

# RL78 LoRaWAN<sup>®</sup> Sensor Demo Tutorial

## Setup and Operation Method

28<sup>TH</sup> DEC 2022

MCP-AA-22-0057-2

MCU DEVICE SOLUTION BUSINESS DIVISION  
IOT AND INFRASTRUCTURE BUSINESS UNIT  
RENESAS ELECTRONICS CORPORATION

### **Notes on using the RF transceiver:**

The use of wireless receivers and transmitters is restricted by international standards and domestic regulations. Wireless receivers and transmitters must therefore be used in accordance with the applicable laws and regulations of the country in which they are being used.

# Contents

---

- **LoRaWAN<sup>®</sup> Features**
- **Required Equipment**
- **Setup LoRaWAN<sup>®</sup> End Node**
- **Setup LoRaWAN<sup>®</sup> Gateway and LoRaWAN<sup>®</sup> Network Server**
- **Register End Node to Network Server**
- **LoRaWAN<sup>®</sup> Sensor Demo Operation**

# Outline

- This tutorial shows how to setup and operate RL78 LoRaWAN<sup>®</sup> Sensor Demo to experience LoRaWAN<sup>®</sup>-based IoT application
- In this demo, sensor data can be sent to cloud service via LoRaWAN<sup>®</sup> wireless network utilizing the LoRaWAN<sup>®</sup> end node software for RL78/G23 from Renesas and visualized on the cloud service.
- You can easily build a wireless network and realize IoT application with the LoRaWAN<sup>®</sup> ecosystem.

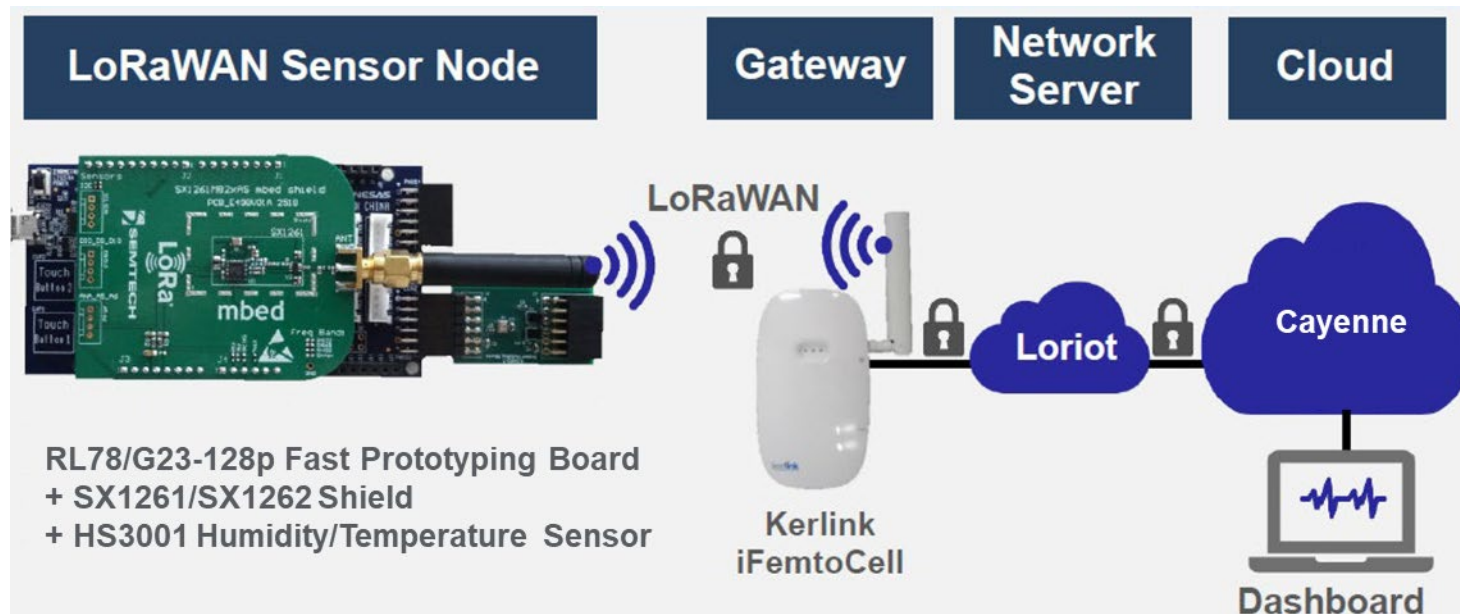

# Required Equipment

## In case RL78/G23-128p Fast Prototyping board is used

- RL78/G23-128p Fast Prototyping Board (RTK7RLG230CSN000BJ)([https://www.renesas.com/rl78g23-128p\\_fpb](https://www.renesas.com/rl78g23-128p_fpb))
- Semtech SX1261 Shield (<https://www.semtech.com/products/wireless-rf/lora-transceivers/sx1261>) or Semtech SX1262 Shield (<https://www.semtech.com/products/wireless-rf/lora-transceivers/sx1262>)
- Relative Humidity Sensor Pmod™ Board (US082-HS3001EVZ)(<https://www.renesas.com/us/en/products/sensor-products/humidity-sensors/us082-hs3001evz-relative-humidity-sensor-pmod-board-renesas-quick-connect-iot>)
- Kerlink Wirnet iFemtoCell (<https://www.kerlink.com/product/wirnet-ifemtocell>)
- Micro USB (USB A-Micro B) Cable

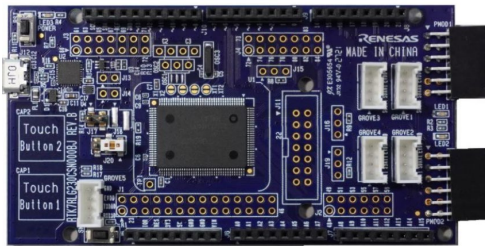

RL78/G23-128p Fast Prototyping Board  
(RTK7RLG230CSN000BJ)



Semtech SX1261 Shield

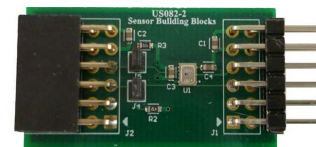

Relative Humidity  
Sensor Pmod™ Board  
(US082-HS3001EVZ)



Kerlink  
Wirnet iFemtoCell

# Ordering Reference

## Semtech SX1261/SX1262 Shield and Kerlink Wirnet iFemtoCell (LoRaWAN® Gateway)

### ▪ Semtech SX1261 Shield or Semtech SX1262 Shield

Region	Parts number	Description
EU	<b>SX1261MB2BAS</b>	SX1261 @868MHZ MBED SHIELD ; +14dBm, XTAL
US	<b>SX1262MB2CAS</b>	SX1262 @915MHZ MBED SHIELD ; +22dBm, XTAL

- Others region: SX1261 can transmit up to +15 dBm. SX1262 can transmit up to +22 dBm. First, please select by your local transmission power limit. If you are not sure, it is better to select SX1261 for demonstration purposes.

### ▪ Kerlink Wirnet iFemtoCell (LoRaWAN® Gateway)

Reference	Description	ISM-Frequencies
PDTIOT-IFE00	<b>Wirnet iFemtoCell 868 MHz</b>	863-874.4MHz
PDTIOT-IFE01	<b>Wirnet iFemtoCell 915 MHz</b>	902-928MHz
PDTIOT-IFE02	<b>Wirnet iFemtoCell 923 MHz</b>	915-928MHz

Information:

[https://lora-alliance.org/lora\\_products/kerlink-wirnet-ifemtocell/](https://lora-alliance.org/lora_products/kerlink-wirnet-ifemtocell/)

### Certification

868	915	923
<ul style="list-style-type: none"><li>• Europe</li><li>• Turkey</li><li>• India</li></ul>	<ul style="list-style-type: none"><li>• USA</li><li>• Canada</li></ul>	<ul style="list-style-type: none"><li>• Australia</li><li>• New-Zealand</li><li>• Singapore</li><li>• Argentina</li><li>• Brazil</li><li>• Taiwan</li><li>• South Korea</li><li>• Japan</li><li>• Hong-Kong</li><li>• Malaysia</li><li>• Indonesia</li><li>• Vietnam</li><li>• Thailand</li><li>• Philippines</li></ul>

# Setup for LoRaWAN<sup>®</sup> End Node

# Setup LoRaWAN® End node (1)

## Hardware Setup in case RL78/G23-128p Fast Prototyping Board is used

### 1) Wirings and change of power supply setting

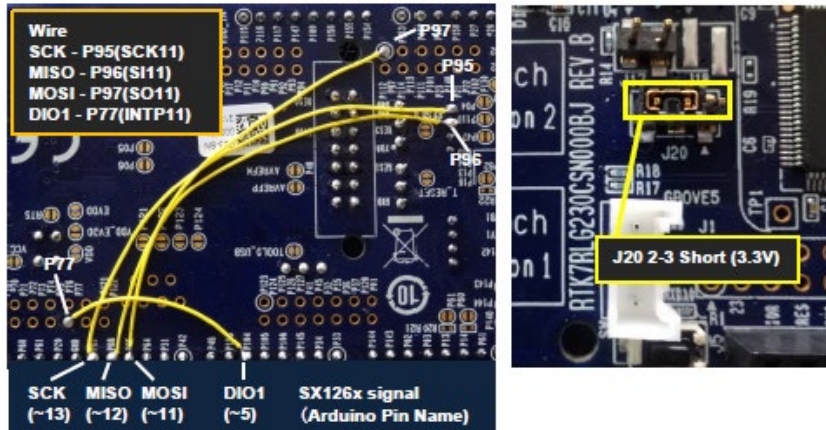

#### STEP1:

Wire SX126x(SCK,MISO,MOSI and DIO1) to RL78/G23(SCK11,SI11,SO11, and INTP11).

#### STEP2:

Power supply selection header (J20) should be changed from 5V (1-2 short) to 3.3V(2-3 short).

#### STEP3:

Plug the SX126x shield. Plug the US082-HS3001EVZ to the PMOD2 connector.

### 2) Connection of boards and cables

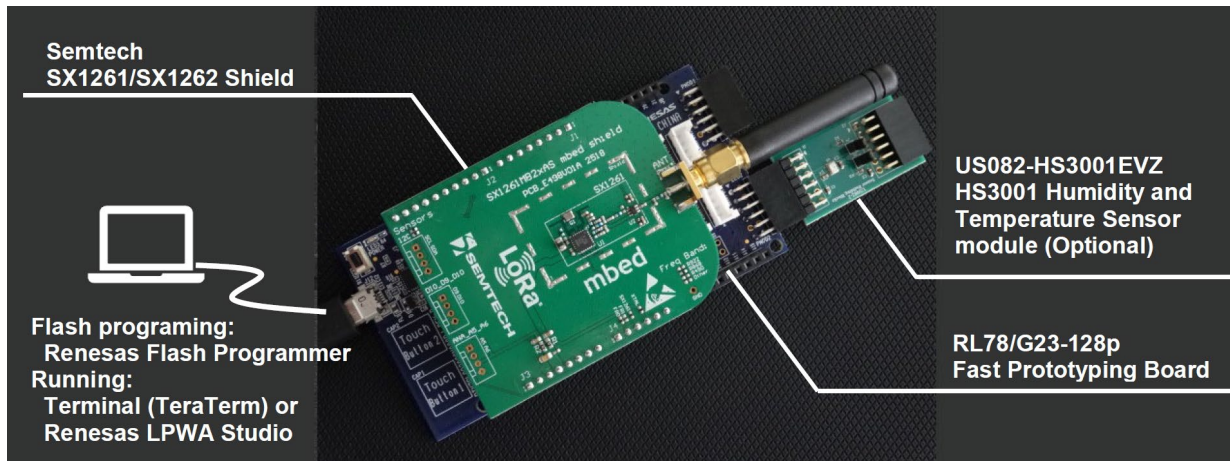



# Setup LoRaWAN® End node (2)

## Write LoRaWAN® Sensor Demo software to flash memory

---

- **Download LoRaWAN(R)-Sensor Demo Package**

- RL78/G23, RL78/G14 LoRaWAN(R)-Sensor Demo Package

<https://www.renesas.com/us/en/document/scd/rl78g23-rl78g14-lorawan-sensor-demo-rev210?language=en&r=1245206>

- **Flash programming to RL78/G23-128p Fast Prototyping Board**

- Download Renesas Flash Programmer (RFP)

RFP V3.08.3 or higher required.

<https://www.renesas.com/rfp>

- Write LoRaWAN® Sensor Demo software to flash memory by RFP

Write the following file to RL78/G23-128p Fast Prototyping Board (Refer to next slide for more details)

`samples\project\e2studio\rl78g23-128pfb_sx126x\LoRaSensorSample\DefaultBuild\LoRaSensorSample.mot`



# Setup LoRaWAN<sup>®</sup> End node (3)

## Write LoRaWAN<sup>®</sup> Sensor Demo software to flash memory

1. Select **New Project**.
2. Select **RL78/G2x** in Microcontroller.
3. Enter project name in Project Name.
4. Select **COM port** in Tool and **2 wire UART** in Interface.
5. Click **Tool Details** and select COM port number.
6. Click **Connect**.
7. Select software file (LoRaSensorSample.mot) in **Program file**.
8. Click **Start**.

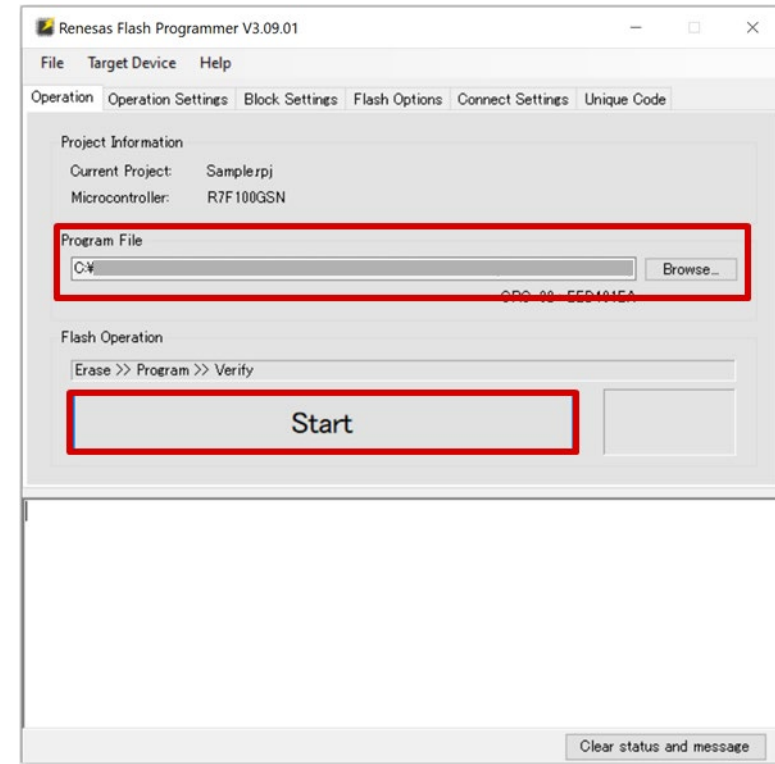
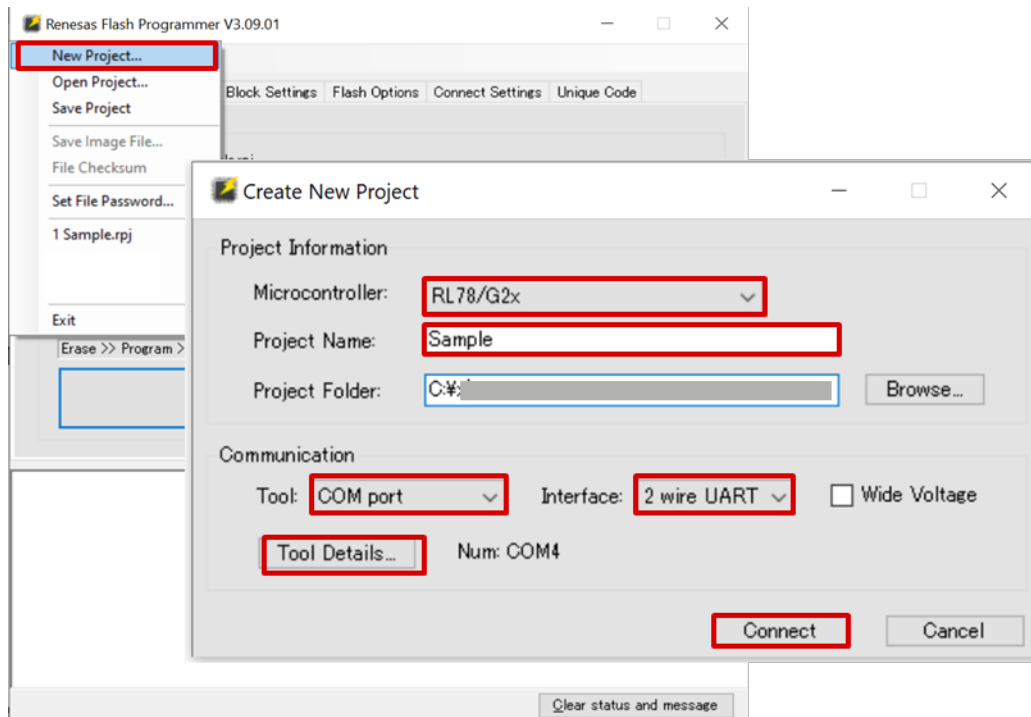

# Setup for LoRaWAN<sup>®</sup> Gateway and LoRaWAN<sup>®</sup> Network Server

# Setup LoRaWAN<sup>®</sup> Gateway

## Login to Kerlink LoRaWAN<sup>®</sup> Gateway by Terminal software(SSH)

### ▪ Necessary information of gateway for setup

Individual information of iFemtoCell is as follows.

Board ID	xxxxxx <b>012345</b>
Host name	klk-wifc- <b>012345</b>
MAC ADDR	XX:XX:XX:XX:XX:XX
Default password Username: root	pdmk- <b>012345</b> (Last 6 digits of Board ID)



Gateway rear label

### ▪ Login to gateway

- Connect the gateway to the LAN environment
- Execute "arp -a" command from Windows command prompt. Identify the gateway by the MAC address and confirm the IP address of the gateway assigned by the DHCP server.
- Connect and login to the confirmed IP address (e.g.: 192.168.1.11) via SSH using Tera Term. Login name: "root", Password: Above default password

### ▪ Similar information

- <https://www.thethingsnetwork.org/docs/gateways/kerlink/ifemtocell/>

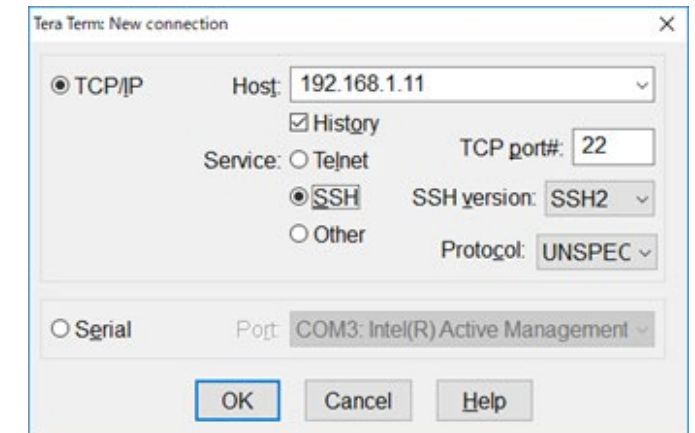

# Setup LoRaWAN® Gateway (2)

## Install LORIENT Software to Kerlink LoRaWAN® Gateway

---

- **Install LORIENT software for iFemtoCell to Kerlink gateway**

- Once login to the gateway, enter the following commands to install the software

```
cd /tmp
```

Change to the LORIENT server name to be used

```
wget https://ap2.loriot.io/home/gwsw/loriot-kerlink-ifemtocell-kerlink_femtocell-SPI-0-latest.sh -O loriot-install.sh
```

```
chmod +x loriot-install.sh
```

```
./loriot-install.sh -f -s ap2.loriot.io
```

- Enter the following command for reboot

```
reboot
```

Note: By downloading and/or using any software from the list you Agree with the EULA.

<https://loriot.io/terms-of-service.html>

# LORIoT LoRaWAN® Network Server

<https://loriot.io/index.html#loriot-network-server>

- LORIoT Network Server has three plans. In this tutorial, COMMUNITY PUBLIC NETWORK SERVER is used.

	<b>COMMUNITY PUBLIC NETWORK SERVER</b> 13 Worldwide Community Public Servers  Public LoRaWAN® servers on-demand including <b>FREE connectivity</b> .  Ideal for Academic/Development/Proof-of-concept/Small-scale/non-critical.	<b>PROFESSIONAL PUBLIC SERVER</b> Professional Network Server for production services  Professional LoRaWAN® network servers with 99.9% SLA and built-in redundancy.  Guaranteed network infrastructure to deploy PoC and commercial services.	<b>PRIVATE NETWORK SERVER</b> Full-featured enterprise-grade Network Server  Private cloud or on-premise network server deployment.  Carrier-grade solution for network operator and large-scale production services.
<b>Unlimited User Accounts</b>	Exclusive	Inclusive	Inclusive
<b>Unlimited Applications</b>	Exclusive	Inclusive	Inclusive
<b>Unlimited gateways</b>	Exclusive	Inclusive	Inclusive
<b>Unlimited Messages</b>	Inclusive	Inclusive	Inclusive
<b>Multitenancy</b>	Exclusive	Inclusive	Inclusive
<b>Included Gateways</b>	unlimited Gateways FREE	Unlimited	Unlimited
<b>Included Devices</b>	30 Devices FREE	Device connectivity packages available	<a href="#">Contact us</a>
<b>Service Level Agreement</b>	Exclusive	99.9%	Inclusive
<b>Cloud Deployment</b>	Worldwide - 13 Regional Servers	Worldwide Professional Servers	Available Worldwide
<b>On-Premise Deployment</b>	—	Exclusive	Inclusive
<b>LoRaWAN® Network Operator</b>	Exclusive	Exclusive	Inclusive
<b>White Label + Custom Domain</b>	—	—	Inclusive
<b>Technical support</b>	Basic	Inclusive	Inclusive
<b>Test Server</b>	—	—	Inclusive
<b>Pricing</b>	<a href="#">FREE</a>	<a href="#">See the plans</a>	<a href="#">Contact us</a>

# Setup LoRaWAN® Network Server (1)

## Web Browser (LORIoT)

### ■ Create LORIoT account







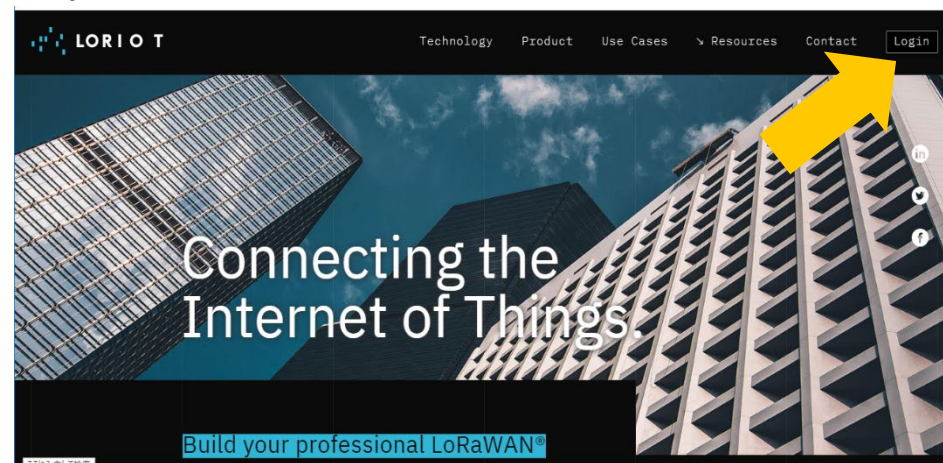





- Access to <https://www.loriot.io/login.html>
- Select a SERVER close to your location
- Click Register a new account

Note: Please use Google Chrome, Firefox or Microsoft Edge for a web browser

<https://www.loriot.io/>



<https://www.loriot.io/login.html>

EUROPE & AFRICA			ASIA / PACIFIC			AMERICAS		
SERVER	LOCATION		SERVER	LOCATION		SERVER	LOCATION	
	<a href="#">EU1</a>	<a href="#">Frankfurt, Germany</a>		<a href="#">AP1</a>	<a href="#">Singapore</a>		<a href="#">US1</a>	<a href="#">California, USA</a>
	<a href="#">EU2</a>	<a href="#">Amsterdam, Netherlands</a>		<a href="#">AU1</a>	<a href="#">Sydney, Australia</a>		<a href="#">US2</a>	<a href="#">New York, USA</a>
	<a href="#">EU3</a>	<a href="#">Madrid, Spain</a>		<a href="#">CN1</a>	<a href="#">Shenzhen, China</a>		<a href="#">SA1</a>	<a href="#">Sao Paulo, Brazil</a>
	<a href="#">UK1</a>	<a href="#">London, United Kingdom</a>		<a href="#">AP2</a>	<a href="#">Tokyo, Japan</a>			
	<a href="#">AF1</a>	<a href="#">Cape Town, South Africa</a>		<a href="#">AP3</a>	<a href="#">Mumbai, India</a>			

Reset password      Register a new account

# Setup LoRaWAN® Network Server (2)

## Web Browser (LORIoT)

- **Add Gateway**

- Click Dashboard→ Networks

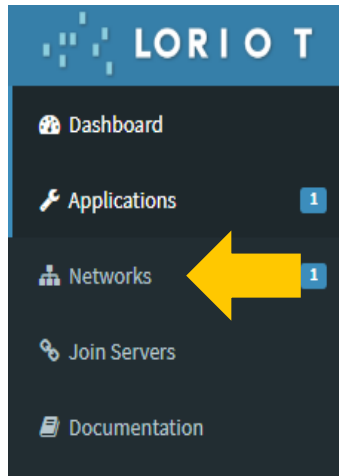

- Click Sample network

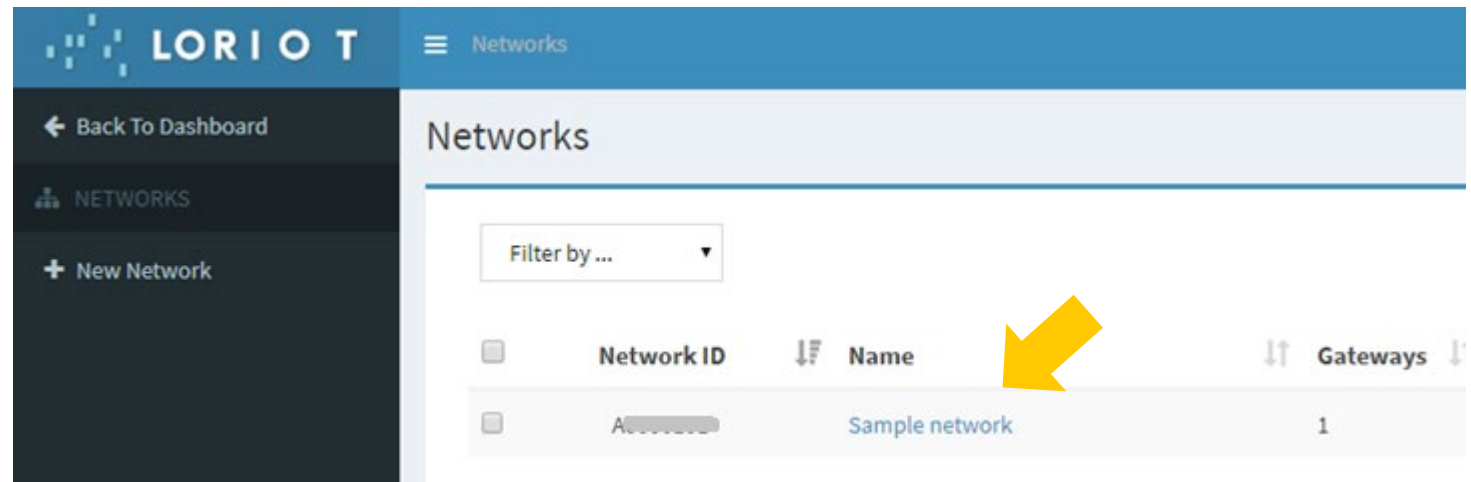



# Setup LoRaWAN® Network Server (3)

## Web Browser (LORIoT)

### Register gateway

- Click “+Add Gateway”
- Select “Kerlink iFemtocell”
- Set gateway MAC ADDR to eth0 MAC address
- Set gateway location in Gateway Location
- Click “Register Kerlink iFemtocell gateway”

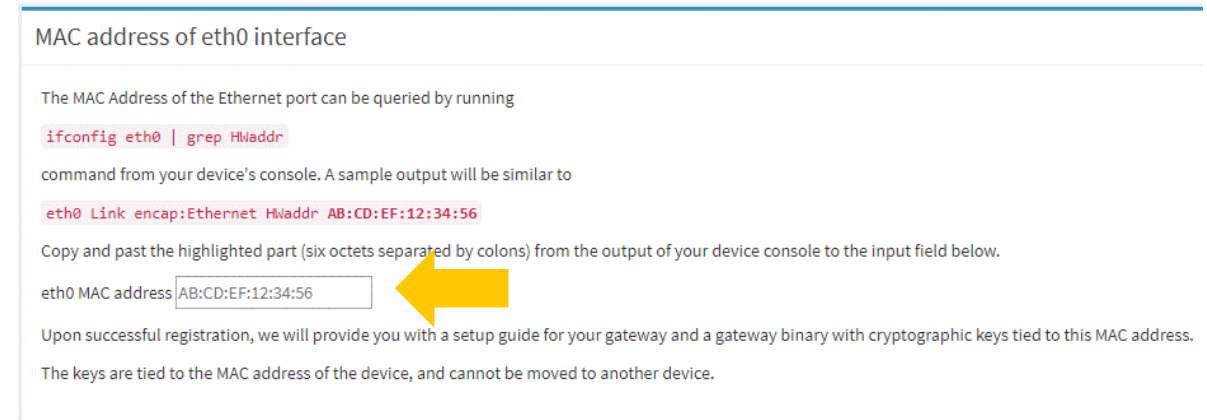
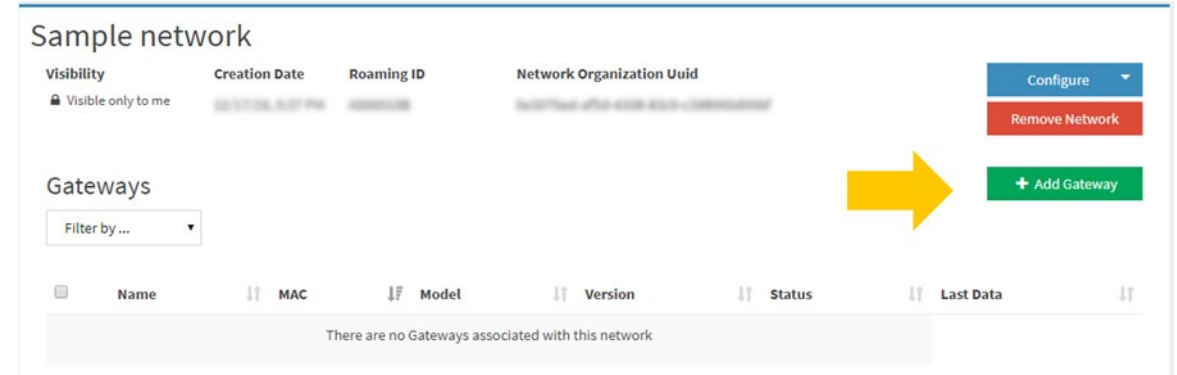

# Setup LoRaWAN® Network Server (4)

## Web Browser (LORIoT)

### ▪ Set region

- Click Region in Configuration
- Select Region Code

Example:

- Europe: EU863-870
- US: US902-928
- JAPAN: AS923

Antennas

Region

- CN779-787
- CN470-510
- US902-928
- AU915-928
- AS923
- EU863-870
- KR920-923
- EU433
- IN865-867
- GLOBAL
- IL915
- RU864-870



Regarding Region Code, see below for other regions

Global Frequency Plans

<https://docs.loriot.io/display/LNS/Global+Frequency+Plans>

# Setup LoRaWAN® Network Server (5)

## Web Browser (LORIoT)

### Set Channel Plans

- Click “- Remove Plans”
- Click “+Add Band”
- Select Channel Plan

Example:

Europe: EU868

US: US915\_CH0\_7

JAPAN: AS923-1

- Click “Restart”

Note: Restart will not be shown when gateway is not online.

ID	Tx Gain	Channel Plans	
0	0	Change TX	<div style="display: flex; align-items: center;"> <div style="border: 1px solid black; padding: 2px; margin-right: 5px;">EU868</div> <div style="margin-left: 20px;"> <span style="color: yellow; font-size: 2em;">➔</span> <div style="display: flex; flex-direction: column; gap: 5px;"> <span style="color: blue;">+ Add Band</span> <span style="color: red;">- Remove Plans</span> </div> </div> </div>

#### Region: EU863-870

EU868

EU868\_RX2SF9

▼
✓
✕

#### Region: US902-928

US915\_CH0\_7

US915\_CH0\_15  
 US915\_CH8\_15  
 US915\_CH16\_23  
 US915\_CH24\_31  
 US915\_CH32\_39  
 US915\_CH40\_47  
 US915\_CH48\_55  
 US915\_CH56\_63  
 US915\_Default

▼
✓
✕

#### Region: AS923

AS923-1

AS923-1b  
 AS923-2  
 AS923-3  
 AS923-4

▼
✓
✕

Restart
←

Regarding Channel Plan, see below for other regions.

Supported Frequency Plans

<https://docs.loriot.io/display/LNS/Supported+Frequency+Plans>

# Registration of End Node to LoRaWAN<sup>®</sup> Network Server

# Registration of End Node to LoRaWAN® Network Server (1)

## Web Browser (LORIoT)

### ▪ Add Device

- Click Dashboard→ Applications

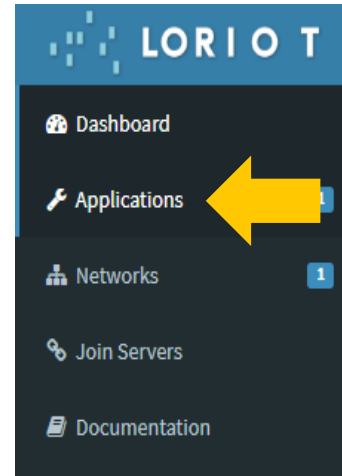

- Click Dashboard→ Applications SampleApp

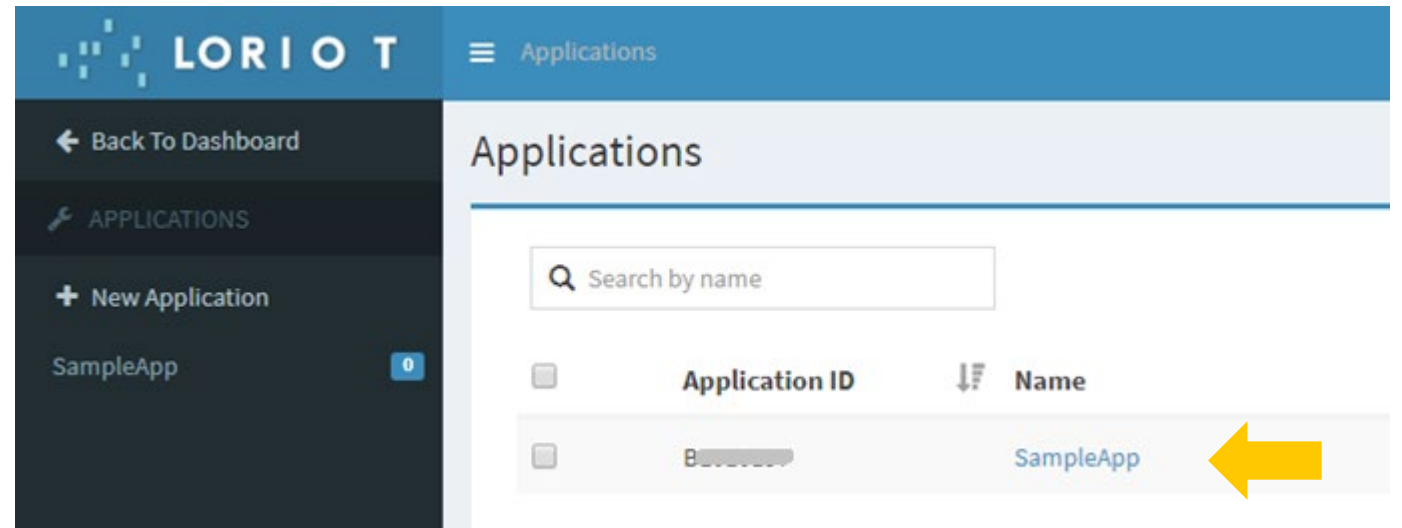

# Registration of End Node to LoRaWAN® Network Server (2)

## Web Browser (LORIoT)

---

- Click Enroll Device

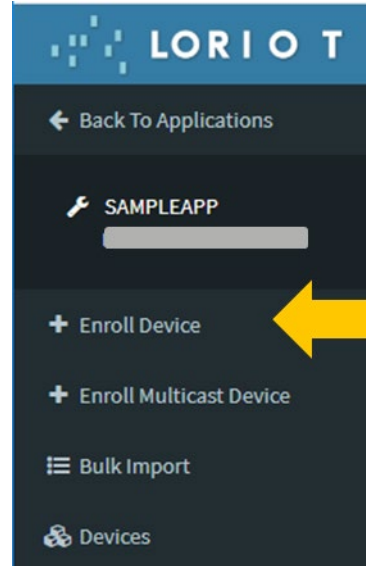

# Registration of End Node to LoRaWAN® Network Server (3)

## Web Browser (LORIoT)

Please prepare 48-bit MAC address. Put FF: FE in the middle of the 48-bit MAC address and use it as a 64-bit Device EUI.

← Back To Applications

SAMPLEAPP

+ Enroll Device

Enroll A New Device

LoRaWAN® Version: LoRaWAN® 1.0.x

Enrollment Process: OTAA

Location:  DISABLED  ENABLED

You can define coordinates for static devices enabling this option.

Details

Title:

Device EUI:

Join EUI:

Application Key:

Device Profile:

Create Another

### ▪ Enter Title, Device EUI, Join EUI, and Application Key

Example:

- Title=demo
- Device EUI=xxxxxxFFFExxxxxx  
xxxxxx is the following MAC address
- Join EUI (Application EUI)= 0123456701234567
- Application Key= 5555555555555555AAAAAAAAAAAAAAAAAAAA  
(5:16 digits and A:16 digits)

### ▪ Click Enroll

MAC address:  
Companies that do not have a MAC address can purchase it from IEEE or alternatively purchase an EEPROM with a MAC address written.



# LoRaWAN<sup>®</sup> Sensor Demo Operation Method

# Operation method of LoRaWAN® End Node (1)

## Terminal Software used to connect to End Node

### Confirmation of UART connection

- Connect with PC by Terminal Software
- Setup Serial and Terminal of right figure  
COM Port number in Port needs to be changed for the one you use
- Enter 'AT' for control confirmation and confirm 'OK'

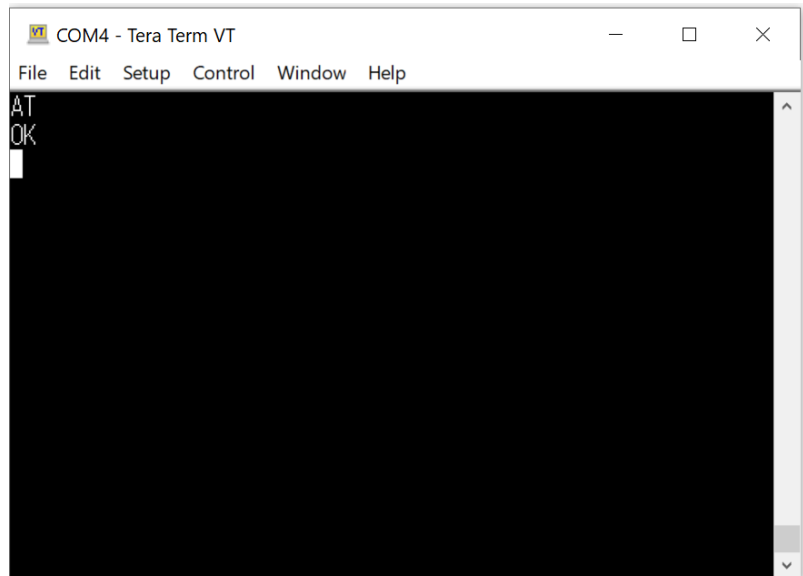
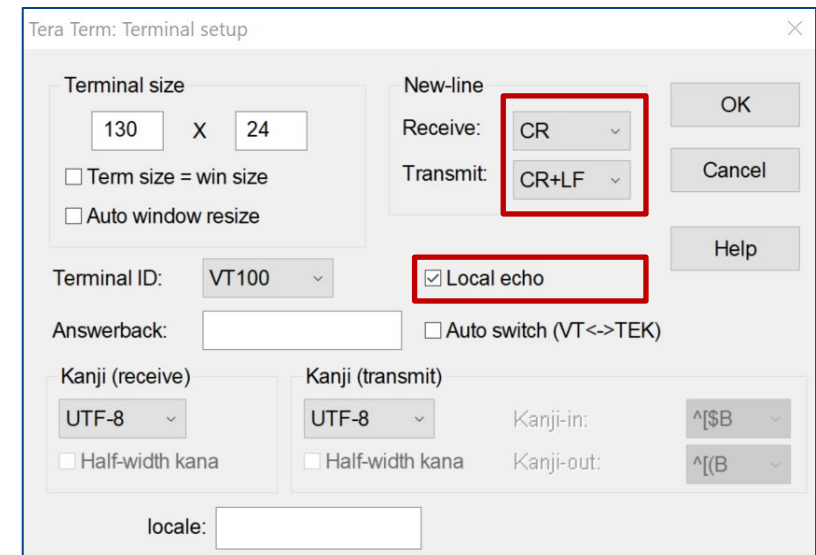
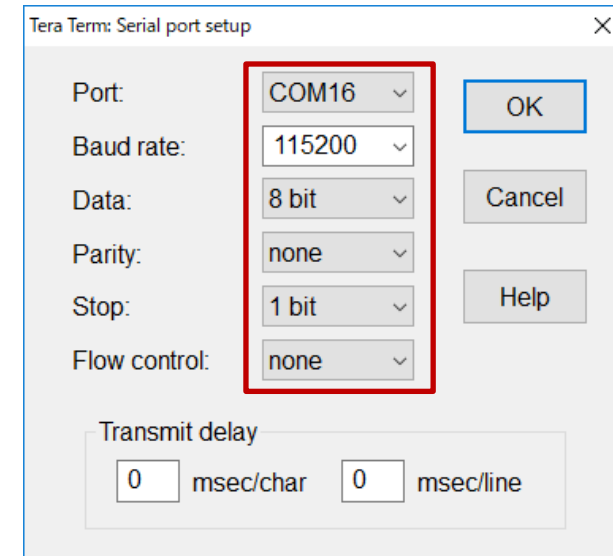

# Operation method of LoRaWAN® End Node (2)

## Configuration of end node

### ▪ Example of configuration

Enter the following commands in Terminal Software

#### 1. Set LoRaWAN® specific parameters with AT-commands

```
AT+REGION=X ← X: 0, 1, 6 // Region: 0:EU868, 1:US915(*Note1), 6:AS923-Group1
AT+CLASS=0 // Class A
AT+ACTMODE=1 // Activation: OTAA
AT+DEVEUI=XXXXXXXXXXXXXXXX // DevEUI
AT+APPEUI=0123456701234567 // AppEUI
AT+APPKEY=5555555555555555AAAAAAAAAAAAAAAA // AppKey
AT+SAVE // Save settings
```

Note1: Enter the following command before AT+SAVE in case US915\_CH8\_15 is used for channel plan  
AT+CHDEFMASK=FF00,0000,0000,0000,0002

#### 2. Set sensor demo specific parameters with AT-command

```
AT+SENSOR=60,60,1 // Set parameters (*Note2)
AT+SAVE // Save settings to data flash
AT+RESET=1 // Auto start after reset
```

Note2: AT+SENSOR=REJOIN,MEASURE,MODE

REJOIN: Join retry interval after join failure [sec], MEASURE: Next measurement after Tx [sec], MODE: 1: Auto start mode

# Operation method of LoRaWAN® End Node (3)

## Example of execution screen of end node

- Example of execution screen of end node

```
COM4 - Tera Term VT
File Edit Setup Control Window Help
AT+REGION=6
OK
AT+CLASS=0
OK
AT+ACTMODE=1
OK
AT+DEVEUI=
OK
AT+APPEUI=0123456701234567
OK
AT+APPKEY=5555555555555555AAAAAAAAAAAAAAAA
OK
AT+SENSOR=60,60,1
OK
AT+SAVE
OK
AT+RESET=1
OK
```

```
COM4 - Tera Term VT
File Edit Setup Control Window Help
*SENSOR: JOIN
*SENSOR: JOIN ACCEPTED
*SENSOR: SEND FFFFFFFFFFFFFFFF,14,1
*SENSOR: SEND ACK_RECEIVED
*SENSOR: MEASUREMENT START
*SENSOR: SEND 016869026700F3,1,0
*SENSOR: SEND OK
*SENSOR: MEASUREMENT START
*SENSOR: SEND 016865026700F8,1,0
*SENSOR: SEND OK
*SENSOR: MEASUREMENT START
*SENSOR: SEND 016862026700FA,1,0
*SENSOR: SEND OK
*SENSOR: MEASUREMENT START
*SENSOR: SEND 016860026700FC,1,0
*SENSOR: SEND OK
*SENSOR: MEASUREMENT START
*SENSOR: SEND 01685F026700FD,1,0
*SENSOR: SEND OK
*SENSOR: MEASUREMENT START
```

# Data Visualization

## Cayenne for LoRa®

- Sensor data such as temperature and humidity can be displayed on Cayenne dashboard via LORIoT network server.

Cayenne for LoRa®

<https://developers.mydevices.com/cayenne/lora/>

Network Server

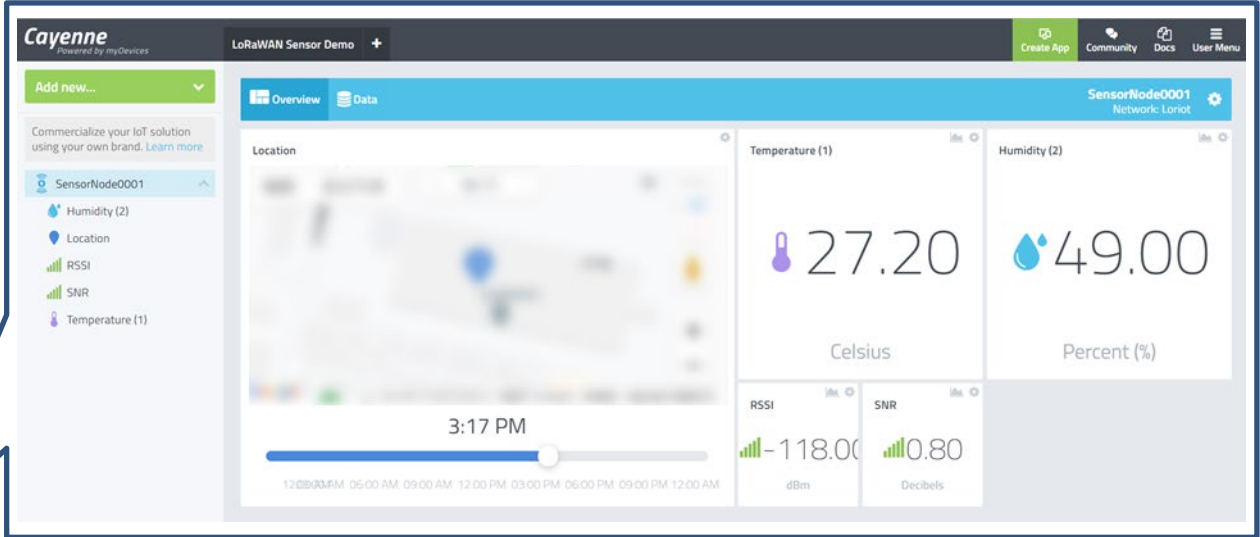
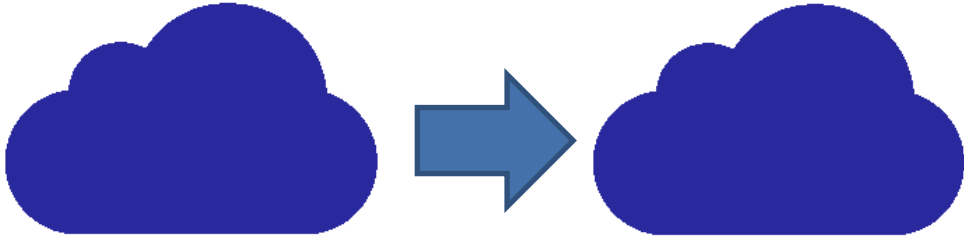

# Data Visualization

## Network Server Setting for Output (Cayenne)

### ■ Set output of network server

- Click Dashboard → Application → SampleApp → Output
- Click Cayenne
- Click Add Output

The screenshot shows the LORIO T web interface. The breadcrumb navigation is 'Applications > SampleApp > Output'. The left sidebar contains a menu with 'Output' highlighted in red. The main content area displays a grid of output mechanisms, including MQTT, WebSocket, TLS Socket, HTTP://, HTTPS://, HTTP Push, PubNub, Amazon AWS IoT, Microsoft Azure, IBM Cloud, Iron.io IronMQ v1, Iron.io IronMQ v3, Google IoT Core, AllThingsTalk, CoAP, and CoAP Push. The 'Cayenne myDevices Cayenne' mechanism is highlighted with a red box and a yellow arrow. A modal dialog is open on the right, showing the 'Add Output' button highlighted with a red box and a yellow arrow.

# Data Visualization

## Get Network Server Information (1)

- Remember Application ID for setting of Cayenne later

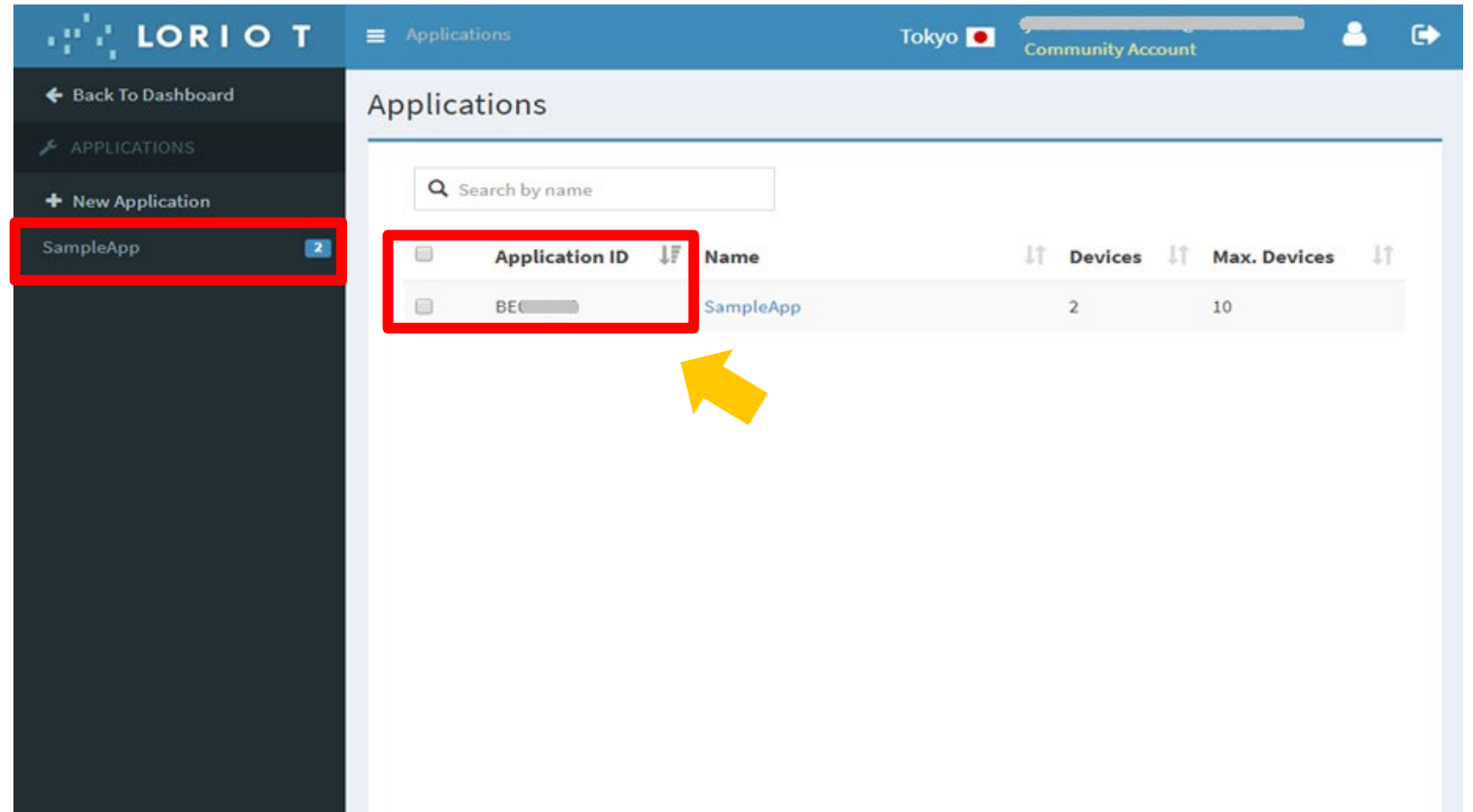

The screenshot shows the LORION Applications page. The left sidebar contains navigation options: 'Back To Dashboard', 'APPLICATIONS', 'New Application', and 'SampleApp' (highlighted with a red box). The main content area displays a table of applications. The table has columns for 'Application ID', 'Name', 'Devices', and 'Max. Devices'. The 'SampleApp' application is listed with an Application ID of 'BE...' (highlighted with a red box) and 2 devices. A yellow arrow points to the Application ID.

Application ID	Name	Devices	Max. Devices
BE...	SampleApp	2	10



# Data Visualization

## Get Network Server Information (2)

- Remember Token for setting of Cayenne later

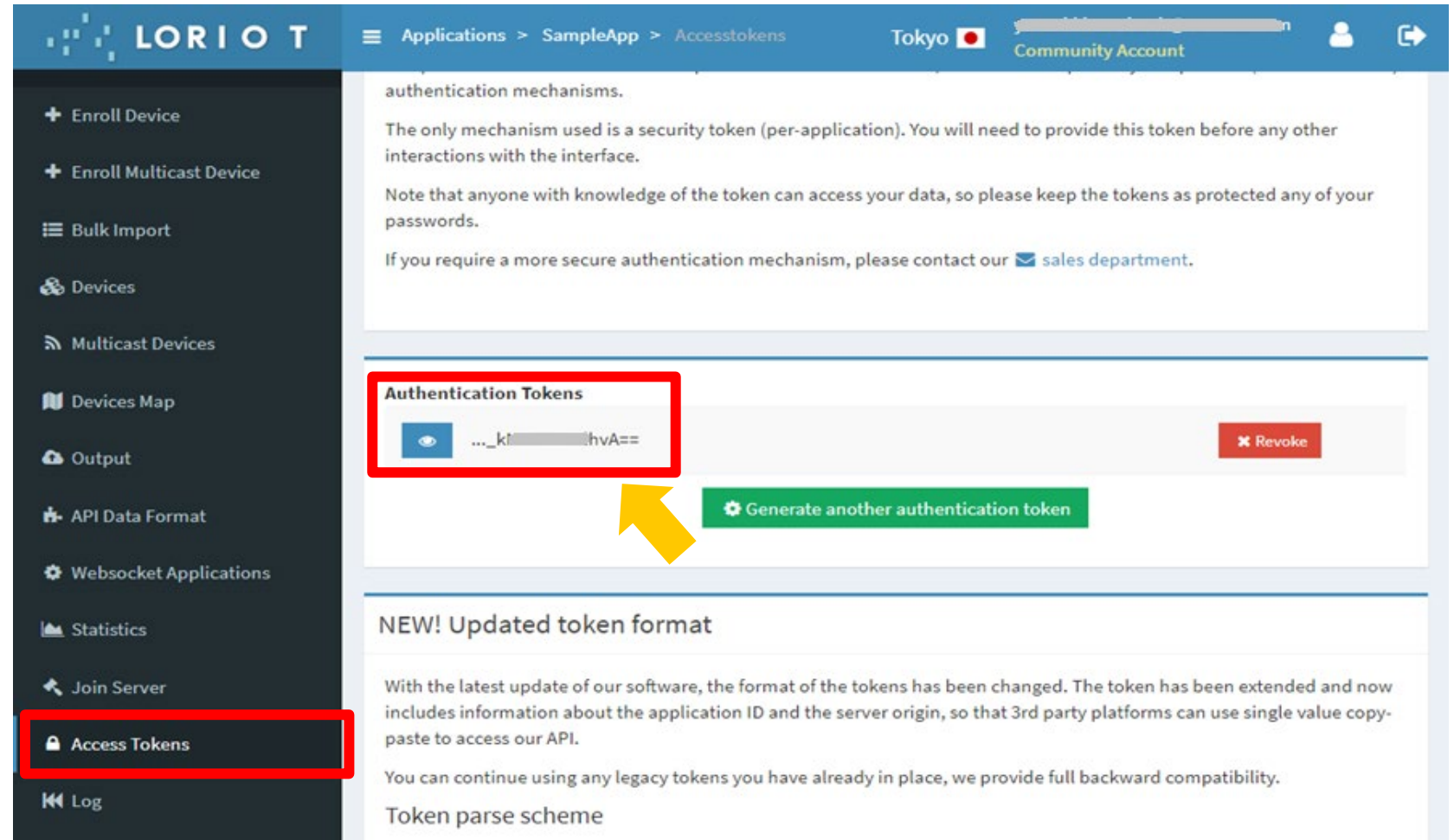

The screenshot shows the LORION web interface. The left sidebar contains a menu with the following items: Enroll Device, Enroll Multicast Device, Bulk Import, Devices, Multicast Devices, Devices Map, Output, API Data Format, Websocket Applications, Statistics, Join Server, Access Tokens (highlighted with a red box), and Log. The main content area is titled 'Applications > SampleApp > Accesstokens'. It contains a header with 'Tokyo' and 'Community Account'. The main text explains authentication mechanisms, stating that a security token is used and that tokens should be kept as protected as passwords. Below this, there is a section titled 'Authentication Tokens' which shows a token value (partially obscured by a red box) and a 'Revoke' button. A yellow arrow points to the token value. Below the token list is a green button labeled 'Generate another authentication token'. At the bottom, there is a section titled 'NEW! Updated token format' which explains that the token format has been changed to include application ID and server origin information, and that legacy tokens are still supported.

# Data Visualization

## Create Account of Cayenne for LoRa®

- Access to Cayenne for LoRa®

<https://developers.mydevices.com/cayenne/lora>

- Create Account

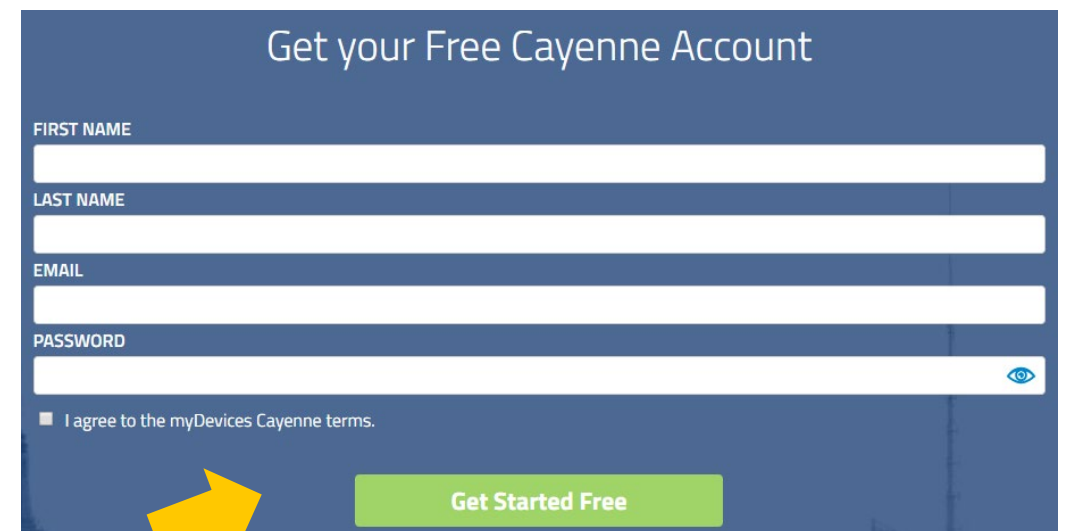
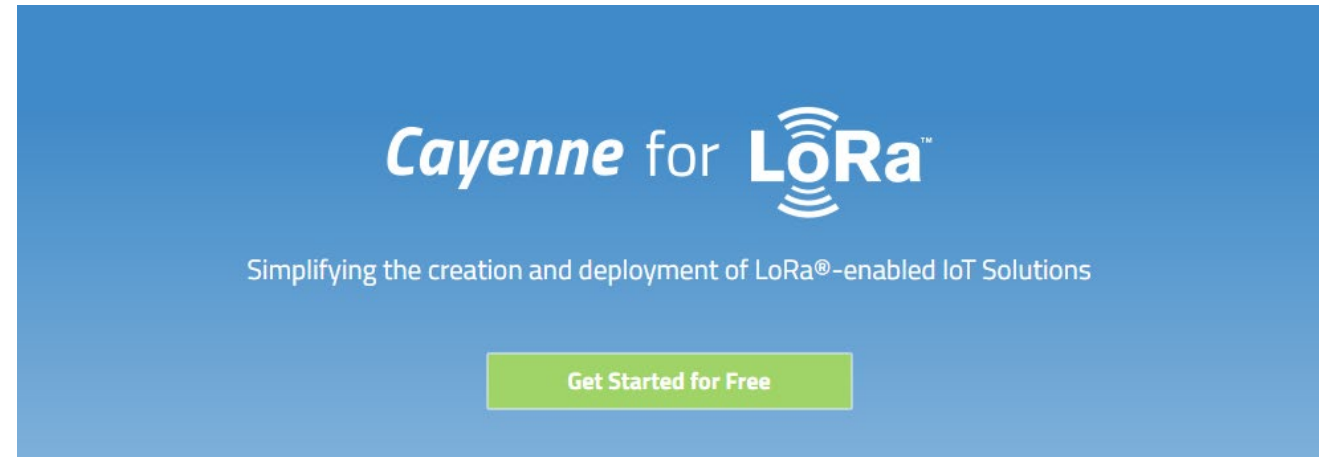
A registration form titled 'Get your Free Cayenne Account'. It has a dark blue background. The form contains four input fields: 'FIRST NAME', 'LAST NAME', 'EMAIL', and 'PASSWORD'. The 'PASSWORD' field has a small eye icon on the right. Below the fields is a checkbox with the text 'I agree to the myDevices Cayenne terms.'. At the bottom right is a green button with the text 'Get Started Free'. A yellow arrow points from the bottom left towards the 'Get Started Free' button.

# Data Visualization

## Setting Cayenne for LoRa® (1)

- Login to Cayenne
- Click “LoRa®”

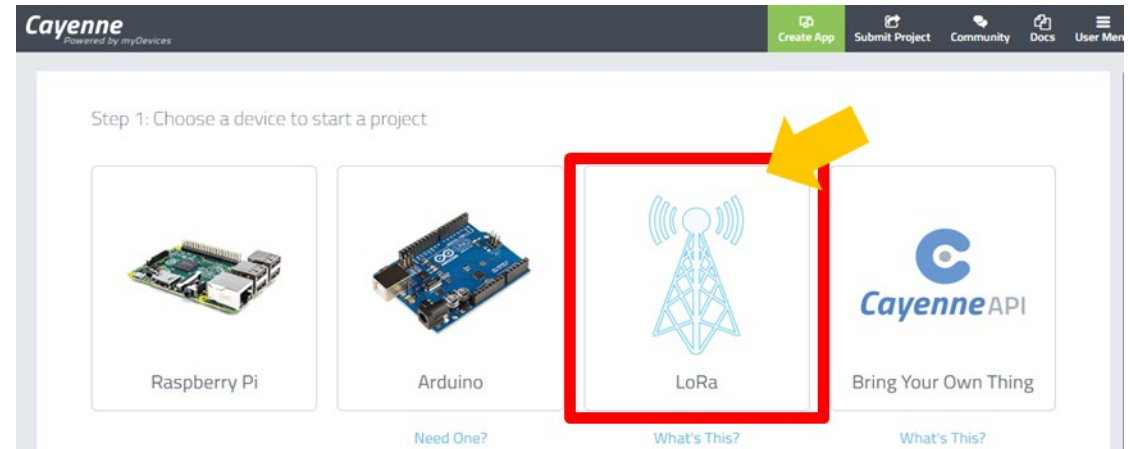

- Click “Loriot”

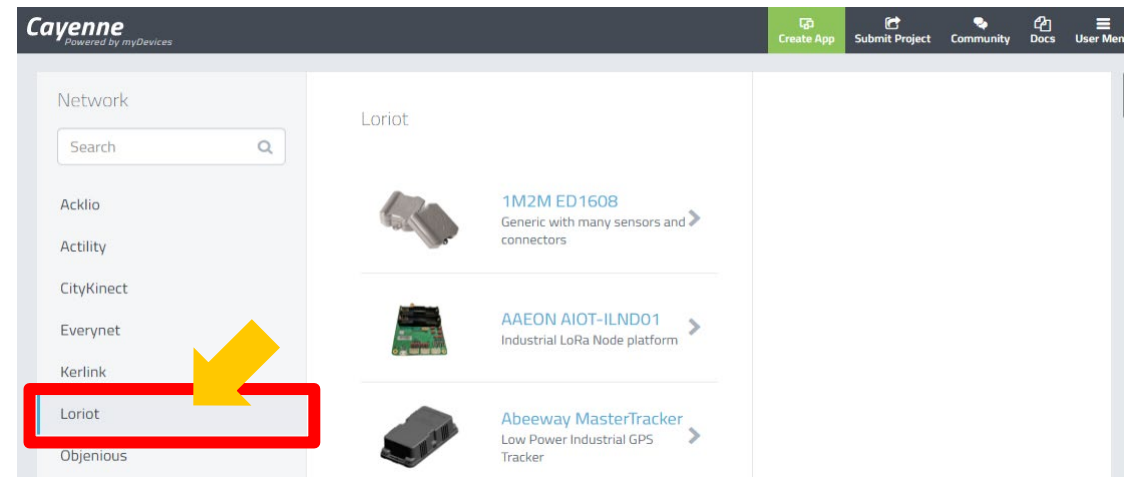

# Data Visualization

## Setting Cayenne for LoRa® (2)

- Click “Cayenne LPP”

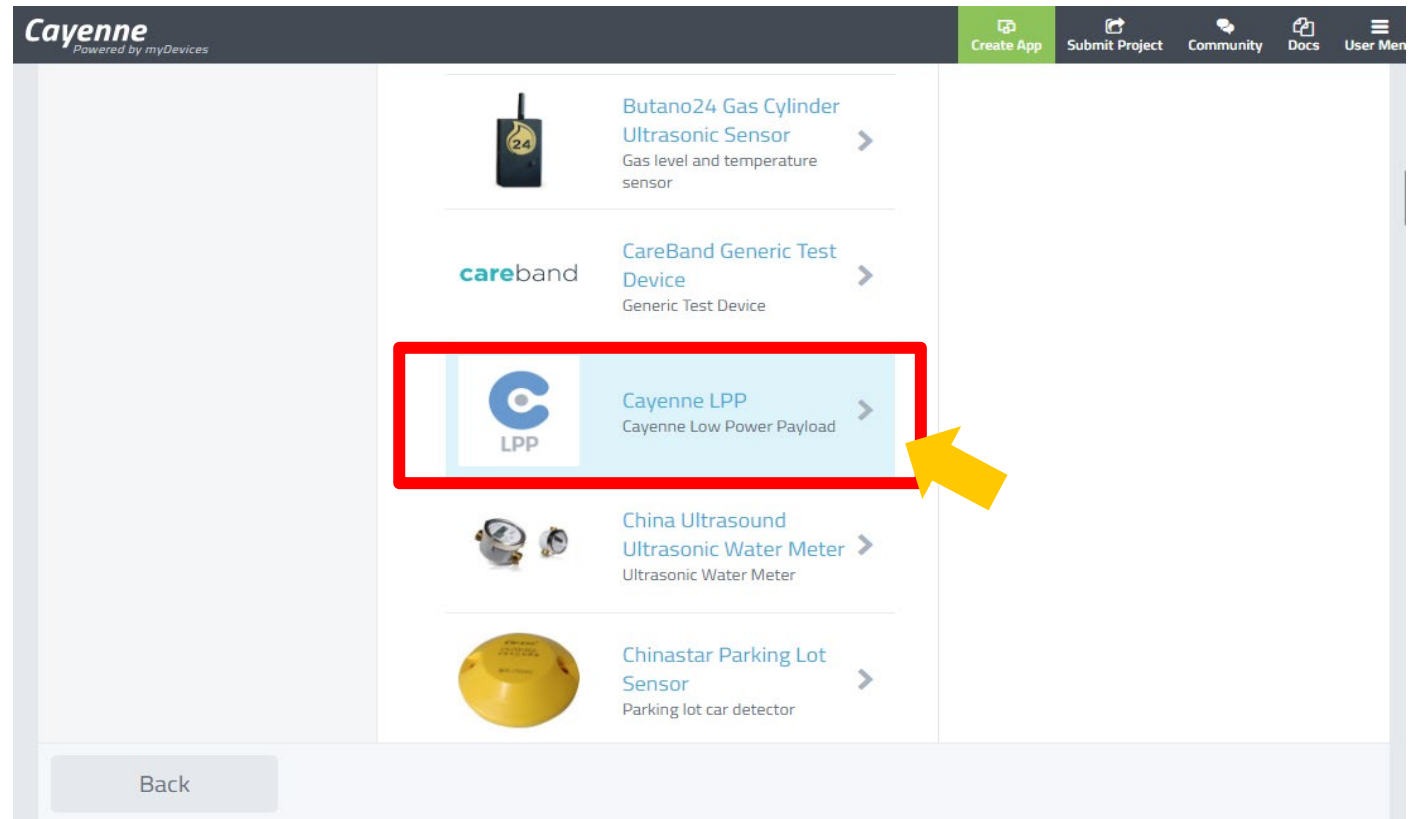

# Data Visualization

## Setting Cayenne for LoRa® (3)

- **Set Information of device and network server**
  - Device EUI
  - Lorient information (Lorient App ID, Lorient Token)
  - Others
- **Click Add Device**
  - This button will be enabled once you enter the correct information.

The screenshot shows the 'Enter Settings' page in the Cayenne web interface. The page title is 'Enter Settings' and the application is 'Cayenne Cayenne LPP'. The form includes the following fields:

- Name: SensorDemo0001
- DevEUI: [Empty text input field]
- Activation Mode: Already Registered (dropdown menu)
- Lorient Server: ap2.loriot.io (Asia-Pacific / Tokyo, Japan) (dropdown menu)
- Lorient App ID: [Empty text input field]
- Lorient Token: [Empty text input field]
- Tracking: This device doesn't move (dropdown menu)

A red box highlights the form fields, and a yellow arrow points to the 'Add device' button. Three blue callout boxes provide instructions:

- DevEUI is the EUI-64 address of the end node
- Select server you use
- App ID and Token are values from Lorient Network Server

# Data Visualization

## Display at Cayenne for LoRa®

- Values of temperature and humidity sensor will be displayed once the data is sent from the end node
- Icons for temperature and humidity sensor can be customized by menu shown when to left-click on chart and the gear wheel on the icons
- You can also check it on your smart phone

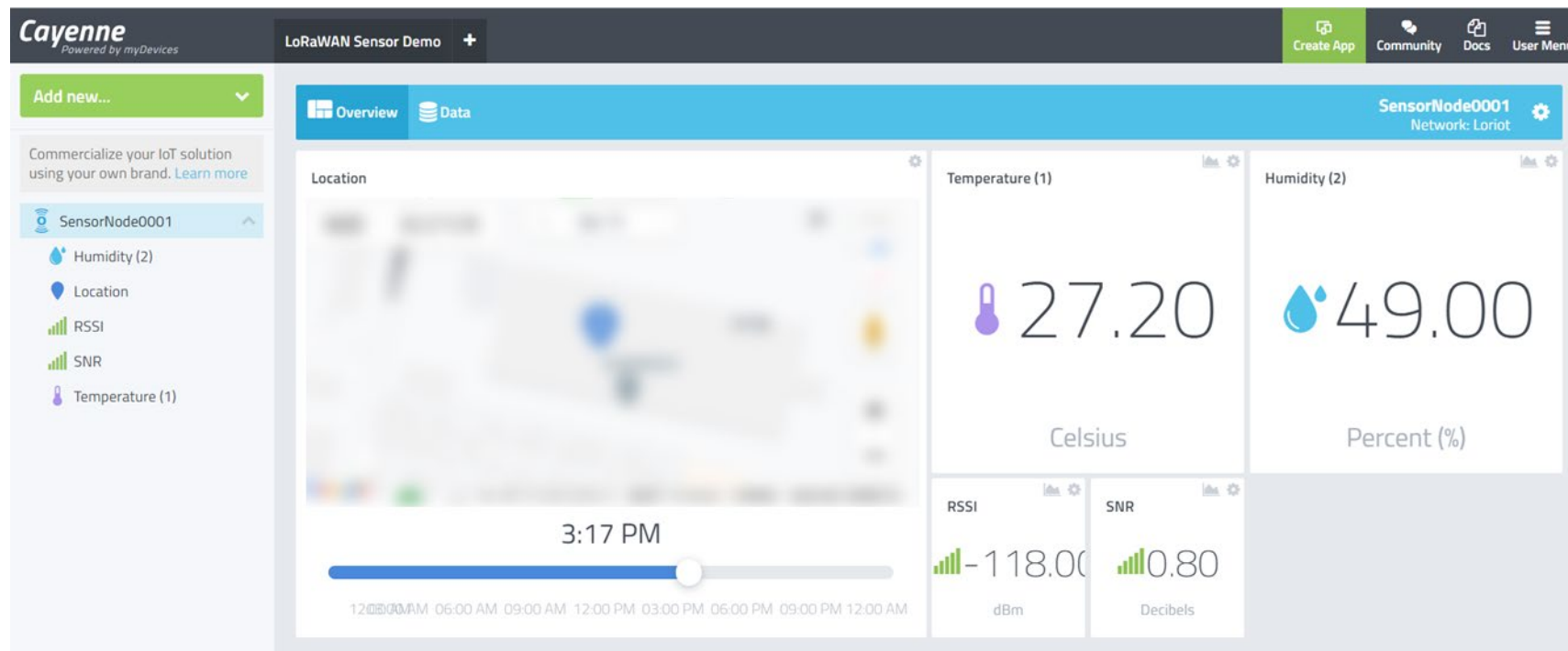

# Related Videos

---

- **RL78 LoRaWAN® Sensor Demo Tutorial**

<https://www.renesas.com/us/en/video/rl78-lorawan-sensor-demo-tutorial>

- **RL78 LoRa®-based Solution**

<https://www.renesas.com/us/en/video/rl78-lora-based-solution>



---

Renesas.com

\*Semtech, LoRa®, and LoRaWAN® are registered trademarks of Semtech Corporation.  
\*All trademarks and registered trademarks are the property of their respective owners.