

REVISIONS			
REV	DESCRIPTION	DATE	APPROVED
00	INITIAL RELEASE	8/8/14	JHUA
01	ADD OPTION 1 & 2	4/2/15	JHUA

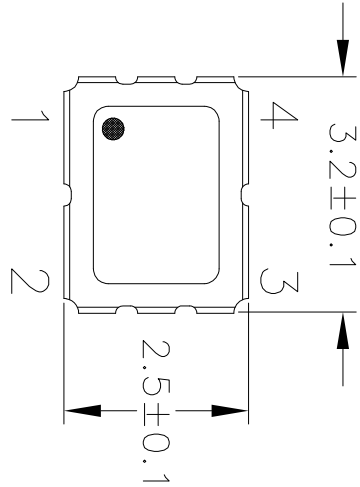

TOP VIEW

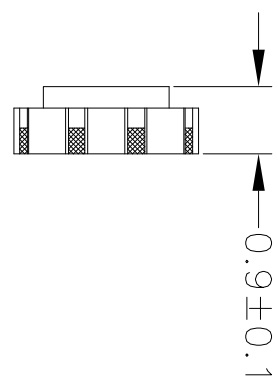

END VIEW

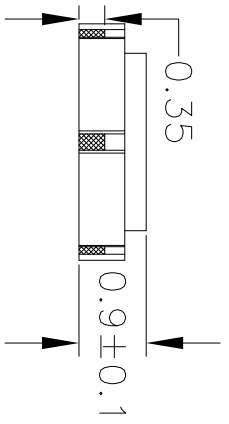

SIDE VIEW

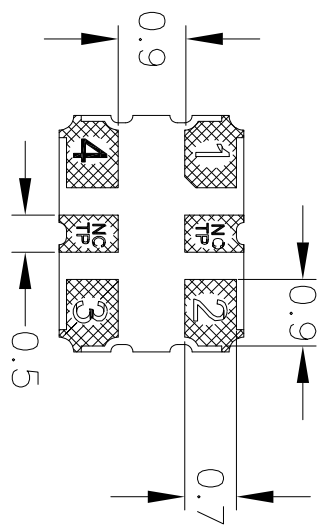

OPTION 1
BOTTOM VIEW

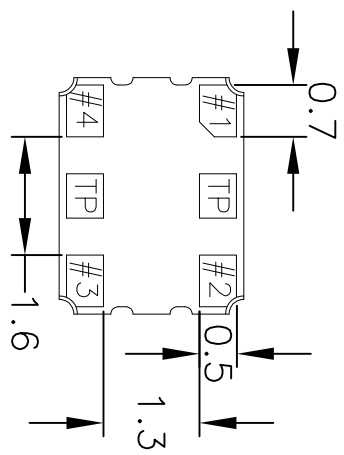

OPTION 2
BOTTOM VIEW

NOTES:
1. ALL DIMENSIONS IN MM.

TOLERANCES UNLESS SPECIFIED		 IDT 6024 Silver Creek Valley Rd San Jose, CA 95138 PHONE: (408) 727-6116 FAX: (408) 492-8674
DECIMAL	ANGULAR	
XXX±	±	
XXXX±		
APPROVALS	DATE	TITLE
DRAWN <i>RAC</i>	8/8/14	JX4 PACKAGE OUTLINE
CHECKED		3.2 x 2.5 mm BODY
		0.9 mm Thick
SIZE	DRAWING No.	REV
C	PSC-4489	01
DO NOT SCALE DRAWING		SHEET 1 OF 2

REVISIONS			
REV	DESCRIPTION	DATE	APPROVED
00	INITIAL RELEASE	8/8/14	JHUA
01	ADD OPTION 1 & 2	4/2/15	JHUA

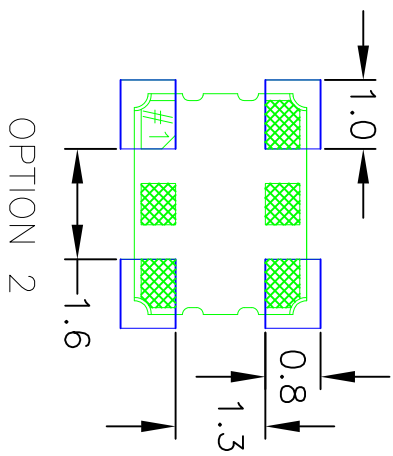
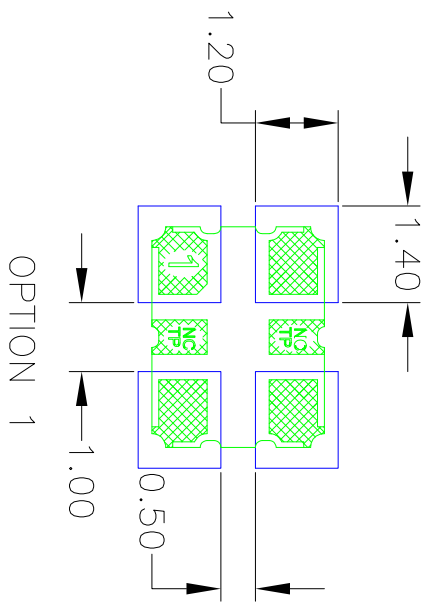

RECOMMENDED LAND PATTERN

- NOTES:
1. ALL DIMENSION ARE IN mm. ANGLES IN DEGREES.
 2. TOP DOWN VIEW AS VIEWED ON PCB.
 3. COMPONENT OUTLINE SHOWN FOR REFERENCE IN GREEN.
 4. LAND PATTERN IN BLUE. NSMD PATTERN ASSUMED.
 5. LAND PATTERN RECOMMENDATION PER IPC-7351B GENERIC REQUIREMENT FOR SURFACE MOUNT DESIGN AND LAND PATTERN.

TOLERANCES UNLESS SPECIFIED	
DECIMAL ±	ANGULAR ±
XXX±	
XXX±	
APPROVALS	DATE
DRAWN /DAG	8/8/14
CHECKED	
SIZE	DRAWING No.
C	PSC-4489
	REV
	01
DO NOT SCALE DRAWING	
SHEET 2 OF 2	

IDT™
 6024 Silver Creek Valley Rd
 San Jose, CA 95138
 PHONE: (408) 727-6116
 FAX: (408) 492-8574
www.idt.com

TITLE JY4 PACKAGE OUTLINE
 3.2 x 2.5 mm BODY
 0.9 mm Thick