

REVISIONS			
REV	DESCRIPTION	DATE	APPROVED
00	INITIAL RELEASE	01/29/07	PKP
01	CHANGE NAME FROM AN/RN TO AN/MN	4/3/08	PKP
02	COMBINE POD & LAND PATTERN	5/29/13	KS

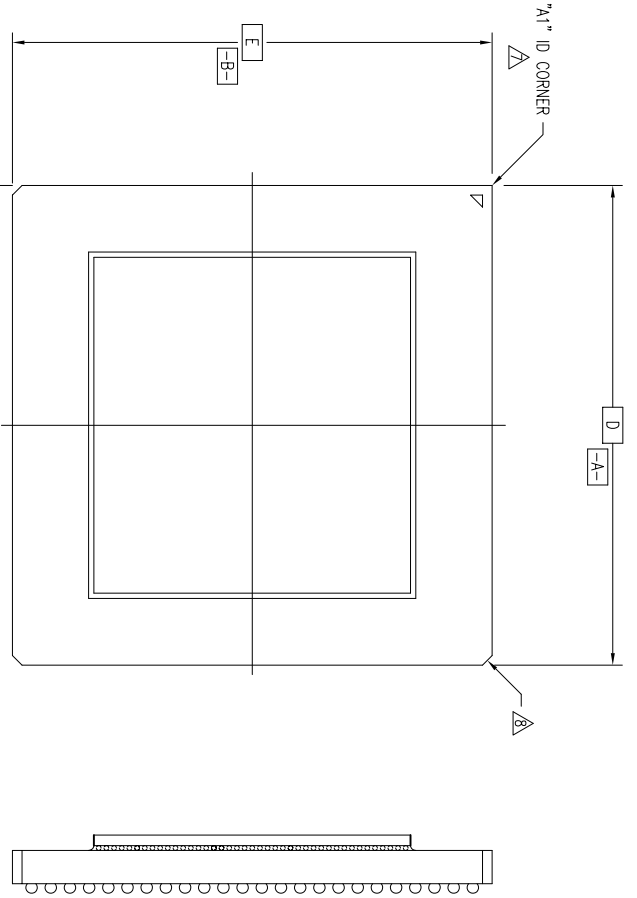

TOP VIEW

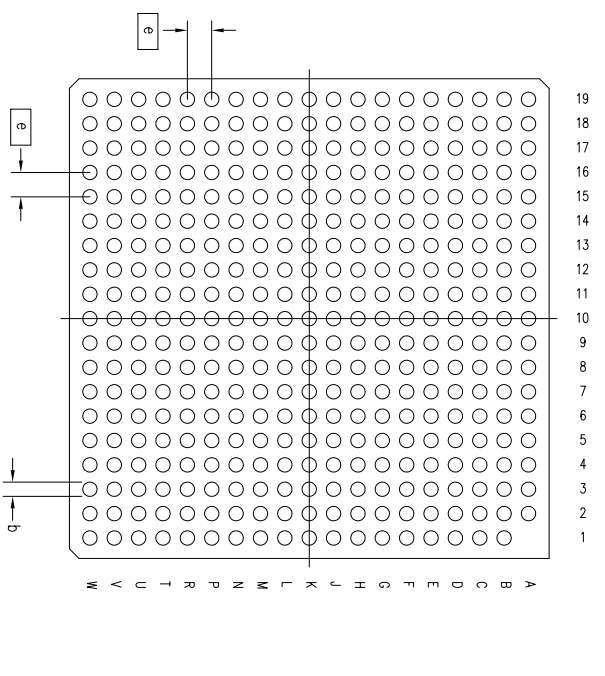
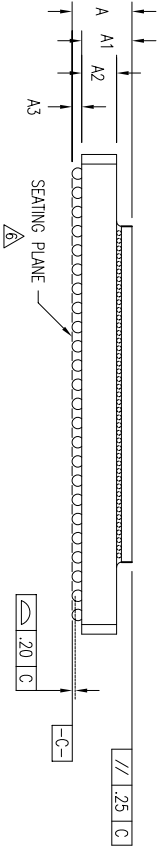

TOLERANCES UNLESS SPECIFIED			JIDT 6024 Silver Creek Valley Rd San Jose, CA 95138 PHONE: (408) 284-8200 FAX: (408) 284-3572
DECIMAL	±		
ANGULAR	±	TITLE AN/MN 360 PACKAGE OUTLINE DRAWN <i>gpc/pj</i> 01/10/07 CHECKED	
APPROVALS	DATE	SIZE	DRAWING NO.
XXXXX		C	PSC-4155
XXXXX			REV 02
DO NOT SCALE DRAWING			
			SHEET 1 OF 3

REVISIONS			
REV	DESCRIPTION	DATE	APPROVED
00	INITIAL RELEASE	01/29/07	PKP
01	CHANGE NAME FROM AN/RN TO AN/MN	4/3/08	PKP
02	COMBINE POD & LAND PATTERN	5/29/13	KS

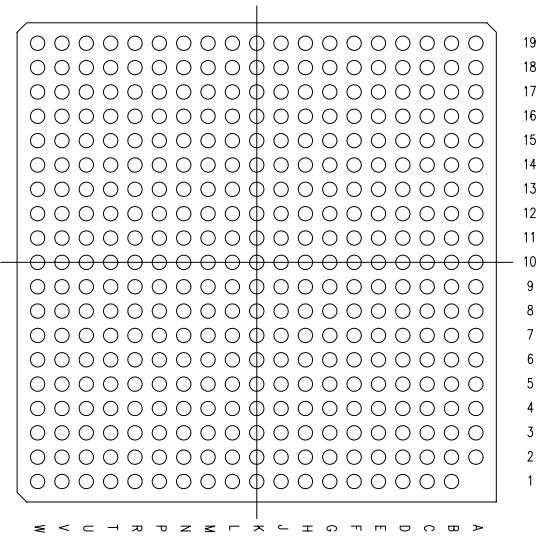

BOTTOM VIEW
(BALL SIDE VIEW)

SYMBOL	JEDEC VARIATION			NOTE
	MIN	NOM	MAX	
A	—	—	2.75	
A1	1.85	2.00	2.15	
A2	—	1.20	—	
A3	0.30	—	—	
D	25.00 BSC			
E	25.00 BSC			
M	19 (FULL MATRIX)			3
N	360			4
e	1.27 BSC			
b	.60	.75	.90	5
CENTER BALL MATRIX	N/A			

NOTES:

- 1 ALL DIMENSIONING AND TOLERANCING CONFORM TO ANSI Y14.5M-1982
- 2 "e" REPRESENTS THE BASIC SOLDER BALL GRID PITCH
- 3 "M" REPRESENTS THE MAXIMUM SOLDER BALL MATRIX SIZE
- 4 "N" REPRESENTS THE BALLOUNT NUMBER
- 5 DIMENSION "b" IS MEASURED AT THE MAXIMUM SOLDER BALL DIAMETER, PARALLEL TO PRIMARY DATUM $\square\text{-C-}$
- 6 SEATING PLANE AND PRIMARY DATUM $\square\text{-C-}$ ARE DEFINED BY THE SPHERICAL CROWNS OF THE SOLDER BALLS
- 7 "A1" ID CORNER MUST BE IDENTIFIED BY CHAMFER, INK MARK, METALLIZED MARKING, INDENTATION OR OTHER FEATURE ON PACKAGE BODY
- 8 EXACT SHAPE OF EACH CORNER IS OPTIONAL
- 9 ALL DIMENSIONS ARE IN MILLIMETERS

TOLERANCES UNLESS SPECIFIED		 6024 Silver Creek Valley Rd San Jose, CA 95138 PHONE: (408) 284-8200 FAX: (408) 284-3572	
DECIMAL	ANGULAR	TITLE	AN/MN 360 PACKAGE OUTLINE
XXX±	±	DRAWN	25.0 x 25.0 mm BODY
XXXX±		CHECKED	1.27 mm PITCH FCBG6A
APPROVALS	DATE	SIZE	DRAWING NO.
		C	PSC-4155
DO NOT SCALE DRAWING		SHEET 2 OF 3	

REVISIONS			
REV	DESCRIPTION	DATE	APPROVED
00	INITIAL RELEASE	01/29/07	PKP
01	CHANGE NAME FROM AN/RN to AN/MN	4/3/08	PKP
02	COMBINE POD & LAND PATTERN	5/29/13	KS

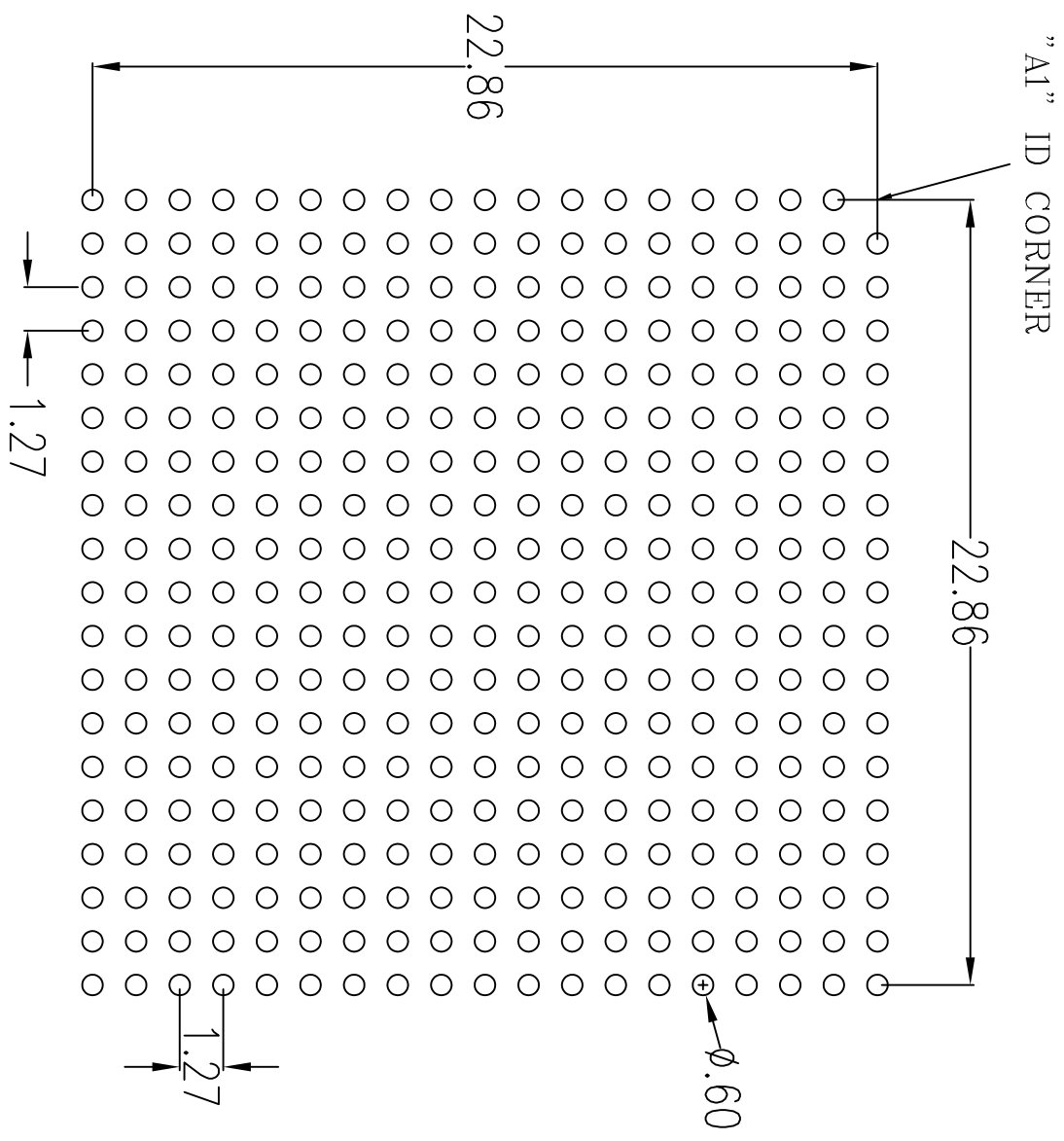

RECOMMENDED LAND PATTERN DIMENSION

TOLERANCES UNLESS SPECIFIED		6024 Silver Creek Valley Rd San Jose, CA 95138 PHONE: (408) 284-8200 FAX: (408) 284-5372	
DECIMAL	ANGULAR	 www.IDT.com	
±	±		
XXXXX		TITLE AN/MN 360 PACKAGE OUTLINE DRAWN /BAC 08/13/12 CHECKED SIZE DRAWING No. PSC-4155 DO NOT SCALE DRAWING	
APPROVALS	DATE	REV	02