

# PACKAGES LINE-UP FOR RF AND MICROWAVE DEVICES

Common Information

## Notice

1. Descriptions of circuits, software and other related information in this document are provided only to illustrate the operation of semiconductor products and application examples. You are fully responsible for the incorporation of these circuits, software, and information in the design of your equipment. Renesas Electronics assumes no responsibility for any losses incurred by you or third parties arising from the use of these circuits, software, or information.
2. Renesas Electronics has used reasonable care in preparing the information included in this document, but Renesas Electronics does not warrant that such information is error free. Renesas Electronics assumes no liability whatsoever for any damages incurred by you resulting from errors in or omissions from the information included herein.
3. Renesas Electronics does not assume any liability for infringement of patents, copyrights, or other intellectual property rights of third parties by or arising from the use of Renesas Electronics products or technical information described in this document. No license, express, implied or otherwise, is granted hereby under any patents, copyrights or other intellectual property rights of Renesas Electronics or others.
4. You should not alter, modify, copy, or otherwise misappropriate any Renesas Electronics product, whether in whole or in part. Renesas Electronics assumes no responsibility for any losses incurred by you or third parties arising from such alteration, modification, copy or otherwise misappropriation of Renesas Electronics product.
5. Renesas Electronics products are classified according to the following two quality grades: "Standard" and "High Quality". The recommended applications for each Renesas Electronics product depends on the product's quality grade, as indicated below.  
"Standard": Computers; office equipment; communications equipment; test and measurement equipment; audio and visual equipment; home electronic appliances; machine tools; personal electronic equipment; and industrial robots etc.  
"High Quality": Transportation equipment (automobiles, trains, ships, etc.); traffic control systems; anti-disaster systems; anti-crime systems; and safety equipment etc.  

Renesas Electronics products are neither intended nor authorized for use in products or systems that may pose a direct threat to human life or bodily injury (artificial life support devices or systems, surgical implantations etc.), or may cause serious property damages (nuclear reactor control systems, military equipment etc.). You must check the quality grade of each Renesas Electronics product before using it in a particular application. You may not use any Renesas Electronics product for any application for which it is not intended. Renesas Electronics shall not be in any way liable for any damages or losses incurred by you or third parties arising from the use of any Renesas Electronics product for which the product is not intended by Renesas Electronics.
6. You should use the Renesas Electronics products described in this document within the range specified by Renesas Electronics, especially with respect to the maximum rating, operating supply voltage range, movement power voltage range, heat radiation characteristics, installation and other product characteristics. Renesas Electronics shall have no liability for malfunctions or damages arising out of the use of Renesas Electronics products beyond such specified ranges.
7. Although Renesas Electronics endeavors to improve the quality and reliability of its products, semiconductor products have specific characteristics such as the occurrence of failure at a certain rate and malfunctions under certain use conditions. Further, Renesas Electronics products are not subject to radiation resistance design. Please be sure to implement safety measures to guard them against the possibility of physical injury, and injury or damage caused by fire in the event of the failure of a Renesas Electronics product, such as safety design for hardware and software including but not limited to redundancy, fire control and malfunction prevention, appropriate treatment for aging degradation or any other appropriate measures. Because the evaluation of microcomputer software alone is very difficult, please evaluate the safety of the final products or systems manufactured by you.
8. Please contact a Renesas Electronics sales office for details as to environmental matters such as the environmental compatibility of each Renesas Electronics product. Please use Renesas Electronics products in compliance with all applicable laws and regulations that regulate the inclusion or use of controlled substances, including without limitation, the EU RoHS Directive. Renesas Electronics assumes no liability for damages or losses occurring as a result of your noncompliance with applicable laws and regulations.
9. Renesas Electronics products and technology may not be used for or incorporated into any products or systems whose manufacture, use, or sale is prohibited under any applicable domestic or foreign laws or regulations. You should not use Renesas Electronics products or technology described in this document for any purpose relating to military applications or use by the military, including but not limited to the development of weapons of mass destruction. When exporting the Renesas Electronics products or technology described in this document, you should comply with the applicable export control laws and regulations and follow the procedures required by such laws and regulations.
10. It is the responsibility of the buyer or distributor of Renesas Electronics products, who distributes, disposes of, or otherwise places the product with a third party, to notify such third party in advance of the contents and conditions set forth in this document, Renesas Electronics assumes no responsibility for any losses incurred by you or third parties as a result of unauthorized use of Renesas Electronics products.
11. This document may not be reproduced or duplicated in any form, in whole or in part, without prior written consent of Renesas Electronics.
12. Please contact a Renesas Electronics sales office if you have any questions regarding the information contained in this document or Renesas Electronics products, or if you have any other inquiries.

(Note 1) "Renesas Electronics" as used in this document means Renesas Electronics Corporation and also includes its majority-owned subsidiaries.

(Note 2) "Renesas Electronics product(s)" means any product developed or manufactured by or for Renesas Electronics.

The mark <R> shows major revised points.

The revised points can be easily searched by copying an "<R>" in the PDF file and specifying it in the "Find what:" field.

## CONTENTS

### <Surface Mount Type Package Line-up Actual Size Illustrations>

(1) Minimold	6
(2) LGA	6
(3) QFN	6
(4) SOP/SON and others	6

### <List of Surface Mount Type Package Drawings>

List of Surface Mount Type Package Drawings	7
---	---

### <List of Special Type Package Drawings>

List of Special Type Package Drawings	9
---------------------------------------	---

### <Package List>

Package group general index	10
Surface mount type 3-pin package list	11
Surface mount type 4-pin package list	12
Surface mount type 6-pin package list	13
Surface mount type 8, 10-pin package list	14
Surface mount type 12, 14-pin package list	15
Surface mount type 16-pin package list	16
Surface mount type 20-pin package list	17
Surface mount type 24, 28, 30, 32, 36-pin package list	18
Surface mount type 44, 52-pin package list	19
Special type (Low Noise) 83A/83B, 84/84A/84C, S01, S02/S03 package list	20
Special type (Power 1/2) 75, 77, 79A, 95, 96/99 package list	20
Special type (Power 2/2) T-86M, T-91M (3M), T-92M, T-97M (3P), T-101M (3S), T-142M package list	21
Special type (MCM, other) TO-92, 7-Pin Special, Chip package list	21

### <Package Dimensions>

3L2MM [3-Pin Lead-Less Minimold]	22
3MM (33 PKG) [3-Pin Minimold (33 PKG)]	22
3PMM (34 PKG) [3-Pin Power Minimold (34 PKG)]	22
3SLM2 (M33, 0804 PKG) [3-Pin Super Lead-Less Minimold (M33, 0804 PKG)]	22

## PACKAGES LINE-UP FOR RF AND MICROWAVE DEVICES

3TL2MM (M53, T6J) [3-Pin Thin-Type Lead-Less Minimold (M53, T6J)]	23
3SMM [3-Pin Super Minimold]	23
3USMM (19, 1608 PKG) [3-Pin Ultra Super Minimold (19, 1608 PKG)]	23
F3TUSMM [Flat-Lead 3-Pin Thin-Type Ultra Super Minimold]	24
4L2MM (M14, 1208 PKG) [4-Pin Lead-Less Minimold (M14, 1208 PKG)]	24
4MM (39) [4-Pin Minimold (39)]	25
4PMM [4-Pin Power Minimold]	25
4SMM (18) [4-Pin Super Minimold (18)]	25
F4TSMM (M04) [Flat-Lead 4-Pin Thin-Type Super Minimold (M04)]	26
F4TSMM (M05, 2012 PKG) [Flat-Lead 4-Pin Thin-Type Super Minimold (M05, 2012 PKG)]	26
6LGA [6-Pin LGA (CSP Type)]	27
6L2MM (M16, 1208 PKG) [6-Pin Lead-Less Minimold (M16, 1208 PKG)]	28
6L2MM (1511 PKG) [6-Pin Lead-Less Minimold (1511 PKG)]	28
6MM [6-Pin Minimold]	28
6SLM2 (1007 PKG) [6-Pin Super Lead-Less Minimold (1007 PKG)]	28
6SMM (M01, TB) [6-Pin Super Minimold (M01, TB)]	29
6TSMM [6-Pin Thin-Type Super Minimold]	29
F6TUSMM [Flat-Lead 6-Pin Thin-Type Ultra Super Minimold]	29
6SON [6-Pin Plastic SON]	30
6TSON (T5N) [6-Pin Plastic TSON (T5N)]	31
6TSON (T6N) [6-Pin Plastic TSON (T6N)]	31
6TSON (T6X) [6-Pin Plastic TSON (T6X)]	32
6RTSON (T7C) [6-Pin Plastic RTSON (T7C)]	32
6TSSON (T5K) [6-Pin Plastic TSSON (T5K)]	33
6TSSON (T6R) [6-Pin Plastic TSSON (T6R)]	34
8L2MM [8-Pin Lead-Less Minimold]	35
8SOP [8-Pin Plastic SOP (5.72 mm (225))]	35
8SSOP [8-Pin Plastic SSOP (4.45 mm (175))]	36
8TSON [8-Pin Plastic TSON]	36
10TSON (TQ) [10-Pin Plastic TSON (TQ)]	37
10TSSON (T6Q) [10-Pin Plastic TSSON (T6Q)]	38
10TSSOP [10-Pin Plastic TSSOP]	38
12QFN (T5F) [12-Pin Plastic QFN (T5F)]	39
<R> 12QFN (T7K) [12-Pin Plastic QFN (T7K)]	40
12TQFN [12-Pin Plastic TQFN]	41
12TSQFN (T5L) [12-Pin Plastic TSQFN (T5L)]	42
12TSQFN (T6M) [12-Pin Plastic TSQFN (T6M)]	43
14LGA [14-Pin LGA (CSP Type)]	44
14SOP [14-Pin Plastic SOP (5.72 mm (225))]	45
14SSOP [14-Pin Plastic SSOP (5.72 mm (225))]	45
16QFN (T5T) [16-Pin Plastic QFN (T5T)]	46

## PACKAGES LINE-UP FOR RF AND MICROWAVE DEVICES

16QFN (T6C) [16-Pin Plastic QFN (T6C)]	46
16QFN (T6S) [16-Pin Plastic QFN (T6S)]	47
16SSOP [16-Pin Plastic SSOP (5.72 mm (225))]	47
16HTSSOP [16-Pin Plastic HTSSOP]	48
16TSON [16-Pin Plastic TSON]	48
20QFN (0.4) [20-Pin Plastic QFN (0.4 mm pitch)]	49
20RQFN (T5R) [20-Pin Plastic RQFN (T5R)]	49
20QFN (0.5) (K) [20-Pin Plastic QFN (0.5 mm pitch) (K)]	50
20QFN (0.5) (T7G) [20-Pin Plastic QFN (0.5 mm pitch) (T7G)]	51
20TQFN (T6E) [20-Pin Plastic TQFN (T6E)]	52
20LGA [20-Pin LGA (CSP Type)]	53
20SOP [20-Pin Plastic SOP (7.62 mm (300))]	54
20SSOP [20-Pin Plastic SSOP (5.72 mm (225))]	54
24QFN [24-Pin Plastic QFN]	55
<R> 24QFN (T7L) [24-Pin Plastic QFN (T7L)]	56
28QFN (K) [28-Pin Plastic QFN (K)]	57
28QFN (T7A) [28-Pin Plastic QFN (T7A)]	58
30SSOP [30-Pin Plastic SSOP (7.62 mm (300))]	59
32QFN (T5S) [32-Pin Plastic QFN (T5S)]	59
36QFN [36-Pin Plastic QFN]	60
44QFN [44-Pin Plastic QFN]	60
75 [75]	61
77 [77]	61
79A [79A]	61
83A, 83B [83A, 83B]	62
84, 84A, 84C [84, 84A, 84C]	62
95 [95]	62
96/99 [96/99]	62
S01 [S01]	63
S02, S03 [S02, S03]	64
T-86M [T-86M]	65
T-91M (3M) [T-91M (3M)]	65
T-92M [T-92M]	65
T-97M (3P) [T-97M (3P)]	66
T-101M (3S) [T-101M (3S)]	66
T-142M [T-142M]	66
TO-92 [TO-92]	67
7-Pin Special [7-Pin Special With Heatsink]	68
 <Mounting Pad Layout>	
3L2MM [3-Pin Lead-Less Minimold]	69

## PACKAGES LINE-UP FOR RF AND MICROWAVE DEVICES

3MM (33 PKG) [3-Pin Minimold (33 PKG)]	69
3PMM (34 PKG) [3-Pin Power Minimold (34 PKG)]	69
3SLM2 (M33, 0804 PKG) [3-Pin Super Lead-Less Minimold (M33, 0804 PKG)]	69
3TL2MM (M53, T6J) [3-Pin Thin-Type Lead-Less Minimold (M53, T6J)]	69
3SMM [3-Pin Super Minimold]	69
3USMM (19, 1608 PKG) [3-Pin Ultra Super Minimold (19, 1608 PKG)]	69
F3TUSMM [Flat-Lead 3-Pin Thin-Type Ultra Super Minimold]	69
4L2MM (M14, 1208 PKG) [4-Pin Lead-Less Minimold (M14, 1208 PKG)]	69
4MM (39) [4-Pin Minimold (39)]	70
4PMM [4-Pin Power Minimold]	70
4SMM (18) [4-Pin Super Minimold (18)]	70
F4TSMM (M04) [Flat-Lead 4-Pin Thin-Type Super Minimold (M04)]	70
F4TSMM (M05, 2012 PKG) [Flat-Lead 4-Pin Thin-Type Super Minimold (M05, 2012 PKG)]	70
6L2MM (M16, 1208 PKG) [6-Pin Lead-Less Minimold (M16, 1208 PKG)]	70
6L2MM (1511 PKG) [6-Pin Lead-Less Minimold (1511 PKG) for Silicon MMIC/GaAs MMIC]	70
6MM [6-Pin Minimold]	70
6SLM2 (1007 PKG) [6-Pin Super Lead-Less Minimold (1007 PKG)]	70
6SMM (M01, TB) [6-Pin Super Minimold (M01, TB)]	71
6TSON [6-Pin Plastic TSON]	71
6TSSON (T5K) [6-Pin Plastic TSSON (T5K)]	71
6TSSON (T6R) [6-Pin Plastic TSSON (T6R)]	71
F6TUSMM [Flat-Lead 6-Pin Thin-Type Ultra Super Minimold]	71
8L2MM [8-Pin Lead-Less Minimold]	71
8SSOP [8-Pin Plastic SSOP (4.45 mm (175))]	71
8TSON [8-Pin Plastic TSON]	71
10TSON [10-Pin Plastic TSON]	71
10TSSON [10-Pin Plastic TSSON]	72
12QFN [12-Pin Plastic QFN]	72
<R> 12QFN (T7K) [12-Pin Plastic QFN (T7K)]	72
12TQFN [12-Pin Plastic TQFN]	72
12TSQFN (T5L) [12-Pin Plastic TSQFN (T5L)]	72
12TSQFN (T6M) [12-Pin Plastic TSQFN (T6M)]	72
14LGA [14-Pin LGA (CSP Type)]	72
14SSOP [14-Pin Plastic SSOP (5.72 mm (225))]	72
16QFN (T5T/T6S) [16-Pin Plastic QFN (T5T/T6S)]	72
16QFN (T6C) [16-Pin Plastic QFN (T6C)]	73
16SSOP [16-Pin Plastic SSOP (5.72 mm (225))]	73
20SSOP [20-Pin Plastic SSOP (5.72 mm (225))]	73
20QFN (0.4) [20-Pin Plastic QFN (0.4 mm pitch)]	73
20QFN (0.5) (T7G) [20-Pin Plastic QFN (0.5 mm pitch) (T7G)]	73
20RQFN [20-Pin Plastic RQFN]	73

## PACKAGES LINE-UP FOR RF AND MICROWAVE DEVICES

---

24QFN [24-Pin Plastic QFN].....	73
<R> 24QFN (T7L) [24-Pin Plastic QFN (T7L)].....	73
28QFN (K) [28-Pin Plastic QFN (K)].....	73
28QFN (T7A) [28-Pin Plastic QFN (T7A)] .....	74
79A [79A] .....	74
S01 [S01] .....	74

Surface Mount Type Package Line-up Actual Size Illustrations

(Unit : mm, Size not exact)

(1) Minimold

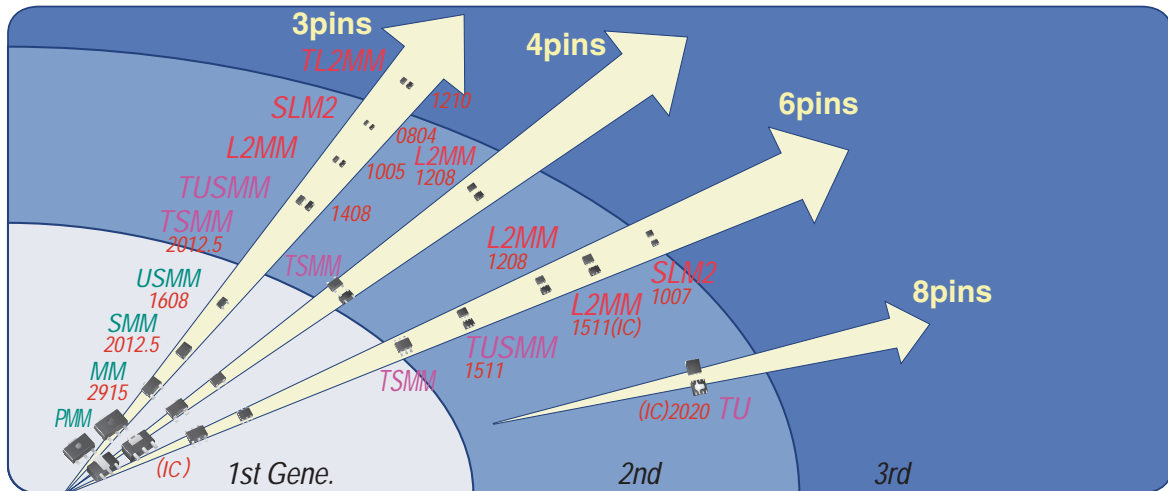

(2) LGA



(3) QFN

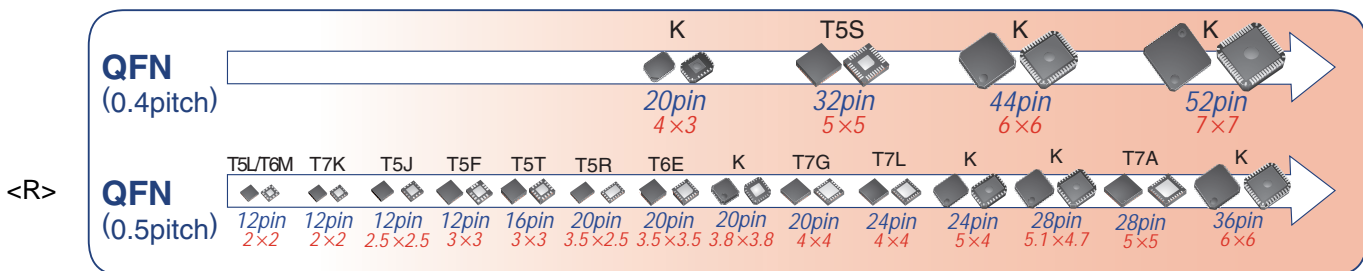



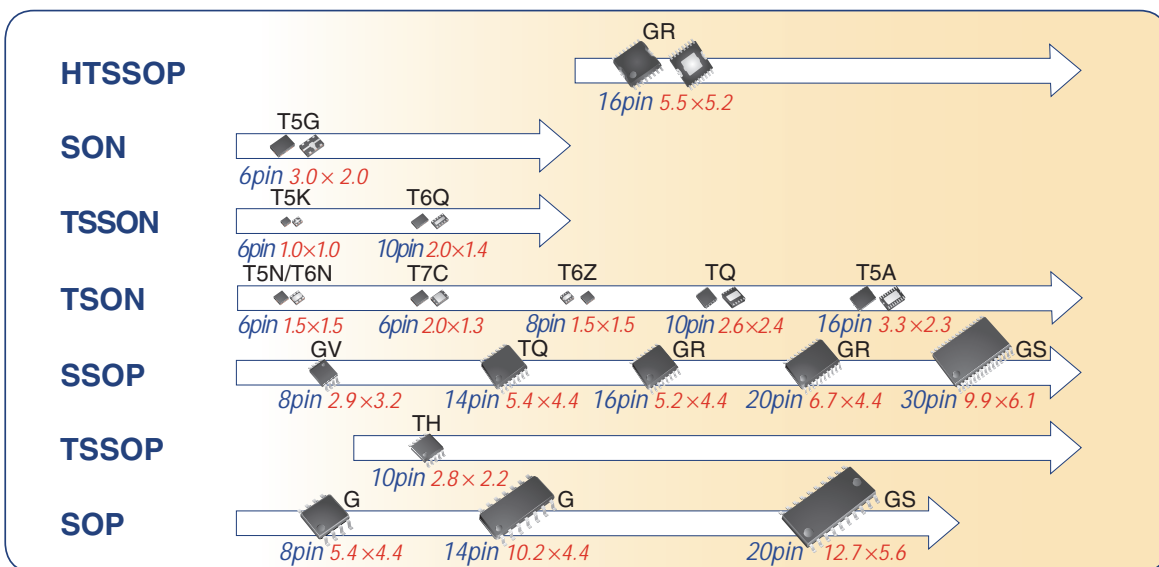













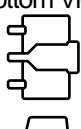



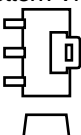



(4) SOP/SOP and others



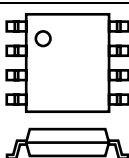
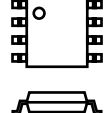

List of Surface Mount Type Package Drawings (1/2)

(Magnification of Dimensions × 2.5)

<b>Abbreviation</b>	<b>3MM</b>	<b>3SMM</b>	<b>3USMM</b>	<b>F3TUSMM</b>	<b>3TL2MM</b>	<b>3L2MM</b>
Outline Diagram and Outline Dimensions L × W × H (mm)	 (2.9×1.5×1.1)	 (2.0×1.3×0.9)	 (1.6×0.8×0.8)	 (1.4×0.8×0.6)	 (1.2×1.0×0.3)	 (1.0×0.7×0.5)
<b>Abbreviation</b>	<b>3SLM2</b>	<b>3PMM (34 PKG)</b>	<b>4MM</b>	<b>4SMM</b>	<b>F4TSMM</b>	<b>4L2MM</b>
Outline Diagram and Outline Dimensions L × W × H (mm)	 (0.8×0.4×0.4)	(Bottom View)  (4.5×2.5×1.5)	 (2.9×1.5×1.1)	 (2.0×1.3×0.9)	 (2.0×1.3×0.6)	 (1.2×0.8×0.5)
<b>Abbreviation</b>	<b>4PMM</b>	<b>6MM</b>	<b>6SMM</b>	<b>6TSMM</b>	<b>6L2MM (1511)</b>	<b>F6TUSMM</b>
Outline Diagram and Outline Dimensions L × W × H (mm)	(Bottom View)  (4.5×2.5×1.5)	 (2.9×1.5×1.1)	 (2.0×1.3×0.9)	 (2.0×1.3×0.6)	 (1.5×1.1×0.6)	 (1.5×1.1×0.6)
<b>Abbreviation</b>	<b>6L2MM (1208)</b>	<b>6SLM2</b>	<b>6LGA</b>	<b>6SON</b>	<b>6RTSON</b>	<b>6TSON</b>
Outline Diagram and Outline Dimensions L × W × H (mm)	 (1.2×0.8×0.5)	 (1.0×0.7×0.4)	(Bottom View)  (1.5×1.5×0.6)	(Bottom View)  (3.0×2.0×0.8)	(Bottom View)  (2.0×1.3×0.4)	(Bottom View)  (1.5×1.5×0.4)
<b>Abbreviation</b>	<b>6TSSON</b>	<b>8SOP</b>	<b>8SSOP</b>	<b>8L2MM</b>	<b>8TSON</b>	
Outline Diagram and Outline Dimensions L × W × H (mm)	(Bottom View)  (1.0×1.0×0.4)	 (5.2×4.4×1.6)	 (2.9×3.2×1.6)	(Bottom View)  (2.0×2.0×0.5)	(Bottom View)  (1.5×1.5×0.4)	







List of Surface Mount Type Package Drawings (2/2)

(Magnification of Dimensions × 2.5)

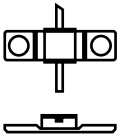
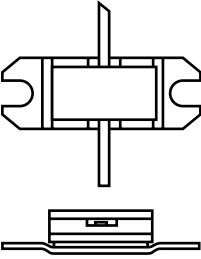
<R>	<b>Abbreviation</b>	<b>10TSSOP</b>	<b>10TSON</b>	<b>10TSSON</b>	<b>12QFN</b>	<b>12QFN(T7K)</b>	<b>12TQFN</b>
	Outline Diagram and Outline			(Bottom View) 	(Bottom View) 	(Bottom View) 	(Bottom View) 
	Dimensions L × W × H (mm)	 (2.8 × 2.2 × 1.1)	 (2.6 × 2.4 × 0.6)	 (2.0 × 1.4 × 0.4)	 (3.0 × 3.0 × 0.8)	 (2.0 × 2.0 × 0.6)	 (2.5 × 2.5 × 0.4)
<R>	<b>Abbreviation</b>	<b>12TSQFN</b>	<b>14SOP</b>	<b>14SSOP</b>	<b>14LGA</b>	<b>16HTSSOP</b>	
	Outline Diagram and Outline	(Bottom View) 			(Bottom View) 	(Bottom View) 	
	Dimensions L × W × H (mm)	 (2.0 × 2.0 × 0.4)	 (10.2 × 4.4 × 1.6)	 (5.4 × 4.4 × 1.6)	 (2.5 × 2.5 × 0.6)	 (5.5 × 5.2 × 0.9)	
<R>	<b>Abbreviation</b>	<b>16QFN</b>	<b>16SSOP</b>	<b>16TSON</b>	<b>20SOP</b>	<b>20SSOP</b>	
	Outline Diagram and Outline	(Bottom View) 		(Bottom View) 			
	Dimensions L × W × H (mm)	 (3.0 × 3.0 × 0.8)	 (5.2 × 4.4 × 1.6)	 (3.3 × 2.3 × 0.6)	 (12.7 × 5.6 × 1.7)	 (6.7 × 4.4 × 1.6)	
<R>	<b>Abbreviation</b>	<b>20QFN (0.4)</b>	<b>20QFN (0.5)(K)</b>	<b>20QFN (0.5) (T7G)</b>	<b>20TQFN</b>	<b>20RQFN</b>	
	Outline Diagram and Outline				(Bottom View) 	(Bottom View) 	
	Dimensions L × W × H (mm)	 (4.0 × 3.0 × 0.9)	 (3.8 × 3.8 × 0.9)	 (4 × 4 × 0.6)	 (3.5 × 3.5 × 0.6)	 (3.5 × 2.5 × 0.6)	
<R>	<b>Abbreviation</b>	<b>20LGA</b>	<b>24QFN</b>	<b>24QFN(T7L)</b>	<b>28QFN (K)</b>	<b>28QFN (T7A)</b>	
	Outline Diagram and Outline	(Bottom View) 		(Bottom View) 			
	Dimensions L × W × H (mm)	 (3.0 × 3.0 × 0.6)	 (5.0 × 4.0 × 1.0)	 (4 × 4 × 0.6)	 (5.1 × 4.7 × 1.0)	 (5.0 × 5.0 × 0.7)	
<R>	<b>Abbreviation</b>	<b>30SSOP</b>		<b>32QFN</b>	<b>36QFN</b>	<b>44QFN</b>	
	Outline Diagram and Outline			(Bottom View) 			
	Dimensions L × W × H (mm)	 (9.9 × 6.1 × 1.8)		 (5.0 × 5.0 × 0.9)	 (6.0 × 6.0 × 1.0)	 (6.0 × 6.0 × 1.0)	

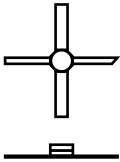
List of Special Type Package Drawings (1/2)

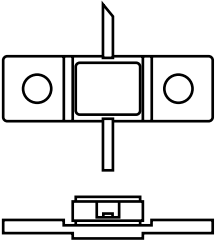
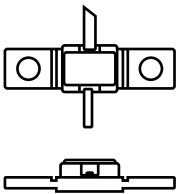
(Magnification of Dimensions × 1.5)

Abbreviation	75	77	79A	83A, 83B	
Outline Diagram and Outline Dimensions L × W × H (mm)	 (9.8 × 2.7 × 2.3)	 (17.5 × 6.4 × 3.8)	 (4.4 × 4.2 × 0.9)	 (1.9 × 1.9 × 1.6)	
Abbreviation	84, 84A, 84C	95	96/99	S01	S02, S03
Outline Diagram and Outline Dimensions L × W × H (mm)	 (1.8 × 1.8 × 1.8)	 (18.5 × 5.9 × 4.5)	 (15.0 × 4.3 × 5.0)	 (2.0 × 2.0 × 1.5)	 (2.6 × 2.6 × 1.5)

List of Special Type Package Drawings (2/2)

(Magnification of Dimensions × 1.0)

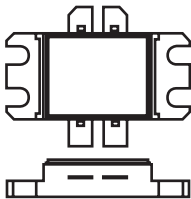
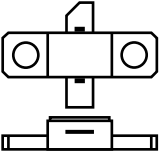
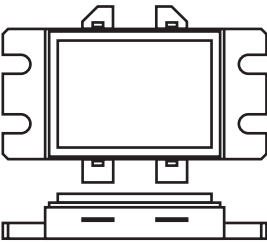
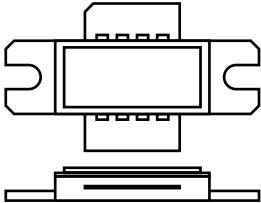
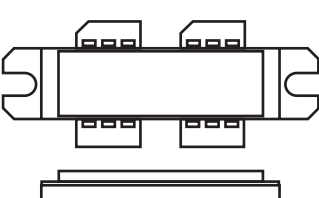
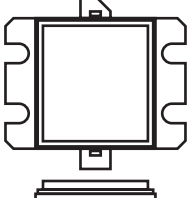
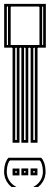
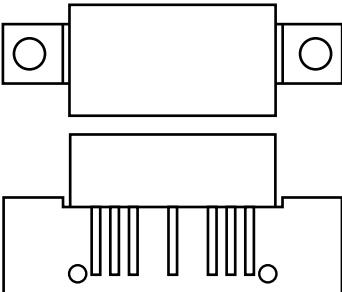







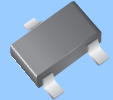

Abbreviation	T-86M	T-91M (3M)	T-92M	T-97M (3P)
Outline Diagram and Outline Dimensions L × W × H (mm)	 (24.5 × 11.4 × 4.9)	 (20.3 × 5.8 × 4.2)	 (35.2 × 17.4 × 6.0)	 (34.0 × 9.9 × 4.4)
Abbreviation	T-101M (3S)	T-142M	TO-92	7-Pin Special
Outline Diagram and Outline Dimensions L × W × H (mm)	 (41.2 × 10.2 × 5.0)	 (24.0 × 17.4 × 5.7)	 (5.5 × 5.2 × 4.2)	 (45.1 × 14.9 × 21.5)

## Package List

### Package group general index

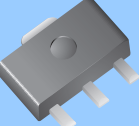
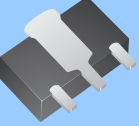

Type	Group	Abbreviation
Surface mount type	3-pin	3MM, 3SMM, 3USMM, F3TUSMM, 3L2MM, 3TL2MM, 3SLM2, 3PMM
	4-pin	4MM, 4SMM, F4TSMM, 4L2MM, 4PMM
	6-pin	6MM, 6SMM, 6TSMM, 6SLM2, 6L2MM, F6TUSMM, 6LGA, 6SON, 6TSON, 6RTSON, 6TSSON
	8-pin	8SOP, 8SSOP, 8L2MM, 8TSON
	10-pin	10TSSOP, 10TSON, 10TSSON, 10LGA
	12-pin	12QFN, 12TQFN, 12TSQFN
	14-pin	14SOP, 14SSOP, 14LGA
	16-pin	16HTSSOP, 16QFN, 16SSOP, 16TSON
	20-pin	20SOP, 20SSOP, 20QFN, 20TQFN, 20RQFN, 20LGA
	24 to 36-pin	24QFN, 28QFN, 30SSOP, 32QFN, 36QFN
	44, 52-pin	44QFN, 52QFN
Special type	Low Noise	83A, 83B, 84, 84A, 84C, S01, S02, S03
	Power 1/2	75, 77, 79A, 95, 96/99
	Power 2/2	T-86M, T-91M (3M), T-92M, T-97M (3P), T-101M (3S), T-142M
	MCM, other	TO-92, 7-Pin Special, Chip

Surface mount type 3-pin package list

Abbreviation	3MM (33)	3SMM	3USMM	F3TUSMM	3L2MM
Outline Diagram and Outline Dimensions L × W × H (mm) Magnification of Dimensions × 3.5	 (2.9 × 1.5 × 1.1)	 (2.0 × 1.3 × 0.9)	 (1.6 × 0.8 × 0.8)	(Top View)  (Bottom View)  (1.4 × 0.8 × 0.6)	(Top View)  (Bottom View)  (1.0 × 0.7 × 0.5)
Abbreviation	3TL2MM	3SLM2 (0804)	3PMM (34)		
Outline Diagram and Outline Dimensions L × W × H (mm) Magnification of Dimensions × 3.5	(Top View)  (Bottom View)  (1.2 × 1.0 × 0.3)	(Top View)  (Bottom View)  (0.8 × 0.4 × 0.4)	(Top View)  (Bottom View)  (4.5 × 2.5 × 1.5)		



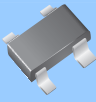

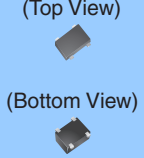
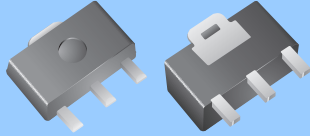





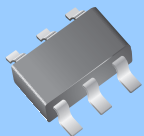
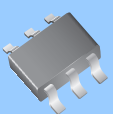
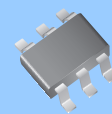



Abbreviation	Package Code		Package Name	Drawings	
	NE	IC		Package	Land Pattern
3MM	33		3-Pin Minimold (33 PKG)	○	○
3SMM	30		3-Pin Super Minimold	○	○
3USMM	19		3-Pin Ultra Super Minimold (1608 PKG)	○	○
F3TUSMM	M03		Flat-Lead 3-Pin Thin-Type Ultra Super Minimold	○	○
3L2MM	M13		3-Pin Lead-Less Minimold	○	○
3TL2MM	M53	T6J	3-Pin Thin-Type Lead-Less Minimold	○	○
3SLM2	M33		3-Pin Super Lead-Less Minimold (0804 PKG)	○	○
3PMM	34		3-Pin Power Minimold (34 PKG)	○	○

Surface mount type 4-pin package list

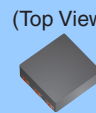
Abbreviation	4MM	4SMM	F4TSMM (2012)
Outline Diagram and Outline Dimensions L × W × H (mm) Magnification of Dimensions × 3.5	 (2.9 × 1.5 × 1.1)	 (2.0 × 1.3 × 0.9)	 (2.0 × 1.3 × 0.6)
Abbreviation	4L2MM (1208)	4PMM	
Outline Diagram and Outline Dimensions L × W × H (mm) Magnification of Dimensions × 3.5	 (1.2 × 0.8 × 0.5)	 (4.5 × 2.5 × 1.5)	

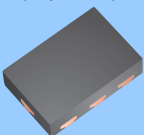
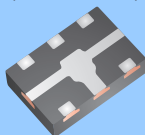
Abbreviation	Package Code		Package Name	Drawings	
	NE	IC		Package	Land Pattern
4MM	39		4-Pin Minimold (39)	○	○
4SMM	18		4-Pin Super Minimold (18)	○	○
F4TSMM	M04		Flat-Lead 4-Pin Thin-Type Super Minimold	○	○
F4TSMM	M05		Flat-Lead 4-Pin Thin-Type Super Minimold (2012 PKG)	○	○
4L2MM	M14		4-Pin Lead-Less Minimold (1208 PKG)	○	○
4PMM	M02		4-Pin Power Minimold	○	○

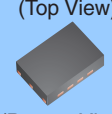
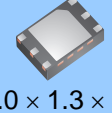





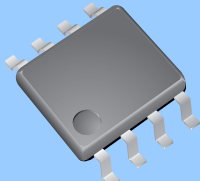
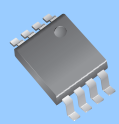

Surface mount type 6-pin package list

Abbreviation	6MM	6SMM	6TSMM	6L2MM (1511)	F6TUSMM	
Outline Diagram and Outline Dimensions L × W × H (mm) Magnification of Dimensions × 5.0	 (2.9 × 1.5 × 1.1)	 (2.0 × 1.3 × 0.9)	 (2.0 × 1.3 × 0.6)	 (Top View)  (Bottom View) (1.5 × 1.1 × 0.6)	 (Top View)  (Bottom View) (1.5 × 1.1 × 0.6)	
Abbreviation	6L2MM (1208)		6SLM2 (1007)		6LGA	
Outline Diagram and Outline Dimensions L × W × H (mm) Magnification of Dimensions × 5.0	 (Top View)  (Bottom View) (1.2 × 0.8 × 0.5)		 (Top View)  (Bottom View) (1.0 × 0.7 × 0.4)		 (Top View)  (Bottom View) (1.5 × 1.5 × 0.6)	
Abbreviation	6SON		6TSON		6RTSON	6TSSON
Outline Diagram and Outline Dimensions L × W × H (mm) Magnification of Dimensions × 5.0	 (Top View)	 (Bottom View) (3.0 × 2.0 × 0.8)	 (Top View)	 (Bottom View) (1.5 × 1.5 × 0.4)	 (Top View)  (Bottom View) (2.0 × 1.3 × 0.4)	 (Top View)  (Bottom View) (1.0 × 1.0 × 0.4)

Abbreviation	Package Code		Package Name	Drawings	
	NE	IC		Package	Land Pattern
6MM	M01	T	6-Pin Minimold	○	○
6MM		TA	6-Pin Minimold	○	○
6SMM		T <sup>Note</sup>	6-Pin Super Minimold	○	○
6SMM		TB	6-Pin Super Minimold	○	○
6TSMM		TF <sup>Note</sup>	6-Pin Thin-Type Super Minimold	○	—
6SLM2		TS <sup>Note</sup>	6-Pin Super Lead-Less Minimold (1007 PKG)	○	○
6L2MM	M16	TK	6-Pin Lead-Less Minimold (1511 PKG)	○	○
F6TUSMM		TC <sup>Note</sup>	Flat-Lead 6-Pin Thin-Type Ultra Super Minimold	○	○
6L2MM		TD <sup>Note</sup>	6-Pin Lead-Less Minimold (1208 PKG)	○	○
6LGA		T5B	6-pin LGA (CSP Type)	○	—
6SON		T5G	6-Pin Plastic SON	○	—
6TSON		T5N	6-Pin Plastic TSON (T5N)	○	○
6TSON	T6N	6-Pin Plastic TSON (T6N)	○	○	
6TSON	T6X	6-Pin Plastic TSON (T6X)	○	—	
6RTSON	T7C	6-Pin Plastic RTSON (T7C)	○	—	
6TSSON	T5K	6-Pin Plastic TSSON (T5K)	○	○	
6TSSON	T6R	6-Pin Plastic TSSON (T6R)	○	○	

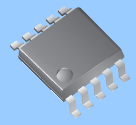
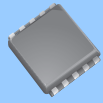
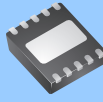
Note: Twin Transistor



Surface mount type 8, 10-pin package list

Abbreviation	8SOP	8SSOP	8L2MM	8TSON
Outline Diagram and Outline Dimensions L × W × H (mm) Magnification of Dimensions × 3.5	 (5.2 × 4.4 × 1.6)	 (2.9 × 3.2 × 1.6)	(Top View)  (Bottom View)  (2.0 × 2.0 × 0.5)	(Top View)  (Bottom View)  (1.5 × 1.5 × 0.4)
Abbreviation	10TSSOP	10TSON	10TSSON	10LGA
Outline Diagram and Outline Dimensions L × W × H (mm) Magnification of Dimensions × 3.5	 (2.8 × 2.2 × 1.1)	(Top View)  (Bottom View)  (2.6 × 2.4 × 0.6)	(Top View)  (Bottom View)  (2.0 × 1.4 × 0.4)	(Top View)  (Bottom View)  (2.0 × 2.1 × 0.6)

Abbreviation	Package Code		Package Name	Drawings	
	NE	IC		Package	Land Pattern
8SOP		G, GR	8-Pin Plastic SOP (5.72 mm (225))	○	—
8SSOP		GV	8-Pin Plastic SSOP (4.45 mm (175))	○	○
8L2MM		TU	8-Pin Lead-Less Minimold	○	○
8TSON		T6Z	8-Pin Plastic TSON	○	○
10TSSOP		TH	10-Pin Plastic TSSOP	○	—
10TSON		TQ	10-Pin Plastic TSON	○	○
10TSSON		T6Q	10-Pin Plastic TSSON	○	○
10LGA		T5C	10-Pin LGA	—	—

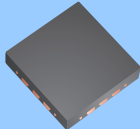
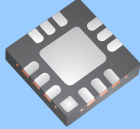
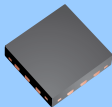
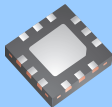
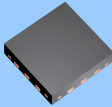
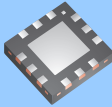

Surface mount type 12, 14-pin package list

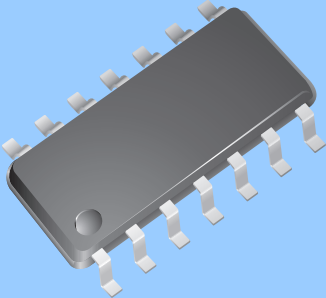
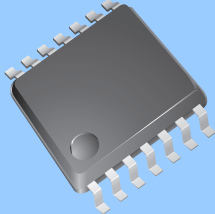
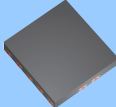
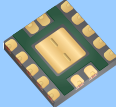
<R>	<b>Abbreviation</b>	<b>12QFN</b>	<b>12QFN(T7K)</b>	<b>12TQFN</b>	<b>12TSQFN</b>
	Outline Diagram and Outline Dimensions L × W × H (mm) Magnification of Dimensions × 4.0	(Top View)  (Bottom View)  (3.0 × 3.0 × 0.8)	(Top View)  (Bottom View)  (2.0 × 2.0 × 0.6)	(Top View)  (Bottom View)  (2.5 × 2.5 × 0.4)	(Top View)  (Bottom View)  (2.0 × 2.0 × 0.4)
	<b>Abbreviation</b>	<b>14SOP</b>		<b>14SSOP</b>	<b>14LGA</b>
	Outline Diagram and Outline Dimensions L × W × H (mm) Magnification of Dimensions × 4.0	 (10.2 × 4.4 × 1.6)		 (5.4 × 4.4 × 1.6)	(Top View)  (Bottom View)  (2.5 × 2.5 × 0.6)

<R>	Abbreviation	Package Code		Package Name	Drawings	
		NE	IC		Package	Land Pattern
	12QFN		T5F	12-Pin Plastic QFN	○	○
	12QFN		T7K	12-Pin Plastic QFN (T7K)	○	○
	12TQFN		T5J	12-Pin Plastic TQFN	○	○
	12TSQFN		T5L	12-Pin Plastic TSQFN (T5L)	○	○
	12TSQFN		T6M	12-Pin Plastic TSQFN (T6M)	○	○
	14SOP	G, GR		14-Pin Plastic SOP (5.72 mm (225))	○	—
	14SSOP	GR		14-Pin Plastic SSOP (5.72 mm (225))	○	○
	14LGA		T5D	14-Pin LGA (CSP Type)	○	○

**Surface mount type 16-pin package list**

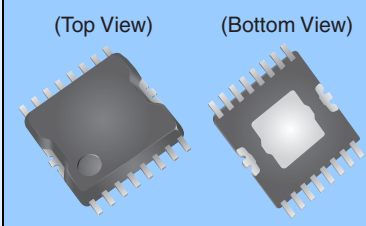
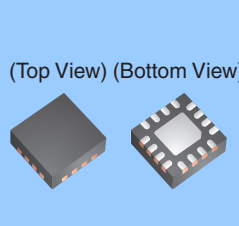
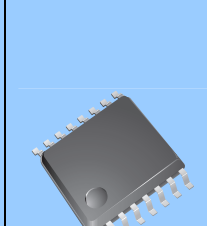
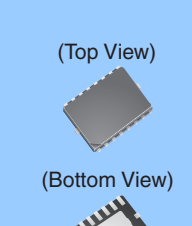
Abbreviation	16HTSSOP	16QFN	16SSOP	16TSON
Outline Diagram and Outline Dimensions L × W × H (mm) Magnification of Dimensions × 3.0	 <p>(Top View) (Bottom View)</p> <p>(5.5 × 5.2 × 0.9)</p>	 <p>(Top View) (Bottom View)</p> <p>(3.0 × 3.0 × 0.8)</p>	 <p>(5.2 × 4.4 × 1.6)</p>	 <p>(Top View)</p> <p>(Bottom View)</p> <p>(3.3 × 2.3 × 0.6)</p>

Abbreviation	Package Code		Package Name	Drawings	
	NE	IC		Package	Land Pattern
16HTSSOP	GR	GR	16-Pin Plastic HTSSOP	○	—
16QFN		T5T	16-Pin Plastic QFN (T5T)	○	○
16QFN		T6C	16-Pin Plastic QFN (T6C)	○	○
16QFN		T6S	16-Pin Plastic QFN (T6S)	○	○
16SSOP		GR	16-Pin Plastic SSOP (5.72 mm (225))	○	○
16TSON		T5A	16-Pin Plastic TSON	○	—

Surface mount type 20-pin package list

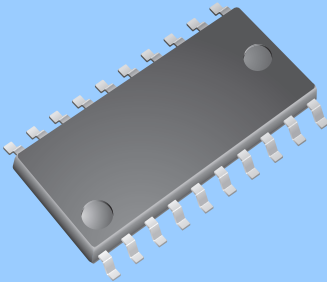
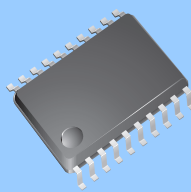
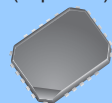
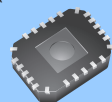
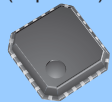
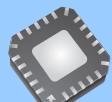
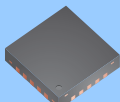
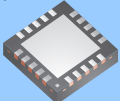
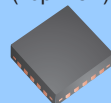
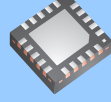
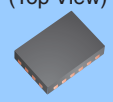
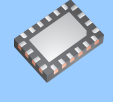
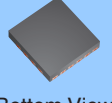
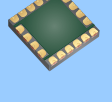
Abbreviation	20SOP	20SSOP	20QFN (0.4)	20QFN (0.5) (K)
Outline Diagram and Outline Dimensions L × W × H (mm) Magnification of Dimensions × 3.0	 (12.7 × 5.6 × 1.7)	 (6.7 × 4.4 × 1.6)	(Top View)  (Bottom View)  (4.0 × 3.0 × 0.9)	(Top View)  (Bottom View)  (3.8 × 3.8 × 0.9)
Abbreviation	20QFN (0.5) (T7G)	20TQFN	20RQFN	20LGA
Outline Diagram and Outline Dimensions L × W × H (mm) Magnification of Dimensions × 3.0	(Top View)  (Bottom View)  (4.0 × 4.0 × 0.6)	(Top View)  (Bottom View)  (3.5 × 3.5 × 0.6)	(Top View)  (Bottom View)  (3.5 × 2.5 × 0.6)	(Top View)  (Bottom View)  (3.0 × 3.0 × 0.6)

Abbreviation	Package Code		Package Name	Drawings	
	NE	IC		Package	Land Pattern
20SOP		GS	20-Pin Plastic SOP (7.62 mm (300))	○	—
20SSOP		GR	20-Pin Plastic SSOP (5.72 mm (225))	○	○
20QFN (0.4)		K	20-Pin Plastic QFN (0.4 mm pitch)	○	○
20QFN (0.5)		K	20-Pin Plastic QFN (0.5 mm pitch)	○	—
20QFN (0.5)		T7G	20-Pin Plastic QFN (0.5 mm pitch)	○	○
20TQFN		T6E	20-Pin Plastic TQFN	○	—
20RQFN		T5R	20-Pin Plastic RQFN	○	○
20LGA		T5E	20-Pin LGA	○	—

Surface mount type 24, 28, 30, 32, 36-pin package list

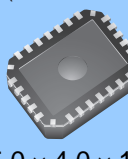
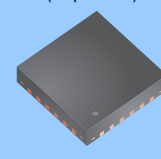
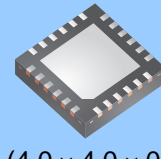
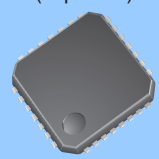
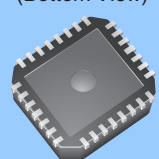
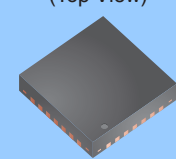
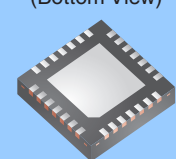
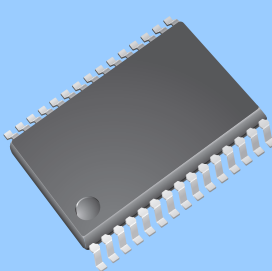
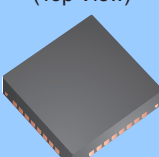
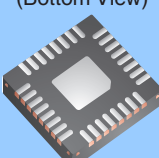
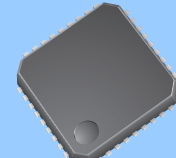
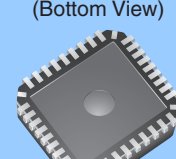
<R>	Abbreviation	24QFN	24QFN(T7L)	28QFN (K)	28QFN (T7A)
	Outline Diagram and Outline Dimensions L × W × H (mm) Magnification of Dimensions × 3.0	 (Top View)  (Bottom View) (5.0 × 4.0 × 1.0)	 (Top View)  (Bottom View) (4.0 × 4.0 × 0.6)	 (Top View)  (Bottom View) (5.1 × 4.7 × 1.0)	 (Top View)  (Bottom View) (5.0 × 5.0 × 0.7)
	Abbreviation	30SSOP		32QFN	36QFN
	Outline Diagram and Outline Dimensions L × W × H (mm) Magnification of Dimensions × 3.0	 (9.9 × 6.1 × 1.8)		 (Top View)  (Bottom View) (5.0 × 5.0 × 0.9)	 (Top View)  (Bottom View) (6.0 × 6.0 × 1.0)

<R>	Abbreviation	Package Code		Package Name	Drawings	
		NE	IC		Package	Land Pattern
	24QFN		K	24-Pin Plastic QFN	○	○
	24QFN		T7L	24-Pin Plastic QFN (T7L)	○	○
	28QFN		K	28-Pin Plastic QFN (K)	○	○
	28QFN		T7A	28-Pin Plastic QFN (T7A)	○	○
	30SSOP		GS	30-Pin Plastic SSOP (7.62 mm (300))	○	—
	32QFN		T5S	32-Pin Plastic QFN	○	—
	36QFN		K	36-Pin Plastic QFN	○	—

**Surface mount type 44, 52-pin package list**

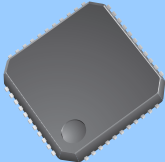
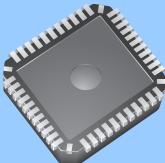
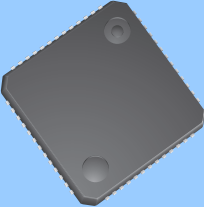
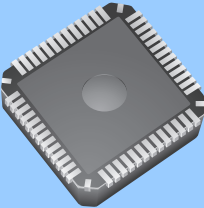
Abbreviation	44QFN	52QFN
Outline Diagram and Outline Dimensions L × W × H (mm) Magnification of Dimensions × 3.0	<p>(Top View)</p>  <p>(Bottom View)</p>  <p>(6.0 × 6.0 × 1.0)</p>	<p>(Top View)</p>  <p>(Bottom View)</p>  <p>(7.0 × 7.0 × 1.0)</p>

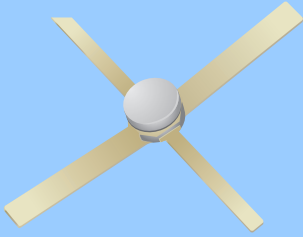
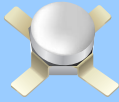
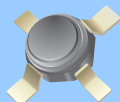
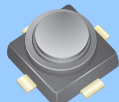

Abbreviation	Package Code		Package Name	Drawings	
	NE	IC		Package	Land Pattern
44QFN		K	44-Pin Plastic QFN	○	—
52QFN		K	52-Pin Plastic QFN	—	—

**Special type (Low Noise) 83A/83B, 84/84A/84C, S01, S02/S03 package list**

Abbreviation	83A, 83B	84, 84A, 84C	S01	S02, S03
Outline Diagram and Outline Dimensions L × W × H (mm) Magnification of Dimensions × 4.0	 (1.9 × 1.9 × 1.6)	 (1.8 × 1.8 × 1.8)	 (2.0 × 2.0 × 1.5)	 (2.6 × 2.6 × 1.5)

Abbreviation	Package Code		Package Name	Drawings	
	NE	IC		Package	Land Pattern
83A/83B	83A/83B		83A/83B Ceramic Package	○	—
84/84A/84C	84/84A/84C		84/84A/84C Ceramic Package	○	—
S01	S01		S01 Hollow Plastic Mold Package	○	○
S02/S03	S02/S03		S02/S03 Hollow Plastic Mold Package	○	—

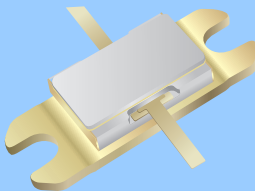
**Special type (Power 1/2) 75, 77, 79A, 95, 96/99 package list**

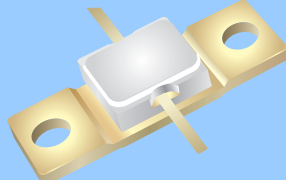
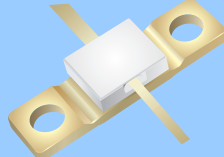
Abbreviation	75	77	79A
Outline Diagram and Outline Dimensions L × W × H (mm) Magnification of Dimensions × 2.0	 (9.8 × 2.7 × 2.3)	 (17.5 × 6.4 × 3.8)	 (4.4 × 4.2 × 0.9)
Abbreviation	95		96/99
Outline Diagram and Outline Dimensions L × W × H (mm) Magnification of Dimensions × 2.0	 (18.5 × 5.9 × 4.5)		 (15.0 × 4.3 × 5.0)

Abbreviation	Package Code		Package Name	Drawings	
	NE	IC		Package	Land Pattern
75	75		75 Ceramic Package	○	—
77	77		77 Ceramic Package	○	—
79A	79A		79A Plastic Mold Package	○	○
95	95		95 Ceramic Package	○	—
96/99	96/99		96/99 Ceramic Package	○	—

**Special type (Power 2/2) T-86M, T-91M (3M), T-92M, T-97M (3P), T-101M (3S), T-142M package list**

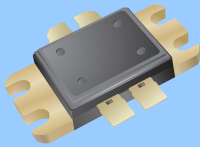
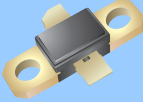
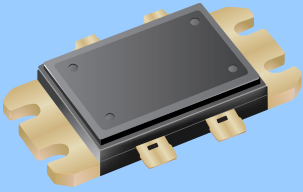
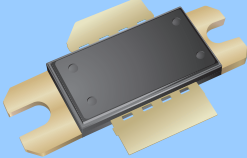
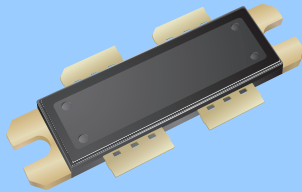
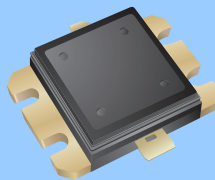
Abbreviation	T-86M	T-91M (3M)	T-92M
Outline Diagram and Outline Dimensions L × W × H (mm) Magnification of Dimensions × 1.0	 (24.5 × 11.4 × 4.9)	 (20.3 × 5.8 × 4.2)	 (35.2 × 17.4 × 5.7)
Abbreviation	T-97M (3P)	T-101M (3S)	T-142M
Outline Diagram and Outline Dimensions L × W × H (mm) Magnification of Dimensions × 1.0	 (34.0 × 9.9 × 4.4)	 (41.2 × 10.2 × 5.0)	 (24.0 × 17.4 × 5.7)

Abbreviation	Package Code		Package Name	Drawings	
	NE	IC		Package	Land Pattern
T-86M	3M		T-86M Hollow Plastic Mold Package	○	—
T-91M			T-91M Hollow Plastic Mold Package	○	—
T-92M			T-92M Hollow Plastic Mold Package	○	—
T-97M	3P		T-97M Hollow Plastic Mold Package	○	—
T-101M			T-101M Hollow Plastic Mold Package	○	—
T-142M	3S		T-142M Hollow Plastic Mold Package	○	—

**Special type (MCM, other) TO-92, 7-Pin Special, Chip package list**

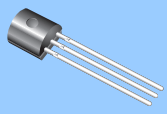
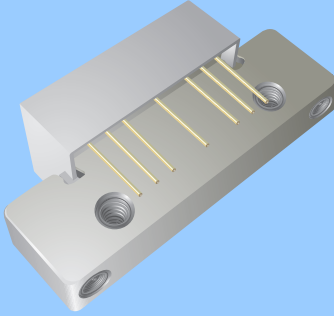
Abbreviation	TO-92	7-Pin Special	Chip
Outline Diagram and Outline Dimensions L × W × H (mm) Magnification of Dimensions × 1.0	 (5.5 × 5.2 × 4.2)	 (45.1 × 14.9 × 21.5)	The Chip size drawing is carried to the data sheet.

Abbreviation	Package Code		Package Name	Drawings	
	NE	IC		Package	Land Pattern
TO-92	32		TO-92 Plastic Mold Package	○	—
7-Pin Special			7-Pin Special With Heatsink	○	—
Chip	00		Chip	—	—

Package Dimensions (1/47)

(Unit : mm)

3-Pin Lead-Less Minimold	3-Pin Minimold (33 PKG)
<p><b>(Bottom View)</b></p>	<p>Marking</p>
3-Pin Power Minimold (34 PKG)	3-Pin Super Lead-Less Minimold (M33, 0804 PKG)
	<p><b>(Bottom View)</b></p>



Package Dimensions (2/47)

(Unit : mm)

3-Pin Thin-Type Lead-Less Minimold (M53, T6J)	
	<p>(Bottom View)</p>
3-Pin Super Minimold	3-Pin Ultra Super Minimold (19, 1608 PKG)

Package Dimensions (3/47)

(Unit : mm)

<p>Flat-Lead 3-Pin Thin-Type Ultra Super Minimold</p>	
<p>Technical drawing of Flat-Lead 3-Pin Thin-Type Ultra Super Minimold. The top view shows a rectangular package with a total width of <math>1.4 \pm 0.1</math> mm and a lead spacing of <math>0.8 \pm 0.1</math> mm. The lead width is <math>0.2 \pm 0.1</math> mm. The side view shows a height of <math>0.59 \pm 0.05</math> mm and a lead thickness of <math>0.15 \pm 0.05</math> mm. Pin positions are labeled 1, 2, and 3.</p>	
<p>4-Pin Lead-Less Minimold (M14, 1208 PKG)</p>	
<p>(Top View)</p> <p>Technical drawing of 4-Pin Lead-Less Minimold (Top View). The package width is <math>1.0 \pm 0.05</math> mm and the lead spacing is <math>0.8 \pm 0.07</math> mm. The total height is <math>1.2 \pm 0.07</math> mm. The lead width is <math>0.15 \pm 0.05</math> mm. Pin positions are labeled 1, 2, 3, and 4.</p>	<p>(Bottom View)</p> <p>Technical drawing of 4-Pin Lead-Less Minimold (Bottom View). The lead spacing is <math>0.6</math> mm and the lead thickness is <math>0.2</math> mm.</p>
<p>Technical drawing of 4-Pin Lead-Less Minimold (Side View). The height is <math>0.5 \pm 0.05</math> mm and the lead thickness is <math>0.11 \pm 0.1</math> mm.</p>	

Package Dimensions (4/47)

(Unit : mm)

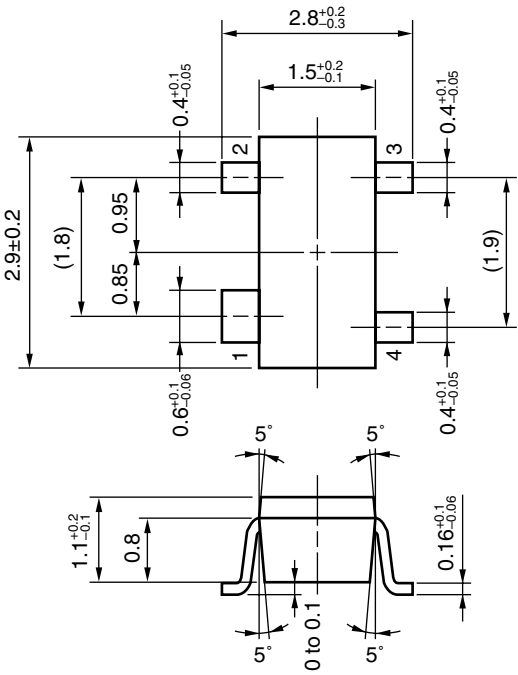
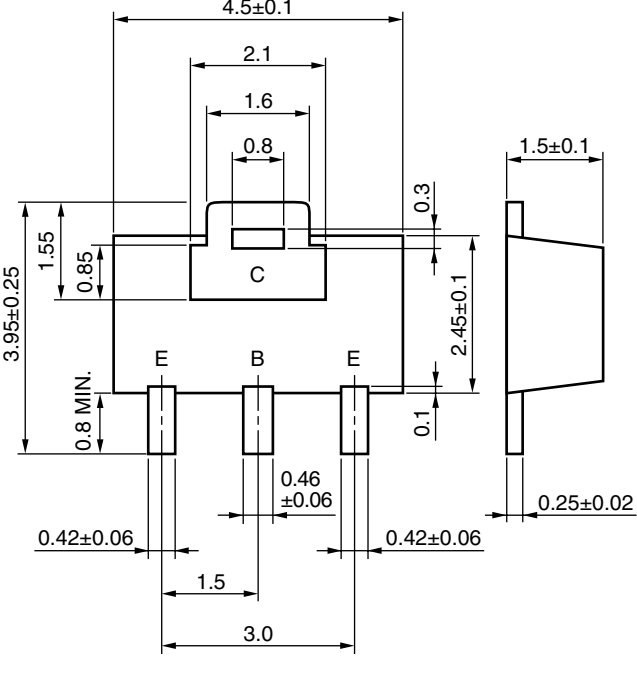
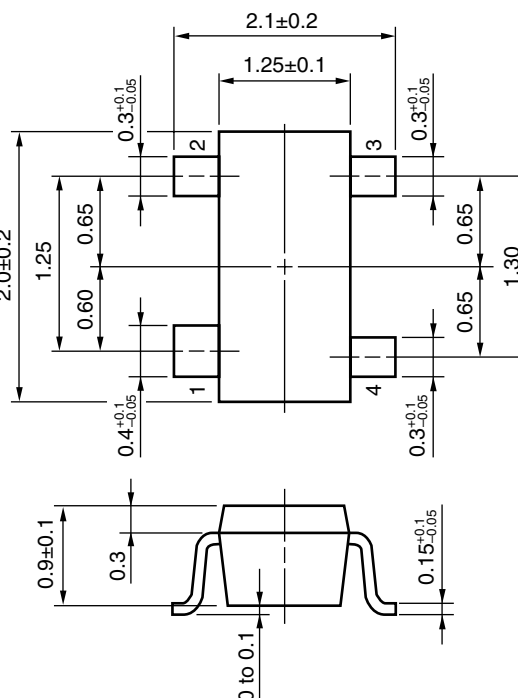
4-Pin Minimold (39)	4-Pin Power Minimold
 <p>Technical drawing of the 4-Pin Minimold (39) package. The top view shows a rectangular package with four pins labeled 1, 2, 3, and 4. Dimensions include a total width of <math>2.8^{+0.2}_{-0.3}</math> mm, a pin pitch of <math>1.5^{+0.2}_{-0.1}</math> mm, and a pin width of <math>0.4^{+0.1}_{-0.05}</math> mm. The total height is <math>2.9 \pm 0.2</math> mm. The side view shows a package with a height of <math>1.1^{+0.2}_{-0.1}</math> mm and a lead height of <math>0.16^{+0.1}_{-0.06}</math> mm. Lead angles are specified as <math>5^\circ</math>. The distance from the center to the lead tip is <math>0.8</math> mm.</p>	 <p>Technical drawing of the 4-Pin Power Minimold package. The top view shows a package with a total width of <math>4.5 \pm 0.1</math> mm and a pin pitch of <math>2.1</math> mm. The pin width is <math>1.6</math> mm and the pin height is <math>0.8</math> mm. The package height is <math>3.95 \pm 0.25</math> mm. The side view shows a package with a height of <math>1.55</math> mm and a lead height of <math>0.1</math> mm. The lead angle is <math>5^\circ</math>. The distance from the center to the lead tip is <math>0.8</math> mm. The package is labeled with C, B, and E.</p>
4-Pin Super Minimold (18)	
 <p>Technical drawing of the 4-Pin Super Minimold (18) package. The top view shows a package with a total width of <math>2.1 \pm 0.2</math> mm and a pin pitch of <math>1.25 \pm 0.1</math> mm. The pin width is <math>0.3^{+0.1}_{-0.05}</math> mm. The total height is <math>2.0 \pm 0.2</math> mm. The side view shows a package with a height of <math>0.9 \pm 0.1</math> mm and a lead height of <math>0.15^{+0.1}_{-0.05}</math> mm. Lead angles are specified as <math>5^\circ</math>. The distance from the center to the lead tip is <math>0.3</math> mm.</p>	

Package Dimensions (5/47)

(Unit : mm)

Flat-Lead 4-Pin Thin-Type Super Minimold (M04)

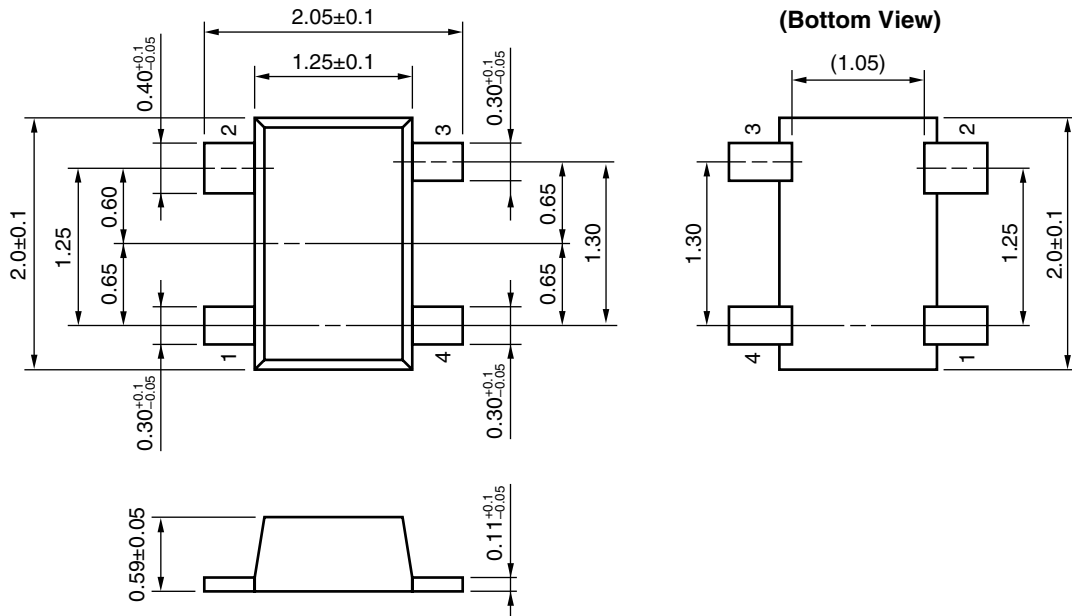

Flat-Lead 4-Pin Thin-Type Super Minimold (M05, 2012 PKG)

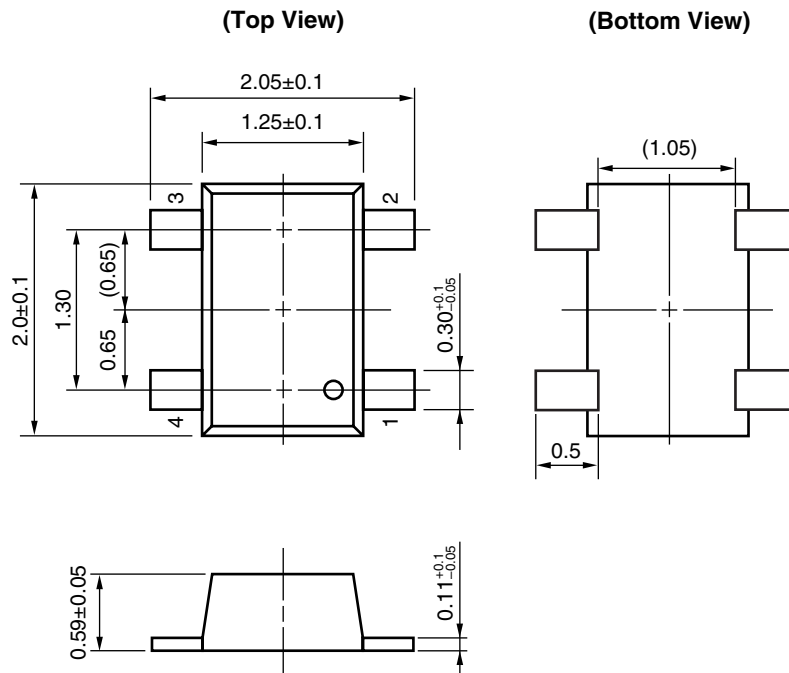

Remark ( ) : Reference value

Package Dimensions (6/47)

(Unit : mm)

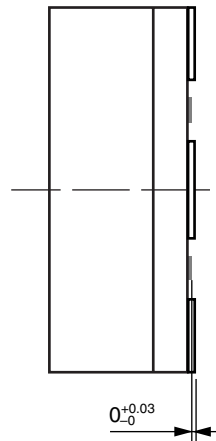
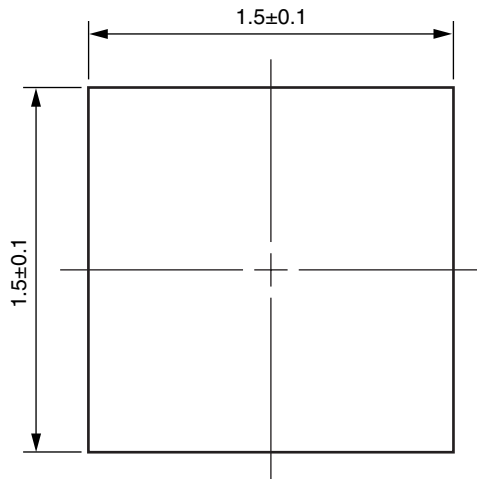

6-Pin LGA (CSP Type)

(Top View)

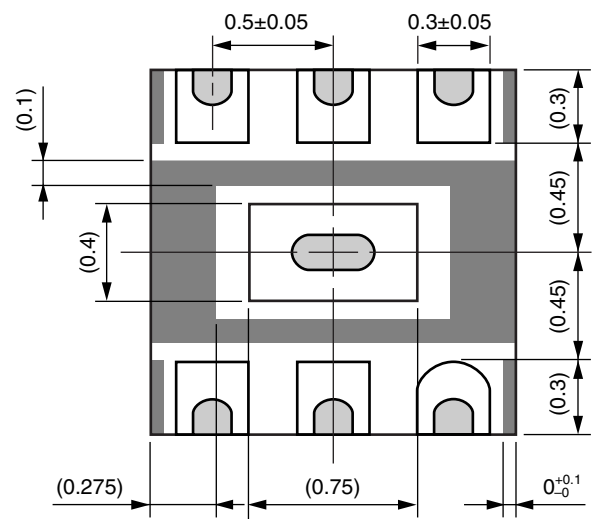
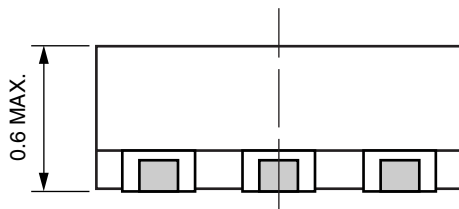

(Bottom View)



-  Through hole
-  Solder resist

Package Dimensions (7/47)

(Unit : mm)

6-Pin Lead-Less Minimold (M16, 1208 PKG)	6-Pin Lead-Less Minimold (1511 PKG)
	<p>(Top View) (Bottom View)</p> <p><b>Remark</b> Dimension<sup>1</sup> is bigger than dimension<sup>2</sup> (dimension<sup>2</sup> = a + b + c).</p>
6-Pin Minimold	6-Pin Super Lead-Less Minimold (1007 PKG)

Package Dimensions (8/47)

(Unit : mm)

6-Pin Super Minimold (M01, TB)	6-Pin Thin-Type Super Minimold
<p>Top view dimensions: 2.1±0.1, 1.25±0.1, 2.0<sup>+0.15</sup>/<sub>-0.20</sub>, 1.3, 0.65, 0.65, 0.2<sup>+0.1</sup>/<sub>-0.05</sub>, 0.1 MIN.</p> <p>Side view dimensions: 0.9±0.1, 0.7, 0.15<sup>+0.1</sup>/<sub>-0.05</sub>, 0 to 0.1</p>	<p>Top view dimensions: 2.10±0.1, 1.25±0.1, 2.00±0.2, 1.30, 0.65, 0.65, 0.22<sup>+0.1</sup>/<sub>-0.05</sub></p> <p>Side view dimensions: 0.60±0.1, 0.45, 0.13±0.05, 0 to 0.1</p>
Flat-Lead 6-Pin Thin-Type Ultra Super Minimold	
<p>Top view dimensions: 1.50±0.1, 1.10±0.1, 1.50±0.1, 0.96, 0.48, 0.48, 0.20<sup>+0.1</sup>/<sub>-0.05</sub></p> <p>Side view dimensions: 0.55±0.05, 0.11<sup>+0.1</sup>/<sub>-0.05</sub></p>	

Package Dimensions (9/47)

(Unit : mm)

6-Pin Plastic SON

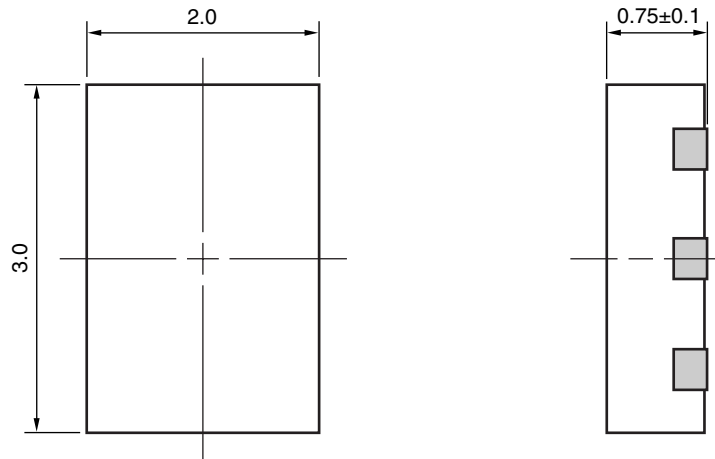

(Bottom View)

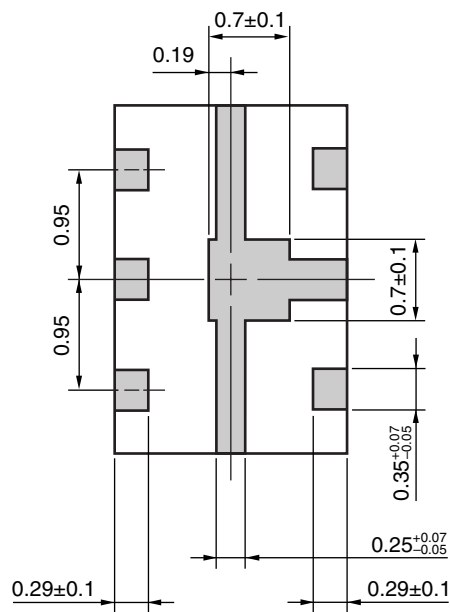



Package Dimensions (10/47)

(Unit : mm)

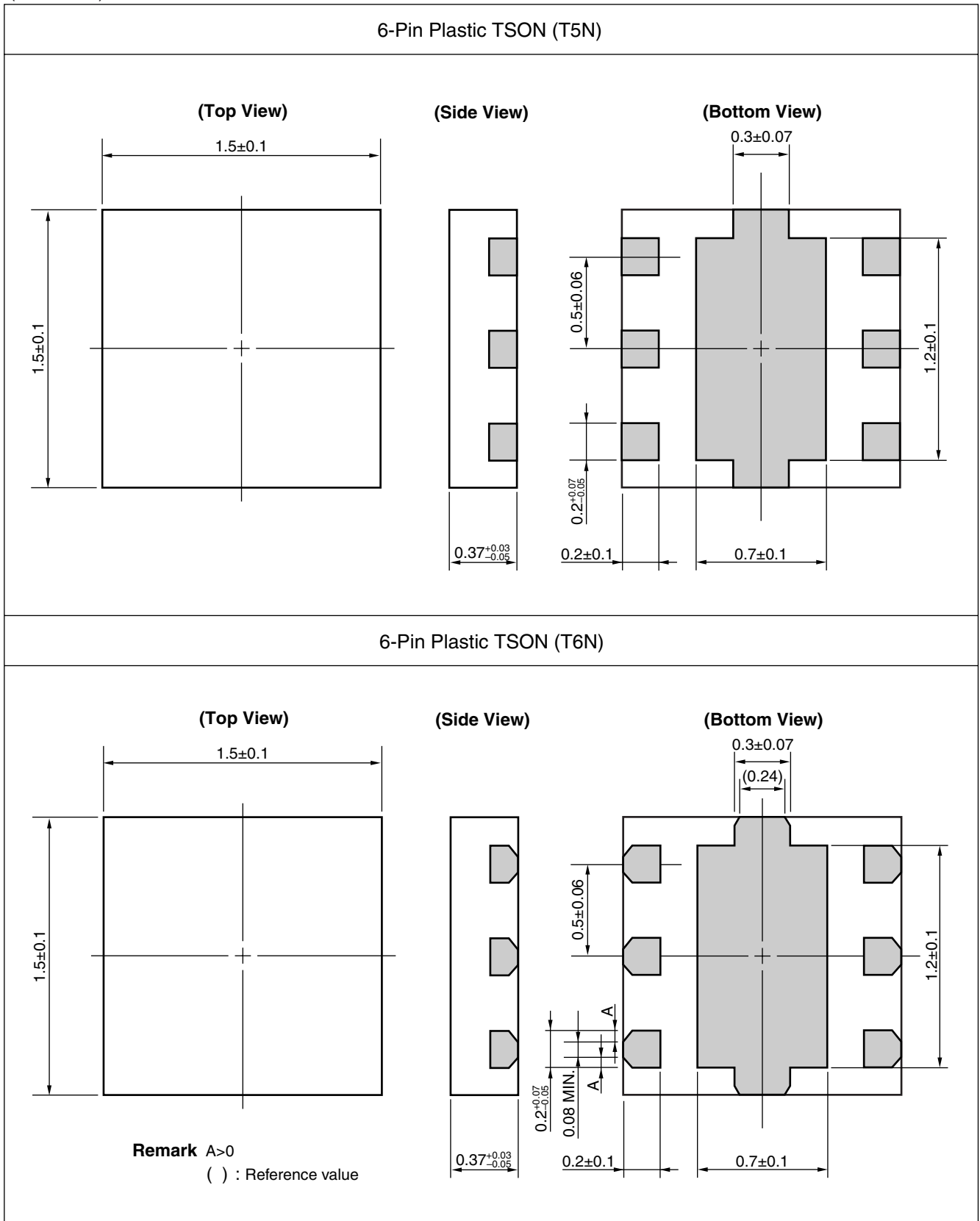

Package Dimensions (11/47)

(Unit : mm)

6-Pin Plastic TSON (T6X)	
<p><b>(Top View)</b></p>	<p><b>(Side View)</b></p>
<p><b>(Bottom View)</b></p>	
<p><b>Remark</b> A&gt;0 ( ) : Reference value</p>	
6-Pin Plastic RTSON (T7C)	
<p><b>(Top View)</b></p>	<p><b>(Side View)</b></p>
<p><b>(Bottom View)</b></p>	
<p><b>Remark</b> A&gt;0 ( ) : Reference value</p>	

Package Dimensions (12/47)

(Unit : mm)

6-Pin Plastic TSSON (T5K)

(Top View)

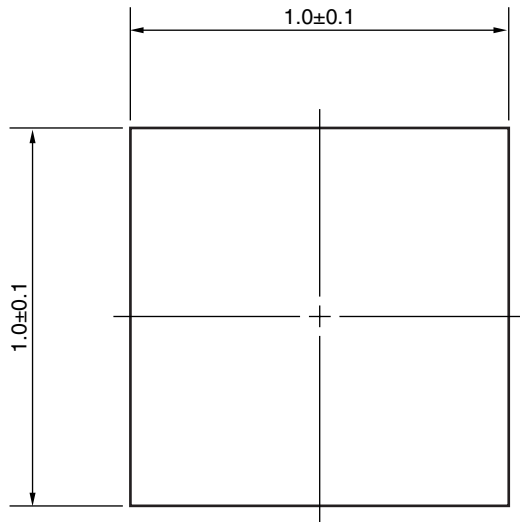

(Bottom View)

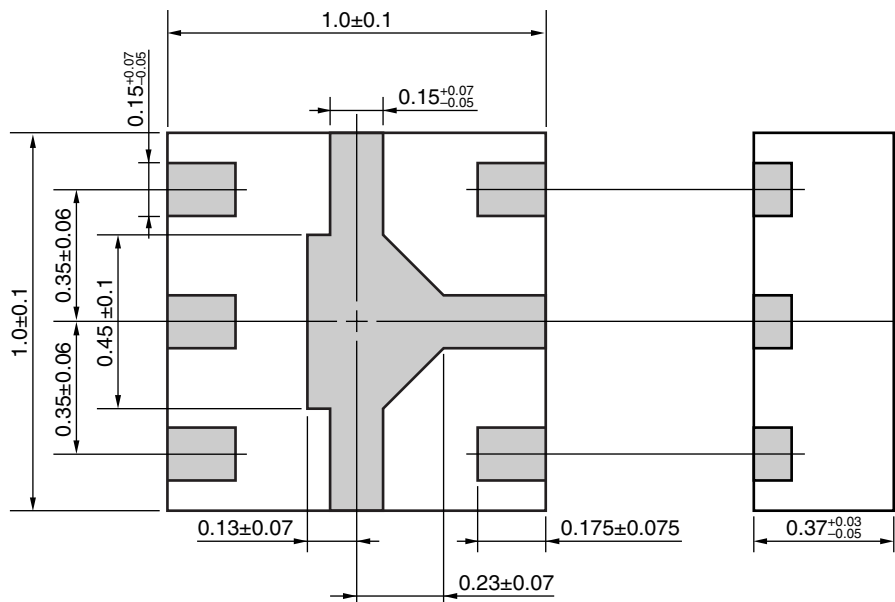

Package Dimensions (13/47)

(Unit : mm)

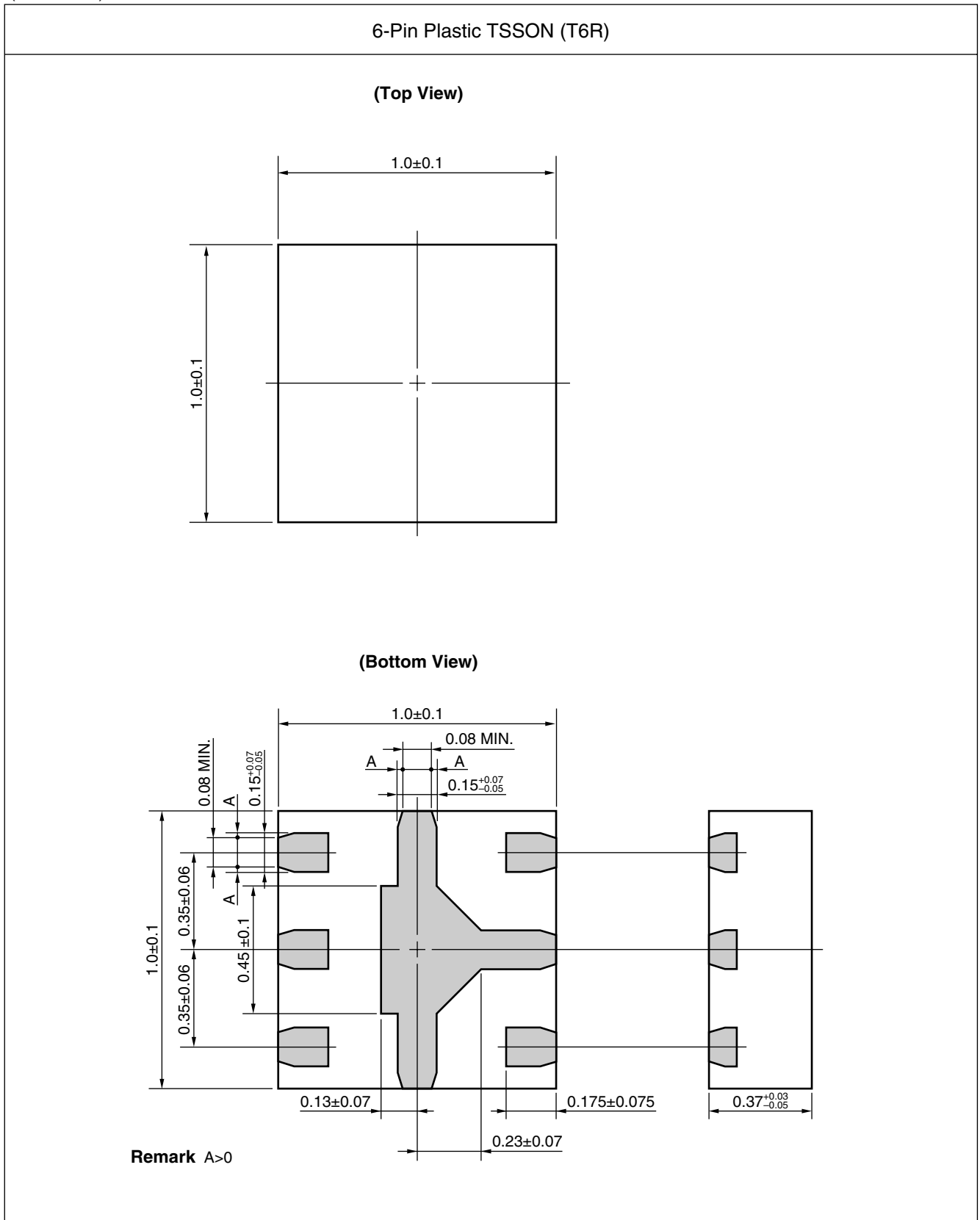

Package Dimensions (14/47)

(Unit : mm)

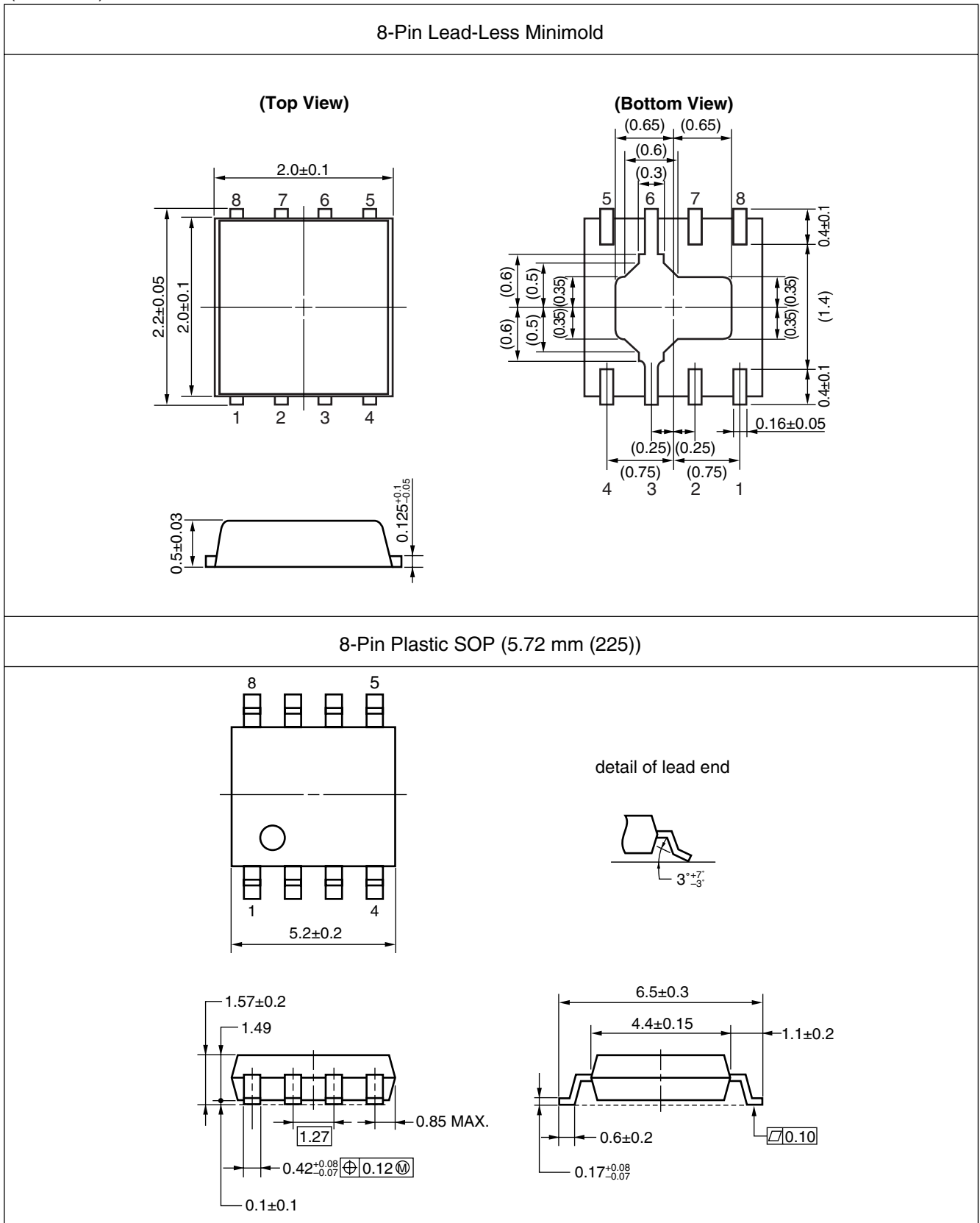

Package Dimensions (15/47)

(Unit : mm)

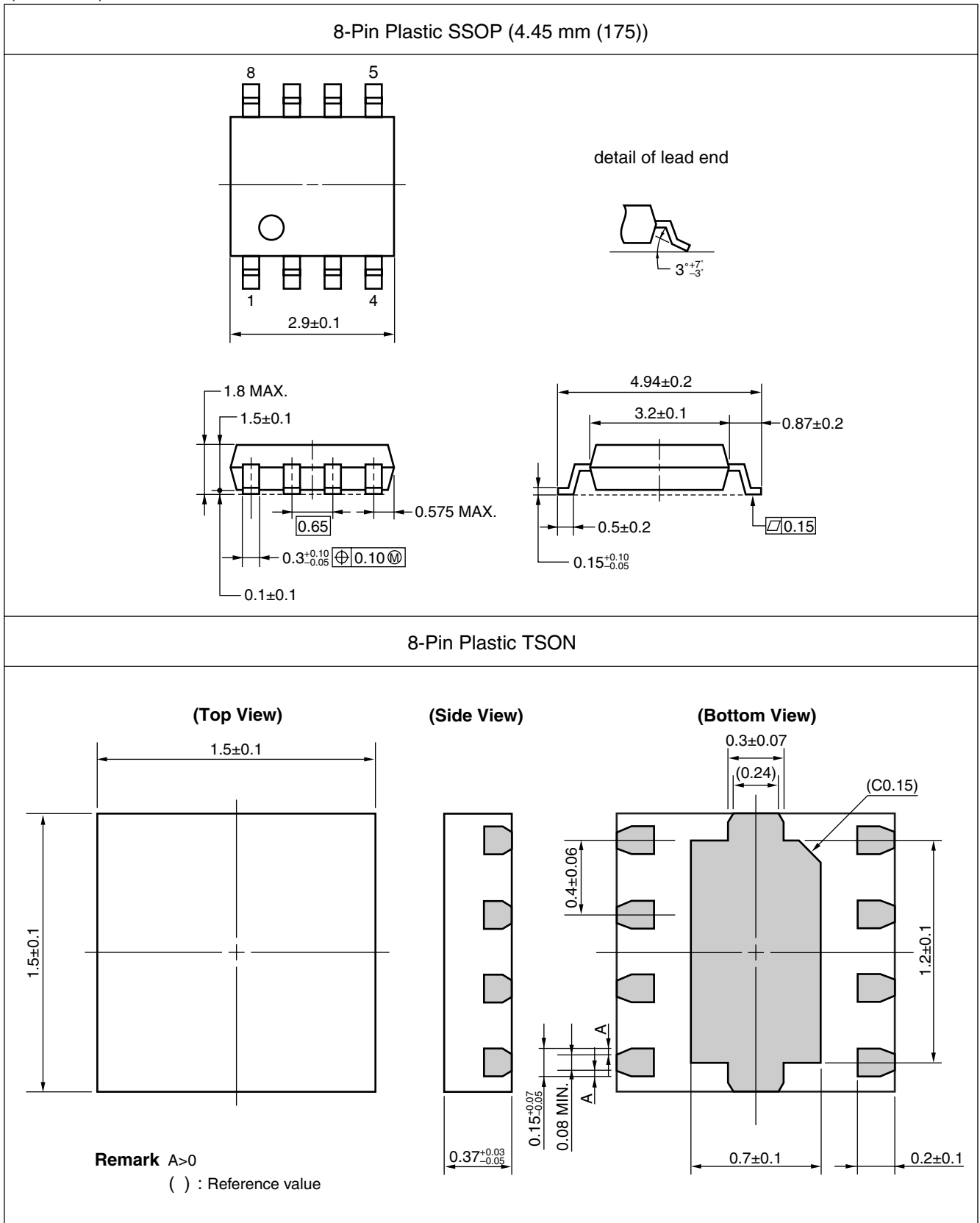

Package Dimensions (16/47)

(Unit : mm)

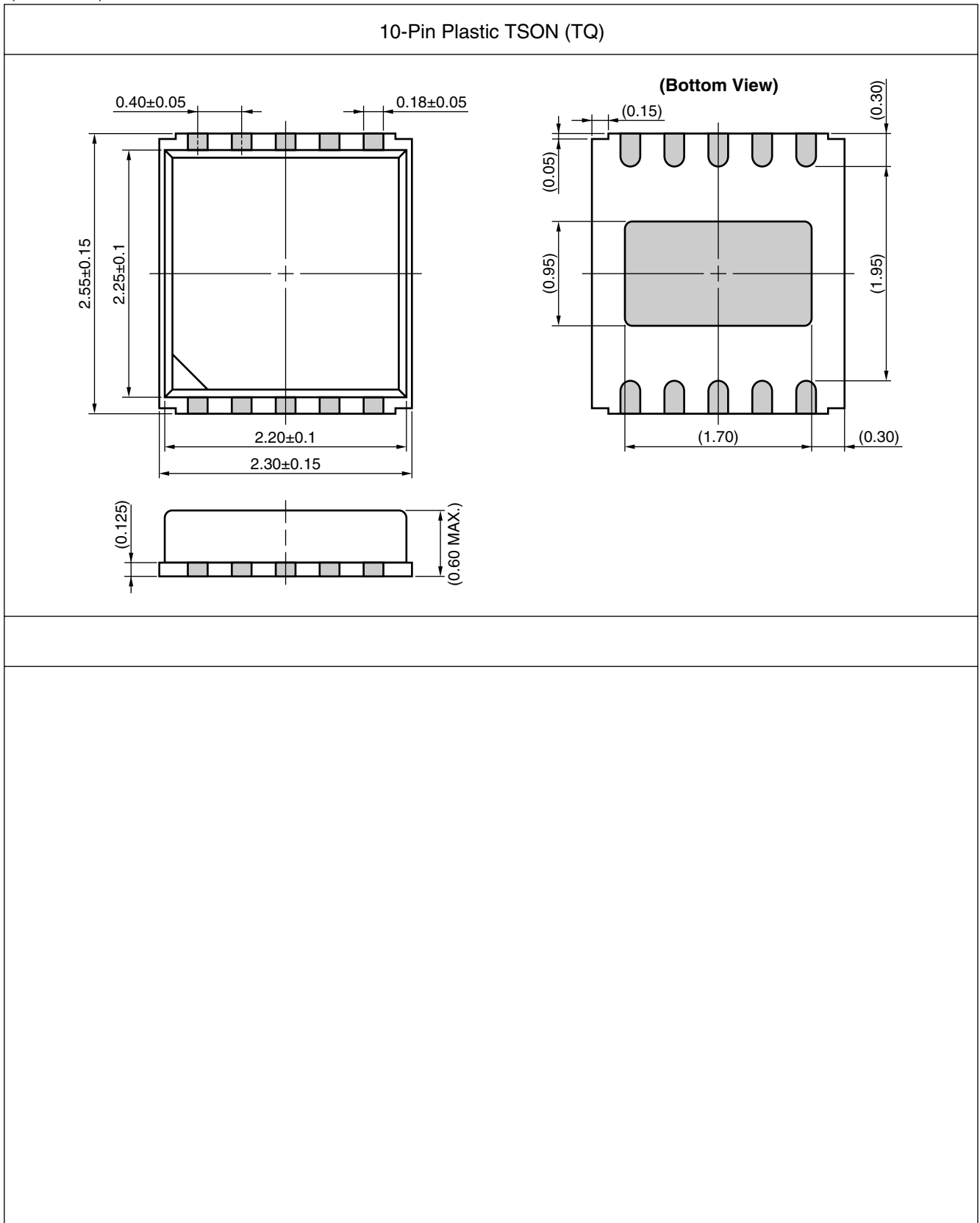

Package Dimensions (17/47)

(Unit : mm)

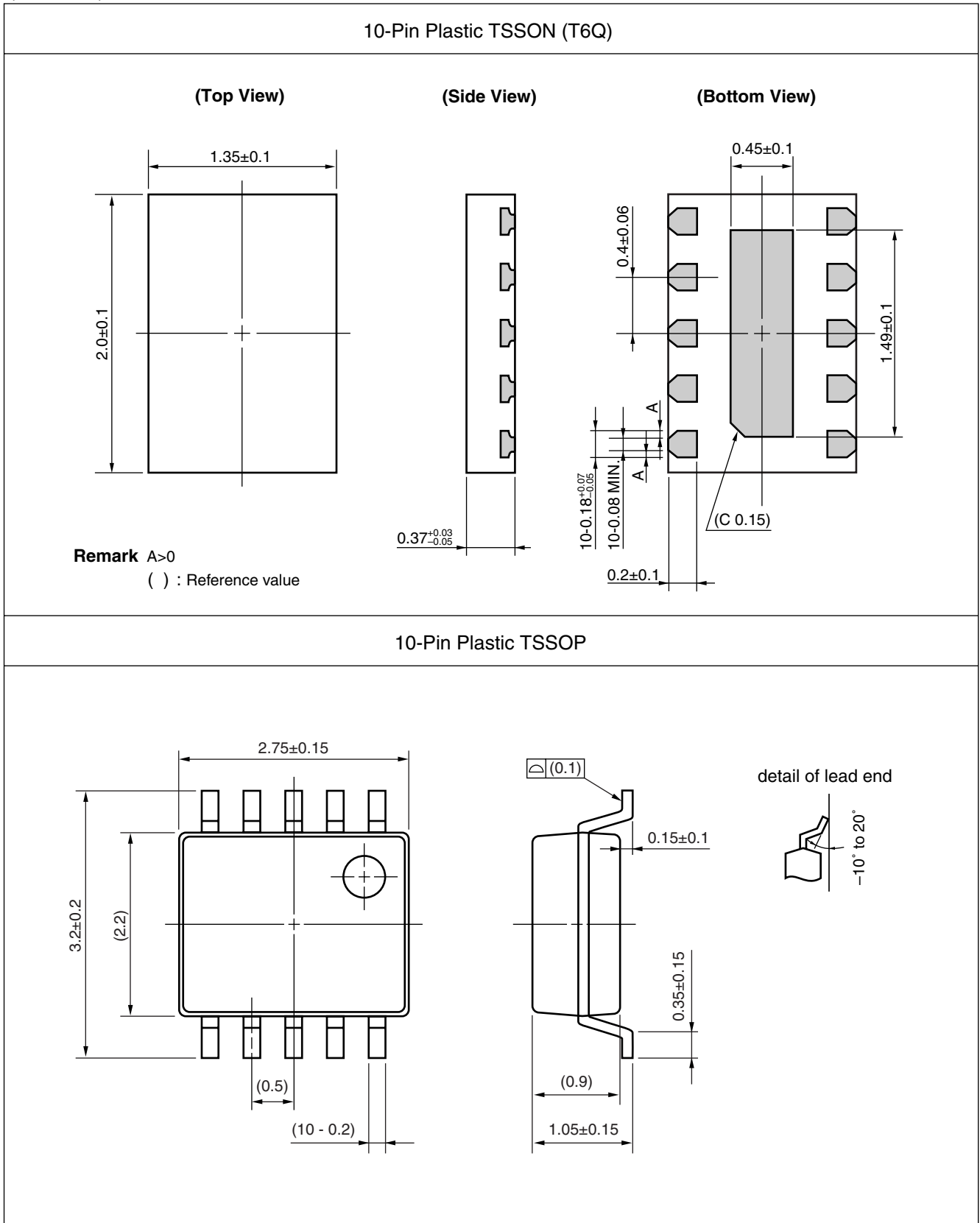



Package Dimensions (18/47)

(Unit : mm)

12-Pin Plastic QFN (T5F)

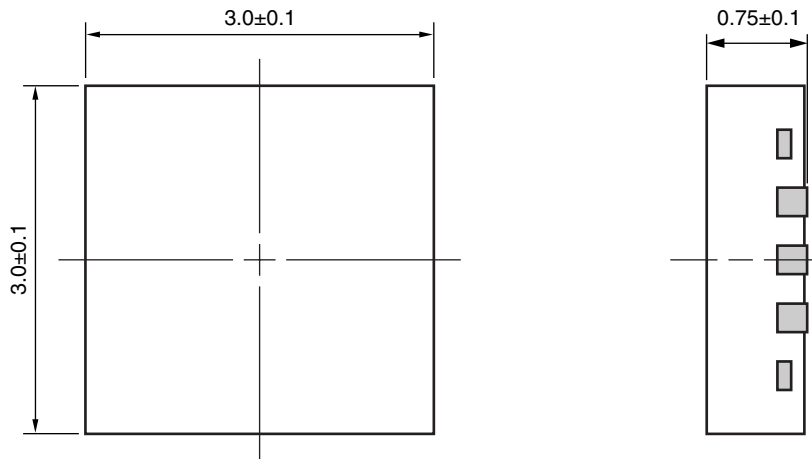

(Bottom View)

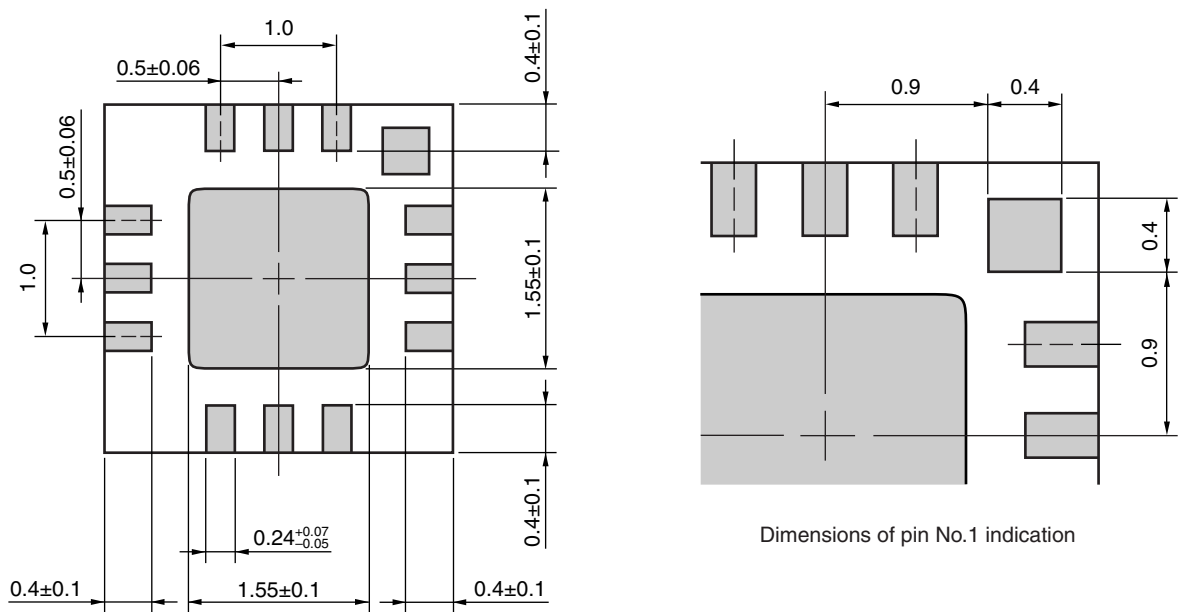

Dimensions of pin No.1 indication

Package Dimensions (19/47)

(Unit : mm)

<R>

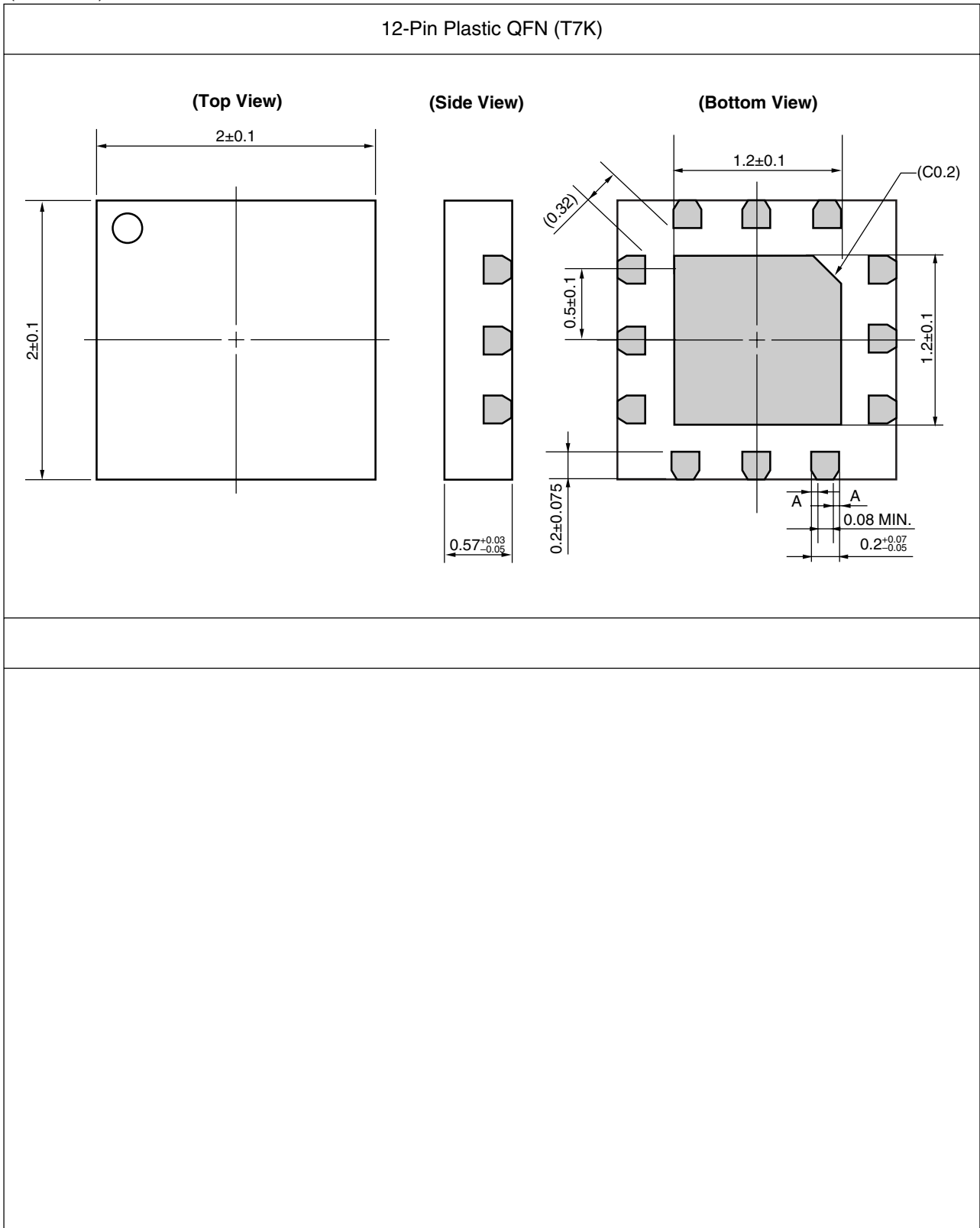

Package Dimensions (20/47)

(Unit : mm)

12-Pin Plastic TQFN

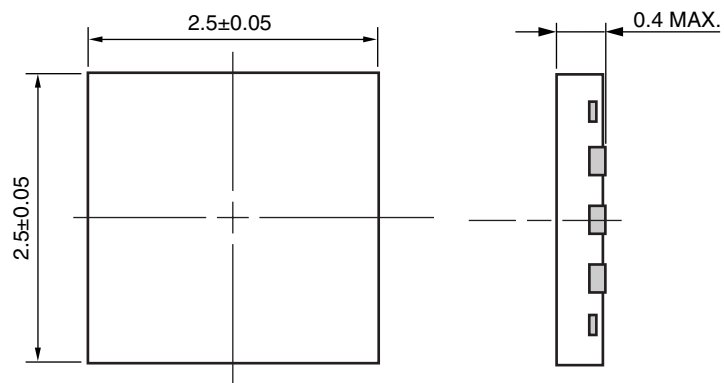

(Bottom View)

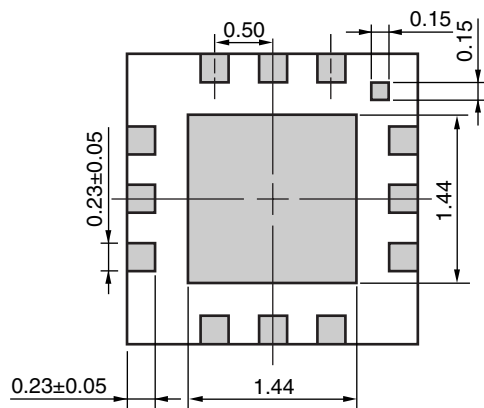

Package Dimensions (21/47)

(Unit : mm)

12-Pin Plastic TSQFN (T5L)

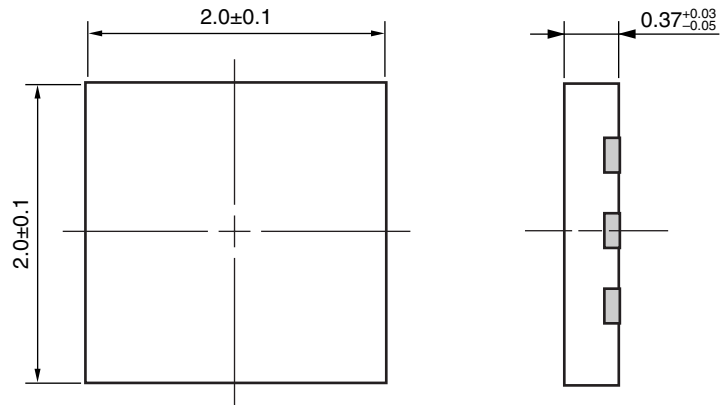

(Bottom View)

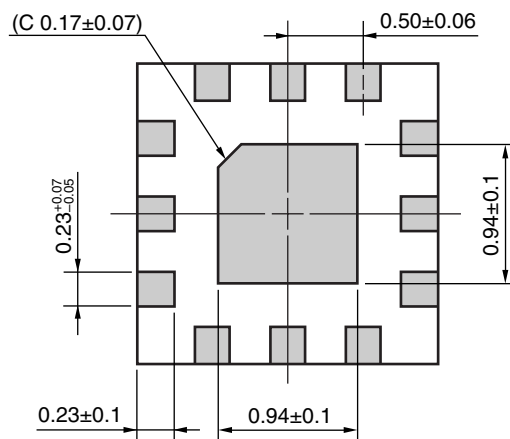

Package Dimensions (22/47)

(Unit : mm)

12-Pin Plastic TSQFN (T6M)

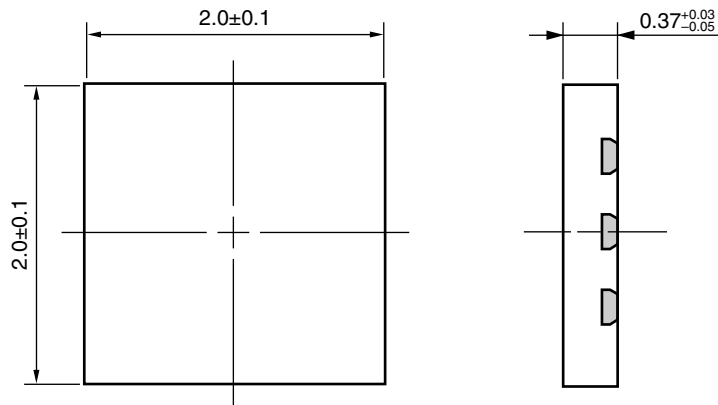

(Bottom View)

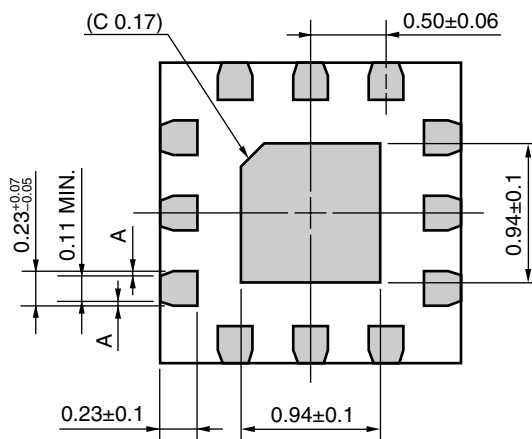

**Remark** A>0  
( ) : Reference value

Package Dimensions (23/47)

(Unit : mm)

14-Pin LGA (CSP Type)

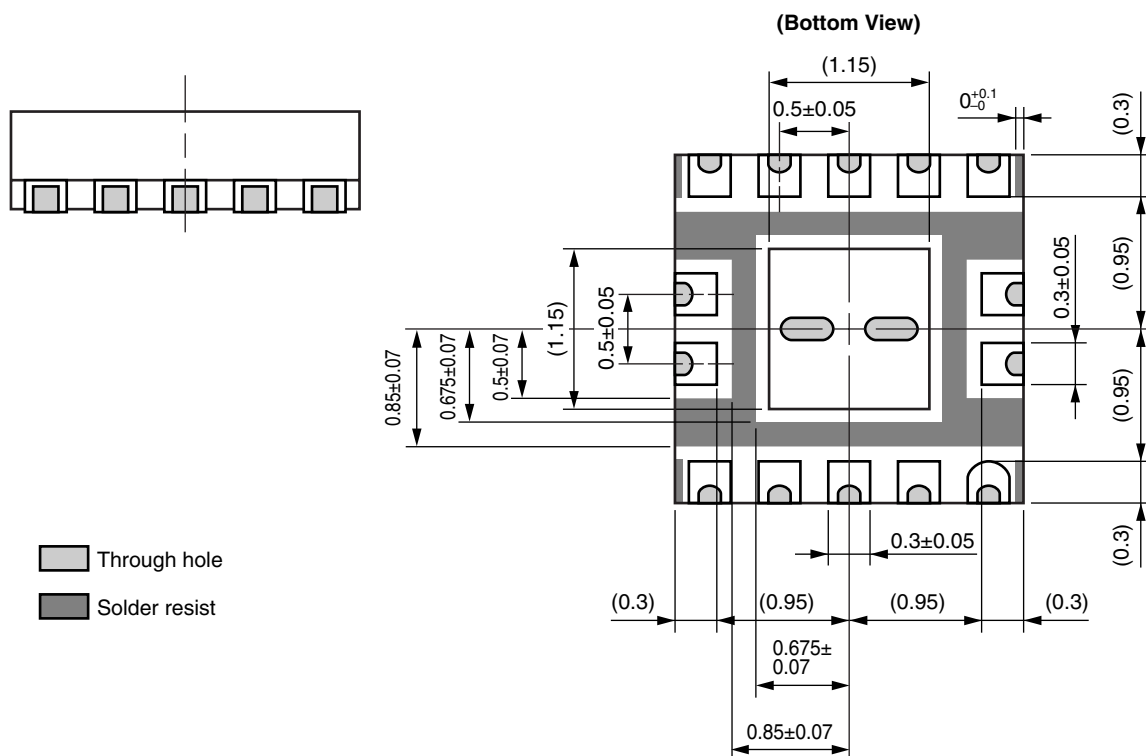
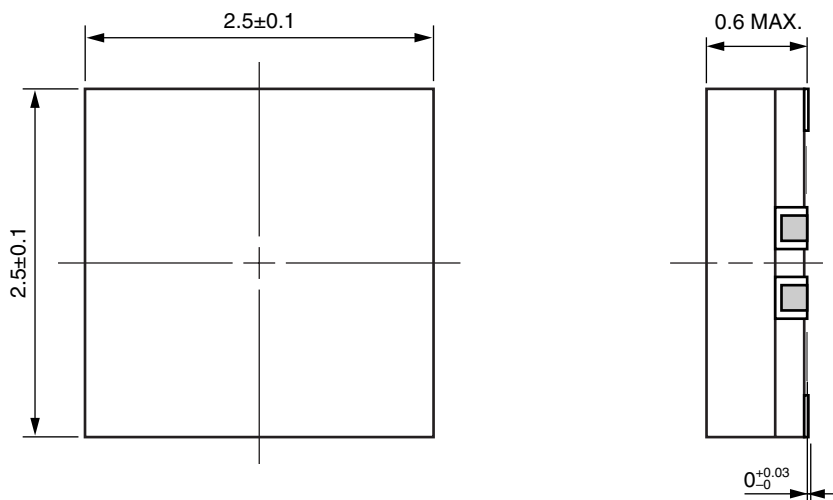

Package Dimensions (24/47)

(Unit : mm)

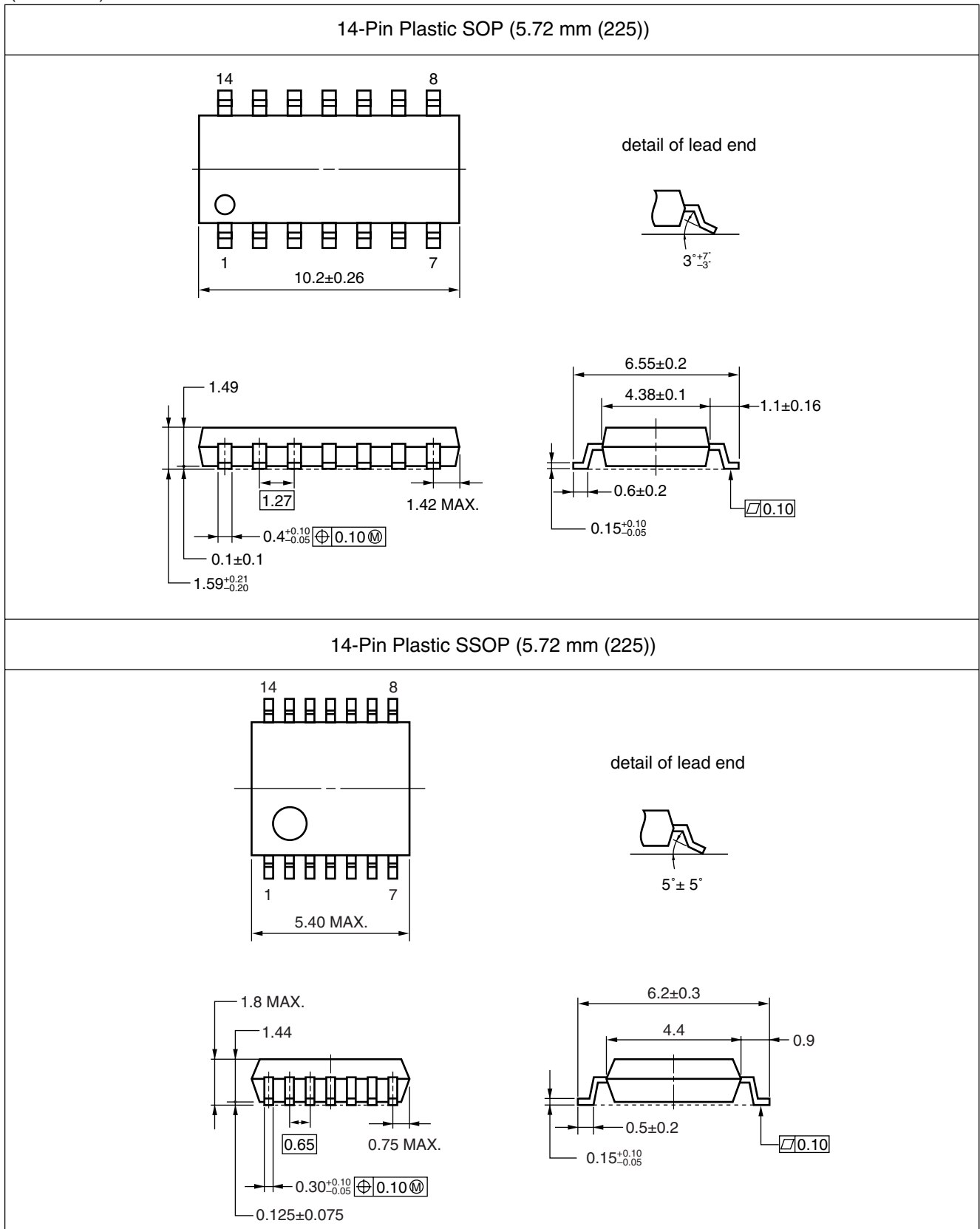

Package Dimensions (25/47)

(Unit : mm)

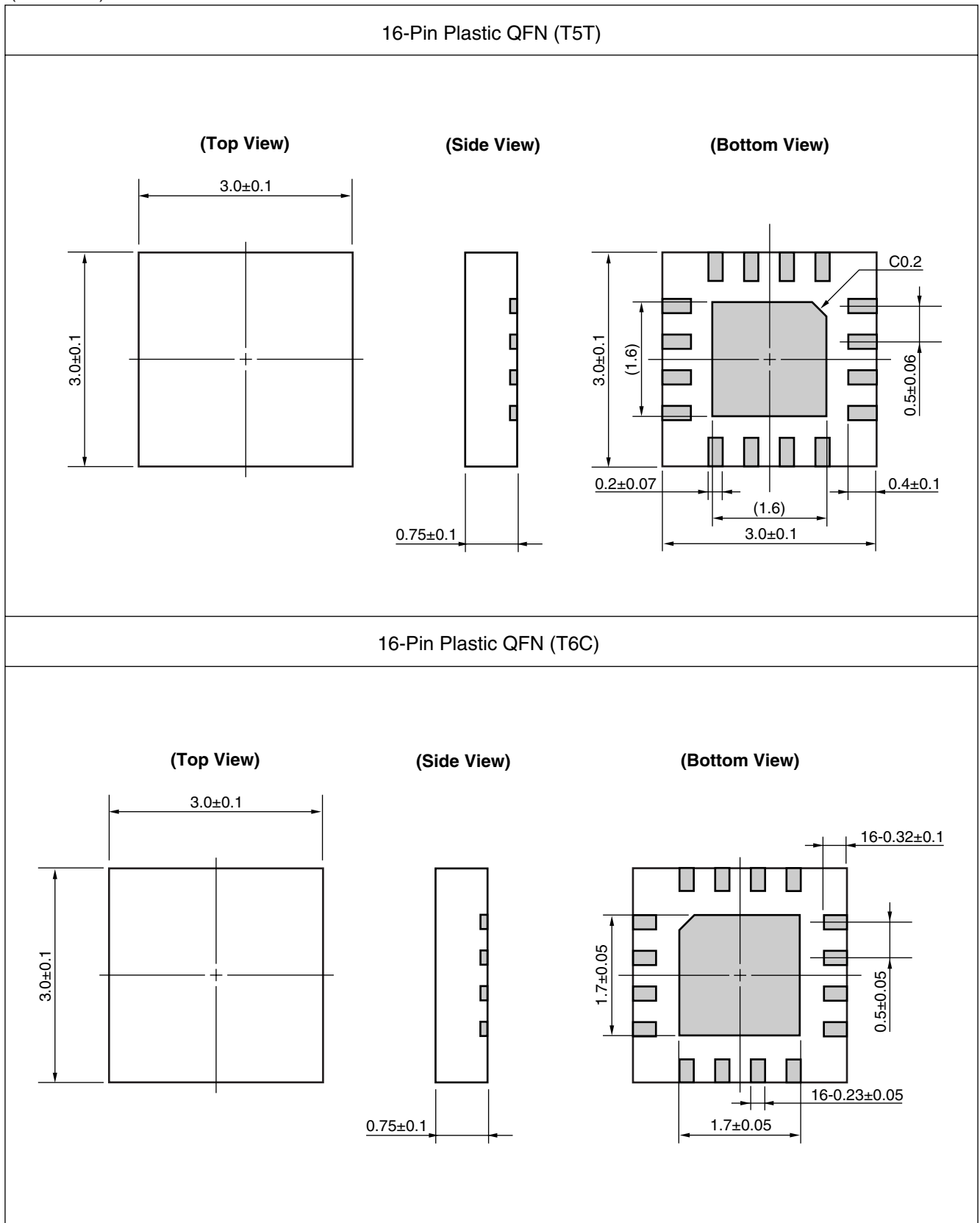



Package Dimensions (26/47)

(Unit : mm)

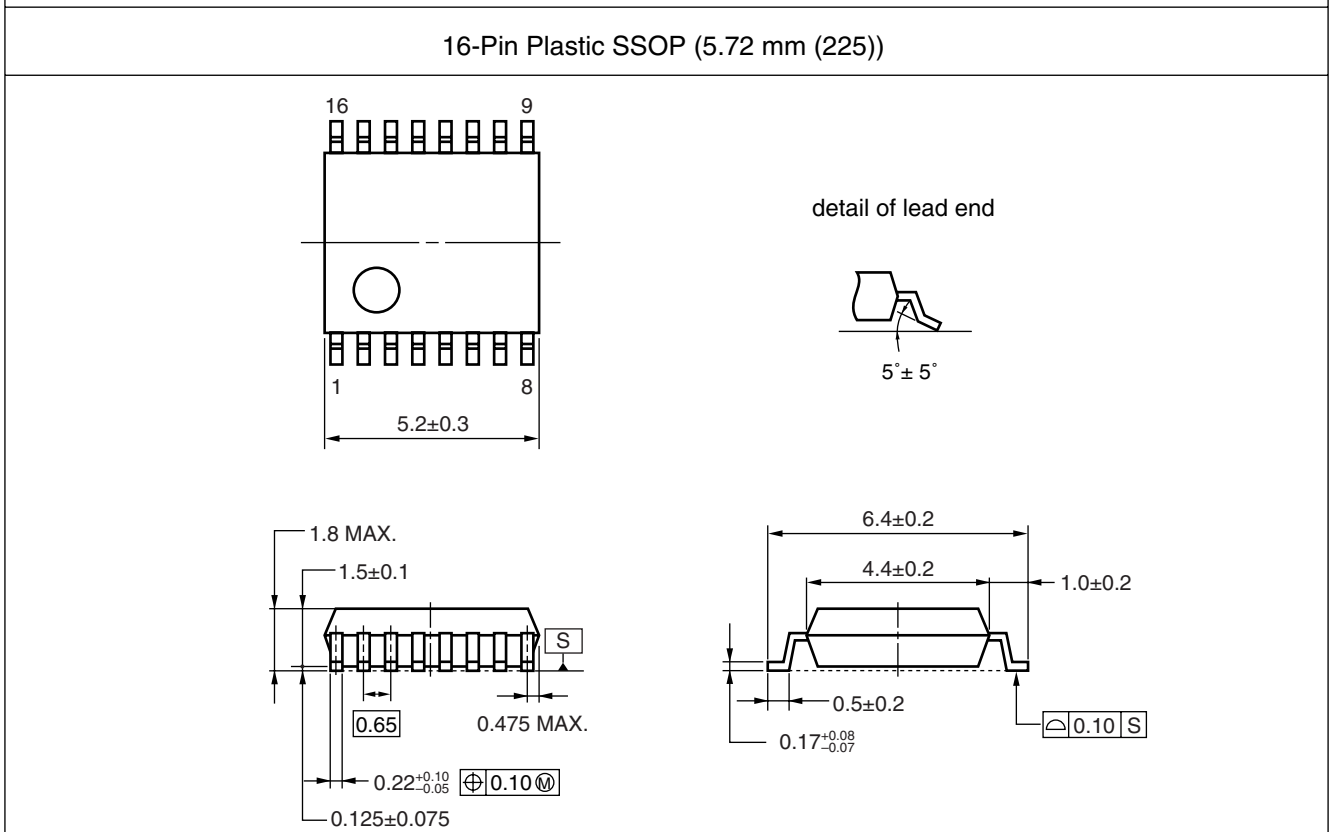
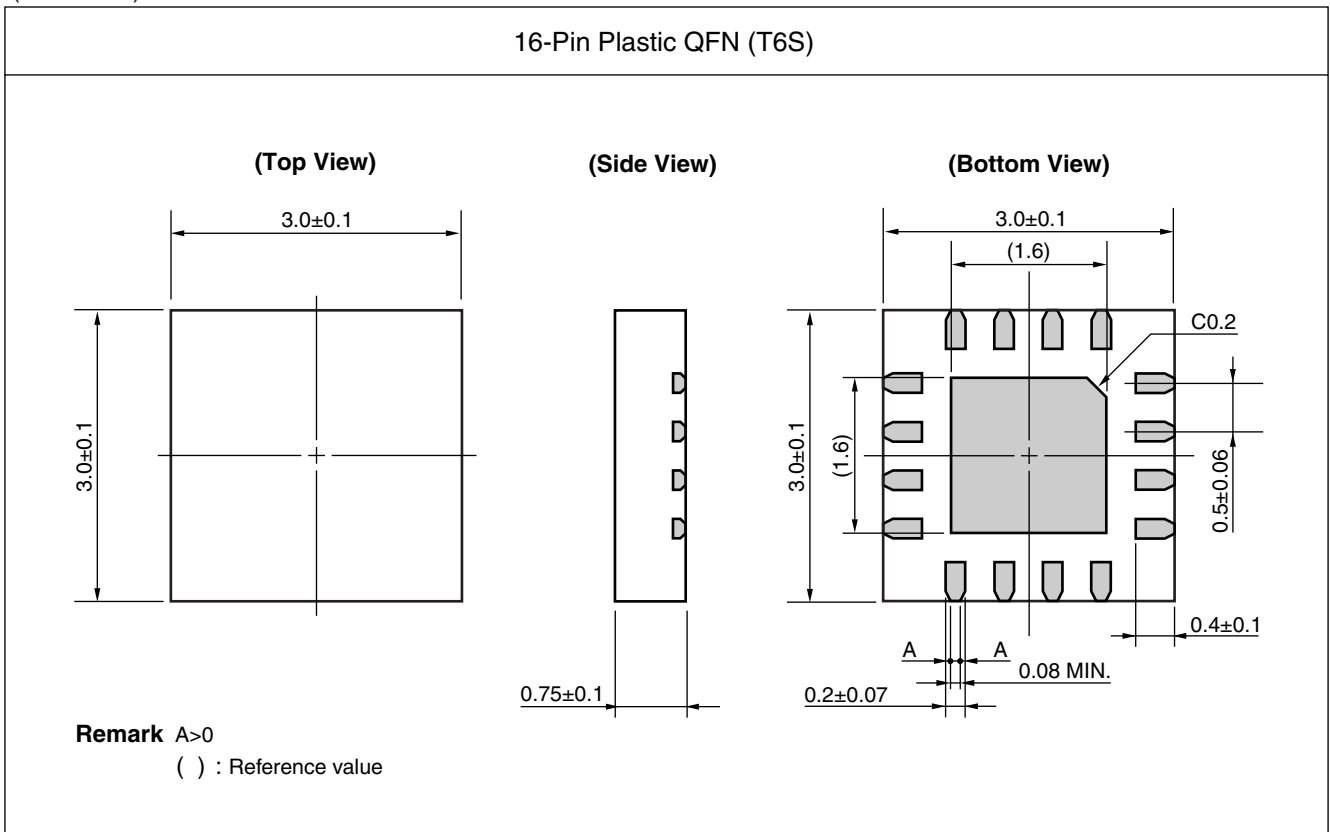

Package Dimensions (27/47)

(Unit : mm)

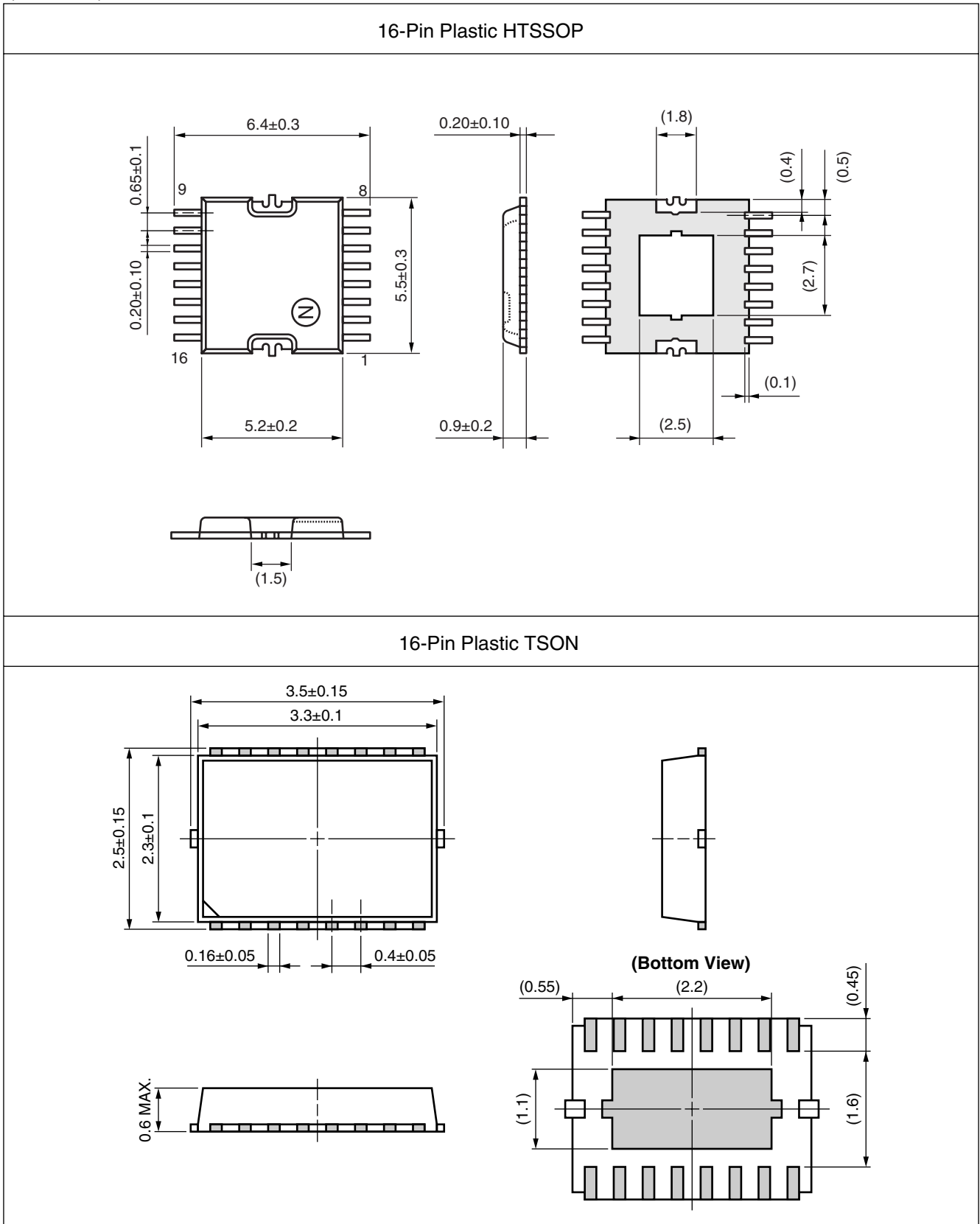

Package Dimensions (28/47)

(Unit : mm)

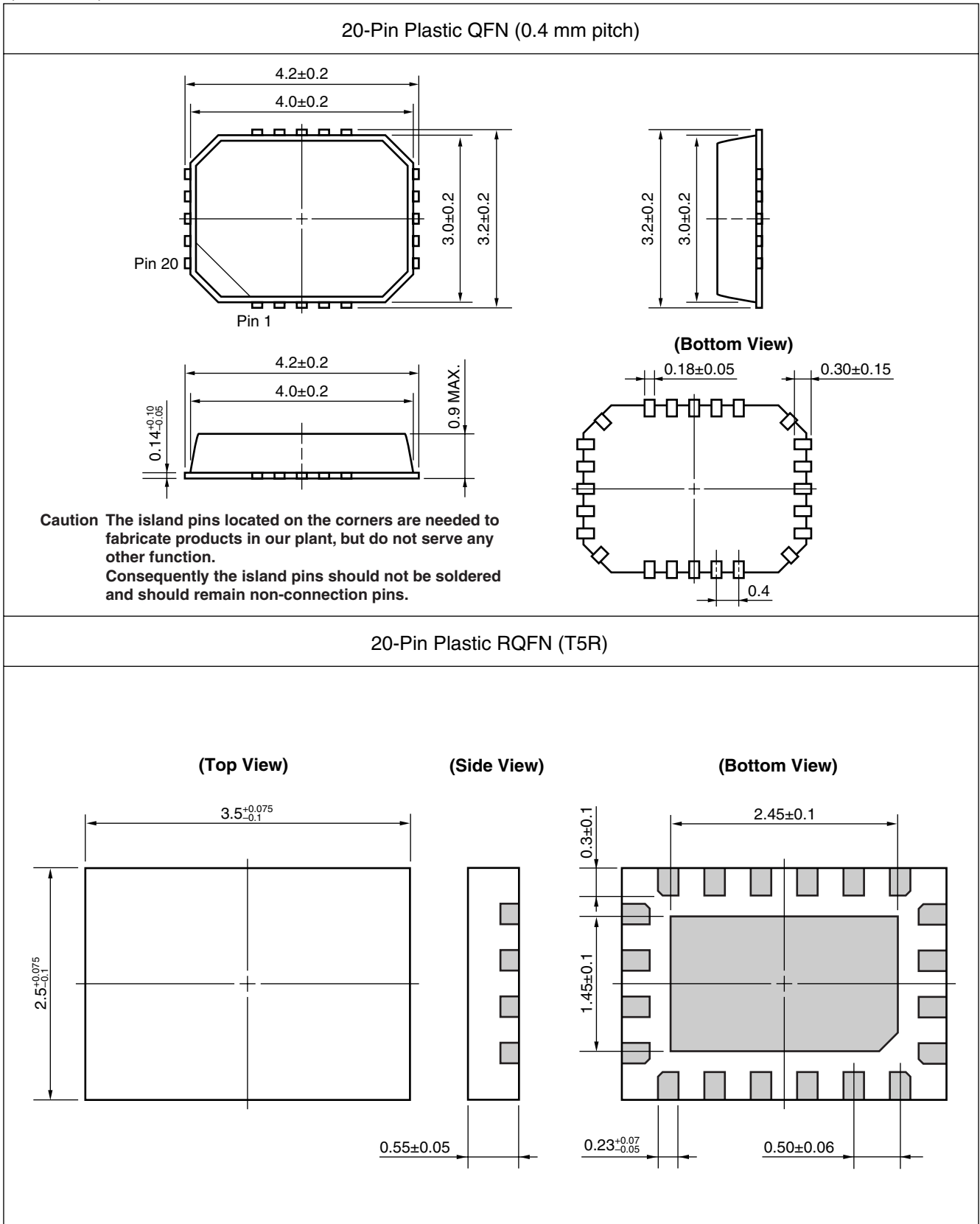

Package Dimensions (29/47)

(Unit : mm)

20-Pin Plastic QFN (0.5 mm pitch) (K)

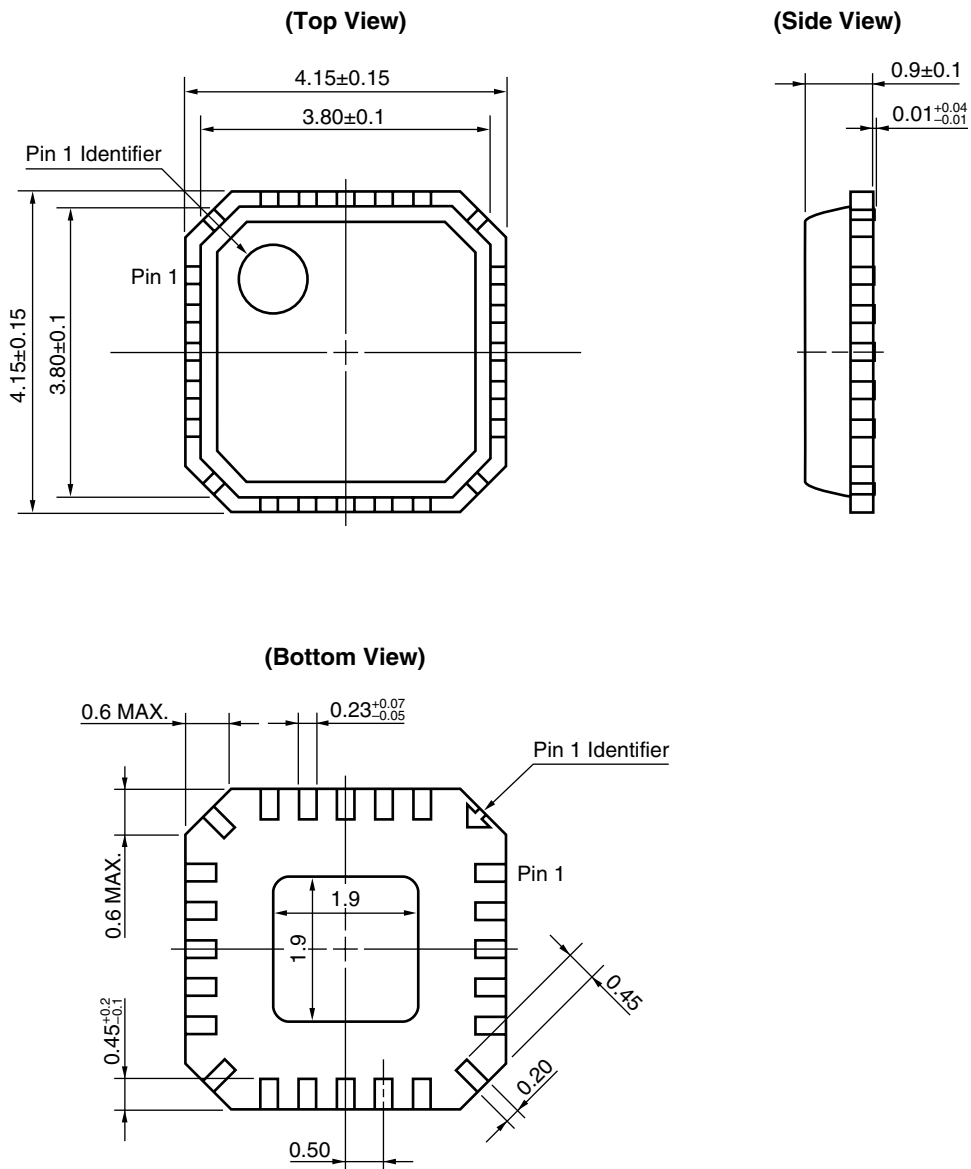

Package Dimensions (30/47)

(Unit : mm)

20-Pin Plastic QFN (0.5 mm pitch) (T7G)

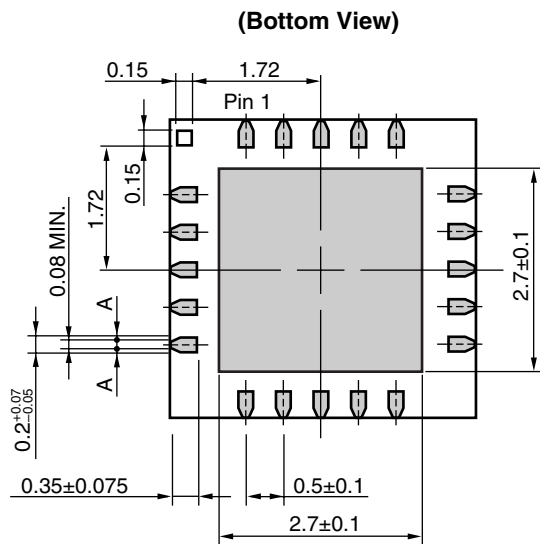
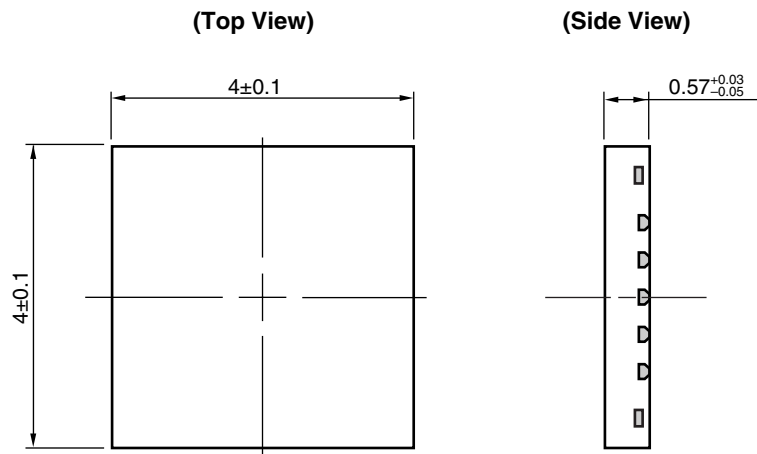

Remark A>0

Package Dimensions (31/47)

(Unit : mm)

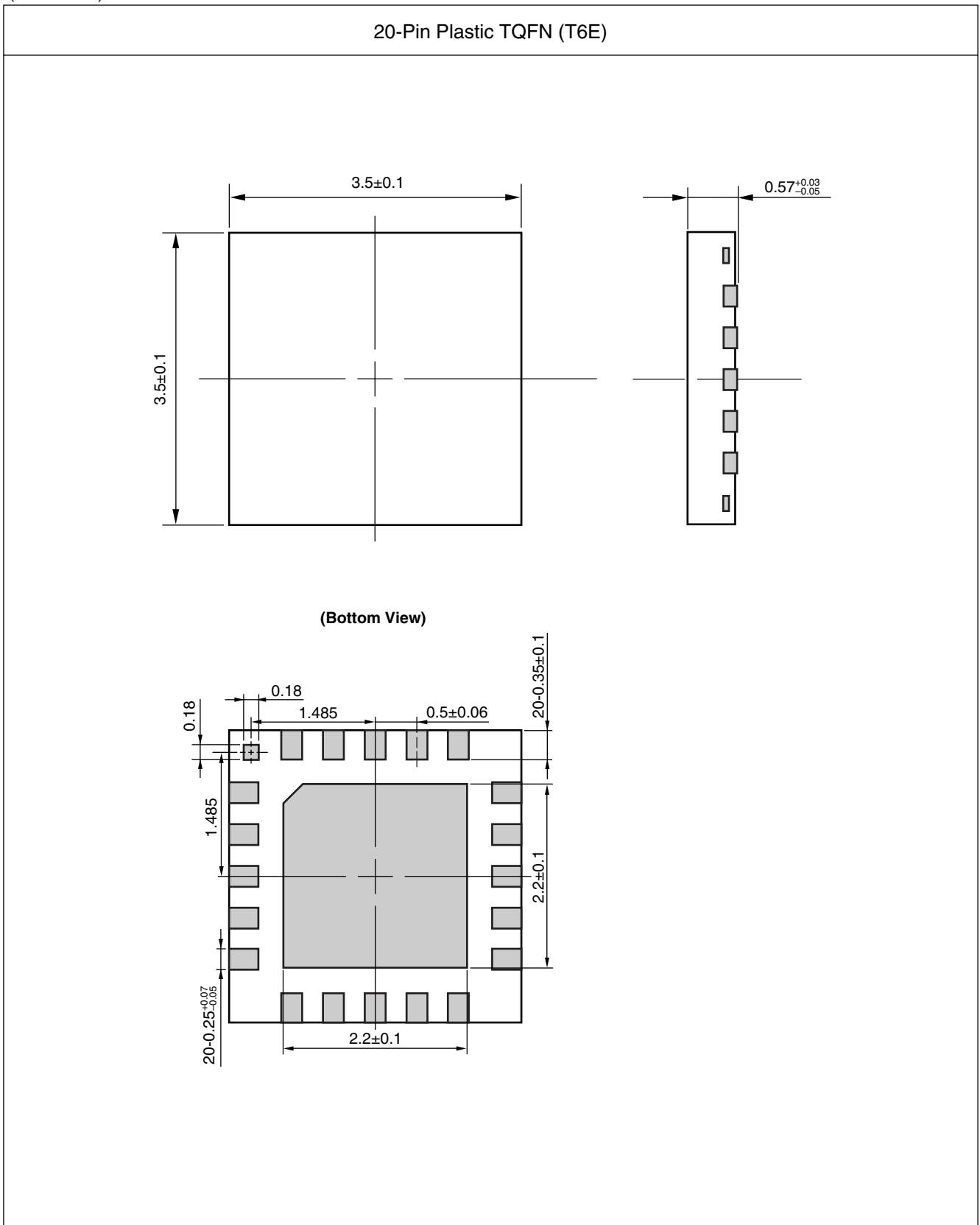

Package Dimensions (32/47)

(Unit : mm)

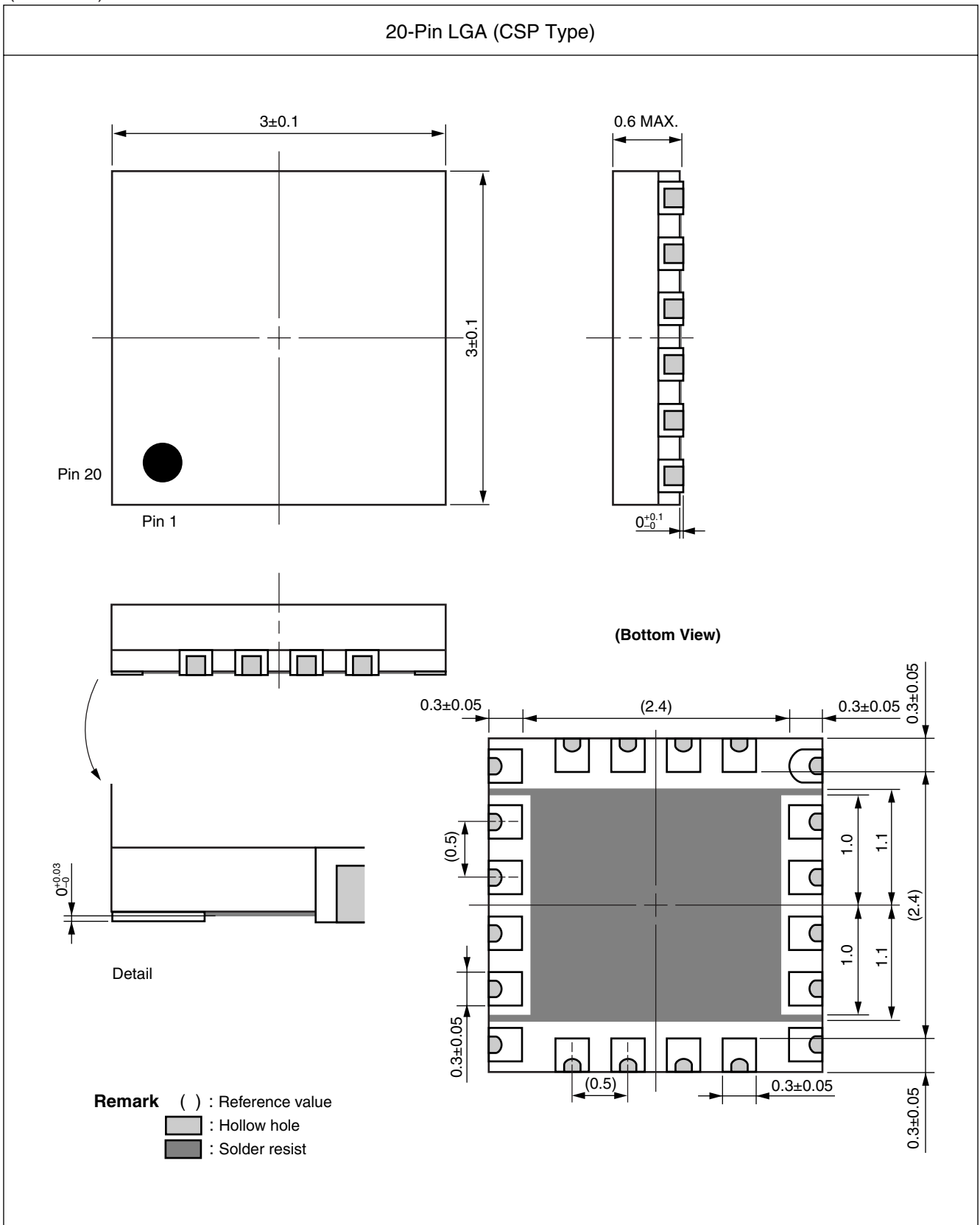

Package Dimensions (33/47)

(Unit : mm)

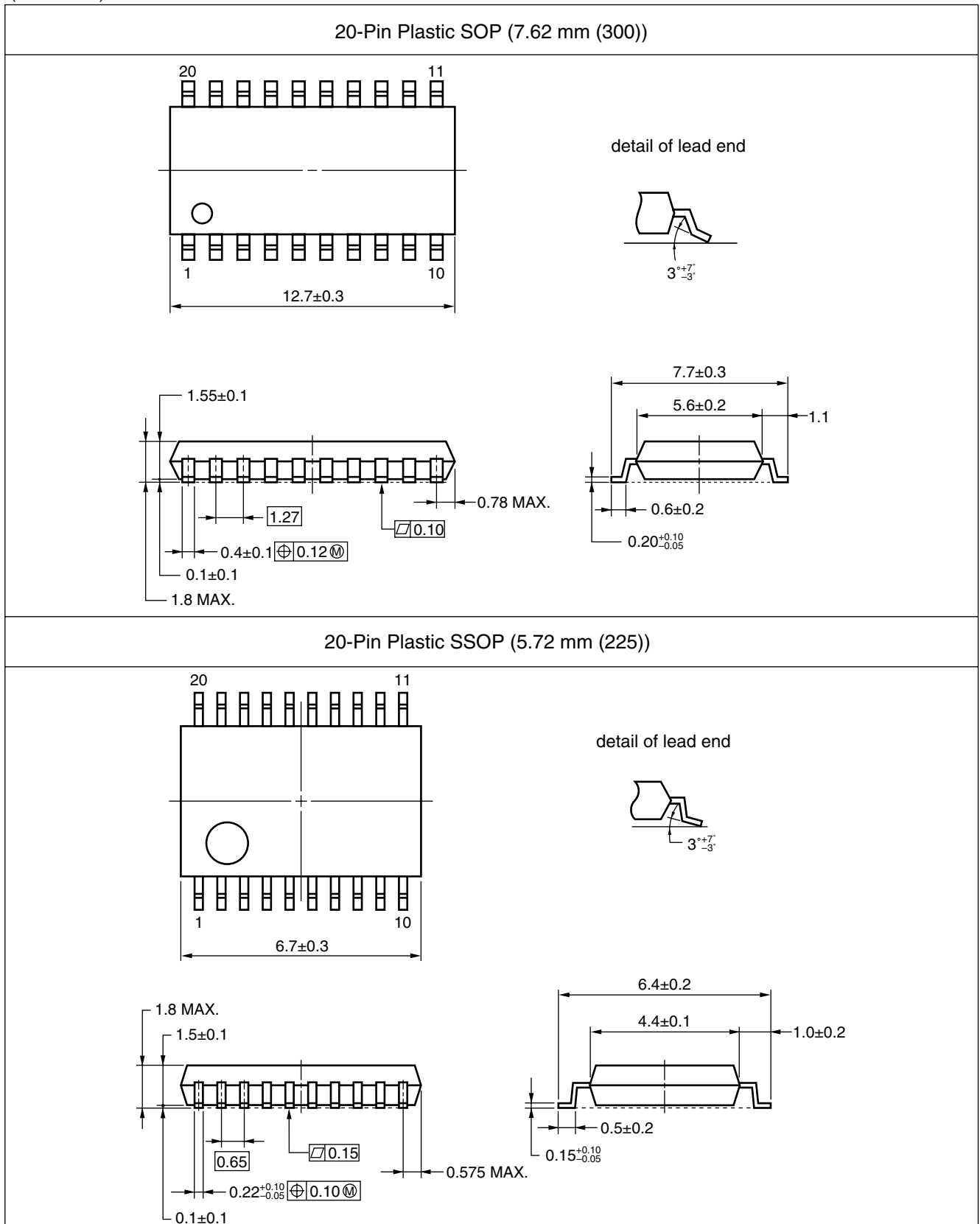



Package Dimensions (34/47)

(Unit : mm)

24-Pin Plastic QFN

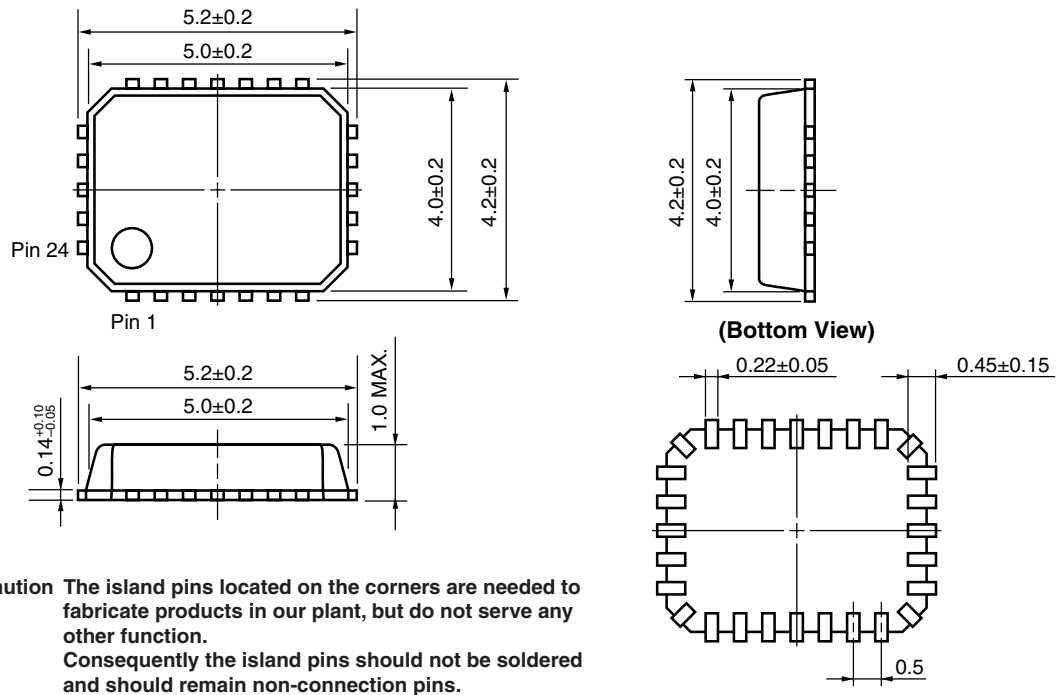

Package Dimensions (35/47)

(Unit : mm)

<R>

24-Pin Plastic QFN (T7L)

(Top View)

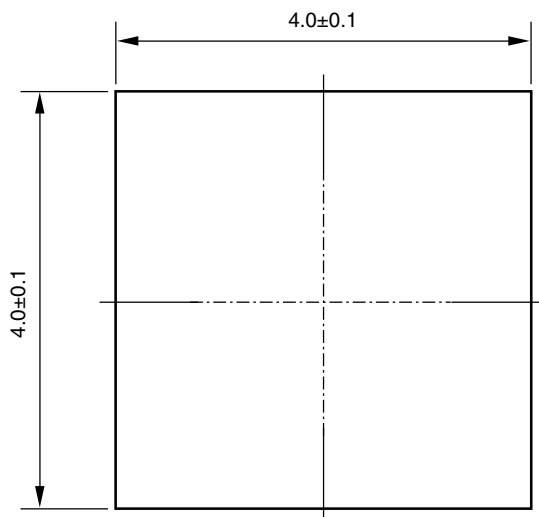

(Side View)

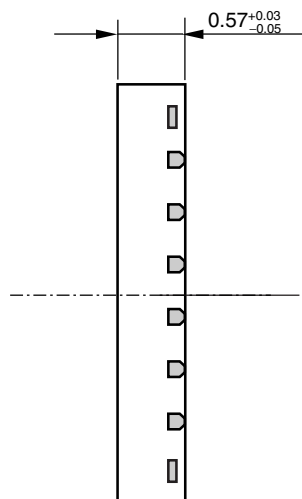

(Bottom View)

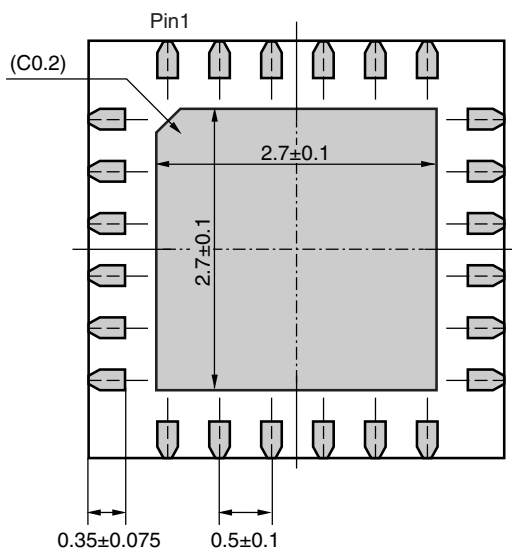

(Dimensions of Each Pin Part)

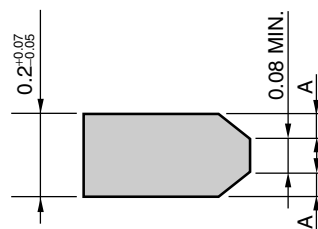

Remark A > 0

Package Dimensions (36/47)

(Unit : mm)

28-Pin Plastic QFN (K)

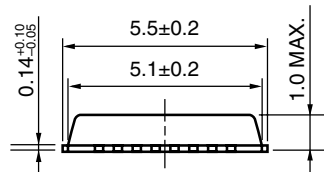
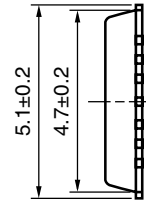
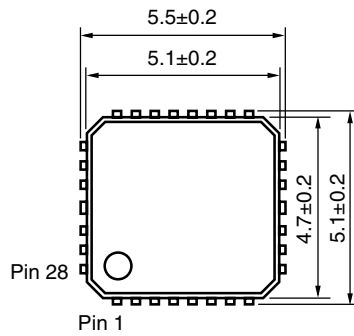

(Bottom View)

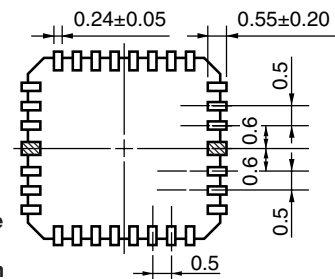

**Caution** The extra-wide pins (shaded portion) located between pins 11 and 12 and pins 25 and 26 in this package are needed to fabricate products in our plant, but do not serve any other function. Consequently the pins should not be soldered and should remain non-connection pins.

Package Dimensions (37/47)

(Unit : mm)

28-Pin Plastic QFN (T7A)

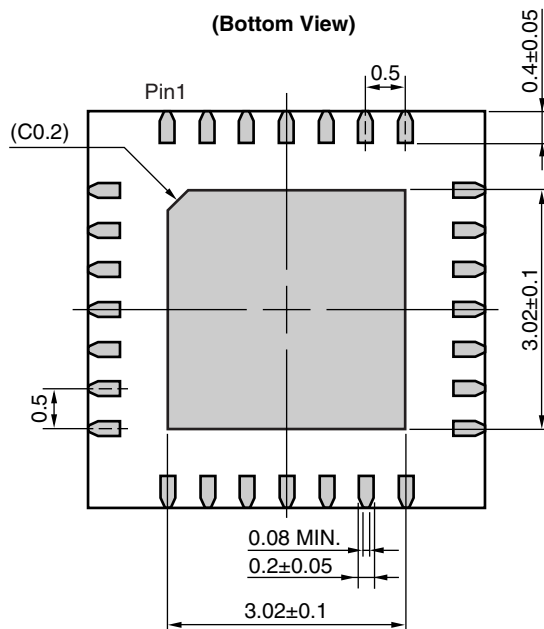
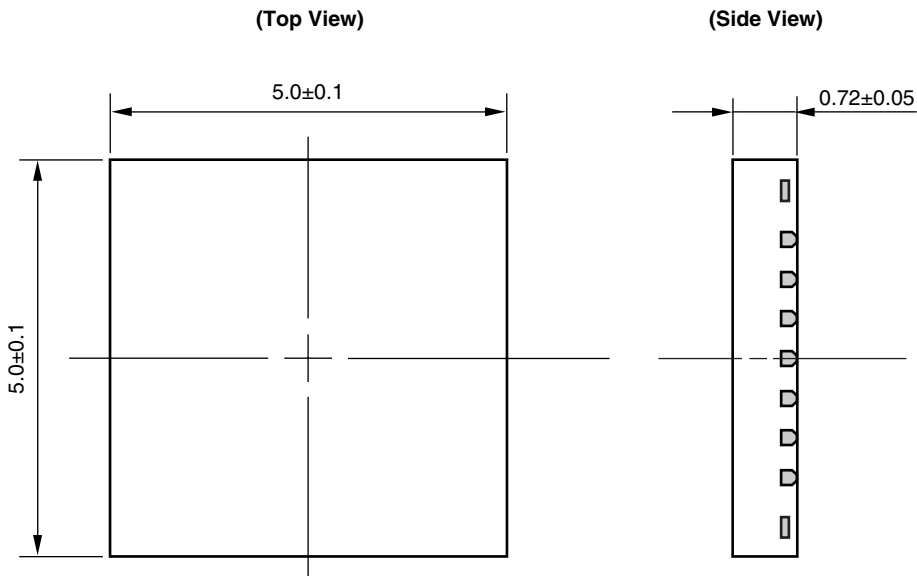

(Dimensions of Each Pin Part)

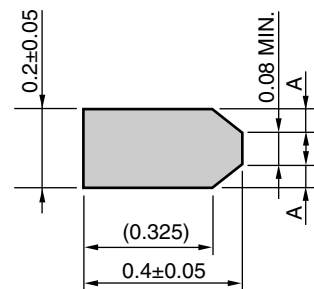

Remark A>0  
( ) : Reference value

Package Dimensions (38/47)

(Unit : mm)

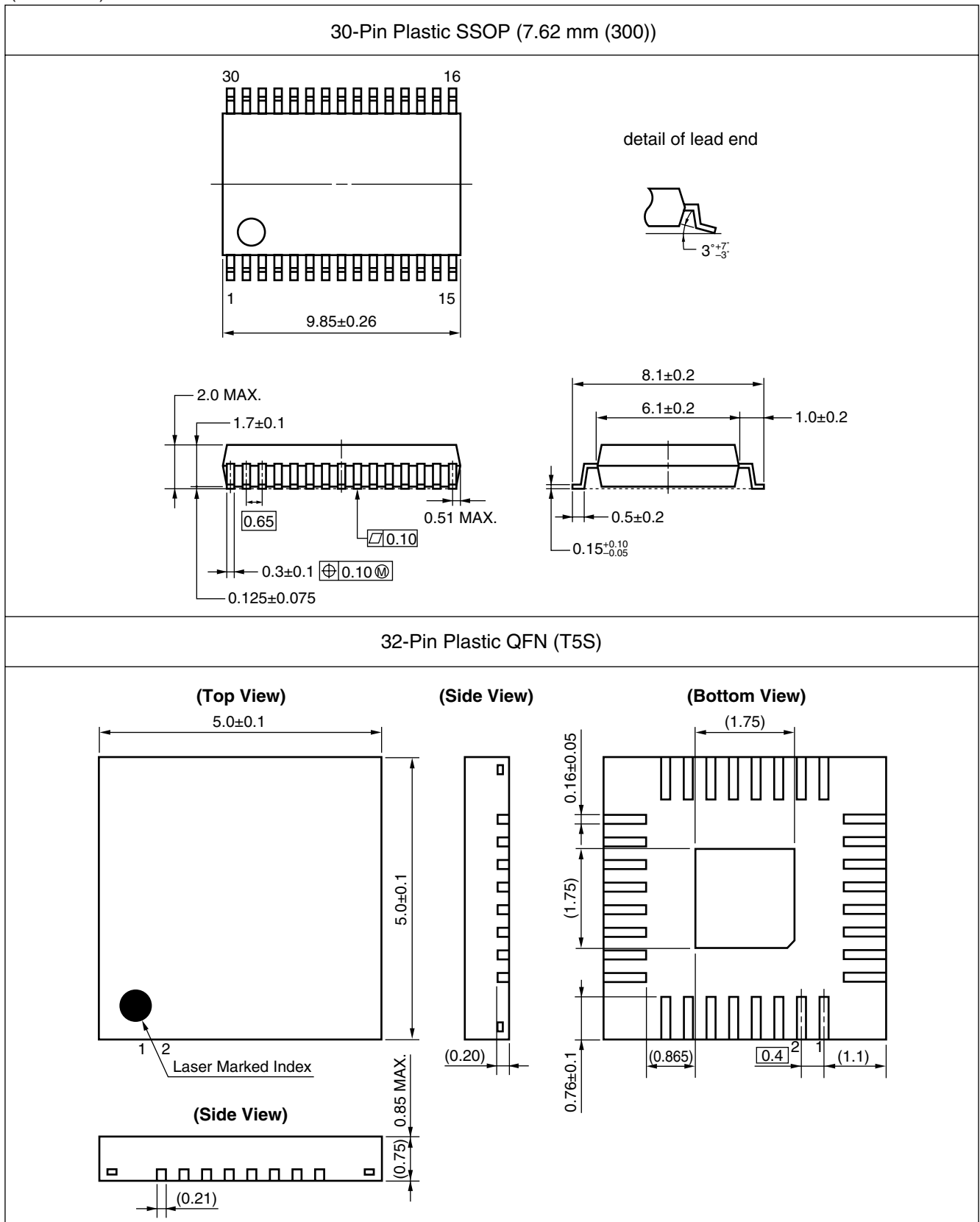

Package Dimensions (39/47)

(Unit : mm)

36-Pin Plastic QFN

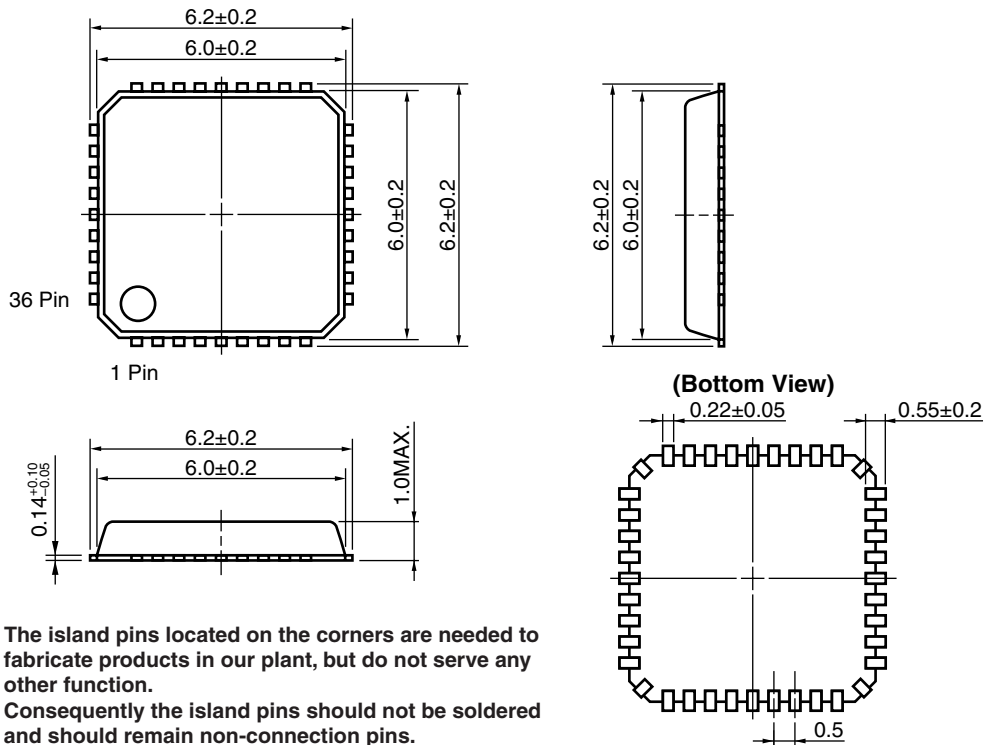

44-Pin Plastic QFN

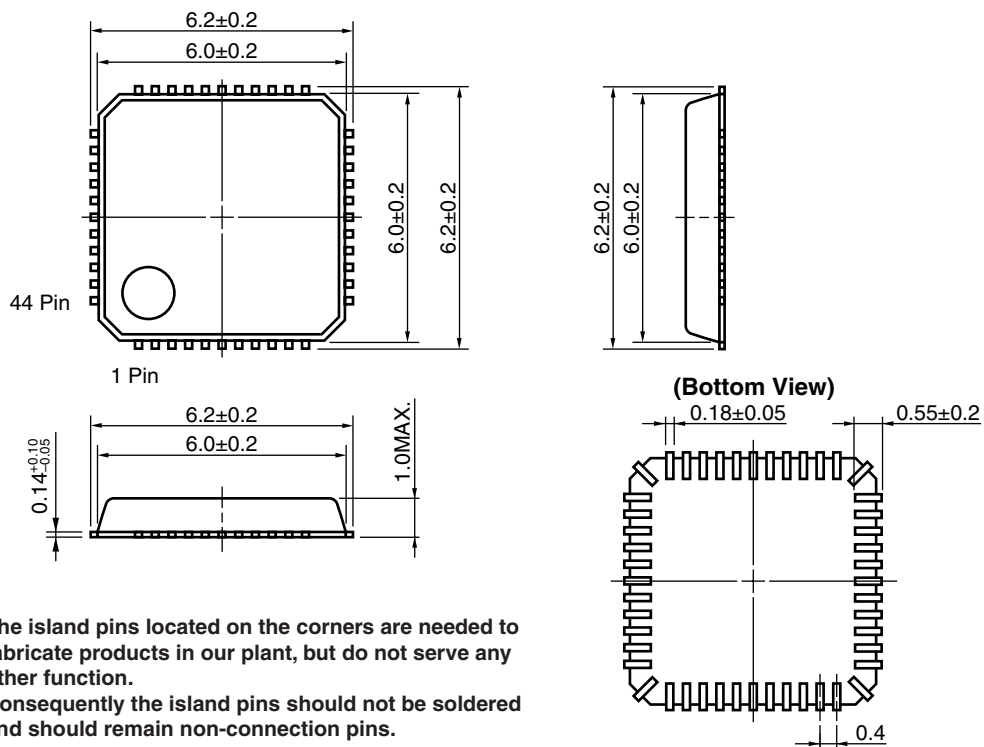

Package Dimensions (40/47)

(Unit : mm)

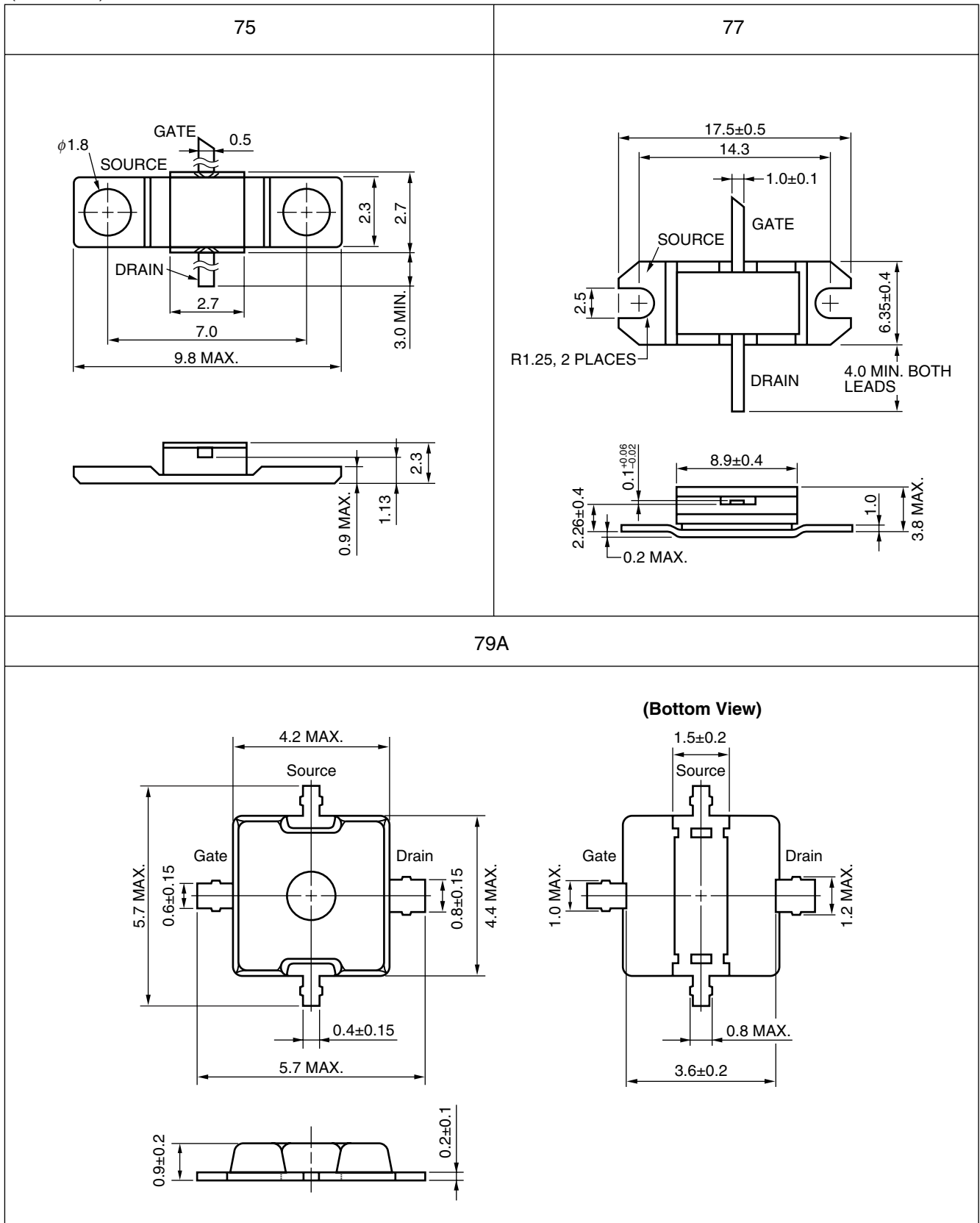

Package Dimensions (41/47)

(Unit : mm)

83A, 83B	84, 84A, 84C
<p>Technical drawing of package 83A, 83B. The top view shows a central circular pad with four leads extending outwards. Dimensions include a lead width of <math>1.88 \pm 0.3</math> mm, a lead length of <math>4.0</math> mm (minimum), and a central pad diameter of <math>1.0 \pm 0.1</math> mm. The side view shows a lead height of <math>0.5 \pm 0.1</math> mm and a total package height of <math>1.45</math> mm (maximum). A small dimension of <math>0.1^{+0.07}_{-0.03}</math> mm is also indicated.</p>	<p>Technical drawing of package 84, 84A, 84C. The top view shows a central circular pad with four leads. Dimensions include a lead width of <math>1.78 \pm 0.2</math> mm and a typical lead length of <math>0.5</math> mm (TYP.). The side view shows a lead height of <math>0.1</math> mm and a total package height of <math>1.7</math> mm (maximum). The length of the leads is denoted as <math>L</math>, with specific values: <math>(-SL) 1.7</math> mm (minimum) and <math>(-T1) 1.0 \pm 0.2</math> mm.</p>
95	96/99
<p>Technical drawing of package 95. The top view shows a rectangular package with a central GATE region and two circular SOURCE regions. Dimensions include a SOURCE diameter of <math>2.5 \pm 0.3</math> mm, a GATE width of <math>0.7 \pm 0.1</math> mm, and a GATE length of <math>4.0</math> mm (minimum). The overall width is <math>5.9 \pm 0.2</math> mm, and the length is <math>14.0 \pm 0.3</math> mm (with a maximum of <math>18.5</math> mm). The side view shows a lead height of <math>2.1 \pm 0.15</math> mm, a lead thickness of <math>0.1</math> mm, a lead width of <math>0.2</math> mm (maximum), a lead length of <math>7.2 \pm 0.2</math> mm, and a total package height of <math>4.5</math> mm (maximum).</p>	<p>Technical drawing of package 96/99. The top view shows a rectangular package with a central GATE region and two circular SOURCE regions. Dimensions include a GATE width of <math>1.0 \pm 0.1</math> mm, a SOURCE diameter of <math>2.2 \pm 0.3</math> mm (in two places), and a GATE length of <math>4.0</math> mm (minimum for both leads). The overall width is <math>4.3 \pm 0.2</math> mm, and the length is <math>15.0 \pm 0.3</math> mm. The side view shows a lead height of <math>0.2</math> mm (maximum), a lead thickness of <math>0.1</math> mm, a lead width of <math>1.7 \pm 0.15</math> mm, a lead length of <math>6.0 \pm 0.2</math> mm, and a total package height of <math>5.0</math> mm (maximum).</p>



Package Dimensions (42/47)

(Unit : mm)

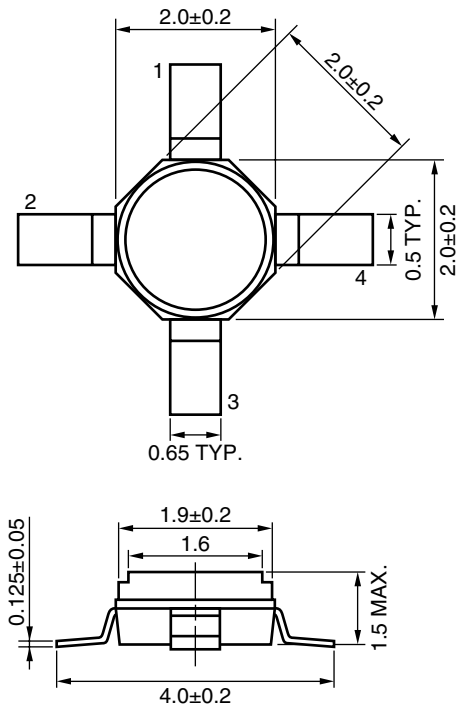
S01	
 <p>Technical drawing of the S01 package showing top and side views with dimensions:</p> <ul style="list-style-type: none"> <li>Top view dimensions: <ul style="list-style-type: none"> <li>Width: <math>2.0 \pm 0.2</math></li> <li>Height: <math>2.0 \pm 0.2</math></li> <li>Pin 1 width: <math>0.5 \text{ TYP.}</math></li> <li>Pin 4 width: <math>0.5 \text{ TYP.}</math></li> <li>Pin 3 width: <math>0.65 \text{ TYP.}</math></li> </ul> </li> <li>Side view dimensions: <ul style="list-style-type: none"> <li>Width: <math>4.0 \pm 0.2</math></li> <li>Height: <math>1.5 \text{ MAX.}</math></li> <li>Pin 1 width: <math>1.9 \pm 0.2</math></li> <li>Pin 4 width: <math>1.6</math></li> <li>Pin 3 width: <math>0.125 \pm 0.05</math></li> </ul> </li> </ul>	

Package Dimensions (43/47)

(Unit : mm)

S02, S03

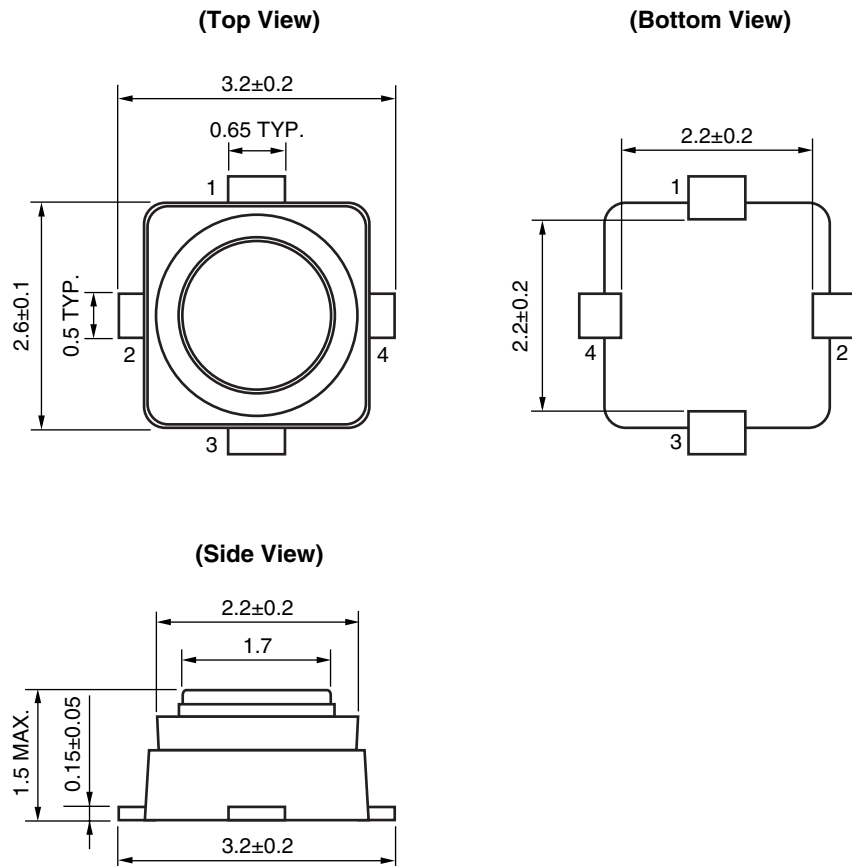

Package Dimensions (44/47)

(Unit : mm)

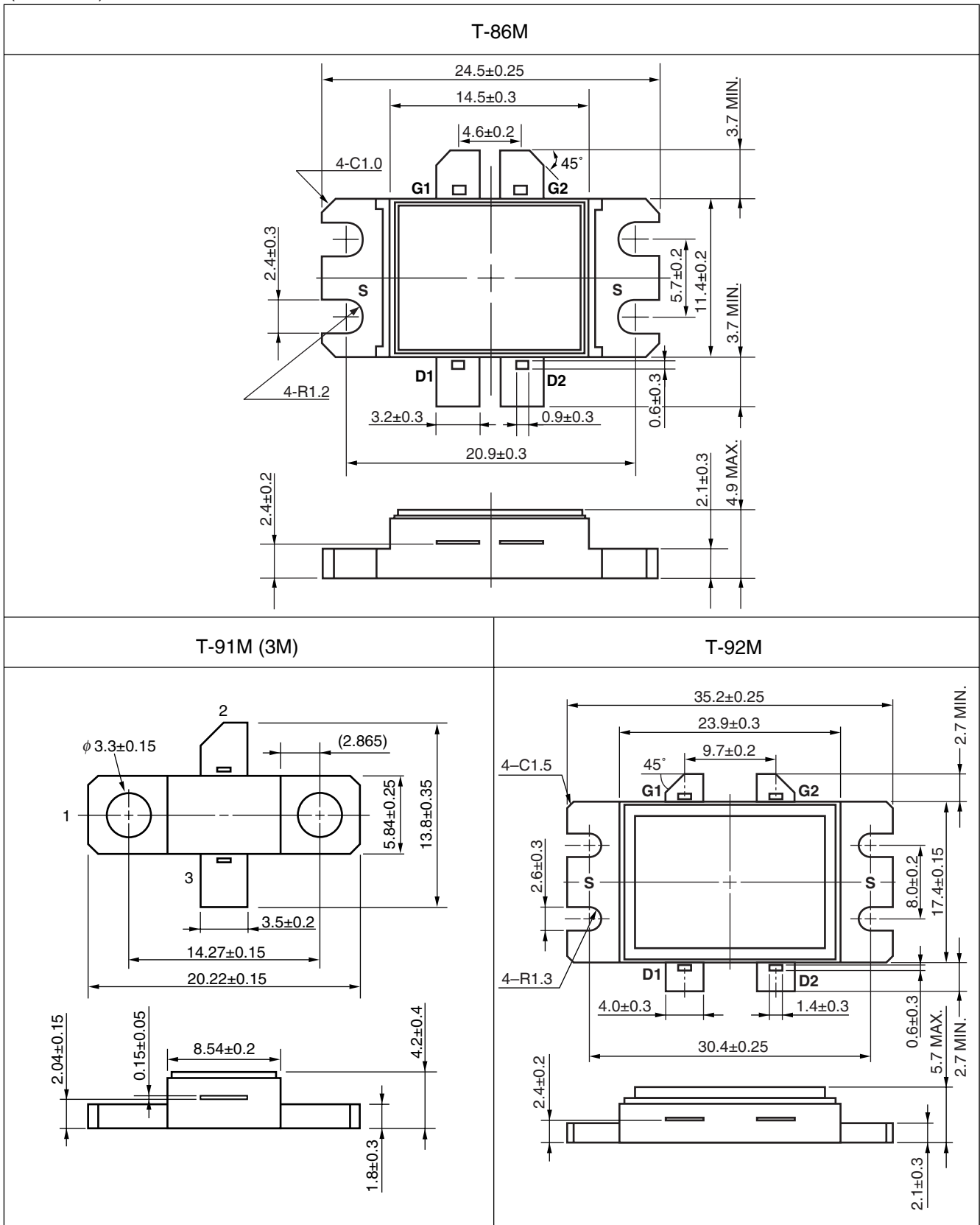

Package Dimensions (45/47)

(Unit : mm)

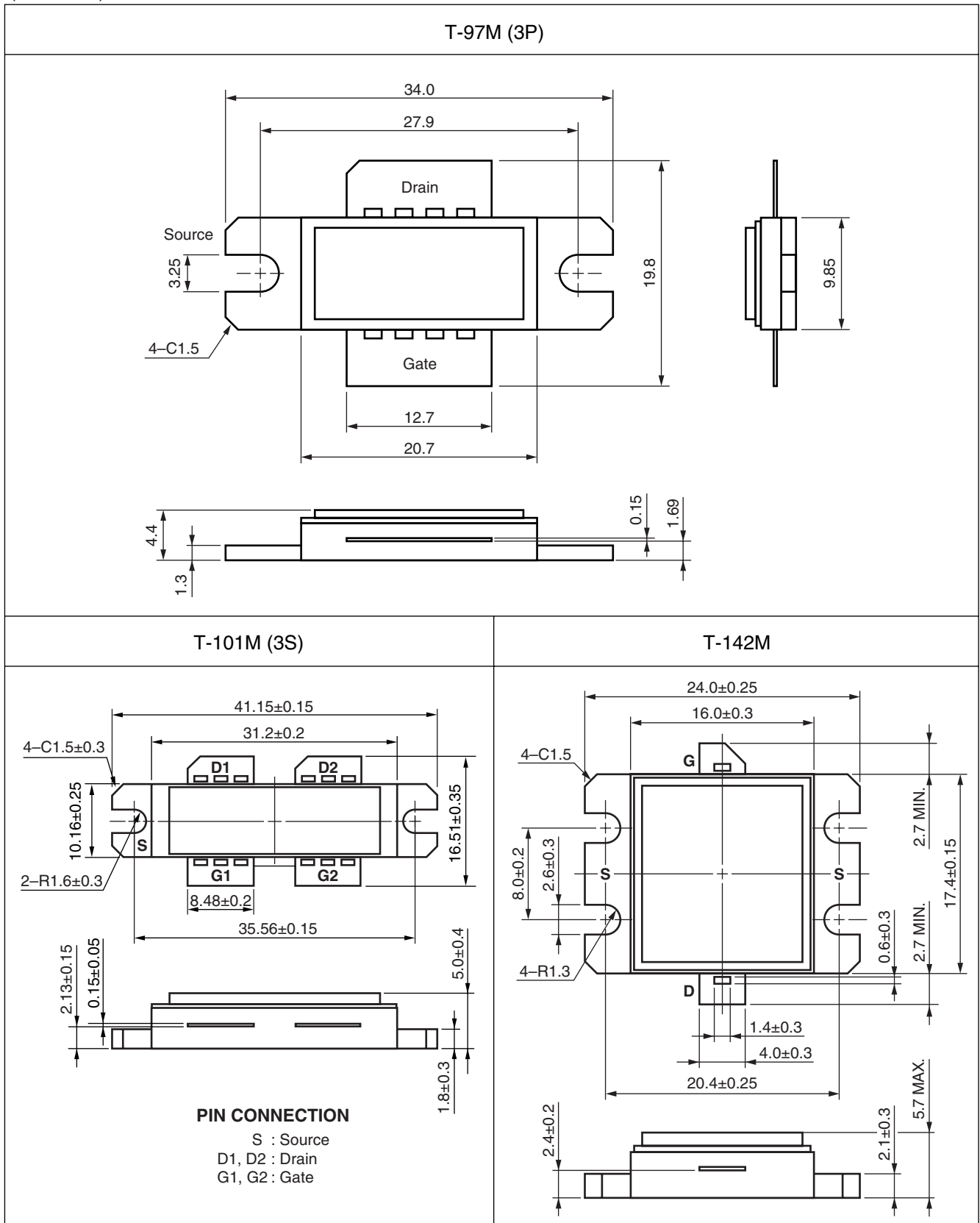

Package Dimensions (46/47)

(Unit : mm)

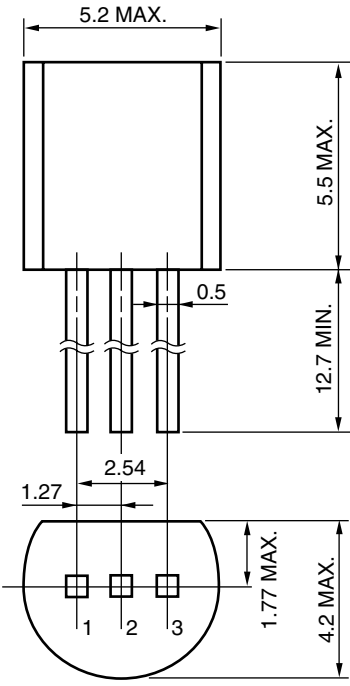
TO-92	
 <p>Technical drawing of a TO-92 package showing dimensions:</p> <ul style="list-style-type: none"> <li>5.2 MAX. (width)</li> <li>5.5 MAX. (height)</li> <li>12.7 MIN. (lead length)</li> <li>0.5 (lead thickness)</li> <li>1.27 (lead offset)</li> <li>2.54 (lead pitch)</li> <li>1.77 MAX. (lead width)</li> <li>4.2 MAX. (lead spacing)</li> </ul> <p>Pins are labeled 1, 2, and 3.</p>	

Package Dimensions (47/47)

(Unit : mm)

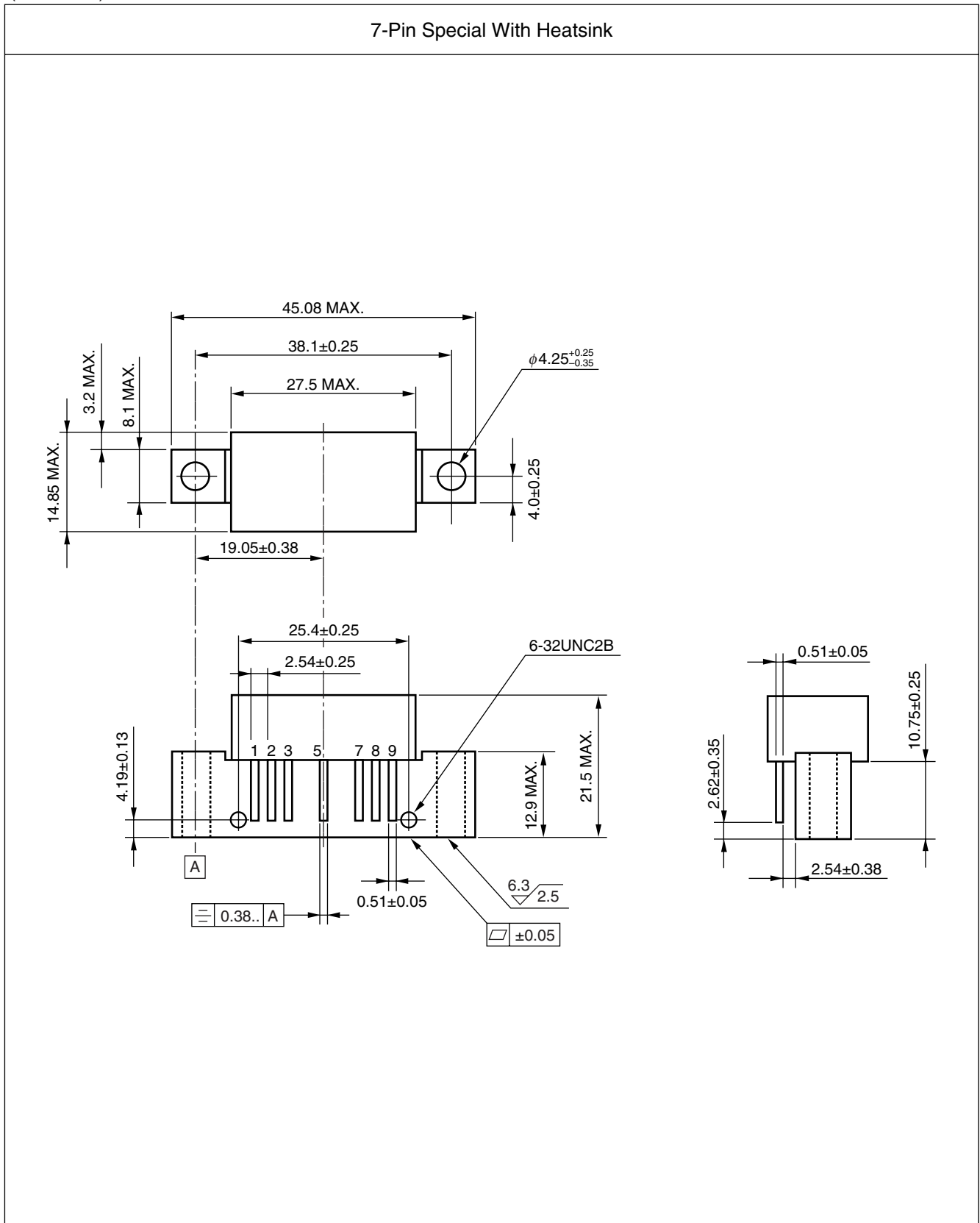

Mounting Pad Layout (1/6)

(Unit : mm)

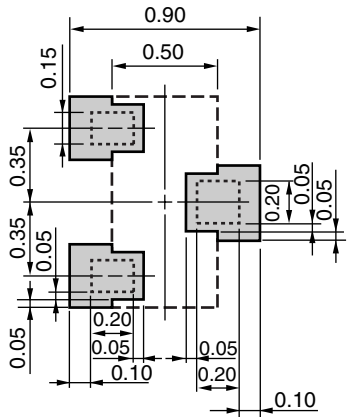
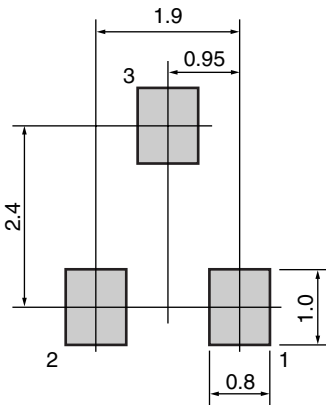
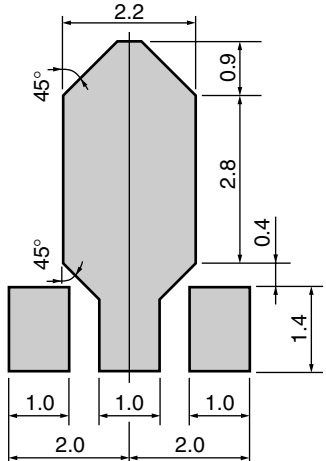
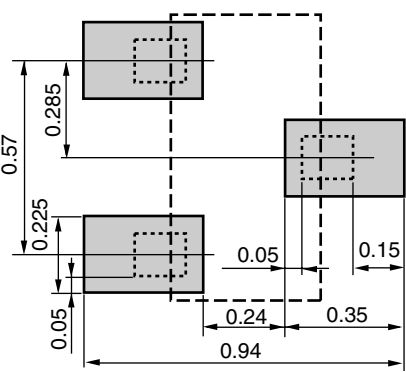
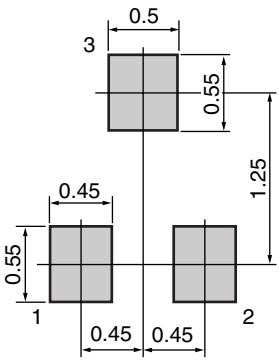
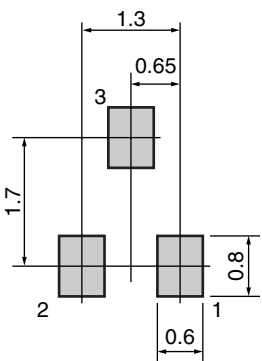
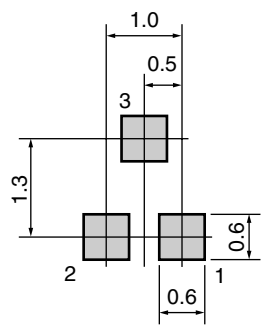
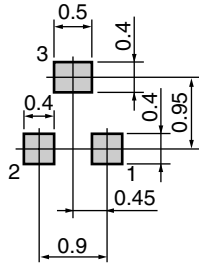
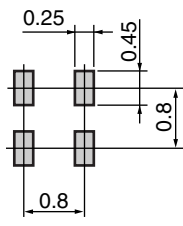
3-Pin Lead-Less Minimold	3-Pin Minimold (33 PKG)	3-Pin Power Minimold (34 PKG)
 <p>0.90 0.15 0.50 0.35 0.05 0.35 0.05 0.20 0.05 0.05 0.10 0.20 0.10</p> <p>Remark --- : Mold package       ..... : Lead</p>	 <p>1.9 0.95 2.4 1.0 0.8</p>	 <p>2.2 45° 0.9 2.8 0.4 1.4 1.0 1.0 1.0 2.0 2.0</p>
3-Pin Super Lead-Less Minimold (M33, 0804 PKG)	3-Pin Thin-Type Lead-Less Minimold (M53, T6J)	3-Pin Super Minimold
 <p>0.57 0.285 0.225 0.05 0.15 0.05 0.24 0.35 0.94</p> <p>Remark --- : Mold package       ..... : Lead</p>	 <p>0.5 0.55 1.25 0.45 0.55 0.45 0.45</p>	 <p>1.3 0.65 1.7 0.8 0.6</p>
3-Pin Ultra Super Minimold (19, 1608 PKG)	Flat-Lead 3-Pin Thin-Type Ultra Super Minimold	4-Pin Lead-Less Minimold (M14, 1208 PKG)
 <p>1.0 0.5 1.3 0.6 0.6</p>	 <p>0.5 0.4 0.4 0.95 0.45 0.9</p>	 <p>0.25 0.45 0.8 0.8</p>

Mounting Pad Layout (2/6)

(Unit : mm)

4-Pin Minimold (39)	4-Pin Power Minimold	4-Pin Super Minimold (18)
Flat-Lead 4-Pin Thin-Type Super Minimold (M04)	Flat-Lead 4-Pin Thin-Type Super Minimold (M05, 2012 PKG)	6-Pin Lead-Less Minimold (M16, 1208 PKG)
6-Pin Lead-Less Minimold (1511 PKG) for Silicon MMIC/GaAs MMIC	6-Pin Minimold	6-Pin Super Lead-Less Minimold (1007 PKG)
		<p><b>Remark</b>    - - - : Mold package          ..... : Lead</p>



Mounting Pad Layout (3/6)

(Unit : mm)

<R>

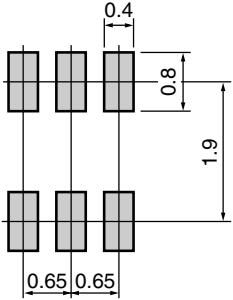
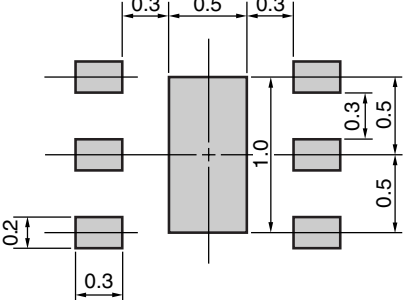
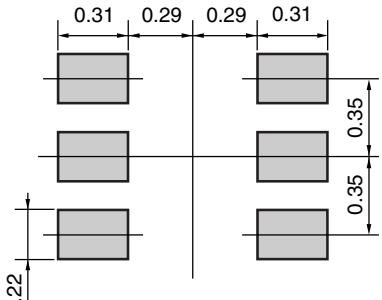
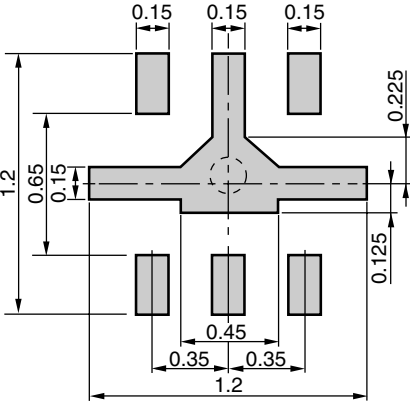
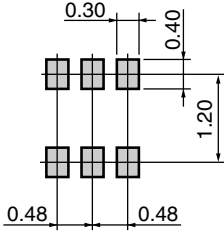
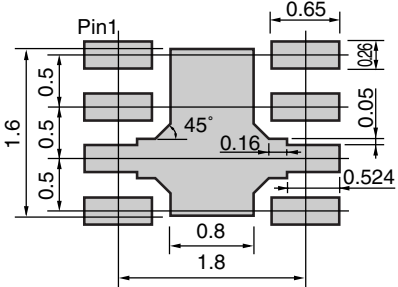
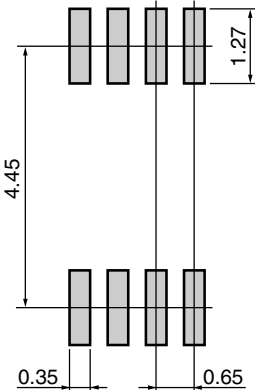
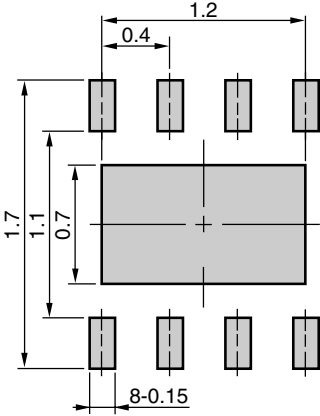
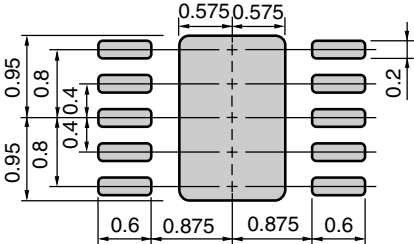
6-Pin Super Minimold (M01, TB)	6-Pin Plastic TSON	6-Pin Plastic TSSON (T5K)
		 <p>Note</p>
6-Pin Plastic TSSON (T6R)	Flat-Lead 6-Pin Thin-Type Ultra Super Minimold	8-Pin Lead-Less Minimold
		
8-Pin Plastic SSOP (4.45 mm (175))	8-Pin Plastic TSON	10-Pin Plastic TSON
		

<R> Note: This layout can also be adopted to some of the products in T6R package.  
Please refer to the data sheet of each product.

Mounting Pad Layout (4/6)

(Unit : mm)

<R>

10-Pin Plastic TSSOP	12-Pin Plastic QFN	12-Pin Plastic QFN (T7K)
12-Pin Plastic TQFN	12-Pin Plastic TSQFN (T5L)	12-Pin Plastic TSQFN (T6M)
14-pin LGA (CSP Type)	14-Pin Plastic SSOP (5.72 mm (225))	16-Pin Plastic QFN (T5T/T6S)

Mounting Pad Layout (5/6)

(Unit : mm)

<p>16-Pin Plastic QFN (T6C)</p>	<p>16-Pin Plastic SSOP (5.72 mm (225))</p>	<p>20-Pin Plastic SSOP (5.72 mm (225))</p>
<p>20-Pin Plastic QFN (0.4 mm pitch)</p>	<p>20-Pin Plastic QFN (0.5 mm pitch) (T7G)</p>	<p>20-Pin Plastic RQFN</p>
<p>&lt;R&gt; 24-Pin Plastic QFN</p>	<p>24-Pin Plastic QFN (T7L)</p>	<p>28-Pin Plastic QFN (K)</p>

**Mounting Pad Layout (6/6)**

(Unit : mm)

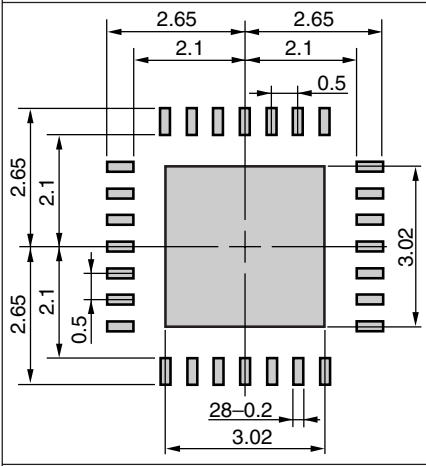
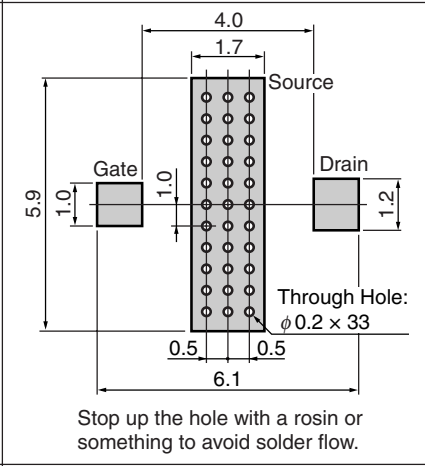
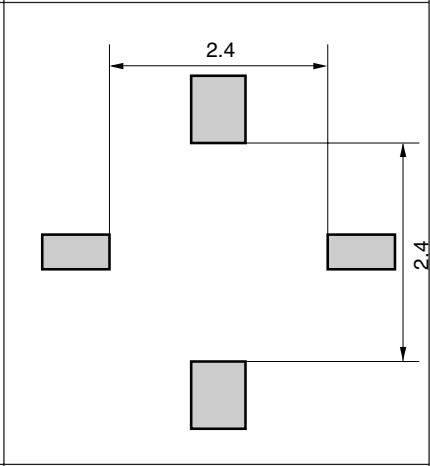
28-Pin Plastic QFN (T7A)	79A	S01
	 <p>Stop up the hole with a rosin or something to avoid solder flow.</p>	

<b>REVISION HISTORY</b>	<b>PACKAGES LINE-UP FOR RF AND MICROWAVE DEVICES</b> Common Information
-------------------------	--

Rev.	Date	Description	
		Page	Summary
1.00	Jul 22, 2010	—	Previous Number:PX10051EJ35V0TN
		p.5	<Surface Mount Type Package Line-up Actual Size Illustrations> Addition of 20-Pin Plastic TQFN (T6E)
		p.6	<List of Surface Mount Type Package Drawings (1/2)> Addition of 6-Pin Plastic RTSON (T7C) Addition of 8-Pin Plastic TSON
		pp.9, 10,12, 13, 16	<Package List> Addition of package code for 3-Pin Thin-Type Lead-Less Minimold (M53, T6J) Addition of 6-Pin Plastic RTSON (T7C) Addition of 8-Pin Plastic TSON Addition of 20-Pin Plastic TQFN
		pp.21, 30, 34	<Package Dimensions> Addition of package code for 3-Pin Thin-Type Lead-Less Minimold (M53, T6J) Addition of 6-Pin Plastic RTSON (T7C) Addition of 8-Pin Plastic TSON
		pp.62, 64	<Mounting Pad Layout> Addition of package code for 3-Pin Thin-Type Lead-Less Minimold (M53, T6J) Addition of 8-Pin Plastic TSON
2.00	Oct 13, 2010	p.5	<Surface Mount Type Package Line-up Actual Size Illustrations> Addition of 6-Pin Plastic RTSON (T7C) Addition of 8-Pin Plastic TSON
		p.7	<List of Surface Mount Type Package Drawings (2/2)> Addition of 28-Pin Plastic QFN (T7A)
		pp.12, 13, 17	<Package List> Addition of the illustration of 6-Pin Plastic RTSON (T7C) Addition of the illustration of 8-Pin Plastic TSON Addition of 28-Pin Plastic QFN (T7A)
		p.53	<Package Dimensions> Addition of 28-Pin Plastic QFN (T7A)
		p.68	<Mounting Pad Layout> Addition of 28-Pin Plastic QFN (T7A)
3.00	Apr 27, 2011	p.6	<Surface Mount Type Package Line-up Actual Size Illustrations> Addition of 20-Pin Plastic QFN (0.5) (T7G) Addition of 28-Pin Plastic QFN (T7A)
		p.8	<List of Surface Mount Type Package Drawings (2/2)> Addition of 20-Pin Plastic QFN (0.5) (T7G)
		pp.17, 18	<Package List> Addition of the illustration of 20-Pin Plastic QFN (0.5) (T7G) Addition of the illustration of 28-Pin Plastic QFN (T7A) Addition of 20-Pin Plastic QFN (0.5) (T7G)
		p.50	<Package Dimensions> Addition of 20-Pin Plastic QFN (0.5) (T7G)
		p.70	<Mounting Pad Layout> Addition of 20-Pin Plastic QFN (0.5) (T7G)

Rev.	Date	Description	
		Page	Summary
4.00	Dec 11, 2012	p.6	<Surface Mount Type Package Line-up Actual Size Illustrations> Addition of 12-Pin Plastic QFN (T7K) Addition of 24-Pin Plastic QFN (T7L)
		p8	<List of Surface Mount Type Package Drawings> Addition of 12-Pin Plastic QFN (T7K) Addition of 24-Pin Plastic QFN (T7L)
		p15	<Surface mount type 12, 14-pin package list> Addition of 12-Pin Plastic QFN (T7K)
		p18	< Surface mount type 24, 28, 30, 32, 36-pin package list> Addition of 24-Pin Plastic QFN (T7L)
		pp.40, 56	<Package List> Addition of 12-Pin Plastic QFN (T7K) Addition of 24-Pin Plastic QFN (T7L)
		P71	< Mounting Pad Layout > The note is added in Mounting Pad Layout of 6-Pin Plastic TSSOP (T5K).
		pp.72, 73	< Mounting Pad Layout > Addition of 12-Pin Plastic QFN (T7K) Addition of 24-Pin Plastic QFN (T7L)

---

PACKAGES LINE-UP FOR RF AND MICROWAVE DEVICES  
Common Information

Publication Date: Rev.1.00 Jul 22, 2010  
Rev.4.00 Dec 11, 2012

Published by: Renesas Electronics Corporation

---

**SALES OFFICES****Renesas Electronics Corporation**<http://www.renesas.com>Refer to "<http://www.renesas.com/>" for the latest and detailed information.

**California Eastern Laboratories, Inc.**  
4590 Patrick Henry Drive, Santa Clara, California 95054, U.S.A.  
Tel: +1-408-919-2500, Fax: +1-408-988-0279

**Renesas Electronics Europe Limited**  
Dukes Meadow, Millboard Road, Bourne End, Buckinghamshire, SL8 5FH, U.K  
Tel: +44-1628-651-700, Fax: +44-1628-651-804

**Renesas Electronics Europe GmbH**  
Arcadiastrasse 10, 40472 Düsseldorf, Germany  
Tel: +49-211-65030, Fax: +49-211-6503-1327

**Renesas Electronics (China) Co., Ltd.**  
7th Floor, Quantum Plaza, No.27 ZhiChunLu Haidian District, Beijing 100083, P.R.China  
Tel: +86-10-8235-1155, Fax: +86-10-8235-7679

**Renesas Electronics (Shanghai) Co., Ltd.**  
Unit 204, 205, AZIA Center, No.1233 Lujiazui Ring Rd., Pudong District, Shanghai 200120, China  
Tel: +86-21-5877-1818, Fax: +86-21-6887-7858 / -7898

**Renesas Electronics Hong Kong Limited**  
Unit 1601-1613, 16/F., Tower 2, Grand Century Place, 193 Prince Edward Road West, Mongkok, Kowloon, Hong Kong  
Tel: +852-2886-9318, Fax: +852 2886-9022/9044

**Renesas Electronics Taiwan Co., Ltd.**  
13F, No. 363, Fu Shing North Road, Taipei, Taiwan  
Tel: +886-2-8175-9600, Fax: +886 2-8175-9670

**Renesas Electronics Singapore Pte. Ltd.**  
80 Bendemeer Road, Unit #06-02 Hyflux Innovation Centre Singapore 339949  
Tel: +65-6213-0200, Fax: +65-6213-0300

**Renesas Electronics Malaysia Sdn.Bhd.**  
Unit 906, Block B, Menara Amcorp, Amcorp Trade Centre, No. 18, Jln Persiaran Barat, 46050 Petaling Jaya, Selangor Darul Ehsan, Malaysia  
Tel: +60-3-7955-9390, Fax: +60-3-7955-9510

**Renesas Electronics Korea Co., Ltd.**  
11F., Samik Lavied or Bldg., 720-2 Yeoksam-Dong, Kangnam-Ku, Seoul 135-080, Korea  
Tel: +82-2-558-3737, Fax: +82-2-558-5141





# PACKAGES LINE-UP FOR RF AND MICROWAVE DEVICES



Renesas Electronics Corporation

R50ZZ0001EJ0400