

RENESAS MCU “CLOUD SOLUTION”

2025.DEC

REV.4.00

EMBEDDED PROCESSOR & CONTROLLER SOLUTION
MARKETING DEPT
EMBEDDED PROCESSING MARKETING DIVISION
EMBEDDED PROCESSING PRODUCT GROUP
(EP/EPMD/EPMSM)

RENESAS ELECTRONICS CORPORATION

CONTENTS

Content	Page
▪ IoT Market Needs and IoT System Use Cases	3
▪ IOT Cloud Solution which connect OT and IT	8
▪ ‘QE for OTA’ : Development Assistance Tool for Firmware Update	17
▪ TCP/IP Network Solution for RA and RX	20
▪ Security Solution	22
▪ Summary	29

IOT MARKET NEEDS

✓ Robust Security & Device Trust

✓ High Performance & Real-Time Processing

✓ Connectivity & Multi-Network support



✓ Edge AI and Real-Time Intelligence

✓ Cloud-Ready service & OTA Framework

✓ Long-Term Supply & Product Reliability

Enhancing Product Value Proposition

Creating a comprehensive solution suite

Data collection
Remote control
Remote Monitoring



Health Monitoring
Health management



Cost Optimization

Reducing workload and time to market

Connected Cities
Smart agriculture



Process optimization
Inventory tracking



Security Alerts and Latest updates

Continuous updates

Anomaly and fault detection
Predictive Maintenance



Software and security updates



Remote Home Appliances



Building Automation



HVAC (Air Conditioning /Motor/Pump Control)



Medical Device health care



OA



FA/Robot



Smart Energy (Storage batteries, EV chargers, etc.)



RENESAS PROVIDES IOT SYSTEMS THAT CAN BE SELECTED ACCORDING TO 'USE CASES'

Suitable configuration can be selected from Following three system configurations

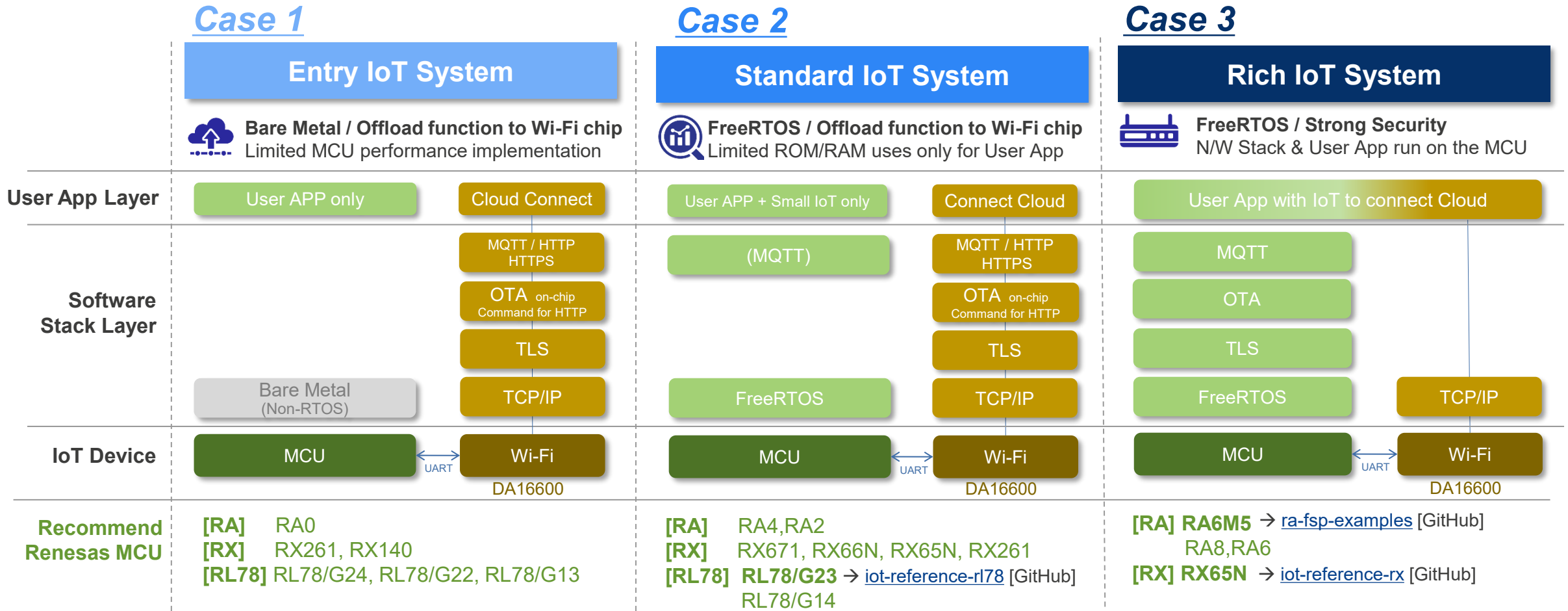

CASE1 : ENTRY IOT SYSTEM

SOLUTIONS THAT SUPPORT THE CONVERSION OF EXISTING SYSTEMS TO IOT

Simply add a Wi-Fi module to your existing system to easily achieve IoT!

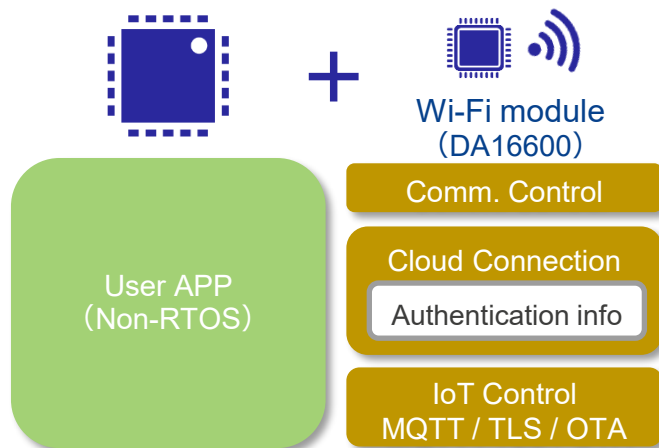

Pros

- Existing systems can easily achieve IoT by adding Wi-Fi module with IoT function.
- Cloud connection can be achieved even with MCUs with small ROM/RAM size

Cons

- Wi-Fi module must manage authentication information for cloud connection
- Since RTOS is not used, limited usage for simple system

RENEASAS RA Easy implementation by selecting necessary software package from middleware stack

Flexible Software Package Documentation:

- HTTP** [On Chip HTTP Client on DA16XXX](#)
- MQTT** [On Chip MQTT Client on DA16XXX](#)
- Driver** [DA16XXX AT Command Transport Layer](#)
- Driver** [WiFi Onchip DA16XXX Framework Driver](#)

RENEASAS RX Easily check the operation with demo using FIT driver

Application Note:

- Driver** [US159-DA16XXXMEVZ Wi-Fi Control Module](#)
- HTTP** **MQTT**
- > [Wi-Fi DA16600 Multiple Protocols Demo](#)

RENEASAS RL78 Easily check the operation with demo using drivers for RL78

Application Note:

- Driver** [US159-DA16XXXMEVZ Wi-Fi Control Module](#)
- HTTP** **MQTT**
- > [Wi-Fi DA16600 Multiple Protocols Demo](#)
- HTTP** **OTA**
- [MCU Firmware Update Over-the-Air on RL78/G23-128p FPB with Wi-Fi DA16600](#)

CASE2 : STANDARD IOT SYSTEM

REAL-TIME CONTROL WHICH IS MANDATORY FOR IOT SYSTEM CAN BE EASILY IMPLEMENTED

By using RTOS, IoT control which require Realtime control can be supported

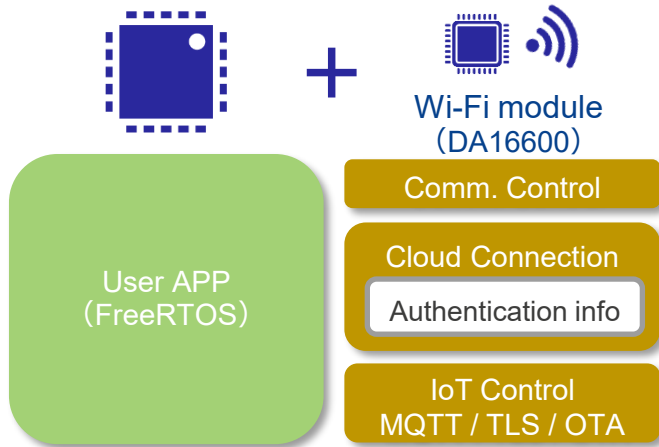

Pros

- Existing systems can easily achieve IoT by adding Wi-Fi module with IoT function
- Complicated control which require Real-Time can be realized with RTOS

Cons

- Wi-Fi module must manage authentication information for cloud connection

RENEASAS RA Easy implementation by selecting necessary software package from middleware stack

Flexible Software Package Documentation:

- HTTP** [On Chip HTTP Client on DA16XXX](#)
- MQTT** [On Chip MQTT Client on DA16XXX](#)
- Driver** [DA16XXX AT Command Transport Layer](#)
- Driver** [WiFi Onchip DA16XXX Framework Driver](#)

RENEASAS RX Easy to confirm the operation with demo using FIT driver

Application Note:

Driver
[US159-DA16XXXMEVZ Wi-Fi Control Module](#)

- HTTP** **MQTT**
 > Wi-Fi DA16600 Multiple Protocols Demo
- HTTP** **OTA**
[MCU Firmware Update Over-the-Air on CK-RX65N v2 with Wi-Fi DA16600](#)

RENEASAS RL78 Easy to confirm the operation with demo using drivers for RL78

Getting Started Guide: [RL78/G23 Getting Started Guide for Connecting AWS in Wi-Fi Communication: RL78/G23-128p FPB + FreeRTOS](#)

Application Note:

Driver
[US159-DA16XXXMEVZ Wi-Fi Control Module](#)

- HTTP** **MQTT**
 > Wi-Fi DA16600 Multiple Protocols Demo

CASE3 : RICH IOT SYSTEM

SOLUTION FOR EXTREMELY SECURE AND COMPLICATED IOT SYSTEMS

By Controlling the IoT system with MCU, more advanced system can be realized



+



Wi-Fi module
(DA16600)

Comm. Control

User App
+ IoT Control
(FreeRTOS)

Cloud Connection

Authentication info

MQTT / TLS / OTA

Pros

- ✓ RTOS to realize complex Real-Time performance
- ✓ User application can control whole IoT system including security
- ✓ Realize extremely safe and secure IoT system with MCU's unique security features (RX:TSIP([Trusted Secure IP](#)), RA:SCE(Secure Crypto Engine))

Cons

- Requires a complete solution development



Easy implementation by selecting necessary software package from middleware stack

Getting Started Guide :

[AWS Cloud Connectivity on CK-RA6M5v2 with Wi-Fi DA16600](#)

Application Note : [MQTT/TLS - Wi-Fi DA16600](#)

Flexible Software Package Documentation:

[MQTT](#) [AWS MQTT](#)

[OTA](#) [AWS OTA PAL on MCUBoot](#)

[HTTP](#) [AWS coreHTTP](#)



Easy to confirm the operation with demo using FIT driver

Getting Started Guide : [iot-reference-rx](#) (GitHub)

Application Note :

[MQTT](#) [OTA](#)

[How to Implement FreeRTOS OTA Using Amazon Web Services](#)

[MQTT](#) [Fleet Provisioning](#)

[Provisioning Procedure for IoT Devices](#)

[MQTT](#) [OTA](#) [Dashboard](#) [Fleet Provisioning](#)

[AWS Cloud Connectivity on CK-RX65N v2 with Wi-Fi DA16600](#)



IOT CLOUD SOLUTIONS THAT CONNECT OT AND IT

IOT CLOUD SOLUTIONS THAT CONNECT OT AND IT

- Overall -

IOT products needs development of both OT and IT

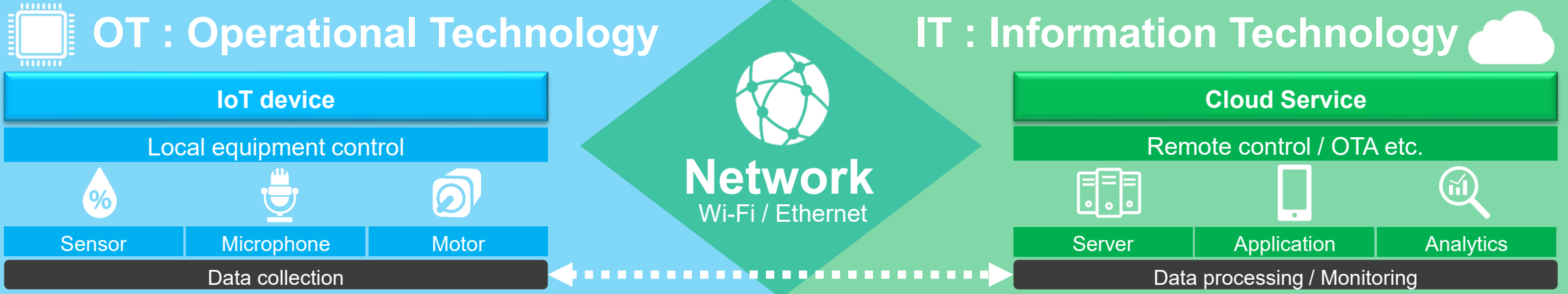

➤ [H/W] Kits for IoT development and OTA

➤ [S/W] Software with Security for IoT development

Standard IoT System

Rich IoT System



FPB-RL78G23-128p +
2.4G Wi-Fi Module

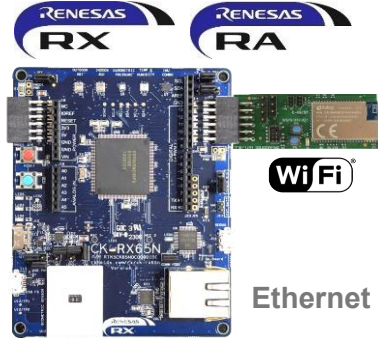

CK-RX65N / CK-RA6M5



Quick and Effective
tool solution



QE for OTA

Software for IoT

- MQTT application
- OTA FW update via cloud
- IoT Dashboard included in CK kit - free of charge (up to \$10) AWS trial account
- Support Fleet provisioning for MP
- FreeRTOS with IoT library
- Ethernet, Wi-Fi, Cellular, USB, Mic
- Secure Firmware Update with Dual Bank Function

Security

- TLS which works with MbedTLS
- AWS IoT certification management
- Server & Client Authentication key management
- Renesas H/W Secure IP (TSIP/SCE9)
- ECDSA-SHA256 Code Signature Verification for OTA
- Secure Boot loader

Renesas H/W Secure IP
 TSIP : Trusted Secure IP for RX Family
 SCE : Secure Crypto Engine for RA Family

RENESAS MCU CLOUD SOLUTION

- DELIVERABLES -

IoT Software

IoT Hardware

- How to connect to cloud
- How to update FW via Cloud?
- How to ensure security?
- How to support mass production?

Customer pain points for IoT

IT

Network

OT

- ✓ Renesas IoT Cloud Solution can support various requirements in IoT, such as MQTT, OTA, Fleet Provisioning and security. This enables smooth and uniform product development from the PoC stage to the mass production phase.
- ✓ Renesas provides comprehensive IoT solutions which our competitors cannot offer.

IoT mandatory feature		RL78	RA	RX
Cloud Connection	Quick Start example of MQTT communication with AWS	●	●	●
	Ethernet / Wi-Fi ^{*1} / Cellular ^{*1}	- / ● / ●	● / ● / ●	● / ● / ●
OTA(Over-the-Air) Firmware Update	Sample project of OTA firmware update via AWS sample project	●	●	●
	Sample project for Firmware update of 2ndary device	●	-	●
Security	TLS which works with HW Security IP	-	● (SCE9)	● (TSIP)
	Secure FW update & Secure boot	● (FWUP)	● (MCUboot)	● (FWUP) ^{*2}
Mass Production	AWS Fleet Provisioning	-	Under Planning	●
Dedicated Kit for IoT		FPB-RL78G23-128p + Wi-Fi Pmod (Sold Separately)	CK-RA6M5 V2	CK-RX65N V2

^{*1} : Wi-Fi : Renesas DA16600-PMOD
 Cellular : Renesas RYZ0214A, RYZ014A were EOL since August 2024. Now providing the software for Sequans GM01Q and GM02S which are compatible products

^{*2} : **MCUboot** is also supported for RX Family with built-in TSIP/RSIP as the Renesas Security Engine. See detail at [IoT Security](#) website.

DEVELOPMENT ENVIRONMENT

RX and RA

[AWS certified IoT Kit]

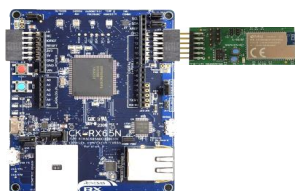

WiFi / Ethernet
[CK-RX65N web page](#)
[CK-RA6M5 web page](#)

- Includes \$10 Credit for AWS IoT by free of charge
- Renesas Wi-Fi PMOD module built-in
- Provides Sample programs and Dashboards for data visualization

[AWS FreeRTOS for cloud connection]

With the Renesas **Flexible Software Package (FSP) for RA** and **RX Driver Package**, the kit has complete software stack support using FreeRTOS and other middleware stacks

- 
- AWS certified FreeRTOS device
 - MQTT communication test program
 - OTA FW update sample program
 - **Fleet Provisioning** (RX only)

RL78

[AWS certified IoT Kit]

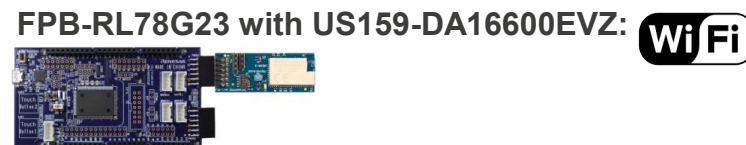

- [RL78/G23-128p Fast Prototyping Board](#)
- [US159-DA16600EVZ](#)

FPB-RL78G23 with RTKYZ024A0B00000BE*:



- [RL78/G23-128p Fast Prototyping Board](#)
- [PMOD Expansion Board for RYZ024A](#)

- 
- AWS certified FreeRTOS device
 - OTA FW update sample program

[OTA Update of a Secondary MCU]

Ethernet

Firmware Update for non-cloud device via cloud (Ethernet)

- **Primary:** [CK-RX65N](#)
- **Secondary:** [RL78/G23-128p Fast Prototyping Board](#)

Development environment

[Easy to start with e2 studio]



- Generate sample project on e2 studio
- Easy to setup peripherals/pins/RTOS

[OTA assist tool (QE for OTA)]

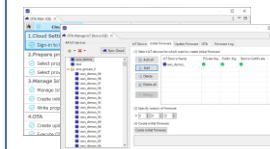

- Control AWS to automate complex OTA procedures.
- Support creating IoT device, initial firmware and update firmware creation and OTA execution.
- V2.2.0 supports FW update MCU which is not connected to cloud

NEW

[Various tutorial videos]

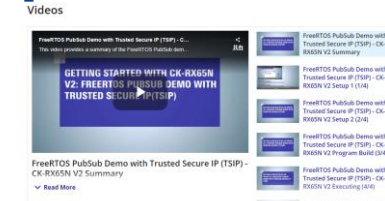

* Note: Cellular part had supported until June/2024, but now became EoL status : ex-RYZ024A(=Sequans/GM02S).

RENESAS MCU CLOUD SOLUTION AS IOT REAL USE CASE BY OT AND IT

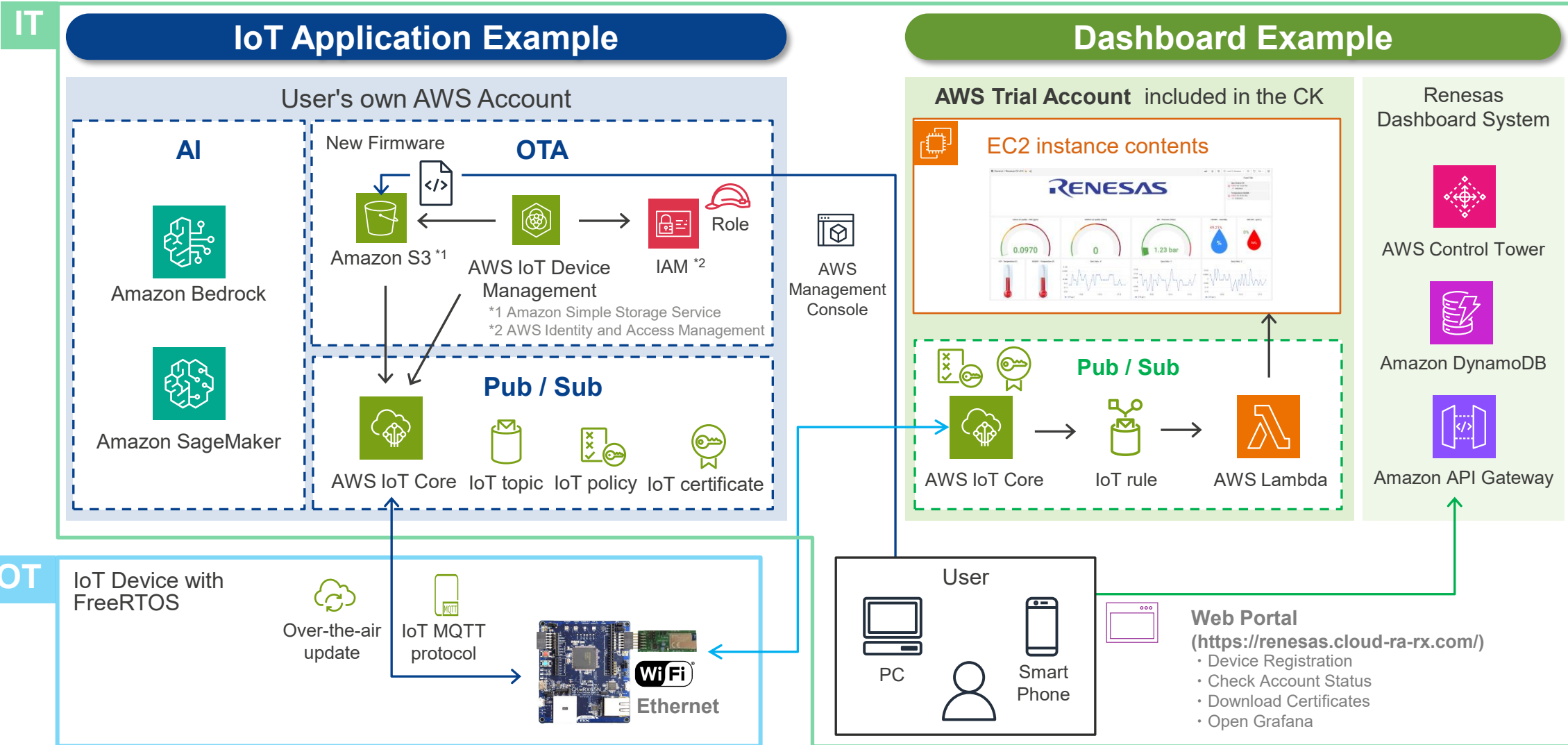

OTA SOLUTION WITH AWS IOT CLOUD

Renesas MCUs can Provide OTA (FW update) solution using AWS IoT Cloud

✓ **Dual Bank FlashROM is suitable for OTA feature.**
Able to download new FW, While executing user FW.

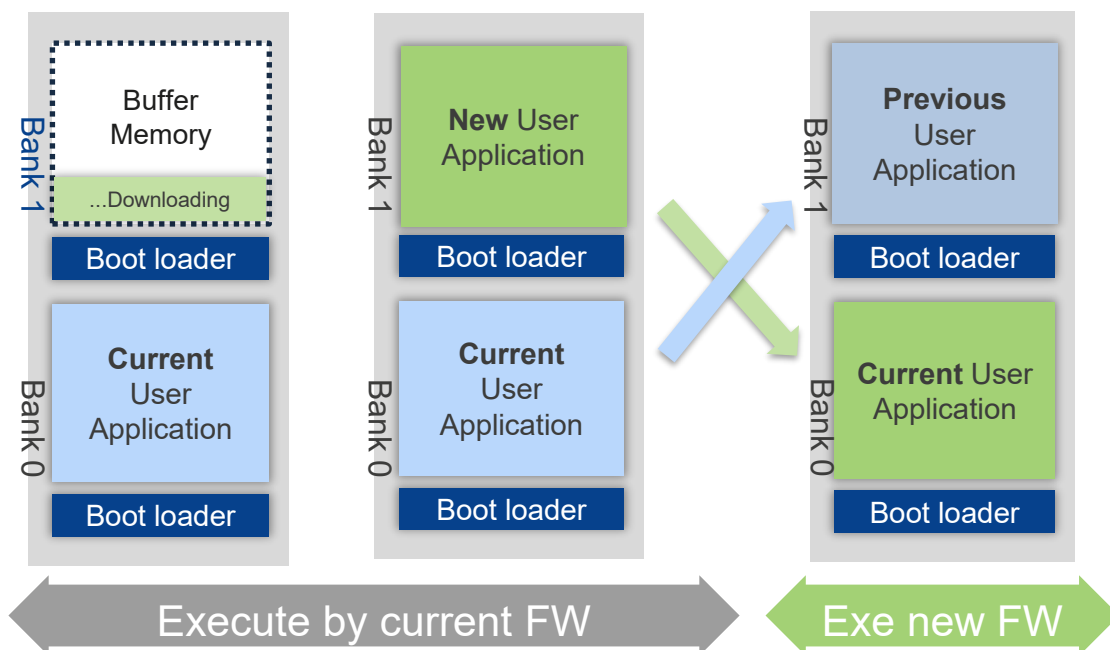

It's easy to recover in case of FW Update process failure since current FW on Bank0 will be maintained until the update is complete.

✓ **Safe OTA / FW Update solution with Secure boot**

- ✓ Provide OTA Sample programs for OTA thru AWS IoT Cloud
- ✓ Securely manages KEYS using MCU built-in Security feature(TSIP)
- ✓ Easy implementation by simply operating the OTA assist "QE for OTA"

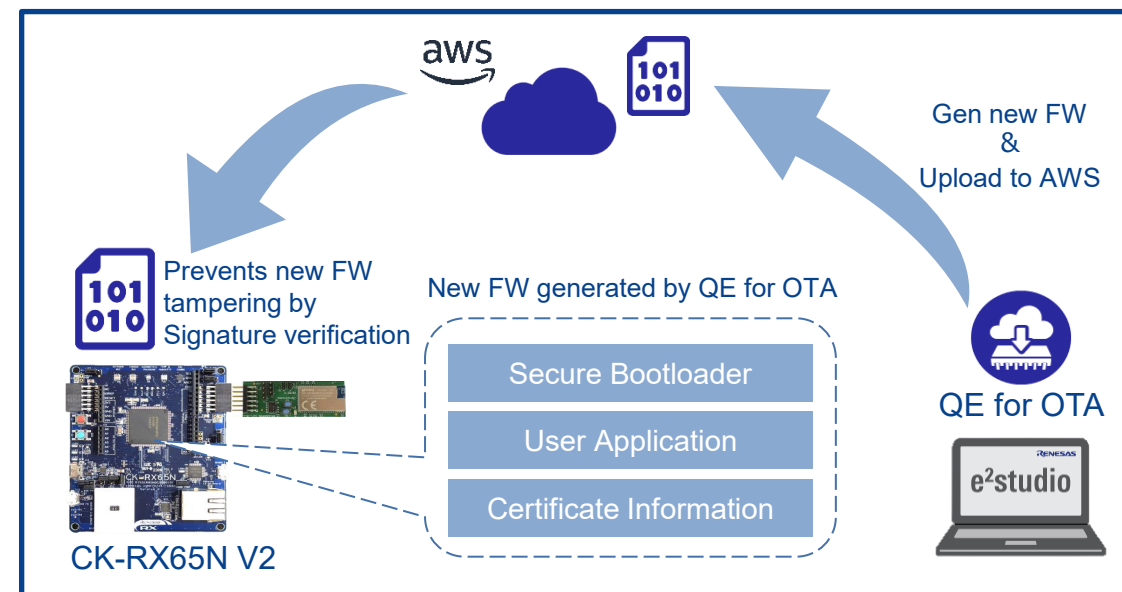

More Detail... [Renesas IoT Cloud](#)

BENEFIT OF AWS FLEET PROVISIONING

SUPPORTED BY RX SOLVES CUSTOMER'S MASS PRODUCTION CHALLENGES

AWS Fleet Provisioning only supported by CK-RX65N-V2 kit, as of December 2025.

Fleet Provisioning is best way for mass production

Challenge Every device requires different version of firmware individually deployed

Bad : Complicated procedure is required on Mass Production phase

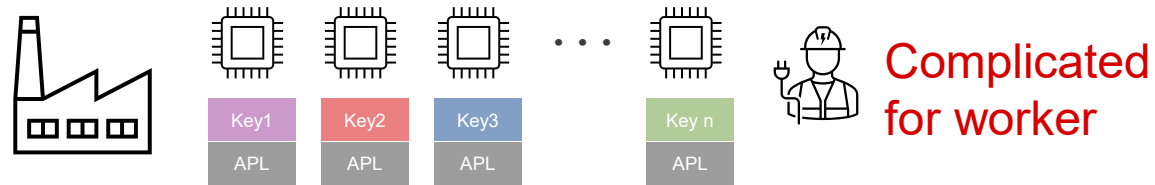

Solution

Every device requires unique firmware.

✓ Fleet Provisioning can use common certification, key, device name, so customer needs to build only one firmware.

Good : Simplify procedure on Mass Production phase

Distributes the unique key and certification when device connect to AWS at the first time

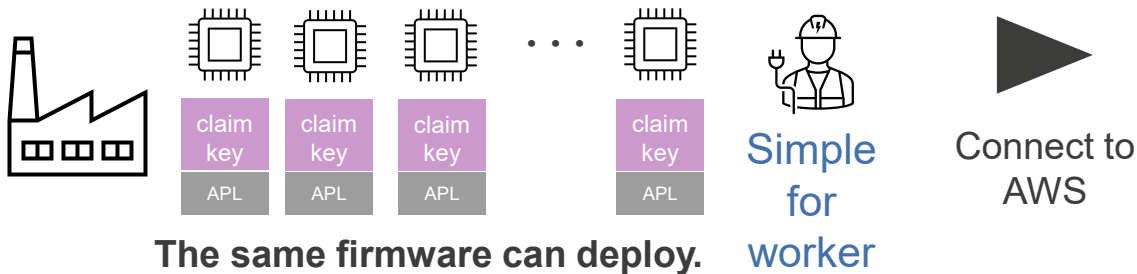

Connect to AWS

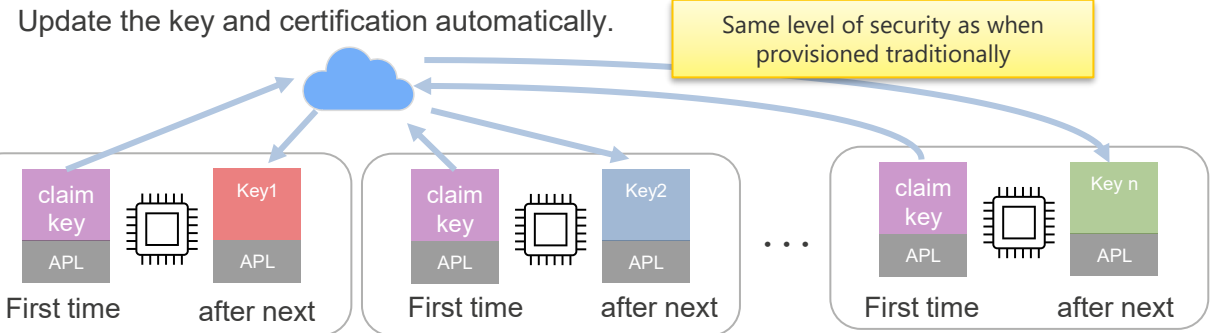

ANOMALY DETECTION USE CASES USING THE “AWS IOT DEVICE DEFENDER”



Please Refer to : [AWS IoT Device](#)

Benefit: Continuous IoT Data Monitoring Enables Rapid Mitigation of Detected Anomalies

Implementation Example

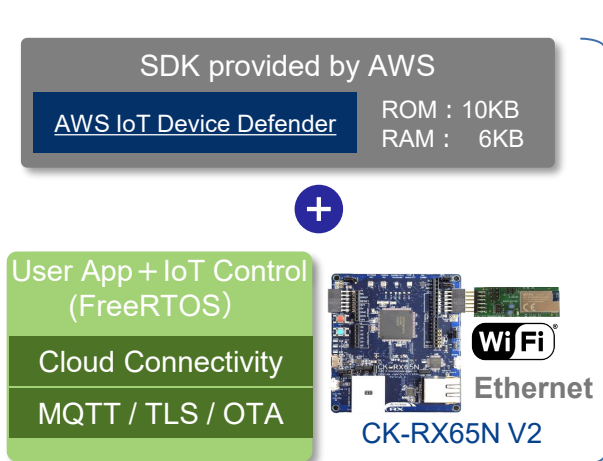

Five Key Features of "AWS IoT Device Defender"

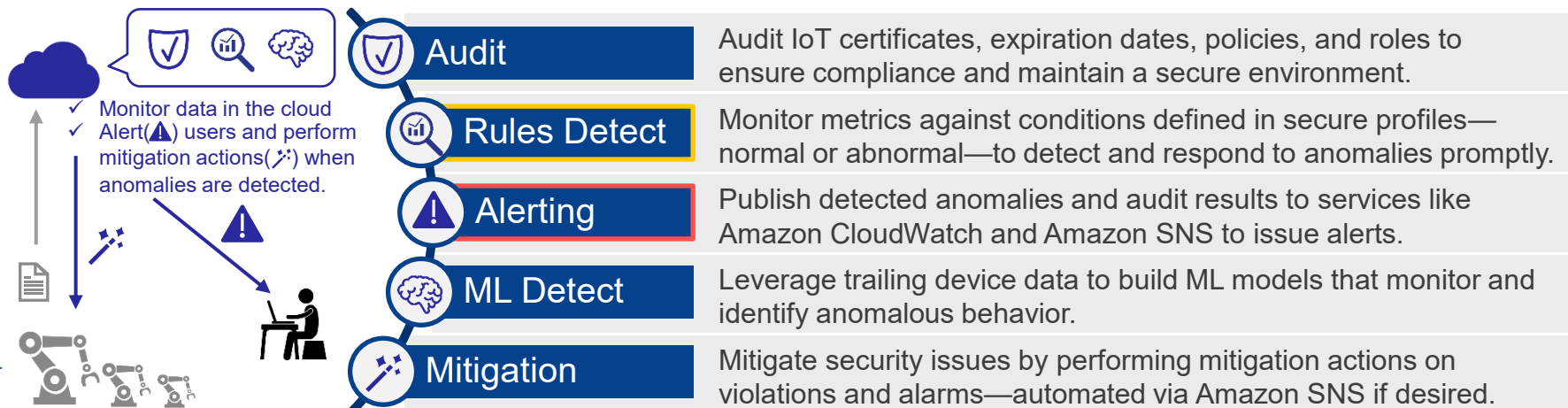

Architecture Example

Send metric values from IoT devices at regular intervals and notify via email when AWS IoT Device Defender detects anomalies.

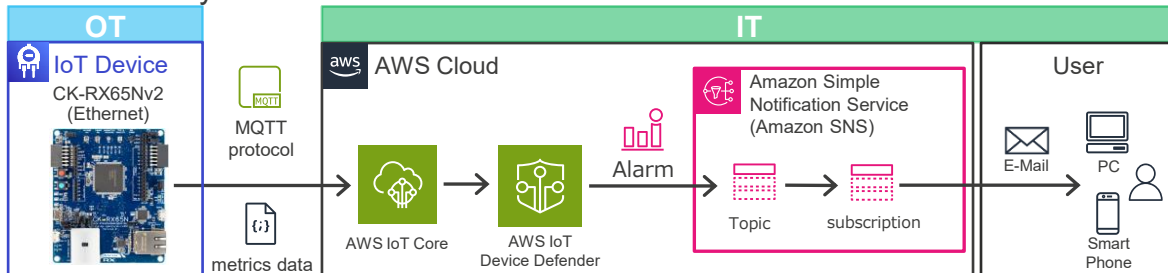

Anomaly detection system (Rules Detect + Alerting)

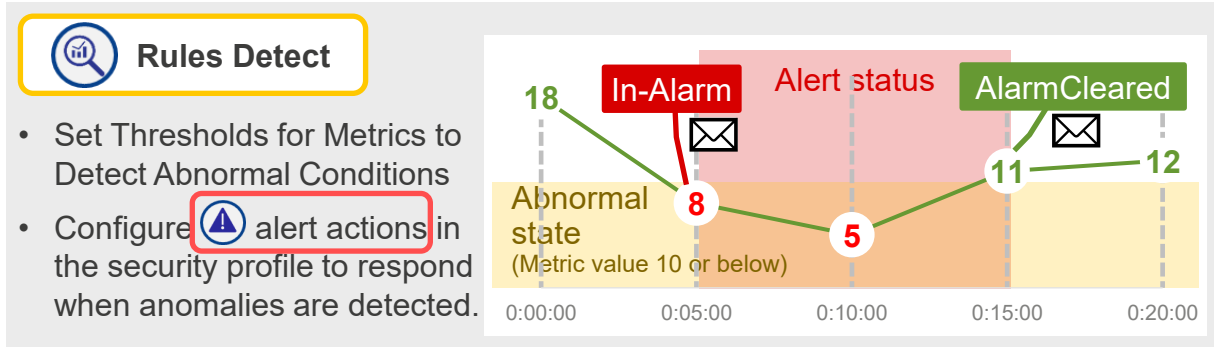

IOT • OTA SOLUTION DEMO

- IOT AIR CONDITIONER -

Renesas IoT Air conditioner Demo



- ✓ IoT & OTA demo that reproduces an air conditioner system and has the functions required for an actual IoT product
- ✓ Leverage all the technologies for IoT, including remote monitoring of sensor data, OTA, and Fleet Provisioning

■ Demo Configuration

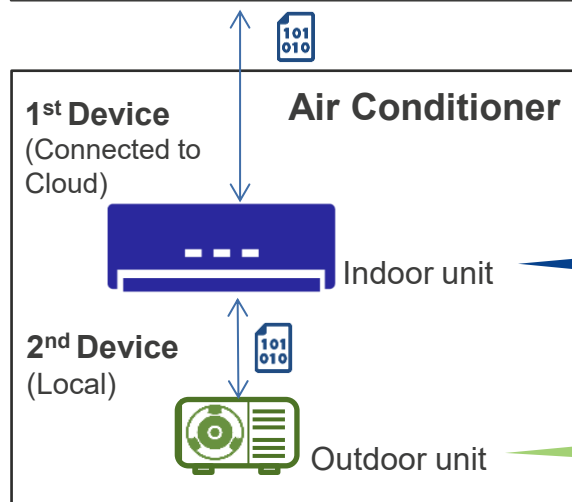
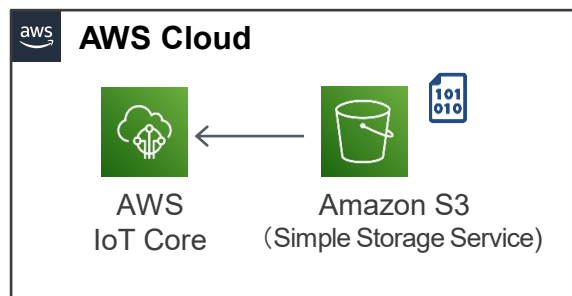

1st Device
RX65N
+ Wi-Fi(DA16600)

2nd Device
RX26T + RAI
for Motor Control

■ Demo Outline



1st Device
(RX65N + DA16600)

- Installed all functions needed for IoT and cloud
- Realize OTA(Over the Air) via AWS Cloud (Over-the-Air)
- Support AWS Fleet Provisioning which is needed for MP
- FW Update of 2nd Device via AWS Cloud

2nd Device
(RX26T + RAI)

- FW Update via 1st Device
- Motor rotation speed is controlled by RAI according to IAQ value
- OTA via AWS to update to the firmware with appropriate RAI parameter value

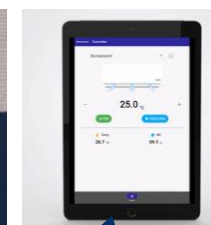

Tablet Showing Sensor data

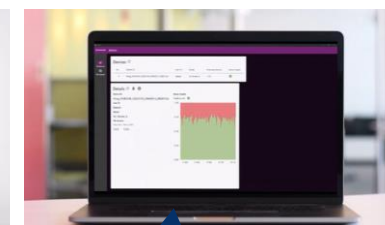

Administrator terminal



QE FOR OTA

DEVELOPMENT ASSISTANCE TOOL FOR FIRMWARE UPDATE

QE FOR OTA: DEVELOPMENT ASSISTANCE TOOL FOR FIRMWARE UPDATE



Functions marked with '★' is supported by **Rich IoT System.**

From **Over the Air (OTA)** to **Local application**
Firmware update with various system structure can be executed with simple GUI

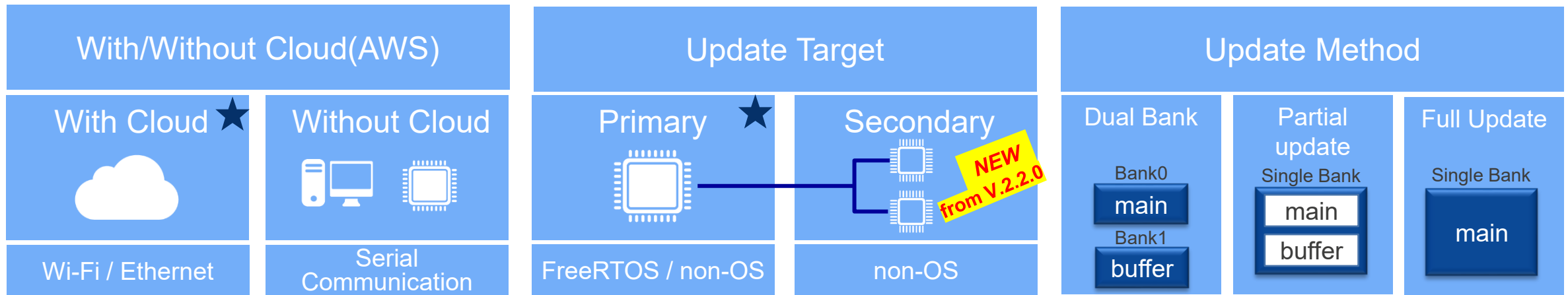

Reduce time required for 1 IoT device OTA by 86%! Support smooth PoC development!

Quick and Effective tool solution



QE for OTA

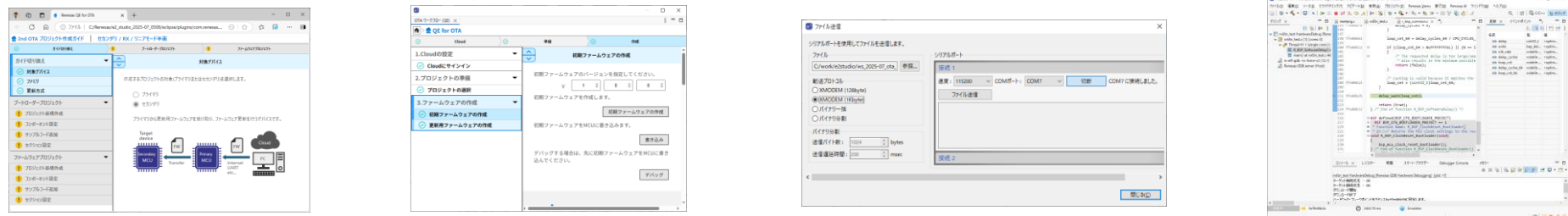

OTA AND FIRMWARE UPDATE BY “QE FOR OTA”



< More information >

- [QE for OTA: Development Assistance for Cloud](#)
- [Firmware Update module](#)

Devices marked with '★' is supported by **Rich IoT System.**

	Firmware Update WITHOUT via Cloud			Firmware Update WITH via Cloud		
: Update FW Location						
Update Target	Primary	Primary	Secondary	Primary	Primary	Secondary
Supported Devices	<RA> RA6M4, RA6M5 <RX> RX Family – All series <RL78> RL78/G22,G23,G24,L23	<RX> RX65N	<RX> RX23E-B, RX66T, RX660, RX261, RX140 <RL78> RL78/G22, RL78/G23	<RA> RA6M5★ <RX> RX65N★ <RL78> RL78/G23	<RX> RX65N★	<RX> RX23E-B, RX66T, RX660, RX261, RX140 <RL78> RL78/G22, RL78/G23
with / without RTOS	non-OS	FreeRTOS, non-OS	non-OS	FreeRTOS	FreeRTOS	non-OS
Flash Memory Update method	< RA, RX > Dual Bank Method < RL78 > Partial Update Method	Support for Primary MCU FW update is planned by next version in 1Q/2026 *3	Dual Bank Method*1, Partial Update Method, Full update method	< RA, RX > Dual Bank Method < RL78 > Partial Update Method	Dual Bank Method	Dual Bank Method*1, Partial Update Method, Full update method
Communication method	Serial Communication*2			< RA, RX > Ethernet < RL78 > Cellular		Serial Communication*2

*1: Only supported by Dual Bank mode-compatible devices. *2: Using " Serial Communication Firmware Updating Communications Module (RX, RL78) " for communication between MCUs.

*3: In Current ver.2.2.0, only FW transfer to Secondary is supported.

TCP/IP NETWORK SOLUTION FOR RA AND RX

MINIMAL NETWORK SOLUTION FOR RX&RA FAMILY

 : AWS IoT libraries
 : FreeRTOS Kernel
 : TCP/IP Control
 : Others

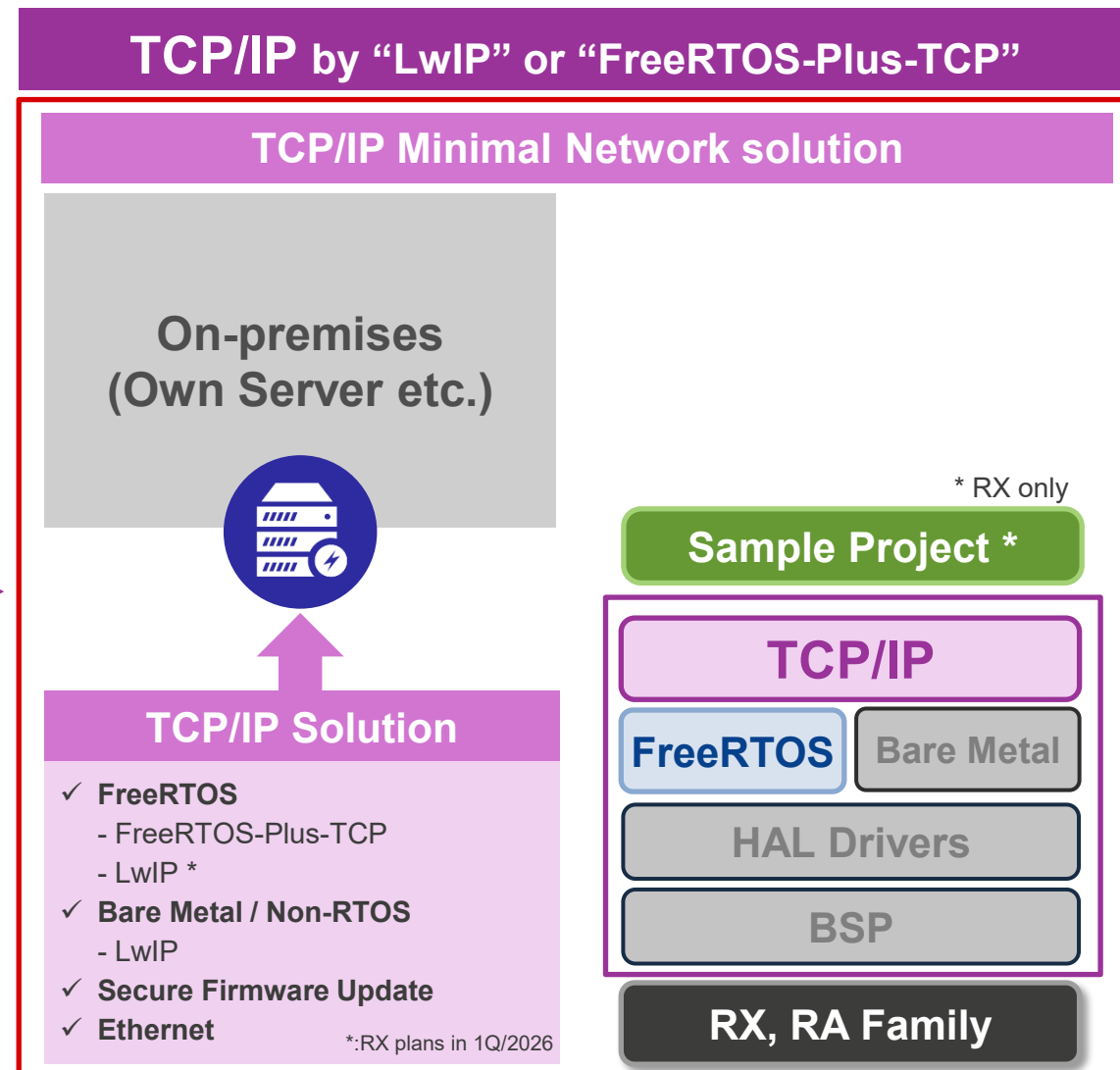
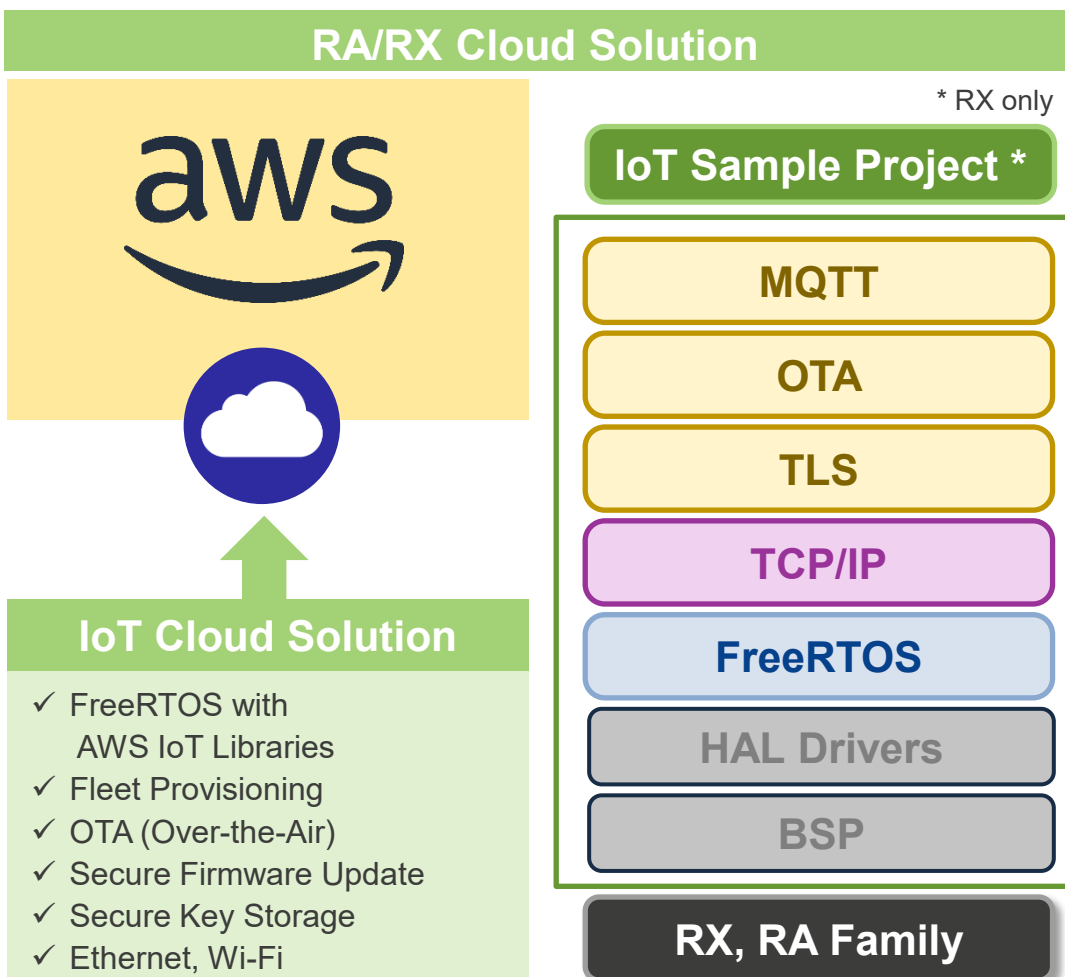

SECURITY SOLUTION



SECURITY SOLUTIONS REQUIRED FOR IOT DEVICES

Renesas supports secure IoT device development with cloud solutions

Secure Cloud Connection



- ✓ TLS communication via MbedTLS
- ✓ Strong security and High speed TLS communication using TSIP
- ✓ Secure cloud connection by device provisioning

Credential Protection for Cloud Connectivity



- ✓ Build a safe area by monitoring unauthorized access with hardware secure IP
- ✓ Encrypt and securely store key data

Tamper protection for Firmware Update



- ✓ Tampering inspection by firmware code sign verification
- ✓ Reset vector, Secure boot area and secure FW update area are protected by Area protection function

CYBERSECURITY MEASURES PROGRESSING IN EACH REGIONS

As “IoT digital products” become more widespread, each country has been strengthening their cybersecurity regulations !

<US>

A Final Rule was published in July 2024 for the U.S. Cyber Trust Mark, a voluntary cybersecurity labeling scheme for wireless consumer IoT products

<EU>

The European Cyber Resilience Act (CRA),
Entry in force Dec 2024.
Fully apply with mandated CE marking in Dec 2027.

<China>

Baseline for Classified Protection of
Cybersecurity, GB/T 22239-2019,
effective on December 1, 2019

<JP>

The Security Requirements Conformity
Assessment and Labeling System (JC-
STAR) was published in 2025



TARGETED SOLUTIONS FOR CYBER SECURITY FOR CRA



Secure Firmware Updates

- Address security vulnerabilities
- Stay up-to-date with protection against the latest security threats

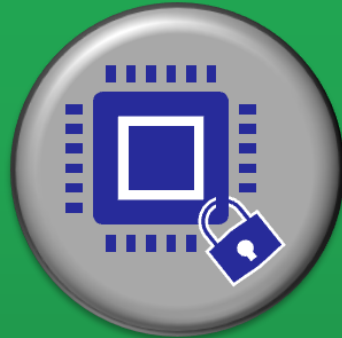

Unauthorised Access Protection

- Protect the operation and behaviour of the product and its associated data
- Protect infrastructure from infiltration

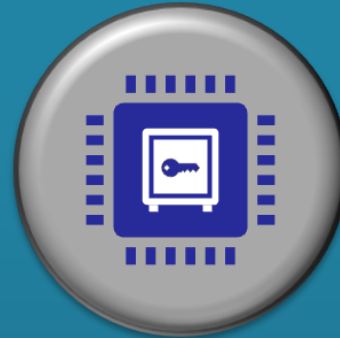

Secure Data Storage

- Protect the confidentiality and integrity of stored data
- Protect sensitive data from being exposed



Secure Communication

- Protect the confidentiality and integrity of transmitted data
- Protect infrastructure from non-authentic devices



Secure Boot

- Protect the operation and behaviour of the product
- Protect infrastructure from a compromised device

Security Functions to Fulfil CRA Cyber Security Requirements

ROOT OF TRUST

Renesas RA/RX/RZ Families provide a strong “Root of Trust” for your products

Root of Trust = Protect the starting point of operation with reliable hardware

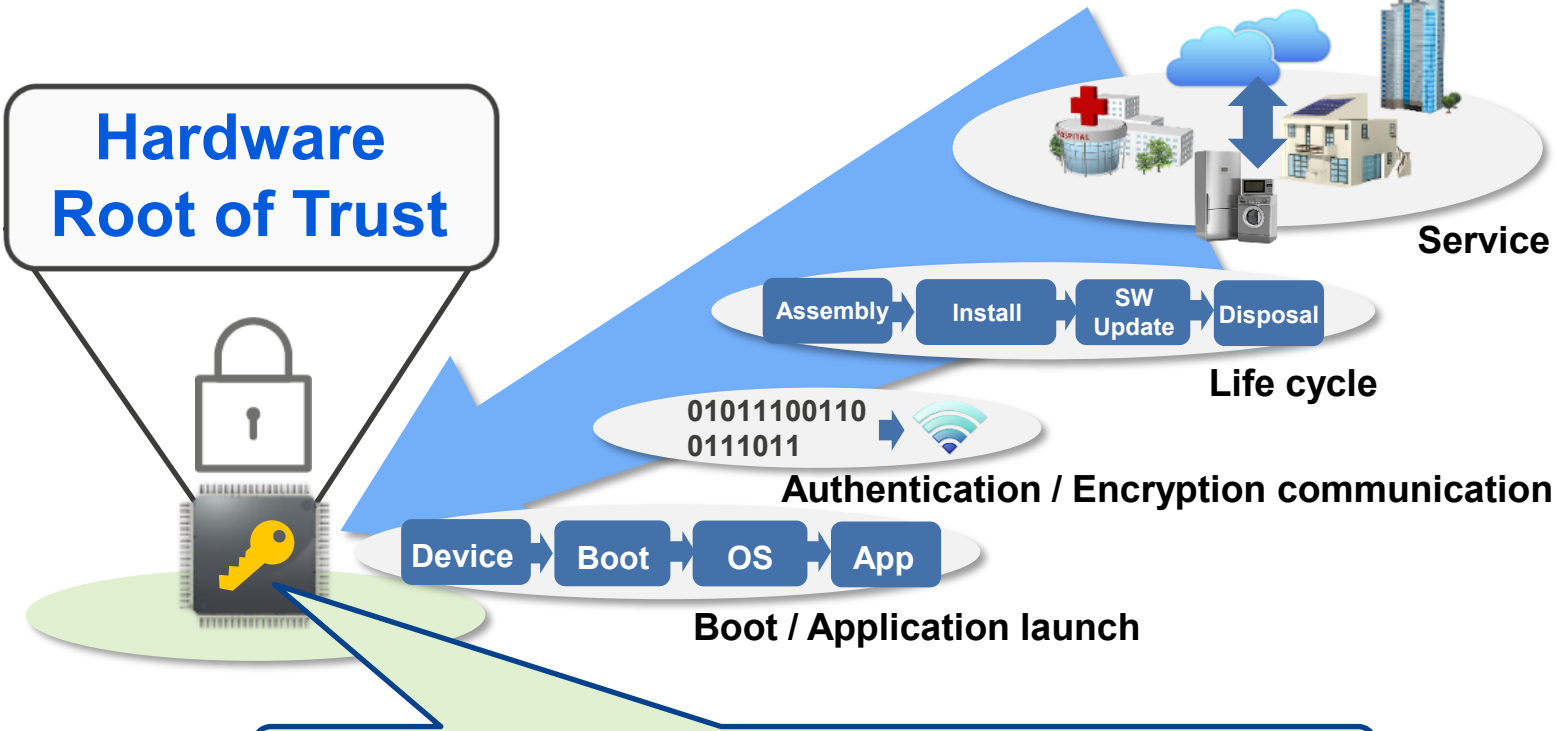
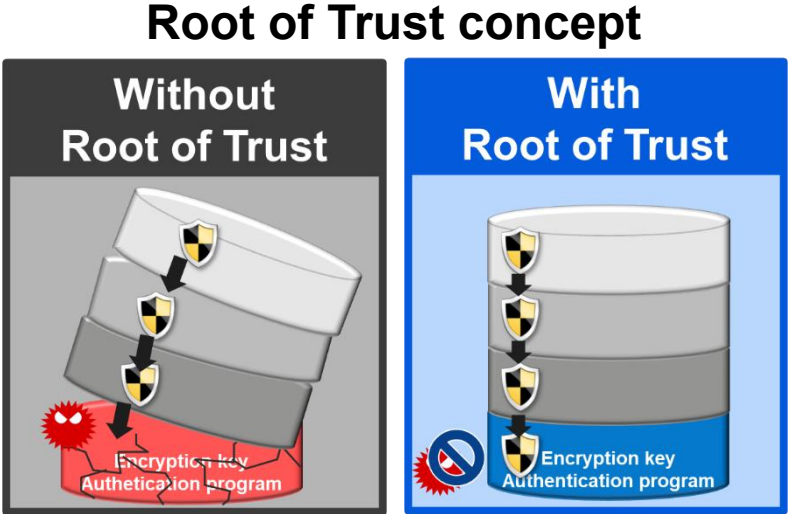

- ✓ Security implementation must be implemented in the customer's product.
- ✓ Renesas MCUs equipped with Security IP realize the **Root of Trust**.



RENESAS SECURITY ENGINE (TSIP/SCE/RSIP)

TSIP : Trusted Secure IP
 SCE : Secure Crypto Engine
 RSIP : Renesas Secure IP

TSIP/RSIP is a subsystem consisting of dedicated control logic in the MCU, completely isolating the security area

Security Subsystem as Independent Control Circuit

- Handle user keys only within the security engine, and plaintext key is not exposed on the bus.
- In case unauthorized access is detected via debugger, etc., the internal operation is stopped by access management circuit.

Key Handling

- Generate wrapped keys for storage in memory outside the security engine.
- MCU-unique key wrapping, which employs a unique key (HUK*) for each device.

Hardware Encryption Engine

- Supports various encryption algorithms such as AES/RSA/ECC.
- True random number generator circuit (TRNG) is available.

* : Hardware Unique Key

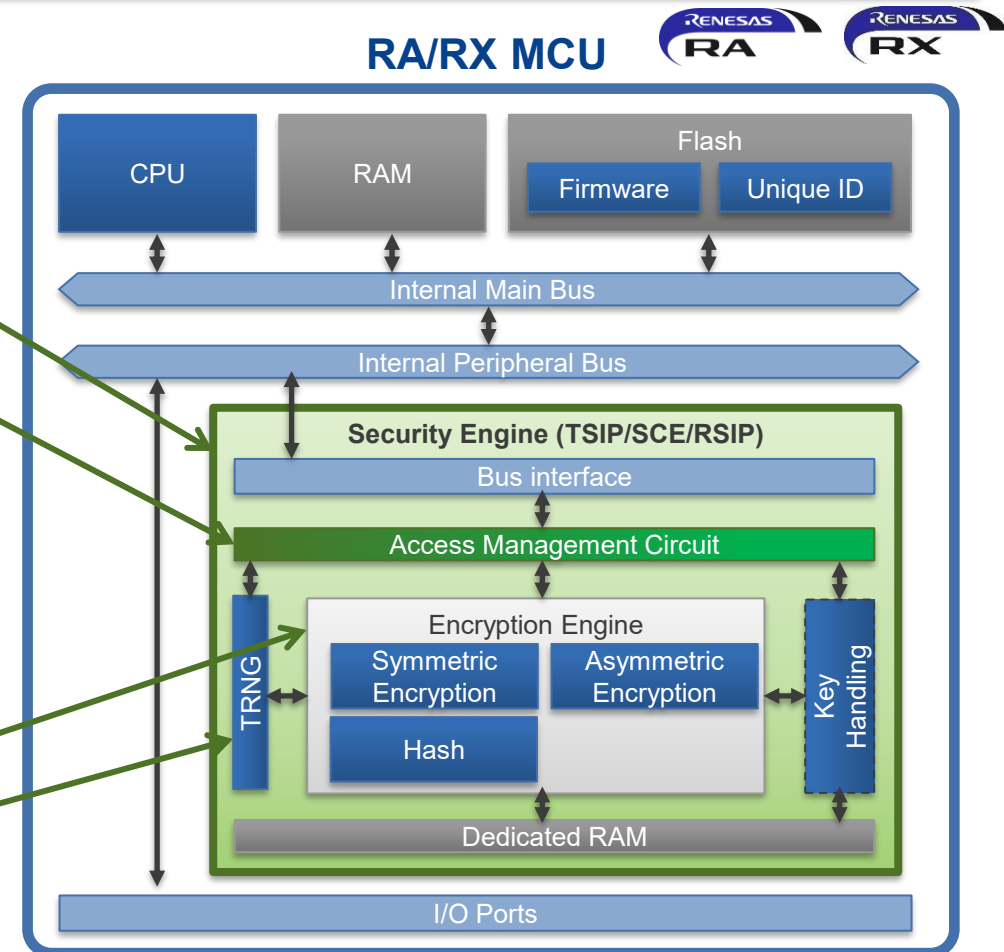

IOT USE CASE WITH SECURITY

Use case (Customer request)

- Want to develop products that utilize **Amazon AWS Cloud**.
- Want to **strengthen network security**.
- Want to **remotely monitor** products and **update FW**.

Solution

- The **standard protocol TLS**, which is used to protect data communication on the Internet, is linked with **the robust key protection function of TSIP** to support the construction of a secure network.
- **High-speed communication processing is realized by linking with TSIP** (Hardware Security IP).
- **OTA FW update program** is available, so it can be applied immediately.

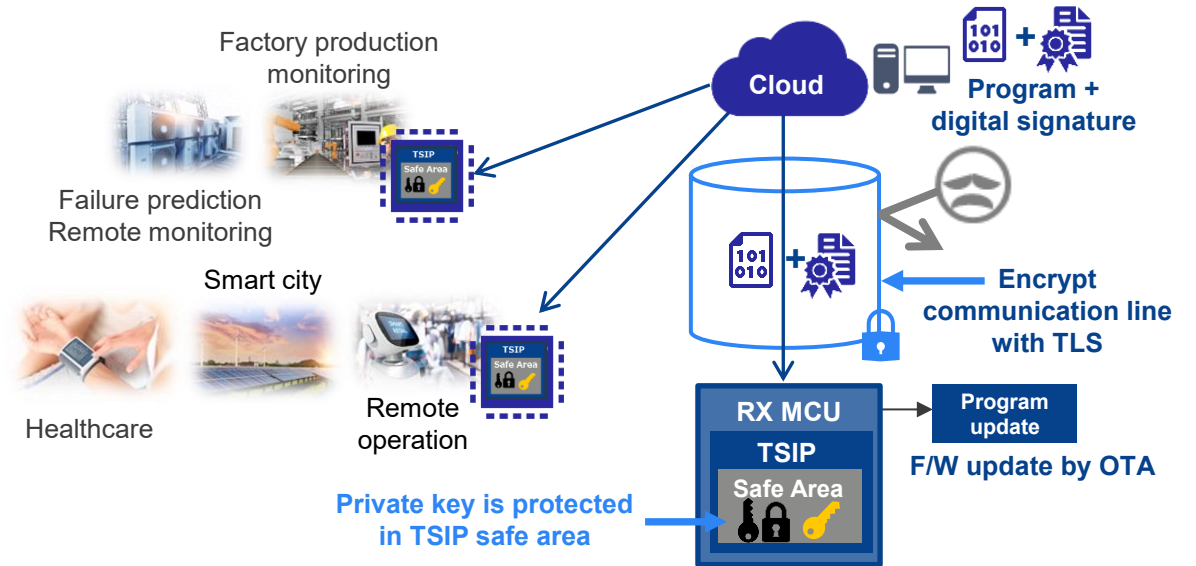

RX Cloud Connectivity Solution

Integrate TLS and TSIP in AWS

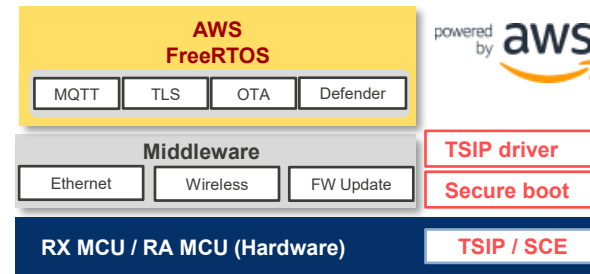

RX family, RA family AWS Certified Evaluation Kit

Realize smoothly cloud connection with evaluation kit and sample software

CK-RX65N v2

CK-RA6M v2



SUMMARY



SUMMARY

- ✓ **Renesas MCU Cloud solution** can ***realize your tomorrow's IoT products.***
- ✓ Please go to the Renesas official web page for more and the latest information.

Renesas IoT Cloud

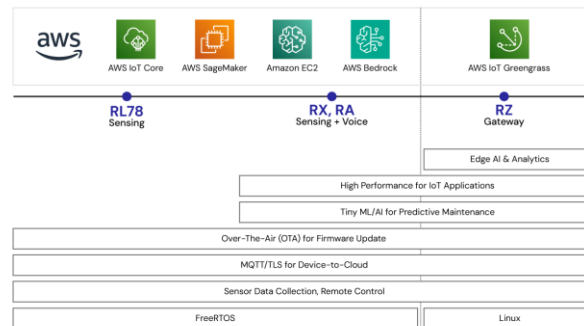
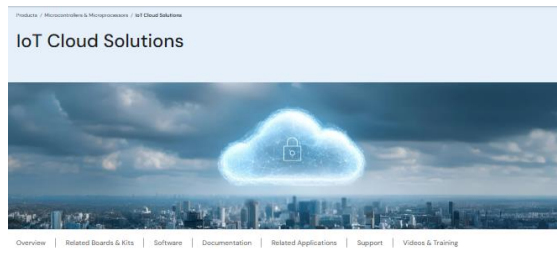

IoT Enablement Architecture

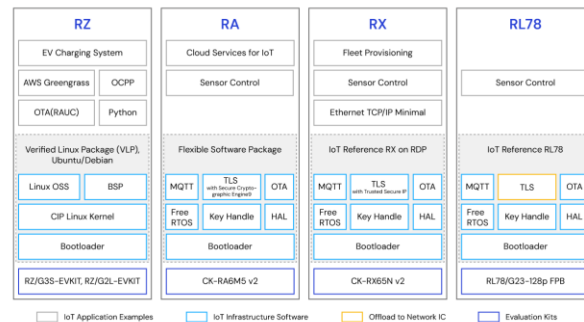

✓ Latest Solution Information

✓ List of AWS Partner Device certification Kits

✓ Tutorial Videos

✓ Various sample programs (sensor data visualization, OTA, etc.) and Application Notes

APPENDIX

VARIOUS NETWORK SUPPORT BY RENESAS IOT DEDICATED KIT

Network	Distance	Power	Data	RA	RX	RL78
Ethernet	~100m	Middle	Many	●	●	—
Wi-Fi	~50m	Middle	Many	●	●	●
LTE-M *	-	Small	Middle	●	●	●
LoRa	1~10Km	Small	Little	●	—	●

RA

Ether Wi-Fi LTE-M LoRaWAN

CK-RA6M5

RX

Ether Wi-Fi LTE-M

CK-RX65N

RL78

Wi-Fi LTE-M LoRaWAN

FPB-RL78G23-128p + 2.4G Wi-Fi Module

* : For Cat-M1 (Cellular), we can provide control software that is compatible with Sequans GM01Q or GM02S (Renesas RYZ014A or RYZ024 have been discontinued in June 2024).

APPLICATION NOTE/SAMPLE PROGRAM

RX	RA	RL78
<p>[Various IoT use case application]</p> <ul style="list-style-type: none"> MQTT Wi-Fi: Sensor data visualization using dashboard OTA LTE: High speed TLS communication using Trusted Secure IP (TSIP) which is security HW IP. OTA Ethernet: OTA Update of a Secondary Device by Amazon Web Services with the Use of FreeRTOS Fleet Provisioning Wi-Fi: RX Family Provisioning Procedure for IoT Devices 	<p>[Various IoT use case application]</p> <ul style="list-style-type: none"> MQTT Wi-Fi: Sensor data visualization using dashboard MQTT LTE: RA AWS MQTT/TLS Cloud Connectivity Solution - Cellular RYZ024A OTA Ethernet: RA AWS Cloud Connectivity and Firmware Update OTA on CK-RA6M5 v2 with Ethernet MQTT LoRa®: RA2E1, RA2L1, RA0E1, RA0E2 LoRaWAN® Sensor Demo 	<p>[Various IoT use case application]</p> <ul style="list-style-type: none"> MQTT Wi-Fi: Getting Started Guide for Connecting Amazon Web Services in Wi-Fi Communication: RL78/G23-128p FPB + FreeRTOS MQTT LTE: RL78/G23 Getting Started Guide for Connecting Amazon Web Services in LTE Communication: RL78/G23-128p FPB + FreeRTOS MQTT LTE: RL78/G23 Visualization of Sensor Information with Connecting Amazon Web Services in LTE Communication: RL78/G23-128p FPB + FreeRTOS OTA Wi-Fi: Getting Started Guide for Connecting Amazon Web Services in Wi-Fi Communication: RL78/G23-128p FPB + FreeRTOS OTA Ethernet: OTA Update of a Secondary Device by Amazon Web Services with the Use of FreeRTOS
<p>[Wi-Fi On Chip solution]</p> <ul style="list-style-type: none"> MQTT Wi-Fi: [RX] RX US159-DA16XXXMEVZ Wi-Fi Control Module Using FIT Application OTA Wi-Fi: [RX] RX Family AWS Cloud Connectivity for MCU OTA on CK-RX65N v2 with Wi-Fi DA16600 Sample Code 	<p>[Wi-Fi On Chip solution]</p> <ul style="list-style-type: none"> MQTT Wi-Fi: [RA] RA FSP: WiFi Onchip DA16XXX Framework Driver (rm_wifi_da16xxx) 	<p>[Wi-Fi On Chip solution]</p> <ul style="list-style-type: none"> MQTT Wi-Fi: RL78 Family US159-DA16XXXMEVZ Wi-Fi Control Module Using Software Integration System OTA Wi-Fi: RL78/G23 AWS Cloud Connectivity for MCU Firmware Update OTA on RL78/G23-128p FPB with Wi-Fi DA16600

NEW

NEW



RX CLOUD SOLUTION COLLATERALS MAP

RX can support Seamlessly from starting PoC to MP phase and OTA feature by the wide range solution.

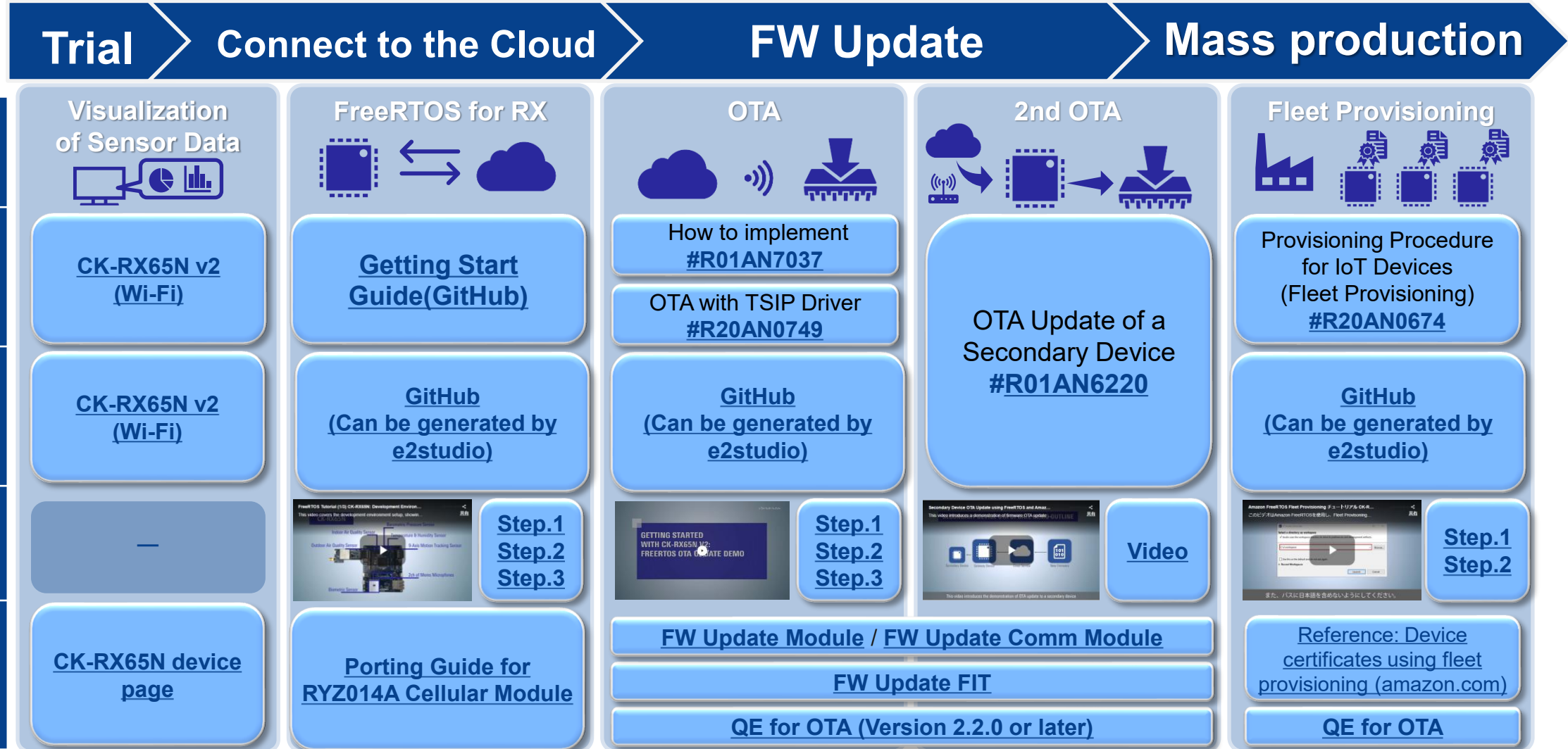

RA CLOUD SOLUTION COLLATERALS MAP

RA can support Seamlessly from starting PoC to MP phase and OTA feature by the wide range solution.

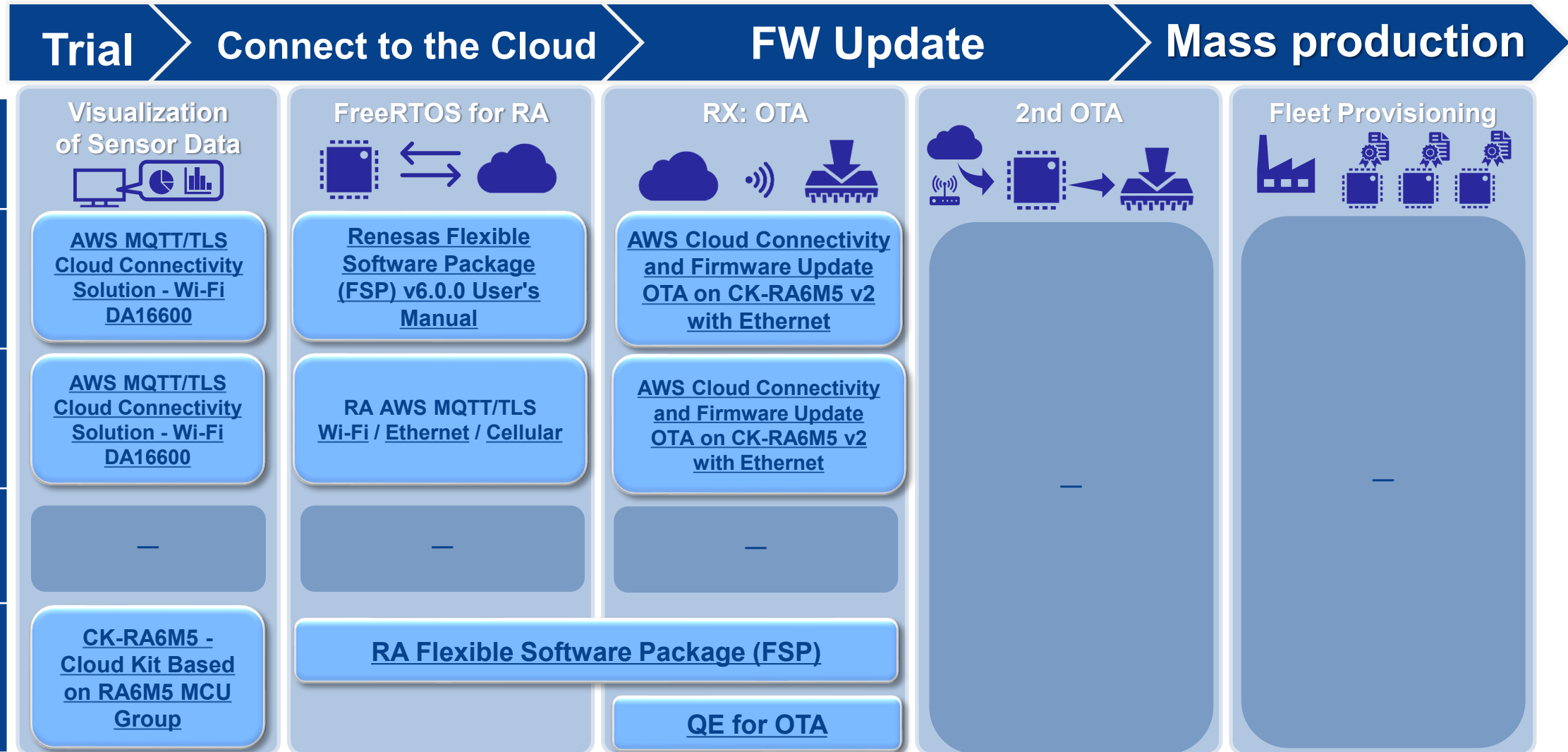

RL78 CLOUD SOLUTION COLLATERALS MAP

RL78 can support Seamlessly from starting PoC to MP phase and OTA feature by the wide range solution.

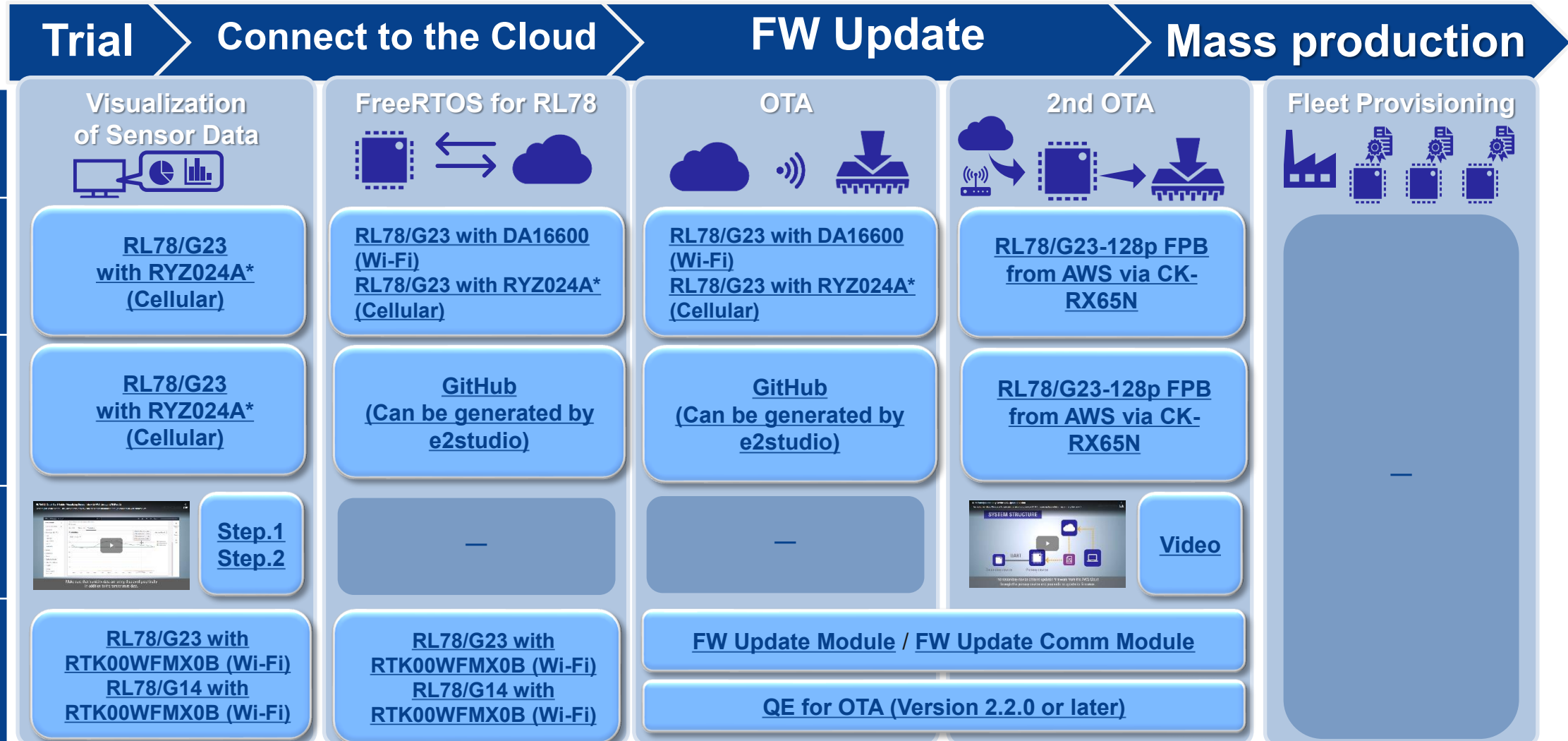

* Note: Cellular part had supported until June/2024, but now became EoL status : ex-RYZ024A(=Sequans/GM02S).

LORA[®]-BASED SOLUTIONS

COVER A WIDE AREA WITH LOW POWER CONSUMPTION

LoRa[®] is a spread spectrum modulation technique derived from chirp spread spectrum (CSS) technology developed by Semtech Corporation. Our LoRa[®]-based solutions use the sub-GHz frequency band of frequencies below 1 GHz, and can **cover a wide area with low power consumption**.

Solution Web Pages



Development Environment

(MCU Evaluation Board + RF Transceiver)

RA MCU:

FPB-RA2E1, EK-RA2L1,
FPB-RA0E1, FPB-RA0E2

RL78 MCU:

FPB-RL78G23-64p, FPB-RL78G23-128p,
FPB-RL78G22, FPB-RL78L23, FPB-RL78G14

* FPB is Fast Prototyping Board



RF Transceiver:
Semtech SX1261/1262 Shield

Software for Ease of Design

- Providing **LoRaWAN[®] protocol stack** compliant with the LoRaWAN[®] specification (Class A/B/C)
- Providing Private LoRa[®]-based network sample and the **radio driver** for custom protocol.
- The **firmware update sample** utilizing LoRaWAN[®] is available.

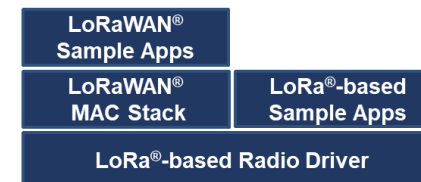

* Please refer to the web-page for the MCU's supported functions.

Power LoRa[®] -based Solutions

- The combination of a low-power microcontroller (**RA2E1, RA2L1, RA0E1, RA0E2, RL78/G23, RL78/G22, RL78/L23, RL78/G14**) and a LoRa[®] transceiver (Semtech SX1261/SX1262)
- The designed communication software for low power consumption achieves a current consumption of less than 1μA

* Please refer to the web page for current consumption

	RA0E1 SX1261	RL78/G23 SX1261
Sleep	0.75 μA	0.55 μA
RX / TX	4.6 / 25.5 mA	4.6 / 25.5 mA

Tools for Ease of RF Characteristics Evaluation

“**Renesas LPWA Studio**” tool that makes RF characteristics evaluation easy

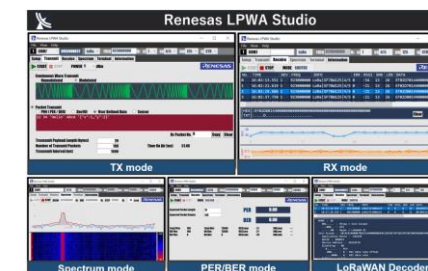

RX SOLUTION

EVK & software

[AWS certified EVK]

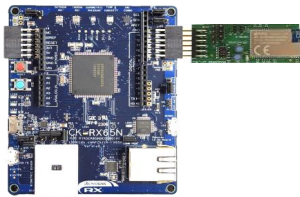

WiFi / Ethernet

For the detailed information, please refer to below page [CK-RX65N web page](#)

- Includes \$10 Credit for AWS IoT by free of charge
- Renesas Wi-Fi PMOD module built-in
- Provides Sample programs and Dashboards for data visualization

[AWS FreeRTOS for cloud connection]

With the Renesas **[RX Driver Package](#)**, the kit has complete software stack support using FreeRTOS and other middleware stacks



- AWS certified FreeRTOS device
- MQTT communication test program
- OTA FW update sample program
- **Fleet Provisioning**

Sample programs

[Various IoT use case application]



- [Sensor data visualization using dashboard](#)



- [OTA FW update for Secondary device which is not directly connected to cloud](#)



- [High speed TLS communication using Trusted Secure IP \(TSIP\) which is security HW IP.](#)

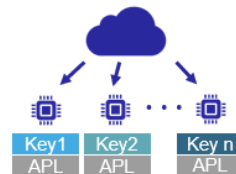

- [RX Family Provisioning Procedure for IoT Devices](#)

Development environment

[Easy to start with e2 studio]



- Generate sample project on e2 studio
- Easy to setup peripherals/pins/RTOS

[OTA assist tool (QE for OTA)]

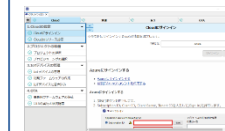

- [Visualize complicated OTA procedure with GUI](#)
- Executed on e2 studio and support from AWS device registration to OTA, and debug
- V2.2.0 supports FW update MCU which is not connected to cloud

[Various tutorial videos]

Videos



RA SOLUTION

EVK & software

[AWS certified EVK]



WiFi / Ethernet

For the detailed information, please refer to below page [CK-RA6M5 web page](#)

- Includes \$10 Credit for AWS IoT by free of charge
- Renesas Wi-Fi PMOD module built-in
- Provides Sample programs and Dashboards for data visualization

[AWS FreeRTOS for cloud connection]

With the Renesas Flexible Software Package (FSP), the kit has complete software stack support using FreeRTOS, Azure RTOS and other middleware stacks

- AWS certified FreeRTOS
- MQTT communication test program
- OTA FW update sample program

Sample programs

[Various IoT use case application]



- [Sensor data visualization using dashboard](#)



- [RA AWS Cloud Connectivity and Firmware Update OTA on CK-RA6M5 v2 with Ethernet](#)



- [RA Flexible Software Package \(FSP\)](#)

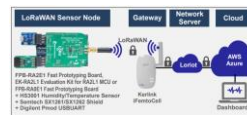

- [RA2E1, RA2L1, RA0E1 LoRaWAN® Sensor Demo Rev.2.50](#)

Development environment

[Easy to start with e2 studio]



- Generate sample project on e2 studio
- Easy to setup peripherals/pins/RTOS

[OTA assist tool (QE for OTA)]

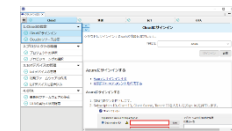

- Visualize complicated OTA procedure with GUI
- Executed on e2 studio and support from AWS device registration to OTA, and debug

RL78 SOLUTION



RL78 Cloud Solution

Evaluation Board

[AWS certified EVK]

FPB-RL78G23 with US159-DA16600EVZ:



- [RL78/G23-128p Fast Prototyping Board](#)
- [US159-DA16600EVZ](#)

FPB-RL78G23 with RTKYZ024A0B00000BE*:



- [RL78/G23-128p Fast Prototyping Board](#)
- [PMOD Expansion Board for RYZ024A](#)

- aws • AWS certified FreeRTOS device
- aws • OTA FW update sample program

[OTA Update of a Secondary MCU]

Ethernet

Firmware Update for non-cloud device via cloud (Ethernet)

- Primary: [CK-RX65N](#)
- Secondary: [RL78/G23-128p Fast Prototyping Board](#)

Sample programs

[Getting Started and application note]

FPB-RL78G23-128p with US159-DA16600EVZ:

AWS Getting Stated:

- [Getting Started Guide for Connecting Amazon Web Services in Wi-Fi Communication: RL78/G23-128p FPB + FreeRTOS](#)

FPB-RL78G23-128p with RTKYZ024A0B00000BE*:

AWS Getting Stated:

- [RL78/G23 Getting Started Guide for Connecting Amazon Web Services in LTE Communication: RL78/G23-128p Fast Prototyping Board + FreeRTOS](#)

OTA Update of a Secondary MCU :

Firmware Update Sample:

- [RL78/G23 Sample Code for OTA Update of a Secondary Device by Amazon Web Services with the Use of FreeRTOS](#)
 - [RL78/G22, RL78/G23, RL78/G24, RL78/L23 Firmware Update Module](#)

Development environment

[Easy to start with e2 studio]



- Generate sample project on e2 studio
- Easy to setup peripherals/pins/RTOS

[OTA assist tool (QE for OTA)]

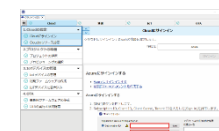

- Visualize complicated OTA procedure with GUI
- Executed on e2 studio and support from AWS device registration to OTA, and debug
- V2.2.0 supports FW update MCU which is not connected to cloud



* Note: Cellular part had supported until June/2024, but now became EoL status : ex-RYZ024A(=Sequans/GM02S).

FAQ

Q. Is it possible to incorporate the evaluation board into the product?

A. This board is intended for user development / evaluation and is not intended to be incorporated into products.

Q. Do I need to register an account to use AWS or Azure?

A. Yes. Not provided by Renesas. Please prepare your own account.

Q. Do I need to get AWS or Azure certification to manufacture and sell products that use AWS or Azure?

A. Not required. Certification is just to show the user that the environment provided by the device vendor ensures a certain level of performance, and it is not necessary to obtain certification for the user's product.

[Renesas.com](https://www.renesas.com)