

RTKA2108332H00000BU

User's Manual: Evaluation Board

Industrial Analog and Power

## 1. Overview

The [RAA210833](#) is a pin-strap configurable 33A step-down PMBus-compliant DC/DC power supply module that integrates a digital PWM controller, synchronous MOSFETs, a power inductor, and passive components. Only input and output capacitors are needed to finish the design. Because of its thermally-enhanced HDA packaging technology, the module can deliver up to 33A of continuous output current without the need for airflow or additional heat sinking. The RAA210833 simplifies configuration and control of Renesas [digital power technology](#) while offering an upgrade path to full PMBus configuration through the pin-compatible ISL8278M.

The RTKA2108332H00000BU evaluation board is a 4in x 4.5in 4-layer FR4 board with 2oz. copper in all layers. The RAA210833 comes with a preprogrammed configuration for operating in a pin-strap mode. Output voltage, switching frequency, input UVLO, soft-start/stop delay and ramp times, and the device SMBus address can be programmed with external pin-strap resistors.

The ZLUSBEVAL3Z (USB to PMBus adapter) is provided with this evaluation board, which connects the evaluation board to a PC to activate the PMBus communication interface. The PMBus command set is accessed by using PowerNavigator™ evaluation software from a PC running Microsoft Windows.

The RTKA2108332H00000BBU can operate in Pin-Strap mode without needing the ZLUSBEVAL3Z adapter or PMBus communication.

### 1.1 Key Features

- $V_{IN}$  range of 4.5V to 14V,  $V_{OUT}$  adjustable from 0.6V to 5V
- Pin-Strap mode for standard settings:  $V_{OUT}$ , switching frequency, input UVLO, soft-start/stop, and external synchronization
- Real-time telemetry for  $V_{IN}$ ,  $V_{OUT}$ ,  $I_{OUT}$ , temperature, duty cycle and switching frequency, and fault logging
- ChargeMode™ control that is tunable with pin-strap resistors or the PMBus interface
- Mechanical switch for enable and the power-good LED indicator

### 1.2 Specifications

This board is configured for the following operating conditions by default:

- $V_{IN}$  = 5V to 12V
- $V_{OUT}$  = 1.2V
- $I_{MAX}$  = 33A
- $f_{SW}$  = 364kHz
- ASCR gain = 250, ASCR residual = 90
- On/off delay = 5ms, on/off ramp time = 5ms
- Input UVLO = 4.2V
- PMBus address = 0x28h

### 1.3 Ordering Information

Part Number	Description
RTKA2108332H00000BU	RAA210833 board (EVB, ZLUSBEVAL3Z adapter, USB cable)

## 1.4 Related Literature

For a full list of related documents, visit our website

- [RAA210833](#) product page

## 1.5 Recommended Equipment

- DC power supply with minimum 15V/25A sourcing capacity
- Electronic load capable of sinking current up to 33A
- Digital Multimeters (DMMs)
- Oscilloscope with higher than 100MHz bandwidth

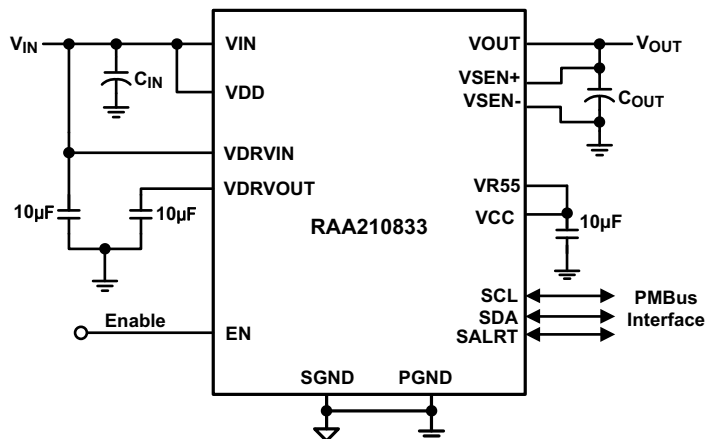

Figure 1. RTKA2108332H00000BU Block Diagram

## 2. Functional Description

The RTKA2108332H00000BU provides all circuitry required to evaluate the features of the RAA210833. A majority of the features of the RAA210833, such as compensation-free ChargeMode control, soft-start delay, ramp times, external clock synchronization, and Bode plot measurement are available on this evaluation board.

[Figure 4 on page 10](#) shows an image of the RTKA2108332H00000BU evaluation board.

### 2.1 Operating Range

By default, the RTKA2108332H00000BU is configured to operate at  $V_{OUT} = 1.2V$ ,  $f_{SW} = 364kHz$ .  $V_{IN}$  ranges from 4.5V to 12V. The board can also support a wider operating range to meet the requirements of specific applications. The  $V_{OUT}$  can be adjusted from 0.6V to 5V. Load current range is from 0A to 33A. Note that airflow across the board may be needed for continuous operation at 33A at elevated ambient temperature. The  $f_{SW}$  and output voltage can also be tuned. However, to ensure sufficient stability margins, the switching frequency and output capacitors should be selected using the “RAA210833 Design Guide Matrix and Output Voltage Response” table in the [RAA210833](#) datasheet.

If the input voltage is less than 5.3V, tie the VCC test point directly to VIN or to a separate 5V power supply for normal operation and best efficiency.

The RTKA2108332H00000BU can handle a 0A to 33A output current transient in which the slew rate is less than 2A/ $\mu$ s, such as an electronic load. If the slew rate exceeds the 2A/ $\mu$ s, it may be necessary to increase the output capacitance or change the VOUT\_OV\_FAULT\_LIMIT and VOUT\_UV\_FAULT\_LIMIT values for proper operation (refer to [“PMBus Option” on page 5](#)).

If external synchronization is used, connect the SYNC test point to the external clock. Note that the external clock signal should be active before the module is enabled.

### 2.2 PMBus Operation

The RTKA2108332H00000BU can be evaluated for all features using the provided ZLUSBEVAL3Z dongle and PowerNavigator. Complete the following steps to evaluate the RAA210833 with the PMBus option.

Install the [PowerNavigator](#) evaluation software from the Renesas website.

For board operation, connect the included ZLUSBEVAL3Z dongle to the 6-pin male connector labeled “PMBus DONGLE IN”. Connect the desired load and an appropriate power supply to the input and connect the included USB cable to the PC running PowerNavigator. Set the ENABLE switch to “DISABLE” before turning on the power.

PowerNavigator allows modification of all RAA210833 PMBus parameters for debugging purposes. The RAA210833 device on the board has been preconfigured as described in this document, but the user can modify the operating parameters through PowerNavigator.

The ENABLE switch can then be moved to “ENABLE” and the RTKA2108332H00000BU board can be tested. Alternately, the PMBus ON\_OFF\_CONFIG and OPERATION commands can be used from PowerNavigator.

### 2.3 Quick Start Guide

#### 2.3.1 Pin-Strap Option

The RTKA2108332H00000BU can be configured in Pin-Strap mode with standard 1% 0603 resistors. The PMBus interface is not required to evaluate the RAA210833 in Pin-Strap mode. Output voltage ( $V_{OUT}$ ), switching frequency ( $f_{SW}$ ), input undervoltage protection (UVLO) threshold, start/stop time delay, ramp time, ASCR settings, and the device PMBus address can be changed by populating the recommended resistors at placeholders provided in the evaluation board. By default, the evaluation board is programmed to regulate at  $V_{OUT} = 1.2V$ ,  $f_{SW} = 364kHz$ ,  $UVLO = 4.2V$ ,  $ASCR\ Gain = 250$ ,  $ACSR\ Residual = 90$ ,  $Ton\_delay = Ton\_rise = Toff\_delay = Toff\_fall = 5ms$ , and PMBus address = 28h.

Complete the following steps to evaluate the RAA210833 in Pin-Strap mode:

- (1) Set the ENABLE switch to “DISABLE”.
- (2) Connect a load to the VOUT lug connectors (J<sub>8</sub> and J<sub>9</sub>).
- (3) Connect a power supply to the VIN connectors (J<sub>1</sub> and J<sub>2</sub>). Make sure the power supply is not enabled when making the connection.
- (4) Adjust V<sub>IN</sub> to 12V and turn the power supply on.
- (5) Set the ENABLE switch to “ENABLE”.
- (6) Measure 1.2V V<sub>OUT</sub> at probe points TP<sub>9</sub> and TP<sub>13</sub>.
- (7) Observe the switching frequency of 364kHz at the probe point labeled VSWH (TP<sub>8</sub>).
- (8) To change V<sub>OUT</sub>, disconnect the board from the setup and populate with a 1% standard 0603 resistor at the R<sub>6</sub> placeholder location on the bottom layer. Refer to the “Output Voltage Resistor Settings” table in the [RAA210833](#) datasheet for recommended values. By default, VOUT\_MAX is set to 110% of V<sub>OUT</sub> set by the pin-strap resistor.
- (9) To change the switching frequency, disconnect the board from the setup and populate with a 1% standard 0603 resistor at the R<sub>2</sub> placeholder location on the bottom layer. Refer to the “Switching Frequency Resistor Settings” table in the [RAA210833](#) datasheet for recommended values.
- (10) To change the Soft-Start/Stop Ramp time or UVLO, disconnect the board from the setup and populate with a 1% standard 0603 resistor at the R<sub>7</sub> placeholder location on the bottom layer. Refer to the “Soft-Start/Stop and Input UVLO Resistor Settings” table or the “UVLO Resistor Settings” table in the [RAA210833](#) datasheet for the recommended values.
- (11) To change the ASCR, disconnect the board from the setup and populate with a 1% standard 0603 resistor at the R<sub>8</sub> placeholder location on the bottom layer. Refer to the “ASCR Resistor Settings” table in the [RAA210833](#) datasheet for the recommended values.

### 2.3.2 PMBus Option

The RTKA2108332H00000BU can be evaluated for all features using the provided ZLUSBEVAL3Z dongle and PowerNavigator. Complete the following steps to evaluate the RAA210833 with the PMBus option.

- (1) Install PowerNavigator.
- (2) Set the ENABLE switch to “DISABLE”.
- (3) Connect a load to the VOUT lug connectors (J<sub>8</sub> and J<sub>9</sub>).
- (4) Connect a power supply to the VIN connectors (J<sub>1</sub> and J<sub>2</sub>). Make sure the power supply is not enabled when making the connection.
- (5) Adjust the V<sub>IN</sub> to 12V and turn the power supply on.
- (6) Connect the ZLUSBEVAL3Z dongle (USB to PMBus adapter) to the RTKA2108332H00000BU board to the 6-pin male connector labeled “PMBus DONGLE IN”.
- (7) Connect the supplied USB cable from the computer through USB to the ZLUSBEVAL3Z dongle.
- (8) Launch PowerNavigator.
- (9) The RAA210833 device on the board operates in Pin-Strap mode from factory default, but the user can modify the operating parameters through PowerNavigator to monitor faults and debug a test case and read real-time values of input/output parameters, switching frequency, duty cycle, and temperature.
- (10) Set the ENABLE switch to “ENABLE”. Alternatively, the PMBus ON\_OFF\_CONFIG and OPERATION commands can be used from PowerNavigator to allow PMBus Enable.
- (11) Monitor and configure the RTKA2108332H00000BU board using the PMBus commands in PowerNavigator. PowerNavigator tutorial videos are available at the Renesas [PowerNavigator](#) website.

## 3. Evaluation Board Information

### 3.1 External Clock Synchronization

The RAA210833 can synchronize to an external clock. External clock synchronization allows the user to operate multiple converters at the same switching frequency and can lead to improved EMI characteristics. The RTKA2108332H00000BU evaluation board can assess this functionality. A function generator is required. Complete the following steps to operate the RAA210833 with an external clock frequency of 593kHz:

- (1) Set the Enable switch to the “DISABLE” position.
- (2) Solder a 17.8k $\Omega$  resistor at RSET on the CFG pin (R<sub>16</sub>).
- (3) Program the function generator to output a continuous square pulse waveform of 593kHz. Program the pulse width to be at least 150ns.
- (4) Ensure that the clock signal is stable by monitoring the waveform on an oscilloscope.
- (5) After verifying clock stability, connect the output cables from the function generator to test point J<sub>4</sub> (labeled “SYNC”).
- (6) Turn the function generator output to “ON”.
- (7) Enable the module by setting the Enable switch to “ENABLE”.
- (8) Observe the switching frequency at test point TP<sub>8</sub> (labeled “VSWH”).
- (9) The module synchronizes to the 593kHz external clock from the function generator.
- (10) Always ensure that the module is disabled before changing the frequency of the external clock.
- (11) A Loss of Sync fault is generated when the external clock is lost.

### 3.2 Bode Plot Measurement

Assessing the stability of the converter is an important step in the design process. Bode plots are a useful and reliable tool to identify the converter’s loop response. Phase margin and gain margin give an insight into the stability of the system, and the bandwidth can indicate how quickly the converter responds to disturbances in input voltage or load transients. Correctly measuring the loop response is critical for designing stable converter systems.

A network analyzer is required to perform the frequency response measurements on the RTKA2108332H00000BU evaluation board. Complete the following steps to evaluate the RAA210833 converter loop response on the RTKA2108332H00000BU evaluation board.

- (1) Break the feedback loop by removing the R<sub>9</sub> resistor in the remote sense path, connected between VSEN+ and VOUT.
- (2) Solder a 20 $\Omega$  resistor in its place. The value of the resistor should be in the range of 10 $\Omega$  to 50 $\Omega$ .
- (3) Solder a twisted wire pair to the 20 $\Omega$  resistor. Ensure that the wires are short in length. A small twisted pair works well by minimizing noise pickup, which is important for a good measurement.
- (4) Enable the module.
- (5) Use a network analyzer to inject a small AC signal (~20mV) across the 20 $\Omega$  resistor as shown in [Figure 2 on page 7](#).
- (6) Measure the amplitudes of the signals at points A and B as shown in [Figure 2](#).
- (7) Sweep the frequency using the network analyzer to observe the bandwidth, phase, and gain margin.



time, the peak current drawn at any given moment is reduced, and the power losses proportional to the  $I_{RMS}^2$  are reduced dramatically.

To enable phase spreading in a multi-module operation, all converters must be synchronized to the same switching clock. The phase offset of each device can be set to any value between  $0^\circ$  and  $360^\circ$  in  $22.5^\circ$  increments by choosing the device PMBus address from the “Interleave Settings from SA” table in the [RAA210833](#) datasheet. The lower four bits of the PMBUS address set the value of the INTERLEAVE command. To implement Interleave functionality for a two module operation, complete the following steps:

- (1) Choose SA (SMBus Address) for Module 1 and Module 2 from the “Interleave Settings from SA” table in the [RAA210833](#) datasheet based on the desired phase difference. Populate the corresponding RSET for SA ( $R_5$ ) according to the [RAA210833](#) datasheet.  
For example, when Module 1 has SA = 28h (INTERLEAVE = 8,  $180^\circ$  phase shift from the rising edge of the external clock) and Module 2 has SA=24h (INTERLEAVE = 4,  $90^\circ$  phase shift from the rising edge of the external clock), the net phase difference between Module 1 and Module 2 is  $90^\circ$  ( $180^\circ - 90^\circ$ ).
- (2) Populate RSET on CFG for both boards to synchronize to an external clock source of a particular switching frequency based on the “External Frequency SYNC Settings” table in the [RAA210833](#) datasheet.
- (3) Connect the power supply to the VIN connectors (VIN/GND) on both boards.
- (4) Connect the ZLUSBEVAL3Z dongle to the 6-pin male connector labeled “PMBus DONGLE In” to one of the boards.
- (5) Daisy chain the second board to the first board by connecting “PMBus DONGLE Out” of the first board to the “PMBus DONGLE In” of the second board.
- (6) Provide an external clock on the SYNC pins of the two boards from a function generator. The external clock frequency from the function generator should be within  $\pm 10\%$  of the listed options shown in the “External Frequency SYNC Settings” table in the [RAA210833](#) datasheet. The incoming clock signal must be stable before the enable pin is asserted. The external clock signal must not vary more than 10% from its initial value and should have a minimum pulse width of 150ns.
- (7) Turn the input power supply on. Next, set the ENABLE switch to the “ENABLE” position.
- (8) Monitor the VSWH node at the probe point labeled VSWH (TP8) on the two boards using an oscilloscope to verify the phase spread set. This functionality can also be verified using the INTERLEAVE command in PowerNavigator.

Note that every module gets assigned a unique Rail ID based on the SA setting. This can be observed in the Power Map window of PowerNavigator.



## 4. PCB Layout Guidelines

To achieve stable operation, low losses, and good thermal performance, some layout considerations are necessary.

The key features of the RTKA2108332H00000BU layout are:

- Establish separate SGND and PGND planes, then connect the SGND plane to the PGND plane in the middle layer. To make connections between SGND/PGND on the top layer and other layers, use multiple vias for each pin to connect to the inner SGND/PGND layers. Do not connect SGND directly to PGND on a top layer. Connecting SGND directly to PGND without establishing the SGND plane bypasses the decoupling capacitor at the internal reference supplies, making the controller susceptible to noise.
- Place enough ceramic capacitors between VIN and PGND and VOUT and PGND. Bypass capacitors between VDD and the ground plane, as close to the module as possible to minimize high-frequency noise.
- Use large copper areas for a power path (VIN, PGND, and VOUT) to minimize conduction loss and thermal stress. Use multiple vias to connect the power planes in different layers. Extra ceramic capacitors at VIN and VOUT can be placed on the bottom layer under the VIN and VOUT pads when using multiple vias to connect copper pads on the top and bottom layers.
- Connect differential remote sensing traces to the regulation point to achieve a tight output voltage regulation. Route a trace from VSEN+ and VSEN- to the point-of-load where tight output voltage is desired. Avoid routing any sensitive signal traces, such as the VSENSE signal, near the VSWH pads.
- For noise sensitive applications, Renesas recommends connecting the VSWH pads only on the top layer; however, thermal performance is sacrificed. External airflow might be required to keep module heat at desired levels. For applications in which switching noise is less critical, excellent thermal performance can be achieved in this power module by increasing the copper mass attached to the VSWH pad. To increase copper mass on the VSWH node, create copper islands in the middle and bottom layers under the VSWH pad and connect them to the top layer with multiple vias. Shield those copper islands with a PGND layer to avoid any interference to noise sensitive signals.

### 4.1 Thermal Considerations and Current Derating

Board layout is critical for safe module operation and maximum allowable power delivery. To work in high temperature environments and carry large currents, the board layout needs to be carefully designed to maximize thermal performance. To achieve this, select enough trace width, copper weight, and the proper connectors.

The RTKA2108332H00000BU evaluation board is designed for running 33A at room temperature without additional cooling systems. However, if the output voltage is increased or the board is operated at elevated temperatures, then the available current is derated. Refer to the derated current curves in the [RAA210833](#) datasheet to determine the maximum output current the evaluation board can supply.  $\theta_{JA}$  is measured by inserting a thermocouple inside the module to measure peak junction temperature.

## 4.2 Board Pictures

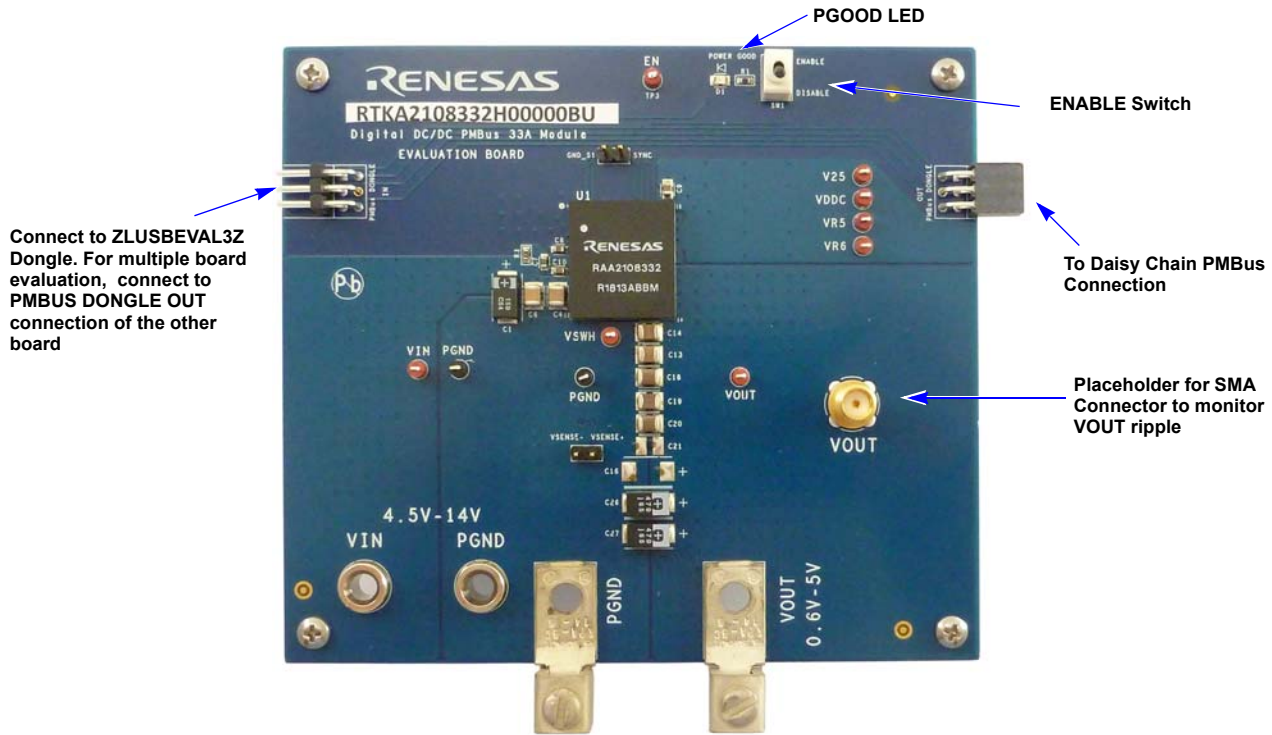

Figure 4. RTKA2108332H00000BU Evaluation Board (Top Side)

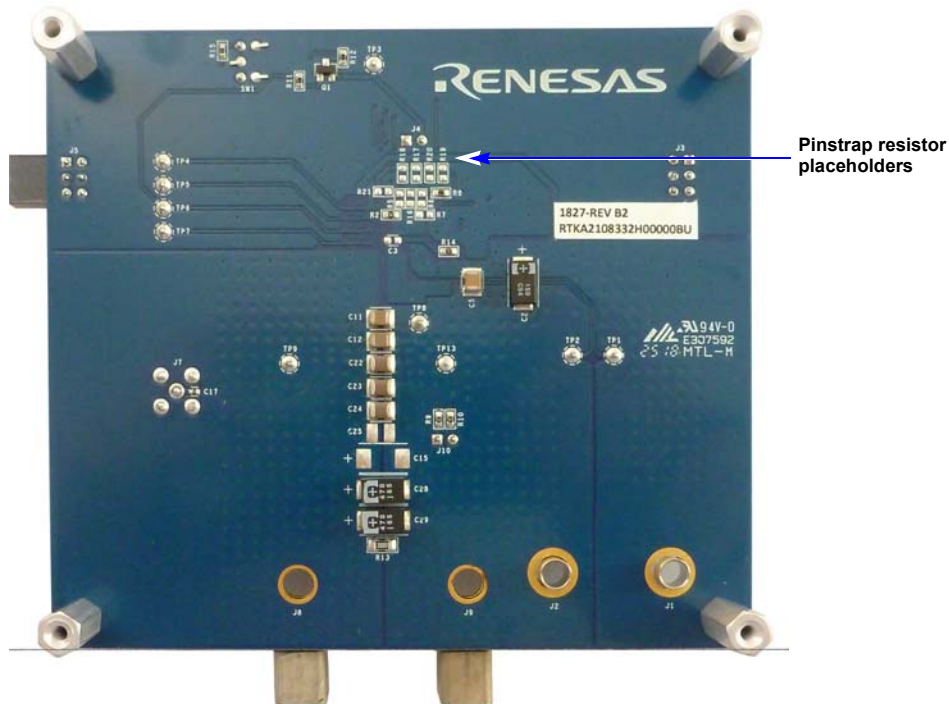

Figure 5. RTKA2108332H00000BU Evaluation Board (Bottom Side)

### 4.3 RTKA2108332H00000BU Board Schematic

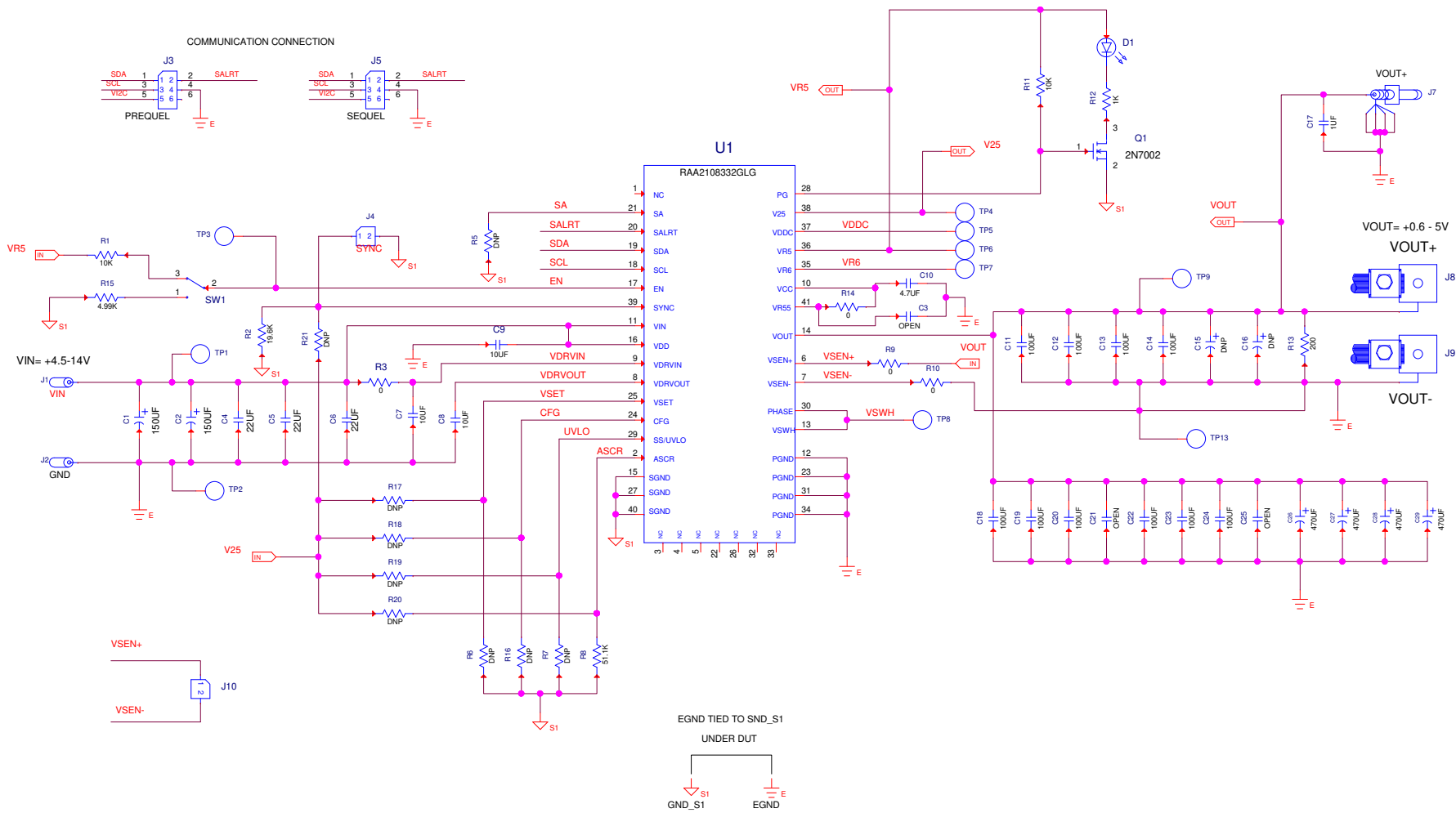

Figure 6. Schematic

#### 4.4 Bill of Materials

Qty	Reference Designator	Description	Manufacturer	Manufacturer Part
1		PCB, RTKA2108332H00000BU, ROHS	Renesas	PCB, RTKA2108332H00000BU
2	C1, C2	CAP-POSCAP, SMD, 7.3x4.3, 150µF, 16V, 20%, 50mΩ, ROHS	Sanyo/ Panasonic	16TQC150MYF
4	C26, C27, C28, C29	CAP TANT POLY 470µF, 6.3V, 20%, 18mΩ 2917, ROHS	Sanyo	6TPE470MI
2	C15, C16	DO NOT POPULATE_PLACE HOLDER		
10	C11, C12, C13, C14, C18, C19, C20, C22, C23, C24	CAP CER 100µF, 6.3V, 20%, X5R, 1210, ROHS	TDK	C3225X5R0J107M
2	C7, C8	CAP CER 10µF, 16V, 20%, X5R, 0603, ROHS	Murata	GRM188R61C106MA73D
1	C10	CAP CER 4.7µF, 16V, 10%, X5R, 0603, ROHS	Murata	GRM188R61C475KAAJD
3	C4, C5, C6	CAP CER 22µF, 25V, 10%, X7R, 1210, ROHS	Murata	GRM32ER71E226KE15L
1	C17	CAP CER 1µF, 6.3V, 10%, X5R, 0402, ROHS	Panasonic	ECJ-0EB0J105K
1	C3	DO NOT POPULATE_PLACE HOLDER		
1	C9	CAP CER 10µF, 25V, 10%, X5R, 0805, ROHS	TDK	C2012X5R1E106K
2	C21, C25	DO NOT POPULATE_PLACE HOLDER		
9	R5, R6, R7, R16, R17, R18, R19, R20, R21	DO NOT POPULATE_PLACE HOLDER		
4	R3, R9, R10, R14	RES SMD 0Ω JUMPER, 1/10W, 0603, ROHS	Panasonic	ERJ-3GEY0R00V
1	R12	RES SMD 1kΩ, 1%, 1/10W, 0603, ROHS	Panasonic	ERJ-3EKF1001V
2	R1, R11	RES SMD 10kΩ, 1%, 1/10W, 0603, ROHS	Panasonic	ERJ-3EKF1002V
1	R2	RES SMD 19.6kΩ, 1%, 1/10W, 0603, ROHS	Panasonic	ERJ-3EKF1962V
1	R15	RES SMD 4.99kΩ, 1%, 1/10W, 0603, ROHS	Panasonic	ERJ-3EKF4991V
1	R8	RES SMD 51.1kΩ, 1%, 1/10W, 0603, ROHS	Panasonic	ERJ-3EKF5112V
1	R13	RES SMD 200Ω, 1%, 1/4W, 1206, ROHS	Panasonic	ERJ-8ENF2000V
1	U1	33A Digital DC/DC PMBus Power Supply Module, ROHS	Renesas	RAA2108332GLG
1	D1	LED, SMD, 0805, GREEN, CLEAR, 10mcd, 2.1V, 20mA, 570nm, ROHS	Chicago Miniature Lamp	CMD17-21VGC-TR8
1	Q1	MOSFET N-CH 60V 115MA SOT-23, ROHS	Fairchild	2N7002

Qty	Reference Designator	Description	Manufacturer	Manufacturer Part
1	SW1	SWITCH-TOGGLE, THRU-HOLE, SPDT, 5P, ROHS	C&K	GT11MCBE
8	TP1, TP3, TP4, TP5, TP6, TP7, TP8, TP9	CONN-MINI TEST PT, VERTICAL, RED, ROHS	Keystone	5000
2	TP2, TP13	CONN-MINI TEST PT, VERTICAL, BLK, ROHS	Keystone	5001
2	J1, J2	CONN-JACK, MINI BANANA, 0.175 PLUG, NICKEL/BRASS, ROHS	Keystone	575-4
2	J8, J9	HDWARE, MTG, CABLE TERMINAL, 6-14AWG, LUG&SCREW, ROHS	Burndy	KPA8CTP
1	J5	CONN-SOCKET STRIP, TH, 2x3, 2.54mm, TIN, R/A, ROHS	Samtec	SSQ-103-02-T-D-RA
2	J4, J10	CONN HEADER 2POS .100" SNGL, ROHS	Samtec	TSW-102-07-F-S
1	J3	CONN-HEADER, 2x3, BRKAWY, 2.54mm, TIN, R/A, ROHS	Samtec	TSW-103-08-T-D-RA
1	J7	SMA Straight Jack Receptacle, ROHS	Johnson Components	142-0711-231

### 4.5 RTKA2108332H00000BU Board Layout

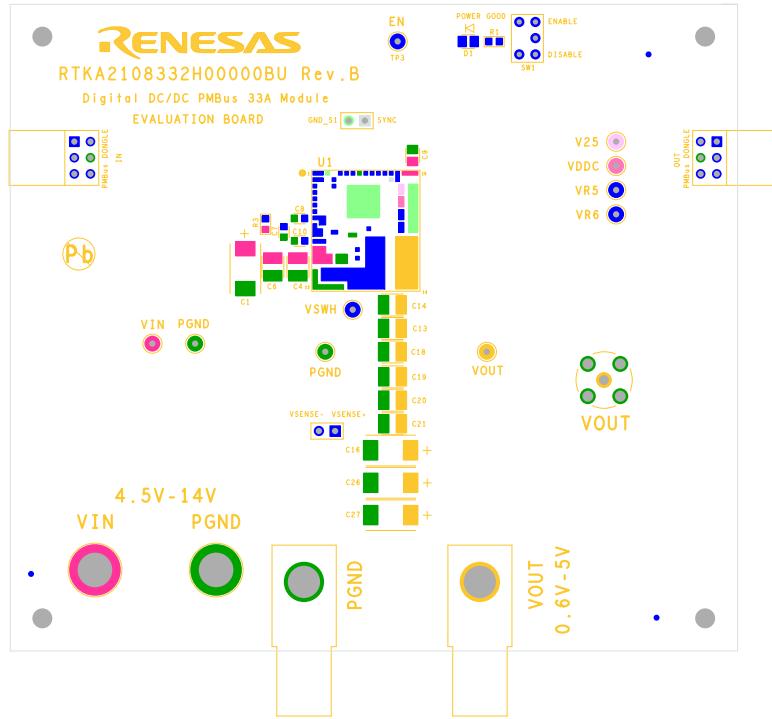

Figure 7. Silkscreen Top

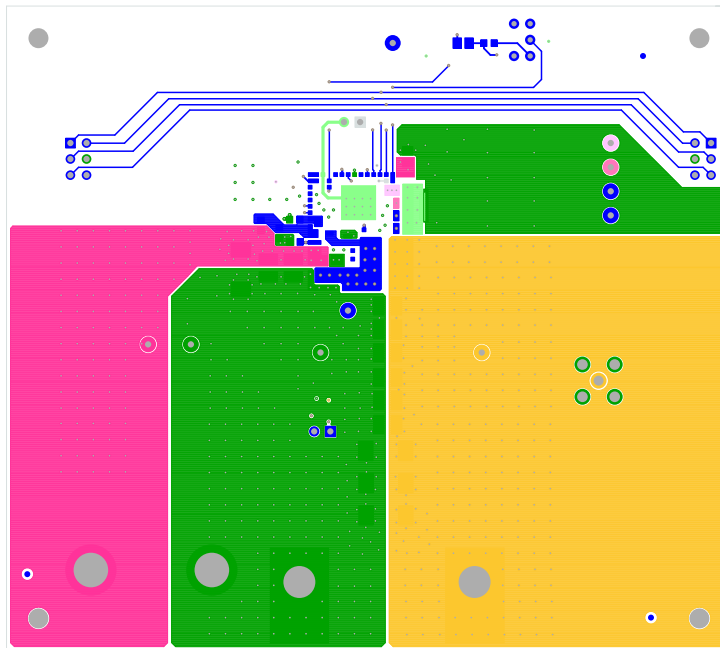

Figure 8. PCB - Top Layer Component Side

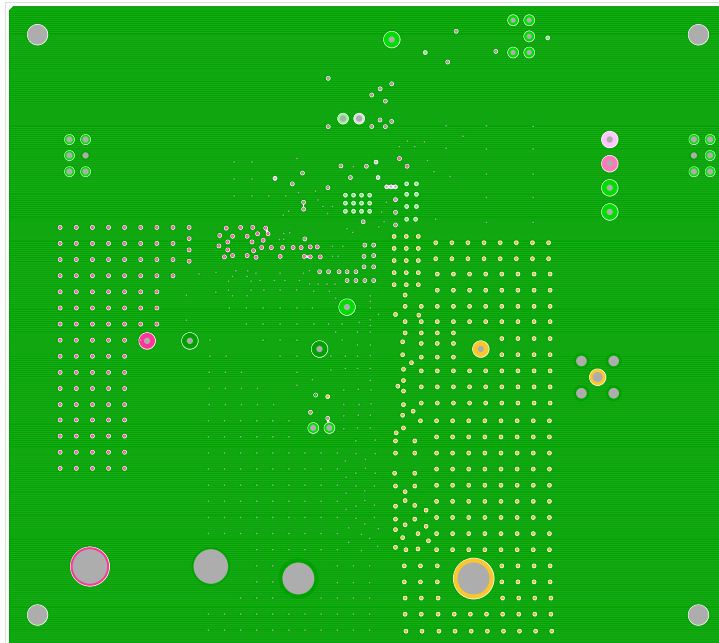

Figure 9. PCB - Layer 2

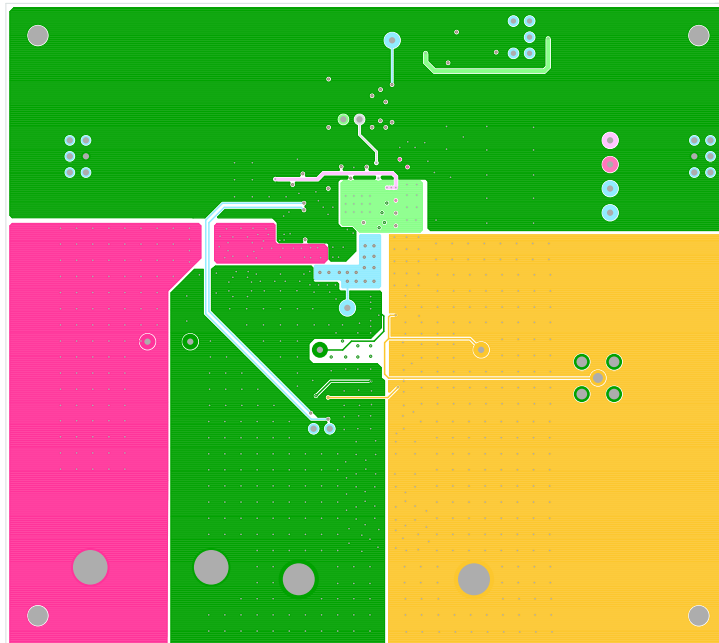

Figure 10. PCB - Layer 3

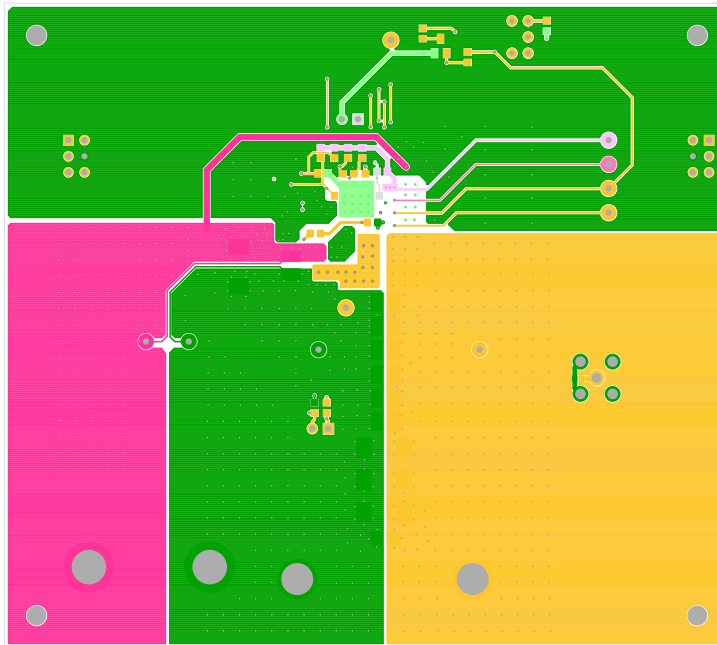

Figure 11. PCB - Layer 4 (Bottom Layer Solder Side)

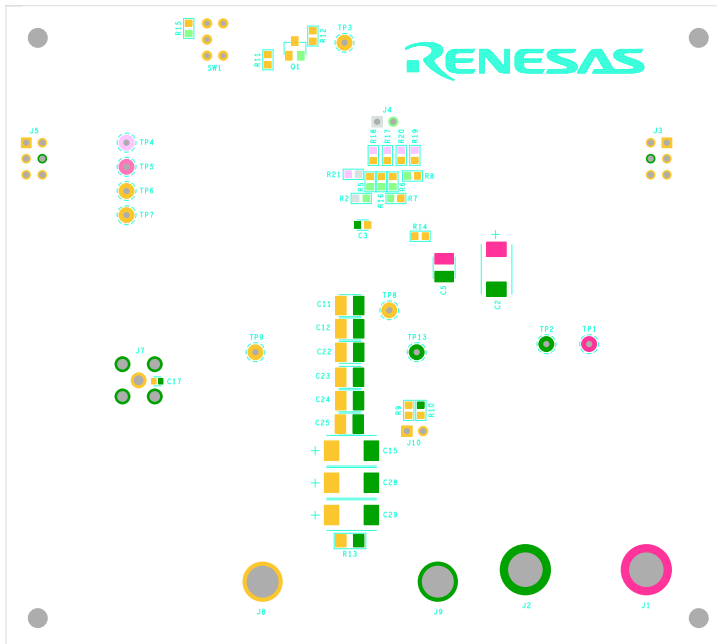

Figure 12. Silkscreen Bottom



### 5. Typical Performance Curves

The following data was acquired using an RTKA2108332H00000BU evaluation board.

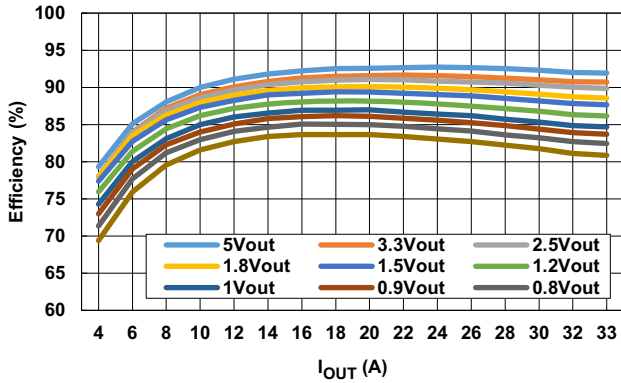

Figure 13. Efficiency vs Output Current at  $V_{IN} = 12V$  and  $f_{SW} = 364kHz$  for Various Output Voltages

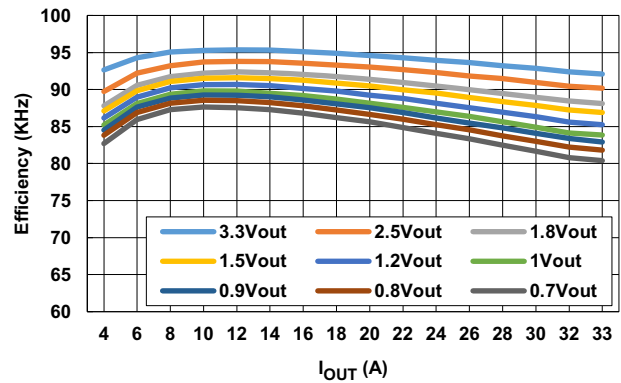

Figure 14. Efficiency vs Output Current at  $V_{IN} = 5V$  and  $f_{SW} = 364kHz$  for Various Output Voltages

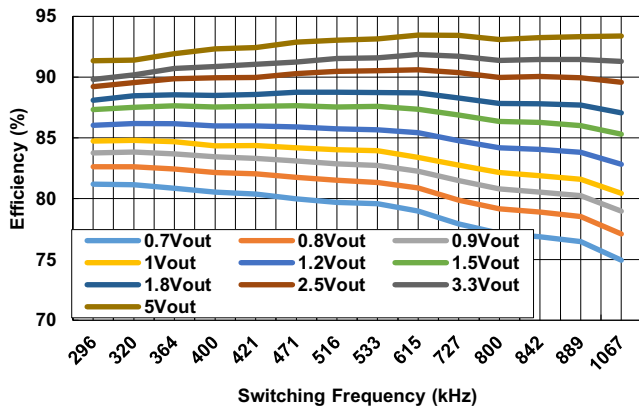

Figure 15. Efficiency vs Switching Frequency at  $V_{IN} = 12V$  and  $I_{OUT} = 33A$  for Various Output Voltages

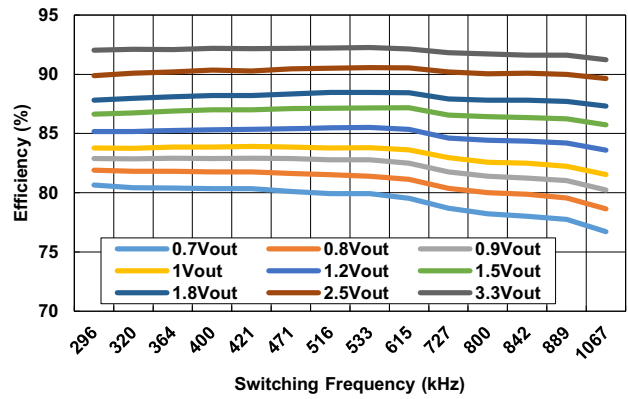

Figure 16. Efficiency vs Switching Frequency at  $V_{IN} = 5V$  and  $I_{OUT} = 33A$  for Various Output Voltages

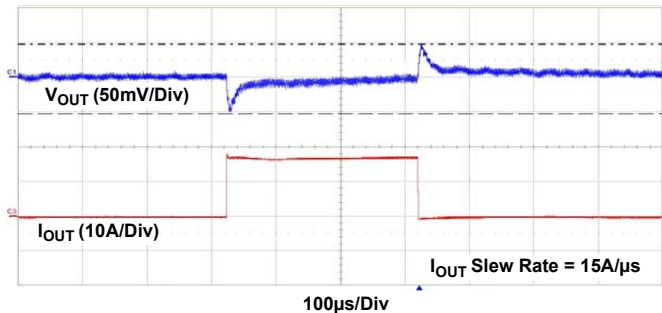

Figure 17.  $5V_{IN}$  to  $1.2V_{OUT}$ ,  $f_{SW} = 364kHz$ ,  $C_{OUT} = 10x100\mu F$  Ceramic +  $4x470\mu F$  POSCAP, ASCR Residual = 90, ASCR Gain = 250

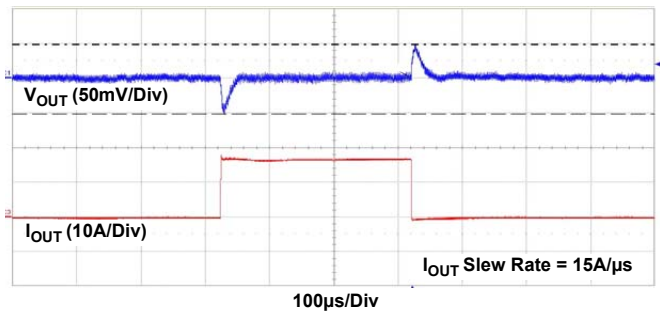

Figure 18.  $12V_{IN}$  to  $1.2V_{OUT}$ ,  $f_{SW} = 364kHz$ ,  $C_{OUT} = 10x100\mu F$  Ceramic +  $4x470\mu F$  POSCAP, ASCR Residual = 90, ASCR Gain = 250

The following data was acquired using an RTKA2108332H00000BU evaluation board. (Continued)

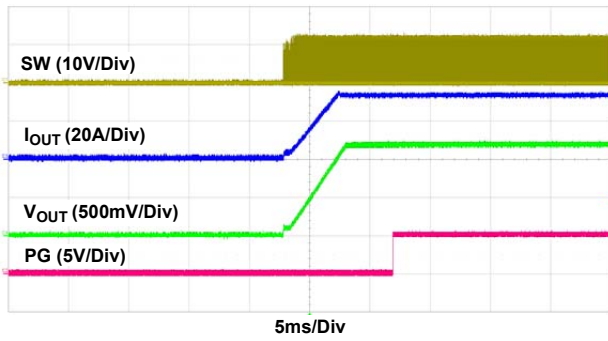

Figure 19. Startup at 12V<sub>IN</sub>, 1.2V<sub>OUT</sub>, 33A

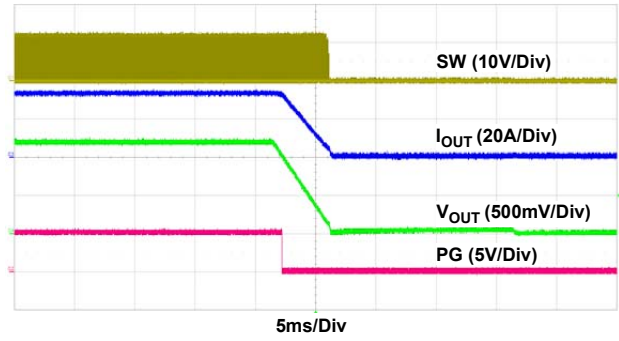

Figure 20. Soft-Off at 12V<sub>IN</sub>, 1.2V<sub>OUT</sub>, 33A

## 6. Revision History

Rev.	Date	Description
0.00	Sep 12, 2018	Initial release

## Notice

1. Descriptions of circuits, software and other related information in this document are provided only to illustrate the operation of semiconductor products and application examples. You are fully responsible for the incorporation or any other use of the circuits, software, and information in the design of your product or system. Renesas Electronics disclaims any and all liability for any losses and damages incurred by you or third parties arising from the use of these circuits, software, or information.
2. Renesas Electronics hereby expressly disclaims any warranties against and liability for infringement or any other claims involving patents, copyrights, or other intellectual property rights of third parties, by or arising from the use of Renesas Electronics products or technical information described in this document, including but not limited to, the product data, drawings, charts, programs, algorithms, and application examples.
3. No license, express, implied or otherwise, is granted hereby under any patents, copyrights or other intellectual property rights of Renesas Electronics or others.
4. You shall not alter, modify, copy, or reverse engineer any Renesas Electronics product, whether in whole or in part. Renesas Electronics disclaims any and all liability for any losses or damages incurred by you or third parties arising from such alteration, modification, copying or reverse engineering.
5. Renesas Electronics products are classified according to the following two quality grades: "Standard" and "High Quality". The intended applications for each Renesas Electronics product depends on the product's quality grade, as indicated below.  
"Standard": Computers; office equipment; communications equipment; test and measurement equipment; audio and visual equipment; home electronic appliances; machine tools; personal electronic equipment; industrial robots; etc.  
"High Quality": Transportation equipment (automobiles, trains, ships, etc.); traffic control (traffic lights); large-scale communication equipment; key financial terminal systems; safety control equipment; etc.  
Unless expressly designated as a high reliability product or a product for harsh environments in a Renesas Electronics data sheet or other Renesas Electronics document, Renesas Electronics products are not intended or authorized for use in products or systems that may pose a direct threat to human life or bodily injury (artificial life support devices or systems; surgical implantations; etc.), or may cause serious property damage (space system; undersea repeaters; nuclear power control systems; aircraft control systems; key plant systems; military equipment; etc.). Renesas Electronics disclaims any and all liability for any damages or losses incurred by you or any third parties arising from the use of any Renesas Electronics product that is inconsistent with any Renesas Electronics data sheet, user's manual or other Renesas Electronics document.
6. When using Renesas Electronics products, refer to the latest product information (data sheets, user's manuals, application notes, "General Notes for Handling and Using Semiconductor Devices" in the reliability handbook, etc.), and ensure that usage conditions are within the ranges specified by Renesas Electronics with respect to maximum ratings, operating power supply voltage range, heat dissipation characteristics, installation, etc. Renesas Electronics disclaims any and all liability for any malfunctions, failure or accident arising out of the use of Renesas Electronics products outside of such specified ranges.
7. Although Renesas Electronics endeavors to improve the quality and reliability of Renesas Electronics products, semiconductor products have specific characteristics, such as the occurrence of failure at a certain rate and malfunctions under certain use conditions. Unless designated as a high reliability product or a product for harsh environments in a Renesas Electronics data sheet or other Renesas Electronics document, Renesas Electronics products are not subject to radiation resistance design. You are responsible for implementing safety measures to guard against the possibility of bodily injury, injury or damage caused by fire, and/or danger to the public in the event of a failure or malfunction of Renesas Electronics products, such as safety design for hardware and software, including but not limited to redundancy, fire control and malfunction prevention, appropriate treatment for aging degradation or any other appropriate measures. Because the evaluation of microcomputer software alone is very difficult and impractical, you are responsible for evaluating the safety of the final products or systems manufactured by you.
8. Please contact a Renesas Electronics sales office for details as to environmental matters such as the environmental compatibility of each Renesas Electronics product. You are responsible for carefully and sufficiently investigating applicable laws and regulations that regulate the inclusion or use of controlled substances, including without limitation, the EU RoHS Directive, and using Renesas Electronics products in compliance with all these applicable laws and regulations. Renesas Electronics disclaims any and all liability for damages or losses occurring as a result of your noncompliance with applicable laws and regulations.
9. Renesas Electronics products and technologies shall not be used for or incorporated into any products or systems whose manufacture, use, or sale is prohibited under any applicable domestic or foreign laws or regulations. You shall comply with any applicable export control laws and regulations promulgated and administered by the governments of any countries asserting jurisdiction over the parties or transactions.
10. It is the responsibility of the buyer or distributor of Renesas Electronics products, or any other party who distributes, disposes of, or otherwise sells or transfers the product to a third party, to notify such third party in advance of the contents and conditions set forth in this document.
11. This document shall not be reprinted, reproduced or duplicated in any form, in whole or in part, without prior written consent of Renesas Electronics.
12. Please contact a Renesas Electronics sales office if you have any questions regarding the information contained in this document or Renesas Electronics products.  
(Note 1) "Renesas Electronics" as used in this document means Renesas Electronics Corporation and also includes its directly or indirectly controlled subsidiaries.  
(Note 2) "Renesas Electronics product(s)" means any product developed or manufactured by or for Renesas Electronics.

(Rev.4.0-1 November 2017)



### SALES OFFICES

Renesas Electronics Corporation

<http://www.renesas.com>

Refer to "<http://www.renesas.com/>" for the latest and detailed information.

**California Eastern Laboratories, Inc.**  
4590 Patrick Henry Drive, Santa Clara, California 95054-1817, U.S.A.  
Tel: +1-408-919-2500, Fax: +1-408-988-0279

**Renesas Electronics Canada Limited**  
9251 Yonge Street, Suite 8309 Richmond Hill, Ontario Canada L4C 9T3  
Tel: +1-905-237-2004

**Renesas Electronics Europe Limited**  
Dukes Meadow, Millboard Road, Bourne End, Buckinghamshire, SL8 5FH, U.K  
Tel: +44-1628-651-700

**Renesas Electronics Europe GmbH**  
Arcadiastrasse 10, 40472 Düsseldorf, Germany  
Tel: +49-211-6503-0, Fax: +49-211-6503-1327

**Renesas Electronics (China) Co., Ltd.**  
Room 1709 Quantum Plaza, No.27 ZhichunLu, Haidian District, Beijing, 100191 P. R. China  
Tel: +86-10-8235-1155, Fax: +86-10-8235-7679

**Renesas Electronics (Shanghai) Co., Ltd.**  
Unit 301, Tower A, Central Towers, 555 Langao Road, Putuo District, Shanghai, 200333 P. R. China  
Tel: +86-21-2226-0888, Fax: +86-21-2226-0999

**Renesas Electronics Hong Kong Limited**  
Unit 1601-1611, 16/F., Tower 2, Grand Century Place, 193 Prince Edward Road West, Mongkok, Kowloon, Hong Kong  
Tel: +852-2265-6688, Fax: +852 2886-9022

**Renesas Electronics Taiwan Co., Ltd.**  
13F, No. 363, Fu Shing North Road, Taipei 10543, Taiwan  
Tel: +886-2-8175-9600, Fax: +886 2-8175-9670

**Renesas Electronics Singapore Pte. Ltd.**  
80 Bendemeer Road, Unit #06-02 Hyflux Innovation Centre, Singapore 339949  
Tel: +65-6213-0200, Fax: +65-6213-0300

**Renesas Electronics Malaysia Sdn.Bhd.**  
Unit 1207, Block B, Menara Amcorp, Amcorp Trade Centre, No. 18, Jln Persiaran Barat, 46050 Petaling Jaya, Selangor Darul Ehsan, Malaysia  
Tel: +60-3-7955-9390, Fax: +60-3-7955-9510

**Renesas Electronics India Pvt. Ltd.**  
No.77C, 100 Feet Road, HAL 2nd Stage, Indiranagar, Bangalore 560 038, India  
Tel: +91-80-67208700, Fax: +91-80-67208777

**Renesas Electronics Korea Co., Ltd.**  
17F, KAMCO Yangjae Tower, 262, Gangnam-daero, Gangnam-gu, Seoul, 06265 Korea  
Tel: +82-2-558-3737, Fax: +82-2-558-5338

RTKA2108332H00000BU

