

To our customers,

---

## Old Company Name in Catalogs and Other Documents

---

On April 1<sup>st</sup>, 2010, NEC Electronics Corporation merged with Renesas Technology Corporation, and Renesas Electronics Corporation took over all the business of both companies. Therefore, although the old company name remains in this document, it is a valid Renesas Electronics document. We appreciate your understanding.

Renesas Electronics website: <http://www.renesas.com>

April 1<sup>st</sup>, 2010  
Renesas Electronics Corporation

Issued by: Renesas Electronics Corporation (<http://www.renesas.com>)

Send any inquiries to <http://www.renesas.com/inquiry>.

## Notice

1. All information included in this document is current as of the date this document is issued. Such information, however, is subject to change without any prior notice. Before purchasing or using any Renesas Electronics products listed herein, please confirm the latest product information with a Renesas Electronics sales office. Also, please pay regular and careful attention to additional and different information to be disclosed by Renesas Electronics such as that disclosed through our website.
2. Renesas Electronics does not assume any liability for infringement of patents, copyrights, or other intellectual property rights of third parties by or arising from the use of Renesas Electronics products or technical information described in this document. No license, express, implied or otherwise, is granted hereby under any patents, copyrights or other intellectual property rights of Renesas Electronics or others.
3. You should not alter, modify, copy, or otherwise misappropriate any Renesas Electronics product, whether in whole or in part.
4. Descriptions of circuits, software and other related information in this document are provided only to illustrate the operation of semiconductor products and application examples. You are fully responsible for the incorporation of these circuits, software, and information in the design of your equipment. Renesas Electronics assumes no responsibility for any losses incurred by you or third parties arising from the use of these circuits, software, or information.
5. When exporting the products or technology described in this document, you should comply with the applicable export control laws and regulations and follow the procedures required by such laws and regulations. You should not use Renesas Electronics products or the technology described in this document for any purpose relating to military applications or use by the military, including but not limited to the development of weapons of mass destruction. Renesas Electronics products and technology may not be used for or incorporated into any products or systems whose manufacture, use, or sale is prohibited under any applicable domestic or foreign laws or regulations.
6. Renesas Electronics has used reasonable care in preparing the information included in this document, but Renesas Electronics does not warrant that such information is error free. Renesas Electronics assumes no liability whatsoever for any damages incurred by you resulting from errors in or omissions from the information included herein.
7. Renesas Electronics products are classified according to the following three quality grades: “Standard”, “High Quality”, and “Specific”. The recommended applications for each Renesas Electronics product depends on the product’s quality grade, as indicated below. You must check the quality grade of each Renesas Electronics product before using it in a particular application. You may not use any Renesas Electronics product for any application categorized as “Specific” without the prior written consent of Renesas Electronics. Further, you may not use any Renesas Electronics product for any application for which it is not intended without the prior written consent of Renesas Electronics. Renesas Electronics shall not be in any way liable for any damages or losses incurred by you or third parties arising from the use of any Renesas Electronics product for an application categorized as “Specific” or for which the product is not intended where you have failed to obtain the prior written consent of Renesas Electronics. The quality grade of each Renesas Electronics product is “Standard” unless otherwise expressly specified in a Renesas Electronics data sheets or data books, etc.
  - “Standard”: Computers; office equipment; communications equipment; test and measurement equipment; audio and visual equipment; home electronic appliances; machine tools; personal electronic equipment; and industrial robots.
  - “High Quality”: Transportation equipment (automobiles, trains, ships, etc.); traffic control systems; anti-disaster systems; anti-crime systems; safety equipment; and medical equipment not specifically designed for life support.
  - “Specific”: Aircraft; aerospace equipment; submersible repeaters; nuclear reactor control systems; medical equipment or systems for life support (e.g. artificial life support devices or systems), surgical implantations, or healthcare intervention (e.g. excision, etc.), and any other applications or purposes that pose a direct threat to human life.
8. You should use the Renesas Electronics products described in this document within the range specified by Renesas Electronics, especially with respect to the maximum rating, operating supply voltage range, movement power voltage range, heat radiation characteristics, installation and other product characteristics. Renesas Electronics shall have no liability for malfunctions or damages arising out of the use of Renesas Electronics products beyond such specified ranges.
9. Although Renesas Electronics endeavors to improve the quality and reliability of its products, semiconductor products have specific characteristics such as the occurrence of failure at a certain rate and malfunctions under certain use conditions. Further, Renesas Electronics products are not subject to radiation resistance design. Please be sure to implement safety measures to guard them against the possibility of physical injury, and injury or damage caused by fire in the event of the failure of a Renesas Electronics product, such as safety design for hardware and software including but not limited to redundancy, fire control and malfunction prevention, appropriate treatment for aging degradation or any other appropriate measures. Because the evaluation of microcomputer software alone is very difficult, please evaluate the safety of the final products or system manufactured by you.
10. Please contact a Renesas Electronics sales office for details as to environmental matters such as the environmental compatibility of each Renesas Electronics product. Please use Renesas Electronics products in compliance with all applicable laws and regulations that regulate the inclusion or use of controlled substances, including without limitation, the EU RoHS Directive. Renesas Electronics assumes no liability for damages or losses occurring as a result of your noncompliance with applicable laws and regulations.
11. This document may not be reproduced or duplicated, in any form, in whole or in part, without prior written consent of Renesas Electronics.
12. Please contact a Renesas Electronics sales office if you have any questions regarding the information contained in this document or Renesas Electronics products, or if you have any other inquiries.

(Note 1) “Renesas Electronics” as used in this document means Renesas Electronics Corporation and also includes its majority-owned subsidiaries.

(Note 2) “Renesas Electronics product(s)” means any product developed or manufactured by or for Renesas Electronics.



# User's Manual

# QB-78K0IX2

## In-Circuit Emulator

---

### Target Devices

**78K0/IY2**

**78K0/IA2**

**78K0/IB2**

Document No. U19513EJ1V0UM00 (1st edition)  
Date Published November 2008 NS

© NEC Electronics Corporation 2008  
Printed in Japan

[MEMO]

**IECUBE is a registered trademark of NEC Electronics Corporation in Japan and Germany.**

• **The information in this document is current as of November, 2008. The information is subject to change without notice. For actual design-in, refer to the latest publications of NEC Electronics data sheets or data books, etc., for the most up-to-date specifications of NEC Electronics products. Not all products and/or types are available in every country. Please check with an NEC Electronics sales representative for availability and additional information.**

- No part of this document may be copied or reproduced in any form or by any means without the prior written consent of NEC Electronics. NEC Electronics assumes no responsibility for any errors that may appear in this document.
- NEC Electronics does not assume any liability for infringement of patents, copyrights or other intellectual property rights of third parties by or arising from the use of NEC Electronics products listed in this document or any other liability arising from the use of such products. No license, express, implied or otherwise, is granted under any patents, copyrights or other intellectual property rights of NEC Electronics or others.
- Descriptions of circuits, software and other related information in this document are provided for illustrative purposes in semiconductor product operation and application examples. The incorporation of these circuits, software and information in the design of a customer's equipment shall be done under the full responsibility of the customer. NEC Electronics assumes no responsibility for any losses incurred by customers or third parties arising from the use of these circuits, software and information.
- While NEC Electronics endeavors to enhance the quality, reliability and safety of NEC Electronics products, customers agree and acknowledge that the possibility of defects thereof cannot be eliminated entirely. To minimize risks of damage to property or injury (including death) to persons arising from defects in NEC Electronics products, customers must incorporate sufficient safety measures in their design, such as redundancy, fire-containment and anti-failure features.
- NEC Electronics products are classified into the following three quality grades: "Standard", "Special" and "Specific".

The "Specific" quality grade applies only to NEC Electronics products developed based on a customer-designated "quality assurance program" for a specific application. The recommended applications of an NEC Electronics product depend on its quality grade, as indicated below. Customers must check the quality grade of each NEC Electronics product before using it in a particular application.

"Standard": Computers, office equipment, communications equipment, test and measurement equipment, audio and visual equipment, home electronic appliances, machine tools, personal electronic equipment and industrial robots.

"Special": Transportation equipment (automobiles, trains, ships, etc.), traffic control systems, anti-disaster systems, anti-crime systems, safety equipment and medical equipment (not specifically designed for life support).

"Specific": Aircraft, aerospace equipment, submersible repeaters, nuclear reactor control systems, life support systems and medical equipment for life support, etc.

The quality grade of NEC Electronics products is "Standard" unless otherwise expressly specified in NEC Electronics data sheets or data books, etc. If customers wish to use NEC Electronics products in applications not intended by NEC Electronics, they must contact an NEC Electronics sales representative in advance to determine NEC Electronics' willingness to support a given application.

(Note)

- (1) "NEC Electronics" as used in this statement means NEC Electronics Corporation and also includes its majority-owned subsidiaries.
- (2) "NEC Electronics products" means any product developed or manufactured by or for NEC Electronics (as defined above).

[MEMO]

## General Precautions for Handling This Product

### 1. Circumstances not covered by product guarantee

- If the product was disassembled, altered, or repaired by the customer
- If it was dropped, broken, or given another strong shock
- Use at overvoltage, use outside guaranteed temperature range, storing outside guaranteed temperature range
- If power was turned on while connection to the AC adapter, USB interface cable, or target system was in an unsatisfactory state
- If the cable of the AC adapter, the USB interface cable, the emulation probe, or the like was bent or pulled excessively
- When using an AC adapter (QB-COMMON-PW-xx) not supported in the region of use
- If the product got wet
- If this product is connected to the target system when there is a potential difference between the GND of this product and GND of the target system.
- If the connectors or cables are plugged/unplugged while this product is in the power-on state.
- If excessive load is applied to the connectors or sockets (As for handling, please see **2.5 Mounting and Connecting Connectors**).
- If a metal part of the power switch, cooling fan, or another such part comes in contact with an electrostatic charge.
- If the product is used or stored in an environment where an electrostatic or electrical noise is likely to occur.

### 2. Safety precautions

- If used for a long time, the product may become hot (50°C to 60°C). Be careful of low temperature burns and other dangers due to the product becoming hot.
- Be careful of electrical shock. There is a danger of electrical shock if the product is used as described above in **1. Circumstances not covered by product guarantee**.

## INTRODUCTION

**Readers** This manual is intended for users who wish to perform debugging using the QB-78K0IX2. The readers of this manual are assumed to be familiar with the device functions and usage, and to have knowledge of debuggers.

**Purpose** This manual is intended to give users an understanding of the basic specifications and correct usage of the QB-78K0IX2.

**Organization** This manual is divided into the following sections.

- General
- Setup procedure
- Settings at product shipment
- Notes

**How to Read This Manual** It is assumed that the readers of this manual have general knowledge in the fields of electrical engineering, logic circuits, and microcontrollers.

This manual describes the basic setup procedures and how to set switches.

To understand the overall functions and usages of the QB-78K0IX2

→ Read this manual in the order of the **CONTENTS**.

To know the manipulations, command functions, and other software-related settings of the QB-78K0IX2

→ See the user's manual of the debugger (supplied with the QB-78K0IX2) to be used.

|                    |  |  |
|--------------------|--|--|
| <b>Conventions</b> | <b>Note:</b>   | Footnote for item marked with <b>Note</b> in the text      |
|                    | <b>Caution:</b>  | Information requiring particular attention                 |
|                    | <b>Remark:</b>   | Supplementary information                                  |
|                    | Numeric representation:  | Binary ... xxxx or xxxxB                                   |
|                    |  | Decimal ... xxxx   |
|                    |  | Hexadecimal ... xxxxH                                      |
|                    | Prefix indicating power of 2<br>(address space, memory<br>capacity): | K (kilo): $2^{10} = 1,024$<br>M (mega): $2^{20} = 1,024^2$ |



## Terminology

The meanings of the terms used in this manual are described in the table below.

| Term          | Meaning   |
|---------------|---|
| Target device | This is the device to be emulated.  |
| Target system | This is the system to be debugged.<br>This includes the target program and the hardware provided by the user. |
| 78K0/Ix2      | Generic name indicating 78K0/IY2, 78K0/IA2 78K0/IB2.  |
| IECUBE™       | Generic name for NEC Electronics' high-performance/compact in-circuit emulator.                               |

## Related Documents

Please use the following documents in conjunction with this manual.

The related documents listed below may include preliminary versions. However, preliminary versions are not marked as such.

### Documents Related to Development Tools (User's Manuals)

| Document Name                           |                              | Document Number |
|---|------------------------------|-----------------|
| QB-78K0IX2 In-Circuit Emulator          |                              | This manual     |
| RA78K0 Assembler Package Ver. 3.80      | Operation                    | U17199E         |
|   | Language                     | U17198E         |
|   | Structured Assembly Language | U17197E         |
| CC78K0 C Compiler Ver. 3.70             | Operation                    | U17201E         |
|   | Language                     | U17200E         |
| ID78K0-QB Integrated Debugger Ver. 3.00 | Operation                    | U18492E         |
| PM plus Ver. 6.30                       |                              | U18416E         |

**Caution** The related documents listed above are subject to change without notice. Be sure to use the latest version of each document for designing, etc.

# CONTENTS

|   |           |
|---|-----------|
| <b>CHAPTER 1 GENERAL</b> .....  | <b>9</b>  |
| 1.1 Hardware Specifications .....   | 10        |
| 1.2 System Specifications.....  | 11        |
| 1.3 System Configuration .....  | 12        |
| 1.4 System Configuration for Each Target Device.....                        | 14        |
| 1.5 Package Contents .....  | 15        |
| 1.6 AC Adapter for IECUBE.....  | 16        |
| <b>CHAPTER 2 SETUP PROCEDURE</b> .....                                      | <b>17</b> |
| 2.1 Names and Functions of Hardware.....                                    | 18        |
| 2.2 Removal of Acrylic Board .....  | 20        |
| 2.3 Clock Settings.....   | 21        |
| 2.4 Software Settings .....   | 23        |
| 2.5 Mounting and Connecting Connectors .....                                | 24        |
| 2.5.1 Mounting TC to target system (socket that has at least 30 pins) ..... | 24        |
| 2.5.2 Mounting TC to target system (socket that has less than 30 pins)..... | 25        |
| 2.5.3 Mounting YQ to TC (socket that has at least 30 pins).....             | 26        |
| 2.5.4 Plugging EA into YQ (socket that has at least 30 pins).....           | 26        |
| 2.5.5 Plugging EA into TC (socket that has less than 30 pins).....          | 26        |
| 2.5.6 Precautions for handling TC, YQ, SA, and CA .....                     | 27        |
| 2.5.7 Precautions for mounting IC using TC and MA .....                     | 28        |
| 2.6 Connecting QB-78K0IX2 to Target System .....                            | 29        |
| 2.7 Notes on Power Supply and GND Pin Connection .....                      | 31        |
| 2.8 Connecting USB Interface Cable and AC Adapter.....                      | 32        |
| 2.9 Switching Power On and Off .....  | 32        |
| <b>CHAPTER 3 SETTINGS AT PRODUCT SHIPMENT</b> .....                         | <b>33</b> |
| <b>CHAPTER 4 NOTES</b> .....  | <b>34</b> |

## CHAPTER 1 GENERAL

The QB-78K0IX2 is an in-circuit emulator for emulating the 78K0/lx2.

Hardware and software can be debugged efficiently in the development of systems in which the 78K0/lx2 is used. This manual describes basic setup procedures, hardware specifications, system specifications, and how to set switches.

## 1.1 Hardware Specifications

Table 1-1. QB-78K0IX2 Hardware Specifications

| Parameter                   |                                       | Specification   |
|-----------------------------|---------------------------------------|---|
| Target device               |                                       | 78K0/IY2, 78K0/IA2, 78K0/IB2  |
| Operating voltage           |                                       | 1.8 to 5.5 V  |
| Operating frequency         | Main system clock                     | $2.7\text{ V} \leq V_{DD} \leq 5.5\text{ V}$ : 1 to 10 MHz <sup>Note</sup>    |
|                             | Internal high-speed oscillation clock | $2.7\text{ V} \leq V_{DD} \leq 5.5\text{ V}$ : 1, 2, 4, 8 MHz <sup>Note</sup> |
| Operating temperature range |                                       | 0 to 40°C (No condensation)   |
| Storage temperature range   |                                       | -15 to 60°C (No condensation)   |
| External dimensions         |                                       | See figure below  |
| Power consumption           | Target system power supply            | Voltage: 1.8 to 5.5 V<br>Maximum current consumption: Approx. 3 mA            |
|                             | Weight                                | Approx. 300 g   |
| Host interface              |                                       | USB interface (1.1, 2.0)  |

**Note** Only a PLL used at 4 MHz can be used.

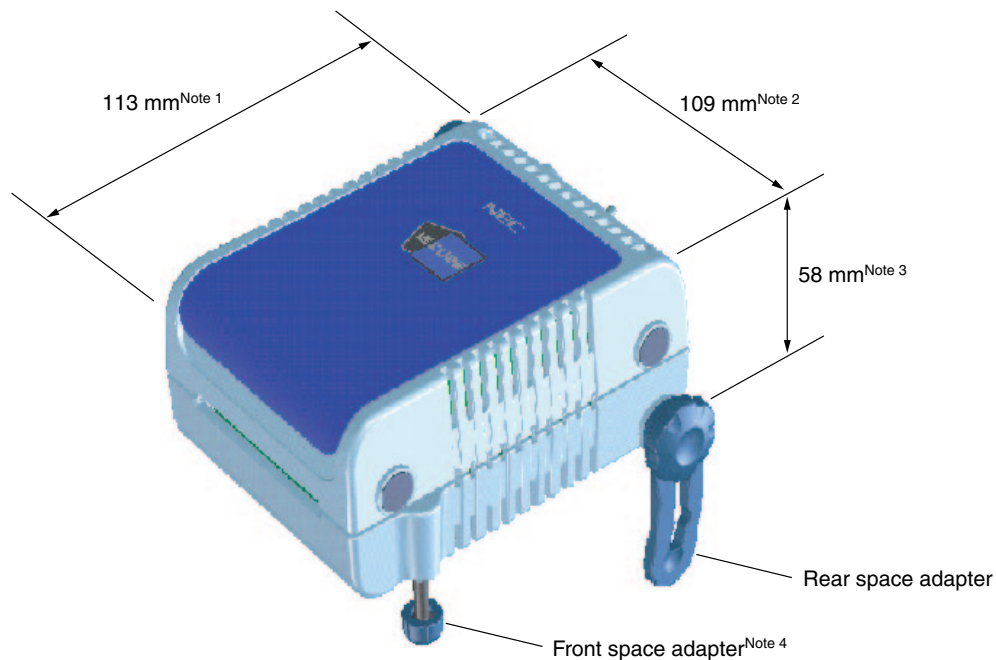

- Notes**
- Does not include projection of power switch
  - Includes projection of screw that fixes rear space adapter
  - Rear space adapter can adjust the height from 30 mm (longest) to 0 mm (shortest)
  - Front space adapter can adjust the height from 20 mm (longest) to 5 mm (shortest)

## 1.2 System Specifications

This section shows the QB-78K0IX2 system specifications.

**Table 1-2. QB-78K0IX2 System Specifications**

| Parameter                         |                                  | Specification  |
|-----------------------------------|----------------------------------|--|
| Emulation memory capacity         | Internal ROM                     | 512 KB (MAX.)  |
|                                   | Internal RAM                     | 61 KB (MAX.)   |
| Program execution functions       | Real-time execution function     | Go, Start from Here, Come Here, Restart, Return Out, Ignore break points and Go  |
|                                   | Non-real-time execution function | Step In, Next Over, Slowmotion, Go & Go  |
| Memory manipulation               |                                  | Available (initialize, copy, compare)  |
| Register manipulation             |                                  | Available (general-purpose registers, control registers, SFRs)   |
| Disassemble function              |                                  | Available  |
| Local variable view               |                                  | Local variables  |
| Watch data view                   |                                  | Local variables, global variables, or else   |
| Stack trace view                  |                                  | Available  |
| Event functions                   | Execution                        | 8 points   |
|                                   | Access                           | 10 points<br>(exclusively for bytes: 8 points, exclusively for words: 2 points)  |
| Break functions                   | Software break                   | 2000 points  |
|                                   | Hardware break                   | Before execution: 16 points<br>After execution: 8 points<br>Access: 10 points  |
|                                   | Fail-safe break                  | Non-map, write protect, SFR illegal access, stack overflow, or else  |
|                                   | Other                            | Forcible break, trace full break, trace delay break, timeout break, timer overflow break   |
| Trace functions                   | Trace data types                 | Program address, program data, access address, access data, status, time tag   |
|                                   | Trace modes                      | Unconditional trace, section trace, qualify trace, delay trigger trace   |
|                                   | Trace functions                  | Non-stop, full stop, full break, delay trigger stop, delay trigger break   |
|                                   | Memory capacity                  | 128K frames  |
| Real-time RAM monitoring function |                                  | All internal RAM spaces  |
| Time measurement functions        | Measurement clock                | 50 MHz (Minimum resolution: 20 ns)   |
|                                   | Measurement objects              | Start through end of program execution<br>Start event through end event  |
|                                   | Maximum measurement time         | Approx. 48 hours and 50 minutes (Resolution: 41 $\mu$ s)   |
|                                   | Number of timers for measurement | Start through end of program execution: 1<br>Start event through end event: 2  |
|                                   | Measurement results              | Execution time (start through end of execution)<br>Maximum, minimum, average, total, pass count (between events)   |
|                                   | Other                            | Timer overflow break function, timeout break function  |
| Other functions                   |                                  | Command functions set in the console, mapping function, event function, coverage function, snapshot function, DMM function, power-off emulation function, pin mask function, flash self programming emulation function |

### 1.3 System Configuration

This section shows the system configuration when using the QB-78K0IX2. Connection is possible even without optional products.

Figure 1-1. System Configuration

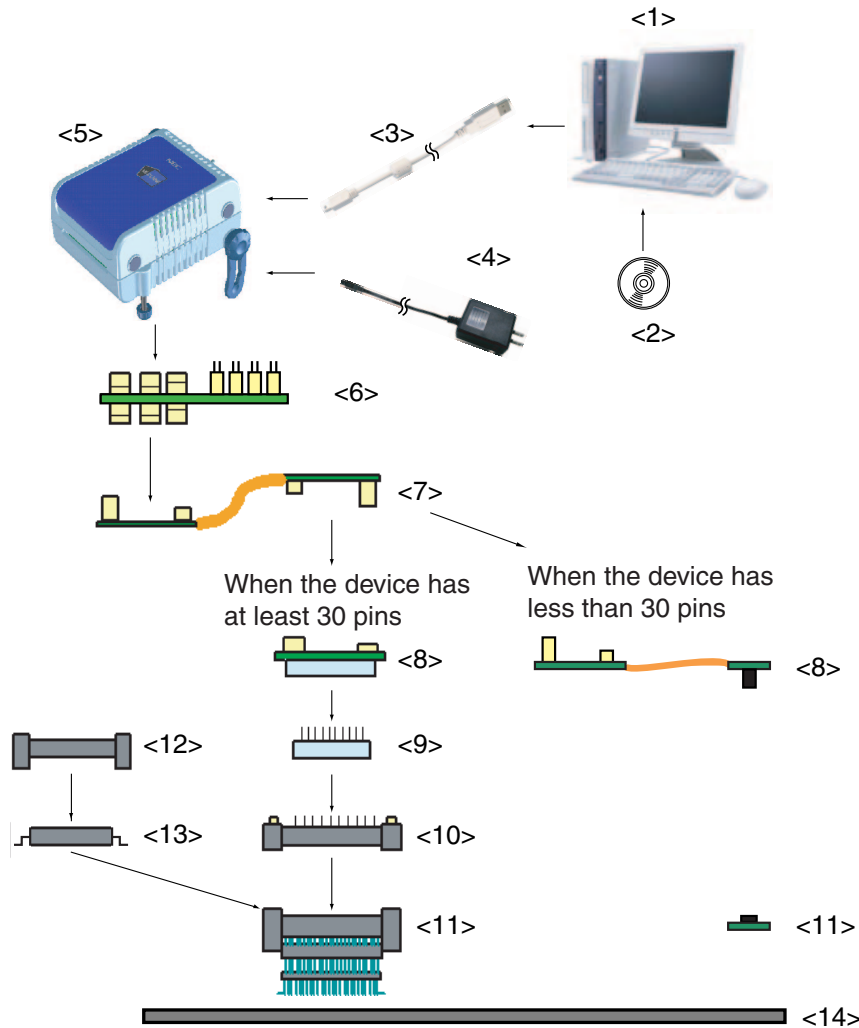

- |                                   |  |
|-----------------------------------|--|
| <1> Host machine                  | : Product provided with USB port                               |
| <2> ID78K0-QB Disk/Accessory Disk | : Debugger, USB drivers, manual, etc.                          |
| <3> USB interface cable           | : Cable connecting QB-78K0IX2 to host machine                  |
| <4> AC adapter                    | : AC adapters classified by region                             |
| <5> QB-78K0IX2                    | : This product   |
| <6> Check pin adapter (optional)  | : Adapter used for monitoring waveforms with oscilloscope      |
| <7> Emulation probe               | : Flexible type of emulation probe                             |
| <8> Exchange adapter              | : Adapter that performs pin conversion                         |
| <9> Space adapter (optional)      | : Adapter used for height adjustment                           |
| <10> YQ connector                 | : Connector that connects exchange adapter to target connector |
| <11> Target connector             | : Connector soldered to target system                          |
| <12> Mount adapter (optional)     | : Adapter used for mounting target device into socket          |
| <13> Device                       | : Target device  |
| <14> Target system                |  |

- Remarks 1.** Obtain device files from the NEC Electronics website.  
<http://www.necel.com/micro/en/ods/index.html>
2. Refer to **1.5 Package Contents** for the purchase forms of the above products.
  3. As for handling of connectors, refer to **2.5 Mounting and Connecting Connectors**.
  4. The part number of <4> differs depending on the region of use. See **Table 1-5 Part Numbers of AC Adapter for IECUBE Classified by Region** for the part numbers. The IECUBE requires an AC adapter that must be purchased separately.
  5. See **Table 1-4 Common Probe and Adapter** for the part numbers of <6> and <7>.
  6. The combination of <8>, <9>, <10>, <11>, and <12> varies depending on the emulation device. See **Table 1-3 Adapters and Connectors for Each Target Device** for the combinations.

## 1.4 System Configuration for Each Target Device

The following table lists the system configuration for each target device of the QB-78K0IX2.

**Table 1-3. Adapters and Connectors for Each Target Device**

| Target Device | Package        | Exchange Adapter   | YQ Connector  | Target Connector                                      | Mount Adaptor   | Space Adaptor   |
|---------------|----------------|--|---|---|---|---|
| 78K0/IY2      | 16 pin<br>SSOP | QB-78K0IY2-EA-01T<br>(sold separately) <sup>Note 1</sup> | <b>Note 2</b>   | QB-16GR-NQ-01T<br>(sold separately) <sup>Note 1</sup> | <b>Note 2</b>   | <b>Note 2</b>   |
| 78K0/IA2      | 20 pin<br>SSOP | QB-78K0IA2-EA-01T<br>(sold separately) <sup>Note 1</sup> | <b>Note 2</b>   | QB-20MC-NQ-01T<br>(sold separately) <sup>Note 1</sup> | <b>Note 2</b>   | <b>Note 2</b>   |
| 78K0/IB2      | 30 pin<br>SSOP | QB-78K0IB2-EA-01T<br>(sold separately) <sup>Note 1</sup> | QB-30MC-YQ-01T<br>(sold separately) <sup>Note 1</sup> | QB-30MC-NQ-01T<br>(sold separately) <sup>Note 1</sup> | QB-30MC-HQ-01T<br>(sold separately) <sup>Note 1</sup> | QB-30MC-YS-01T<br>(sold separately) <sup>Note 1</sup> |

**Table 1-4. Common Probe and Adapter**

| Name              | Part Number                                    |
|-------------------|--|
| Check pin adapter | QB-144-CA-01 (sold separately)                 |
| Emulation probe   | QB-80-EP-01T (sold separately) <sup>Note</sup> |

**Notes 1.** The adapter/connector and common probe/adapter for each target device are sold separately, but some products include an exchange adapter, YQ connector, target connector, and emulation probe, depending on the ordering code. See **1.5 Package Contents** for details.

**2.** There is no space adapter, mount adapter, or YQ connector in a configuration of less than 30 pins.

**Remark** See the following URL for package drawings of the connectors, adapters, and probes.  
<http://www.necel.com/micro/en/development/asia/Emulator/IE/iecube.html>



## 1.5 Package Contents

The following items have been placed in the QB-78K0IX2 packing box. Please check the contents.

### Products supplied with QB-78K0IX2-ZZZ

- 1: QB-78K0IX2
- 2: USB interface cable (2 meters)
- 3: Online user registration card (warranty card and software contract in one)
- 4: ID78K0-QB Disk (CD-ROM)
- 5: Accessory Disk (CD-ROM)
- 6: IECUBE Setup Manual (Japanese/English)
- 7: Packing list
- 8: QB-MINI2

### Products supplied with QB-78K0IX2-T16GR

- 1 to 8
- 9: Emulation probe QB-80-EP-01T
- 10: Exchange adapter QB-78K0IY2-EA-01T
- 12: Target connector QB-16GR-NQ-01T

### Products supplied with QB-78K0IX2-T20MC

- 1 to 8
- 9: Emulation probe QB-80-EP-01T
- 10: Exchange adapter QB-78K0IA2-EA-01T
- 12: Target connector QB-20MC-NQ-01T

### Products supplied with QB-78K0IX2-T30MC

- 1 to 8
- 9: Emulation probe QB-80-EP-01T
- 10: Exchange adapter QB-78K0IB2-EA-01T
- 11: YQ connector QB-30MC-YQ-01T
- 12: Target connector QB-30MC-NQ-01T

## 1.6 AC Adapter for IECUBE

The specifications of the AC adapter for IECUBE differ depending on the region of use.  
Be sure to use an AC adapter corresponding to the region of use.

The IECUBE is not provided with an AC adapter.  
It must be purchased separately.

**Table 1-5. Part Numbers of AC Adapter for IECUBE Classified by Region**

| Product                         | Destination (Region) <sup>Notes 1,2</sup> | Part Number <sup>Note 3</sup> |
|---------------------------------|---|-------------------------------|
| AC adapter<br>(sold separately) | Japan                                     | QB-COMMON-PW-JP               |
|                                 | USA                                       | QB-COMMON-PW-EA               |
|                                 | China                                     | QB-COMMON-PW-CN               |
|                                 | Hong Kong                                 | QB-COMMON-PW-HK               |
|                                 | South Korea                               | QB-COMMON-PW-KR               |
|                                 | Singapore                                 | QB-COMMON-PW-SG               |
|                                 | Taiwan                                    | QB-COMMON-PW-TW               |

- Notes**
1. Products are shipped only on order from each region.
  2. Contact a distributor or an NEC Electronics sales representative for information on regions other than the above.
  3. Only the AC adapter usable in each region can be ordered.

## CHAPTER 2 SETUP PROCEDURE

This chapter explains the QB-78K0IX2 setup procedure.

Setup can be completed by performing installation setup in the order in which it appears in this chapter.

Perform setup along the lines of the following procedure.

See **2.1 Names and Functions of Hardware** for clock positions.

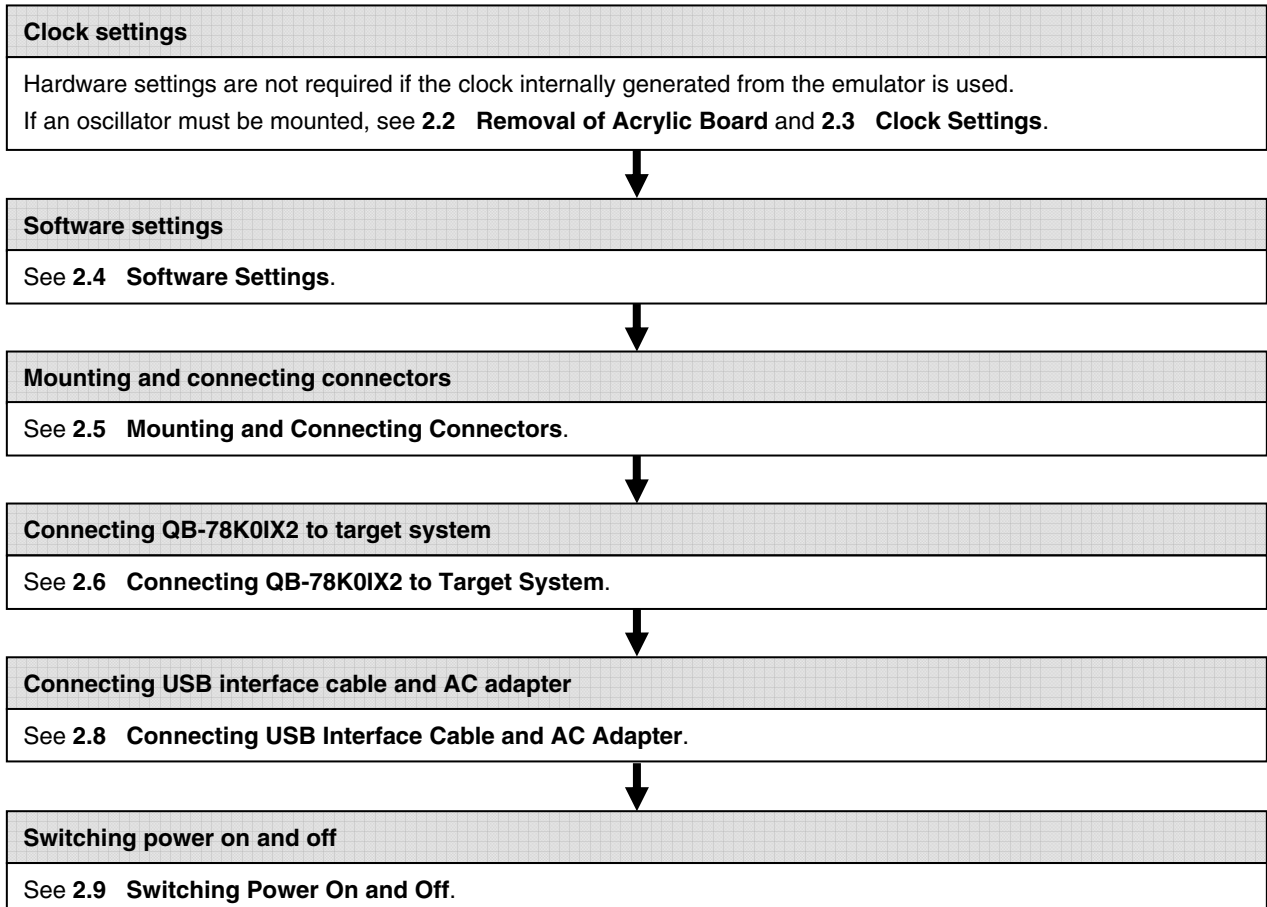

2.1 Names and Functions of Hardware

Figure 2-1. Names of Parts of QB-78K0IX2

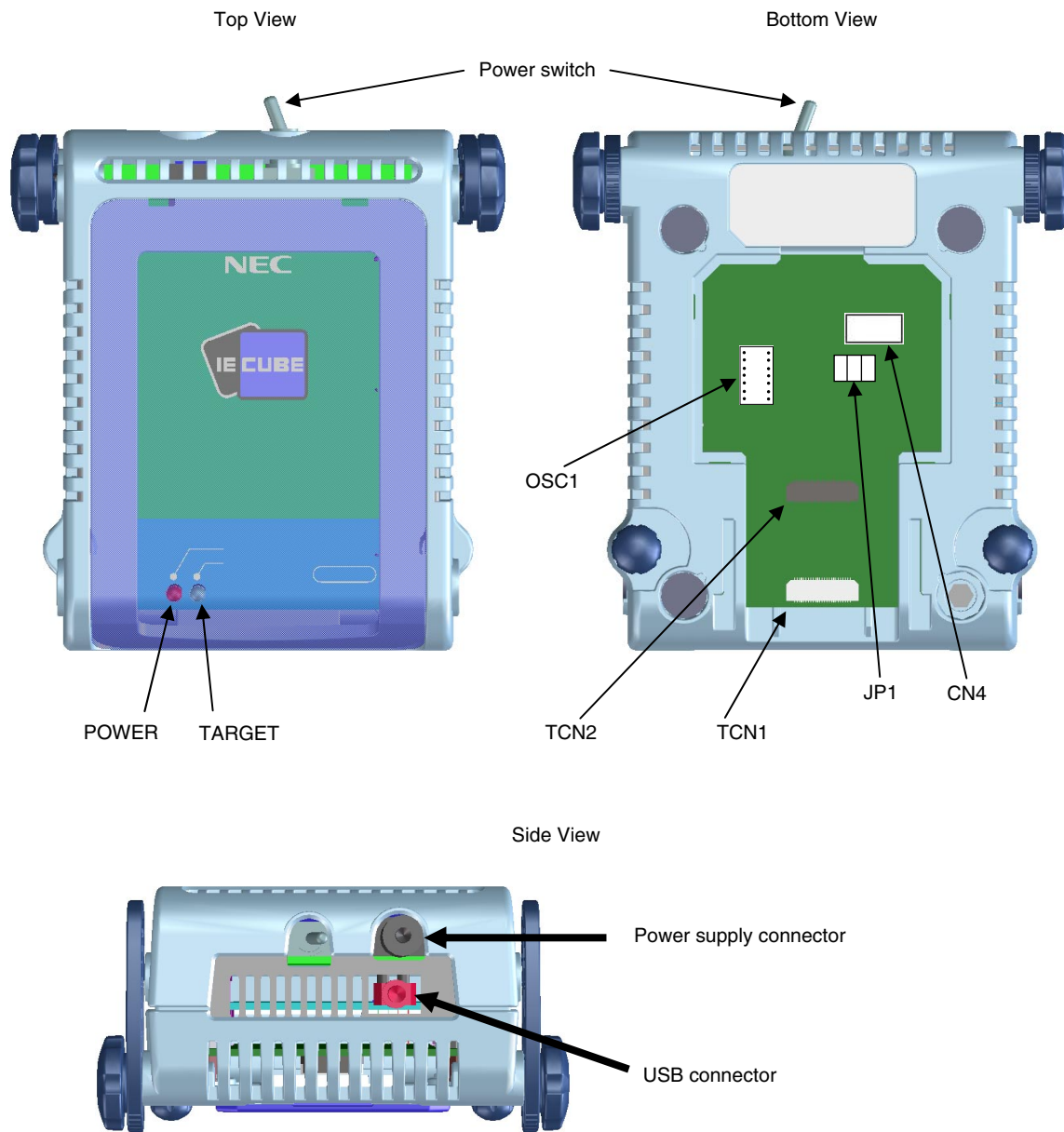

(1) TCN1, TCN2

These are connectors for connecting a check pin adapter or emulation probe.

(2) OSC1

This is a socket for mounting the oscillator.

(3) CN4/JP1

This is a connector for the shipment inspection. It is not something that the user will need.

(4) POWER (Red LED)

This is an LED that shows whether the power supply of the QB-78K0IX2 is switched on.

| LED State | QB-78K0IX2 State   |
|-----------|--|
| Lit       | Power switch ON  |
| Not lit   | Power switch OFF or AC adapter not connected to QB-78K0IX2                               |
| Blinking  | Internal error occurred (Contact an NEC Electronics sales representative or distributor) |

(5) TARGET (Green LED)

This is an LED that shows whether the power supply of the target system is switched on.

| LED State | Target System State   |
|-----------|---|
| Lit       | Target system power supply ON                                 |
| Not lit   | Target system power supply OFF or target system not connected |

(6) Power switch

This is the power switch of the QB-78K0IX2.

It is OFF at shipment.

## 2.2 Removal of Acrylic Board

To modify the clock setting, the acrylic board on the bottom of the QB-78K0IX2 must be removed. The acrylic board can be removed by lifting it up.

Figure 2-2. Acrylic Board Removal Method

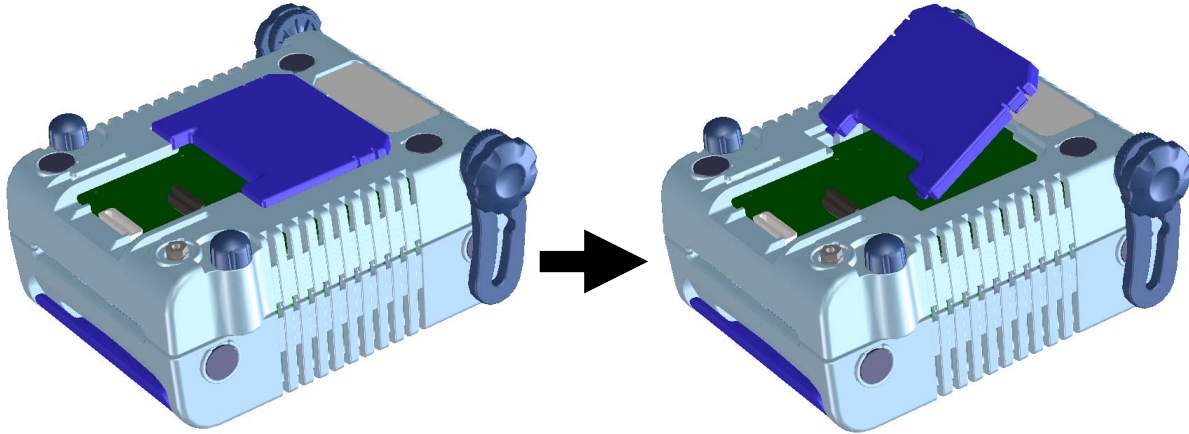

## 2.3 Clock Settings

The following four types of clock settings are available.  
Each clock setting is listed below.

| Clock Used   | Clock Supply   | Debugger Setting<br>(in Configuration Dialog) |
|--|--|---|
| (1) High-speed system clock <sup>Note</sup><br>(X1 oscillator or External input) | (a) When the clock generated within the emulator is used         | System  |
|  | (b) When the clock is supplied from the target system            | External                                      |
|  | (c) When the oscillator (OSC1) mounted onto the emulator is used | Clock Socket                                  |
| (2) Internal high-speed oscillation clock  | Uses the clock internally generated from the emulator            | –   |

**Note** First, select “System” in the debugger settings (refer to (a) When the clock generated within the emulator is used, in (1) High-speed system clock).

If there is no clock that can be selected, follow the descriptions below.

- If the target system clock can supply a square wave for the emulator:  
Select “External” in the debugger settings (refer to (b) When the clock is supplied from the target system, in (1) High-speed system clock).
- If the target system clock cannot supply a square wave for the emulator:  
Mount onto the emulator the oscillator of the clock to be used and select “Clock Socket” in the debugger settings (refer to (c) When the oscillator (OSC1) mounted onto the emulator is used, in (1) High-speed system clock).

Oscillation with the resonator on the target system is not supported. Therefore, the in-circuit emulator cannot emulate the oscillation operation of the clock on the target system.

- (1) High-speed system clock  
 The clock settings are listed below.

**Table 2-1. Settings for High-Speed System Clock**

| Type of Clock to Be Used  | OSC1               | Debugger Setting |
|---|--------------------|------------------|
| (a) When the clock generated within the emulator is used              | –                  | System           |
| (b) When the clock is supplied from the target system <sup>Note</sup> | –                  | External         |
| (c) When the oscillator (OSC1) mounted onto the emulator is used      | Oscillator mounted | Clock Socket     |

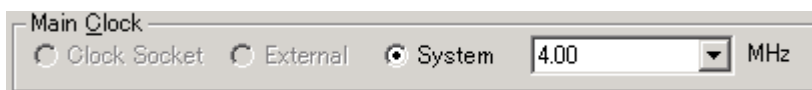

**Note** This setting is not possible when TARGET LED is not lit.

**Remarks 1.** Settings other than the above are prohibited.

2. Selection of (a) or (b) is possible regardless of whether the oscillator is not mounted in the OSC1socket.

- (a) When the clock generated within the emulator is used

Select the “System” in the debugger and select the desired frequency from the drop-down list.

The following frequencies are selectable.

2.00, 3.00, 3.57, 4.00, 4.19, 4.91, 5.00, 6.00, 8.00, 8.38, 10.00 [MHz]

- (b) When the clock is supplied from the target system

Select the “External” in the debugger. The clock input from the target system is then used.

Oscillation with the resonator on the target system is not supported. To input a clock from the target system, input to the clock pin (X2) the square-wave signal with the same voltage potential as that of the target device supply voltage (V<sub>DD</sub>). Inputting the inverted signal to X1 is not necessary.

The selectable frequencies are same as those of the target device.

- (c) When the oscillator (OSC1) mounted onto the emulator is used

Mount an oscillator in the OSC1 socket in the emulator and then select the “Clock socket” in the debugger. The clock generated from the oscillator mounted on the emulator is used.

The selectable frequencies are same as those of the target device.

As an oscillator<sup>Note</sup> to be mounted in the OSC1 socket in the emulator, use the one that satisfies the following specifications.

- Supply voltage: 5 V
- Output level: CMOS

**Note** An oscillator that uses a resonator cannot be used.

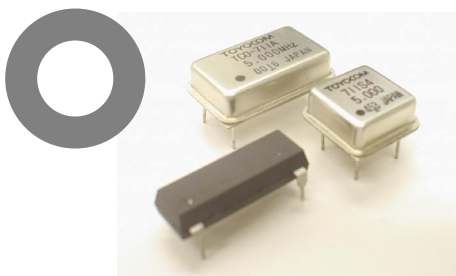



Figure 2-3. Oscillator Shape

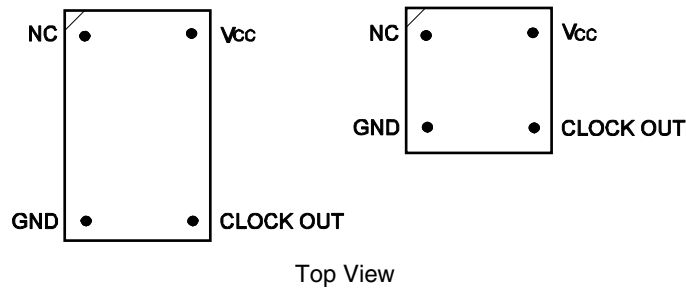
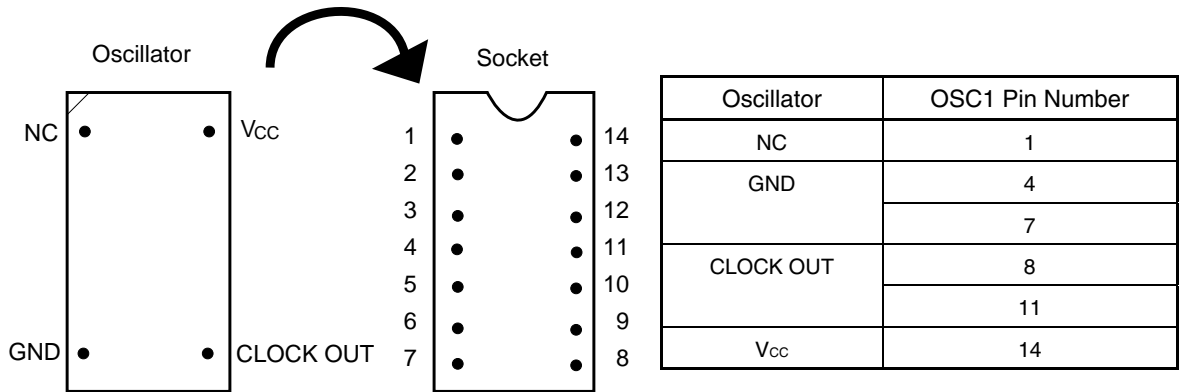

Figure 2-4. Mapping of Oscillator to Socket



**Remark** Insert the oscillator into the socket, take care for the pin 1 position.

(2) Internal high-speed oscillation clock

The debugger setting is not necessary.

The use of the internal high-speed oscillation clock can be specified in the user program.

## 2.4 Software Settings

For details, see the **ID78K0-QB Ver. 3.00 Integrated Debugger Operation User's Manual (U18492E)**.

## 2.5 Mounting and Connecting Connectors

This section describes the methods of connecting the QB-78K0IX2 and target system.

Make connections with both the QB-78K0IX2 and target system powered OFF.

The following abbreviations are used in this section:

- TC: Target connector
- YQ: YQ connector
- EA: Exchange adapter
- MA: Mount adapter
- CA: Check pin adapter
- SA: Space adapter

### 2.5.1 Mounting TC to target system (socket that has at least 30 pins)

- (1) Thinly apply a two-component epoxy adhesive (hardening time at least 30 minutes) to the ends of the four projections on the base of the TC and adhere the TC to the user board (clean the surface of the target system board using alcohol or the like). If alignment of target system pads to TC leads is difficult, align them as in (2).
- (2) Align by inserting the guide pins for alignment for the TC (NQGUIDE) through the pin holes on the top of the TC. Accessory holes are  $\phi 1.0$  mm non-through holes in two or three places.  
(For hole positions, see the particular TC drawing.)
- (3) Solder after fitting the MA to the TC. This is to prevent troubles such as flux or solder splashing and adhering to the TC contact pins when soldering.
  - Soldering conditions

|                  |                                   |
|------------------|-----------------------------------|
| Solder reflow    | 260°C × 10 seconds or less        |
| Manual soldering | 350°C × 5 seconds or less (1 pin) |

**Caution** Do not perform washing by flux immersion or vapor.

- (4) Take away the guide pins.

**2. 5. 2 Mounting TC to target system (socket that has less than 30 pins)**

- (1) Thinly apply an adhesive to the back of the TC and adhere the TC to the target system. In addition, be sure to clean the back of the TC as well as the surface of the target system using alcohol or the like. Align the TC leads along the target system pads .
- (2) Preserve the soldering conditions (use Sn-3.5Ag-0.5Cu) and solder carefully to prevent troubles such as flux or solder splashing and adhering to the contact pins.

Solder reflow:

- Preheating: 150 to 170°C  
120 seconds or less
- Heating: 220°C  
60 seconds or less
- Maximum temperature: 240°C or below

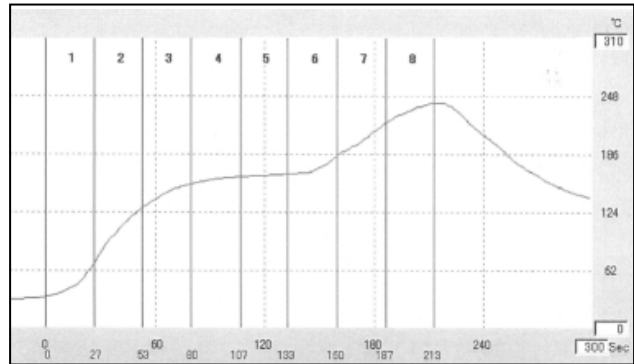

The above profile represents the temperature around the soldering pins.

Manual soldering:

- 350°C × 5 seconds or less (1 pin)

### 2.5.3 Mounting YQ to TC (socket that has at least 30 pins)

- (1) After confirming that there are no broken or bent YQ contact pins, fit the YQ in the TC and fasten it using the supplied YQGUIDE (for the fastening method, see the next step, (2)). If repeatedly inserting and removing, be sure to inspect the YQ pins before fitting. If pins are bent, correct them using something thin and flat such as the edge of a knife.
- (2) Fasten YQ to the TC on the target system using the supplied YQGUIDE. Fasten the screws equally in the four corners using the supplied flat-blade screwdriver or a torque driver. The tightening torque of YQGUIDE is 0.054 Nm (MAX.). Too great tightening causes bad connections. Four screws for fitting to the MA (M2 x 10 mm / 4 units) are included with YQ.

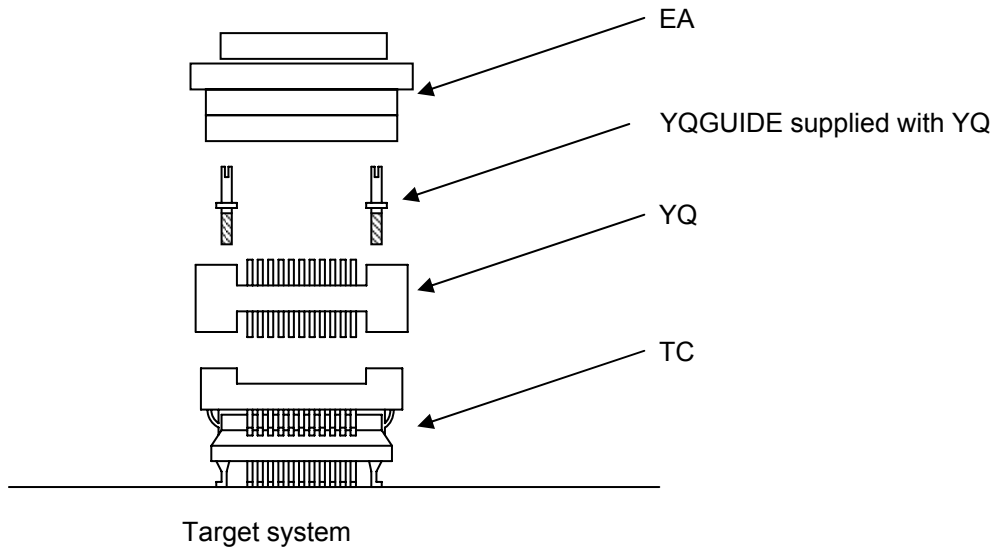

### 2.5.4 Plugging EA into YQ (socket that has at least 30 pins)

Match the pin 1 position of the YQ or SA (corner cuts match in both) to the pin 1 position of the EA and plug in.

- When plugging or unplugging, press on the TC, YQ, and SA with a finger so that there is no force on the TC.
- When plugging or unplugging, be careful of the direction of wiggling.

As a tool when unplugging, insert some kind of thin non-conductive material such as a wooden stick between the YQ (SA) and EA and wiggle while slowly unplugging. Be careful since the connector will be damaged if this is done in the wrong direction.

### 2.5.5 Plugging EA into TC (socket that has less than 30 pins)

Check the pin 1 position of the EA and the pin 1 mark (silk) of the pin 1 position of the TC and plug in.

### 2.5.6 Precautions for handling TC, YQ, SA, and CA

- (1) When taking the TC from the box, press down on the body and take out the sponge first.
- (2) Since the pins of the YQ are thin and easily bent, be careful. When inserting it in the TC, confirm that there are no bent pins.
- (3) When screwing a YQ soldered to a board to the TC, fasten the screws in four places in turn using a #0 or #1 Phillips precision screwdriver or torque driver after tentatively tightening them. Fix the torque at 0.054 Nm (MAX.).  
If just one place is overtightened, it may cause poor contact. Moreover, a board being connected to the YQ must have accessory holes in prescribed positions (four places:  $\phi 2.3$  mm or  $\phi 3.3$  mm). The  $\phi 3.8$  mm or  $\phi 4.3$  mm that is the screw head size is an area where wiring is prohibited.
- (4) In YQ and SA removal, since there is a danger of YQ pins being bent or broken when prying and wiggling, remove them gradually using a flatbladed screwdriver from four directions. Moreover, to connect and use the YQ and SA, screw the YQ to the TC according to the YQGUIDE (included with the YQ) using a 2.3 mm flatbladed screwdriver and then connect it to the SA. Fix the torque at 0.054 Nm (MAX.). If even one place is overtightened, it may cause poor contact.
- (5) For the TC, YQ, and SA, since there is a danger that washing fluid on the structure will remain in the connector, do not perform washing.
- (6) TC, IC, and YQ cannot be used in combination.
- (7) A TC/YQ system cannot be used in an environment of vibrations or shocks.
- (8) It is assumed that this product will be used in system development and evaluation. Moreover, when used in Japan, Electrical Appliance and Material Control Law and electromagnetic disturbance countermeasures have not been applied.
- (9) Since there are rare cases of shape change if the box is left for a long time in a place where it is 50°C or higher, for safekeeping, store it in a place where it is no higher than 40°C and direct sunlight does not hit it.
- (10) For details about handling the TC, YQ, and SA, see the NQPACK series technical materials at the website of Tokyo Eletech Corporation.  
URL: <http://www.tetc.co.jp/>
- (11) CA  
The CA is an optional product for IECUBE, and can be used to measure the waveform between IECUBE and the target system.  
Since the pins on the CA do not correspond to the pin layout in each device, the pin header cover must be mounted according to the device to be used. For mounting methods of the pin header cover, refer to **[Related Contents]** on the following URL.  
<http://www.necel.com/micro/en/development/asia/Emulator/IE/iecube.html>
- (12) Prying at insertion/removal might break the connector, therefore be sure to insert/remove vertically.

**2.5.7 Precautions for mounting IC using TC and MA**

- (1) Confirm that there is no weld flash in the resin (sealant part) of the IC. If there is weld flash, remove it using a knife or the like.
- (2) Confirm that there is no weld flash breaking or bending of IC leads. In particular, confirm the planarity of IC leads. If there is abnormality in the planarity, correct that portion.
- (3) Viewing the TC contact pins from the top, if there are foreign bodies on them, remove them using a brush or the like.

After confirming (1) to (3), fit the IC to the TC. Also fit the MA.

- (4) Put the supplied M2 x 6 mm screws in the four accessory holes of the MA and fasten the screws in opposite corners. At that time, use either the dedicated screwdriver that is supplied or a torque driver to fasten them equally in turn with a tightening torque of 0.054 Nm (MAX.). Since the contact is poor if tightening is too great, once you have lightly fastened the MA screws, tighten them again.
- (5) Depending on the use environment, when starting up a device that has been left for a long time, starting it may be difficult. In this case, loosen the screws slightly and then retighten them.
- (6) If startup still is difficult after (5) above, check (1) to (3) again.
- (7) Tightening the screws of the MA too much may give rise to cracks in the molded part of the MA (plastic part) and bend the mold into a bowed shape, making contact poor.
- (8) After soldering the TC, do not perform cleaning by flux immersion or vapor.

## 2.6 Connecting QB-78K0IX2 to Target System

If connecting the emulation probe (QB-80-EP-01T), connect it to the QB-78K0IX2 and the target system by the following procedure.

### (a) Connection of emulation probe

Connect the emulation probe to the QB-78K0IX2.

**Figure 2-5. Emulation Probe Connection Method**

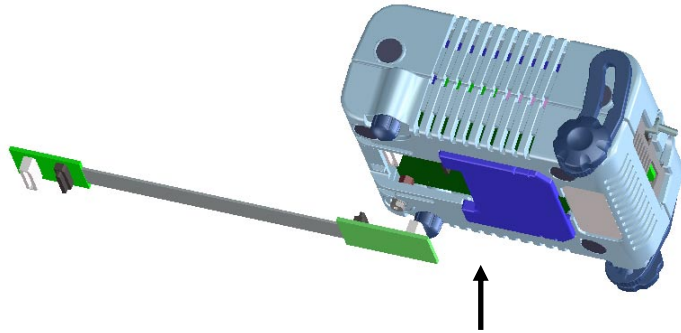

Insert CN1 and CN2 of the probe into TCN1 and TCN2 of the QB-78K0IX2.

### (b) Connection of emulation probe GND wire

There are 2 GND wires in the emulation probe. Connect them to the QB-78K0IX2 and target system.

- <1> Fasten the GND wire on the QB-78K0IX2 side of the emulation probe to the nut on the bottom of the QB-78K0IX2 using a #0 or #1 Phillips precision driver (connection of B to A in Figure 2-6).
- <2> Next plug the connector on top of the emulation probe into the connector at the opening on the bottom of the QB-78K0IX2 from below being careful of the insertion direction.

**Figure 2-6. GND Wire**

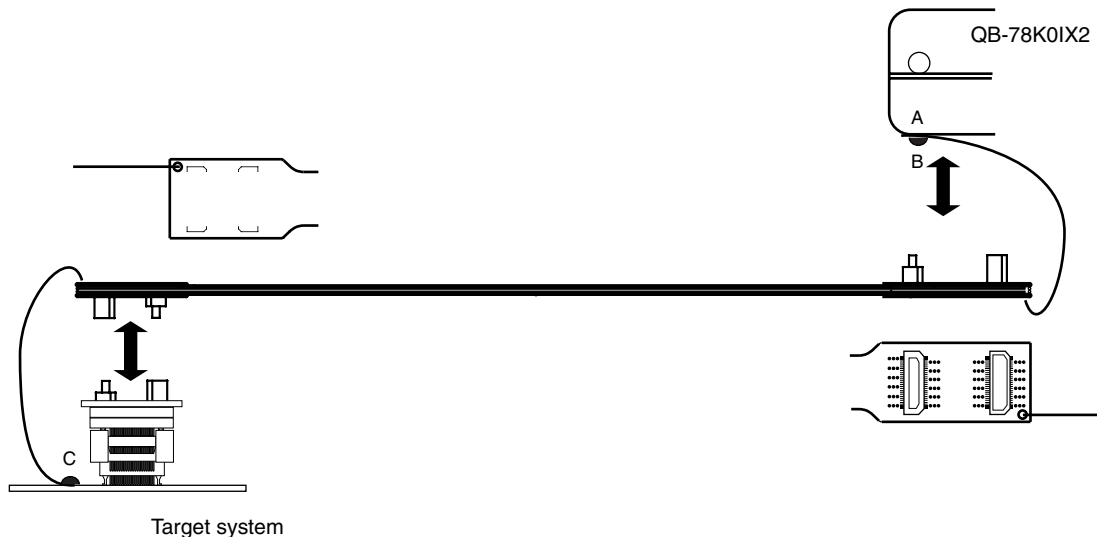

- <3> Connect the exchange adapter and emulation probe to the target connector.
- <4> Connect the GND wire on the target system side of the emulation probe to the target system GND. If a pin or screw is fastened to the target system GND, remove the transparent terminal cover on the end of the GND wire and fasten the Y terminal of the GND wire to the target system (C in Figure 2-6). If the GND on the target system is an exposed pad, likewise fasten the Y terminal to the pad on the target system by soldering (recommended soldering iron temperature setting: 300°C).
- <5> Since the length of the GND wire below the head (insulated part) is approximately 60 mm, there must be a GND to which it can be connected to within the range of an approximately 60 mm radius section of the target system for connecting the emulation probe, as shown in Figure 2-7.

**Figure 2-7. Where GND Wire Can Be Connected**

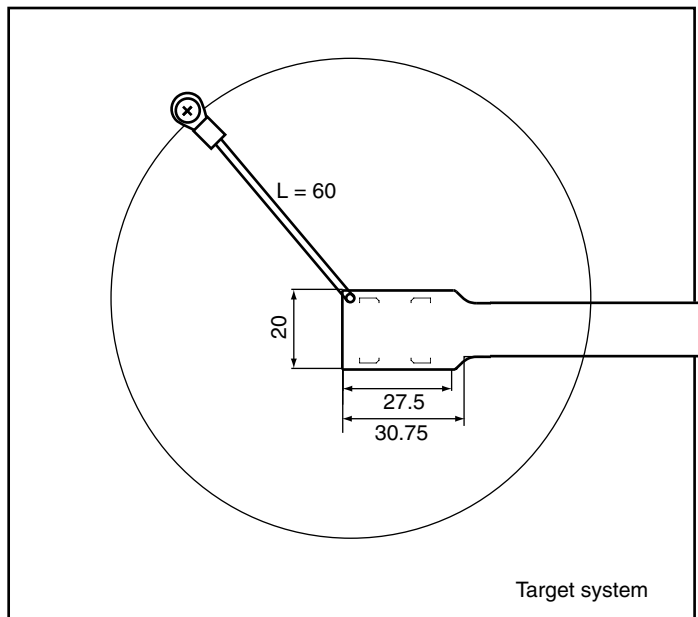



**(c) Ensuring isolation**

When connecting the target system to the QB-78K0IX2 using an emulation probe, adjust the height using the front space adapter or rear space adapter of the QB-78K0IX2 and ensure isolation from the target system.

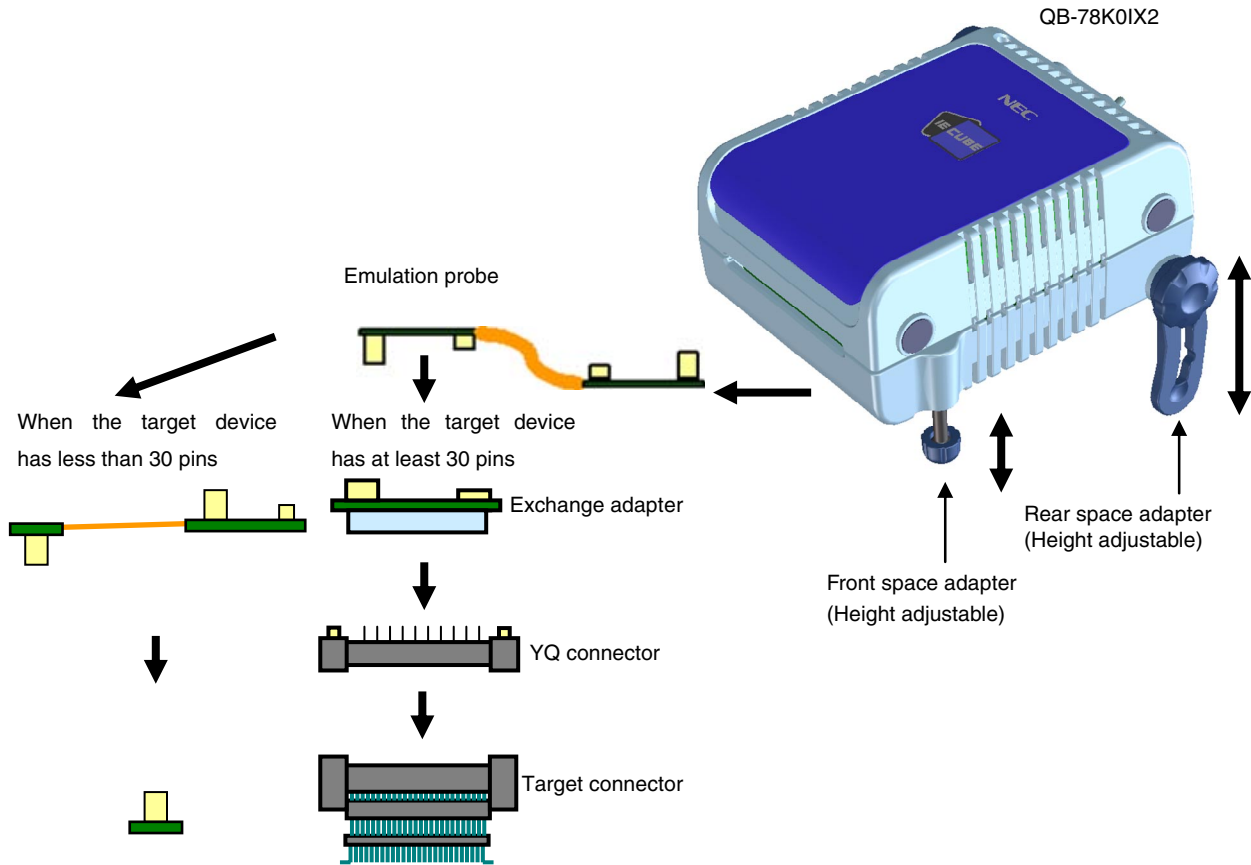
**Figure 2-8. Connection Using Emulation Probe****(d) Precautions related to emulation probe**

The following precautions pertain to using the emulation probe.

- <1> Be careful that stress of the emulation probe is not placed on the target connector. Moreover, when removing the emulation probe, remove it slowly while pressing down on the exchange adapter with a finger so that there is no stress on the target connector.
- <2> Be sure to connect the GND wire of the emulation probe to the QB-78K0IX2 and the target system. If not, the impedance of the cable becomes unstable, resulting in the lowering of signal transmission characteristics or distortion of the output waveform for an input waveform.

**2.7 Notes on Power Supply and GND Pin Connection**

For power supplies and GND pins of the target device, be sure to connect all pins to each power supply or GND.

## 2.8 Connecting USB Interface Cable and AC Adapter

Plug the USB interface cable supplied with the QB-78K0IX2 into the USB connector of the host machine, and plug the other side into the USB connector on the rear of the QB-78K0IX2.

Plug the AC adapter (sold separately) into a receptacle and plug the other side into the power supply connector on the rear of the QB-78K0IX2.

For QB-78K0IX2 connector positions, see **Figure 2-9**.

**Figure 2-9. Connector Positions**

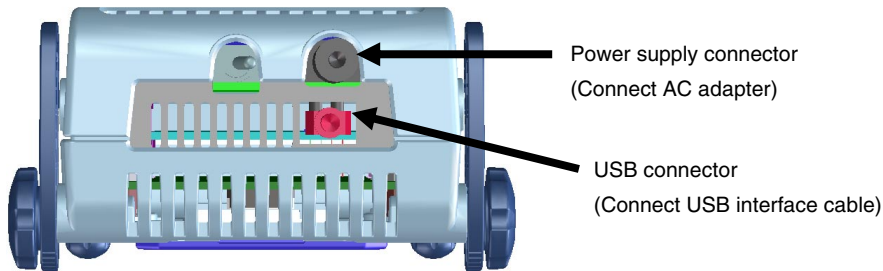

## 2.9 Switching Power On and Off

Be sure to switch the power on and off according to the following procedures.

- |  |   |
|--|---|
| - Switching power on                       | - Switching power off                       |
| <1> QB-78K0IX2 power on                    | <1> Debugger termination                    |
| <2> Target system power on <sup>Note</sup> | <2> Target system power off <sup>Note</sup> |
| <3> Debugger startup                       | <3> QB-78K0IX2 power off                    |

**Note** In the procedures, <2> is unnecessary if the target system is not connected.

**Caution** If the wrong sequence was used for the operation, the target system or QB-78K0IX2 may fail.

## CHAPTER 3 SETTINGS AT PRODUCT SHIPMENT

**Table 3-1. Settings at Shipment**

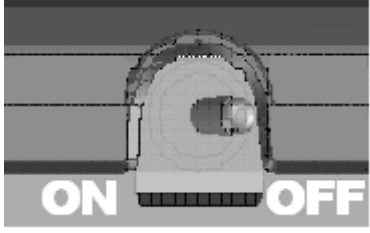
| Item         | Setting   | Remarks   |
|--------------|---|---|
| OSC1         | Not mounted   | Oscillator can be mounted <sup>Note</sup> .                             |
| JP1          | 1-2 shorted   | This is a connector used for inspection.<br>Do not change this setting. |
| Power switch |  | Set to OFF at shipment.   |

**Note** The oscillation circuit using an oscillation cannot be used.

## CHAPTER 4 NOTES

Observe the following notes.

- The QB-78K0IX2 may be damaged if  $AV_{REF}$  is applied before the target powers  $V_{DD}$  is applied.
- Be sure to supply power from the target system when the target system is connected. If the debugger is started without supplying power from the target system, the target system may be damaged.
- Emulating the trimming registers (R4MTRM1, 2, 3) is not supported. The accuracy of the internal high-speed oscillators (4 MHz, 8 MHz) is less than 1%, regardless of the trimming registers.
- Do not turn off the target power supply (do not allow it to become lower than the POC voltage) during a break (power supply can be turned off only during RUN).
- When inputting the external clock, input the square waveform with the same potential as the target device to the clock pins (X2, XT2).
- A watchdog timer reset is not generated when an area for which the capacities of the internal ROM, internal high-speed ROM, and internal expansion RAM are not set with the IMS registers is illegally accessed. Emulation is performed with a fail-safe break.
- The device and IECUBE have different circuit equivalences.
  - The  $V_{DD}$  pin of IECUBE is provided with a power supply detection circuit and is internally connected to a 2 k $\Omega$  pull-down resistor.
  - The RESET pin of IECUBE is connected to a 2 M $\Omega$  pull-down resistor.
  - The ports (except the shared analog pins) of IECUBE are connected to 56  $\Omega$  damping resistors.
  - The shared analog port pins of IECUBE are connected to 1 M $\Omega$  pull-down resistors, which are disconnected when the analog functions are used.
  - The P122 pin of IECUBE are connected to a 100 k $\Omega$  pull-down resistor.
  - The REGC pin of IECUBE is internally left open. (The REGC pin functions cannot be emulated.)
- The response time of the comparator differs from that of the device.

Actual device : 70 ns (typ.) (2.7 to 5.5 V)  
IECUBE : 140 ns (typ.) (5.5 V)  
          : 120 ns (typ.) (3.3 V)

**[MEMO]**

*For further information,  
please contact:*

**NEC Electronics Corporation**  
1753, Shimonumabe, Nakahara-ku,  
Kawasaki, Kanagawa 211-8668,  
Japan  
Tel: 044-435-5111  
<http://www.necel.com/>

**[America]**

**NEC Electronics America, Inc.**  
2880 Scott Blvd.  
Santa Clara, CA 95050-2554, U.S.A.  
Tel: 408-588-6000  
800-366-9782  
<http://www.am.necel.com/>

**[Europe]**

**NEC Electronics (Europe) GmbH**  
Arcadiastrasse 10  
40472 Düsseldorf, Germany  
Tel: 0211-65030  
<http://www.eu.necel.com/>

**Hanover Office**

Podbielskistrasse 166 B  
30177 Hannover  
Tel: 0 511 33 40 2-0

**Munich Office**

Werner-Eckert-Strasse 9  
81829 München  
Tel: 0 89 92 10 03-0

**Stuttgart Office**

Industriestrasse 3  
70565 Stuttgart  
Tel: 0 711 99 01 0-0

**United Kingdom Branch**

Cygnus House, Sunrise Parkway  
Linford Wood, Milton Keynes  
MK14 6NP, U.K.  
Tel: 01908-691-133

**Succursale Française**

9, rue Paul Dautier, B.P. 52  
78142 Velizy-Villacoublay Cédex  
France  
Tel: 01-3067-5800

**Sucursal en España**

Juan Esplandiú, 15  
28007 Madrid, Spain  
Tel: 091-504-2787

**Tyskland Filial**

Täby Centrum  
Entrance S (7th floor)  
18322 Täby, Sweden  
Tel: 08 638 72 00

**Filiale Italiana**

Via Fabio Filzi, 25/A  
20124 Milano, Italy  
Tel: 02-667541

**Branch The Netherlands**

Steijgerweg 6  
5616 HS Eindhoven  
The Netherlands  
Tel: 040 265 40 10

**[Asia & Oceania]**

**NEC Electronics (China) Co., Ltd**  
7th Floor, Quantum Plaza, No. 27 ZhiChunLu Haidian  
District, Beijing 100083, P.R.China  
Tel: 010-8235-1155  
<http://www.cn.necel.com/>

**Shanghai Branch**

Room 2509-2510, Bank of China Tower,  
200 Yincheng Road Central,  
Pudong New Area, Shanghai, P.R.China P.C:200120  
Tel:021-5888-5400  
<http://www.cn.necel.com/>

**Shenzhen Branch**

Unit 01, 39/F, Excellence Times Square Building,  
No. 4068 Yi Tian Road, Futian District, Shenzhen,  
P.R.China P.C:518048  
Tel:0755-8282-9800  
<http://www.cn.necel.com/>

**NEC Electronics Hong Kong Ltd.**

Unit 1601-1613, 16/F., Tower 2, Grand Century Place,  
193 Prince Edward Road West, Mongkok, Kowloon, Hong Kong  
Tel: 2886-9318  
<http://www.hk.necel.com/>

**NEC Electronics Taiwan Ltd.**

7F, No. 363 Fu Shing North Road  
Taipei, Taiwan, R. O. C.  
Tel: 02-8175-9600  
<http://www.tw.necel.com/>

**NEC Electronics Singapore Pte. Ltd.**

238A Thomson Road,  
#12-08 Novena Square,  
Singapore 307684  
Tel: 6253-8311  
<http://www.sg.necel.com/>

**NEC Electronics Korea Ltd.**

11F., Samik Lavied'or Bldg., 720-2,  
Yeoksam-Dong, Kangnam-Ku,  
Seoul, 135-080, Korea  
Tel: 02-558-3737  
<http://www.kr.necel.com/>