

PG-FP6 V1.16

Flash Memory Programmer

User's Manual

All information contained in these materials, including products and product specifications, represents information on the product at the time of publication and is subject to change by Renesas Electronics Corporation without notice. Please review the latest information published by Renesas Electronics Corporation through various means, including the Renesas Electronics Corporation website (<http://www.renesas.com>).

Notice

1. Descriptions of circuits, software and other related information in this document are provided only to illustrate the operation of semiconductor products and application examples. You are fully responsible for the incorporation or any other use of the circuits, software, and information in the design of your product or system. Renesas Electronics disclaims any and all liability for any losses and damages incurred by you or third parties arising from the use of these circuits, software, or information.
2. Renesas Electronics hereby expressly disclaims any warranties against and liability for infringement or any other claims involving patents, copyrights, or other intellectual property rights of third parties, by or arising from the use of Renesas Electronics products or technical information described in this document, including but not limited to, the product data, drawings, charts, programs, algorithms, and application examples.
3. No license, express, implied or otherwise, is granted hereby under any patents, copyrights or other intellectual property rights of Renesas Electronics or others.
4. You shall be responsible for determining what licenses are required from any third parties, and obtaining such licenses for the lawful import, export, manufacture, sales, utilization, distribution or other disposal of any products incorporating Renesas Electronics products, if required.
5. You shall not alter, modify, copy, or reverse engineer any Renesas Electronics product, whether in whole or in part. Renesas Electronics disclaims any and all liability for any losses or damages incurred by you or third parties arising from such alteration, modification, copying or reverse engineering.
6. Renesas Electronics products are classified according to the following two quality grades: "Standard" and "High Quality". The intended applications for each Renesas Electronics product depends on the product's quality grade, as indicated below.

"Standard": Computers; office equipment; communications equipment; test and measurement equipment; audio and visual equipment; home electronic appliances; machine tools; personal electronic equipment; industrial robots; etc.

"High Quality": Transportation equipment (automobiles, trains, ships, etc.); traffic control (traffic lights); large-scale communication equipment; key financial terminal systems; safety control equipment; etc.

Unless expressly designated as a high reliability product or a product for harsh environments in a Renesas Electronics data sheet or other Renesas Electronics document, Renesas Electronics products are not intended or authorized for use in products or systems that may pose a direct threat to human life or bodily injury (artificial life support devices or systems; surgical implantations; etc.), or may cause serious property damage (space system; undersea repeaters; nuclear power control systems; aircraft control systems; key plant systems; military equipment; etc.). Renesas Electronics disclaims any and all liability for any damages or losses incurred by you or any third parties arising from the use of any Renesas Electronics product that is inconsistent with any Renesas Electronics data sheet, user's manual or other Renesas Electronics document.

7. No semiconductor product is absolutely secure. Notwithstanding any security measures or features that may be implemented in Renesas Electronics hardware or software products, Renesas Electronics shall have absolutely no liability arising out of any vulnerability or security breach, including but not limited to any unauthorized access to or use of a Renesas Electronics product or a system that uses a Renesas Electronics product. RENESAS ELECTRONICS DOES NOT WARRANT OR GUARANTEE THAT RENESAS ELECTRONICS PRODUCTS, OR ANY SYSTEMS CREATED USING RENESAS ELECTRONICS PRODUCTS WILL BE INVULNERABLE OR FREE FROM CORRUPTION, ATTACK, VIRUSES, INTERFERENCE, HACKING, DATA LOSS OR THEFT, OR OTHER SECURITY INTRUSION ("Vulnerability Issues"). RENESAS ELECTRONICS DISCLAIMS ANY AND ALL RESPONSIBILITY OR LIABILITY ARISING FROM OR RELATED TO ANY VULNERABILITY ISSUES. FURTHERMORE, TO THE EXTENT PERMITTED BY APPLICABLE LAW, RENESAS ELECTRONICS DISCLAIMS ANY AND ALL WARRANTIES, EXPRESS OR IMPLIED, WITH RESPECT TO THIS DOCUMENT AND ANY RELATED OR ACCOMPANYING SOFTWARE OR HARDWARE, INCLUDING BUT NOT LIMITED TO THE IMPLIED WARRANTIES OF MERCHANTABILITY, OR FITNESS FOR A PARTICULAR PURPOSE.
8. When using Renesas Electronics products, refer to the latest product information (data sheets, user's manuals, application notes, "General Notes for Handling and Using Semiconductor Devices" in the reliability handbook, etc.), and ensure that usage conditions are within the ranges specified by Renesas Electronics with respect to maximum ratings, operating power supply voltage range, heat dissipation characteristics, installation, etc. Renesas Electronics disclaims any and all liability for any malfunctions, failure or accident arising out of the use of Renesas Electronics products outside of such specified ranges.
9. Although Renesas Electronics endeavors to improve the quality and reliability of Renesas Electronics products, semiconductor products have specific characteristics, such as the occurrence of failure at a certain rate and malfunctions under certain use conditions. Unless designated as a high reliability product or a product for harsh environments in a Renesas Electronics data sheet or other Renesas Electronics document, Renesas Electronics products are not subject to radiation resistance design. You are responsible for implementing safety measures to guard against the possibility of bodily injury, injury or damage caused by fire, and/or danger to the public in the event of a failure or malfunction of Renesas Electronics products, such as safety design for hardware and software, including but not limited to redundancy, fire control and malfunction prevention, appropriate treatment for aging degradation or any other appropriate measures. Because the evaluation of microcomputer software alone is very difficult and impractical, you are responsible for evaluating the safety of the final products or systems manufactured by you.
10. Please contact a Renesas Electronics sales office for details as to environmental matters such as the environmental compatibility of each Renesas Electronics product. You are responsible for carefully and sufficiently investigating applicable laws and regulations that regulate the inclusion or use of controlled substances, including without limitation, the EU RoHS Directive, and using Renesas Electronics products in compliance with all these applicable laws and regulations. Renesas Electronics disclaims any and all liability for damages or losses occurring as a result of your noncompliance with applicable laws and regulations.
11. Renesas Electronics products and technologies shall not be used for or incorporated into any products or systems whose manufacture, use, or sale is prohibited under any applicable domestic or foreign laws or regulations. You shall comply with any applicable export control laws and regulations promulgated and administered by the governments of any countries asserting jurisdiction over the parties or transactions.
12. It is the responsibility of the buyer or distributor of Renesas Electronics products, or any other party who distributes, disposes of, or otherwise sells or transfers the product to a third party, to notify such third party in advance of the contents and conditions set forth in this document.
13. This document shall not be reprinted, reproduced or duplicated in any form, in whole or in part, without prior written consent of Renesas Electronics.
14. Please contact a Renesas Electronics sales office if you have any questions regarding the information contained in this document or Renesas Electronics products.

(Note1) "Renesas Electronics" as used in this document means Renesas Electronics Corporation and also includes its directly or indirectly controlled subsidiaries.

(Note2) "Renesas Electronics product(s)" means any product developed or manufactured by or for Renesas Electronics.

(Rev.5.0-1 October 2020)

Corporate Headquarters

TOYOSU FORESIA, 3-2-24 Toyosu,
Koto-ku, Tokyo 135-0061, Japan

www.renesas.com

Trademarks

Renesas and the Renesas logo are trademarks of Renesas Electronics Corporation. All trademarks and registered trademarks are the property of their respective owners.

Contact information

For further information on a product, technology, the most up-to-date version of a document, or your nearest sales office, please visit:

www.renesas.com/contact/.

General Precautions in the Handling of Microprocessing Unit and Microcontroller Unit Products

The following usage notes are applicable to all Microprocessing unit and Microcontroller unit products from Renesas. For detailed usage notes on the products covered by this document, refer to the relevant sections of the document as well as any technical updates that have been issued for the products.

1. Precaution against Electrostatic Discharge (ESD)

A strong electrical field, when exposed to a CMOS device, can cause destruction of the gate oxide and ultimately degrade the device operation. Steps must be taken to stop the generation of static electricity as much as possible, and quickly dissipate it when it occurs. Environmental control must be adequate. When it is dry, a humidifier should be used. This is recommended to avoid using insulators that can easily build up static electricity. Semiconductor devices must be stored and transported in an anti-static container, static shielding bag or conductive material. All test and measurement tools including work benches and floors must be grounded. The operator must also be grounded using a wrist strap. Semiconductor devices must not be touched with bare hands. Similar precautions must be taken for printed circuit boards with mounted semiconductor devices.

2. Processing at power-on

The state of the product is undefined at the time when power is supplied. The states of internal circuits in the LSI are indeterminate and the states of register settings and pins are undefined at the time when power is supplied. In a finished product where the reset signal is applied to the external reset pin, the states of pins are not guaranteed from the time when power is supplied until the reset process is completed. In a similar way, the states of pins in a product that is reset by an on-chip power-on reset function are not guaranteed from the time when power is supplied until the power reaches the level at which resetting is specified.

3. Input of signal during power-off state

Do not input signals or an I/O pull-up power supply while the device is powered off. The current injection that results from input of such a signal or I/O pull-up power supply may cause malfunction and the abnormal current that passes in the device at this time may cause degradation of internal elements. Follow the guideline for input signal during power-off state as described in your product documentation.

4. Handling of unused pins

Handle unused pins in accordance with the directions given under handling of unused pins in the manual. The input pins of CMOS products are generally in the high-impedance state. In operation with an unused pin in the open-circuit state, extra electromagnetic noise is induced in the vicinity of the LSI, an associated shoot-through current flows internally, and malfunctions occur due to the false recognition of the pin state as an input signal become possible.

5. Clock signals

After applying a reset, only release the reset line after the operating clock signal becomes stable. When switching the clock signal during program execution, wait until the target clock signal is stabilized. When the clock signal is generated with an external resonator or from an external oscillator during a reset, ensure that the reset line is only released after full stabilization of the clock signal. Additionally, when switching to a clock signal produced with an external resonator or by an external oscillator while program execution is in progress, wait until the target clock signal is stable.

6. Voltage application waveform at input pin

Waveform distortion due to input noise or a reflected wave may cause malfunction. If the input of the CMOS device stays in the area between V_{IL} (Max.) and V_{IH} (Min.) due to noise, for example, the device may malfunction. Take care to prevent chattering noise from entering the device when the input level is fixed, and also in the transition period when the input level passes through the area between V_{IL} (Max.) and V_{IH} (Min.).

7. Prohibition of access to reserved addresses

Access to reserved addresses is prohibited. The reserved addresses are provided for possible future expansion of functions. Do not access these addresses as the correct operation of the LSI is not guaranteed.

8. Differences between products

Before changing from one product to another, for example to a product with a different part number, confirm that the change will not lead to problems. The characteristics of a microprocessing unit or microcontroller unit products in the same group but having a different part number might differ in terms of internal memory capacity, layout pattern, and other factors, which can affect the ranges of electrical characteristics, such as characteristic values, operating margins, immunity to noise, and amount of radiated noise. When changing to a product with a different part number, implement a system-evaluation test for the given product.

Preface

Thank you for purchasing the PG-FP6. The PG-FP6 is a flash memory programmer for MCUs from Renesas Electronics.

If you have any questions about the PG-FP6, submit your opinions or impressions by using the [Give Feedback](#) form or contact your local distributor.

You can download the latest manuals from the Renesas Tools homepage (<https://www.renesas.com/pg-fp6>).

Important

Before using this product, be sure to read this user's manual carefully.

Keep this user's manual, and refer to it when you have questions about this product.

Purpose of use of the product:

This product is a device to support the development of systems that uses MCUs from Renesas Electronics. This product is a tool that erases, writes and verifies programs on a Renesas Electronics on-chip flash memory MCU on the target system.

Be sure to use this product correctly according to said purpose of use. Please avoid using this product other than for its intended purpose of use.

For those who use this product:

This product can only be used by those who have carefully read the user's manual and know how to use it.

Use of this product requires basic knowledge of electric circuits, logical circuits, and MCUs.

When using this product:

- (1) This product is a development-support unit for use in your program development and evaluation stages. When a program you have finished developing is to be incorporated in a mass-produced product, the judgment as to whether it can be put to practical use is entirely your own responsibility, and should be based on evaluation of the device on which it is installed and other experiments.
- (2) In no event shall Renesas Electronics Corporation be liable for any consequence arising from the use of this product.
- (3) Renesas Electronics Corporation strives to provide workarounds for and correct trouble with products malfunctions, with some free and some incurring charges. However, this does not necessarily mean that Renesas Electronics Corporation guarantees the provision of a workaround or correction under any circumstances.
- (4) Renesas Electronics Corporation cannot predict all possible situations and possible cases of misuse that carry a potential for danger. Therefore, the warnings in this user's manual and the warning labels attached to this product do not necessarily cover all such possible situations and cases. The customer is responsible for correctly and safely using this product.
- (5) The power adapter that comes with the product covered by this document conforms to the region-specific standard. This fact must be taken into account when the product is to be used in some other country.
- (6) Renesas Electronics Corporation will not assume responsibility of direct or indirect damage caused by an accidental failure or malfunction in this product.

When disposing of this product:

Penalties may be applicable for incorrect disposal of this waste, in accordance with your national legislation.

Usage restrictions:

This product has been developed as a means of supporting system development by users. Therefore, do not use it as an embedded device in other equipment.

About product changes:

We are constantly making efforts to improve the design and performance of our product. Therefore, the specification or design of the product, or this user's manual, may be changed without prior notice.

About rights:

- (1) We assume no responsibility for any damage or infringement on patent rights or any other rights arising from the use of any information, products or circuits presented in this user's manual.
- (2) The information or data in this user's manual does not implicitly or otherwise grant a license to patent rights or any other rights belonging to Renesas or to a third party.
- (3) This user's manual and this product are copyrighted, with all rights reserved by Renesas. This user's manual may not be copied, duplicated or reproduced, in whole or part, without prior written consent from Renesas.

About diagrams:

Some diagrams in this user's manual may differ from the objects they represent.

Precautions for Safety

This chapter describes the precautions which should be taken in order to use this product safely and properly. Be sure to read and understand this chapter before using this product.

Contact us if you have any questions about the precautions described here.



WARNING

WARNING indicates a potentially dangerous situation that will cause death or heavy wound unless it is avoided.



CAUTION

CAUTION indicates a potentially dangerous situation that will cause a slight injury or a medium-degree injury or property damage unless it is avoided.

In addition to the two above, the following are also used as appropriate.

△ means WARNING or CAUTION.

Example:



CAUTION AGAINST AN ELECTRIC SHOCK

⊘ means PROHIBITION.

Example:



DISASSEMBLY PROHIBITED

● means A FORCIBLE ACTION.

Example:



UNPLUG THE POWER CABLE FROM THE RECEPTACLE.

WARNING
Warnings for Power Supply:

If the power cable of the power adapter that comes with the product does not fit the receptacle, do not alter the power cable and do not plug it forcibly. Failure to comply may cause electric shock and/or fire.

Use a power cable which complies with the safety standard of the country.

Do not touch the plug of the power cable when your hands are wet. This may cause electric shock.

This product is connected signal ground with frame ground. If yours developing product is transform-less (not having isolation transformer of power), this may cause electric shock. Also, this may give an un-repairable damage to this product and your developing product.

While developing, connect power of the product to commercial power through isolation transformer in order to avoid these dangers.

To eliminate differences in potential between the grounds of this product and of the user system, only connect the plug of the power cable to the outlet after connecting this product and the user system.

If other equipment is connected to the same branch circuit, care should be taken not to overload the circuit.



If you smell a strange odor, hear an unusual sound, or see smoke coming from this product, then disconnect power immediately by unplugging the power cable from the outlet.

Do not use this as it is because of the danger of electric shock and/or fire. In this case, contact your local distributor.

Before setting up this product and connecting it to other devices, turn off power or remove a power cable to prevent injury or product damage.

Warnings to Be Taken for Handling:

Do not modify this product. Personal injury due to electric shock may occur if this product is modified. Modifying the product will void your warranty.

Warning for Installation:

Do not set this product in water or areas of high humidity. Spilling water or some other liquid into the product may cause un-repairable damage.

Warning for Use Temperature:

The maximum allowable ambient temperature for using this product is 35 °C. Care should be taken that a maximum ambient temperature is not exceeded when this product is to be used.

 **CAUTION****Caution on the Power Adapter:**

Use only the supplied dedicated power adapter for this product.
Do not use the power adapter for other equipment.

Caution on Turning on the Power:

Observe the following specified order for the power-on and power-off procedures of the user system and this product. Doing otherwise may cause the user system or this product to fail.

Power ON: (1) This product ON, (2) User system ON

Power OFF: (1) User system OFF, (2) This product OFF

Caution on Handling This Product:

Exercise caution when handling the product. Be careful not to apply a mechanical shock.

Do not touch the connector pins of this product and the target MCU connector pins directly. Static electricity may damage the internal circuits.

When attaching and removing the cable, hold the plug of the cable and do not touch the cable. Do not pull this product by the communications interface cable or the flexible cable. Excessive flexing or force may break conductors.

 **CAUTION****Caution on System Malfunctions:**

If this product malfunctions because of interference like external noise, do the following to remedy the trouble.

Exit the FP6 Terminal, and shut OFF this product and the user system.

After a lapse of 10 seconds, turn ON the power of this product and the user system again, and then launch the FP6 Terminal.

Caution on Disposal:

Penalties may be applicable for incorrect disposal of this waste, in accordance with your national legislation.

European Union regulatory notices:

The WEEE (Waste Electrical and Electronic Equipment) regulations put responsibilities on producers for the collection and recycling or disposal of electrical and electronic waste. Return of WEEE under these regulations is applicable in the European Union only. This equipment (including all accessories) is not intended for household use. After use the equipment cannot be disposed of as household waste, and the WEEE must be treated, recycled and disposed of in an environmentally sound manner.

Renesas Electronics Europe GmbH can take back end of life equipment, register for this service at "<http://www.renesas.eu/weee>".

How to Use This Manual

Purposes and Target Readers

The purpose of this manual is to give users an understanding of the basic specifications and correct use of the PG-FP6. This manual is intended for users who are using the flash programmer in designing and developing a system that employs a Renesas Electronics microcontroller equipped with on-chip flash memory.

It is assumed that the readers of this manual have a basic knowledge of microcontrollers, Windows, and electrical and logic circuits.

Use this product after sufficiently confirming the manual of the microcontroller in use.
--

Conventions

- Note: Footnote for item marked with “Note” in the text.
- Caution: Information requiring particular attention
- Remark: Supplementary information
- Numeral representations: Binary ... xxxx or xxxxB
Decimal ... xxxx
Hexadecimal ... 0xXXXX or xxxxH
- “ ”: Any character or item on the screen that can be selected or input
- : Name of a button
- []: Name of a command, dialog box, tabbed page, option, or area on the screen

Terminology

The meanings of the terms used in this document are as follows.

Term	Meaning
FP6 main unit	Abbreviation of the flash memory programmer PG-FP6
FP6 Terminal	Windows® application including functions for creating or changing setting files for the FP6 and handling commands for the PG-FP6 main unit
FP6	Collective term for a system consisting of the FP6 main unit and FP6 Terminal
FP6 Gang Programmer	Windows® application for operating up to 12 FP6 main units and having a simultaneous programming function
MCU	Abbreviation of “microcontroller unit”
Target device	On-chip flash memory microcontroller from Renesas Electronics
Target system	User-designed board on which the target device is mounted
Setting file	FP6’s setting file (file extension: *.esf or .es6). This file contains settings regarding the programming environment such as the target device and options.
Program file	Program to be written to the MCU. For the FP6, the following file formats are supported. <RL78, 78K, and V850> a. Intel HEX format HEX file b. Intel HEX format HCUHEX file c. Motorola S-record format HEX file d. Motorola S-record format HCUHEX file e. RPI file (only supported for RL78 products) f. RPE file g. Binary file <RX family and SuperH family> a. Intel HEX format HEX file b. Motorola S-record format HEX file c. DDI file (only supported for SuperH products) d. RPI file e. RPE file f. Binary file <RH850 family, R8C family, Renesas Synergy™ family, RA family and RE family> a. Intel HEX format HEX file b. Motorola S-record format HEX file c. RPI file (not supported for R8C products) d. RPE file e. Binary file f. SFP file (only supported for some target devices of RA products) Note Only the ASCII character code (1 byte) is supported. Unicode is not supported.
Flash-option data	General term for MCU operation settings such as security settings
HEX file	HEX file of Intel HEX format type or Motorola S-record format type that does not include flash-option data
HCUHEX file	For details, refer to the following Web page. https://www.renesas.com/us/en/hcu
DDI file	File that contains data in multiple flash areas generated by the Flash Development Toolkit
RPI file	Image file generated by the RFP that combine usable HEX files and flash-option data
RPE file	An encrypted program file that has been generated by the encryption utility program
SFP file	An encrypted program file that has been generated by the Security Key Management Tool

Term	Meaning
Flash Development Toolkit	Software for programming the on-chip flash memory of Renesas MCUs. For details, refer to the following Web page. https://www.renesas.com/fdt
RFP	Abbreviation of “Renesas Flash Programmer”, software for programming the on-chip flash memory of Renesas MCUs. For details, refer to the following Web page. https://www.renesas.com/rfp
Parameter file	Information file specific to the target device (file extension: *.pr5 or .pr6). This file is for use by the FP6 Terminal and PG-FP6 main unit. Each parameter file holds parameter information required for programming of the flash memory in the target device.
Programming area	Area in the FP6 main unit for saving the parameter, settings, and program files
FINE	Single- or dual-line communications interface operating through the FINE pins of an MCU. Some of our MCUs support programming via single-line FINE.
ID authentication mode	One of the security features of the MCU. Connection of the flash programmer is protected by ID authentication. For details, refer to the user’s manual of the MCU.
Command protection mode	One of the security features of the MCU. Execution of individual commands (e.g., the erase command) can be restricted. For details on operations while the security feature is enabled, refer to the user’s manual of the MCU.
TSIP	Dedicated hardware secure IP (Trusted Secure IP) for managing encryption keys. For details, contact a Renesas Electronics sales office.
DLM	Management to maintain security in the entire life cycle of the device (device life-cycle management). For details, refer to the user’s manual of the target device.
ID Tag	Data for programming in the data flash memory of some V850 target devices. For details, refer to the user’s manual of the target device.
Renesas Partition Data File	File including the information on the boundary setting output from the e ² studio for the RA family
SWD	Two-wire communications interface using the debug communications pins of the MCU
Security Key Management Tool	The Security Key Management Tool is a key-wrapping tool for use with key-management systems that use security IP modules incorporated in Renesas MCUs and MPUs. For details, refer to the following Web page. https://www.renesas.com/software-tool/security-key-management-tool

Replacing Terms

Some terms used in this application should be replaced as shown in the tables below, depending on the target device to be used.

- When an RL78 MCU is to be used:

Term in This Application	To be Replaced with
Access window (AW)	Flash shield window

- When an RH850 with an extended user area is to be used:

Term in This Application	To be Replaced with
User Boot Area	Extended user area

- When an RH850 with an extended data area is to be used:

Term in This Application	To be Replaced with
Data Flash	Extended data area

- When an RH850 with a double map mode is to be used:

Term in This Application	To be Replaced with
Dual mode	Double map mode
Linear mode	Single map mode

Term in This Application	To be Replaced with
Config Area	Configuration setting area Option-setting memory Remark: The term differs with the target device.

- When an RA with MRAM is to be used:

Term in This Application	To be Replaced with
Flash memory	MRAM
Flash area	MRAM area

Table of Contents

1. Overview	20
1.1 Features	20
1.2 Supported Microcontrollers	20
1.3 FP6 System Configuration	21
1.4 Optional Products	22
1.5 Operating Environments	22
1.5.1 Hardware environment	22
1.5.2 Software environment	22
1.6 List of Specifications	23
1.7 Formats of Program Files	24
1.7.1 Intel HEX format	24
1.7.2 Motorola S format	24
1.7.3 RPI files	24
1.7.4 RPE files	24
1.8 Regulatory Compliance Notices	25
2. FP6 Main Unit: Names and Functions of Parts	26
2.1 FP6 Control Panel	26
2.2 FP6 Connectors	27
3. Software Installation	30
3.1 Obtaining Software	30
3.2 Installation	30
3.2.1 Notes on installation	31
3.3 Uninstallation	32
4. Usage of the FP6 Terminal	33
4.1 Main Window	33
4.2 Creating a New Setting	35
4.2.1 [Create New Setting] dialog box	35
4.3 [Setup] Dialog Box	36
4.3.1 [Program Files] tabbed page	37
4.3.2 [Operation Settings] tabbed page	39
4.3.3 [Block Settings] tabbed page	42
4.3.4 [Flash Options] tabbed page	44
4.3.5 [Connect Settings] tabbed page	50
4.4 Menu Bar	54
4.4.1 [File] menu	54
4.4.2 [Programmer] menu	57
4.4.3 [Target Device] menu	64
4.5 Toolbar	68
4.6 Example of Operation Using the FP6 Terminal	69
4.6.1 Installing the FP6 Terminal and USB driver	69
4.6.2 Connecting the FP6 to the host PC	69
4.6.3 Connecting the target system	69
4.6.4 Starting up the FP6 Terminal	70
4.6.5 Setting up a programming environment	71
4.6.6 Executing the [Start] command	73
4.6.7 System shutdown	74
5. Usage in Standalone Mode	75
5.1 Details of Buttons, Message Display, and Status LEDs	75
5.2 Standalone Operation Menu	77

5.2.1	[Commands] menu	77
5.2.2	[Project] menu	78
5.2.3	[Utility] menu	78
6.	Usage of the Remote Connector	79
6.1	Remote Interface Mode	79
7.	Usage of Communications Commands.....	80
7.1	Starting the Communications Software	80
7.1.1	Connecting the system.....	80
7.1.2	Starting the FP6	80
7.1.3	Starting communications software	80
7.2	Command Lists	81
7.3	Description of Commands.....	83
7.4	Description of FP6 Control Commands	84
7.4.1	autocon command.....	84
7.4.2	brt command	85
7.4.3	clear command.....	86
7.4.4	conf command.....	87
7.4.5	downprm command.....	89
7.4.6	downset command	89
7.4.7	fcks command	90
7.4.8	files command	91
7.4.9	fp_mode command	92
7.4.10	hex command.....	93
7.4.11	hlp command.....	94
7.4.12	lod command.....	95
7.4.13	prm command	97
7.4.14	progarea command	98
7.4.15	res command	99
7.4.16	selftest command	100
7.4.17	serno command	101
7.4.18	set_auth_id command.....	102
7.4.19	sound command.....	103
7.4.20	speed_mode command.....	104
7.4.21	srec command.....	105
7.4.22	trc command	106
7.4.23	upprm command	107
7.4.24	upset command.....	107
7.4.25	ver command	108
7.5	Description of FP6 Device Commands.....	109
7.5.1	bln command.....	109
7.5.2	clr command.....	110
7.5.3	con command.....	110
7.5.4	dcon command.....	110
7.5.5	dln command.....	111
7.5.6	ep command	112
7.5.7	ers command	113
7.5.8	ers_chip command	113
7.5.9	gdi command.....	114
7.5.10	ged command	115
7.5.11	gid command.....	115
7.5.12	glb command.....	116
7.5.13	gob command	116
7.5.14	gof command	117

7.5.15	gos command.....	117
7.5.16	got command	118
7.5.17	gsc command.....	118
7.5.18	gtm command	119
7.5.19	idc command.....	120
7.5.20	opb command	121
7.5.21	otp command	121
7.5.22	pfo command	122
7.5.23	prg command	123
7.5.24	read command	124
7.5.25	rsc command.....	125
7.5.26	scf command.....	125
7.5.27	sed command.....	126
7.5.28	sid command.....	126
7.5.29	sig command.....	127
7.5.30	slb command.....	128
7.5.31	spd command.....	129
7.5.32	stm command.....	129
7.5.33	sum command.....	130
7.5.34	vrf command	130
8.	Encryption Utility Program	131
8.1	Exit Code	131
8.2	Command-line Syntax.....	131
8.3	Start Options	131
9.	Renesas Flash Programmer Utility Program.....	132
10.	Connectors and Cables	133
10.1	Power-Supply Connector	133
10.2	Serial Connector	134
10.2.1	Serial cable connected to the 9-pin D-sub serial connector	135
10.3	USB Connector	135
10.3.1	USB cable	135
10.4	Target Connector	136
10.4.1	Target cable (14-pin type).....	137
10.4.2	14-pin to 16-pin conversion adapter for the E1 emulator.....	138
10.4.3	20-pin conversion adapter for the PG-FP6	139
10.5	GND Connector	140
10.5.1	GND cable.....	141
10.6	Remote Connector.....	141
11.	Examples of Connections with the Target Device.....	143
12.	Troubleshooting	144
12.1	FAQ.....	144
12.2	Problems during Operation.....	144
12.2.1	When an error produces the message 'ERROR: 004 No response'	144
12.2.2	When an error produces the message '023 Inv. Sig. addr.'	145
12.2.3	When an error produces the message 'Communication failure or timeout'	145
13.	Points for Caution	147
13.1	Checking before Connection	147
13.2	Manipulating the User Boot Mat	147
13.3	Erasing a Chip	147

13.4	Auto-Padding with 0xFF.....	147
13.5	Wide Voltage Mode.....	148
13.6	Switching to Dual Mode.....	148
13.7	Switching to Double Map Mode.....	149
13.8	RPI Files.....	149
13.9	Verification after Protecting the MCU.....	150
13.10	Writing to the Code Flash Memory of an RL78/F2x for Secure Boot.....	150
13.11	SWD Interface Connection.....	150
13.12	Security Memory Protection Unit (MPU).....	150
13.13	Procedure for Erasing Data Flash Memory in an RL78/F2x Device.....	151
13.14	Erase Command.....	151
14.	Maintenance and Warranty.....	152
14.1	Maintenance.....	152
14.2	Warranty.....	152
14.3	Repair Provisions.....	152
14.4	How to Make Request for Repair.....	153
Appendix A.	Messages.....	154
A.1	Messages Defined in the FP6 Terminal.....	154
A.2	Error Messages Produced by the FP6 Main Unit.....	156
A.3	Error Messages Produced by the FP6 Main Unit that are Only Displayed in the Terminal.....	164
A.4	List of Security and Safety Functions of the Target Device that May Affect the Operation of the Programmer.....	165
Appendix B.	Supplementary Information.....	166
B.1	32-Bit CRC Method.....	166
B.2	Division Method.....	167
B.3	16-Bit CRC Method.....	168
Appendix C.	Equivalent Circuits of the Target Interface.....	170
Appendix D.	Electrical Specifications of the Remote Interface.....	171
D.1	Absolute Maximum Ratings ($T_A=0$ to 40°C).....	171
D.2	DC Characteristics ($T_A=0$ to 40°C , $C=0\text{pF}$ (Unloaded Condition)).....	171
D.3	AC Characteristics ($T_A=0$ to 40°C , $C=0\text{pF}$ (Unloaded Condition)).....	172
D.3.1	Standard mode.....	172
D.3.2	Bank mode.....	174
D.3.3	Simple mode.....	176
Appendix E.	Electrical Specifications of the Target Interface.....	179
E.1	Absolute Maximum Ratings ($T_A=0$ to 40°C).....	179
E.2	DC Characteristics ($T_A=0$ to 40°C).....	180
Appendix F.	Setting the Multiplier.....	181
F.1	RX110, RX111, RX113, RX130, RX13T.....	181
F.2	RX140.....	181
F.3	RX220.....	181
F.4	RX230, RX231, RX23E-A, RX23W, RX23E-B.....	181
F.5	RX23T, RX24T, RX24U.....	181
F.6	RX260, RX261.....	181
F.7	RX610, RX621, RX62N.....	182
F.8	RX62G, RX62T.....	182
F.9	RX630, RX631, RX63N.....	182
F.10	RX634.....	182

F.11	RX63T	183
F.12	78K0/Dx2, 78K0/Fx2, 78K0/Kx2, 78K0/Kx2-C, 78K0/Lx2, 78K0/Lx3, 78K0/Lx3-M, UPD78F0730, UPD78F8019, UPD78F8020, UPD78F8024/UPD78F8025, UPD78F8032, UPD78F8077	183
F.13	V850E/IA3, V850E/IA4, V850ES/Dx2, V850ES/Fx2, V850ES/IK1, V850E/Sx2-H, V850E/lx3, V850ES/Hx2, V850ES/IE2	183
F.14	V850E/Sx3-H	183
F.15	V850ES/Sx2, V850ES/Jx2	183
F.16	V850ES/Jx3, V850ES/Sx3	184
F.17	V850ES/Kx1, V850ES/Kx1+, V850ES/Kx2	184
F.18	V850ES/Jx3-L	184
F.19	V850ES/Hx3, V850ES/Fx3	184
F.20	V850ES/Jx3-H, V850ES/Jx3-U, V850ES/Jx3-E	184
F.21	V850E/Dx3, V850E/lx4, V850E/lx4-H	185
F.22	V850ES/Fx3-L	185
F.23	V850ES/Dx4, V850ES/Dx4-H	185
F.24	V850E2/Fx4, V850E2/Fx4-M	185
F.25	V850E2/Fx4-L	185
F.26	V850E2/Fx4-G	186
F.27	V850E2/Mx4	186
F.28	SH7146, SH7149	186
F.29	SH7214, SH7216	186
F.30	SH7253	187
F.31	SH72A0	188
F.32	SH72A2	188

1.Overview

The FP6 is a tool that is used to erase, write, and verify programs on a Renesas Electronics on-chip flash memory MCU on the target system.

1.1 Features

- Standalone programming
- Programming through the dedicated FP6 Terminal GUI under PC control
- Selectable from among up to eight programming environments
- Specialized for use on production lines (command control via serial communication and remote control of signals from external devices)
- Programming of a unique code to a designated area of flash memory
- The FP6 Manager allows the customization required in development and mass-production, such as prevention of a programming operator from modifying the programming settings.
- Self-testing function
- Support for simultaneous programming by FP6 Gang Programmer gang programming GUI, with the use of up to 12 PG-FP6 units*¹
- Enhancement of the FP6 Manager and the encryption of program files to improve security against theft*²
- Compatibility with the PG-FP5 interface allows the utilization of setting files that were for use with the PG-FP5.

Notes: 1. FP6 Terminal V1.03.00 or a later version

2. FP6 Terminal V1.04.00 or a later version

1.2 Supported Microcontrollers

Microcontrollers supported by the FP6 are listed on the Web page at the following link:

<https://www.renesas.com/pg-fp6>

1.3 FP6 System Configuration

The system configuration of the FP6 is shown below.

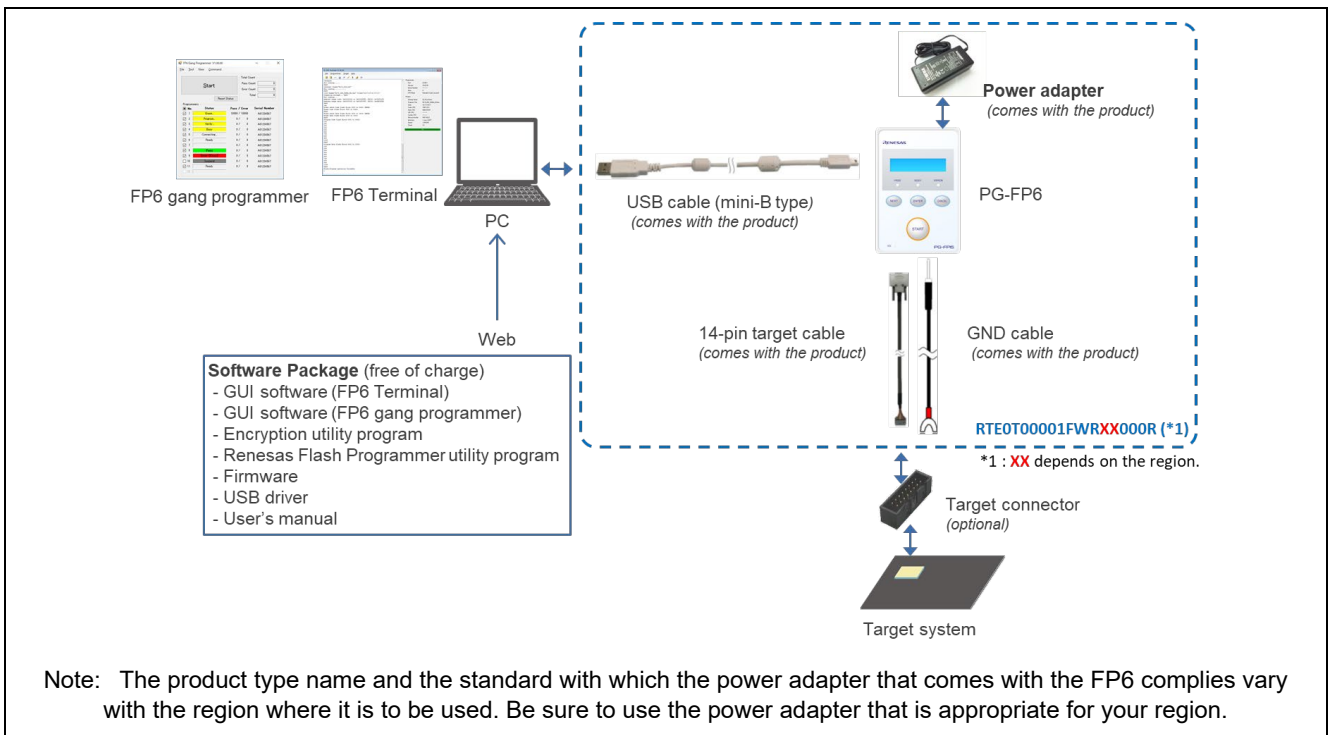

Figure 1.1 Image of FP6 Connection

Table 1.1 Product Type Names for Ordering

Target Region	Product Type Name	Plug Shape				Voltage Range ^{*1}
Japan	RTE0T00001FWRJP000R					AC: 100-240 V
		A				
Europe and USA	RTE0T00001FWREA000R					
		SE	C	BF	A	
China, Hong Kong, Chinese Taipei, South Korea, Singapore	RTE0T00001FWRAS000R					
		SE	C	BF	A	

Note: This voltage range is for the power adapter. For the voltage intended for the power cable, check the indication around the plug.

Cautions:

1. Since regulations that apply to the FP6 vary with the region, we cannot ship a product to a region other than that from which the order was made. For example, if you place an order in Japan, you cannot purchase a product intended for Europe and the USA. Please purchase the product from a Renesas Electronics Corporation representative (responsible for sales) or distributor in the region where it is to be used.
2. If you wish to know which model is available in a region not included in the above table, please contact either a Renesas Electronics Corporation representative (responsible for sales) or distributor.
3. The power adapter that comes with the FP6 complies with the regulations that are applicable in the target region. Its plug is also in the shape that is usable in that region.

1.4 Optional Products

We provide useful optional products (separately sold) for use with the FP6.

- 14-pin to 16-pin conversion adapter for the E1 emulator (type name: QB-F14T16-01)
- 20-pin conversion adapter for the PG-FP6 (type name: RTE0T00001FWRB0000R)
- User system interface cable (20-pin to 20-pin) for the E2 emulator (type name: RTE0T00020KCAC0000J)
- User system interface cable (20-pin to 10-pin) for the E2 emulator (type name: RTE0T00020KCAC1000J)

For details on the optional products, refer to the following Web page in the Development Tools section of the Renesas site.

<https://www.renesas.com/pg-fp6>

The optional products are also available for purchase from Naito Densai Machida Mfg. Co., Ltd. Contact the company through the following site for details.

- Web site for Naito Densai Machida Mfg Co., Ltd:

<https://www.ndk-m.co.jp>

1.5 Operating Environments

1.5.1 Hardware environment

- Host PC
 - Processor: At least 1 GHz
 - Main memory: At least 2 Gbytes; 4 Gbytes or more recommended
 - Display: Resolution should be at least 1024 x 768.
 - Interface: USB2.0 or serial interface (RS-232C)

1.5.2 Software environment

- Operating System
 - Windows 10 (32-bit edition, 64-bit edition)
 - Windows 11

1.6 List of Specifications

Table 1.2 List of Specifications

Category	Items	Specifications
Hardware specifications	Operating power supply	<ul style="list-style-type: none"> Supplied via the power adapter (5 V, 2 A): recommended USB-bus power supply (VBUS 4.5 V min./500 mA max.)
	Operating environment condition	Temperature: 5°C to 35°C (no condensation)
	Storage environment condition	Temperature: -15°C to 55°C (no condensation)
	Package size (H × W × D)	140 × 95 × 30 mm (not including projections)
	Weight	Approximately 245 g
	Host PC interface	Target host PC: Refer to section 1.5, Operating Environments. USB connector: USB 2.0 (mini-B type) Serial port: 9-pin D-Sub male port for RS-232C*1
	Target interface	15-pin D-Sub female target connector Power supply: 1.8 V to 5.5 V, 500 mA max.*2
	Remote interface	15-pin D-Sub female remote connector Interface level: 3.3 V
FP6 functions	Operation of the FP6 main unit	<ul style="list-style-type: none"> Use of the GUI (FP6 Terminal) Use of the gang programming GUI (FP6 Gang Programmer) Use of communications commands Standalone operation with the use of the buttons of the FP6 main unit Remote interface operation using signals from an external control unit
	Selectable programming environment	Up to eight target environments are selectable for the programming area (384 MB max.)
	Security functions of the FP6 main unit	<ul style="list-style-type: none"> Pattern authentication when the main unit is started Password authentication when the settings of the security function are changed A limit on the number of times authentication can be attempted Reading of RPE files Restricting the operation of the FP6 main unit (in terms of the number of times the target device can be programmed and restriction of the execution of commands) Encrypting the data stored in the FP6 main unit
Attached items	Power adapter	Power adapter for each region*3
	USB cable	Approximately 2 m
	Target cable	14-pin type Cable length: Approximately 42 cm
	GND cable	Approximately 1 m

Notes: 1. Connecting to the host PC has to use a cross cable.

2. The maximum power-supply current is 100 mA when USB bus power is being supplied; however, this depends on the performance of the USB host in terms of the supply of power.

3. The power adapter that comes with the FP6 varies with the region where it is to be used. For the product type names, see Table 1.1, Product Type Names for Ordering.

1.7 Formats of Program Files

For a HEX file to be readable by the FP6, it must have the correct format and satisfy the following conditions. If a program file with a non-supported format is read, an error will occur.

1.7.1 Intel HEX format

- The format file ends with the end record.
- All lines consist solely of record types 00 to 05.

1.7.2 Motorola S format

- The format file ends with the end record (S7, S8, or S9).
- All lines consist solely of record types S0 to S9 (excluding S4).

1.7.3 RPI files

An RPI file is an image file which combines a program file and flash option data and is generated by using the RFP. For details on the RFP, refer to the following Web page.

<https://www.renesas.com/rfp>

1.7.4 RPE files

An RPE file is a file in which a program file is encrypted and can be generated by the encryption utility program that comes with this product. For how to generate such files, refer to chapter 8, Encryption Utility Program.

1.8 Regulatory Compliance Notices

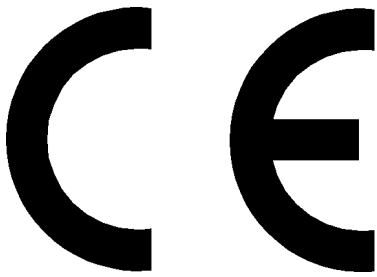

This equipment complies with the EMC protection requirements.

WARNING

This is a 'Class A' equipment. This equipment can cause radio frequency noise when used in the residential area. In such cases, the user/operator of the equipment may be required to take appropriate countermeasures under his responsibility.

CAUTION

This equipment should be handled like a CMOS semiconductor device. The user must take all precautions to avoid build-up of static electricity while working with this equipment. All test and measurement tool including the workbench must be grounded. The user/operator must be grounded using the wrist strap. The connectors and/or device pins should not be touched with bare hands.

WEEE Directive (2012/19/EU)

The Waste Electrical and Electronic Equipment Regulations 2013

For customers in the UK & European Union



The WEEE (Waste Electrical and Electronic Equipment)

regulations put responsibilities on producers for the collection and recycling or disposal of electrical and electronic waste. Return of WEEE under these regulations is applicable in the UK and European Union.

 This equipment (including all accessories) is not intended for household use. After use the equipment cannot be disposed of as household waste, and the WEEE must be treated, recycled and disposed of in an environmentally sound manner.

Renesas Electronics Europe GmbH can take back end of life equipment. Register for this service at;

<https://www.renesas.com/eu/en/support/regional-customer-support/weee>

2.FP6 Main Unit: Names and Functions of Parts

This chapter gives the names and functions of the parts on the FP6 main unit.

2.1 FP6 Control Panel

Indicators and buttons are placed on the top of the FP6.

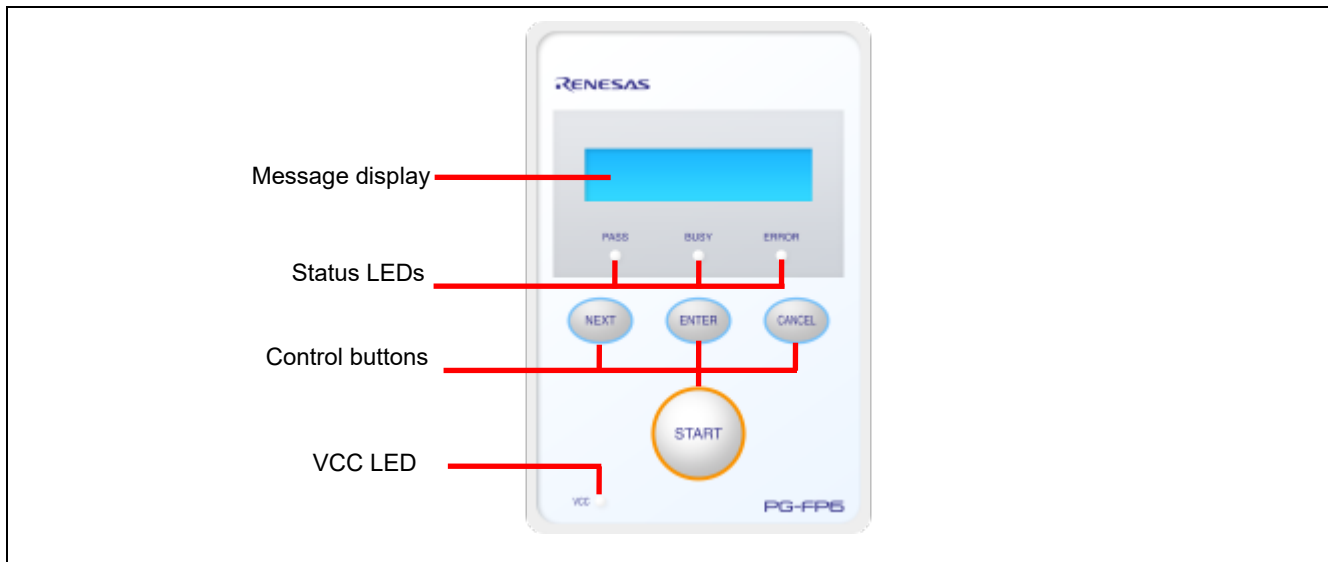

Figure 2.1 FP6 Top View <Control Panel>

(1) Indicators

- **Message display** An LCD display of 16 × 2 characters that indicates the operating mode or menus.
It is mainly used when the FP6 is in standalone mode.
- **Status LEDs** These LEDs show the operating state of the FP6.
PASS (blue) indicates a normal end, BUSY (orange) indicates processing in progress, and ERROR (red) indicates an abnormal end.
- **VCC LED** This LED is illuminated (green) when power is being supplied to the user system.

(2) Buttons

- **[NEXT] button** Proceeds to the next menu item.
- **[ENTER] button** Selects the item shown in the message display.
- **[CANCEL] button** Cancels the current selection and returns to the previous menu item. The currently running command cannot be stopped, except for the [Read] command.
- **[START] button** Executes the [Start] command with the current active-programming-area setting.

2.2 FP6 Connectors

The power-supply connector, serial port, and USB connector are placed on the host interface side of the FP6.

The target connector, GND connector, and remote connector are placed on the target connector side of the FP6.

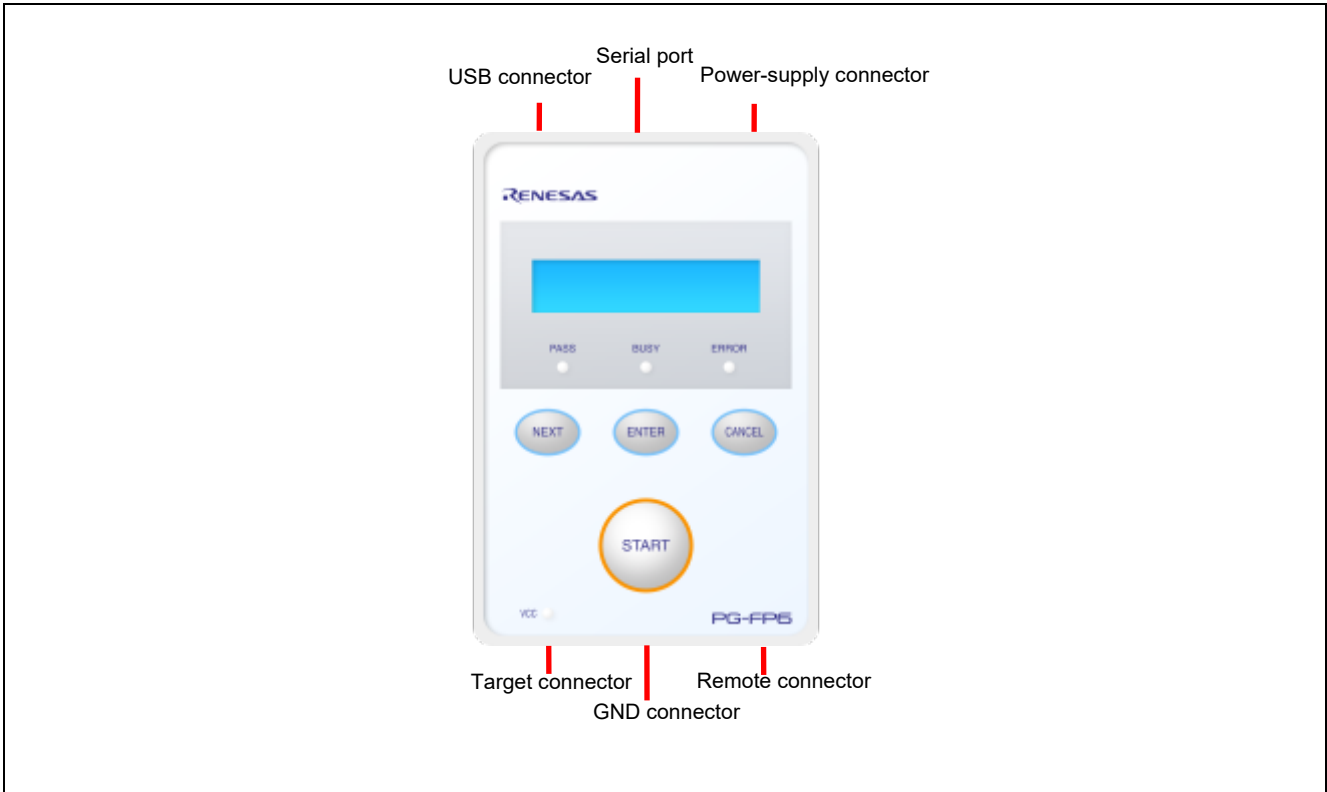

Figure 2.2 FP6 Top View <Connectors>

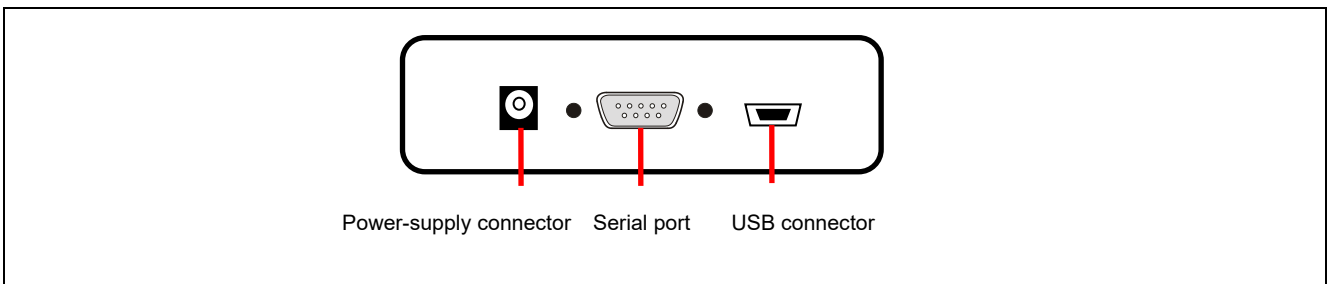

Figure 2.3 FP6 Host Interface Side

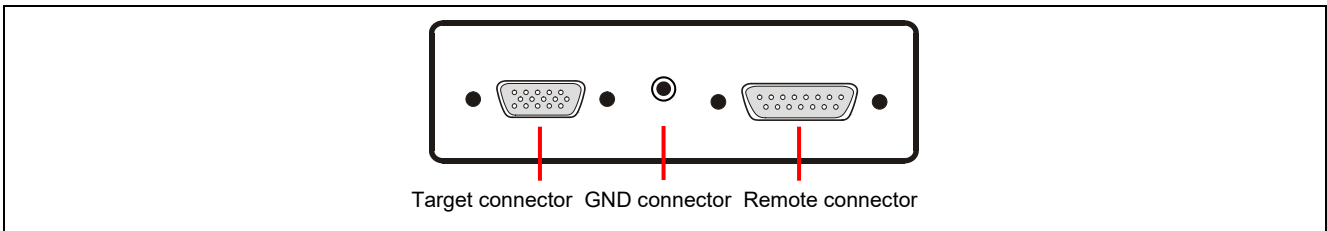

Figure 2.4 FP6 Target Connector Side

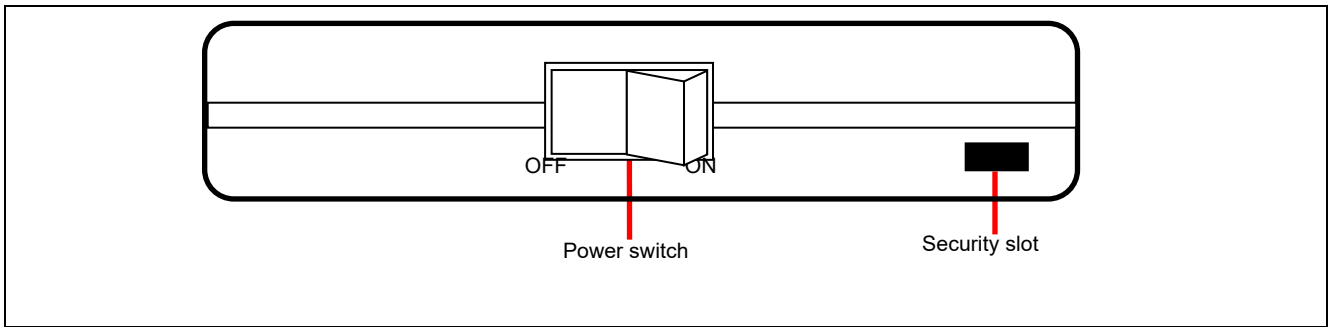

Figure 2.5 Power Switch

(1) Power-supply connector

Connect the power-supply connector to the power adapter for your region. For details on the power-supply connector specifications, refer to chapter 10, Connectors and Cables.

Note: Do not use a power adapter other than that included with the PG-FP6.

(2) Serial port

Communication is established by connecting the host PC serial port and the FP6 serial port via a serial cable (RS-232C crossover cable). The data transfer conditions are as follows.

- Data transfer speed: 9,600 bps, 19,200 bps, 38,400 bps, 57,600 bps, or 115,200 bps
- Data bit: 8 bits
- Parity: none
- Stop bit: 1 bit
- Flow control: hardware

The transfer speed can be changed although it is set to 9,600 bps by default. For details on the serial connector specifications, refer to chapter 10, Connectors and Cables.

(3) USB connector

Communication is established by connecting the FP6 USB connector (mini-B type) and the host PC USB port via a USB cable. This connector conforms to USB 2.0 standards. For details on the USB connector specifications, refer to chapter 10, Connectors and Cables.

(4) Target connector

Connect the target connector to the target system via the target cable. For details on the target connector specifications, refer to chapter 10, Connectors and Cables.

(5) GND connector

To reinforce the GND, connect the GND connector of the FP6 and the GND of the target system via the GND cable. For details on the GND connector specifications, refer to chapter 10, Connectors and Cables.

Note: The FP6 and target system may be damaged if there are differences in potential between the grounds of the FP6 and of the target system. Use the GND cable to eliminate differences in potential before connecting the target cable.

(6) Remote connector

The FP6 can be remote controlled by connecting the remote connector and an external control device. For details on remote operation, refer to chapter 6, Usage of the Remote Connector, and chapter 10, Connectors and Cables.

(7) Power switch

The power switch turns on/off the FP6.

(8) Security slot

This is a security slot for the Kensington lock.

3. Software Installation

This chapter explains how to install software.

3.1 Obtaining Software

Download the PG-FP6 software from the following Web page.

<https://www.renesas.com/pg-fp6>

Note: We recommend the use of the latest version of software to assure the correct operation of the FP6.

3.2 Installation

This section explains the installation procedure for the PG-FP6 software.

Table 3.1 Installation

Item	Method
PG-FP6 software	Execute the downloaded executable file (PG-FP6_Package_Vxxx.exe) and follow the directions on the installer screen. After installation, the USB driver detects the FP6 by plug-and-play.

3.2.1 Notes on installation

- (1) Basically we recommend using the latest version.
- (2) You might be asked to reboot your computer after installing the FP6. Be sure to close all other applications before rebooting your computer.
- (3) You must have administrator privileges to install the FP6.
- (4) The FP6 can only be installed in a folder that is named using ASCII characters (excluding the 11 characters / * : < > ? | " \ ; , and character strings that begin and end with a space). The FP6 might not operate correctly if installed in a folder that is named using other characters.
- (5) The FP6 cannot be installed from a network drive or on a network drive.
- (6) The installer does not specify environment variable paths. If these paths are required, add them after installation.
- (7) The Microsoft .NET Framework and the Microsoft Visual C++ runtime libraries are required to run the installer. If the Microsoft .NET Framework and the Microsoft Visual C++ runtime libraries are not installed, the FP6 Terminal will install them.
- (8) Make sure that your host PC is connected to the network before installing the program. If you wish to install the program on a host PC that is not connected to the network, first go to the Microsoft Download Center and install the Microsoft .NET Framework 4.5.2 or later before installing the FP6 Terminal.
- (9) If the installer is started on a non-Japanese version of Windows and the path contains multi-byte characters, it will cause an error, and the installer will not start.
- (10) The following folders created after installation (including the files under the folders) contain files required for the tools to operate. Do not delete them.
(Windows is the 32-bit edition and the system drive is C:)
C:\Program Files\Renesas Electronics\Programming Tools\
(Windows is the 64-bit edition and the system drive is C:)
C:\Program Files (x86)\Renesas Electronics\Programming Tools\
(11) To change the folder of the installed tools, uninstall all software related to CS+ (integrated development environment from Renesas), the FP6 Terminal, and the USB driver, and install them again.
(12) In the environment where CS+, the FP6 Terminal, and the USB driver for the FP6 are installed, the FP6 Terminal and the USB driver for the FP6 are included in the target software of the CS+ integrated uninstaller. If you do not wish to delete them, exclude them from the uninstallation targets.
(13) If a CS+ instance launched via Rapid Start is in the notification area (system tray) during installation, the following error message will appear. Exit the application, and run the installer again.

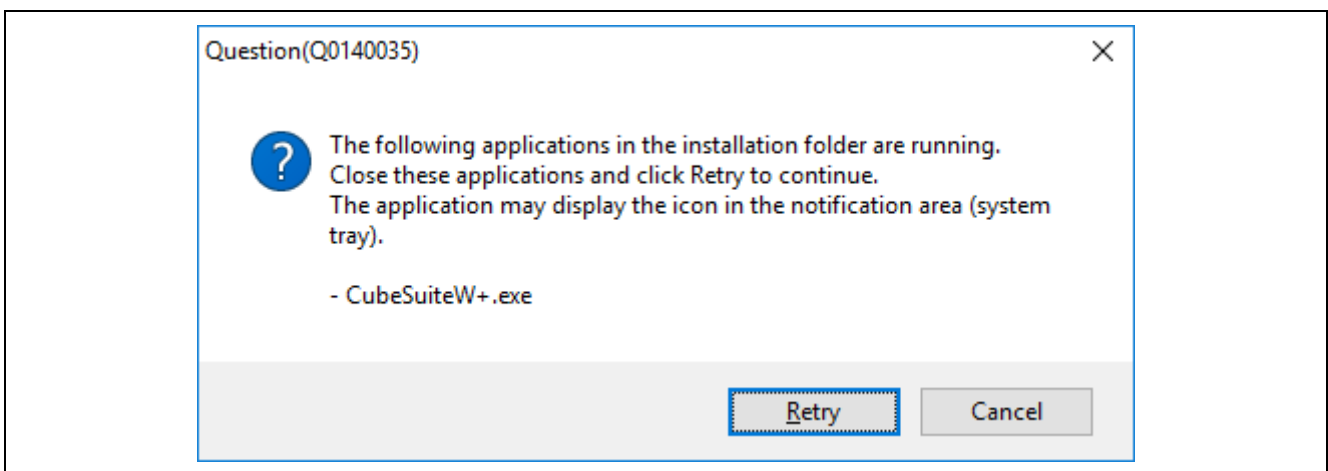

Figure 3.1 Message Dialog Box (Question (Q0140035))

3.3 Uninstallation

This section explains how to uninstall the PG-FP6 software. The uninstallation order is not prescribed.

Table 3.2 Uninstallation

Item	Method
PG-FP6 software	Use [Add or Remove Programs] on the Control Panel to uninstall the FP6 Terminal and the USB driver. The names are [PG-FP6] and [Renesas USB Driver x86 for PG-FP6] (or [Renesas USB Driver x64 for PG-FP6]), respectively.

4.Usage of the FP6 Terminal

4.1 Main Window

The main window of the FP6 Terminal that has been started up is shown below.

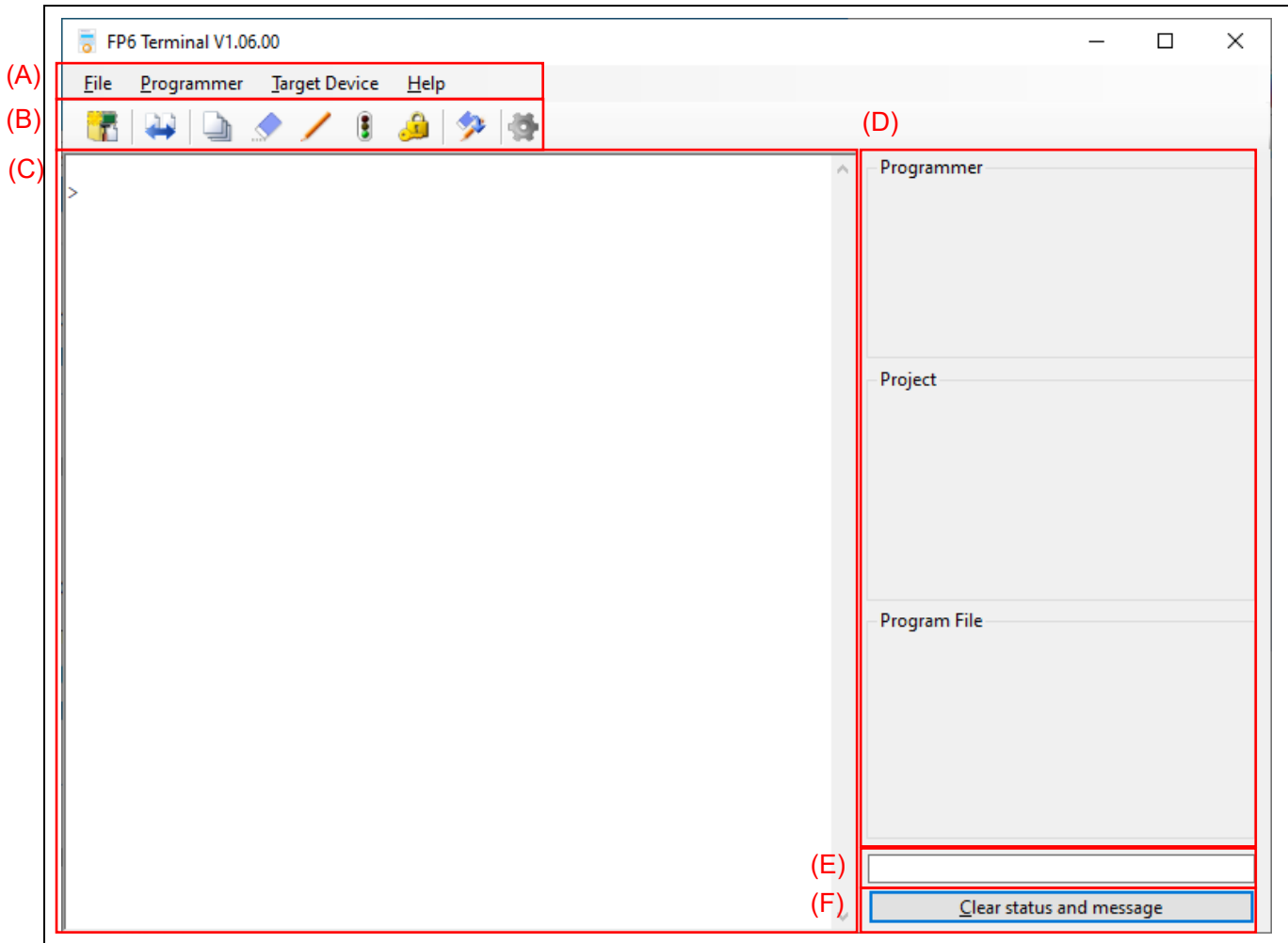

Figure 4.1 Main Window

Table 4.1 Main Window

	Name	Description	Refer to
(A)	Menu bar	Commands executable through the FP6 Terminal	4.4
(B)	Toolbar	Frequently used commands (provided as buttons)	4.5
(C)	Console window	Execution result and log of commands	-
(D)	Parameter window	Programming parameter settings	-
(E)	Status bar	State of command execution indicated by colors and messages	-
(F)	[Clear status and message] button	Clears state information and messages.	-

(A) Menu bar

This is the menu for operating the programmer. For details on the menu bar, see section 4.4, Menu Bar.

(B) Toolbar

The frequently used menu items can be executed by clicking on the buttons. For details on the toolbar, see section 4.5, Toolbar.

(C) Console window

This window shows the execution result and log of commands.

Note that log entries older than the 3000th line are automatically deleted.



(D) Parameter window

This window shows the settings acquired from the FP6 main unit when a setting file or a program file is downloaded, the FP6 main unit is connected, or the active programming area is changed. However, the information on connection with the target device is not displayed when “Restrict Upload from FP6” is selected in the [FP6 Security Manager] dialog box (see Figure 4.23).

(E) Status bar

The current state of the FP6 and the result of command execution are displayed. This facility is effective only when a command is executed from the menu bar. The state shown on this bar is not updated when a command is executed through the console window.

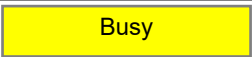
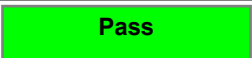
Table 4.2 Status Information

Status	Description
	Command execution is in progress.
	Command execution ended normally.
	Command execution failed.

(F) [Clear status and messages] button

The displays in the console window and status bar are cleared and the states of the LEDs of the FP6 are cleared.

4.2 Creating a New Setting

4.2.1 [Create New Setting] dialog box

Selecting [File]-[New Setting File...] from the menu bar opens the [Create New Setting] dialog box, as shown below.

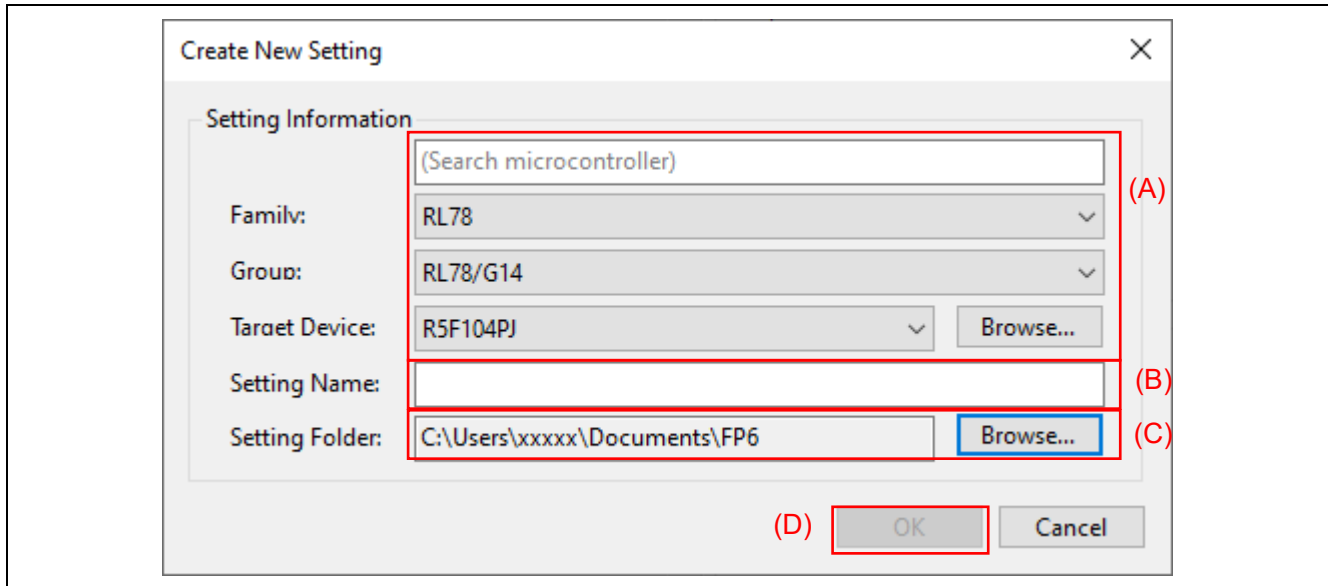

Figure 4.2 [Create New Setting] Dialog Box

(A) Target device

Select the family, group, and type name of the target device.

Entering the group or type name of the target device in [(Search microcontroller)] initiates a search for the target device and displays the details of the first target device to have matched.

Remark: Using the [Browse] button is not generally necessary.

(B) Setting name

Specify the name of a setting to be created.

Remarks:

1. Since the setting name is used for a setting File name, only use characters that are allowed for file names.
2. Up to 46 alphanumeric characters can be used for each setting name.

(C) Folder

Specify the path to the folder in which a setting File will be created.

(D) OK

Click on the [OK] button to create a setting File in the specified folder and open the [Setup] dialog box.

4.3 [Setup] Dialog Box

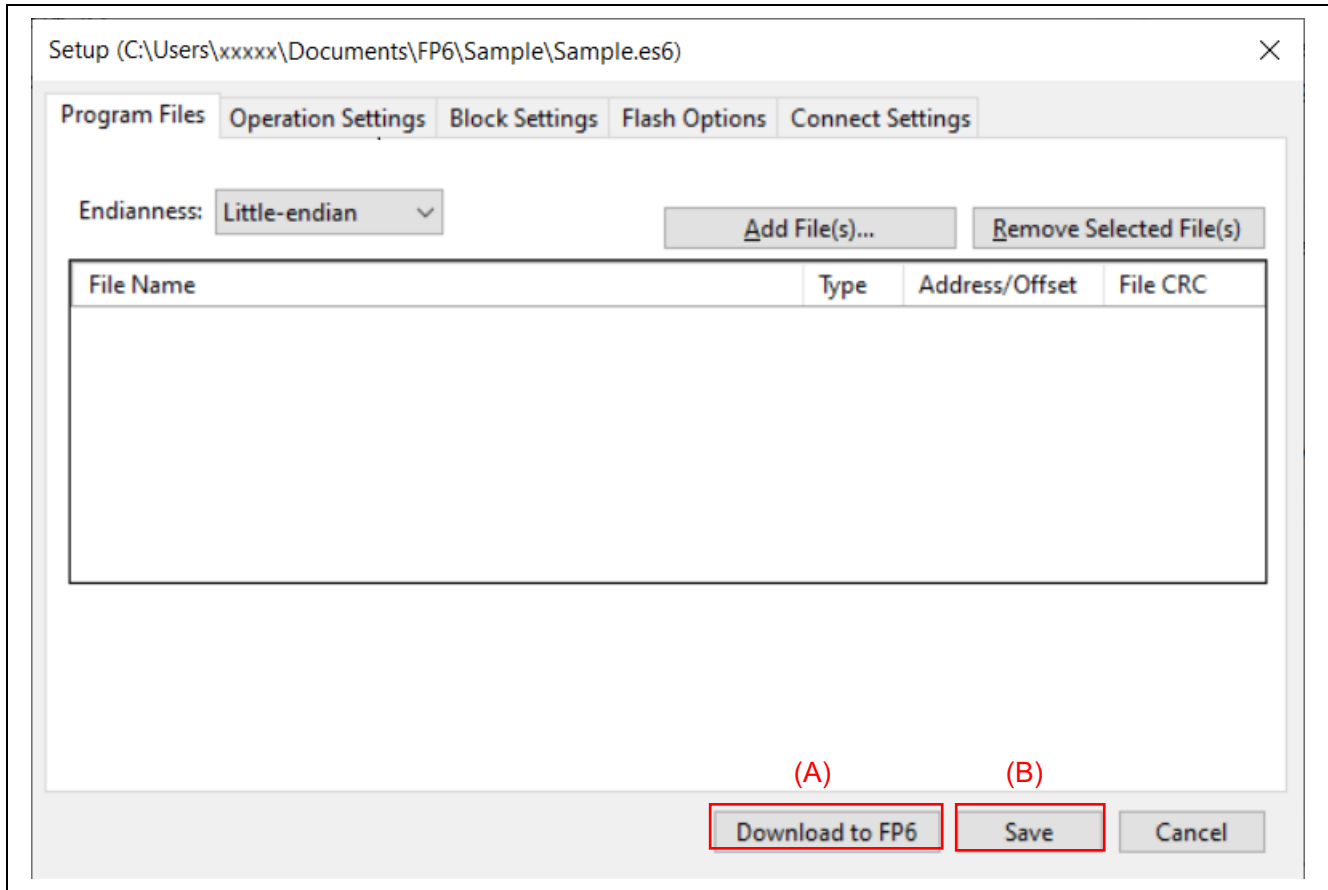

Figure 4.3 [Setup] Dialog Box

(A) [Download to FP6] button

Clicking on this button applies the changes made in the [Setup] dialog box to the setting file, and closes the [Setup] dialog box. In addition, the setting file, parameter file, and program file are downloaded to the FP6. This button is non-active when the FP6 is not connected.

(B) [Save] button

Clicking on this button applies the changes made in the [Setup] dialog box to the setting file, and closes the [Setup] dialog box. Unlike the [Download to FP6] button, no files are downloaded to the FP6.

4.3.1 [Program Files] tabbed page

The [Program Files] tabbed page allows you to select the files to be written to the target device.

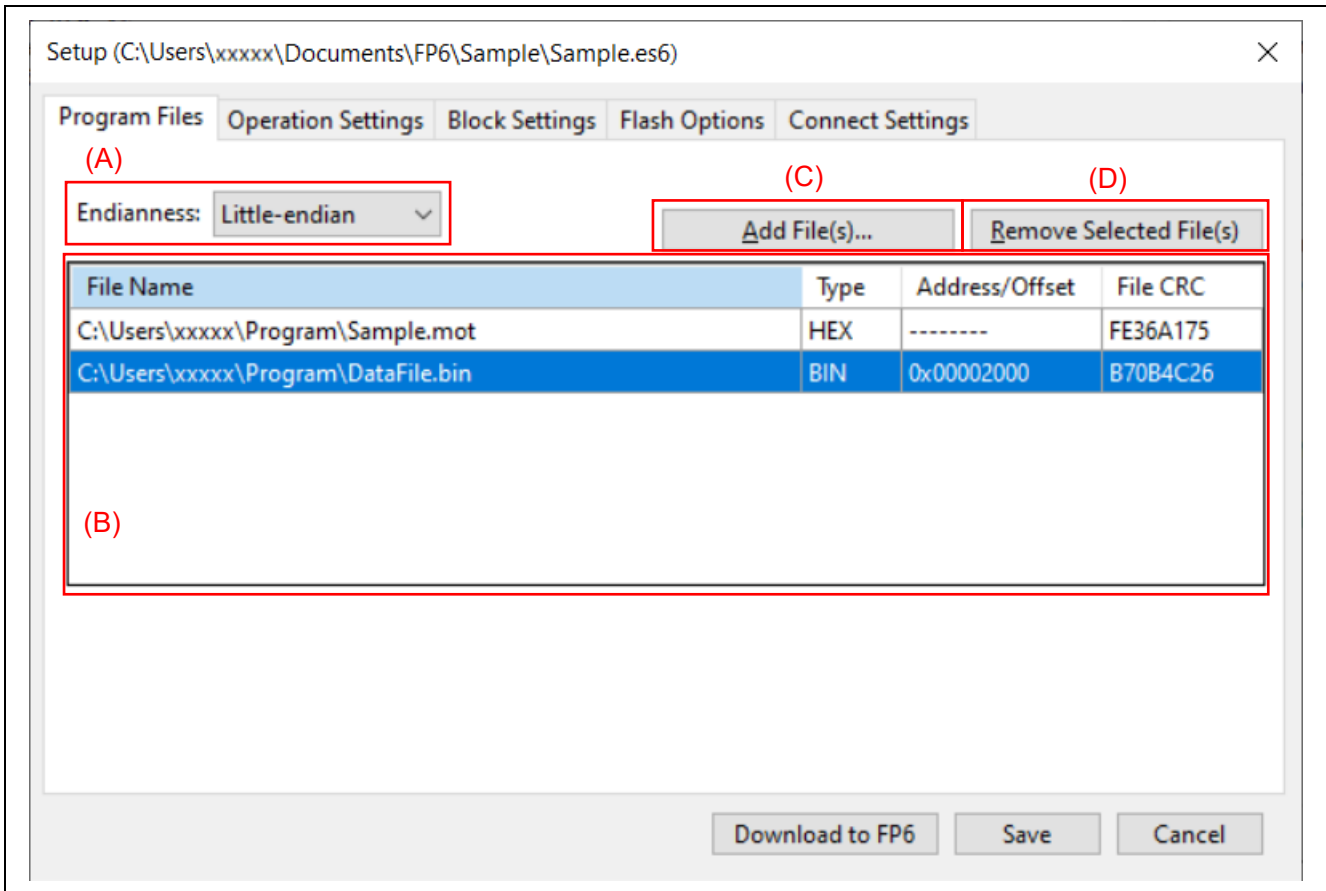

Figure 4.4 [Program Files] Tabbed Page

(A) Endian

Select the endian according to the data of the program file. This item is not displayed when the target device does not support switching of the endian.

(B) List of files

Displays a list of files to be written to the flash memory of the target device. Files can be added to the list by clicking on the [Add File(s)...] button or by dragging and dropping. Selecting and double-clicking on the name of a target file opens the [File Offset] dialog box which enables specifying the write address or offset. For details, refer to section 4.3.1.1, [File Offset] Dialog Box.

Caution: Before selecting and downloading an RPE file, set the password for the RPE file to be sent to the FP6 main unit through the dialog box produced by the [Programmer Setting] menu item.

Remarks:

1. [Address/Offset]: An offset can be specified for a HEX file. The entry in the [Address/Offset] column for a HEX file shows "-----" if no offset is specified and "+xxxxxxx" if an offset is specified.
2. [CRC] displays the checksum (CRC-32) of the selected file. This checksum is calculated from the entire file including a linefeed code. Therefore, it does not match the checksum acquired from the target device.
3. Multiple DDI, HCUHEX, or RPI files cannot be selected.

(C) [Add File(s)...] button

This opens a dialog box for opening a file to be added to the list of files. If a binary file or user key file is selected in this dialog box, the [File Offset] dialog box opens to allow specifying the programming start address.

(D) [Remove Selected File(s)] button

Select a file or files to be removed. Clicking on this button or pressing the delete key of Windows enables removal of the selected file(s).

4.3.1.1 [File Offset] Dialog Box

A binary file or a key file is shown in address mode and other types of file are shown in offset mode.

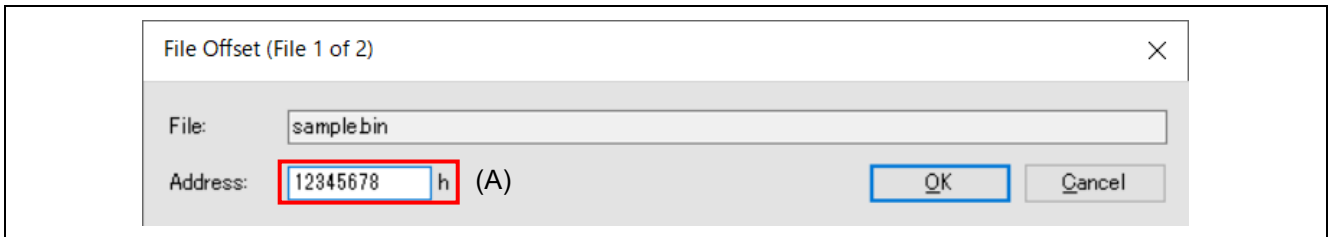

Figure 4-5 [File Offset] Dialog Box (Address Mode)

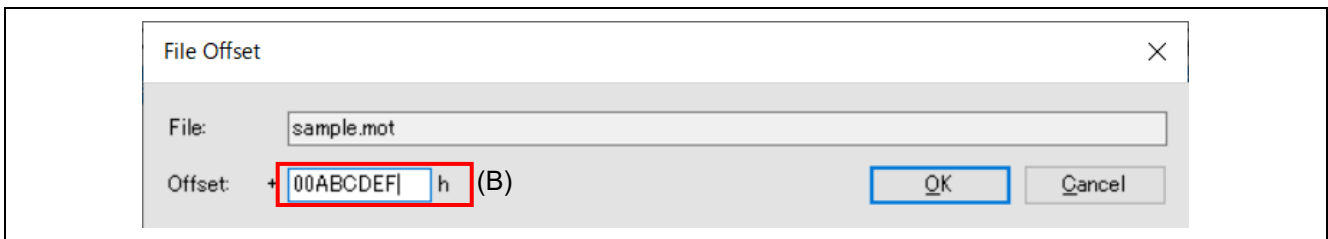

Figure 4-6 [File Offset] Dialog Box (Offset Mode)

(A) Address

Enter the write address of the file in hexadecimal.

(B) Offset

Enter the write offset (additive) of the file in hexadecimal. No entry will be regarded as 0.

4.3.2 [Operation Settings] tabbed page

The [Operation Settings] tabbed page allows you to change settings related to the operation of flash memory.

Remark: Some items may not be displayed or the values of some items may not be changeable depending on the selected target device or program file.

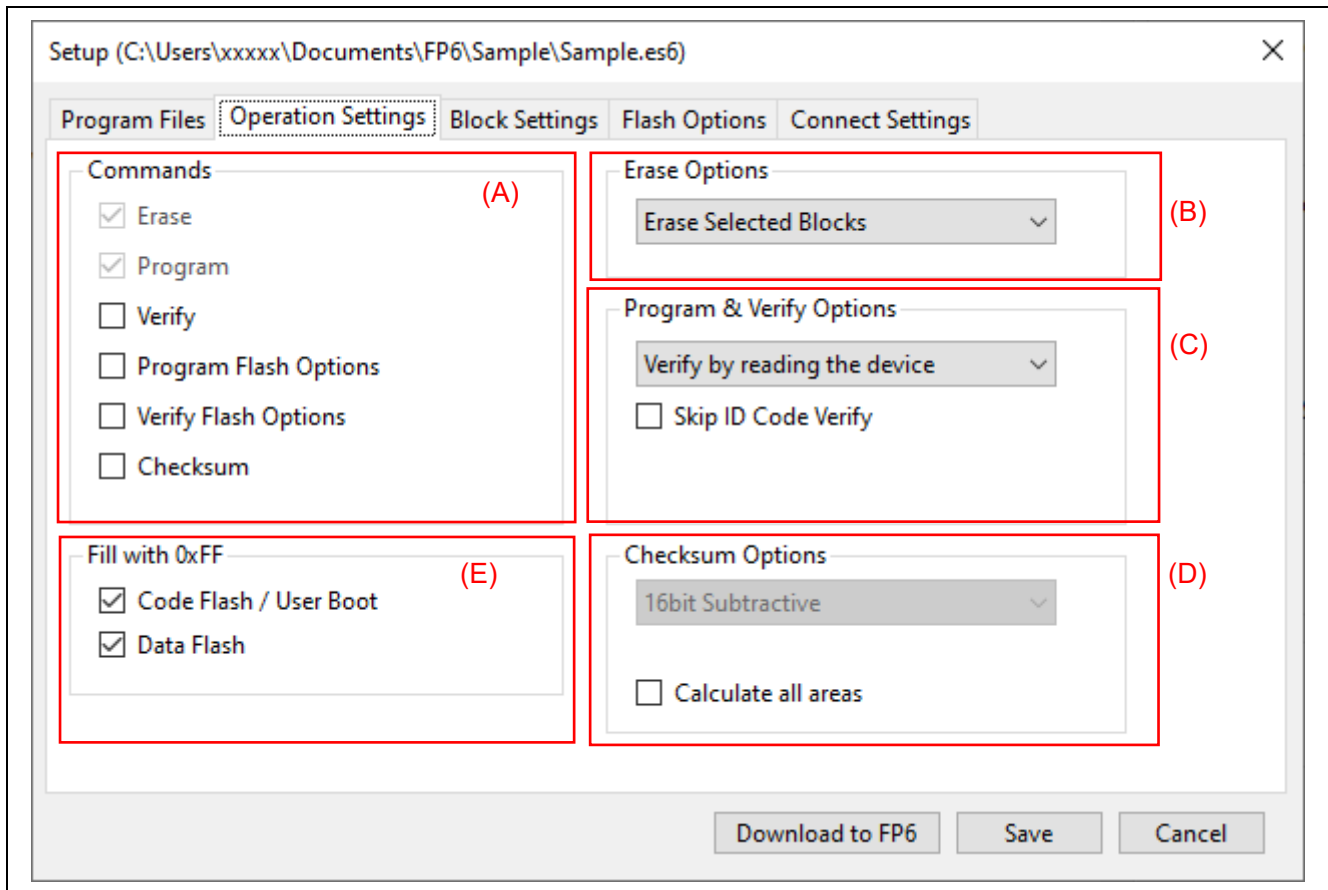

Figure 4.7 [Operation Settings] Tabbed Page

(A) Command

Select the command(s) to be executed in response to pressing the [START] button on the FP6 or clicking on the [Start] button on the FP6 Terminal. When multiple commands are selected, they are executed in order from the top. The six processes listed below can be selected as commands. Note that some commands may not be available depending on the selected target device.

Remark: If you wish to execute any of these commands individually, select it from the [Target] menu.

- Erase
This command erases flash memory data in the range selected for the [Block Settings] tabbed page and "(B) Erase Option". For details on a point for caution that applies to this command, refer to section 13.14, Erase Command.
- Program
This command programs data in the flash area. The programming range is set on the [Block Settings] tabbed page.
- Verify
Handle comparison between the program file and the data in the flash area. The verification range is set on the [Block Settings] tabbed page.

The operation reflects the setting made under "(C) Program & Verify Option".

- Program Flash Options

This command makes settings of flash options such as lock bits, OTP, flash access window, option bytes, and security. These settings correspond to those configured on the [Block Settings] and [Flash Options] tabbed pages. Note that this item is not displayed when the HCUHEX files, RPI files, or RPE files containing encrypted versions of those files are selected and programming of flash options always proceeds during programming.

Caution: If the contents of the [Flash Options] tabbed page have been modified, programming of the flash options must be enabled for command execution to reflect the modification in the setting file. The settings will not be made in the target device otherwise.

- Verify Flash Options

This command verifies the flash option areas. When this option is used, also select [Program Flash Options].

- Checksum

This command acquires the checksum of flash memory. The method selected for "(D) Checksum Option" is used for calculating the checksum.

(B) Erase Option

Select an option for "Erase" under "Command".

- Erase Selected Blocks

Erase only those blocks selected on the [Block Settings] tabbed page.

For the [Block Settings] tabbed page, see section 4.3.3, [Block Settings] tabbed page.

- Erase All Blocks

Erase all blocks.

Caution: Erasure processing may be skipped for certain blocks reserved by the MCU due to security functions and so on.

- Erase Chip

Erase all blocks and clear the flash options.

Cautions:

1. This processing does not restore the MCU to its state at shipment. If correct settings are not programmed for the flash options after erasing the chip, the MCU will not operate.
2. For 78K, V850, and R8C devices, the erasure operation will be switched according to the settings on the [Block Settings] tabbed page.
3. When "Erase Chip" is executed, the chip erasure command, the security release command, or the configuration clear command will be executed after all blocks are erased. For details of these commands, refer to the user's manual of the MCU.

(C) Program & Verify Option

Select an option for "Program" or "Verify" under "Command".

- Verification type

Select the type of verification as one of the following items. Depending on the target device, only one type may be available.

— Verify by reading the device

Data are acquired with a read command from the MCU and the FP6 handles verification.

Comparison cannot proceed if the MCU is in a state such that reading is prohibited.

- Verify in the device

Data are re-sent to the MCU in response to the verify command and the MCU side handles comparison.

Depending on the specifications of the verify command, the range for comparison may extend beyond the programmed data, and this may lead to an error in verification if "Fill with 0xFF" was not selected.

Use this option if the execution of read commands is disabled by the security settings of the MCU.

- Skip ID Code Verify

In general, do not select the check box when this feature is displayed as an option. However, use this feature in cases of the following type.

The security settings of the MCU may make reading of the ID code impossible since the ID code in the MCU is protected. This may lead to an error in verification processing. To avoid errors of this type, select this check box to use the feature.

For details, refer to section 13.9, Verification after Protecting the MCU.

(D) Checksum Option

Select the method for calculation when "Checksum" is selected under "Command". Usable methods vary with the target device.

- Calculate all areas

In general, the range for calculation of the checksum is selected as all ranges of the target device or the range specified on the [Block Settings] tabbed page.

(E) Fill with 0xFF

Select this check box if you wish to fill the ranges that do not contain program file data with 0xFF.

Target areas: Code flash and user-boot areas or data flash area

- When "Fill with 0xFF" is selected

- Programming: 0xFF will be written to the ranges that do not contain program file data.

- Verification: The ranges that do not contain program file data will be compared with 0xFF as the expected value.

- When "Fill with 0xFF" is not selected

- Programming: No data will be written to the ranges that do not contain program file data.

- Verification: The ranges that do not contain program file data will not be verified.

Remark: "Fill with 0xFF" cannot be deselected for some target devices.

Caution: Even if "Fill with 0xFF" is not used, filling of 0xFF is always performed in the minimum unit of programming by the MCU.

4.3.3 [Block Settings] tabbed page

The [Block Settings] tabbed page allows you to set blocks to be handled.

Caution: If the selected file is HCUHEX or RPI, the [Block Settings] tabbed page is not displayed. The blocks to be handled are processed as all blocks (chip mode) with the lock bits and OTP is processed according to the content of the RPI file if this is the file type.

4.3.3.1 Case of a 78K, V850, or R8C device

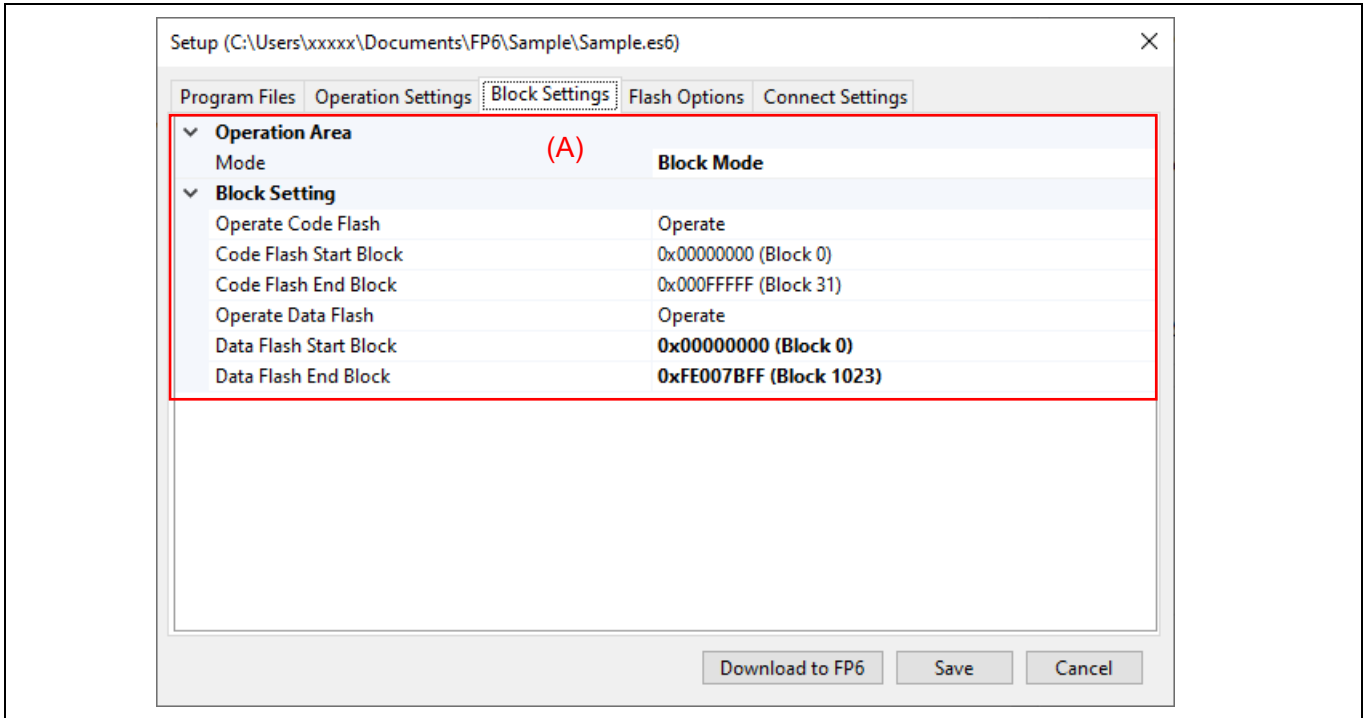

Figure 4.8 [Block Settings] Tabbed Page (Case of a 78K, V850, or R8C Device)

(A) Operation Area

Specify the target range for erase, program, and verify operations.

The flash memory can be handled as a whole (Chip Mode) or in block units (Block Mode).

- Mode
 - Chip Mode

This mode is used to handle the entire chip.
 - Block Mode

This mode is used to specify a range of blocks. Erasure, programming, and verification will not be executed for blocks outside the range.
- Operation of code flash and data flash

Select whether the code flash and data flash areas should be regarded as the target of operation.
- Start/end block of code/data flash

Select the start and end addresses of the code flash and data flash areas to be handled.

4.3.3.2 Case of other device types

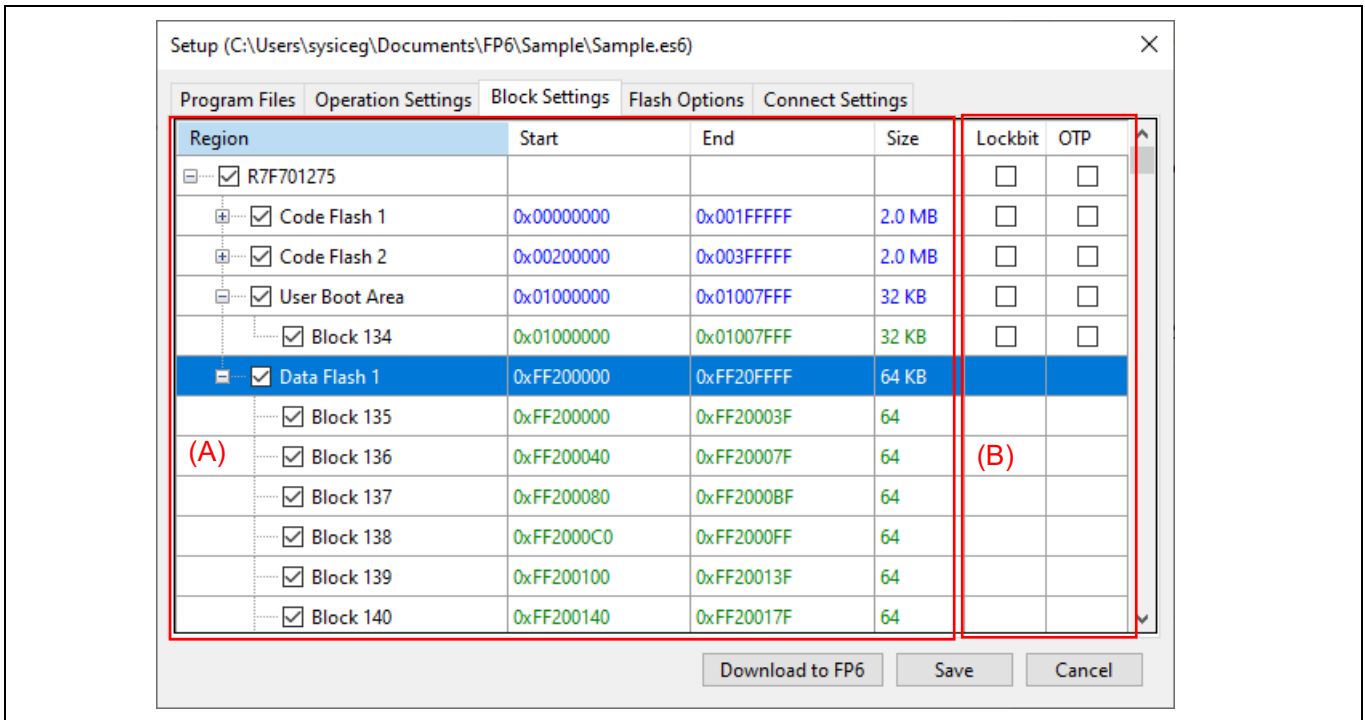

Figure 4.9 [Block Settings] Tabbed Page (Case of Other Device Types)

(A) Information on area blocks

Specify the target blocks for erasure, programming, and verification.

Cautions:

1. The names of areas or block numbers are common to FP6. Note that these names may differ from those stated in the user’s manual of the target device.
2. When “Erase All Blocks” or “Erase Chip” is selected for [Erase Options] on the [Operation Settings] tabbed page, the settings made on the [Block Settings] tabbed page are ignored.
3. When SuperH is selected as the target device, either code flash or user boot flash can be specified as the target of operation. When both areas need to be programmed simultaneously, you can select both areas by specifying a DDI-format file as the program file.

(B) Lock bits or OTP

To set the lock bits or OTP, select the target blocks on the [Block Settings] tabbed page. Alternatively, select "Set" for "Set Option" of each item on the [Flash Option] tabbed page and click [Program Flash Option] on the [Operation Setting] tabbed page and execute [Start].

4.3.4 [Flash Options] tabbed page

The [Flash Options] tabbed page allows you to specify flash options for the target device.

Remark: Only those items the target device supports are shown. For the meanings and details of the settings of the individual items, refer to the user's manual of the target device in use.

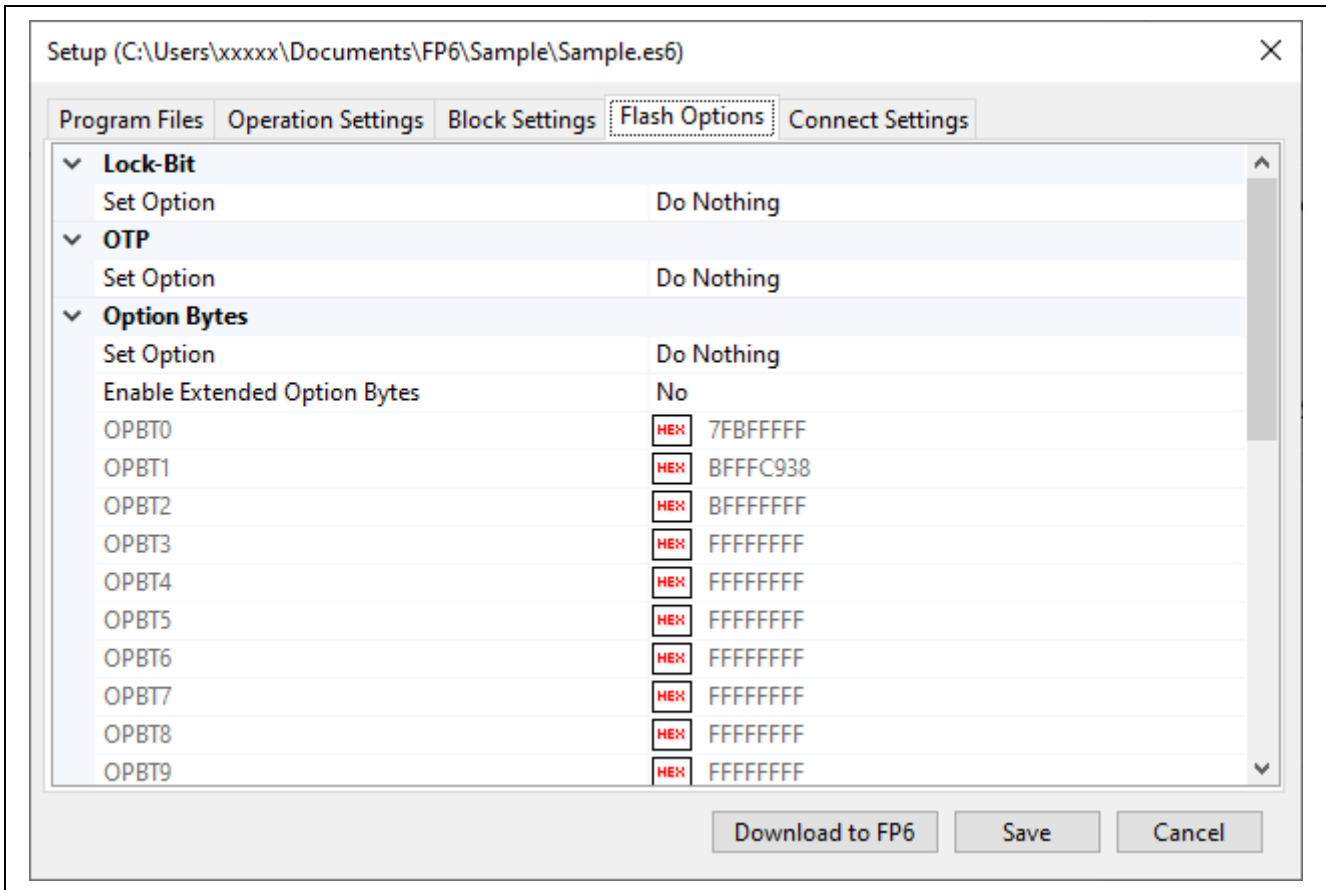

Figure 4.10 [Flash Options] Tabbed Page

(A) Lock-Bit

Select whether to set the lock bits. When “Set” is selected, the lock bits for the blocks selected on the [Block Settings] tabbed page will be set.

(B) OTP

Select whether to set the OTP. When “Set” is selected, the OTP for the blocks selected on the [Block Settings] tabbed page will be set.

(C) Access window/Flash shield window

Select whether to set the access window.

- Set Option
 - “Do Nothing”: Access window are not set.
 - “Set”: The setting of access window is enabled.
- Start Block/End Block
 - Select the start or end block from the pull-down menu.
- Operation Setting
 - “Prohibit outside the range”: Programming or erasing of blocks outside the range from the start block to the end block is prohibited.

- “Prohibit inside the range”: Programming or erasing of blocks within the range from the start block to the end block is prohibited.
- “Disable rewriting”
 - “No”: Making changes within the access window is not disabled.
 - “Yes”: Making changes within the access window is disabled.

(D) Option Bytes (OPBT)

You can change the settings of option bytes (OPBT).

- Enable Extended Option Bytes

Select “Enable” or “Disable”, respectively, to enable or disable setting of extended option bytes (OPBT8 and above) and acquisition of their values.

Caution: Be careful when you rewrite the values of the extended option bytes since they may include important settings for the MCU.

- OPBT0 to OPBT7

Enter the value of option bytes in 4-byte units in hexadecimal notation (bit 31 to bit 0).
- OPBT8 and above

Enter the value of extended option bytes in 4-byte units in hexadecimal notation (bit 31 to bit 0).

(E) ICU-S

Enable or disable the ICU-S.

- “Set Option”
 - “Do Nothing”: ICU-S is not set.
 - “Set”: The ICU-S function is enabled.

Caution: For some target devices, the ICU-S cannot be disabled after it has been enabled. For details, refer to the user's manual of the target device.

Remark: The [Verify Flash Options] command cannot be used with this option.

(F) Security

Set security functions.

- “Set Option”
 - “Do Nothing”: The security function is not set.
 - “Set”: The security function is enabled.
- “Enable ID Code Authentication”
 - “No”: The ID authentication function is disabled.
 - “Yes”: The ID authentication function is enabled.
- “Disable Chip Erase / Disable Block Erase / Disable Program / Disable Read / Disable Rewriting boot cluster / Disable Initialize Command / Disable Test Mode / Disable AL2 authentication / Disable AL1 authentication / Disable LCK_BOOT transition”
 - “No”: The security function is not set for the target command.
 - “Yes”: The use of the target command is prohibited.

Cautions:

1. Once any of the functions for disabling commands has been set for an MCU, some of the security settings cannot be reversed.

2. To reverse the security settings for the MCU, select “Erase Chip” for “Erase Options” to clear the flash options.

(G) Reset Vector

Enter the reset vector value of the target device in hexadecimal notation.

(H) Security Code

Set the ID code or the access password.

- “Set Option”
 - “Do Nothing”: An ID code or access password is not set.
 - “Set”: The setting of an ID code or access password is enabled.
- ID Code
 - Enter the ID code in hexadecimal notation.
- Code Flash Access Password
 - Enter the password for accessing code flash memory in hexadecimal notation.
- Data Flash Access Password
 - Enter the password for accessing data flash memory in hexadecimal notation.

(I) Boot Area

Specify the end block of the boot area.

(J) Connection Prohibited

Make the setting for disabling connection in serial programming mode or both the debugger and serial programming mode.

- “Disable Serial Programming”
 - “Do Nothing”: Serial programming is not disabled.
 - “Set”: Connection in serial programming mode is disabled.
- “Disable Debugger and Serial Programming”
 - “Do Nothing”: Debugger and serial programming are not disabled.
 - “Set”: Connection in debugger and serial programming mode is disabled.

Caution: Once the Connection Prohibited function is set for an MCU, the setting cannot be reversed.

(K) DLM

Make the setting for DLM state transitions. Use this setting when DLM state transitions are set in response to other processing such as the programming of a program file. When a DLM state transition requires authentication, use the DLM transition in the menu for the target device.

- “Set Option”
 - “Do Nothing”: A transition of the DLM state is not to be set.
 - “Set”: The setting of DLM transitions is enabled.
- “Target State”
 - Select the destination of the DLM transition from the pull-down menu.

(L) DLM Keys

Specify the DLM key file for use in DLM authentication which is to be set for the target device.

For details on how to generate DLM keys, refer to [Security Key Management Tool](#).

- “Set Option”
 - “Do Nothing”: A DLM key is not to be set.
 - “Set”: The setting of a DLM key is enabled.
- DLM key file

Open the [Open File] dialog box by clicking on , and specify a DLM key file.

Remarks: 1. If a DLM key file is not specified, programming of the flash memory will not proceed.
 2. DLM key files in formats other than the Renesas Key File (.rkey) are not supported.

(M) Boundary

Set the size of the secure and non-secure callable areas of the target device.

- “Set Option”
 - “Do Nothing”: Boundaries are not to be set.
 - “Set”: The setting of boundaries is enabled.
- “Renesas Partition Data File”

Use the Renesas Partition Data File to make the settings of “Secure [KB]” and “NSC [KB]” on boundaries.
- “Secure [KB]”

Enter the size of the secure area in KB units.
- “NSC [KB]”

Enter the size of the non-secure callable area in KB units.

Caution: Confirm the specifiable sizes in the user’s manual of the target device since limits will apply.

(N) Flash Read Protection

Make the setting for flash read protection.

- “Set Option”
 - “Do Nothing”: Flash read protection is not to be set.
 - “Set”: The setting for flash read protection is enabled.
- “Start Block/End Block”

Select the start or end block from the pull-down menu.

Remark: To enable reading of all blocks, select “Permitted All Blocks”.

- “Disable rewriting”
 - “No”: Rewriting of flash read protection is not disabled.
 - “Yes”: Rewriting of flash read protection is disabled.

(O) Extra Option

Make the setting for the extra option.

- “Set Option”
 - “Do Nothing”: An extra option is not to be set.
 - “Set”: The setting of an extra option is enabled.
- “Disable rewriting”
 - “No”: Rewriting of an extra option is not disabled.
 - “Yes”: Rewriting of an extra option is disabled.

Caution: Once the Extra Option function is set for an MCU, the setting cannot be reversed.

(P) Configuration Data Lock Bit

Make the setting for a configuration data lock bit.

- “Set Option”
 - “Do Nothing”: A configuration data lock bit is not to be set.
 - “Set”: The setting of a configuration data lock bit is enabled.

Caution: Once the Configuration Data Lock Bit function is set for an MCU, the setting cannot be reversed.

(Q) Anti-Rollback Settings

Make the Anti-Rollback Settings.

- “Set Option”
 - “Do Nothing”: Anti-Rollback Settings is not to be made.
 - “Set”: Making of Anti-Rollback Settings is enabled.

Cautions:

- Once the Anti-Rollback Settings function is set for an MCU, the setting cannot be reversed.
- “Anti-Rollback Settings” may be displayed for some target devices which do not support this function. For details on whether a target device has an Anti-Rollback Settings function, refer to the user’s manual of the target device.

(R) OEM root public key

Make the setting for the OEM root public key.

- “Set Option”
 - “Do Nothing”: An OEM root public key is not to be set.
 - “Set”: The setting of an OEM root public key is enabled.
- “OEM Root Public Key File x”

Open the [Open File] dialog box by clicking on , and specify the OEM root public key file.
- “Disable Rewriting”
 - “No”: Rewriting of an OEM root public key is not disabled.
 - “Yes”: Rewriting of an OEM root public key is disabled.

Caution: “OEM root public key” may be displayed for some target devices which do not support this function. For details on whether a target device has an OEM root public function, refer to the user’s manual of the target device.

(S) Certificate

Make the setting for a certificate.

- “Set Option”
 - “Do Nothing”: The certificate setting is not to be made.
 - “Set”: Making of the certificate setting is enabled.
- “Verification Method”

Specify the authentication method.

 - “Signature”: Signature mode
 - “CRC”: CRC mode
- “Code Certificate / Key Certificate”

Open the [Open File] dialog box by clicking on , and specify a certificate file.

(T) CPU Settings

Make the setting for the operation of the CPU.

- “Set Option”
 - “Do Nothing”: No setting is made for the operation of the CPU.
 - “Set”: The setting for the operation of the CPU is enabled.
- “Change master CPU from CPU0 to CPU1”/“Disable Security Extension for CPU1”
 - “No”: The settings for these options are not to be made.
 - “Yes”: These options are to be set.

Caution: Once “Yes” is set for an MCU, the setting cannot be reversed.

(U) Boot Cluster Size/Bank Swapping

Make the setting for the boot cluster size/bank swapping option.

Caution: When the swapping function of the target device is enabled (BTFLG = 0) and BTBLS is changed after programming of the flash memory, the result of programming may not be as expected if the swapping size is changed after the end of programming. To avoid this problem, following either of the methods below when flash memory is programmed with the swapping function enabled is recommended.

- Program the flash memory after BTBLS has been set.
- Program the flash memory after having restored all security states (including that of BTFLG) to their default values by erasing the chip.
- “Set Option”
 - “No”: The boot cluster size/bank swapping option is not to be set.
 - “Yes”: The setting of the boot cluster size/bank swapping option is enabled.
- “Disable Rewriting BTBLS (BAPR)”
 - “Yes”: Rewriting the setting area for BTBLS is disabled (BAPR = 0).

Remark: When BTBLS is to be set, be sure to disable rewriting of the setting area for BTBLS.

4.3.5 [Connect Settings] tabbed page

The [Connect Settings] tabbed page allows you to fill the information necessary for connecting the MCU.

Remark: The items displayed on this page vary with the type of the target device.

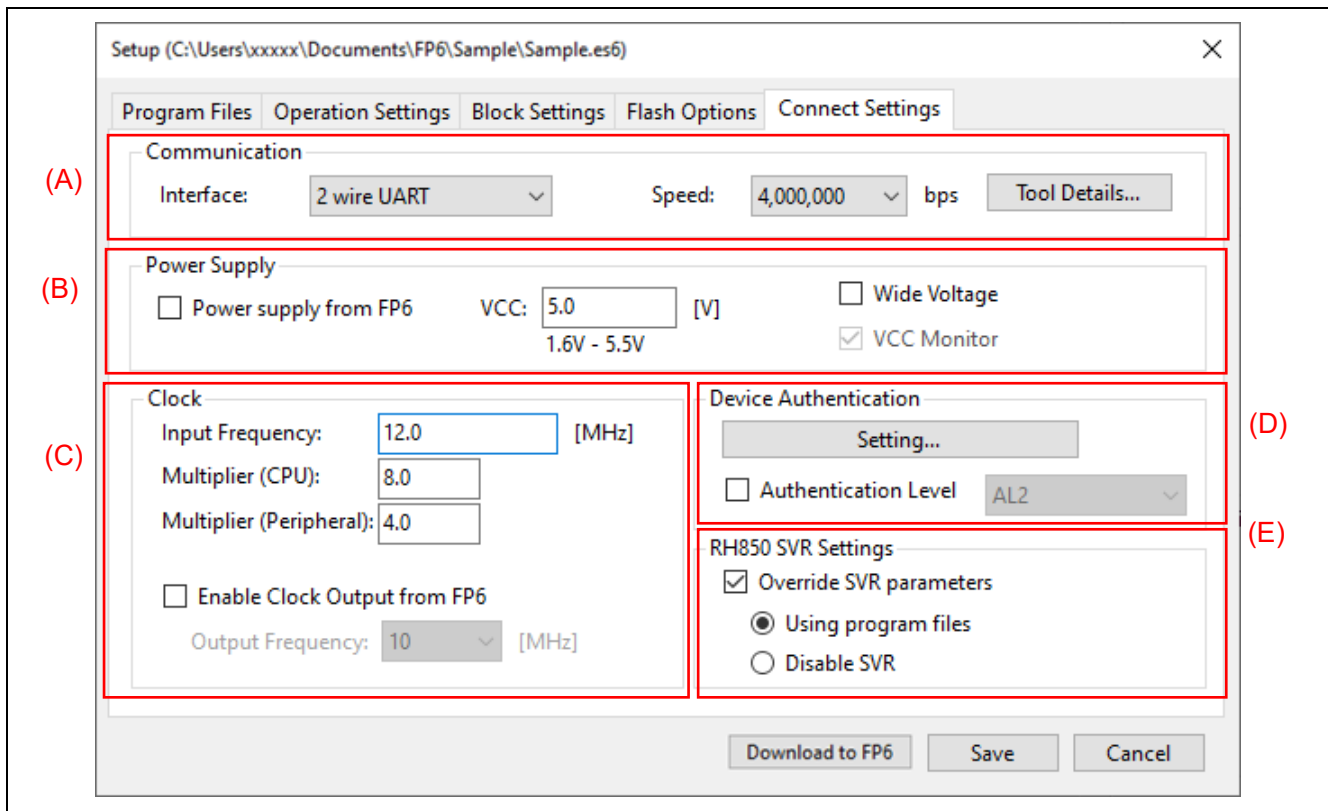

Figure 4.11 [Connect Settings] Dialog Box

(A) Communication

- Information on the programmer

The communication port and serial number of the currently connected FP6 are displayed.

Remark: You cannot select any other FP6 through this dialog box. To do so, select [Programmer]–[Setup PC Connection] in the main window.

- Interface

Select the method for communicating with the target device.

- Speed

Select the communication speed in the communication mode selected for “Interface”.

Caution: If the target device operates at a low voltage, communications may only be possible with a relatively low baud rate (e.g., 9600 bps or 115200 bps).

- Tool Details

Click on this button to open the [Tool Details] dialog box, which enables setting of the states of the mode pins at the time of connection and of the reset pin at the time of disconnection.

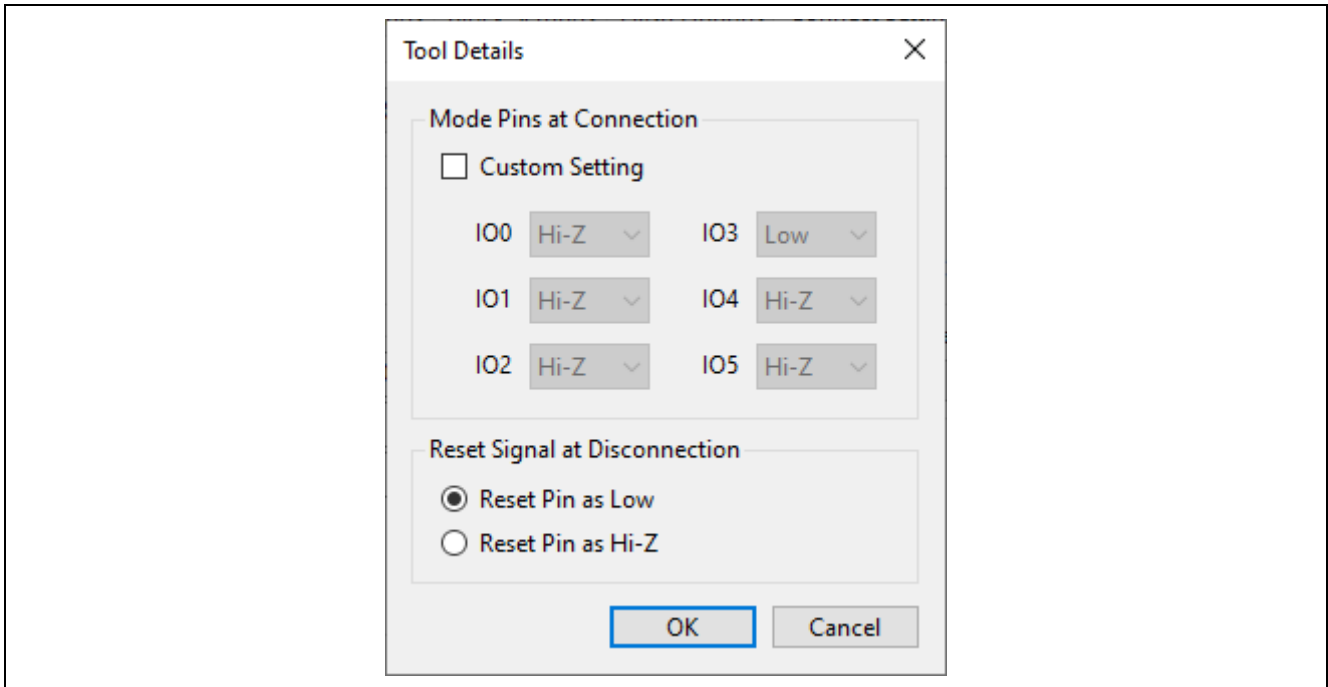

Figure 4.12 [Tool Details] Dialog Box

- [Mode Pins at Connection]

To modify the levels on the mode pins (I/O pins) at the time of connection, select “Custom Setting” and set IO0 to IO5. You can then change the pin settings to the high-impedance state or to the high or low output level.

Remark: Depending on the target device, certain selections may not be available.

For pin assignments, refer to Table 10.3, Pin Configuration of the Target Connector (14-Pin Type), and Table 10.4, Pin Configuration of the Target Connector (20-Pin Type).

- [Reset Signal at Disconnection]

Select the state of the reset pin at disconnection from the target device.

- Reset Pin as Low

After disconnection, a low-level signal is continuously output from the RESET pin.

- Reset Pin as Hi-Z

After disconnection, the RESET pin is held low for a short time and then placed in a Hi-Z state. This setting is used when making the target device operate after completion of the FP6 processing.

(B) Power Supply

- Power Supply from FP6

Select whether power should be supplied from the FP6 or the target system during the process of connecting the target device.

Remark: We recommend supplying power from the target system to the MCU for on-board programming. Specify the voltage value within the range of 1.8 V to 5.5 V.

Caution: The voltage value should meet the operating conditions of the target device and target system.

- **Wide Voltage**
Select this check box to perform programming in wide voltage mode. For details on wide voltage mode, refer to section 13.5, Wide Voltage Mode.
- **VCC Monitor**
Select this check box to detect an error when there is a gap of approximately $\pm 5\%$ from the voltage value that was entered in [VCC].

Caution: The voltage value is measured on the FP6 side of the target cable. Accordingly, this facility does not guarantee that the voltage set for the target device on the target system is being supplied.

(C) Clock

Set the frequency of the input clock, the multiplication ratio of the main clock, and the multiplication ratio of the peripheral clock. Set the input clock frequency in MHz. If the value is smaller than 1 MHz, use a decimal. The display is switched depending on the type of the target device. You can check the clock settings for each target device in the Points for Caution stated in the Release Note, which can be obtained from the Renesas Tools homepage (<https://www.renesas.com/pg-fp6>).

In addition, specify whether a clock in the target system or that on the FP6 side is the source of the clock signal for supply to the target device. When the [Enable Clock Output from FP6] check box is not selected, a clock in the target system is used. When the [Enable Clock Output from FP6] check box is selected, the clock on the FP6 side is used.

(D) Device Authentication

- “Setting”

Clicking on this button opens the [Authentication Code] dialog box. Use this button if you wish to change an authentication code required for operating the target device, such as the ID code, access password, or DLM key. Enter the ID code for authentication in hexadecimal notation (0 to 9 and A to F).

To authenticate a device without saving the authentication ID code in the FP6 main unit, use the communications command which is described in section 7.4.18, set_auth_id command.

- “Authentication Level (AL)”

When this option is selected, authentication proceeds at the authentication level selected from the pull-down menu.

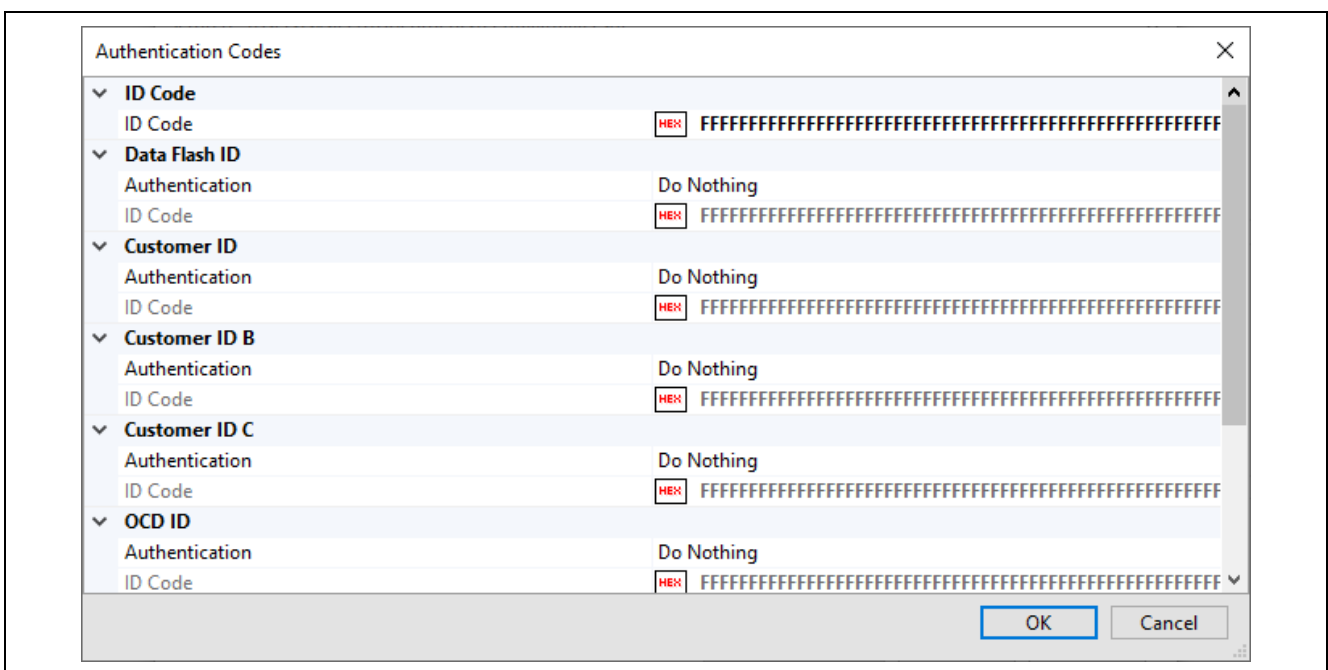

Figure 4.13 [Authentication Codes] Dialog Box

Cautions:

- When an RX-family device is connected via the FP6, input the value in the order (control code) ID1, ID2, ..., ID16.

Example:

When the number of effective bytes = 16, control code = 0x45, ID code = ID1=0x01, ID2=0x02, ID3=0x03, ID4=0x04, ID5=0x05, ID6=0x06, ID7=0x07, ID8=0x08, ID9=0x09, ID10=0x0A, ID11=0x0B, ID12=0x0C, ID13=0x0D, ID14=0x0E and ID15=0x0F, the value will be '450102030405060708090A0B0C0D0E0F'.

- When RX72x, RX71x, RX66x, RX65x, or RX64x device is connected via a debug tool which has been specified with the CS+ or e2 studio, the order for input of the authentication code changes to that shown below.

ID4 ID3 ID2 ID1 ID8 ID7 ID6 ID5 ID12 ID11 ID10 ID9 ID16 ID15 ID14 ID13

- FP6 repeats it up to three times if ID code authentication fails.
- When an RA-family, Renesas Synergy™-family, or RE-family device is connected to the FP6, input values to be specified for registers of the target device in order of bits 127 to 0 in byte units. Since the input specification may also differ with the tool, confirm the input specification of the tool you will be using.
- For an RH850-family device, when the ID code for programming is to be generated in a program file instead of on the [Option Settings] tabbed page, enter the value set for the register in the target device from the higher-order bits in byte units. Example: For ID255 to ID0, the first byte is entered as ID255 to ID248 and the second byte is entered as ID247 to ID240.

Remark: The default authentication code in some target devices at the time of shipment is all FFs. For details, refer to the user's manual of the target device.

(E) RH850 SVR Settings

Make the settings to control the SVR parameters while the PG-FP6 is connected to the target device.

“Override SVR parameters”

- When this option is selected
The PG-FP6 is connected to the target device after forcibly changing the SVR settings of the target device.
 - “Using program files”: Parameters in the program file are used.
 - “Disable SVR”: The SVR functions are disabled.
- When this option is not selected
The SVR parameters written to the option bytes of the target device are used.

Caution: Caution is required since the SVR settings are for the power supply. For details, refer to the user's manual of the target device.

4.4 Menu Bar

4.4.1 [File] menu

4.4.1.1 [New Project...]

This menu item is used to select a new target device and create a new setting file.

4.4.1.2 [Open Project...]

This menu item is used to open a setting file which has been created and download it to the FP6.

Caution: When a setting file created by using the FP5 is selected, the [Config Area] check box on the [Block Settings] tabbed page of the [Setup] dialog box is not selected by default. If necessary, select the [Config Area] check box after opening the [Setup] dialog box. This note is only applicable to the RX651 and RX65N groups.

4.4.1.3 [Upload Files]

This menu item is used to upload a program file and the setting file that are stored in the FP6 to the PC.

Remark: This menu item is not executable when [Disable Upload] is selected for the currently connected FP6.

- [File Upload] dialog box
Specify the file to be uploaded and the directory where the file is to be saved.

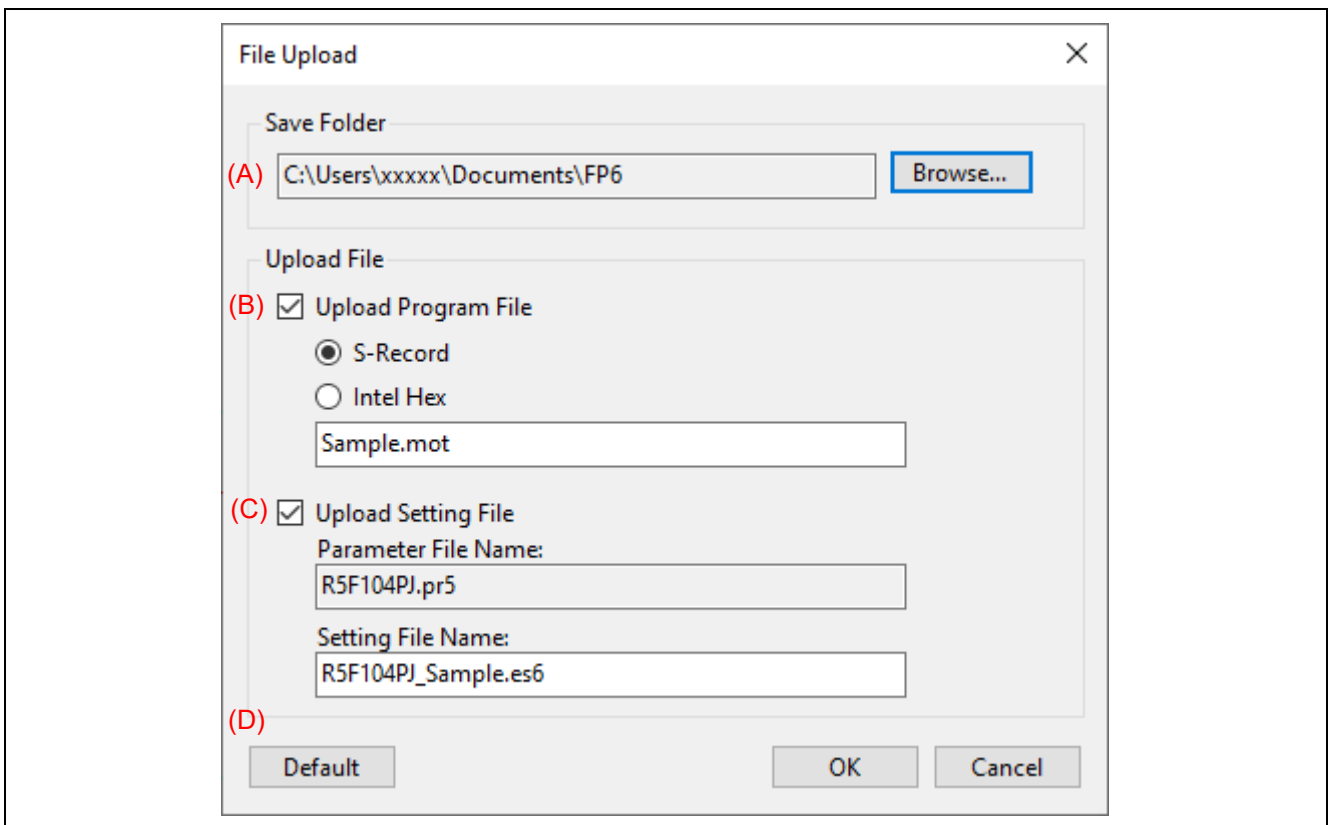

Figure 4.14 [File Upload] Dialog Box

(A) [Save Folder]

Specify the directory where the file is to be saved after it has been uploaded.

(B) [Upload Program File]

When a program file is to be uploaded, specify the file format (S-Record or Intel Hex) and select the check box. Although the text box initially shows a file name, the name can be changed.

(C) [Upload Setting File]

When a setting file is to be uploaded, select this check box. Although the text box initially shows a file name, the name can be changed.

(D) [Default] button

Clicking on this button restores the dialog box to its initial values.

4.4.1.4 [File Checksum]

This menu item is used to calculate the checksum of the data in the program file, which is saved in the currently connected FP6, and display the value in the console window.

Remark: Empty locations are included in the calculation as having the value 0xFF.

- [File Checksum] dialog box

Specify an area (or all areas) of the data saved in the FP6 and the method for calculating the checksum of the data.

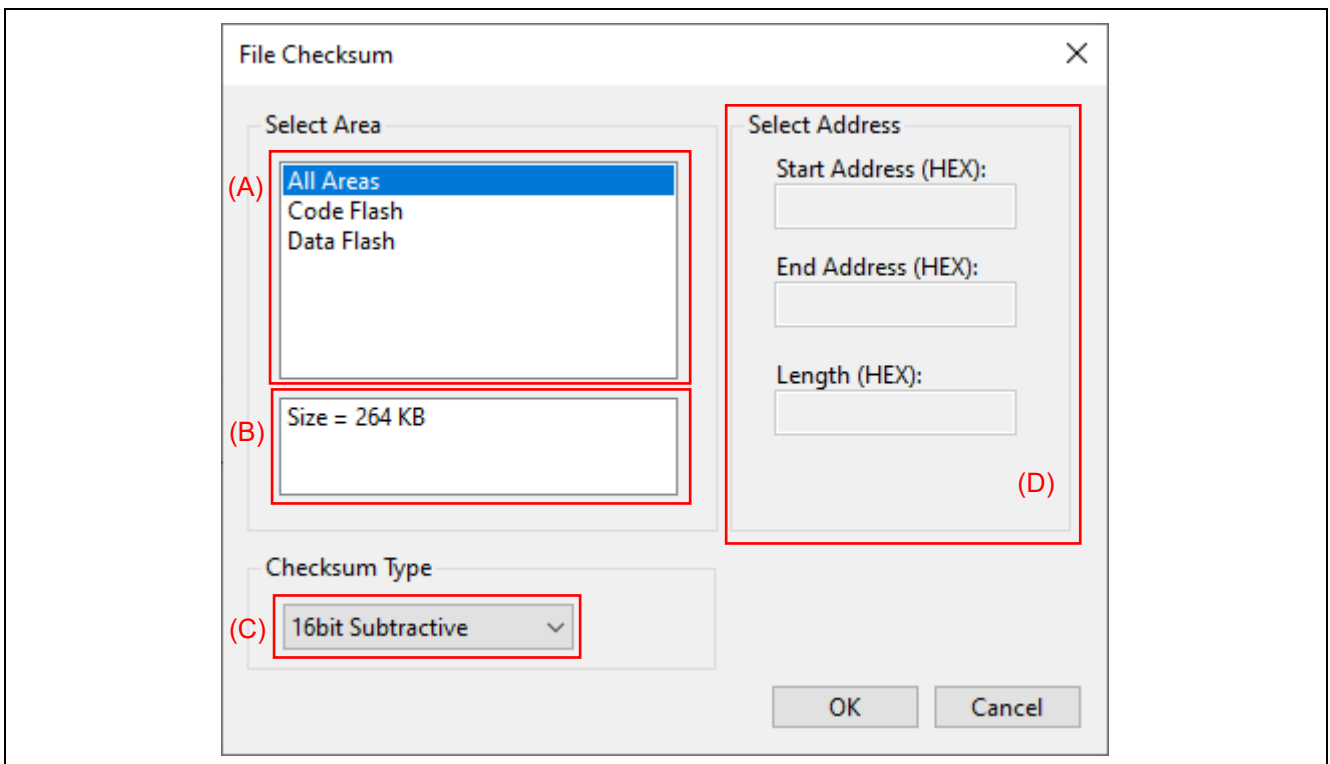

Figure 4.15 [File Checksum] Dialog Box

(A) List of areas

Specify the area to be used in calculating the checksum.

(B) Information on an area

Displays information on an area selected in the list of areas.

(C) Method for calculating the checksum

Select the method for calculating the checksum.

(D) "Select Address"

Only change the addresses when calculation is to be for a specific range.

4.4.1.5 [Recently used setting files]

This menu item is used to display the setting files that have most recently been created (up to eight filenames).

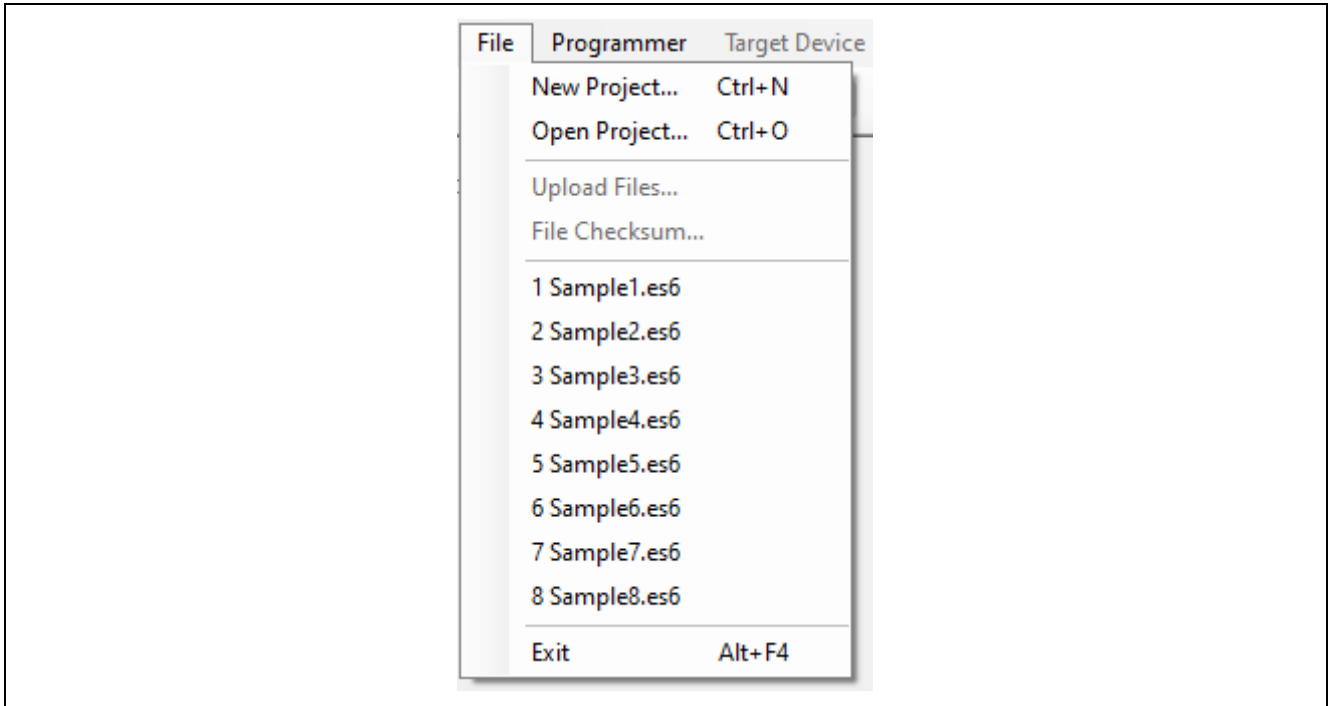

Figure 4.16 [Recently used setting files] Dialog Box

4.4.1.6 [Exit]

This menu item is used to close the FP6 Terminal.

4.4.2 [Programmer] menu

4.4.2.1 [Connection to FP6]

This menu item is used to select the port and baud rate for communications between the FP6 Terminal and the FP6 main unit.

- [Connection to FP6] dialog box

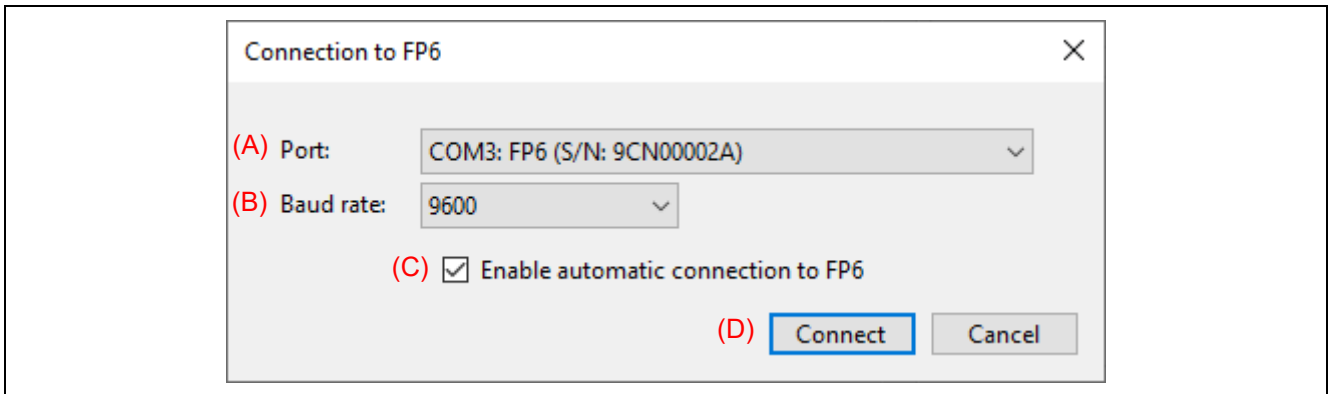

Figure 4.17 [Connection to FP6] Dialog Box

(A) [Port]

Select the communications port connected to the FP6 main unit. When a USB interface cable is used for connection, "COMx: FP6(S/N:xxxxxxx)" will be displayed.

(B) [Baud rate]

Select the speed for communications of the serial port of the FP6 main unit.

Remarks:

1. [Baud rate] is hidden when a port is USB-connected to the FP6 main unit.
2. Confirm the baud rate of the FP6 main unit from [Utility]-[RS232C Baudrate] on the LCD message display and set the same baud rate here.

(C) [Enable automatic connection to FP6]

When this check box is selected, the [Connection to FP6] dialog box will be skipped before the main window of the FP6 Terminal opens in cases where the FP6 is connected to the same COM port as in the previous connection or to any COM port via USB.

(D) [Connect]

Clicking on this button starts connection to the FP6 main unit with the current settings. When the PC is connected to the FP6 main unit, the firmware version of the FP6 main unit will be checked. If the firmware version does not match that expected by the FP6 Terminal, the [Update Firmware] dialog box will appear. Select whether to update the firmware.

Remark: If the firmware versions do not match, the FP6 Terminal will not be connectable to the FP6 main unit. When the FP6 Terminal is connected with the data of the FP6 main unit retained, use the version of the FP6 Terminal for which the data were to be downloaded to the FP6 main unit.

4.4.2.2 [Firmware Update]

This menu item is used to update the FP6 firmware.

4.4.2.3 [Logging]

This menu item is used to save the communication log for the results of command execution displayed on the console window. Selecting this menu item opens the [Save File] dialog box, in which you can specify the location where the file will be saved and the file name. While a log is being acquired, a check mark (√) is displayed next to the [Logging] menu item. When the menu item is selected again, the √ mark will disappear and the acquired log data will be saved in the file.

4.4.2.4 [Select Programming Area]

This menu item is used to change the active programming area for the currently connected FP6 and delete data saved in the specified programming area.

- [Select Programming Area] dialog box
 Selecting the [Select Programming Area] menu item opens the [Select Programming Area] dialog box, in which you can change the programming area for the currently connected FP6 main unit. To change the programming area, select an area and click on [OK]. To cancel the change, click on [Cancel]. Data that have been saved in the programming area can be deleted by clicking on the [Delete] button for the selected area.

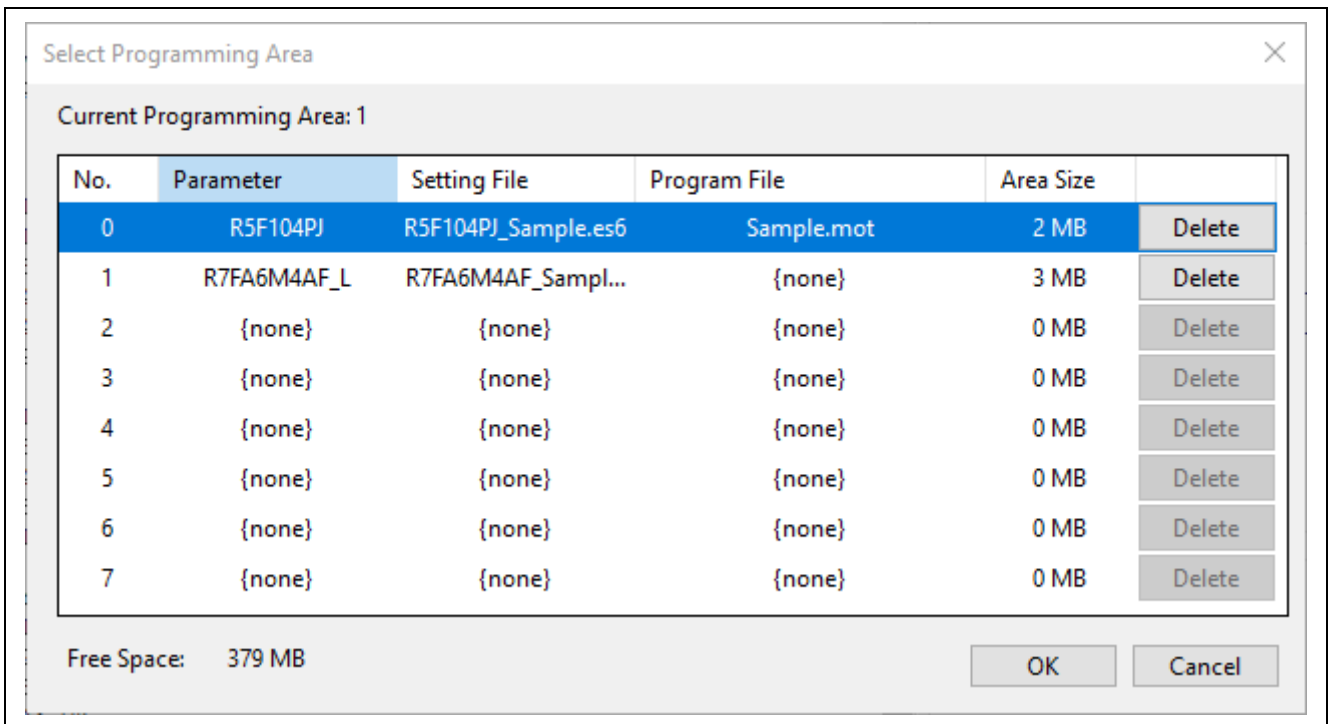

Figure 4.18 [Select Programming Area] Dialog Box

4.4.2.5 [Self Test]

This menu item is used for self-testing of the FP6.

- [Self Test] dialog box

After self-testing of the FP6 hardware has completed, the following dialog box will appear to show the result of self-testing of the FP6 hardware.

Cautions:

1. The MCU and equipment connected to the target connector and remote connector must be removed before the test.
2. Execute the test while power is being supplied from the power adapter to the FP6.

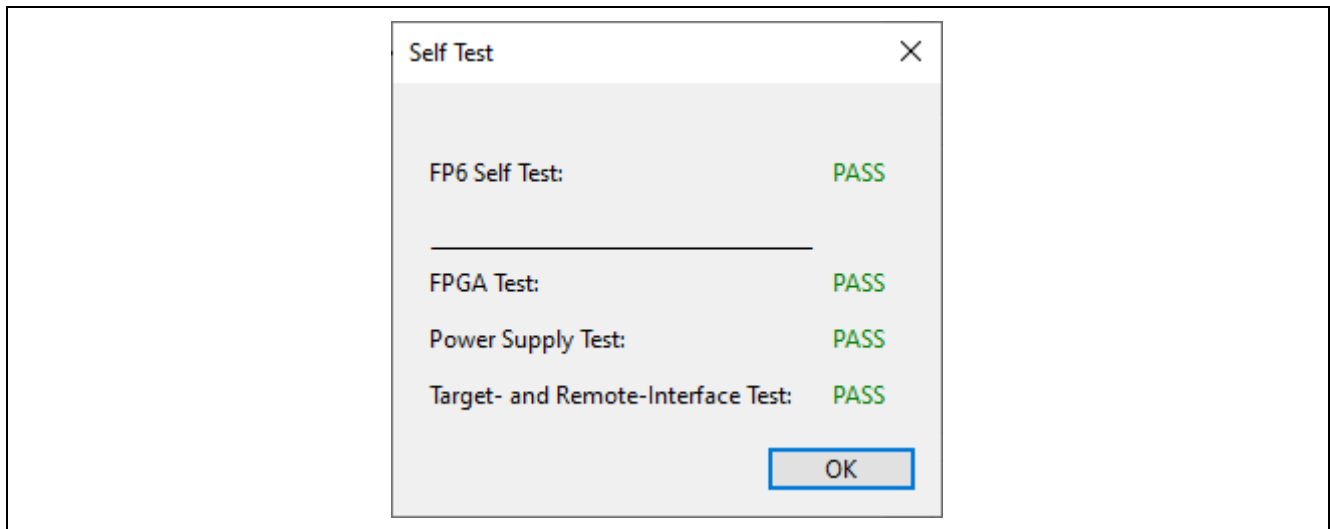

Figure 4.19 [Self Test] Dialog Box

4.4.2.6 [Programmer Setting]

This menu item is used to make security settings, such as disabling uploading or modification of FP6 settings, and change the operation mode of the FP6 main unit.

- [FP6 Options] dialog box

This dialog box is used to make settings for the FP6 main unit and for security functions and initialize the FP6 main unit.

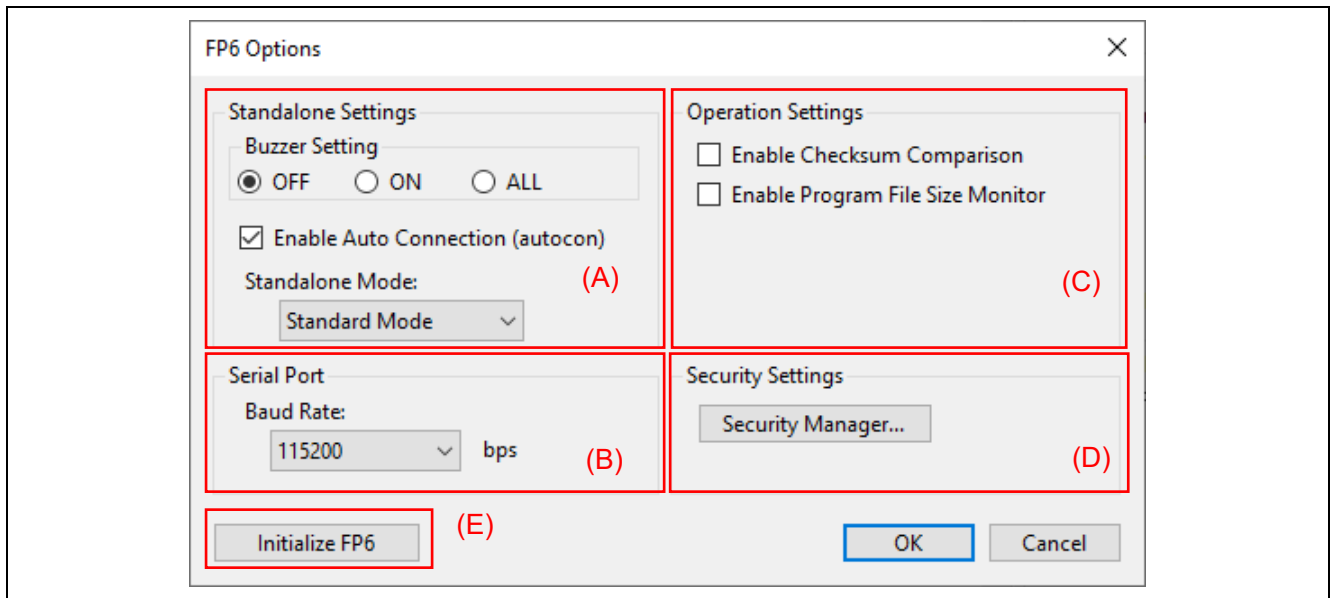

Figure 4.20 [FP6 Options] Dialog Box

(A) Standalone Settings

- Buzzer Setting

This setting specifies the output from the buzzer of the FP6 main unit.

<OFF>

The buzzer is disabled.

<ON>

The buzzer is enabled. The FP6 makes a buzzer sound upon completion of the target device operation in response to pressing the [START] button on the FP6 or clicking on the [Start] button on the FP6 Terminal.

<ALL>

The buzzer is enabled. The FP6 makes a buzzer sound upon completion of the target device operation in response to the selection of any item of the [Target Device] menu on the FP6 Terminal or any of the submenu items under the [Commands] menu on the FP6 main unit (including an operation following pressing of the [START] button).

- Enable Auto Connection

This checkbox is used to make settings for the automatic connection function during programming of the target device. If this checkbox is de-selected, you must manually connect or disconnect the device before and after programming.

- Standalone Mode

Switch the operating mode of the FP6 main unit.

<Standard Mode>

The default mode at shipment.

<Bank Mode>

In this mode, the active programming area is switched by using bank signals instead of a standalone menu. For bank mode, refer to chapter 6, Usage of the Remote Connector.

<Simple Mode>

In this mode, the active programming area is switched by using the [NEXT] and [CANCEL] buttons. For simple mode, refer to chapter 5, Usage in Standalone Mode.

<Terminal Mode>

This mode disables the operations on the FP6 main unit in response to pressing of the [NEXT], [ENTER], [CANCEL], or [START] button and the input of signals to the remote connector.

In this mode, when the FP6 Terminal or other terminal software is used to operate the FP6, unintended operations of the main unit can be avoided. Other operations are the same as those in the standard mode.

(B) Serial Port

This area is used to change the speed for communications of the serial port of the connected FP6.

(C) Operation Settings

This area is for selecting optional functions that you may wish to use in command execution.

— Checksum Comparison

When this function is enabled and the checksum (*sum*) command of the target device is executed, the checksum of the downloaded program file will be displayed. An error will be reported if there is a mismatch.

— Program File Size Monitor

When this function is enabled and the programming (*prg*) or verify (*ver*) command is executed, an error will be reported in cases where the selected program file has data that exceeds the programmable area of the target device.

(D) Security Settings

This menu item is used to change security settings, such as disabling uploading or modification of FP6 settings. For details, refer to section 4.4.2.7, [FP6 Security Manger].

(E) Initialize FP6

Click on this button to initialize the settings and password that were downloaded to the FP6.

4.4.2.7 [FP6 Security Manger]

To execute [FP6 Security Manager], a password needs to be set in the FP6. If no password has been set in the currently connected FP6, the [Set Password] dialog box will appear.

Remark: Enter a password made up of alphanumeric characters and symbols (up to 64 characters).

The usable symbols are as follows.

a-z, A-Z, 0-9, !, @, #, \$, ^, &, *, (,), _, -, +, =, [,], {, }, ;, :, <, >, |, ., /, ?

Figure 4.21 [Set Password] Dialog Box

If a password is already set in the FP6, the [Login to FP6 Security Manager] dialog box will appear. In this dialog box, enter the password and log in to the [FP6 Security Manager] menu.

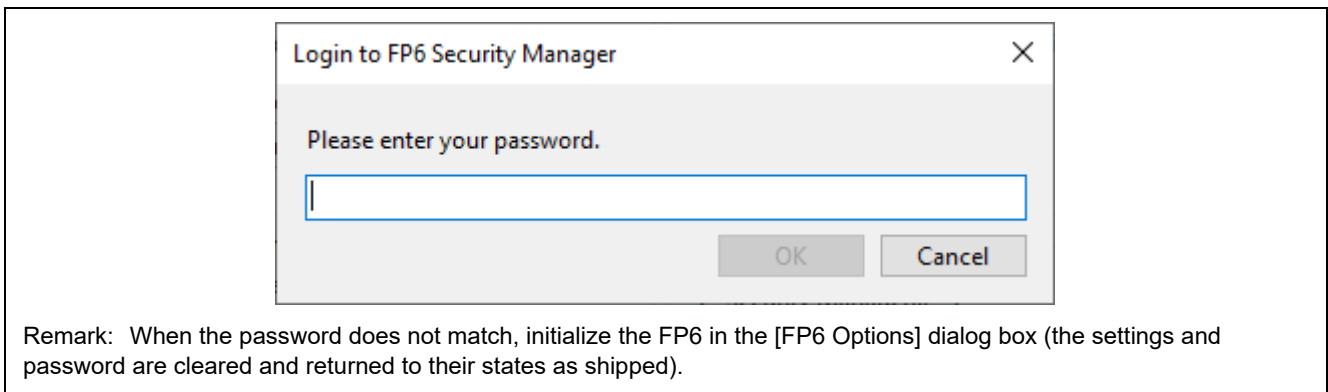

Figure 4.22 [Login to FP6 Security Manager] Dialog Box

- [FP6 Security Manager] dialog box
This dialog box allows you to set security facilities or restrictions on the operation of the FP6 main unit and select the encryption of data.

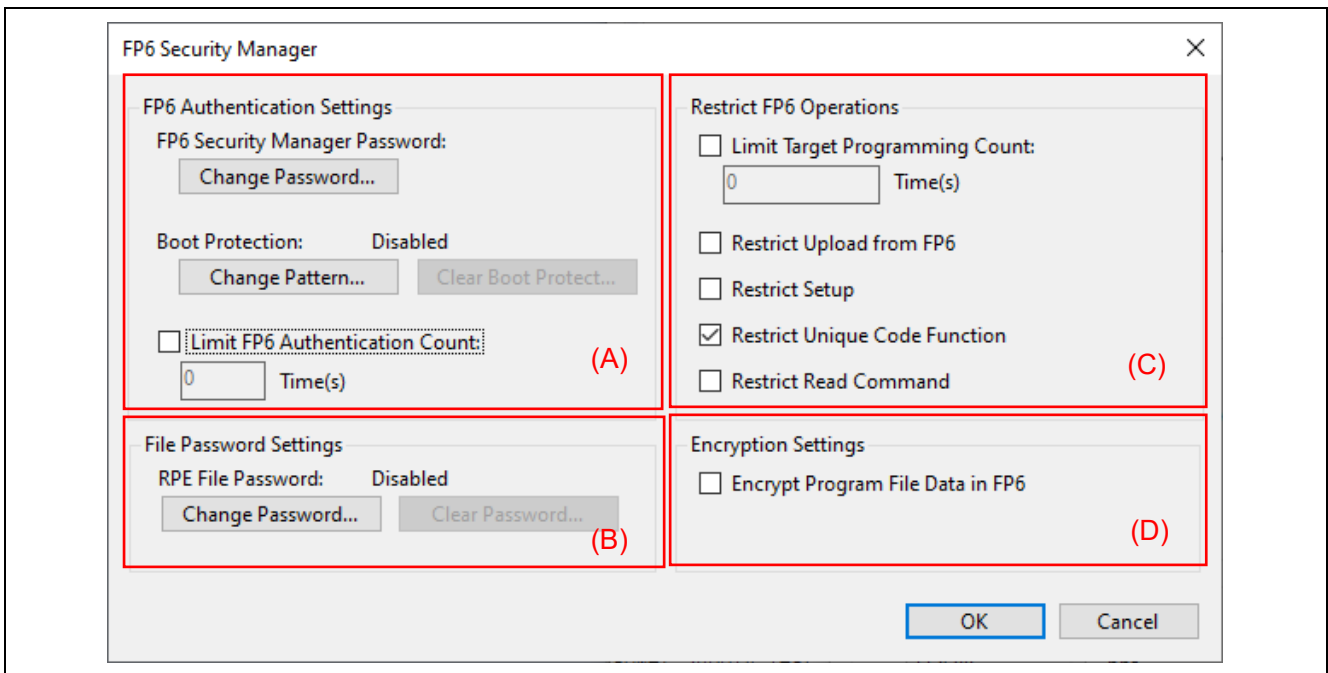

Figure 4.23 [FP6 Security Manager] Dialog Box

(A) FP6 Security

This area is for making the security settings (password or pattern) including a limit on the number of times authentication can be attempted on the FP6 main unit.

- Change Password
Allows you to change the password for logging in to the [FP6 Security Manager] dialog box.
- Boot Protection
Provides a facility for locking the FP6 main unit.
Pressing the [NEXT], [ENTER], and [CANCEL] buttons on the FP6 main unit sets and clears the authentication patterns. Pressing the [START] button specifies the pattern. (Pattern length: 1 to 32)

Remark: If boot protection is set, the operation of the target device is restricted until the protection is released by the correct authentication pattern after the FP6 has been started.

Caution: Changing the settings in the FP6, removing data, and uploading data from the FP6 are enabled even before release from boot protection by using the authentication pattern. Accordingly, also set [Restrict FP6 Operations] in the [FP6 Security Manager] dialog box.

- Limit FP6 Authentication Count

A limit of from one to ten attempts at authentication can be specified.

(B) File Password Settings

This area is for setting and clearing the passwords of RPE files. Setting of the password is required before downloading of an RPE file. For details on RPE files, refer to chapter 8, Encryption Utility Program.

(C) Restrict FP6 Operations

This area is for restricting the operation of the FP6.

- Limit Target Programming Count

The number of times the target device can be programmed is set (0 to 100000).

Once the set number has been reached, programming and verifying facilities are not available.

To enable the facilities again, set a larger number or disable this facility.

- Restrict Upload from FP6

This box is for prohibiting the uploading of settings files included in program files from the FP6 main unit.

- Restrict Setup

This box is for prohibiting the downloading of settings files and program files to the FP6 main unit.

- Restrict Unique Code Function

This box is for prohibiting programming of the unique code (serno command) and setting of the ID code with the specification of the <ID Code> option (of the sid command).

For details on programming of the unique code, refer to section 7.4.17, serno command. For setting of the ID code, refer to section 7.5.28, sid command.

- Restrict Read Command

This box is for prohibiting execution of the following reading commands of the FP6 main unit.

gdi command, gid command, gos command, and read command

Caution: These are not security functions of the target device. Although this makes execution of the above commands from the FP6 main unit impossible, use the security functions of the target device to avoid reading by other tools.

(D) Encryption Settings

- Encrypt Program File Data in FP6

Program file data to be downloaded to the FP6 main unit are always encrypted (AES; 128-bit block length). If this setting is enabled, programming the device and the verification time will be slightly increased.

Caution: Data are encrypted and saved in the flash memory in the FP6. During programming, data are decrypted for use in communications with the target device.

4.4.3 [Target Device] menu

This menu is used to perform operations for the target device, such as erasure or programming. When the selected target device does not support a given function, the corresponding menu item will be hidden. This menu is invalid when the FP6 main unit has not been connected.

4.4.3.1 Connect

This command is used for connection with the target device. This menu item is only selectable when automatic connection of the connected FP6 main unit is disabled (see Enable Auto Connection under (A) Standalone Settings in 4.4.2.6, [Programmer Setting]).

4.4.3.2 Disconnect

This command is used for disconnection from the target device. This menu item is only selectable when automatic connection of the connected FP6 main unit is disabled.

4.4.3.3 Blank Check

This command checks if data has already been written to the flash memory in the target device.

4.4.3.4 Erase

This command erases flash memory in the target device.

4.4.3.5 Program

This command writes data that has been downloaded to the FP6 to the flash memory in the target device.

4.4.3.6 Verify

This command compares data written to the target device with data downloaded to the FP6.

4.4.3.7 Read Memory

This command reads data from the flash memory in the target device.

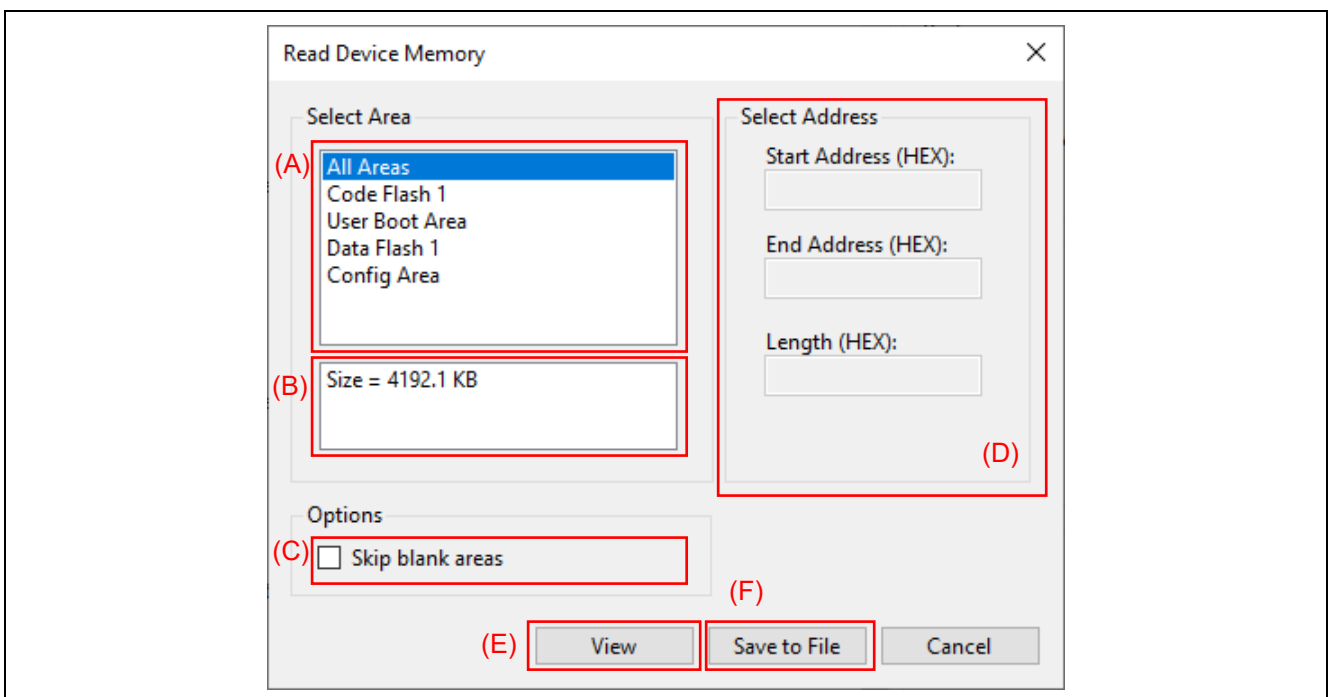

Figure 4.24 [Read Device Memory] Dialog Box

(A) List of areas

Specify the area to be read.

(B) Information on an area

Displays information on an area selected in the list of areas.

(C) [Skip blank areas]

If this checkbox is selected, blank areas of the target device are to be skipped in the reading of data from memory.

Remark: The sizes of the ranges over which areas may be blank depend on the target device. In some devices, selecting this option may increase the time for reading memory.

(D) [Select Address]

Change the addresses when only a specific range is to be read.

(E) [View] button

Information that has been read from memory is displayed in the console window. Data from memory are displayed in units of 4 Kbytes. Clicking on any key continually repeats starting the output of the information in memory.

(F) [Save to File] button

Information that has been read from memory is saved to a file.

Remark: Select the format of the file for saving the memory data when specifying a file name in the [Save File] dialog box.

4.4.3.8 Program Flash Options

This command sets flash options, such as option bytes, security, flash access window, OTP, and lock bits, which have been set on the [Flash Options] tabbed page of the [Setup] dialog box, in the target device.

4.4.3.9 Initialize Device

This command initializes the settings for flash memory, boundaries and so on, and cause the DLM state to change to SSD or OEM_PL2.

4.4.3.10 DLM Transition

This command causes a transition to the DLM state. In the [DLM Transition] dialog box, selecting the target DLM state and clicking on **Transition** cause the required transition of the DLM state.

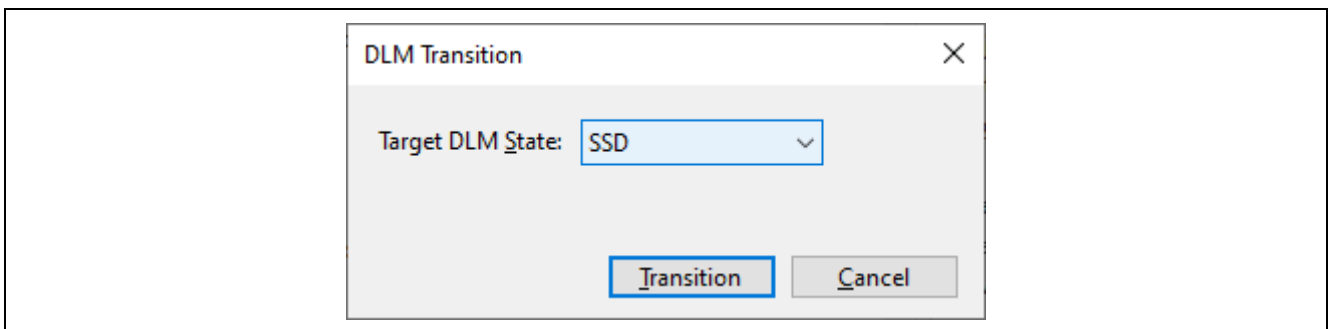

Figure 4.25 [DLM Transition] Dialog Box

(A) Target DLM State

The target DLM state is selected.

(B) Use Unique ID authentication

When this checkbox is selected, the unique ID authentication feature is used during transition to the RMA state.

4.4.3.11 Checksum

This command acquires the checksum of data of flash memory in the target device.

4.4.3.12 SWAS Recover

This command executes the SWAS Recover command in the target device. For the SWAS Recover command, refer to the Flash Boot Firmware User's Manual.

4.4.3.13 Start

This command executes the commands selected in the [Operation Settings] tabbed page of the [Setup] dialog box.

4.4.3.14 Read Signature

This command establishes connection with the target device and displays MCU information in the console window.

4.4.3.15 Read Flash Options

This command acquires information on flash options from the target device and displays it in the console window and a popup dialog box. The acquired information can also be saved as a new setting file.

- [Flash Options] dialog box
The result of executing the Read Flash Options command will be displayed on the [Block Setting] and [Flash Option] tabbed pages of this dialog box.

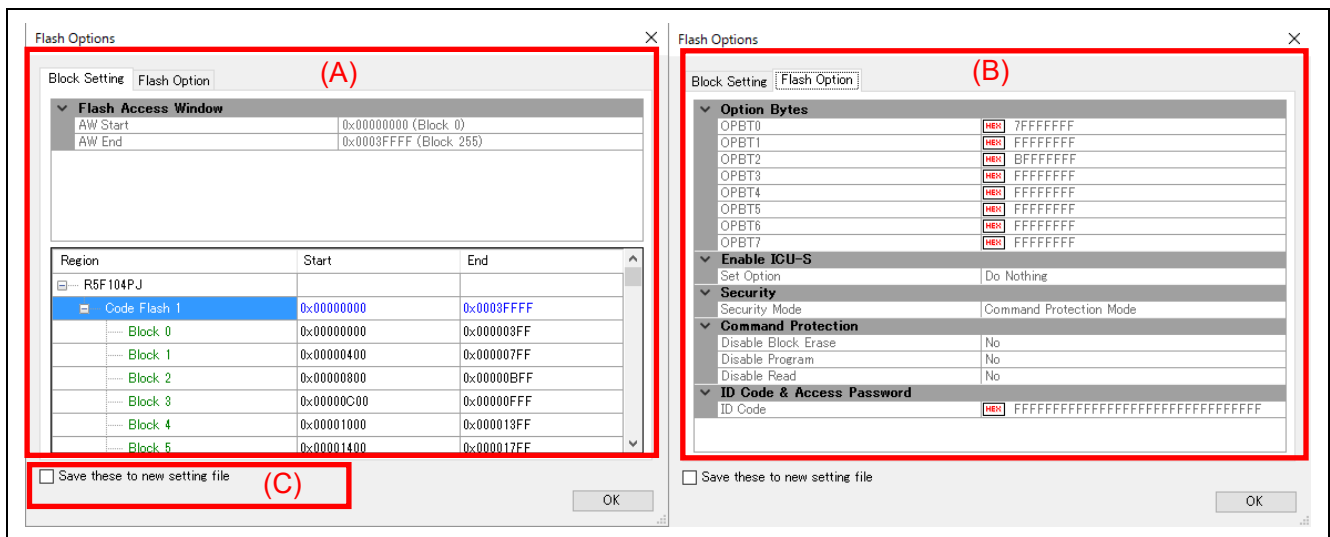

Figure 4.26 [Flash Options] Dialog Box

(A)[Block Setting] tabbed page

This page shows the settings made for [Lockbit & OTP] on the [Block Settings] tabbed page of the [Setup] dialog box. For details, see section 4.3.3, [Block Settings] tabbed page.

(B)[Flash Option] tabbed page

This page shows the settings made on the [Flash Options] tabbed page of the [Setup] dialog box. For details, see section 4.3.4, [Flash Options] tabbed page.





(C)[Save these to new setting file] checkbox

Select this checkbox if you wish to save the flash-option data that have been acquired as a new setting file.

4.5 Toolbar

The menu items frequently used on the FP6 Terminal are displayed as buttons on the toolbar. Similar to the target menus on the menu bar, some buttons may be hidden depending on the selected operation or type of the target device.

Table 4.3 Toolbar Buttons

Icon	Description
	The same action as selecting [New Setting File...] in the [File] menu.
	The same action as selecting [Select Programming Area...] in the [Programmer] menu.
	The same action as selecting [Connect] in the [Target Device] menu. Left side: Connect the FP6 when it is disconnected Right side: Disconnect the FP6 when it is connected
	The same action as selecting [Blank Check] in the [Target Device] menu.
	The same action as selecting [Erase] in the [Target Device] menu.
	The same action as selecting [Program] in the [Target Device] menu.
	The same action as selecting [Verify] in the [Target Device] menu.
	The same action as selecting [Program Flash Options] in the [Target Device] menu.
	The same action as selecting [Start] in the [Target Device] menu.
	The same action as selecting [Programmer Setting] in the [Programmer] menu.

4.6 Example of Operation Using the FP6 Terminal

This chapter explains a series of basic FP6 operations using the FP6 Terminal, taking a case where the RL78/G14 is used as the target device as an example.

- Series of operations described in this chapter:

The operation conditions for this chapter are as follows.

- Host PC interface: USB
- Active programming area: Area 0
- Target device: R5F104PJ (RL78/G14)
- Power supply: 5 V supplied from the FP6
- Clock supply: 32 MHz (on-chip oscillator clock)
- Communications interface: Single-wire UART (1 Mbps)
- Security setting: Disabled
- Block setting: Operations are to be on all blocks.
- Flash options: Not used

The operation steps described in this chapter are as follows.

- (1) Installing the FP6 Terminal and USB driver
- (2) Connecting the FP6 to the host PC
- (3) Connecting the target system
- (4) Starting up the FP6 Terminal
- (5) Setting up a programming environment
- (6) Executing the [Start] command
- (7) System shutdown

4.6.1 Installing the FP6 Terminal and USB driver

Refer to chapter 3, Software Installation, and install the FP6 Terminal and the USB driver on the host PC.

4.6.2 Connecting the FP6 to the host PC

1. Connect the USB connector of the FP6 to the USB port on the host PC via a USB cable.
2. Connect the power adapter (which comes with the FP6) to the FP6.
3. Turn on the power switch on the FP6. Do not connect the target device before turning on power.

4.6.3 Connecting the target system

Be sure to turn on the power of the FP6 before connecting the target system.

1. Connect the GND connector of the FP6 to the target system via the GND cable.

Note: The FP6 and target system may be damaged if there are differences in potential between the grounds of the FP6 and of the target system. Use the GND cable to eliminate differences in potential before connecting the target cable.

2. Connect the target connector of the FP6 to the target system via the target cable.

Note: Connect the target system before supplying V_{CC} power from the target system.

4.6.4 Starting up the FP6 Terminal

1. Click on the [Start] menu and select [PG-FP6] to start the FP6 Terminal.
2. When the FP6 Terminal is started correctly and connected to the FP6, the main window is opened.

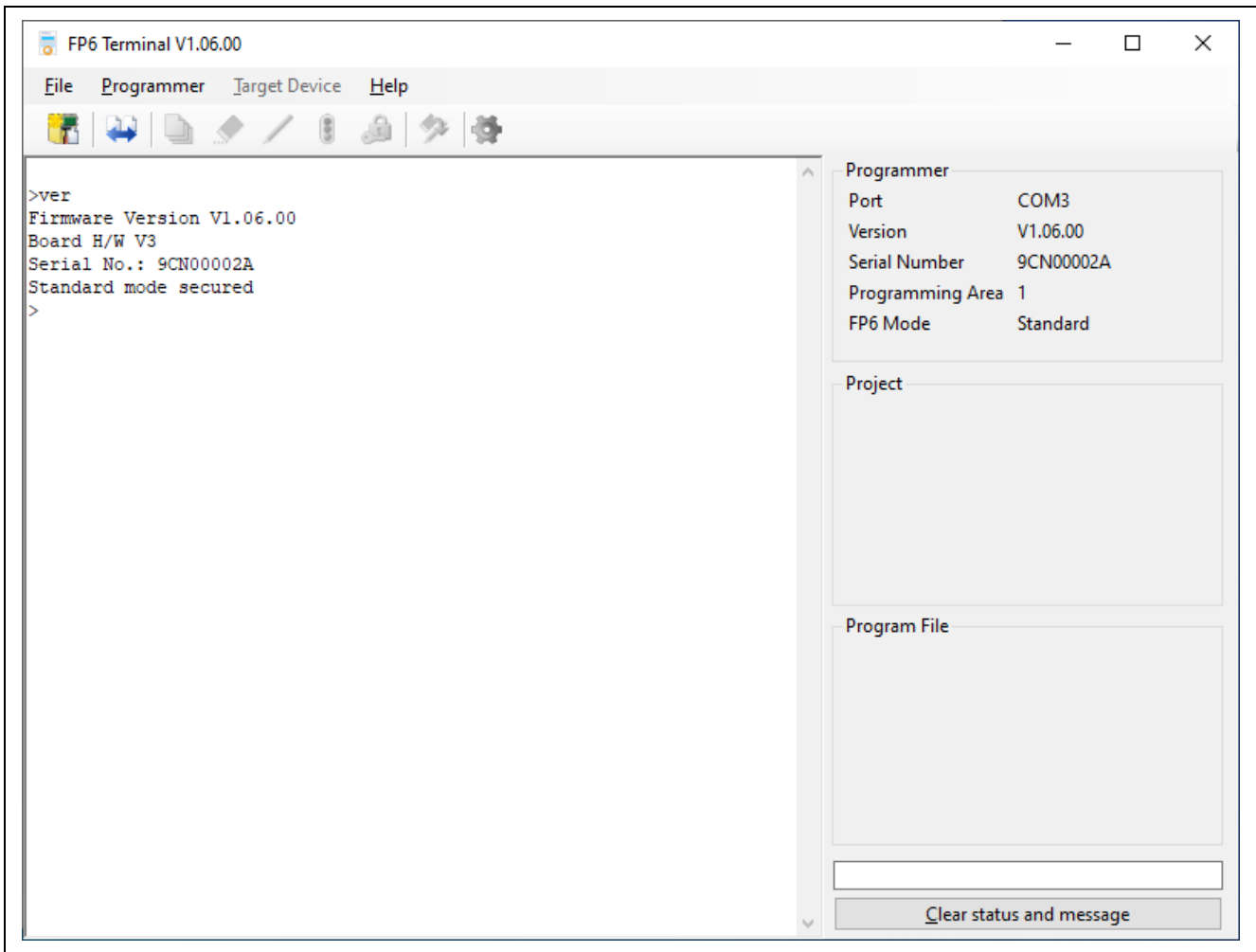

Figure 4.27 Main Window

4.6.5 Setting up a programming environment

1. When the main window is opened, select [New Project...].

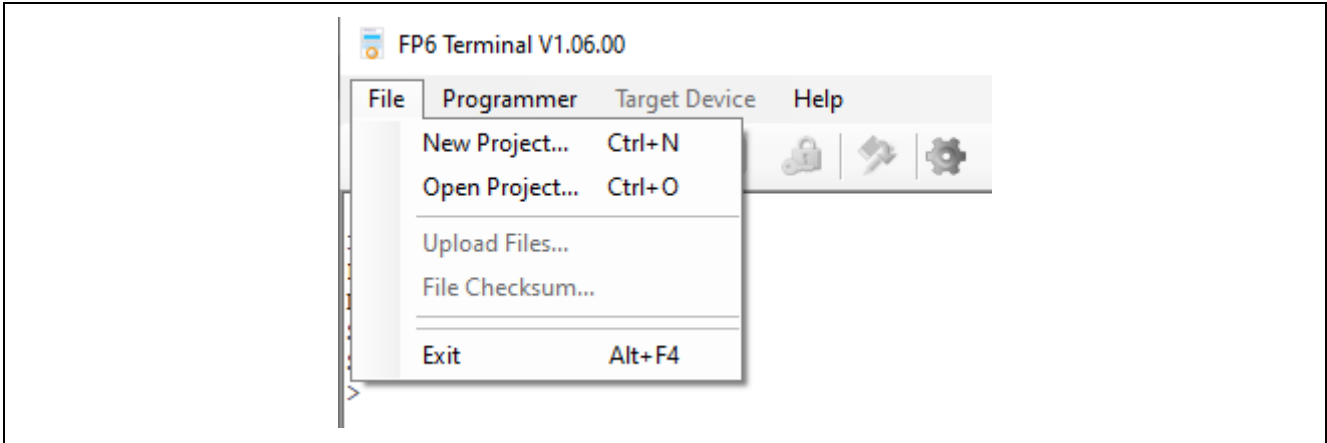

Figure 4.28 [New Project] Menu

2. Create a new setting file. Select the family, group, and type name of the target device, and enter a setting name as shown in Figure 4.29, and click on the [OK] button.

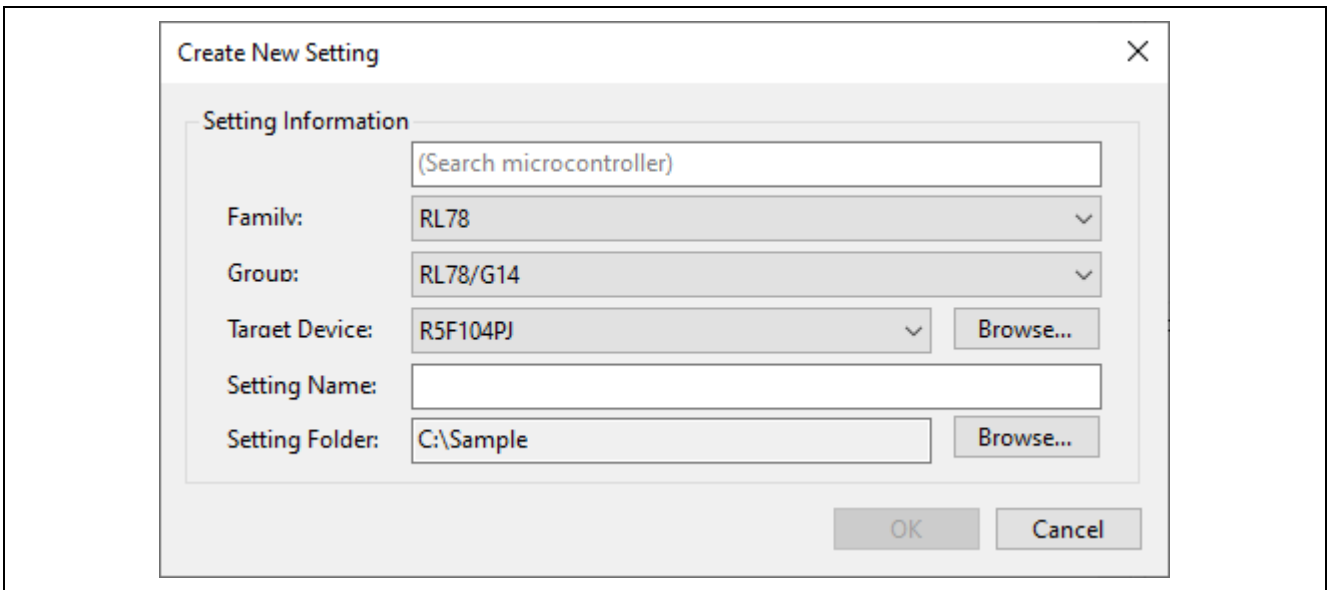

Figure 4.29 [Create New Setting] Dialog Box

- The [Setup] dialog box will appear. Designate a program file on the [Program Files] tabbed page. Click on the [Browse...] button to select a file.

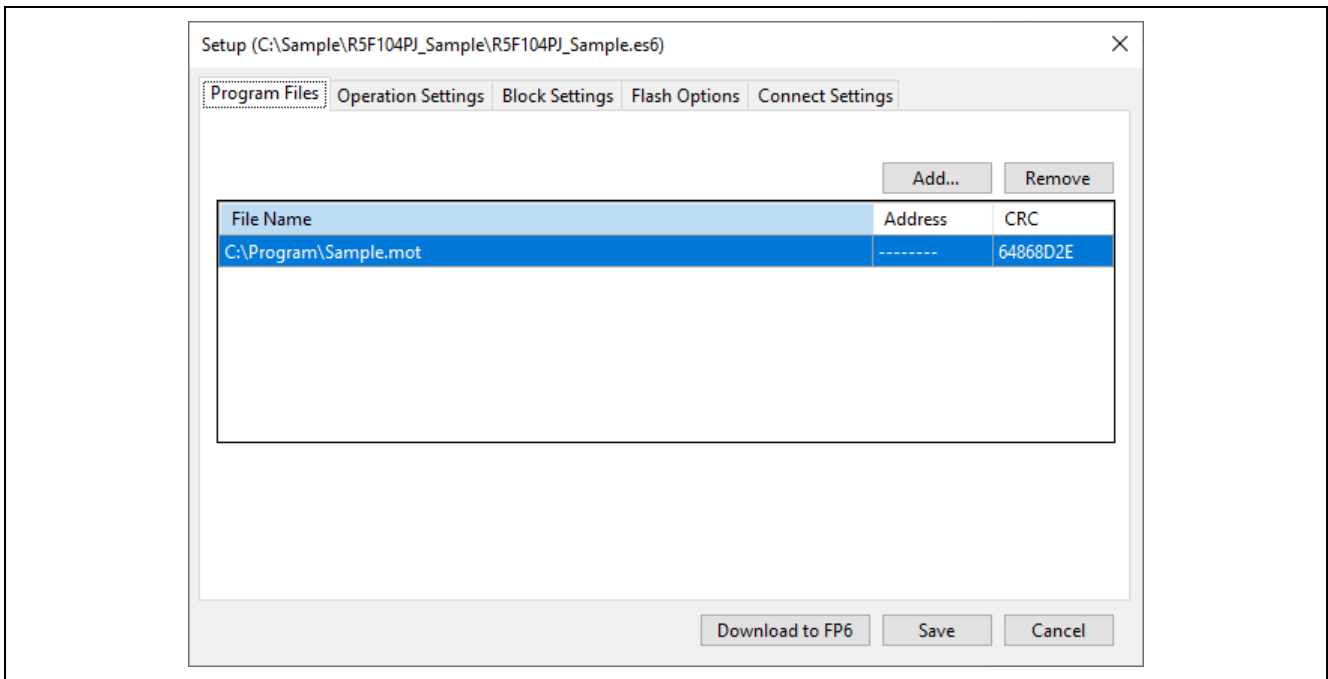

Figure 4.30 Selecting a Program File

- Click on the [Download to FP6] button to download parameter, setup, and program files to the FP6. When downloading is complete, the screen shown below will appear. This completes the setting of the programming environment.

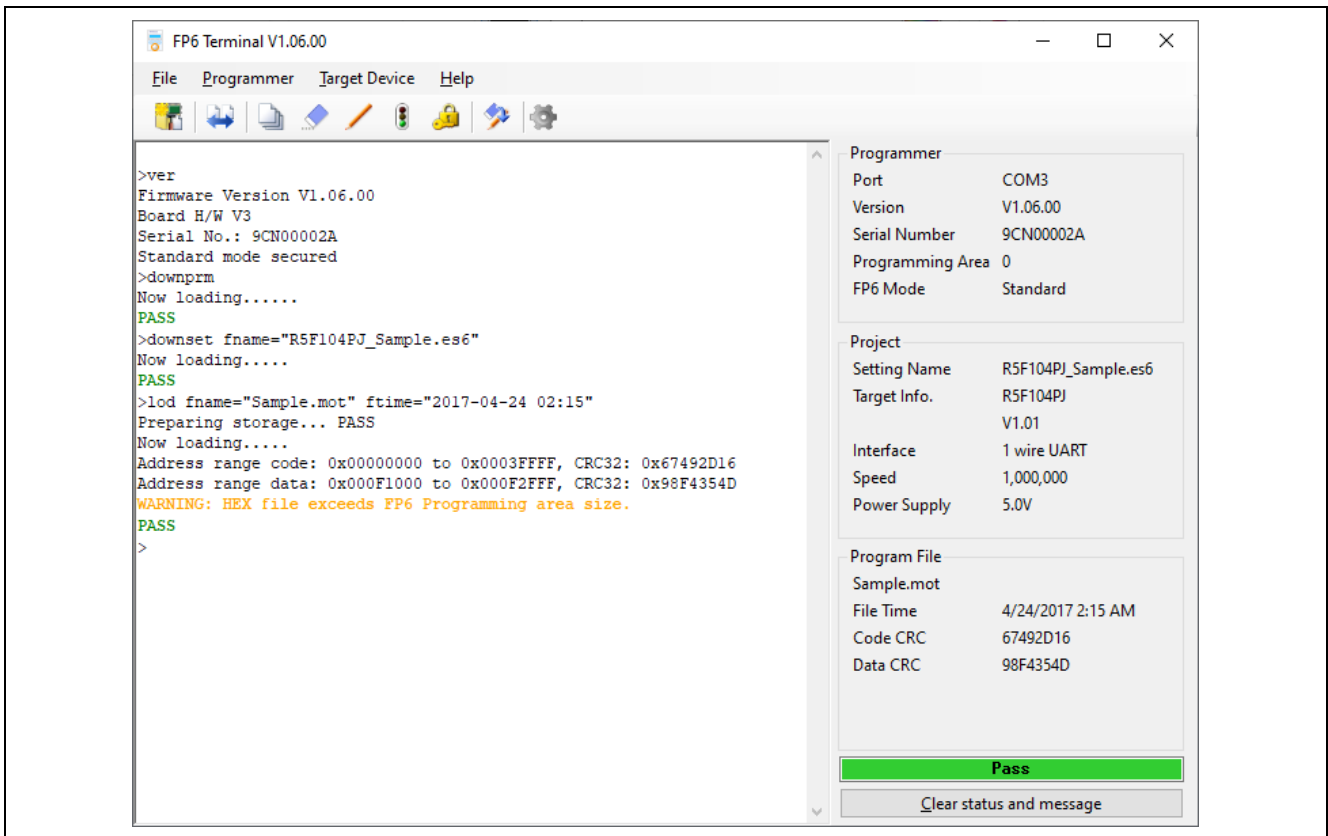

Figure 4.31 Downloading Parameter, Setup, and Program Files

4.6.6 Executing the [Start] command

Execute the [Start] command from the [Target Device] menu.

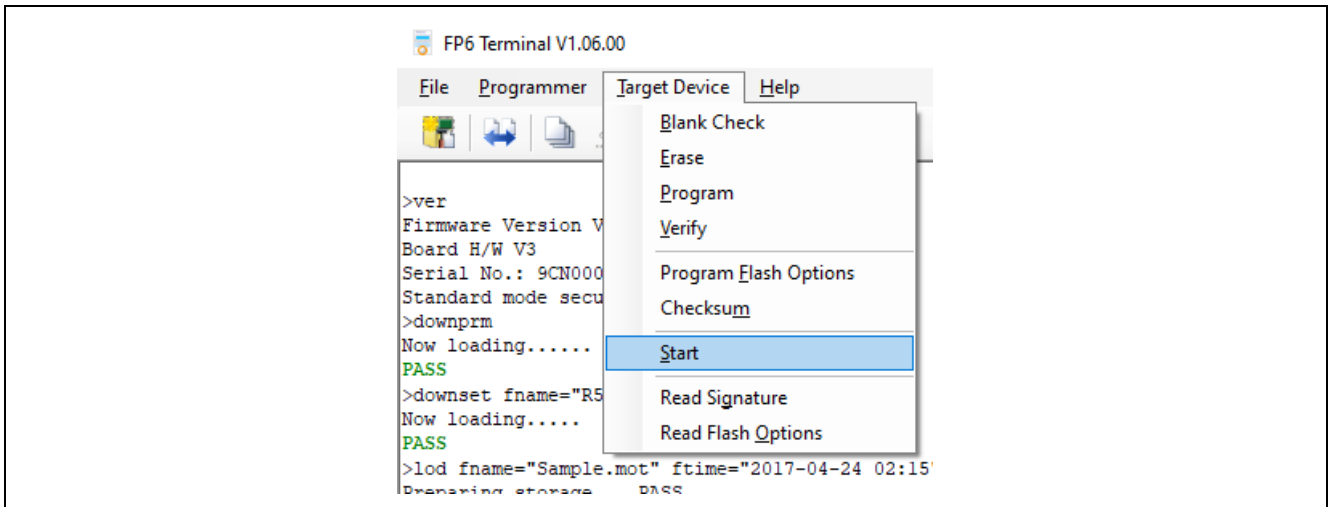

Figure 4.32 [Start] Command

When the [Start] command is executed, the [Erase] and [Program] commands are executed in that order for the R5F104PJ.

Note: If you wish to write to another target system, turn the power off, connect the target system, and supply power before executing the [Start] command.

When execution of the [Start] command is completed, “Erase, Program operation finished” is displayed in the console window.

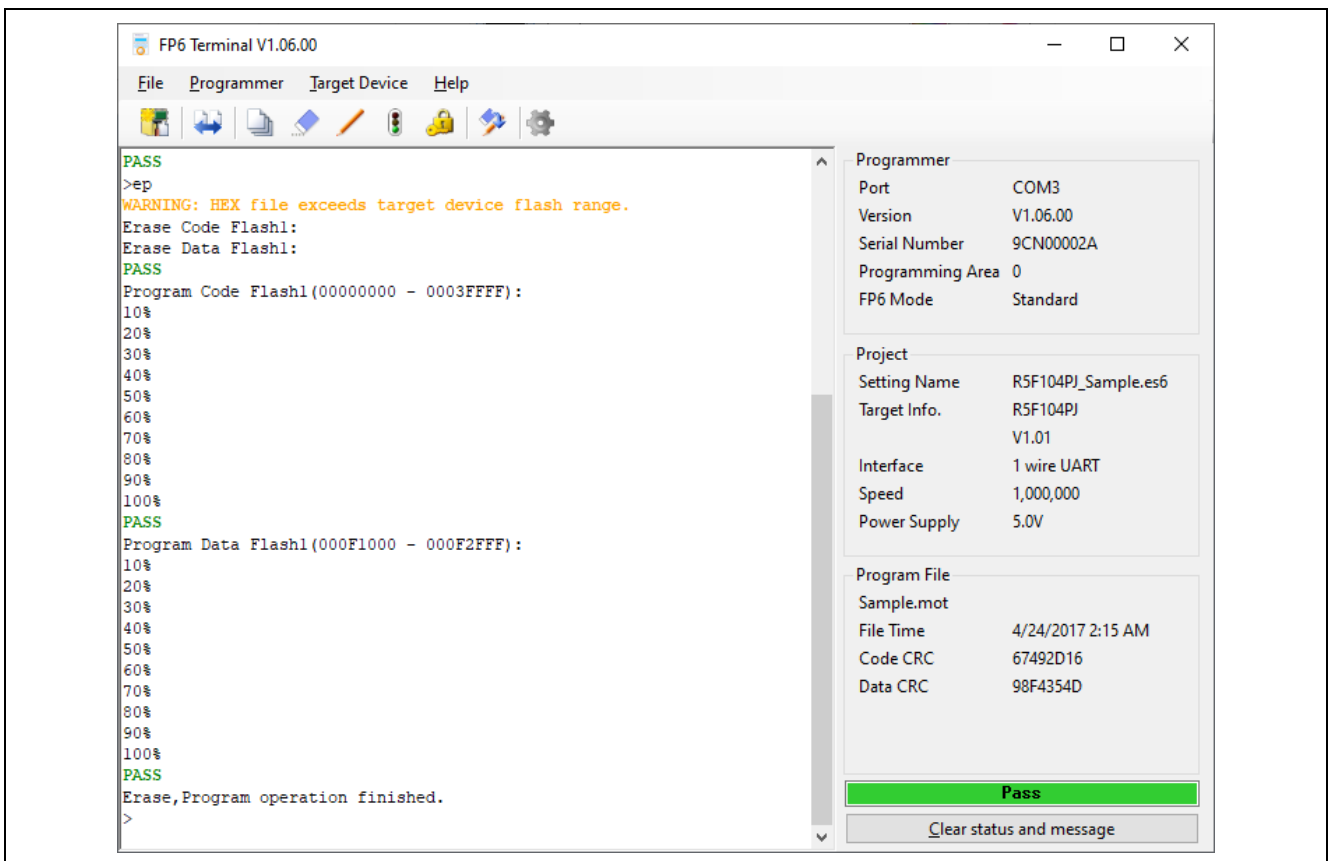

Figure 4.33 Result of Executing the [Start] Command

4.6.7 System shutdown

1. Remove the target system from the target cable.

Note: When Vcc is supplied from the target system, turn the power off before removing the target system.

2. If you do not intend to program any other target devices, execute the [Exit] command from the [File] menu to close the FP6 Terminal. All settings that have been made so far are saved in the setting file and can be restored when the FP6 Terminal is restarted. The parameter, setup, and program files are saved in the FP6 internal flash memory.
3. Turn off the power switch of the FP6.
4. Remove the power adapter and USB cable from the FP6.

Note: If an error has occurred in the above steps, refer to chapter 12, Troubleshooting, and appendix A, Messages. Also refer to 4.4.2.5, [Self Test], and perform self-testing. If this does not resolve the problem, see the FAQ (<https://www.renesas.com/pg-fp6/faq-en>) or access <https://www.renesas.com/contact> for inquiry.

5.Usage in Standalone Mode

The FP6 has a standalone mode in which the FP6 by itself can execute the [Erase], [Program], and [Start] commands without a host PC. This mode is useful for using the FP6 on the production line during mass production and for upgrading in the field.

- Standard mode
Various functions on the LCD menu can be executed by operating buttons on the main unit or inputting the remote interface signal (NEXT, ENTER, CANCEL, START, VERIFY, or CLEAR).
- Simple mode
This mode allows changing the active programming areas by the NEXT button. In this mode, the functions on the LCD menu cannot be executed unlike in the standard mode. Table 5.1 shows assignments of remote interface signals in simple mode.

Table 5.1 Assignments of Remote Interface Signals in Simple Mode

Button on FP6 Main Unit	Pin Number Assigned to Remote Interface Signal	Function in Simple Mode
CANCEL	5	CANCEL
ENTER	6	Depends on the [Start] setting.
NEXT	7	Changes active programming areas. (Increments the number by 1. Returns to 0 after area 7.)
START	9	Depends on the [Start] setting.

- Bank mode
Refer to chapter 6, Usage of the Remote Connector. The message display shows 'BANK Mode'.
- Terminal mode
The FP6 is controlled via the USB or serial port in this mode and pressing of the [NEXT], [ENTER], [CANCEL], or [START] button and the input of signals to the remote connector are disabled. The message display shows 'Terminal Mode'.

5.1 Details of Buttons, Message Display, and Status LEDs

In standalone mode, command menus are selected and executed using the control button ([NEXT], [ENTER], [CANCEL], or [START]) on the top of the FP6 main unit.

The selected command menu is shown in the message display, and the result of command execution is indicated by the message display and status LEDs.

The command menu consists of two levels of menus: a main menu and submenu.

- [NEXT] button: Displays the next menu on the same level.
- [ENTER] button: Selects or executes the menu item currently displayed.
- [CANCEL] button: Cancels the current selection and returns to the previous menu level. It also stops the execution of the [Read] command if the command is currently running. In some target devices, the execution of other commands can also be stopped while they are running.
- [START] button: Executes the [Start] command. It can be executed from any command menu, and the display returns to the same command menu after execution.

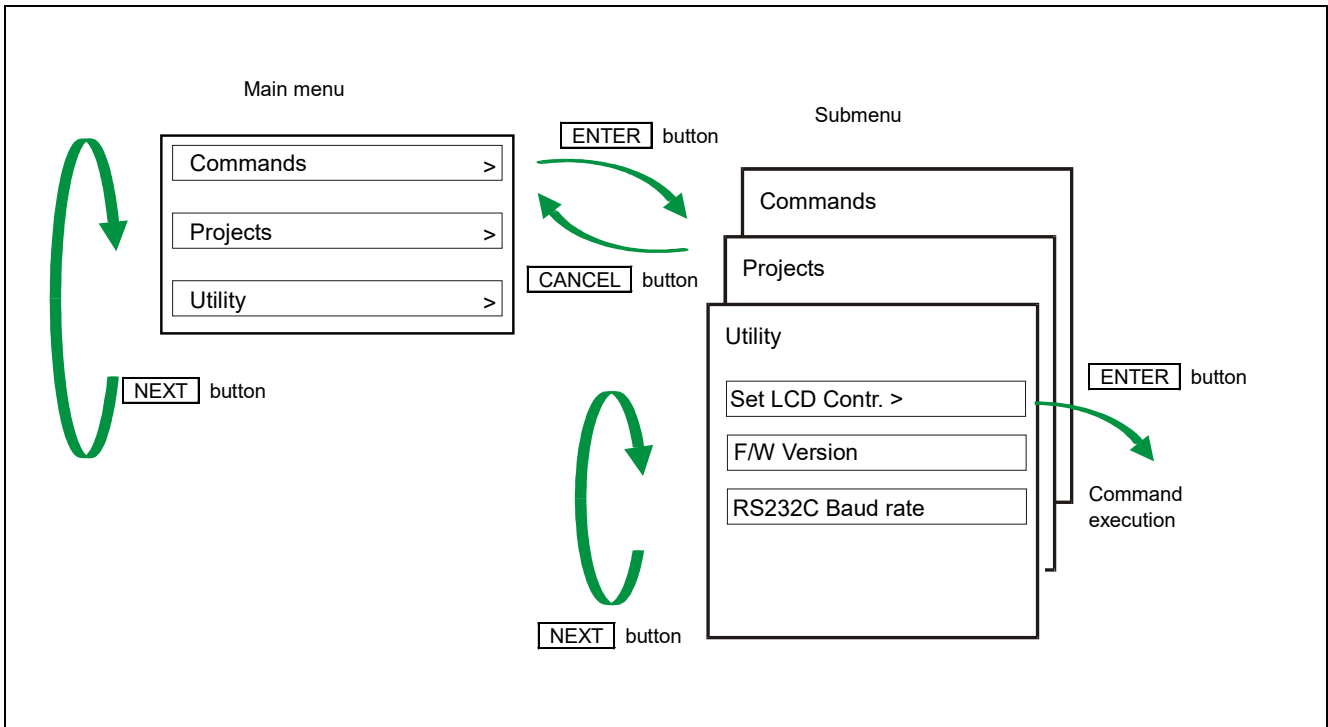

Figure 5.1 Transition of the States of Menus by Using Buttons

On the main menu level, the FP6 shows the selectable menu items. On the submenu level, the first line and the second line in the message display show the menu item and the response from the FP6, if any, respectively.

A command prompt '>' displayed at the end of a menu line indicates that it is selectable with the [ENTER] button, or that the menu (command) can be executed. If the command prompt '>' is not displayed at the end of a menu line, it means that the function is available only for display.

When power to the FP6 is turned on, 'Commands >' is displayed in the message display.

The status LEDs indicate the states of communications with the MCU and the result of execution, as shown below.

Table 5.2 Status LEDs

Status LED	Color	State
PASS	Blue	The selected command has been executed correctly. The command that has been correctly executed is displayed in the message display.
BUSY	Orange	The selected command is under execution. The detailed execution state is displayed in the message display.
ERROR	Red	The selected command has been executed incorrectly. Details on errors are displayed in the message display.
VCC	Green	Power is being supplied to the user system.

Note: For details on errors displayed in the message display, refer to appendix A.2, Error Messages Produced by the FP6 Main Unit.

5.2 Standalone Operation Menu

In standalone mode, the programming environment of the target device can be checked and then programs can be written by using the commands explained in this section.

5.2.1 [Commands] menu

The [Commands] menu provides various commands required for programming the target device. Select a command from this menu and press the [ENTER] button; the FP6 will then execute the command for the target device, based on the settings downloaded to the active programming area. For details on command execution, refer to section 4.4.3, [Target Device] menu.

Table 5.3 [Commands] Menu

Main Menu	Submenu	Description
[Commands >]	[E.P. >]	Pressing the [ENTER] button executes the [Start] command.
	[Program >]	Pressing the [ENTER] button executes the [Program] command.
	[Erase >]	Pressing the [ENTER] button executes the [Erase] command.
	[Verify >]	Pressing the [ENTER] button executes the [Verify] command.
	[Program Flash Options >]	Pressing the [ENTER] button executes the [Program Flash Options] command.
	[Checksum >]	Pressing the [ENTER] button executes the [Checksum] command. The checksum value read from the MCU is displayed in the message display. When there are multiple checksum values, pressing the [ENTER] button switches among the values.
	[Signature >]	Pressing the [ENTER] button executes the [Read Signature] command. The MCU name is displayed in the message display.
	[Erase Chip >]	Pressing the [ENTER] button executes the [Initialize device] command.
	[Connect >]	Pressing the [ENTER] button executes the [Connect] (con) command.
[Disconnect >]	Pressing the [ENTER] button executes the [Connect] (dcon) command.	

5.2.2 [Project] menu

The [Project] menu is used to check information about switching the active programming area and checking the setting file name, program file name, and CRC value.

Table 5.4 [Project] Menu

Main Menu	Submenu	Description
[Project >]	[Project Name >]	Display the name of the setting file stored in the active programming area on the message display.*
	[PRM Name >]	Display the name of the parameter file stored in the active programming area on the message display.*
	[Program File >]	Display the name of the program file stored in the active programming area on the message display.*
	[File Checksum >]	Display the CRC-32 (the sum of the CRC-32 results for all areas which is displayed during downloading) of the entire file in the message display.*
	[Progarea >]	Pressing the [ENTER] button causes a transition to the next programming area.

Note: If the file to be displayed has not been downloaded, [n.a.] is displayed. If the file name exceeds 16 characters, “~” is displayed as the 16th character.

5.2.3 [Utility] menu

The [Utility] menu is used to adjust the LCD contrast and check the firmware version of the FP6 main unit.

Table 5.5 [Utility] Menu

Main Menu	Submenu	Description
[Utility >]	[Set LCD Contr. >]	Adjust the contrast in the message display. After pressing the [ENTER] button, the contrast can be adjusted using the [NEXT] (darken) or [CANCEL] (lighten) button. To fix the contrast, click on the [ENTER] button.
	[F/W Version]	Pressing the [ENTER] button displays the FP6 firmware version.
	[RS232C Baud rate]	Pressing the [ENTER] button displays the current baud rate value set for the RS-232C host interface.

6.Usage of the Remote Connector

This chapter describes the usage of the remote connector.

The FP6 can be remotely controlled by connecting the remote connector and external control device. Remote control can be used to operate and check programming and the display of PASS, BUSY or ERROR from the external control device.

6.1 Remote Interface Mode

The remote interface has a standard mode and a bank mode.

The modes are switched by using [Operation Mode] of [FP6 Options].

For details of the mode setting, refer to section 4.4.2.6, [Programmer Setting].

- Standard mode or simple mode
The same signals as the control buttons (NEXT, ENTER, and CANCEL) on the command menu of the FP6 unit can be input.
- Bank mode
This mode allows inputting of the bank signals (BANK0 to BANK2) that indicate the programming area. The control buttons (NEXT, ENTER, and CANCEL) will change their functions to those inputting bank signals.
- Terminal mode
All input signals (CANCEL, ENTER, NEXT, VRF, START, and CLR) are ignored.

7.Usage of Communications Commands

This chapter describes how to use communications commands from a host PC to operate the FP6.

7.1 Starting the Communications Software

In order to use communications commands for operation, communications with the FP6 must be established with communications software. In this chapter, we shall describe how to use communications software to establish communications.

7.1.1 Connecting the system

For connection via the USB, connect a USB cable to the USB port on your host PC, and then connect the other end to the USB connector on the FP6. For connection via the RS-232C, connect an RS-232C cable to the RS-232C connector on your host PC and then connect the other end to the RS-232C connector on the FP6. Next, plug the power supply adapter into an outlet, then connect it to the FP6 power supply connector.

7.1.2 Starting the FP6

After the connections are made, turn on the FP6 power supply switch.

7.1.3 Starting communications software

Start communications software.

Check the COM port number with Device Manager.

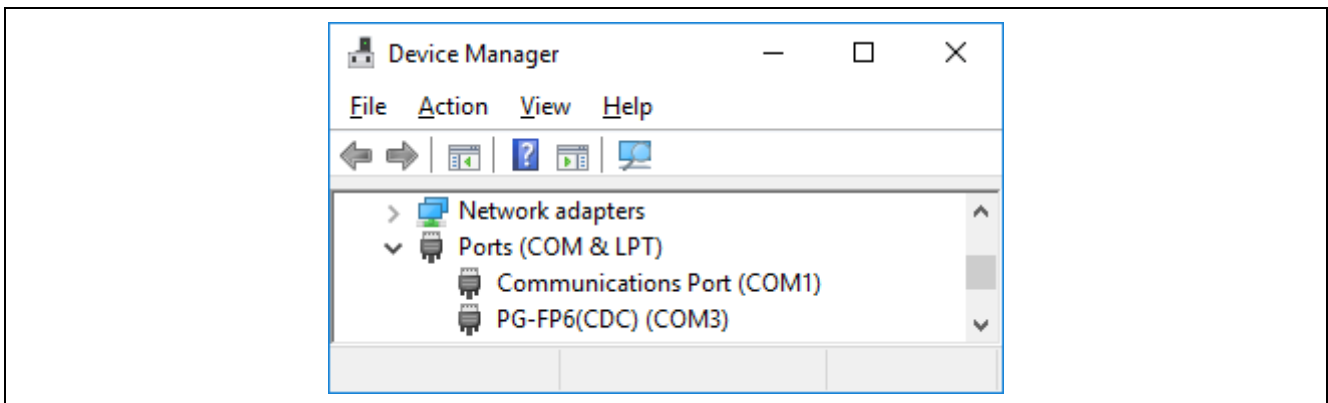

Figure 7.1 Checking the COM Port Number Settings

In the case of using the RS-232C cable, select the data transfer conditions listed below.

Data transfer rate: 9600 bps, 19200 bps, 38400 bps, 57600 bps, or 115200 bps

Data bits: 8 bits

Parity: None

Stop bit: 1 bit

Flow control: Hardware

Remark: The above settings are optional for a USB connection.

The default data transfer rate is 9600 bps, but it may be changed by the FP6 Terminal or terminal commands to another rate. In such cases, use [RS232C Baud rate] from [Utility] in the LCD panel of the FP6 main unit to check the transfer rate and make sure that it matches that of the host.

When communications software starts correctly, the main window will open. If communications are established, then a ">" will be displayed when the Enter key on the host PC is pressed. This completes the preparation for using communications commands.

Note: Press the Enter key once after FP6 has started. Alternatively, send a linefeed code once to FP6 by using communications software.

7.2 Command Lists

The following is a list of commands that control the FP6 main unit and the target device.

Table 7.1 List of FP6 Control Commands

Command Name	Description
autocon	This command is used to select whether to automatically or manually connect or disconnect the target device in the following processes, or to refer to the current setting. <ul style="list-style-type: none"> • From entering flash memory programming mode to verifying the signature • Leaving the flash memory programming mode
brt	Confirms and changes the data transfer rate during serial communications with the host PC.
clear	Turns the PASS and ERROR LEDs off.
conf	Displays a list of the information stored in the FP6.
dwnprm	Downloads the parameter file.
downset	Downloads the setting file.
fcks	Gets a checksum value of the program file that was downloaded to the active programming area of the FP6.
files	Displays the information concerning the program file, DLM key, and user key that were downloaded to the FP6.
fp_mode	Switches the operating mode of the FP6 main unit.
hex	Uploads the program file in Intel HEX format.
hlp	Displays a list of available commands, with simple descriptions.
lod	Downloads the program file, DLM key, and user key to the active programming area of the FP6.
prm	Displays the information concerning the parameter file and setting file that were downloaded to the FP6.
progarea	Confirms, changes and deletes data in the active programming areas.
res	Resets the FP6.
selftest	Executes a self-test.
serno	Sets the unique code for embedding in the program file.
set_auth_id	Changes the authentication ID code to a desired value.
sound	Sets the buzzer.
speed_mode	Adjusts the waiting time and timeout time in communications with the target device.
srec	Uploads the program file in Motorola S format.
trc	Displays the communication information between the FP6 and target device.
upprm	Uploads the parameter file.
upset	Uploads the setting file.
ver	Displays the FP6 version.

Table 7.2 List of FP6 Device Commands

Command Name	Description
bln	Executes the blank check.
clr	Executes the Configuration clear.
con	Executes the processes from “transition to flash memory programming mode” to “signature verification”.
dcon	Executes the termination of the flash memory programming mode.
dln	Refers to the DLM state and causes a transition of the state.
ep	Executes erasure and then programming.
ers	Executes the Erase command.
ers_chip	Initializes the target device.
gdi	Gets the information of blank check and flash option.
ged	Gets the information of endian.
gid	Gets the ID code.
glb	Gets the information of lock bit.
gob	Gets the information of option byte.
gof	Gets the information of OFS.
gos	Gets the information of flash option.
got	Gets the information of OTP.
gsc	Gets the information of security.
gtm	Gets the information of Trusted Memory.
idc	Executes the ID code setting.
opb	Executes the option byte setting.
otp	Executes the OTP setting.
pfo	Sets the flash options collectively.
prg	Executes programming.
read	Reads the flash memory data from the target device.
rsc	Executes the Security Release command.
scf	Executes the [Set Security] command.
sed	Executes the endian setting.
sid	Sets the ID code and enables ID authentication in the serial programming mode.
sig	Executes the Signature read command.
slb	Executes the lock bit setting.
spd	Disables the serial programming.
stm	Executes the Trusted Memory setting.
sum	Executes the Checksum command.
vrf	Executes the Verify command.

7.3 Description of Commands

Each of the commands is described using the following format.

Command name

Presents an overview of the command.

Input format

Presents the input format for the command^{Note}.

Description of the function

Describes the function of the command.

Example of usage

Presents an example of using the command.

Note: The symbols used to describe the input format are defined below.

Notation	Description
Characters within single quotation marks ' '	Characters that must be input as displayed
Characters within angle brackets < >	Information that must be provided
Characters within parentheses ()	Optional items
Options separated by vertical bars	Options where only one option can be selected

7.4 Description of FP6 Control Commands

7.4.1 autocon command

This command is used to select whether to automatically or manually connect or disconnect the target device in the following processes, or to refer to the current setting.

- From entering flash memory programming mode to verifying the signature
- Leaving the flash memory programming mode

Input format

'autocon' ('on | off')

Description of the function

Selects either automatic (on) or manual (off) execution, to be executed before and after the target command completion, of the processes from entering flash memory programming mode to verifying the signature (con command), and leaving the flash memory programming mode (dcon command). The initial value is automatic (on). If this command is executed without an option, the current setting is displayed (automatic (on) or manual (off)). The default setting is automatic (on).

on: The con command and dcon command are executed automatically.

off: The con command and dcon command are executed manually. When set to manual (off), the con command is executed, the target command can be executed. Furthermore, various target commands can be executed multiple times. Execute the dcon command to terminate. Note that the ep command will automatically execute the con command and dcon command even if this is set to manual (off).

Example of usage

Example of Communication Software Terminal Display
<pre>>autocon AutoCon is on / off >autocon on AutoCon is on >autocon off AutoCon is off</pre>

7.4.2 brt command

Confirms and changes the data transfer rate for serial communications with the host PC.

Input format

```
'brt' ('get' | '9600' | '19200' | '38400' | '57600' | '115200')
```

Description of the function

This command can be used with its options to change the data transfer rate for serial communications with the host PC. When the data transfer rate is changed, it will be necessary to change the data transfer rate of the COM port setting with terminal software and reconnect.

If no options are used with this command, the current data transfer rate will be displayed.

If the serial connector is connected, the data transfer rate will be displayed.

If a USB connector is used, the USB version will be displayed.

- USB (HS) ... USB 2.0
- USB (FS) ... USB 1.1

The default data transfer rate is 9600 bps.

- get:** Displays the data transfer rate for the current serial communications with the FP6 main unit when the USB connector is connected.
- 9600:** Changes the data transfer rate to 9600 bps.
- 19200:** Changes the data transfer rate to 19200 bps.
- 38400:** Changes the data transfer rate to 38400 bps.
- 57600:** Changes the data transfer rate to 57600 bps.
- 115200:** Changes the data transfer rate to 115200 bps.

Example of usage

Example of Communication Software Terminal Display

```
>brt
[When the serial connector is connected at 115200 bps]
Current Baud rate is: 115200

>brt
[When the USB connector is connected at High speed]
Current Baud rate is: USB (HS)

>brt 19200
New Baud rate is: 19200
```

7.4.3 clear command

Turns the PASS and ERROR LEDs off.

Input format

'clear'

Description of the function

Turns the PASS and ERROR LEDs on the FP6 main unit off and clears the PASS and ERROR signals of the remote connector.

Example of usage

Example of Communication Software Terminal Display
>clear Process CLR signal of remote interface by command.

7.4.4 conf command

Displays a list of the information stored in the FP6.

Input format

'conf'

Description of the function

Displays information on data downloaded to the FP6 and the settings of the FP6.

Example of usage

Example of Communication Software Terminal Display				
<pre>>conf Firmware Version Vx.xx.xx Board H/W Vx Serial No.: xxxxxxxxxx Standard mode unsecured Active Program Area: 0 Number of Program areas: 8 Max. area size: 384 MByte Free space: 363 MByte Area 0: 2 MByte Area 1: 6 MByte Area 2: 3 MByte Area 3: 10 MByte Area 4: 0 MByte Area 5: 0 MByte Area 6: 0 MByte Area 7: 0 MByte Area Filename Date Time Range CRC *0 test-0.hex 2019-10-17 17:35 00000000-00003FFF 2673FC33 1 {unknown data} 2 test-2.hex 2019-10-17 17:35 00000000-00003FFF 2673FC33 3 test-3.hex 2019-10-17 17:35 00000000-00003FFF 2673FC33 4 {unknown data} 5 {unknown data} 6 {unknown data} 7 {unknown data} Area File name CRC Type *0 R5F104AA 25BDA75F PR5 test-0.es6 B6D40286 ESF 1 R5F564M 1CC12600 PR5 test-1.es6 0FDBCF7A ESF 2 R7FA6M3AF DEC16EA8 PR5 test-2.es6 ABB4801E ESF</pre>				

```

3  R7F701708          92AC1CBE PR5
   test-3.es6        A43294EC ESF
4  {invalid}         PR5
   {invalid}         ESF
5  {invalid}         PR5
   {invalid}         ESF
6  {invalid}         PR5
   {invalid}         ESF
7  {invalid}         PR5
   {invalid}         ESF

```

```

AutoCon is on
Sound is on
EP mode: Standard
speed mode is middle.
Security state is: Inactive
Boot protection: disabled
Max authentication number: 0
Current number of password authentication: 0
Current number of boot authentication: 0
Limit of ep/prg executions: disabled
Remain number of ep/prg executions: 0
Encrypt downloaded data: disabled
Encrypt file password: disabled
Manager flags: 0x00000100
  HEX file Upload enabled
  Device Setup enabled
  Unique Code disabled
  Read Command enabled
Manager option byte: 0x00
  HEX file Upload enabled
  Device Setup enabled
Checksum comparison off
File range check is off

```

7.4.5 downprm command

Downloads the parameter file.

Input format

'downprm'

<Parameter file data>

Description of the function

Downloads the parameter file to the FP6 main unit. Before executing the downset command, be sure to execute the downprm command to download the parameter file. After executing the downprm command, the setting file and program file data are cleared; so execute the downset and lod commands again.

7.4.6 downset command

Downloads the setting file.

Input format

'downset ('fname="filename"')

<Setting file data>

Description of the function

Downloads the setting file to the FP6 main unit.

Be sure to execute the downprm command before the downset command.

Be sure to execute the lod command after the downset command.

File names without options are not stored.

fname="filename":

Specifies the name of the setting file to be downloaded. The maximum number of characters is 50.

If 51 or more characters are specified, the first 50 characters are used.

7.4.7 fcks command

Gets a checksum value of the program file that was downloaded to the active programming area of the FP6.

Input format

'fcks' (<type> (<start1> <end1> (<start2> <end2> (<start3> <end3> (<start4> <end4> (<start5> <end5>))))))

Description of the function

Gets a checksum value of the program file in the active programming area.

Specifies the calculation method, start address and number of bytes in the options.

If this command is specified without options, an appropriate calculation method for the target MCU is used for all the areas.

type: Specifies one of the following calculation methods.

crc: 32-bit CRC method

crc16: 16-bit CRC method

ari: 16-bit subtraction calculation method (When a V850, RL78, or 78K is selected)

32-bit addition calculation method (When a RX, RH850, SuperH, or R8C is selected)

add16: 16-bit addition calculation method

k0s_sp: Division method (original)

startx: The start address is specified in hexadecimal. (A maximum of five ranges can be specified.)

endx: Specifies the end address in hexadecimal. (A maximum of five ranges can be specified.)

Example of usage

Example of Communication Software Terminal Display

```
> fcks crc 0 3ffffff
Checksum Code Flash 1 : 000000-3FFFFFF = 26218DD4

> fcks ari 0 3ffffff 400000 41ffff
Checksum Code Flash 1 : 000000-3FFFFFF = 61C0
Checksum Data Flash 1 : 400000-41FFFF = 0200
Checksum Total       : 63C0
```

7.4.8 files command

Displays the information concerning the program file, DLM key, and user key that were downloaded to the FP6.

Input format

'files' ('key') ('check')

Description of the function

If no options are used, the information (file name, creation date, size, and checksum) concerning the program file downloaded to the FP6 is displayed.

- check: The checksum of all programming areas stored in the program file, from START to END, is recalculated with the 32-bit CRC method, and cross-checked with the checksum stored in the FP6 during download.
- key: Displays the data specified in key files without using a program file.

Example of usage

Example of Communication Software Terminal Display				
Area	Filename	Date	Time	Range CRC<CR+LF>
*0	XXXXX.key	xxxx	xxxx	SECDBG<CR+LF>
	XXXX.key	xxxx	xxxx	00000000<CR+LF>
1	{invalid}			<CR+LF>
2	XXXXXXXXX.key	xxxx	xxxx	00002000<CR+LF>
3	XXX.key	xxxx	xxxx	NONSECDBG<CR+LF>
4	{invalid}			<CR+LF>
5	{invalid}			<CR+LF>
6	{invalid}			<CR+LF>
7	{invalid}			<CR+LF>
>				

7.4.9 fp_mode command

Switches the operating mode of the FP6 main unit.

Input format

'fp_mode' ('Standard' | 'Bank' | 'Simple' | 'Terminal')

Description of the function

Switches the standalone mode of the FP6 main unit. Changing from the standalone mode to the simple mode or return from the simple mode to the standalone mode leads to automatic restarting of the FP6 main unit. If no option is included, the current mode is displayed.

Standard: Switches the FP6 main unit to the normal mode.

Bank: Switches the FP6 main unit to the bank mode.

Simple: Switches the FP6 main unit to the simple mode.

Terminal: Switches the FP6 main unit to the terminal mode.

Example of usage

Example of Communication Software Terminal Display
> fp_mode Bank OK > fp_mode FP6 mode is: Standard

7.4.10 hex command

Uploads the program file to the host PC in Intel HEX format.

Input format

'hex' (<start1><length1>(<start2><length2>(<start3><length3>(<start4><length4>))))

Description of the function

If a program file has been downloaded to an active programming area, executing this command will upload the program file in Intel HEX format. If this command is executed without any options, the upload will be executed with the address size used during downloading. If a program has not been downloaded, "Invalid argument" will be displayed.

start address: The start address is designated as a hexadecimal number. (A maximum of four ranges can be specified.)

length: The number of bytes is designated as a hexadecimal number. (A maximum of four ranges can be specified.)

Example of usage

Example of Communication Software Terminal Display

```
>hex 10000 100
Press any key to start/continue output.
:020000040001F9
:10000000000102030405060708090A0B0C0D0E0F78
:10001000101112131415161718191A1B1C1D1E1F68
:
:1000F000F0F1F2F3F4F5F6F7F8F9FAFBFCFDFF88
:00000001FF
```

7.4.11 hlp command

Lists available commands with brief descriptions.

Input format

'hlp'

Description of the function

Lists available commands with brief descriptions.

Example of usage

Example of Communication Software Terminal Display	
<pre>>hlp</pre>	
<pre>----- Control commands -----</pre>	
<pre>downprm/downset</pre>	<pre>: Download parameter/customer settings</pre>
<pre>upprm /upset</pre>	<pre>: Upload parameter/customer settings</pre>
<pre>lod</pre>	<pre>: Download Intel Hex or Motorola S-record file</pre>
<pre>hex/srec</pre>	<pre>: Upload Intel Hex / Motorola S-record file</pre>
<pre>progarea</pre>	<pre>: Change Program area</pre>
<pre>files</pre>	<pre>: Show downloaded HEX/SREC files in FP6 memory</pre>
<pre>prm</pre>	<pre>: Show Parameter file (PRM/SET) information</pre>
<pre>conf</pre>	<pre>: Show / Modify FP6 configuration</pre>
<pre>brt</pre>	<pre>: Set Baud rate to host</pre>
<pre>fcks</pre>	<pre>: Calculate file checksum (FP6 memory)</pre>
<pre>ver</pre>	<pre>: Show firmware version</pre>
<pre>res</pre>	<pre>: Reset FP6</pre>
<pre>sound</pre>	<pre>: Enable / Disable sound generation</pre>
<pre>trc</pre>	<pre>: Show Device communication trace</pre>
<pre>selftest</pre>	<pre>: Perform a Selfcheck</pre>
<pre>----- Device commands -----</pre>	
<pre>bln</pre>	<pre>: Blankcheck</pre>
<pre>ers</pre>	<pre>: Erase</pre>
<pre>prg</pre>	<pre>: Program</pre>
<pre>vrf</pre>	<pre>: Verify</pre>
<pre>read</pre>	<pre>: Read</pre>
<pre>ep</pre>	<pre>: Erase and Program</pre>
<pre>sig</pre>	<pre>: Show device signature</pre>
<pre>sum</pre>	<pre>: Get device checksum</pre>
<pre>scf</pre>	<pre>: Set security information</pre>

7.4.12 lod command

Downloads the program file, DLM key, and user key to the active programming area of the FP6.

Input format

'lod' ('add') ('key' <type> (<address>)) (fname="<filename>") (ftime="<date and time>")

Description of the function

Downloads the program file, DLM key, and user key to an active programming area. After this command is executed, the program file must be downloaded to the FP6 in ASCII format using communications software. If using the terminal software, select [Transfer], and then select the program file. The options are to delete or not to delete the file before downloading, the file name, and the creation date. If this command is executed without any options, the file name and creation date will not be stored. Use the FP6 Terminal.

Caution: In V1.04.00 and later versions, the CRC of the program file in the range of the ROM space of the target device is calculated and displayed before the program file is downloaded. Data outside the range of the ROM space are not in the scope of CRC calculation.

add: Specifying the add option omits the erasure of data that have been stored in the FP6 before downloading of the file for programming.

- Notes:**
1. The name of the file for programming and the date and time of its creation are specified as fname and ftime at the time of saving when the command is executed with the add option.
 2. If the amount of data in the file from the target address for downloading overlaps earlier data, the later data to have been downloaded become valid.

key <type>: Specifying the type of key.

- seckey: SECDBG key
- nonseckey: NONSECDBG key
- rmakey: RMA key
- userkey: User key

<address>: Specifying the start address when the user key is specified.

- al2key: AL2 key
- al1key: AL1 key
- oem_root0: OEM Root Public key 0
- oem_root1: OEM Root Public key 1
- oem_root2: OEM Root Public key 2
- oem_root3: OEM Root Public key 3

fname = "filename":

Designates the file name of the program file that is downloaded. The maximum number of characters is 31. If 32 or more characters are specified, the first 31 characters are used.

ftime = "date and time":

Designates the creation date and time of the downloaded program file. The format is YYYY-MM-DD HH:MM.

YYYY: Year; MM: Month; DD: Date; HH: Hour; MM: Minute

Example of usage

Command	Status	Status LED	Message Display	Screen Output
lod	Display after execution of the command (before downloading)	BUSY	*** BUSY ***	Preparing storagePASS Now loading...
	Display during downloading	BUSY	*** BUSY ***	...
	Display after normal ending of the download	PASS	Returns to the display before executing the command.	PASS
	Display after error ending of the download	ERROR	Returns to the display before executing the command.	ERROR: <text>

Example of Communication Software Terminal Display

```
>lod
[When the MCU supports only the code flash area]
Address range: 0x00000000 to 0x00003FFF, CRC32: 0xC80EBAB6
PASS

>lod fname="sample.hex" ftime="2006-02-24 21:13"
[When the MCU also supports areas other than code flash]
Address range code: 0xFFFF0000 to 0xFFFFFFFF, CRC32: 0xD253DA27
Address range data: 0x00100000 to 0x00107FFF, CRC32: 0x0CA407F9
Address range boot: 0xFF7FC000 to 0xFF7FFFFF, CRC32: 0xE39BE9B8
PASS
```

7.4.13 prm command

Displays the information concerning the parameter file and setting file that were downloaded to the FP6.

Input format

'prm'

Description of the function

Displays the information concerning the parameter file and setting file (parameter file name, parameter file checksum, setting file checksum, and setting file name) that were downloaded to all the programming areas of the FP6.

Example of usage

Example of Communication Software Terminal Display			
>prm			
Area	File name	CRC	Type
*0	R5F571M	41F6142D	PR5
	Test1	62189515	PRJ
1	R5F571M	41F6142D	PR5
	Test2	5AC4344E	PRJ
2	78F1166	C8005840	PR5
	{invalid}		PRJ
3	{invalid}		PR5
	{invalid}		PRJ
4	{invalid}		PR5
	{invalid}		PRJ
5	{invalid}		PR5
	{invalid}		PRJ
6	{invalid}		PR5
	{invalid}		PRJ
7	{invalid}		PR5
	{invalid}		PRJ

7.4.14 progarea command

Confirms and changes information on the active programming areas and deletes data from the programming areas.

Input format

'progarea' ('clear' '0' | '1' | '2' | '3' | '4' | '5' | '6' | '7') ('0' | '1' | '2' | '3' | '4' | '5' | '6' | '7')

Description of the function

The active programming area can be changed by designating a numerical option. Also, by designating the clear option, the data in the programming area (parameter file, setting file, and program file) can be deleted. If there are no options, then the current active programming area is displayed.

- clear: Clears the data in the active programming area (parameter file, setting file, and program file).
- 0: Changes the active programming area to 0.
- 1: Changes the active programming area to 1.
- 2: Changes the active programming area to 2.
- 3: Changes the active programming area to 3.
- 4: Changes the active programming area to 4.
- 5: Changes the active programming area to 5.
- 6: Changes the active programming area to 6.
- 7: Changes the active programming area to 7.

Example of usage

Example of Communication Software Terminal Display

```
>progarea
Active Program Area: 0
Max. code area size: 16 MByte
Max. data area size: 4 MByte
Max. user boot area size: 4 Mbyte

>progarea clear 1

> progarea 0
Active Program Area: 0
```

7.4.15 res command

Resets FP6.

Input format

'res'

Description of the function

Resets and restarts the FP6 main unit.

Example of usage

Example of Communication Software Terminal Display
<pre>>res Starting FP6... Firmware Version Vx.xx.xx Board H/W Vx Serial No.:xxxxxxxxx Standard mode unsecured</pre>

7.4.16 selftest command

Executes a diagnostic test.

Input format

'selftest'

Description of the function

Executes a self-test to diagnose hardware faults.

Example of usage

Example of Communication Software Terminal Display
<pre>>selftest ***** CAUTION ***** Remove any plugs from Target- and Remote-Connector before starting. Any hardware attached to those connectors may be damaged by this test ! ***** CAUTION ***** Target- and Remote-connector unplugged ? If yes, press 's' to start the test. Otherwise, press 'n' to cancel the test: s FPGA Test: PASS Power Supply Test: PASS Target- and Remote-Interface Test: PASS Selftest PASSED.</pre>

7.4.17 serno command

Sets the unique code for embedding in the program file.

Input format

'serno' <start address> <pattern>

Description of the function

Sets the unique code for embedding in the program file. This command becomes available when the unique code function is enabled by the FP6 Security Manager setting. A target command (such as ep, prg, and vrf) is executed with the specified address replaced by unique code in the program file. The setting of the unique code is cleared on completion of the target command.

Note: When filling with 0xFF is disabled and the area of data flash memory in the program file specified in the serno command is blank, embedding of the unique code in that area does not proceed.

start address: Specifies the start address in hexadecimal.

pattern: Specifies the unique code in hexadecimal notation. A maximum of 64 bytes can be specified.

Example of usage

Example of Communication Software Terminal Display
>serno 8000 00010203 OK

7.4.18 set_auth_id command

Changes the authentication ID code to a desired value.

Input format

'set_auth_id' <type> <id>

Description of the function

When the authentication ID code is changed from the value in the settings file, this command is used to specify the type of authentication ID code for which the value is to be set as the desired ID code.

The settings for ID code which have been made with this command are maintained unless the following operations proceed (the following operations disable the set ID).

- Executing the downprm or downset command
- Changing the active programming area (executing [START] with the progarea command, the operation of the FP6 main unit, or in bank mode)
- Issuing a reset (with the res, version_up, or hwtest command)
- Turning off the power of the FP6 main unit

<type> Type of the authentication ID code
 id: Serial programming ID
 cfpw: Password for code flash memory
 dfpw: Password for data flash memory
 oid: OCD ID
 cid: Customer ID
 cidb: Customer ID B
 cidc: Customer ID C
 dfid: Data flash ID
 ctid: C-TEST ID
 sifid: RHSIF ID
 seckey: SECDBG Key
 nonseckey: NONSECDBG Key
 rmakey: RMA Key

<id> Specifies the authentication ID value.

Example of usage

Example of Communication Software Terminal Display
<pre>>set_auth_id id 00112233445566778899AABBCCDDEEFF The ID setting was changed.</pre>

7.4.19 sound command

Sets the buzzer.

Input format

'sound' ('off' | 'on' | 'all')

Description of the function

Sets the buzzer. "Enabled" or "disabled" is optionally designated. If no option is designated, the current setting is displayed.

off: Disables the buzzer.

on: Enables the buzzer. The FP6 makes a buzzer sound upon completion of the execution of the ep command.

all Enables the buzzer. The FP6 makes a buzzer sound upon completion of the execution of any FP6 target command.

Example of usage

Example of Communication Software Terminal Display
<pre>>sound Sound is off >sound off Sound is off >sound on Sound is on >sound all Sound is on (All target commands)</pre>

7.4.20 speed_mode command

Adjusts the waiting time and timeout time for use in communications with the target device.

Input format

'wait_mode' ('middle' | 'low' | 'high')

Description of the function

With devices of the V850 (except for V850E2) and 78K (except for 78K0S) family as the targets, this command adjusts the waiting time and timeout time in communications with the target device according to the following options. When no option is specified, the command is output with the currently specified mode.

middle: Normal mode (default)

Communications with the target device continue with the default timing.

low: Safe mode

A wait is inserted in communications processing to improve the stability of the connection. An unstable connection may become stable in the safe mode; however, processing times will be delayed.

high: Fast mode

This mode accelerates communications processing relative to the default value. While fast mode accelerates processing in many cases, it may cause the connection to fail. This depends on the target device and the environment.

Example of usage

Example of Communication Software Terminal Display
>speed_mode speed mode is middle.

7.4.21 srec command

Uploads the program file in Motorola S format.

Input format

'srec' (<start1><length1>(<start2><length2>(<start3><length3>(<start4><length4>))))

Description of the function

If a program file has been downloaded to an active programming area, executing this command will upload the program file in Motorola S format. If this command is executed without any options, the upload will be executed with the address size used during downloading. If a program has not been downloaded, "Invalid argument" will be displayed.

start address: The start address is designated as a hexadecimal number. (A maximum of four ranges can be specified.)

length: The number of bytes is designated as a hexadecimal number. (A maximum of four ranges can be specified.)

Example of usage

Example of Communication Software Terminal Display
<pre>>srec 10000 100 Press any key to start/continue output. S00D000053616D706C652E6D6F7412 S31500010000000102030405060708090A0B0C0D0E0F71 S31500010010101112131415161718191A1B1C1D1E1F61 : S315000100F0F0F1F2F3F4F5F6F7F8F9FAFBFCFDFF81 S70500000000FA</pre>

7.4.22 trc command

Displays the communication information between the FP6 and target device.

Input format

'trc'

Description of the function

Displays the communication information between the FP6 and target device. Up to 4096 lines can be stored.

If the communication information exceeds 4096 lines, old data is deleted.

Example of usage

Example of Communication Software Terminal Display

```
>trc
Debug Output
Number   Time us      Send  Rec.
:
0214     0008675924   17   --
0215     0008678930   --   02
:
Total number of transmitted bytes : 266282
Total number of received bytes   : 006212
```

7.4.23 upprm command

Uploads the parameter file.

Input format

'upprm'

Description of the function

If the parameter file has been downloaded to an active programming area, executing this command will upload the parameter file.

Example of usage

Example of Communication Software Terminal Display
<pre>>upprm Press any key to start/continue output. [FlashProParameterFile] : [CHECKSUM] SUM=BA9F0491 [EOF]</pre>

7.4.24 upset command

Uploads the setting file.

Input format

'upset'

Description of the function

If the setting file has been downloaded to an active programming area, executing this command will upload the setting file.

Example of usage

Example of Communication Software Terminal Display
<pre>>upset Press any key to start/continue output. [FlashproCustomerSettingFile] : [CHECKSUM] SUM=F7D4A9E7 [EOF]</pre>

7.4.25 ver command

Displays the FP6 version.

Input format

'ver'

Description of the function

Displays the FP6 version (firmware version, board hardware version, and serial number).

Example of usage

Example of Communication Software Terminal Display
<pre>>ver Firmware Version Vx.xx.xx Board H/W Vx Serial No.:xxxxxxxxxx Standard mode unsecured</pre>

7.5 Description of FP6 Device Commands

7.5.1 bln command

Executes the blank check.

Input format

'bln'

Description of the function

Executes blank checking for the flash memory of the target device.

The area specified on the [Block Settings] tabbed page is checked.

Example of usage

Example of Communication Software Terminal Display
<pre>>bln [When the area is blank] Blank check Block 000: Blank check Block 001: Blank check Block 002: Blank check Block 003: PASS Blank check operation finished. >bln [When the area is not blank] Blank check Block 000: ERROR ERROR(E051): Not Blank. Blank check operation finished.</pre>

7.5.2 clr command

Executes "Configuration clear".

Input format

'clr'

Description of the function

Executes "Configuration clear".

Remark: For details of "Configuration clear", refer to the user's manual of the MCU.

Example of usage

Example of Communication Software Terminal Display
<pre>>clr Configuration clear : PASS Configuration clear operation finished.</pre>

7.5.3 con command

Executes the processes from "transition to the flash memory programming mode" to "signature verification".

Input format

'con'

Description of the function

Executes the processes from "transition to the flash memory programming mode" to "signature verification". In order to use this command, "manual" (off) must be set with the autocon command beforehand.

7.5.4 dcon command

Executes the process to end the flash memory programming mode.

Input format

'dcon'

Description of the function

Executes the process to end the flash memory programming mode. In order to use this command, "manual" (off) must be set with the autocon command beforehand.

7.5.5 dlm command

Refers to the DLM state and causes a transition of the state.

Input format

'dlm' (<type>) ('unique' <authentication code>)

Description of the function

Refers to the DLM state of the target device and causes a transition of the state.

dlm <type>: Specifies the DLM state.
 SSD, NSECSD, DPL, LCK_DBG, LCK_BOOT, RMA_REQ, OEM_PL2, OEM_PL1, or OEM_PL0

unique Specifies this parameter when unique ID authentication is to proceed.
 <authentication>:

Example of usage

Example of Communication Software Terminal Display
<pre>>dlm Request DLM DLM state: SSD PASS DLM operation finished.</pre>
<pre>>dlm SSD Transit DLM DLM state: SSD PASS DLM operation finished.</pre>

7.5.6 ep command

Executes the [Start] command.

Input format

'ep' or 'epv'

Description of the function

Executes the [Start] command.

Example of usage

Command	Status	Status LED	Message Display	FP6 Response Message
ep	Display while executing the command	BUSY	Display contents of the ers and prg commands	See the descriptions of the ers and prg commands.
	Display after executing the command [When completed normally]	PASS	Returns to the display before executing the command.	PASS Erase, Program operation finished. or PASS EPV operation finished.
	Display after executing the command [When terminated abnormally]	ERROR	ERROR: xxx xxxxxxxxxxxxxxxx	ERROR(Exxx): <text> Erase, Program operation finished.

Example of Communication Software Terminal Display

```
>ep
Blank check Skipped.
Erase Chip:
PASS
Program Chip:
10%
20%
30%
40%
50%
60%
70%
80%
90%
100%
PASS
Erase,Program operation finished.
```

7.5.7 ers command

Executes the Erase command.

Input format

'ers'

Description of the function

Erases the target flash memory.

The range specified with the erasure option or on the [Block Settings] tabbed page is to be erased.

If this command is executed with the “Erase Chip” specified, initialization of flash options is also executed.

Example of usage

Example of Communication Software Terminal Display
<pre>>ers Blank check Skipped. Erase Chip: PASS Erase operation finished.</pre>

7.5.8 ers_chip command

Initializes an MCU of the RA family.

Input format

'ers_chip'

Description of the function

Initializes an MCU of the RA family.

Example of usage

Example of Communication Software Terminal Display
<pre>>ers_chip Erase Chip PASS Erase Chip operation finished.</pre>

7.5.10 ged command

Gets the information of endian.

Input format

'ged'

Description of the function

Gets the information of endian.

Example of usage

Example of Communication Software Terminal Display
<pre>>ged Get Endianness Little Endian PASS Get Endianness operation finished.</pre>

7.5.11 gid command

Gets the ID code.

Input format

'gid'

Description of the function

Gets the ID code.

Example of usage

Example of Communication Software Terminal Display
<pre>>gid OCD-ID : FFFFFFFFFFFFFFFFFFFFFFFF PASS OCD-ID operation finished.</pre>

7.5.12 glb command

Gets the lock bit.

Input format

'glb'

Description of the function

Gets the lock bit.

Example of usage

Example of Communication Software Terminal Display
<pre>>glb LockBits : CF1: FF CF2: FF UB: FF PASS LockBits operation finished.</pre>

7.5.13 gob command

Gets the information of option bytes.

Input format

'gob'

Description of the function

Obtains the information of option bytes.

Example of usage

Example of Communication Software Terminal Display
<pre>>gob Option Bytes : FFFFFFFF FFFFFFFF FFFFFFFF FFFFFFFF FFFFFFFF FFFFFFFF FFFFFFFF FFFFFFFF Extended Option Bytes : FFFFFFFF PASS Option Bytes operation finished.</pre>

7.5.14 gof command

Gets the information of OFS.

Input format

'gof'

Description of the function

Gets the information of OFS.

Remark: For details of OFS, refer to the user's manual of the MCU.

Example of usage

Example of Communication Software Terminal Display
<pre>>gof Get OFS OFS: FFFFFFFF FFFFFFFF PASS Get OFS operation finished.</pre>

7.5.15 gos command

Gets the information of flash option.

Input format

'gos'

Description of the function

Reads and outputs the flash option information of the target device. When the read-disable setting is effective, unreadable data are not output.

Example of usage

Example of Communication Software Terminal Display
<pre>>gos OFS: FFFFFFFF FFFFFFFF PASS Get Option Setting operation finished.</pre>

7.5.16 got command

Gets the information of OTP.

Input format

'got'

Description of the function

Gets the information of OTP.

Remark: For details of OTP, refer to the user's manual of the MCU.

Example of usage

Example of Communication Software Terminal Display
<pre>>got OTP flags : CF1: FF FFFFFFFFFFFFFFFFFFFFFFFF CF2: FF UB: FF PASS OTP operation finished.</pre>

7.5.17 gsc command

Gets the information of security.

Input format

'gsc'

Description of the function

Gets the security information set on the MCU.

Example of usage

Example of Communication Software Terminal Display
<pre>>gsc Command protection: FF PASS Security operation finished.</pre>

7.5.18 gtm command

Gets the information of Trusted Memory.

Input format

'gtm'

Description of the function

Gets the information of Trusted Memory.

Remark: For details of Trusted Memory, refer to the user's manual of the MCU.

Example of usage

Example of Communication Software Terminal Display
>gtm Trusted Memory: FF TMINF: FFFFFFFF TM address: 00120060 00120064 PASS Get Trusted Memory operation finished.

7.5.19 idc command

Executes the ID code setting.

Input format

'idc' (<ID Code>)

Description of the function

Sets the ID code and code flash and data flash passwords (the passwords are only applicable in the case of RH850/P1x-C devices) for use in on-chip debugging of the MCU. Use an sid command to set the ID code for enabling ID authentication when an RH850/C1x, RH850/D1x, RH850/E1x, RH850/F1x, or RH850/P1x device is connected in the serial programming mode. This command does not support MCUs for which the ID code items are not present on the [Flash Options] tabbed page in the [Setup] dialog box of the FP6 Terminal.

Caution: Do not issue this command if you are using HCUHEX files.

ID Code: Specifies the ID code to be set for the MCU as a hexadecimal number.

No option specified: Value of setting file downloaded is set.

Set the ID code with a size supported by the MCU. When this option is used with an RH850/P1x-C device, the size is specified as 96 bytes as the concatenation of data in the order ID code, code flash password, and data flash password. If ID code with an unavailable size is specified, an error occurs.

Example of usage

Example of Communication Software Terminal Display
>idc 000102030405060708090A0B0C0D0E0F Set ID code PASS ID code operation finished.

7.5.20 opb command

Sets the option bytes.

Input format

'opb'

Description of the function

Sets the option bytes.

Example of usage

Example of Communication Software Terminal Display
<pre>>opb Set Option Bytes PASS Option Bytes operation finished.</pre>

7.5.21 otp command

Executes the OTP setting.

Input format

'otp'

Description of the function

Executes the OTP setting.

Remark: For details of OTP, refer to the user's manual of the MCU.

Caution: Do not issue this command if you are using HCUHEX files.

Example of usage

Example of Communication Software Terminal Display
<pre>>otp Set OTP protection PASS OTP operation finished.</pre>

7.5.22 pfo command

Sets the flash options collectively.

Input format

'pfo'

Description of the function

Sets the flash options collectively.

Example of usage

Example of Communication Software Terminal Display
<pre>>pfo Set Flash Option PASS Program Flash Option operation finished.</pre>

7.5.23 prg command

Executes programming.

Input format

'prg'

Description of the function

Executes programming.

When filling with 0xFF is disabled, programming is performed to the locations where program file data exist. In this case, data is programmed with the minimum alignment unit of the MCU.

Caution: Do not issue this command if you are using HCUHEX files.

Example of usage

Example of Communication Software Terminal Display
>prg Program Chip: 10% 20% : 100% PASS Program operation finished.

7.5.24 read command

Reads data of the flash memory in the target device.

Input format

'read' ('skipblank') ('hex' | 'srec') ('all' | <start_address> <end_address>)

Description of the function

Reads data of the flash memory in the target device and outputs the data in the specified format.

If this command is executed without options, data in the range set on the [Block Settings] tabbed page is read.

Caution: Do not issue this command if you are using HCUHEX files.

No option specified: Outputs data in the hexadecimal format.

skipblank: Reads data other than that in blank areas.

hex: Reads data with the Intel HEX format.

srec: Reads data with the Motorola HEX format.

all: Reads all readable areas in the target device.

start_address: Designates the start address (in block units) with a hexadecimal number.

end_address: Designates the end address (in block units) with a hexadecimal number.

Example of usage**Example of Communication Software Terminal Display**

```
>read FE000000 FE0000FF
Read FE000000 to FE0000FF:
Press any key to start/continue output.
FE000000: FB F9 F1 F9 F1 31 37 B1 E9 FF F9 FF 20 74 F5 F5
FE000010: F9 F9 FB ED FF B5 F7 F7 69 B9 FB F9 71 A9 36 75
:
FE0000F0: 3D FF BF 9F 7D 7F 6F 7D 77 1F DF FF FF FF FF FF
PASS
Read operation finished.
```

7.5.25 rsc command

Executes the Security Release command.

Input format

'rsc'

Description of the function

Executes the Security Release command.

Remark: For details of the Security Release command, refer to the user's manual of the MCU.

Example of usage

Example of Communication Software Terminal Display
>rsc Release security PASS Release security operation finished.

7.5.26 scf command

Sets security information.

Input format

'scf'

Description of the function

Sets security information to the MCU.

Caution: Do not issue this command if you are using HCUHEX files.

Example of usage

Example of Communication Software Terminal Display
>scf Set security Flags PASS Security operation finished.

7.5.27 sed command

Executes the endian setting.

Input format

'sed'

Description of the function

Executes the endian setting.

Example of usage

Example of Communication Software Terminal Display
<pre>>sed Set Endianness PASS Set Endianness operation finished.</pre>

7.5.28 sid command

Sets the ID code and enables ID authentication in the serial programming mode.

Input format

'sid' (<ID Code>)

Description of the function

Sets the ID code and enables ID authentication in the serial programming mode.

ID Code: Specifies the ID code to be set for the MCU as a hexadecimal number.

No option specified: Value of setting file downloaded is set.

Set the ID code with a size supported by the MCU.

If ID code with an unavailable size is specified, an error occurs.

Example of usage

Example of Communication Software Terminal Display
<pre>>sid 0123456789ABCDEF Set Serial Programming ID PASS Set Progr. ID operation finished.</pre>

7.5.29 sig command

Executes the [Read Signature] command.

Input format

'sig'

Description of the function

Executes the [Read Signature] command.

Example of usage

Example of Communication Software Terminal Display
<pre>>sig [Signature] Device name: R7FA8D1BHECFC Device code: 03 Boot FW version: 3.6.32 Code Flash 1: 02000000 - 021F7FFF Code Flash 2: 12000000 - 121F7FFF Data Flash 1: 27000000 - 27002FFF Data Flash 2: 37000000 - 37002FFF Config Setting 1: 0300A100 - 0300A17F Config Setting 2: 0300A200 - 0300A2FF Config Setting 3: 1300A180 - 1300A1FF Config Setting 4: 27030050 - 2703035F MCU Unique ID: 4E4B2E3F1D114E36305034352D046395 DLM state: OEM_PL2 Authentication Level: AL2 AL2 Key: No AL1 Key: No RMA Key: No PASS Signature operation finished.</pre>
<pre>>sig Device name: R7F100GMJ Device data: 10 00 0A Boot FW version: 1.02 Code Flash 1: 00000000 - 0003FFFF Data Flash 1: 000F1000 - 000F2FFF PASS Signature operation finished.</pre>

```
>sig
Device name:      RX65N Group
Device code:      30 00 00 00 00 00 00 00
Code Flash:       FFE00000 - FFFFFFFF
Data Flash:       00100000 - 00107FFF
Config Area:      FE7F5D00 - FE7F5D7F
PASS
Signature operation finished.
```

7.5.30 slb command

Sets the Lock bit information.

Input format

'slb'

Description of the function

Sets the Lock bits on the MCU.

Example of usage

Example of Communication Software Terminal Display

```
>slb
Set LockBits
PASS
LockBits operation finished.
```

7.5.31 spd command

Disables the serial programming.

Input format

'spd'

Description of the function

Disables the serial programming for the MCU.

Example of usage

Example of Communication Software Terminal Display
>spd Set Serial Programming Disable PASS Set SerProgDis operation finished.

7.5.32 stm command

Sets the Trusted Memory.

Input format

'stm'

Description of the function

Enables the Trusted Memory setting.

Remark: For details of the Trusted Memory, refer to the user's manual of the MCU.

Example of usage

Example of Communication Software Terminal Display
>stm Set Trusted Memory PASS Set Trusted Memory operation finished.

7.5.33 sum command

Executes the Checksum command.

Input format

'sum'

Description of the function

Executes the Checksum command and gets checksum values in the MCU.

Example of usage

Example of Communication Software Terminal Display
>sum Checksum: 0x1234 PASS Checksum operation finished.

7.5.34 vrf command

Executes the Verify command.

Input format

'vrf'

Description of the function

Executes the Verify command.

Example of usage

Example of Communication Software Terminal Display
>vrf Verify Chip: 10% 20% : 100% PASS Verify operation finished.

8. Encryption Utility Program

rpe.exe, which is bundled with this product, can be used to encrypt or decrypt program files.

- Remarks:
1. rpe.exe is stored in the same location as that for FP6.exe in the folder where the FP6 Terminal has been installed.
 2. The Advanced Encryption Standard (AES) with a 128-bit block length is used for encryption.

Caution: In this utility program, encryption is not for protecting communications between the tool and the target device but for protecting program files.

8.1 Exit Code

When the operation was successful, exit code 0 is returned.

Otherwise, 1 is returned.

8.2 Command-line Syntax

The command-line syntax is as follows:

RPE <file> /password <password> [options...]

8.3 Start Options

The following lists start options for the PG-FP6.

Table 8.1 Start Options

Option	Description
file	Specifies the file to be input (this specification is mandatory). <ul style="list-style-type: none"> • The file can be specified as a relative path from the working directory. • Files to be encrypted: Intel Hex, S-Record, HCUHEX, and RPI • Files to be decrypted: RPE
password	Specifies the password for use in encrypting or decrypting the file (this specification is mandatory). If the password includes symbols, enclose each in double-quotation marks (").
decrypt	Decrypts an encrypted file (RPE). If this option is not specified, the file is encrypted.
output	Specifies the destination for output of a file. If this option is not specified, the directory holding the input files is used. <ul style="list-style-type: none"> • The file can be specified as a relative path from the working directory.
nooverwrite	Prohibits overwriting of output files.
?	Displays help information on the options.

Caution: Pathnames that include spaces must be enclosed in double-quotation marks (").

Remark: Enter a password made up of alphanumeric characters and symbols (up to 64 characters). The usable symbols are as follows.

a-z, A-Z, 0-9, !, @, #, \$, ^, &, *, (,), _, -, +, =, [,], {, }, ;, :, <, >, |, ., /, ?

Example:

- > rpe "out.hex" /password "0123456789"
- > rpe "out.hex" /password "0123456789" /output "out.rpe"
- > rpe "out.rpe" /decrypt /password "0123456789" /output "D:\outputdir"

9.Renesas Flash Programmer Utility Program

The Renesas Flash Programmer utility program, rfp-util.exe, which had been bundled with this product from FP6 Terminal V1.07, has been discontinued. Use the [Security Key Management Tool](#) as the successor software.

10.Connectors and Cables

10.1 Power-Supply Connector

The power-supply connector is laid out on the host interface side of the FP6.

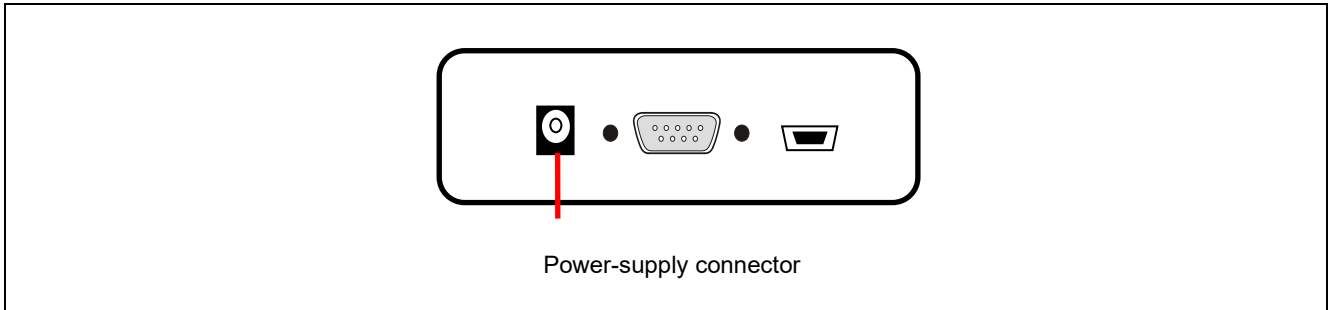

Figure 10.1 Power-Supply Connector

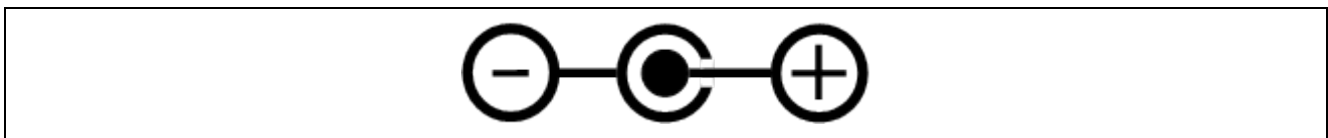

Figure 10.2 Pin Assignments of the Power-Supply Connector

Note: Do not connect a power adapter other than the one for the PG-FP6 to the power-supply connector.

The following is the specification of the power-supply adapter.

- Output: 5 V/2 A
- Connector model No.: HEC0470-01-0630

10.2 Serial Connector

The serial connector (9-pin D-sub male connector) is laid out on the host interface side of the FP6.

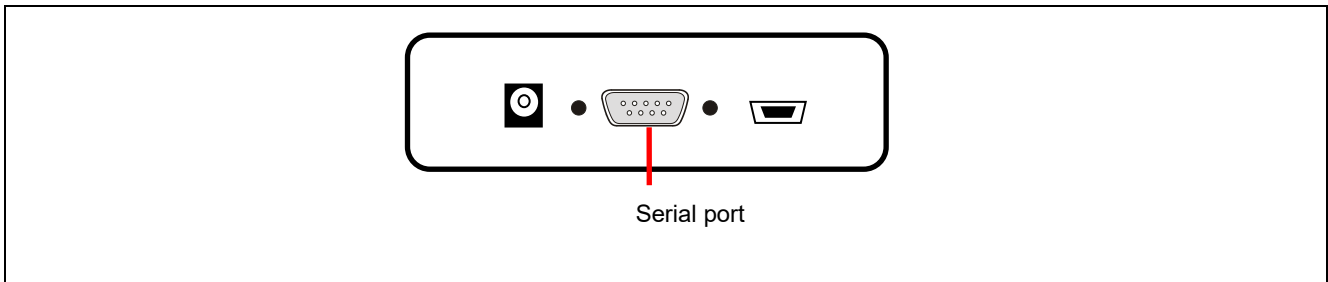

Figure 10.3 9-Pin D-Sub Serial Connector

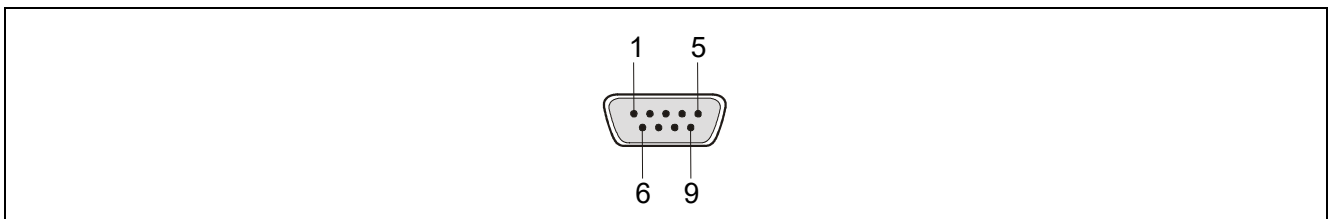

Figure 10.4 Pin Assignments of the Serial Connector

Table 10.1 Pin Configuration of the 9-Pin D-Sub Serial Connector

Serial Connector	Signal Name
1	NC
2	RxD
3	TxD
4	NC
5	VSS
6	NC
7	RTS
8	CTS
9	NC

Note: Part number of the serial connector (9-pin D-sub male connector): DELC-J9PAF-20L9E (manufactured by Japan Aviation Electronics Industry, Limited)

10.2.1 Serial cable connected to the 9-pin D-sub serial connector

A serial cross cable is additionally required. The connectors on both sides are 9-pin D-sub female connectors. The following shows the connection.

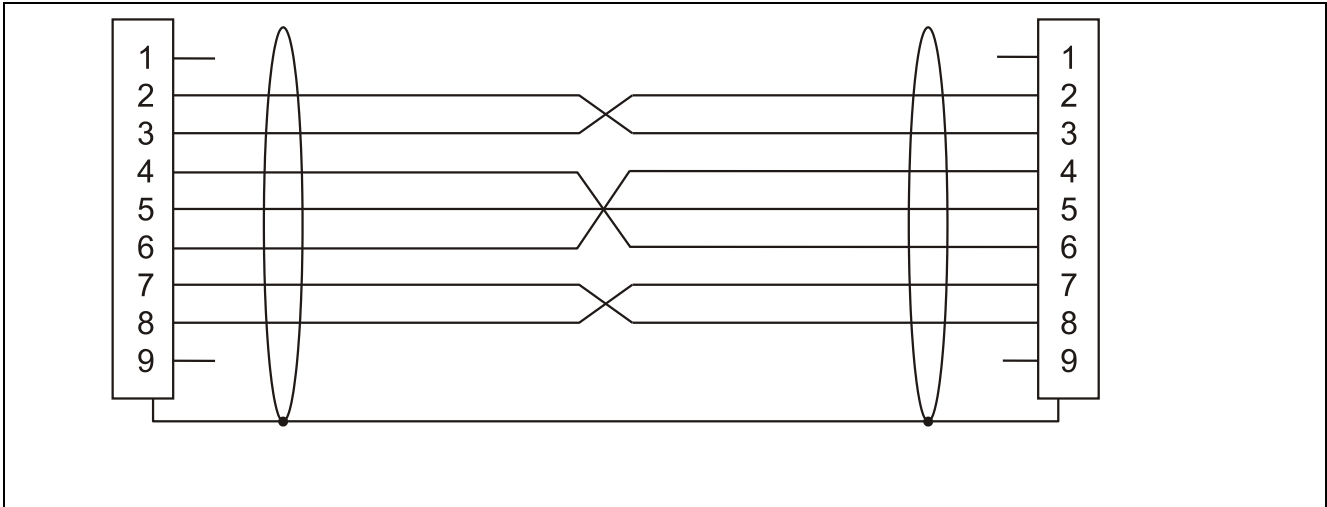

Figure 10.5 Connection of the Serial Cable

10.3 USB Connector

The mini-B type USB connector is laid out on the host interface side of the FP6.

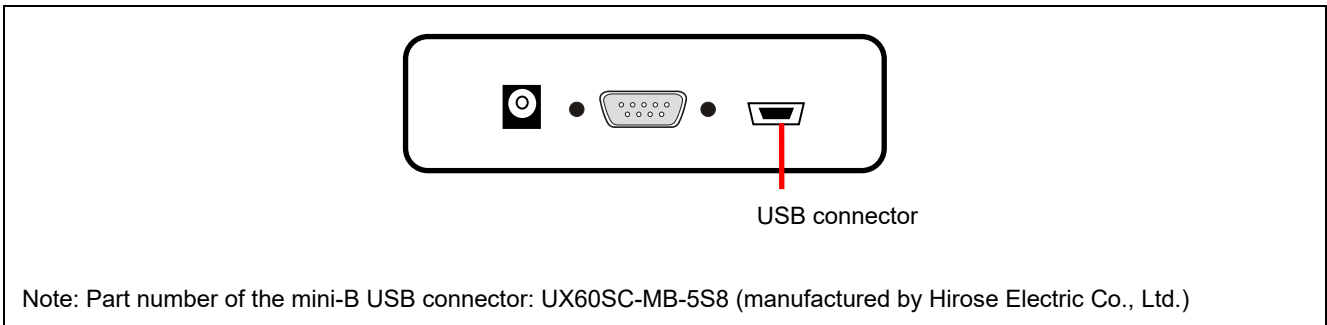

Figure 10.6 USB Connector (Host Interface Side of the FP6)

10.3.1 USB cable

The USB cable is approximately two meters long. The cable is equipped with a USB mini-B type connector and USB A type connector.

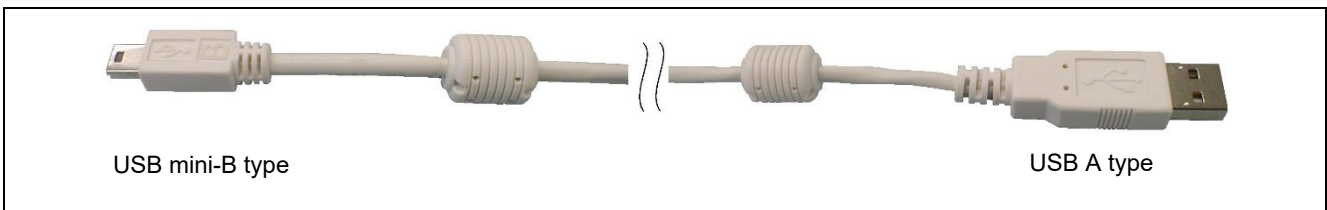

Figure 10.7 Appearance of the USB Cable

10.4 Target Connector

The target connector is laid out on the right side of the FP6.

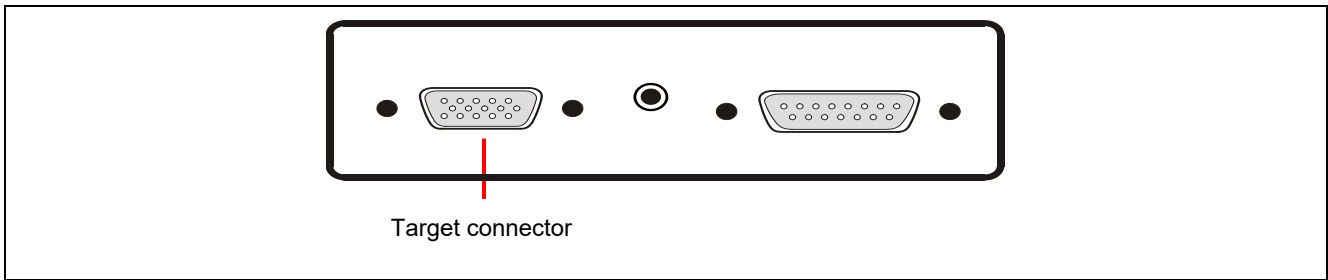

Figure 10.8 Target Connector (Target Connector Side of the FP6)

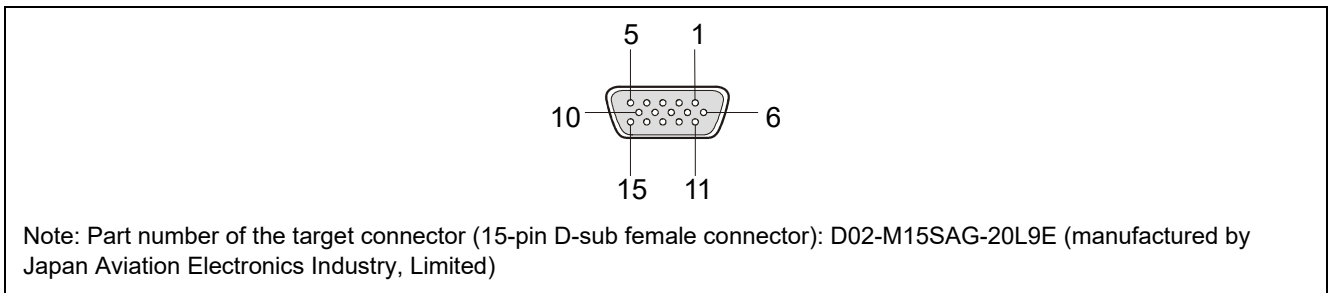

Figure 10.9 Pin Assignments of the Target Connector (15-Pin D-Sub Female Connector)

Table 10.2 Pin Configuration of the Target Connector

FP6 D-Sub 15	FP6 Signal Name
1	SO/TxD1/IO3
2	SI/RxD
3	SCK/IO4
4	RESET
5	NC*
6	FLMD1
7	TxD2/HS
8	VCC
9	VCC
10	IO1
11	NC*
12	FLMD0/IO0
13	IO2
14	CLK/IO5
15	GND

Note: Reserved pin. Leave this pin open.

Note: For the connection with the target device, refer to chapter 11, Examples of Connections with .

10.4.1 Target cable (14-pin type)

The target cable (14-pin type) is a standard shielded cable and is approximately 42 centimeters long. The target cable is equipped with a 15-pin D-sub male connector and a 14-pin 2.54-mm pitch multipurpose female connector.

Note: The following are the recommended connectors to be connected to the 14-pin 2.54-mm pitch multipurpose female connectors.

- 7614-6002 (straight angle type manufactured by 3M Japan Limited)
- 2514-6002 (straight angle type manufactured by 3M Limited)

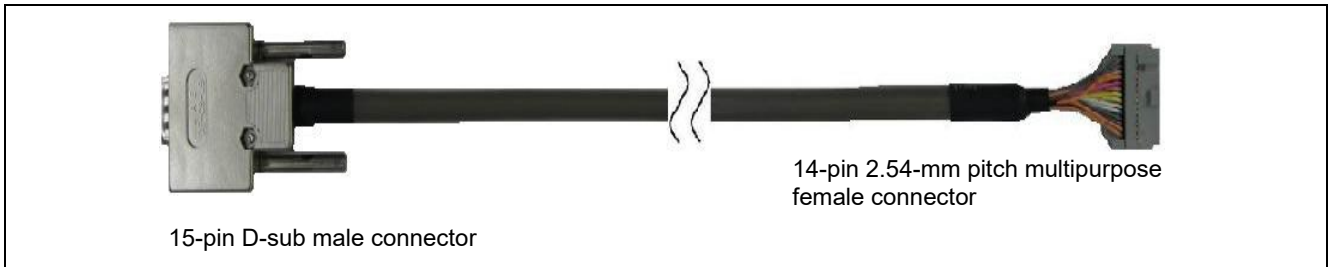

Figure 10.10 Appearance of the Target Cable (14-Pin Type)

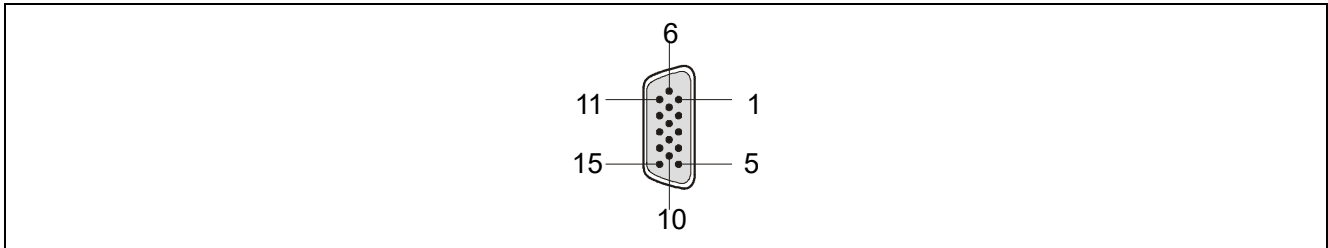

Figure 10.11 Pin Assignments of the 15-Pin D-Sub Male Connector of the Target Cable (14-Pin Type)

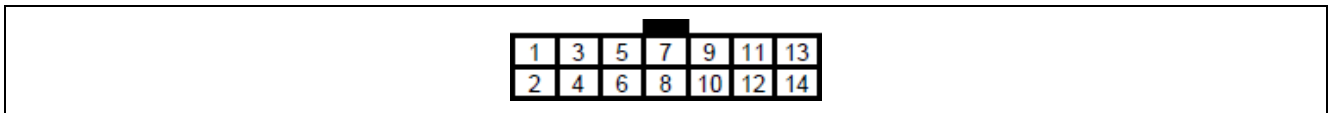

Figure 10.12 Appearance of the 14-Pin 2.54-mm Pitch Multipurpose Female Connector of the Target Cable (14-Pin Type) (View from the Socket Side)

Table 10.3 Pin Configuration of the Target Connector (14-Pin Type)

Signal Name (PG-FP6)	15-Pin D-Sub Male Connector	14-Pin 2.54-mm Pitch Multipurpose Female Connector
SCK/IO4	3	1
GND	15	2
CLK/IO5	14	3
FLMD0/IO0	12	4
SI/RxD	2	5
IO1	10	6
SO/TxD1/IO3	1	7
VCC	8	8
FLMD1	6	9
IO2	13	10
TxD2/HS	7	11
GND	15	12
RESET	4	13
Not used *	—	14

Note: Reserved pin. Leave this pin open.

Left open in the target cable. If you use the same 14-pin connector for debugging, please also refer to the user's manual of the emulator.

10.4.2 14-pin to 16-pin conversion adapter for the E1 emulator

When the 16-pin connector is used on the target system, use the 14-pin to 16-pin conversion adapter for the E1 emulator.

Caution: This conversion adapter is only usable with 78K and V850 target devices.

Remark: For the product information, refer to section 1.4, Optional Products.

10.4.3 20-pin conversion adapter for the PG-FP6

When the CoreSight 20-pin connector is used on the target system, use the 20-pin conversion adapter for the PG-FP6. When the 10-pin connector is used on the target system, use the 20-pin to 10-pin conversion cable to match it.

Remark: For the product information, refer to section 1.4, Optional Products.

Table 10.4 Pin Configuration of the Target Connector (20-Pin Type)

Signal Name (PG-FP6)	15-Pin D-Sub Male Connector	CoreSight 20-pin Female Connector	CoreSight 10-pin Female Connector
Vcc	8,9	1	1
FLMD1	6	2	2
GND	15	3	3
SCK/IO4	3	4	4
GND	15	5	5
SI/RxD	2	6	6
Not used *1	—	7	7
TxD2/HS	7	8	8
Not used	—	9	9
RESET	4	10	10
Not used *1	—	11	—
SO/TxD1/IO3	1	12	—
Not used *1	—	13	—
IO1	10	14	—
GND	15	15	—
CLK/IO5	14	16	—
GND	15	17	—
FLMD0/IO0	12	18	—
GND	15	19	—
IO2	13	20	—

Note: Reserved pin. Leave this pin open.

10.5 GND Connector

The banana-jack GND connector is laid out on the target connector side of the FP6.

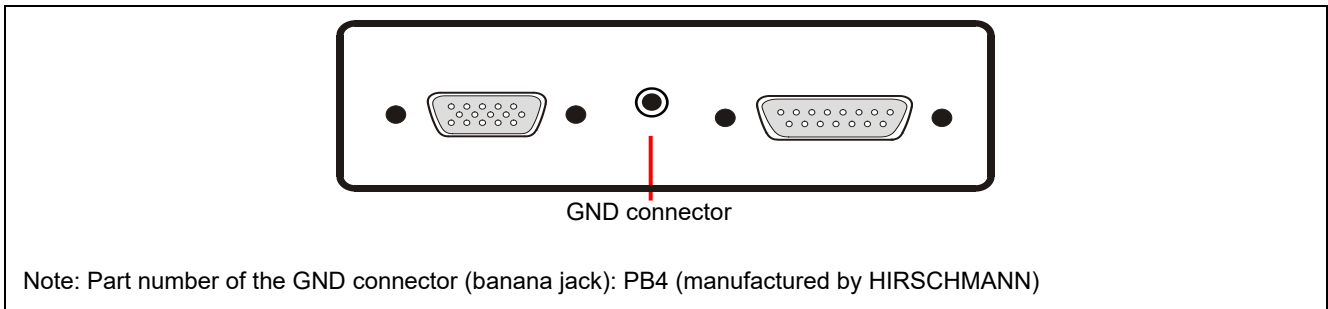

Figure 10.13 GND Connector (Target Connector Side of the FP6)

10.5.1 GND cable

The GND cable is approximately one meter long. The cable is equipped with a banana jack and a spade terminal.

Note: The FP6 and target system may be damaged if there are differences in potential between the grounds of the FP6 and of the target system. Use the GND cable to eliminate differences in potential before connecting the target cable.

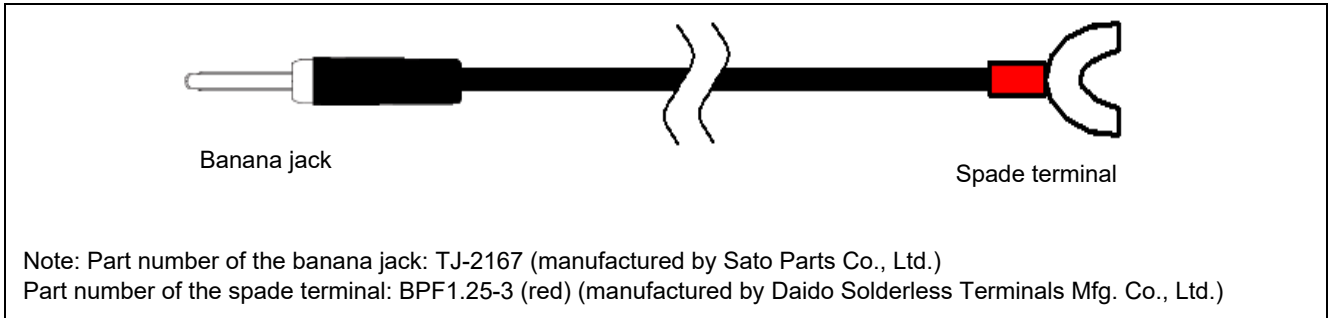

Figure 10.14 Appearance of the GND Cable

10.6 Remote Connector

The remote connector (a 15-pin D-sub female connector) is laid out on the target connector side of the FP6.

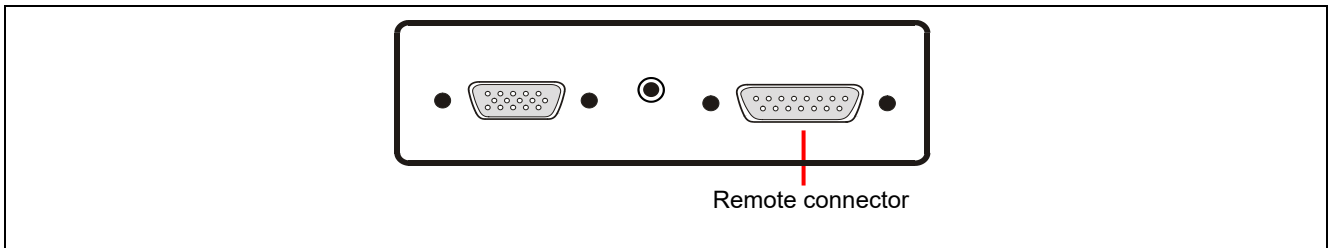

Figure 10.15 Remote Connector (Target Connector Side of the FP6)

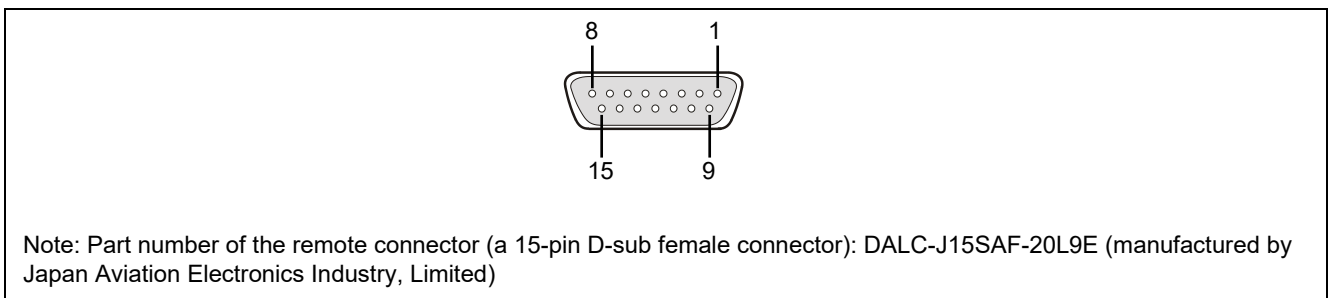

Figure 10.16 Pin Assignments of the Remote Connector (15-Pin D-Sub Female Connector)

The remote connector pins of the FP6 have the following functions. Table 10.5 shows the pin numbers on the remote connector of the FP6. Each input pin is pulled-up inside the FP6.

Table 10.5 Pin Functions of the Remote Interface

Pin Number	Input/Output	Pin Name		Function	Active Level
1	Output	CONN		Indicates that the remote interface is connected. When the power of the FP6 is ON, the CONN is always valid.	High level
2	Output	BUSY		Outputs the status indicated by the status LED "BUSY".	High level
3	Output	PASS		Outputs the status indicated by the status LED "PASS".	High level
4	Output	ERROR		Outputs the status indicated by the status LED "ERROR".	High level
5	Input	Modes other than bank mode	CANCEL	Same as the function of the CANCEL button.	Low level
	Input	Bank mode	BANK0	Indicates the lowest 1 bit of the 3-bit programming area number.	Low level
6	Input	Standard mode	ENTER	Same as the function of the ENTER button.	Low level
	Input	Bank mode	BANK1	Indicates the middle 1 bit of the 3-bit programming area number.	Low level
7	Input	Standard mode	NEXT	Same as the function of the NEXT button.	Low level
	Input	Bank mode	BANK2	Indicates the highest 1 bit of the 3-bit programming area number.	Low level
8	Input	VRF		Executes verification.	Low level
9	Input	START		Inputs the "START" (Start command) signal.	Low level
10	Input	CLR		Clears the "PASS" and "ERROR" signals.	Low level
11 to 15	—	GND		GND pins	—

Note: Each input pin is pulled-up inside the FP6.

Table 10.6 Programming Areas and Banks

	BANK2	BANK1	BANK0
Programming area 0	0	0	0
Programming area 1	0	0	1
Programming area 2	0	1	0
Programming area 3	0	1	1
Programming area 4	1	0	0
Programming area 5	1	0	1
Programming area 6	1	1	0
Programming area 7	1	1	1

Remark: 0: Low level

1: High level

Note: Set BANK0, BANK1, and BANK2 to the low level in programming area 0. Set BANK0 and BANK1 to the high level and BANK2 to the low level in programming area 3.

11.Examples of Connections with the Target Device

For examples of recommended connections between the PG-FP6 and the target devices, refer to the [PG-FP6, Renesas Flash Programmer Additional Document for User's Manual \(Recommended Circuits for Connecting the Flash Programmer\)](#).

12. Troubleshooting

This chapter covers frequently asked questions (FAQ).

12.1 FAQ

For frequently asked questions, refer to the following support portal (FAQ):

<https://www.renesas.com/pg-fp6/faq-en>

* Using the self-testing function, the user can find out the reason why the FP6 does not operate normally, such as a defect in the FP6, or problems in other hardware. For how to use the tool, refer to 4.4.2.5, [Self Test].

12.2 Problems during Operation

This section describes troubleshooting for problems that may occur during operation.

12.2.1 When an error produces the message 'ERROR: 004 No response'

Cause 1:

The connection with the target system might be wrong.

Action 1:

Confirm that the connection with the target system is correct by referring to the PG-FP6, Renesas Flash Programmer Additional Document for User's Manual (Recommended Circuits for Connecting the Flash Programmer).

Cause 2:

The operating mode of the target device might be wrong.

Action 2:

The FP6 is connected to the target device in boot mode or serial programming mode.

- (1) Refer to the user's manual of the target device and check that all required mode pins are being handled correctly.
- (2) For the RX family, check that the settings for I/O signals in the [Tool Details] dialog box match the wiring of the target system.

Cause 3:

The wrong MCU might be selected in the [Create New Setting] dialog box.

The wrong target device might be selected for the settings file.

Action 3:

Select the same MCU as the target device.

Cause 4:

The target device might not be receiving a clock signal.

Action 4:

Check the clock supply on the target system.

Cause 5:

Power might not be being supplied normally to the target device.

Action 5:

(1) Check the power supply setting.

(2) If the power is being supplied from the FP6, the power might not be sufficient. In such cases, supply power from the target system. Confirm that the supply of power on the target system is possible.

Cause 6:

The [security](#) functions of the target device may restrict the connection to the PG-FP6.

Action 6:

None. Change the target device if this is required.

12.2.2 When an error produces the message '023 Inv. Sig. addr.'**Cause 1:**

An attempt was made to connect a target device which differs from that when the settings file was created.

Action 1:

Create a new settings file or use the correct settings file with the target device.

Cause 2:

The memory structure might have been changed by the option settings of the target device.

Action 2:

When the MCU has a function that for changing the mapping of the flash memory, such as a dual-bank structure, the FP6 recognizes the MCU as a different one before and after changes to the memory mapping. Accordingly, after a change to the memory mapping in the MCU, the error "023 Inv. Sig. addr." will occur. In the FP6, create and change settings files for use before and after changes to the memory mapping.

12.2.3 When an error produces the message 'Communication failure or timeout'**Cause 1:**

The connection to the target system may be wrong.

Action 1:

Confirm that the connection with the target system is correct by referring to the PG-FP6, Renesas Flash Programmer Additional Document for User's Manual (Recommended Circuits for Connecting the Flash Programmer).

Cause 2:

Settings of the target system and FP6 may not match.

Action 2:

- (1) Baud rate: Check the operating frequency of the target device to see if the baud rate exceeds the allowable communications rate and if the baud rate is appropriate.
- (2) Clock settings: Check if the clock settings for the target device in the FP6 match the actual clock of the target system.

Cause 3:

The target device might have been reset during communications.

Action 3:

- (1) Power supply of the target device: An internal reset might occur in the target device due to voltage fluctuations during communications with the FP6. Check that the power supply is free of problems.
- (2) External reset: A reset might have been applied to the target device by an external reset circuit during communications with the FP6. Check that the reset circuit is free of problems.

Cause 4:

Communications between the FP6 and target device might not be stable.

Action 4:

Check that there is no noise on the communications line.

Remark: Good communications may not be possible if you are using a self-made cable, a self-made extension cable, or the like for connection with a tool.

13. Points for Caution

This chapter gives some notes on rewriting the memory in the target device.

13.1 Checking before Connection

- Applies to: All MCUs

Connection of the target device in the cases listed below may damage the tool in use or the target system due to conflicts between signals. Be sure to check that the settings and circuit connection are correct.

- The type of the target device to be connected was mistaken.
- The wrong recommended circuit was used for the target device.
- The output setting of mode setting pins was wrong while the setting is for manual entry to boot mode.
- The power-supply setting was wrong.

13.2 Manipulating the User Boot Mat

- Applies to: RX610 series

If a valid ID code has not been set before the MCU is connected (i.e. the device is not protected), manipulation of the user boot mat is not possible on completion of the connection. To enable manipulation of the user boot mat, set a valid ID code before connecting the MCU.

- Applies to: SH family

- Reading of data file in user boot mat areas is not supported.
- Uploading of data in user boot mat areas is not supported.
- Getting a checksum of the program file in user boot mat areas is not supported.
- If you are using program files other than a DDI-format file, do not select blocks in both code flash and user boot flash areas at the same time on the [Block Settings] tabbed page of the [Setup] dialog box.

13.3 Erasing a Chip

- Applies to: RH850 family

When a chip is erased, the configuration data are cleared after all other data have been erased. In other words, the option settings of the MCU are all erased. Since all settings, including the settings at the time of shipment, are erased, be sure to make the required settings at the same time.

In addition, processing to clear the configuration data is prohibited in some MCUs. When you wish to erase a chip, refer to the user's manual of the target device in use and determine whether the processing is available.

13.4 Auto-Padding with 0xFF

- Applies to: All MCUs

When an amount of data is less than the minimum unit for programming a flash memory, the data are always padded with 0xFF before programming.

- Applies to: RX

When programming the configuration setting area, parts with no data will be padded with 0xFF.

13.5 Wide Voltage Mode

- Applies to: 78K0R family

If you wish to enable wide voltage mode, select the [Wide Voltage] check box on the [Connect Setting] tabbed page of the [Setup] dialog box. Since the FP6 ignores any wide voltage setting in a HCUHEX file, this is the case regardless of whether you are using an HCUHEX file.

13.6 Switching to Dual Mode

- Applies to: All MCUs with flash memory in a dual-bank structure

When you create a new setting file for the FP6 Terminal, select a target device name that matches the bank mode selected by the Bank Mode Select bits in the option-setting memory.

The following error messages will appear when the FP6 is connected to an MCU with a different bank mode.

Message displayed on the FP6: ERROR:023 Inv. Sig. addr.

FP6 Terminal: ERROR (E023): Invalid signature code.

Remark: This point for caution applies to all MCUs in cases where the configuration of flash memory is changed after programming. The way this is indicated, such as “dual mode”, “linear mode”, or “Bank Mode Select bits” will differ with the MCU family in use. For details, refer to the user’s manual of the MCU you are using.

The bank mode for the MCU is changed by the following actions.

- Resetting the MCU after a setting for bank mode which differs from the current setting has been written to the Bank Mode Select bits
- Resetting the MCU after selecting [Erase Chip] to erase a chip that is currently in dual mode

The following describes the steps in switching a chip from the linear mode to the dual mode.

(1) Programming an application at the same time as switching to dual mode

- Applies to: RA and RX families
 - Condition: Do not program area 2 in Figure 13.1.
1. Create a new ESF file for an MCU in the linear mode.
 2. Program the program file for the option-setting memory that specifies the dual mode and the program file (application) for area 1 in Figure 13.1.
 3. Reset the MCU.

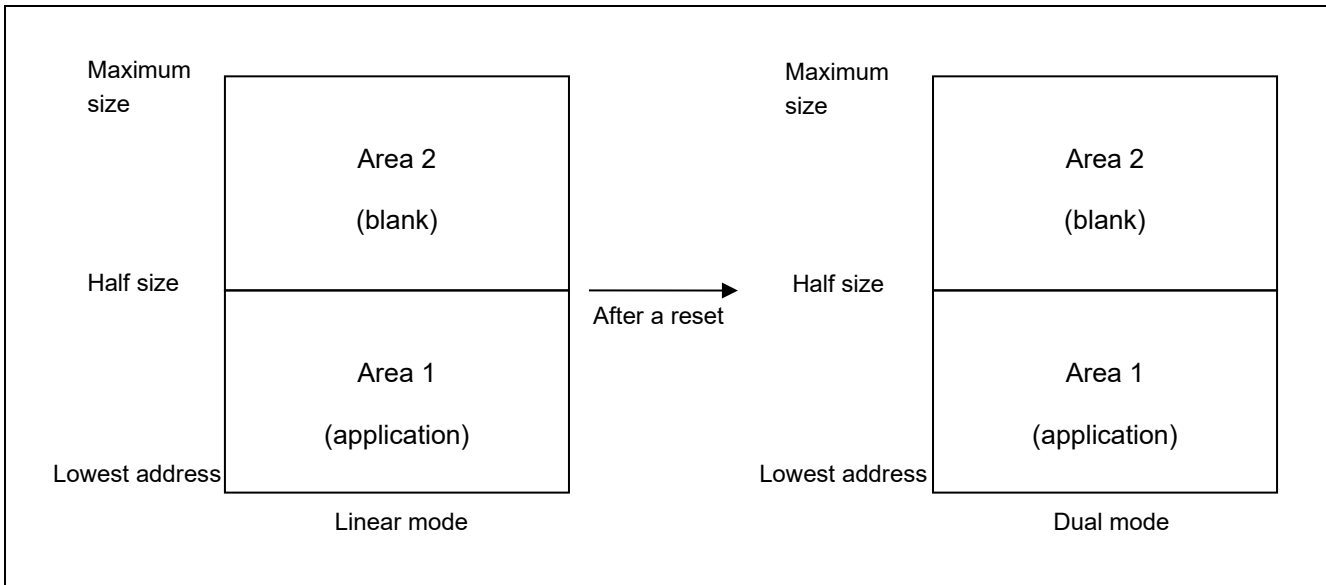

Figure 13.1 Programming an Application for Use in Dual Mode in Linear Mode

Remark: When switching from linear mode to dual mode is to proceed, it is recommended that area 2 in Figure 13.1 be blank.

(2) Only switching to dual mode

- Applies to: RH850, RA, and RX families
 1. Create a new ESF file for an MCU in the linear mode.
 2. Program the option-setting memory with a file that specifies the dual mode.
 3. Reset the MCU.
 4. Since the connection of the MCU in the ESF file for the linear mode is not possible after this step, create a new ESF file for the dual mode.

13.7 Switching to Double Map Mode

This method is the same as that for switching to dual mode.

For details, refer to section 13.6, Switching to Dual Mode.

13.8 RPI Files

- Applies to: RL78 family, RX100 series*¹, and RX200 series*¹
 When you are using an RPI file, the following settings will be effective even if the RPI file includes no settings regarding command protection*² or a flash-access window.

- Command Protection*²
 - Disable Block Erase: No
 - Disable Program: No
 - Disable Boot Block Cluster Programming: No
- Flash Access Window
 - Beginning: Block 0 in the code flash memory of the target MCU
 - End: The last block in the code flash memory of the target MCU

Notes: 1. Only those MCUs that support flash-access window
 2. For the RL78 family only

13.9 Verification after Protecting the MCU

- Applies to: RH850, RX72T, RX71x, RX66x, RX64x
Setting the following protection functions of the MCU restricts the verification function.
 - ID code protection
Proceeding with verification (“Verify by reading the device”) without issuing a reset after the ID code protection bit has been set (written) will cause a protection error. To avoid this type of error, be sure to reset the MCU after setting (writing to) the ID code protection bit. The FP6 enters the ID authentication mode and verification is enabled.
 - Read command protect (Reading prohibited)
After the read command protection bit has been set, the ID code written to the MCU cannot be verified. However, the setting of the read command protection bit becomes effective immediately after a new setting has been written.

13.10 Writing to the Code Flash Memory of an RL78/F2x for Secure Boot

- Applies to: RL78/F2x
Before writing to the code flash memory of an RL78/F2x for secure boot by the FP6 with specification of the key and MAC passwords, generate an RPI file for which a password has been set by using rfp-cli.

Remark: rfp-cli is a command line function included in the RFP package. For details, refer to <https://www.renesas.com/rfp>.

13.11 SWD Interface Connection

Applies to: RA

For the SWD interface connection, handle the pins on the user system so that the startup mode of the MCU is single-chip mode. In single-chip mode, the MD pin is at the high level. The PG-FP6 does not operate normally in SCI boot mode.

For the MCUs supported by the SWD interface, refer to [List of MCUs Supported by PG-FP6](#).

Applies to: RA4E1, RA4M2, RA4M3, RA6E1, RA6M4, RA6M5, RA6T2

The following functions cannot be used with an SWD interface connection. Use these functions through UART communications.

- Programming, verifying, or reading flash options
- Writing or verifying user keys
- Checksums
- Settings or acquisition in relation to TrustZone
- Initializing devices
- Connecting the PG-FP6 while the target device is in non-secure state

13.12 Security Memory Protection Unit (MPU)

Applies to: RA

After the security MPU has been enabled, the FP6 will not operate correctly on the target device.

13.13 Procedure for Erasing Data Flash Memory in an RL78/F2x Device

Applies to: RL78/F2x

When data flash memory in an RL78/F2x device is to be erased, set bit 0 in the security option byte to 0. If this procedure was not observed and data flash memory was erased, an error may occur during erasure.

- Procedure
 1. Write a program file in which bit 0 in the security option byte (000C4H/040C4H) is set to 0.
 2. Reset the MCU.
 3. Erase data flash memory.

13.14 Erase Command

Applies to: RA, RH850, RX, Renesas Synergy™

Areas that do not support erasure, such as MRAM areas and Config Area will not to be erased even if “Erase” is selected for “Command” on the [Operation Settings] tabbed page. Note that erasure is skipped for these areas. Check the log to see the areas which were actually erased.

14. Maintenance and Warranty

This chapter covers basic maintenance, warranty information, provisions for repair and the procedures for requesting a repair.

14.1 Maintenance

- (1) If dust or dirt collects on this product, wipe it off with a dry soft cloth. Do not use thinner or other solvents because these chemicals can cause the surface coating to separate.
- (2) When you do not use this product for a long period, disconnect it from the power supply, host PC and user system.

14.2 Warranty

- (1) This product comes with a one-year warranty after purchase.
Should the product break down or be damaged while you're using it under normal condition based on its user's manual, it will be repaired or replaced free of cost.
- (2) However, if the following failure or damage occurs to the product under warranty, the product will be repaired or
 - a) Failure or damage attributable to the misuse or abuse of the product or its use under other abnormal conditions.
 - b) Failure or damage attributable to improper handling of the product after purchase, such as dropping of the product when it is transported or moved.
 - c) Failure or damage to the product caused by other pieces of equipment connected to it.
 - d) Failure or damage attributable to fire, earthquakes, thunderbolts, floods, or other natural disasters or abnormal voltages, etc.
 - e) Failure or damage attributable to modifications, repairs, adjustments, or other acts made to the product by other than Renesas Electronics Corporation.
- (3) Consumables (e.g., sockets and adapters) are not covered by the aforementioned repair.

In the above cases, contact your local distributor. If your product is being leased, consult the leasing company or the owner.

14.3 Repair Provisions

- (1) Repairs not covered by warranty
Problems arising in products for which more than one year has elapsed since purchase are not covered by warranty.
- (2) Replacement not covered by warranty
If your product's fault falls into any of the following categories, the fault will be corrected by replacing the entire product instead of repairing it, or you will be advised to purchase a new product, depending on the severity of the fault.
 - Faulty or broken mechanical portions
 - Flaws, separation, or rust in coated or plated portions
 - Flaws or cracks in plastic portions
 - Faults or breakage caused by improper use or unauthorized repair or modification
 - Heavily damaged electric circuits due to overvoltage, overcurrent or shorting of power supply
 - Cracks in the printed circuit board or burnt-down patterns
 - A wide range of faults that make replacement less expensive than repair
 - Faults that are not locatable or identifiable

(3) Expiration of the repair period

When a period of one year has elapsed after production of a given model ceased, repairing products of that model may become impossible.

(4) Carriage fees for sending your product to be repaired

Carriage fees for sending your product to us for repair are at your own expense.

14.4 How to Make Request for Repair

If your product is found faulty, fill in the Repair Request Sheet downloadable from the following URL. And email the sheet and send the product to your local distributor. To ensure rapid repair, fill in the sheet as specific as possible.

<https://www.renesas.com/repair>

CAUTION

Note on Transporting the Product:



When sending your product for repair, use the packing box and cushioning material supplied with the product when it was delivered to you and specify caution in handling (handling as precision equipment). If packing of your product is not complete, it may be damaged during transportation. When you pack your product in a bag, make sure to use the conductive plastic bag supplied with the product (usually a blue bag). If you use a different bag, it may lead to further trouble with your product due to static electricity.

Appendix A. Messages

This chapter explains the messages.

A.1 Messages Defined in the FP6 Terminal

No.	Message	Description
E0000001	Operation with a file failed.	The file name exceeds the available number of characters or includes characters that are not usable in the OS, or the permission settings for the specified file or folder may not allow the operation. Change the file name or the location.
E0000002 E3000002	A file was not found.	This error code and message are displayed when the specified file was not found. Specify a new file that actually exists.
E0000301	This file cannot be read.	A corrupted file or a non-supported file may have been selected. Create a new file with the [New Project...] menu item or select a correct file.
E0001001	The input value is not correct.	The value entered is wrong. Enter the value in the correct format.
E0001002	The combination of file type is incorrect.	This error occurs when an RPI, HCUHEX, DDI, or RPE file is selected at the same time as a file of another type. Specify these file types exclusively of each other.
E0001003	The specified frequency is out of range.	The clock frequency value that was entered exceeds the valid range for the target device. Refer to the user's manual of the target device or Points for Caution stated in the Release Note of the PG-FP6 and enter a correct value.
E0001006	No blocks have been selected for the current operation.	Select one or more blocks for the operation on the [Block Settings] tabbed page.
E0001007	No flash options have been set.	There are no target options when flash options are to be programmed. Change at least one setting to [Set] on the [Flash Options] tabbed page.
E0002002	Updating of the firmware failed.	Confirm the connection with the FP6. The firmware file may be damaged. Reinstall the FP6 Terminal.
E0002202	Boot protection setting is failed.	When an authentication pattern is set for [Boot Protection] in the [FP6 Security Manager] dialog box, the pattern entered the first time does not match that entered the second time. Enter the correct patterns again.
E0003001	Connection to the specified port failed. The port may not exist or is already in use.	Confirm the COM number to which the FP6 is connected. Another possible reason is other terminal software and so on being in contention with the terminal software for the target FP6.
E0003002	Cannot connect to the FP6.	Confirm the COM number to which the FP6 is connected.

No.	Message	Description
E0003003	A communications error occurred.	Communications with the FP6 were stopped. Check for problems with the cable connected to the FP6. If you are using the FP6 in an environment such as Windows 7, automatic reconnection of the FP6 main unit may not be possible when it is restarted. In such a situation, restart the FP6 main unit or FP6 Terminal to reconnect the FP6 main unit.
E0003004	An error occurred during communications with the FP6.	A problem occurred in the data received from the FP6. Confirm the error message in the console window. If the message is not correctly displayed, check for problems with the cable connected to the FP6.
E0009001	Not enough memory for this operation.	Processing cannot be continued since there is not enough memory in the host PC.
E0009002 E0009003	An unexpected error occurred.	Reinstall the FP6 Terminal.
E3000008	This file is corrupt.	This error occurs when a corrupted file or a non-supported key file for DLM authentication is read. Check to see if you have selected the correct key file.
E3000101	The data already exist.	This error occurs when an attempt is made to handle data having overlapping addresses. Check for data having overlapped addresses in the program file.

A.2 Error Messages Produced by the FP6 Main Unit

The following describes the error messages produced by the FP6 main unit. The first rows of the Message column are messages displayed in the message display of the main unit. The second and subsequent rows of the Message column are messages displayed in the FP6 Terminal.

No.	Message	Possible Workaround
001	Invalid PR5 data	The parameter file might not have been downloaded to the FP6, or the parameter file was downloaded but is damaged. Download a correct parameter file to the FP6.
	Invalid Parameter File.	
002	Not connected	The target device is manually connected. Enable automatic connection with the 'autocon' command or execute a 'con' command before the command that leads to this error.
	No device connected.	
004	No response	The target device is not connected or is not responding. Check the connection to and operating mode of the target device. Another possibility is disabling of connection by the security functions of the target device. Refer to section 12.2, Problems during Operation.
	The device is not responding.	
005	Not supported!	The command issued is not supported on the target device and thus cannot be used. Check if the parameter file for the MCU to be connected has been downloaded to the FP6 main unit.
	Not supported for this device type.	
006	Command aborted!	Execution of the command has been canceled.
	Cancel pressed, command aborted.	
008	Parameter Error!	An illegal option was specified in the communications command. Refer to chapter 7, Usage of Communications Commands, and specify a correct option.
	Invalid argument.	
009	HEX file Error!	The program file data downloaded to the FP6 may have been damaged. Download the program file again.
	HEX file contains invalid data!!	
012	Synchron. Failed	A failure in communications occurred while the FP6 was proceeding with connection to the target device. Check the connection between the target device and the FP6. Slowing the transfer rate may solve this problem.
	Connection or Synchronisation failed.	
013	Addr. Range err	The address given in the command exceeds the address range of the MCU.
014	RDY detect. fail	The target device is not connected or is not responding. Check the connection to and operating mode of the target device. Refer to section 12.2, Problems during Operation.
	Connection or Synchronisation failed.	
015	Freq. set failed	Setting the frequency of the target device failed. Check if the oscillator frequency of the target system matches the frequency specified in the FP6 Terminal, and if the frequency is selectable for the MCU.
	Connection or Synchronisation failed.	
016	Baudrt. set fail	Setting the baud rate of the target device failed. Check if the oscillator frequency of the target system matches the frequency specified in the FP6 Terminal. The MCU may not support the specified baud rate. Refer to the user's manual of the MCU and specify a supported baud rate.
	Connection or Synchronisation failed.	
017	ID code chk. err	This error code and message are displayed when an ID code different from the security code set in the target device is authenticated.
	Security code authentication failed.	If you have forgotten the configured ID code, connection to the target device for serial programming is basically disabled. However, erasure of the whole flash memory is enabled as an exception in some target devices; for details, refer to the user's manual of the target device.

No.	Message	Possible Workaround
020	Inv. Sig. ID	An attempt was made to connect a target device which differs from that when the settings file was created. Create a new settings file or use the correct settings file with the target device.
	Invalid signature code.	
021	Inv. Sig. code	An attempt was made to connect a target device which differs from that when the settings file was created. Create a new settings file or use the correct settings file with the target device.
	Invalid signature code.	
022	Inv. Sig. func.	An attempt was made to connect a target device which differs from that when the settings file was created. Create a new settings file or use the correct settings file with the target device.
	Invalid signature code.	
023	Inv. Sig. addr.	An attempt was made to connect a target device which differs from that when the settings file was created or the memory structure might have been changed by the option settings of the target device. Create a new settings file. Refer to section 12.2, Problems during Operation.
	Invalid signature code.	
024	Inv. device name	An attempt was made to connect a target device which differs from that when the settings file was created. Create a new settings file or use the correct settings file with the target device.
	Invalid signature code.	
026	Inv. Dev/Firm ver	An attempt was made to connect a target device which differs from that when the settings file was created. Create a new settings file or use the correct settings file with the target device.
	Invalid device or firmware version.	
027	Unkn. Signature	The parameter file downloaded to the FP6 may have been damaged. Download the parameter file to the FP6 again.
	Invalid signature code.	
029	Inv. DeviceInfo	Check the correctness of the correspondence between the parameter file downloaded to the FP6 and the connected MCU.
	Connection or Synchronisation failed.	
034	Endian info err	A timeout occurred when a problem in communications between the target device and the FP6 arose for some reason. Check the connection to the target device and confirm that the target device has not been reset. Refer to section 12.2, Problems during Operation.
	Communication failure or timeout.	
040	Erase Timeout	A timeout occurred when a problem in communications between the target device and the FP6 arose for some reason. Check the connection to the target device and confirm that the target device has not been reset. Refer to section 12.2, Problems during Operation.
	Communication failure or timeout.	
041	Erase failure	This error code and message are displayed when erasure of flash memory in the target device was attempted but failed. Possible causes of the error (failure to erase) include: (1) The power-supply voltage for the target device not being correct. (2) Flash memory in the target device cannot be erased because of the pin settings or processing of the target device. (3) An operation was attempted in an area to which a security function is applying a restriction. Check the items (1) through (3) above. If this error is not resolved even if there are none of the problems described in (1) through (3) above, the target device may be malfunctioning (including defects in or deterioration of the flash memory).
	Erase failed	
	Protect error due to Security Setting	
	Receive device error (0xXX)	
050	BIn Timeout	A timeout occurred when a problem in communications between the target device and the FP6 arose for some reason. Check the connection to the target device and confirm that the target device has not been reset. Refer to section 12.2, Problems during Operation.
	Communication failure or timeout.	
051	Blank chk failed	This error code and message are displayed when blank checking is executed for the flash memory of the target device and the area is not blank. When the target device is to be programmed, erase the flash memory with the 'ers' command before executing the 'prg' command or execute the 'ep' command.
	Not Blank.	

No.	Message	Possible Workaround
070	Write timeout	A timeout occurred when a problem in communications between the target device and the FP6 arose for some reason. Check the connection to the target device and confirm that the target device has not been reset. Refer to section 12.2, Problems during Operation.
	Communication failure or timeout.	
071	Write failed	This error code and message are displayed when programming of flash memory in the target device was attempted but failed. Check the items (1) through (5) below.
	Program failed	
	Protect error due to Security Setting	If this error is not resolved even if there are none of the problems described in (1) through (5) below, the target device may be malfunctioning (including defects in or deterioration of the flash memory).
	Receive device error (0xXX)	(1) Programming was attempted in an area where the flash memory had not been erased. (2) The power-supply voltage for the target device not being correct. (3) Flash memory in the target device cannot be programmed because of the pin settings or processing of the target device. (4) An operation was attempted in an area to which a security function is applying a restriction. (5) The state of the switch area is dirty during programming of flash memory in the target device. Execute [SWAS Recover] to restore the state of the switch area to valid.
074	No Prog Data	The operation area contains no data for the program file. Check the block setting and program file downloaded to the FP6.
	There is no data in the operating range.	
075	No Flash Option	The flash option settings have not been specified in the setting file.
	No flash options have been set.	When using the Program Flash Option command (pfo command), specify the flash option settings.
076	No SVR Parameter	This error occurs when [Using program files] under [Override SVR parameters] is enabled but data include no SVR parameters in the specified program file.
	There are no SVR parameters in the data.	
080	Vrf Timeout	A timeout occurred when a problem in communications between the target device and the FP6 arose for some reason. Check the connection to the target device and confirm that the target device has not been reset. Refer to section 12.2, Problems during Operation.
	Communication failure or timeout.	
081	Verify failed	This error code and message are displayed when verification of flash memory in the target device was attempted but failed. Possible causes of the error include: (1) Different data have been written to the program file and the target device. (2) The power-supply voltage for the target device not being correct. (3) Data cannot be read from flash memory in the target device because of the pin settings or processing of the target device. (4) An operation was attempted in an area to which a security function is applying a restriction. Check the items (1) through (4) above. If this error is not resolved even if there are none of the problems described in (1) through (4) above, the target device may be malfunctioning (including defects in or deterioration of the flash memory).
	Receive device error (0xXX)	
090	IVrf Timeout	A timeout occurred when a problem in communications between the target device and the FP6 arose for some reason. Check the connection to the target device and confirm that the target device has not been reset. Refer to section 12.2, Problems during Operation.
	Communication failure or timeout.	
091	IVerify failed	An error occurred while the flash memory of the target device was being programmed. Erase the flash memory before programming. Also, check that the power-supply voltage for the target device is normal. If the same error occurs even if you try the operation again, the target device may be malfunctioning (including defects in or deterioration of the flash memory).
	Internal Verify failed	

No.	Message	Possible Workaround
093	SUM Comm err	An error occurred during execution of the 'sum' command. This might be due to a problem with communications between the FP6 and target device. Refer to section 12.2, Problems during Operation.
	Communication failure or timeout.	
094	SCF Comm err	This error code and message are displayed when programming of flash options in the target device was attempted but failed. Possible causes of the error (failure to program) include: (1) An attempt was made to enable a command that had already been disabled. (2) An operation that is not possible in the security state of the target device was attempted. (3) The power-supply voltage for the target device not being correct. (4) Data cannot be read from flash memory in the target device because of the pin settings or processing of the target device. (5) The target device is malfunctioning (including defect or deterioration in the flash memory). Reset the target device or re-check its security state. In some target devices, this problem may be rectified by erasing the flash options (selecting the erasure option as [Erase Chip] to erase the chip). For details, refer to the user's manual of the target device. Another possibility is a problem with communications between the FP6 and target device. Refer to section 12.2, Problems during Operation.
	Communication failure or timeout.	
095	GSC Comm err	An error occurred during execution of the 'gsc' command. This might be due to a problem with communications between the FP6 and target device. Refer to section 12.2, Problems during Operation.
	Communication failure or timeout.	
096	CLR Comm err	This error occurs when the flash memory in the target device is not blank and the 'clr' or 'rsc' command is executed. Erase all of the flash memory in the target device before executing these commands. Another possibility is a problem with communications between the FP6 and target device. Refer to section 12.2, Problems during Operation.
	Communication failure or timeout.	
099	READ Comm err	An error occurred during execution of the 'read' command. Read prohibition may be set in the security settings for the target device. Another possibility is a problem with communications between the FP6 and target device. Refer to section 12.2, Problems during Operation.
	Communication failure or timeout.	
	Protect error due to Security Setting	
	Receive device error (0xXX)	
100	Pattern mismatch	When an authentication pattern is set for [Boot Protection] in the [FP6 Security Manager] dialog box, the pattern as entered the first time does not match that entered the second time. To specify an authentication pattern for [Boot Protection], the same pattern must be entered the first and second times.
	The first and second patterns do not match.	
101	ep/prg/vrf Limit	Due to the restriction on the number of times the target device is programmed which is set for [Limit Target Programming] in the [FP6 Security Manager] dialog box, no more programming or verification commands can be executed. The FP6 Security Manager function is available for removing this restriction.
	The number of executions of ep/prg/vrf command exceeded the upper limit.	
102	Cmd restricted	Due to the restriction which is set for [Restrict FP6 Operations] in the [FP6 Security Manager] dialog box, executing the command is prohibited. The FP6 Security Manager function is available for removing this restriction.
	Execution of this command is restricted.	

No.	Message	Possible Workaround
103	Cmd restricted	Executing a command is prohibited during the downloading of a HCUHEX or RPI file.
	Execution of this command is restricted when using RPI file.	
106	DLM Comm err.	An error occurred during execution of the 'dln' command. This might be due to a problem with communications between the FP6 and target device. If the same error occurs even if you try the operation again, improve the connection environment between the FP6 and MCU. Slowing the transfer rate may solve this problem.
	DLM error. (0xXX)	
107	Require Authen	A transition in the life cycle that requires authentication may have been made with the 'pfo' command. However, use the 'dln' command in such cases ([DLM Transition] in the FP6 Terminal menu). Alternatively, execute the 'ers_chip' command ([Initialize device] in the FP6 Terminal menu) to initialize the target device.
	This operation requires authentication.	
108	DLM Comm err.	A transition in the life cycle by the target device failed. A state that does not allow transitions from the current life cycle may have been specified. Acquire the flash options of the target device and confirm that the state that can transit has been specified.
	Cannot transition to the specified state from the current state.	
109	NoSupport UsrKey	This error code and message are displayed when an ep, prg, or vrf command was executed after setting of the SWD communications method and downloading of a user key. Write and verify user keys through UART communications.
	User keys are not supported when using the SWD interface.	
111	NoSupport File	Parameter files or setting files cannot be downloaded because the firmware for the FP6 main unit is old. Connect the latest version of the FP6 Terminal to update the firmware for the FP6.
	This file is not supported by this firmware version. Please update to latest firmware version.	
204	Not connected	A 'dcon' command was issued when the target device was already disconnected from the FP6.
	No Device connected.	
210	Already conn.	A 'con' command was issued when the target device was already connected to the FP6. The FP6 target commands can be issued.
	Device already connected.	
302	HEX range err	The address range of the downloaded program file extends beyond the set address range. Check the specified program file. When there is no problem even if data out of the range have been included, deselect [Program File Size Monitor] in the [FP6 Options] dialog box.
	HEX file exceeds target device flash range.	
303	Invalid ID Tag	The format of the ID Tag is not correct. Download the correct file.
	Invalid ID Tag	For information on the ID Tag, refer to the Terminology table of this user's manual.
400	Targ. power det.	This error message is displayed when the FP6 should supply VCC power but VCC has been detected as already being 0.2 V or higher in the target system before VCC is supplied. Check VCC in the target system. If there is no problem with the target system, the FP6 main unit might be damaged. Run a self-test. If this does not resolve the problem, contact a Renesas Electronics sales representative or distributor.
	Power failure.	
402	FP6 int Vcc fail	The FP6 main unit might be damaged. Contact a Renesas Electronics sales representative or distributor.
	Power failure.	

No.	Message	Possible Workaround
404	Targ. power fail	This error message is displayed when [VCC Monitor] is selected in the [FP6 Manager] dialog box but the VCC voltage is outside the range of the VCC setting by $\pm 5\%$ just before starting communication. Check VCC in the target system. If there is no problem with the target system, the FP6 main unit might be damaged. Run a self-test. If this does not resolve the problem, contact a Renesas Electronics sales representative or distributor.
	Power failure.	
405	Power failure	An overcurrent was detected when VCC was output. Check the connection with the MCU and VCC on the target system. If there is no problem with the target system, the FP6 main unit might be damaged. Run a self-test. If this does not resolve the problem, contact a Renesas Electronics sales representative or distributor.
	Power failure.	
407	Input Power fail.	The voltage of the USB and the power adapter is not correct. When the same error occurs even after the connected PC or AC adapter is changed, the FP6 main unit might be damaged. Contact a Renesas Electronics sales representative or distributor.
	Power failure.	
585	GOB Comm err	An error occurred during execution of the 'gob' command. This might be due to a problem with communications between the FP6 and target device. Refer to section 12.2, Problems during Operation.
	Communication failure or timeout.	
586	GID Comm err	An error occurred during execution of the 'gid' command. This might be due to a problem with communications between the FP6 and target device. Refer to section 12.2, Problems during Operation.
	Communication failure or timeout.	
587	SLB Comm err	An error occurred during execution of the 'slb' command. A block for which the lock bit has already been set might be disabled in the target device. To disable the lock bit, do not use the 'slb' command but erase the target block. Alternatively, it might be due to a problem with communications between the FP6 and target device. Refer to section 12.2, Problems during Operation.
	Communication failure or timeout.	
588	GOT Comm err	An error occurred during execution of the 'got' command. This might be due to a problem with communications between the FP6 and target device. Refer to section 12.2, Problems during Operation.
	Communication failure or timeout.	
589	GLB Comm err	An error occurred during execution of the 'glb' command. This might be due to a problem with communications between the FP6 and target device. Refer to section 12.2, Problems during Operation.
	Communication failure or timeout.	
590	IDC Comn err	An error occurred during execution of the 'idc' command. The OCD ID of a V850E2 cannot be overwritten. This problem may be resolved by selecting [Erase Chip] as the erasure option and erasing the flash options. Alternatively, it might be due to a problem with communications between the FP6 and target device. Refer to section 12.2, Problems during Operation.
	Communication failure or timeout.	
591	OPB Comn err	An error occurred during execution of the 'opb' command. The option bytes of a V850E2 cannot be overwritten. This problem may be resolved by selecting [Erase Chip] as the erasure option and erasing the flash options. Alternatively, it might be due to a problem with communications between the FP6 and target device. Refer to section 12.2, Problems during Operation.
	Communication failure or timeout.	
592	OTP Comm err	An error occurred during execution of the 'otp' command. A block which has already been set as OTP might be disabled in the target device. The block once an OTP has been set cannot be released. Alternatively, it might be due to a problem with communications between the FP6 and target device. Refer to section 12.2, Problems during Operation.
	Communication failure or timeout.	
593	SID Comm err	An error occurred during execution of the 'sid' command. This might be due to a problem with communications between the FP6 and target device. Refer to section 12.2, Problems during Operation.
	Communication failure or timeout.	
595	SED Comm err	An error occurred during execution of the 'sed' command. This might be due to a problem with communications between the FP6 and target device. Refer to section 12.2, Problems during Operation.
	Communication failure or timeout.	
596	GED Comm err	An error occurred during execution of the 'ged' command. This might be due to a problem with communications between the FP6 and target device. Refer to section 12.2, Problems during Operation.
	Communication failure or timeout.	

No.	Message	Possible Workaround
597	SPD Comm err	An error occurred during execution of the 'spd' command. This might be due to a problem with communications between the FP6 and target device. Refer to section 12.2, Problems during Operation.
	Communication failure or timeout.	
599	STM Comm err	An error occurred during execution of the 'stm' command. This might be due to a problem with communications between the FP6 and target device. Refer to section 12.2, Problems during Operation.
	Communication failure or timeout.	
600	GTM Comm err	An error occurred during execution of the 'gtm' command. This might be due to a problem with communications between the FP6 and target device. Refer to section 12.2, Problems during Operation.
	Communication failure or timeout.	
601	SPD is active	This error occurs when the security setting to prohibit connection has been made. The serial programming function then cannot be used. In some target devices, this error does not occur even if connection has been prohibited but the 004 error occurs instead.
	SPD is active.	
603	SWAS Recover err	An error occurred during execution of the 'swas_recover' command. This might be due to a problem with communications between the FP6 and target device. Refer to section 12.2, Problems during Operation.
	Communication failure or timeout.	
604	GOS Comm err	An error occurred during execution of the 'gos' command. This might be due to a problem with communications between the FP6 and target device. Refer to section 12.2, Problems during Operation.
	Communication failure or timeout.	
605	PFO Comm err	An error occurred during execution of the 'pfo' command. This might be due to a problem with communications between the FP6 and target device. Refer to section 12.2, Problems during Operation.
	Communication failure or timeout.	
606	PFO Status err	An error occurred during execution of the 'pfo' command. This error code and message are displayed when programming of flash options in the target device was attempted but failed. For details, refer to the user's manual of the target device.
	Receive device error (0xXX)	
607	PFO Protect err	An error occurred during execution of the 'pfo' command. Possible causes of the error (failure to program) include: (1) The specified operation is prohibited by a security function of the target device. (2) An attempt was made to change an operation prohibited by a security function of the target device to be permitted. Reset the target device or re-check its security state.
	Protection err	
608	PFO Write err	An error occurred during execution of the 'pfo' command. This error code and message are displayed when programming of the DLM key in the target device was attempted but failed. Check that the specified DLM key is free of problems.
	Program failed	
801	FP6 Power err	The FP6 main unit might be damaged. Contact a Renesas Electronics sales representative or distributor.
	Power Failure detected.	
802	LCD Timeout	The FP6 main unit might be damaged. Contact a Renesas Electronics sales representative or distributor.
	-(No display)-	
803	NAND flash err	The FP6 main unit might be damaged. Contact a Renesas Electronics sales representative or distributor.
	NAND flash - ECC error	
804	NAND flash err	The FP6 main unit might be damaged. Contact a Renesas Electronics sales representative or distributor.
	NAND flash - Timeout	
805	NAND flash err	Execute the 'init' command (click on the [Initialize FP6] button in the [FP6 Options] dialog box selected from the FP6 Terminal menu). The FP6 main unit might be damaged if the error cannot be fixed. Contact a Renesas Electronics sales representative or distributor.
	NAND flash - Redirection block not found	

No.	Message	Possible Workaround
808	NAND flash err	The FP6 main unit might be damaged. Contact a Renesas Electronics sales representative or distributor.
	NAND flash - Mapping Error	
809	FP6 Config err	The FP6 main unit might be damaged. Contact a Renesas Electronics sales representative or distributor.
	NAND flash - Mapping Error	
810	FP6 Config err	The FP6 main unit might be damaged. Contact a Renesas Electronics sales representative or distributor.
	FP6 Configuration - Erase/Write fail	
811	Statistics err	The FP6 main unit might be damaged. Contact a Renesas Electronics sales representative or distributor.
	FP6 Statistics - Erase/Write fail	
820	FP6 FW err	The firmware of the FP6 is incorrect.
	Firmware data is invalid.	This error may occur when the power of the FP6 main unit is turned off during updating the version of firmware. Contact a Renesas Electronics sales representative or distributor.
830	ProgareaSize err	There is no space in the programming area although the required programming area was reserved when the parameter file was downloaded. Other programming areas must be erased.
	This device requires setting of a larger programming area	
900	DAP err	This error occurs when the CPU clocks are stopped.
	An error occurred during setting of the CPU clock.	Confirm that the clocks are correctly being supplied to the target device. If there are no problems with the clocks, the device may be in the snooze mode or software standby mode. Erase the flash memory of the target device through UART communications.
901	DAP err	This error occurs when the PG-FP6 is connected to the target device through SWD communications while the target device is not in the secure state. Confirm the security state of the target device. If the target device is in the non-secure state, connect the PG-FP6 to the target device through UART communications.
	The device cannot be connected to the FP6 since debugging the device is prohibited.	
902	DAP err	Refer to error message No. 901.
	The device cannot be connected to the FP6 since it is in non-secure state.	

A.3 Error Messages Produced by the FP6 Main Unit that are Only Displayed in the Terminal

The following describes the error messages produced by the FP6 main unit that are only displayed in the USB- or serial-connected terminal.

No.	Message	Description
—	Invalid Parameter File.	A parameter file has not been downloaded to the active programming area of the FP6. Download the parameter file and settings file to the FP6.
—	Password of RPE File not set.	A password for the RPE file has not been set. Set the password for the FP6 in the [FP6 Security Manager] dialog box before downloading an RPE file to the FP6.
—	Invalid MDE	The endian specified on the [Program File] tabbed page of the [Setup] dialog box may not match that of the downloaded program file. Confirm that the endians of the program file and settings file match.
—	Consolidated HEX file has no Option and Security data.	An HCUHEX file downloaded to the FP6 does not include flash options data. Use HCU.exe to create a HCUHEX file that includes the options.
—	This file format does not support uploading.	Uploading of RPE, RPI, and HCUHEX files is not supported.
—	Command not found (enter 'hlp' for help).	The FP6 does not support the communications command. Check the executable commands by issuing the 'hlp' command.
—	Please update to latest firmware version.	When you use a downloaded parameter file, the FP6 firmware must have been updated to the latest version. Use the FP6 Terminal to update the FP6 firmware.
—	Aborted in line: xx Invalid file format.	The format of the downloaded program file might be wrong. Check the line indicated by "Aborted in line: xx". This error will also occur when the password given for the RPE file does not match the actual password.

A.4 List of Security and Safety Functions of the Target Device that May Affect the Operation of the Programmer

The following lists the security and safety functions of the target device that may affect the error messages with descriptions that include security functions.

- Access window
- Flash shield window
- OTP
- Disable Debugger and Serial Programming
- Disable Serial Programming
- DLM
- Disable Initialize Command
- Disable Chip Erase
- Disable Block Erase
- Disable Program
- Disable Rewriting boot cluster
- ICU
- Disable Read

Remark: The security functions included in a target device and the operation when the security function has been set depends on the target device. Some security functions may not be cleared by using the [Erase Chip] option or the [Initialize Device] menu. For details, refer to the user's manual of the target device.

Appendix B. Supplementary Information

This chapter covers supplementary information referred to by the user's manual of the FP6.

B.1 32-Bit CRC Method

```

/* The generator polynomial used for this table is */
/*  $x^{32}+x^{26}+x^{23}+x^{22}+x^{16}+x^{12}+x^{11}+x^{10}+x^8+x^7+x^5+x^4+x^2+x^1+x^0$  */
/* according to Autodin/Ethernet/ADCCP protocol standards */
/* Binary: 0x04c11db7 */
const uint32_t CRC32_Tab [256]= {
    0x00000000, 0x04c11db7, 0x09823b6e, 0x0d4326d9, 0x130476dc, 0x17c56b6b, 0x1a864db2, 0x1e475005,
    0x2608edb8, 0x22c9f00f, 0x2f8ad6d6, 0x2b4bcb61, 0x350c9b64, 0x31cd86d3, 0x3c8ea00a, 0x384fbd8d,
    0x4c11db70, 0x48d0c6c7, 0x4593e01e, 0x4152fda9, 0x5f15adac, 0x5bd4b01b, 0x569796c2, 0x52568b75,
    0x6a1936c8, 0x6ed82b7f, 0x639b0da6, 0x675a1011, 0x791d4014, 0x7ddc5da3, 0x709f7b7a, 0x745e66cd,
    0x9823b6e0, 0x9ce2ab57, 0x91a18d8e, 0x95609039, 0x8b27c03c, 0x8fe6dd8b, 0x82a5fb52, 0x8664e6e5,
    0xbe2b5b58, 0xbaea46ef, 0xb7a96036, 0xb3687d81, 0xad2f2d84, 0xa9ee3033, 0xa4ad16ea, 0xa06c0b5d,
    0xd4326d90, 0xd0f37027, 0xddb056fe, 0xd9714b49, 0xc7361b4c, 0xc3f706fb, 0xcceb42022, 0xca753d95,
    0xf23a8028, 0xf6fb9d9f, 0xfbb8bb46, 0xff79a6f1, 0xe13ef6f4, 0xe5ffeb43, 0xe8bccd9a, 0xec7dd02d,
    0x34867077, 0x30476dc0, 0x3d044b19, 0x39c556ae, 0x278206ab, 0x23431b1c, 0x2e003dc5, 0x2ac12072,
    0x128e9dcf, 0x164f8078, 0x1b0ca6a1, 0x1fcd8bb16, 0x018aeb13, 0x054bf6a4, 0x0808d07d, 0x0cc9cdca,
    0x7897ab07, 0x7c56b6b0, 0x71159069, 0x75d48dde, 0x6b93d8db, 0x6f52c06c, 0x6211e6b5, 0x66d0fb02,
    0x5e9f46bf, 0x5a5e5b08, 0x571d7dd1, 0x53dc6066, 0x4d9b3063, 0x495a2dd4, 0x44190b0d, 0x40d816ba,
    0xaca5c697, 0xa864db20, 0xa527fdf9, 0xa1e6e04e, 0xbfa1b04b, 0xbb60adfc, 0xb6238b25, 0xb2e29692,
    0x8aad2b2f, 0x8e6c3698, 0x832f1041, 0x87ee0df6, 0x99a95df3, 0x9d684044, 0x902b669d, 0x94ea7b2a,
    0xe0b41de7, 0xe4750050, 0xe9362689, 0xedf73b3e, 0xf3b06b3b, 0xf771768c, 0xfa325055, 0xfef34de2,
    0xc6bcf05f, 0xc27dede8, 0xcf3ecb31, 0xcbbfd686, 0xd5b88683, 0xd1799b34, 0xdc3abded, 0xd8fba05a,
    0x690ce0ee, 0x6dcdffd59, 0x608edb80, 0x644fc637, 0x7a089632, 0x7ec98b85, 0x738aad5c, 0x774bb0eb,
    0x4f040d56, 0x4bc510e1, 0x46863638, 0x42472b8f, 0x5c007b8a, 0x58c1663d, 0x558240e4, 0x51435d53,
    0x251d3b9e, 0x21dc2629, 0x2c9f00f0, 0x285e1d47, 0x36194d42, 0x32d850f5, 0x3f9b762c, 0x3b5a6b9b,
    0x0315d626, 0x07d4cb91, 0x0a97ed48, 0x0e56f0ff, 0x1011a0fa, 0x14d0bd4d, 0x19939b94, 0x1d528623,
    0xf12f560e, 0xf5ee4bb9, 0xf8ad6d60, 0xfc6c70d7, 0xe22b20d2, 0xe6ea3d65, 0xeba91bbc, 0xef68060b,
    0xd727bb66, 0xd3e6a601, 0xdea580d8, 0xda649d6f, 0xc423cd6a, 0xc0e2d0dd, 0xcda1f604, 0xc960ebb3,
    0xbd3e8d7e, 0xb9ff90c9, 0xb4bcb610, 0xb07daba7, 0xae3afba2, 0xaafbe615, 0xa7b8c0cc, 0xa379dd7b,
    0x9b3660c6, 0x9fff77d1, 0x92b45ba8, 0x9675461f, 0x8832161a, 0x8cf30bad, 0x81b02d74, 0x857130c3,
    0x5d8a9099, 0x594b8d2e, 0x5408abf7, 0x50c9b640, 0x4e8ee645, 0x4a4ffbf2, 0x470cdd2b, 0x43cdc09c,
    0x7b827d21, 0x7f436096, 0x7200464f, 0x76c15bf8, 0x68860bfd, 0x6c47164a, 0x61043093, 0x65c52d24,
    0x119b4be9, 0x155a565e, 0x18197087, 0x1cd86d30, 0x029f3d35, 0x065e2082, 0x0b1d065b, 0x0fdd1bec,
    0x3793a651, 0x3352bbe6, 0x3e119d3f, 0x3ad08088, 0x2497d08d, 0x2056cd3a, 0x2d15ebe3, 0x29d4f654,
    0xc5a92679, 0xc1683bce, 0xcc2b1d17, 0xc8ea00a0, 0xd6ad50a5, 0xd26c4d12, 0xdf2f6bcb, 0xdbee767c,
    0xe3a1cbc1, 0xe760d676, 0xea23f0af, 0xeee2ed18, 0xf0a5bd1d, 0xf464a0aa, 0xf9278673, 0xfd69bc4,
    0x89b8fd09, 0x8d79e0be, 0x803ac667, 0x84fbdbd0, 0x9abc8bd5, 0x9e7d9662, 0x933eb0bb, 0x97ffad0c,
    0xafb010b1, 0xab710d06, 0xa6322bdf, 0xa2f33668, 0xbcb4666d, 0xb8757bda, 0xb5365d03, 0xb1f740b4
};

uint32_t CalcMemoryCRC32 (uint32_t address, uint32_t length)
{
    uint32_t i, rd_ptr, crc_accum;
    uint8_t byte, data [16];

```

```

crc_accum= 0xFFFFFFFF; /* Init Pattern */
for (i= 0, rd_ptr= 16; i < length; i++)
{
    /* Check flash read buffer and fill if needed */
    if (rd_ptr == 16)
    {
        Memory_Read (address, 16, data);
        rd_ptr= 0;
        address+= 16;
    }
    byte= ((crc_accum >> 24) ^ data [rd_ptr++]) & 0xFF;
    crc_accum= (crc_accum << 8) ^ CRC32_Tab [byte];
}
return crc_accum;
}

```

Figure B.1 32-bit CRC Calculation Specifications

B.2 Division Method

```

#define BLOCKSIZ 256

/* You have to store 1-Block ROM data. */
unsigned char rom_data[BLOCKSIZ];

unsigned char
bist_calc()
{
    int i;
    unsigned short bist, bist_temp;

    bist = 0;
    for(i = 0; i < BLOCKSIZ; i++){
        bist_temp = bist & 0x1;
        bist_temp = (bist_temp << 8) | (bist_temp << 9) |
            (bist_temp << 11) | (bist_temp << 12);
        bist = (bist >> 1) ^ rom_data[i] ^ bist_temp;
    }
    return((unsigned char)bist);
}

```

Figure B.2 Division (Original) Calculation Specifications

B.3 16-Bit CRC Method

```

/* The generator polynomial used for this table is: */
/* x^16+x^12+x^5+x^0 according to CCITT-16 standard. */
/* Binary: 0x1021 */
const uint16_t CRC16_Tab [256]= {
    0x0000,0x1021,0x2042,0x3063,0x4084,0x50A5,0x60C6,0x70E7,
    0x8108,0x9129,0xA14A,0xB16B,0xC18C,0xD1AD,0xE1CE,0xF1EF,
    0x1231,0x0210,0x3273,0x2252,0x52B5,0x4294,0x72F7,0x62D6,
    0x9339,0x8318,0xB37B,0xA35A,0xD3BD,0xC39C,0xF3FF,0xE3DE,
    0x2462,0x3443,0x0420,0x1401,0x64E6,0x74C7,0x44A4,0x5485,
    0xA56A,0xB54B,0x8528,0x9509,0xE5EE,0xF5CF,0xC5AC,0xD58D,
    0x3653,0x2672,0x1611,0x0630,0x76D7,0x66F6,0x5695,0x46B4,
    0xB75B,0xA77A,0x9719,0x8738,0xF7DF,0xE7FE,0xD79D,0xC7BC,
    0x48C4,0x58E5,0x6886,0x78A7,0x0840,0x1861,0x2802,0x3823,
    0xC9CC,0xD9ED,0xE98E,0xF9AF,0x8948,0x9969,0xA90A,0xB92B,
    0x5AF5,0x4AD4,0x7AB7,0x6A96,0x1A71,0x0A50,0x3A33,0x2A12,
    0xDBFD,0xCBDC,0xFBBF,0xEB9E,0x9B79,0x8B58,0xBB3B,0xAB1A,
    0x6CA6,0x7C87,0x4CE4,0x5CC5,0x2C22,0x3C03,0x0C60,0x1C41,
    0xEDAE,0xFD8F,0xCDEC,0xDDCD,0xAD2A,0xBD0B,0x8D68,0x9D49,
    0x7E97,0x6EB6,0x5ED5,0x4EF4,0x3E13,0x2E32,0x1E51,0x0E70,
    0xFF9F,0xEFBE,0xDFDD,0xCFFC,0xBF1B,0xAF3A,0x9F59,0x8F78,
    0x9188,0x81A9,0xB1CA,0xA1EB,0xD10C,0xC12D,0xF14E,0xE16F,
    0x1080,0x00A1,0x30C2,0x20E3,0x5004,0x4025,0x7046,0x6067,
    0x83B9,0x9398,0xA3FB,0xB3DA,0xC33D,0xD31C,0xE37F,0xF35E,
    0x02B1,0x1290,0x22F3,0x32D2,0x4235,0x5214,0x6277,0x7256,
    0xB5EA,0xA5CB,0x95A8,0x8589,0xF56E,0xE54F,0xD52C,0xC50D,
    0x34E2,0x24C3,0x14A0,0x0481,0x7466,0x6447,0x5424,0x4405,
    0xA7DB,0xB7FA,0x8799,0x97B8,0xE75F,0xF77E,0xC71D,0xD73C,
    0x26D3,0x36F2,0x0691,0x16B0,0x6657,0x7676,0x4615,0x5634,
    0xD94C,0xC96D,0xF90E,0xE92F,0x99C8,0x89E9,0xB98A,0xA9AB,
    0x5844,0x4865,0x7806,0x6827,0x18C0,0x08E1,0x3882,0x28A3,
    0xCB7D,0xDB5C,0xEB3F,0xFB1E,0x8BF9,0x9BD8,0xABBB,0xBB9A,
    0x4A75,0x5A54,0x6A37,0x7A16,0x0AF1,0x1AD0,0x2AB3,0x3A92,
    0xFD2E,0xED0F,0xDD6C,0xCD4D,0xBDAA,0xAD8B,0x9DE8,0x8DC9,
    0x7C26,0x6C07,0x5C64,0x4C45,0x3CA2,0x2C83,0x1CE0,0x0CC1,
    0xEF1F,0xFF3E,0xCF5D,0xDF7C,0xAF9B,0xBFBA,0x8FD9,0x9FF8,
    0x6E17,0x7E36,0x4E55,0x5E74,0x2E93,0x3EB2,0x0ED1,0x1EF0
};

uint16_t CalcMemoryCRC16 (uint32_t address, uint32_t length)
{
    uint32_t i, rd_ptr;
    uint16_t crc_accum;
    uint8_t byte, data [4];

    crc_accum= 0x0000; /* Init Pattern */
    for (i= 0, rd_ptr= 0; i < length; i++)
    {

```

```
/* Check flash read buffer and fill if needed */
if (rd_ptr == 0)
{
    Memory_Read (address, 4, data);
    rd_ptr= 4;
    address+= 4;
}
byte= (crc_accum >> 8) ^ data [--rd_ptr];
crc_accum= (crc_accum << 8) ^ CRC16_Tab [byte];
}
return crc_accum;
}
```

Figure B.3 16-bit CRC Calculation Specifications

Appendix C. Equivalent Circuits of the Target Interface

This chapter shows equivalent circuits of the target interface.

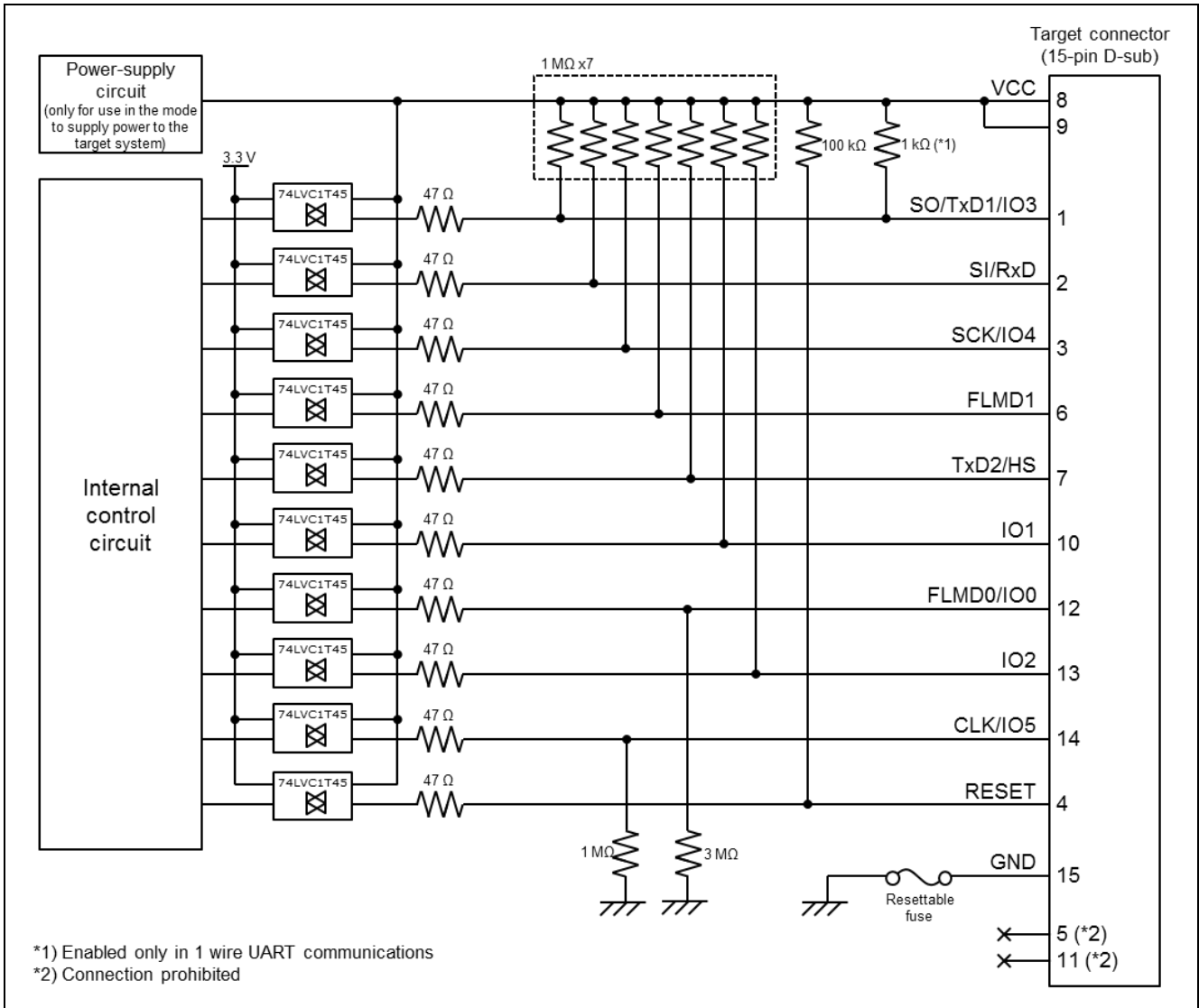

Figure C.1 Equivalent Circuits of the Target Interface

Appendix D. Electrical Specifications of the Remote Interface

This chapter gives the electrical specifications of the remote interface.

D.1 Absolute Maximum Ratings ($T_A=0$ to 40°C)

Pin name	Symbol	Parameter or Conditions	Ratings	Unit
CONN	V_i	Input voltage	-0.5 to +6.0	V
BUSY	I_o	Output current	± 50	mA
PASS ERROR CANCEL ENTER NEXT VRF START CLEAR	I_{ik}	Input current ($V_i < 0$ V)	-50	mA

Note: Product quality may suffer if the absolute maximum rating is exceeded even momentarily for any parameter. That is, the absolute maximum ratings are rated values at which the product is on the verge of suffering physical damage, and therefore the product must be used under conditions that ensure that the absolute maximum ratings are not exceeded.

D.2 DC Characteristics ($T_A=0$ to 40°C , $C=0\text{pF}$ (Unloaded Condition))

Pin name	Symbol	Parameter or Conditions	MIN.	TYP.	MAX.	Unit
CONN	V_{OH}	Output voltage, high ($I_{OH}=8\text{mA}$)	2.3	—	—	V
BUSY		Output voltage, high ($I_{OH}=100\mu\text{A}$)	3.0	3.3	—	V
PASS	V_{OL}	Output voltage, low ($I_{OL}=8\text{mA}$)	—	—	0.8	V
ERROR		Output voltage, low ($I_{OH}=100\mu\text{A}$)	—	0	0.1	V
CANCEL	V_{IH}	Input voltage, high	2	—	—	V
ENTER NEXT VRF START CLEAR	V_{IL}	Input voltage, low	—	—	0.8	V
CONN	I_{OH}	Output current, high	—	—	-8	mA
BUSY PASS ERROR	I_{OL}	Output current, low	—	—	+8	mA
CANCEL	I_i	Input current	—	—	± 1	mA
ENTER NEXT VRF START CLEAR	R_{IPU}	Internal pull-up resistor (3.3V)	—	4.7	—	$\text{k}\Omega$

D.3 AC Characteristics (T_A=0 to 40°C, C=0pF (Unloaded Condition))

D.3.1 Standard mode

(1)

Pin name	Symbol	Parameter or Conditions	MIN.	TYP.	MAX.	Unit
CONN	t _{PLH}	Rise time(I _O =8mA)	—	—	5	ns
BUSY PASS ERROR	t _{PHL}	Fall time (I _O =8mA)	—	—	5	ns
CANCEL ENTER NEXT VRF START CLEAR	t _{PLIN}	Low-level width of input signal	50	—	—	ms
	t _{PCNIN}	Time from the rise of the CONN signal until the input signal is acknowledged	1	—	—	ms

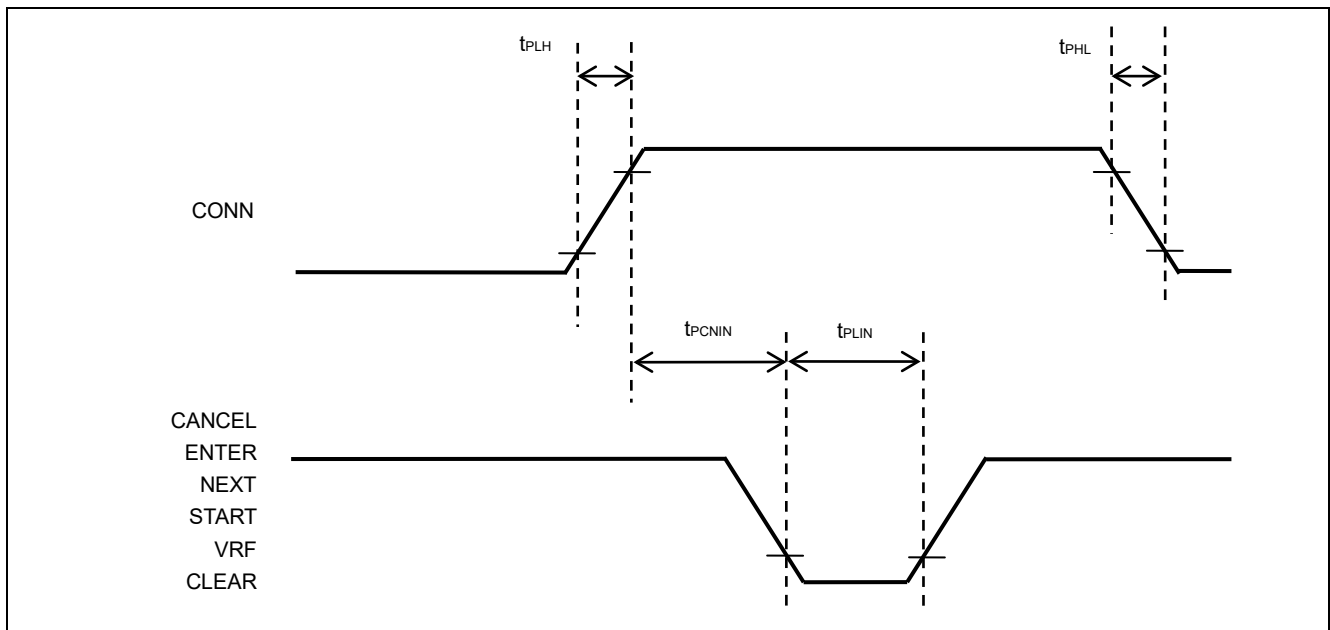

(2)

Pin name	Symbol	Parameter or Conditions	MIN.	TYP.	MAX.	Unit
	t_{PINBU}	Time from the fall of the VRF, START, or ENTER signal until the rise of the BUSY signal	—	—	50	ms
	t_{PBUIN}	Time from the fall of the BUSY signal until the CLEAR signal can be input	1	—	—	ms
	t_{PCLPE}	Time from the fall of the CLEAR signal until the fall of the PASS or ERROR signal	—	—	50	ms
	t_{PPEIN}	Time from the fall of the BUSY signal until the VRF, START, or ENTER signal can be input	—	—	1	ms

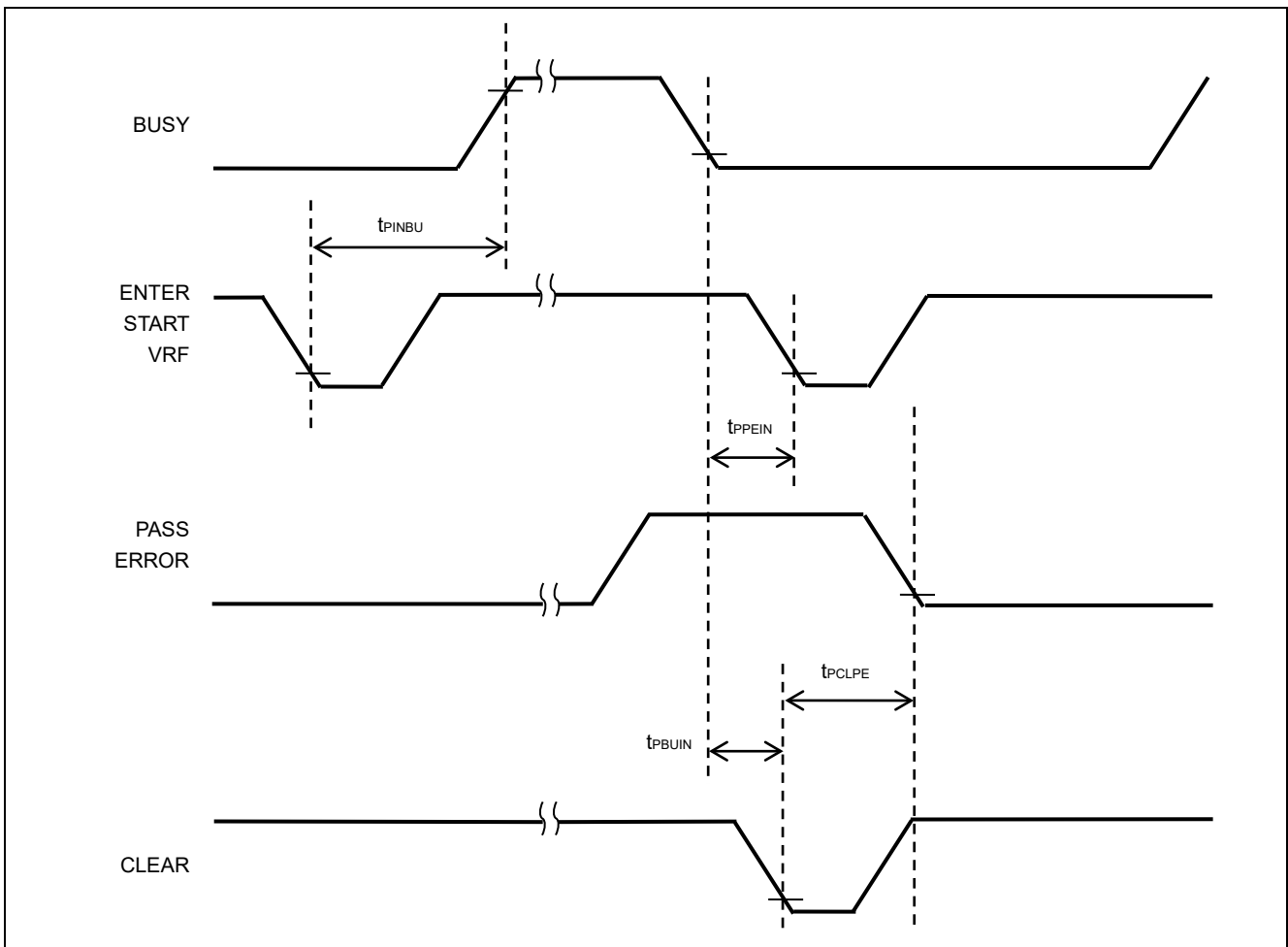

D.3.2 Bank mode

(1)

Pin name	Symbol	Parameter or Conditions	MIN.	TYP.	MAX.	Unit
CONN	t_{PLH}	Rise time ($I_o=8mA$)	—	—	5	ns
BUSY PASS ERROR	t_{PHL}	Fall time ($I_o=8mA$)	—	—	5	ns
BANK0	t_{PLIN}	Low-level width of input signal	50	—	—	ms
BANK1 BANK2 VRF START CLEAR	t_{PCNIN}	Time from the rise of the CONN signal until the input signal is acknowledged	1	—	—	ms

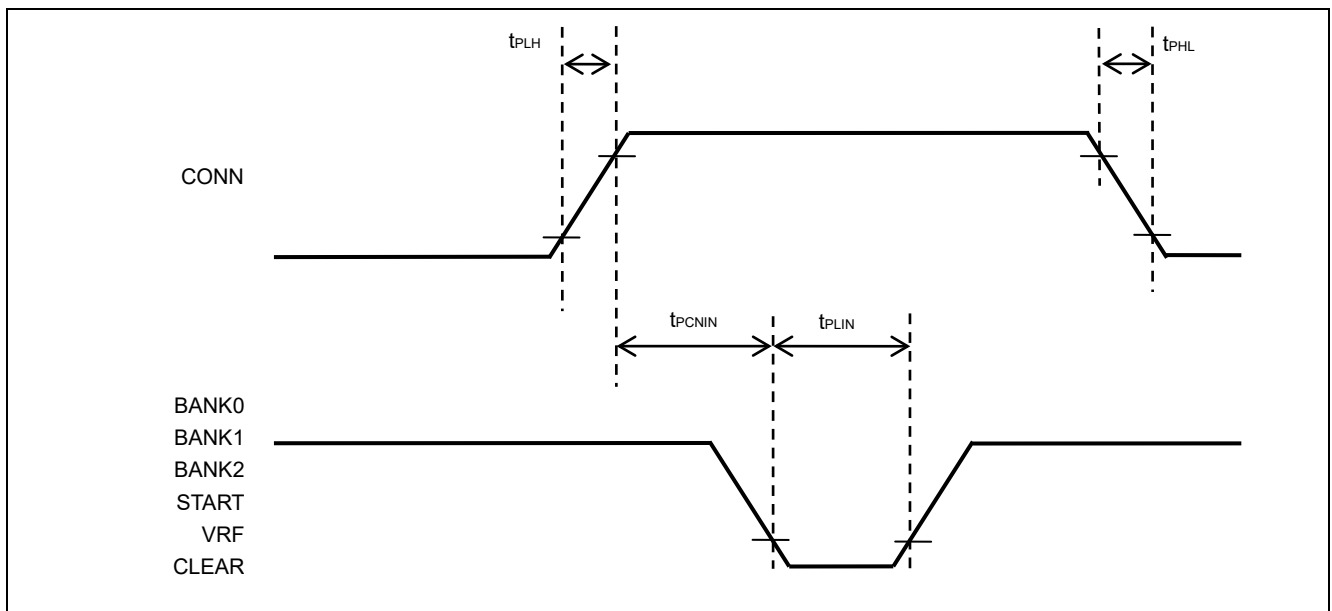

(2)

Pin name	Symbol	Parameter or Conditions	MIN.	TYP.	MAX.	Unit
	t_{PBAIN}	Time from the fall of the BANK signal until the VRF or START signal can be input	1	—	—	ms
	t_{PINBU}	Time from the fall of the VRF, START or ENTER signal until the rise of the BUSY signal	—	—	100	ms
	t_{PBUIN}	Time from the fall of the BUSY signal until the CLEAR signal can be input	5	—	—	ms
	t_{PCLPE}	Time from the fall of the CLEAR signal until the fall of the PASS or ERROR signal	—	—	50	ms
	t_{PPEBA}	Time from the fall of the BUSY signal until the BANK signal can be input	10	—	—	ms

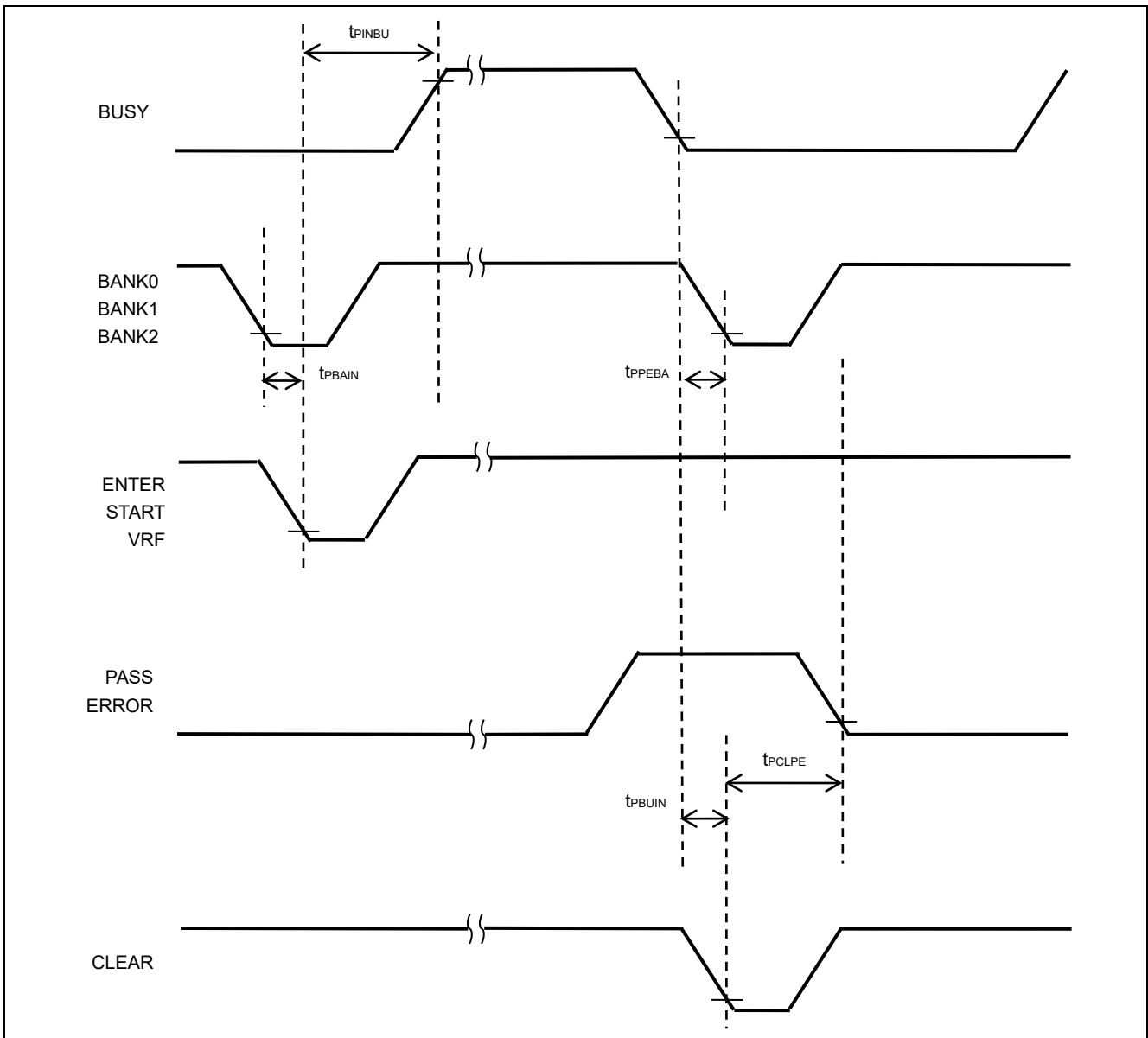

D.3.3 Simple mode

(1)

Pin name	Symbol	Parameter or Conditions	MIN.	TYP.	MAX.	Unit
CONN	t_{PLH}	Rise time (IO=8mA)	—	—	5	ns
BUSY PASS ERROR	t_{PHL}	Fall time (IO=8mA)	—	—	5	ns
CANCEL	t_{PLIN}	Low-level width of input signal	50	—	—	ms
ENTER NEXT VRF START CLEAR	t_{PCNIN}	Time from the rise of the CONN signal until the input signal is acknowledged	1	—	—	ms

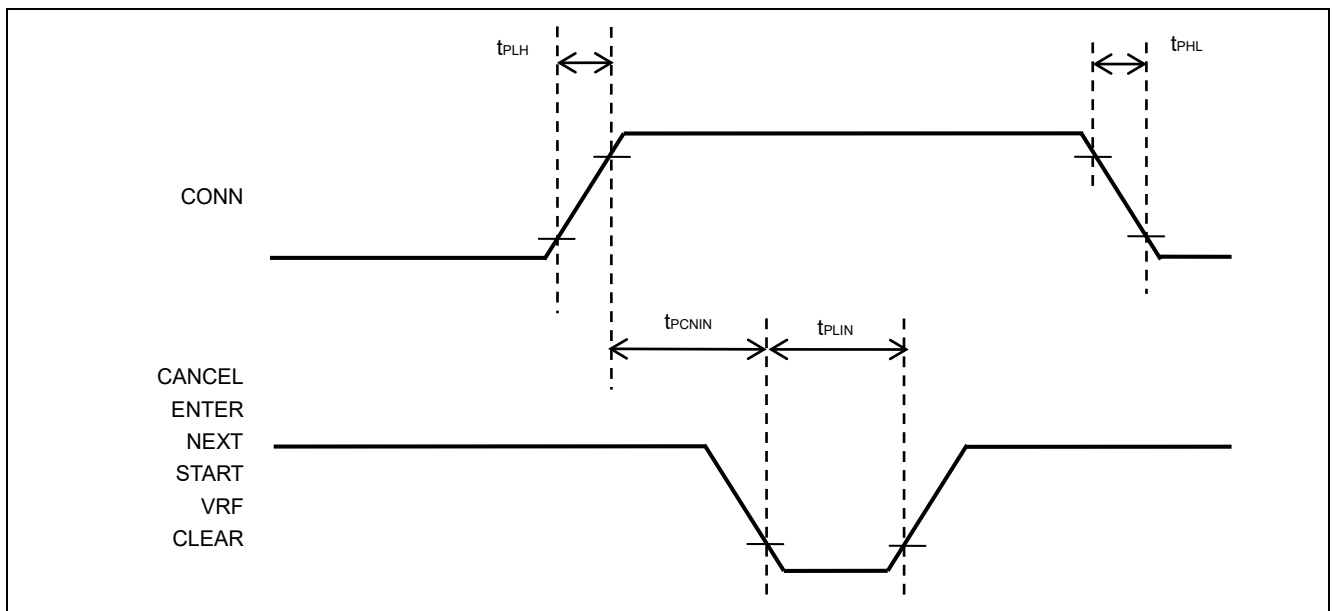

(2)

Pin name	Symbol	Parameter or Conditions	MIN.	TYP.	MAX.	Unit
	t _{PBAIN}	Time from the fall of the NEXT signal until the VRF or START signal can be input	1	—	—	ms
	t _{PINBU}	Time from the fall of the VRF, START or ENTER signal until the rise of the BUSY signal (When the input signal is input after having changed the program area)	—	—	8000	ms
		Time from the fall of the VRF, START or ENTER signal until the rise of the BUSY signal (When the input signal is input without changing the program area)	—	—	50	ms
	t _{PBUIN}	Time from the fall of the BUSY signal until the CLEAR signal can be input	1	—	—	ms
	t _{PCLPE}	Time from the fall of the CLEAR signal until the fall of the PASS or ERROR signal	—	—	50	ms
	t _{PPENE}	Time from the fall of the BUSY signal until the NEXT signal can be input	1	—	—	ms

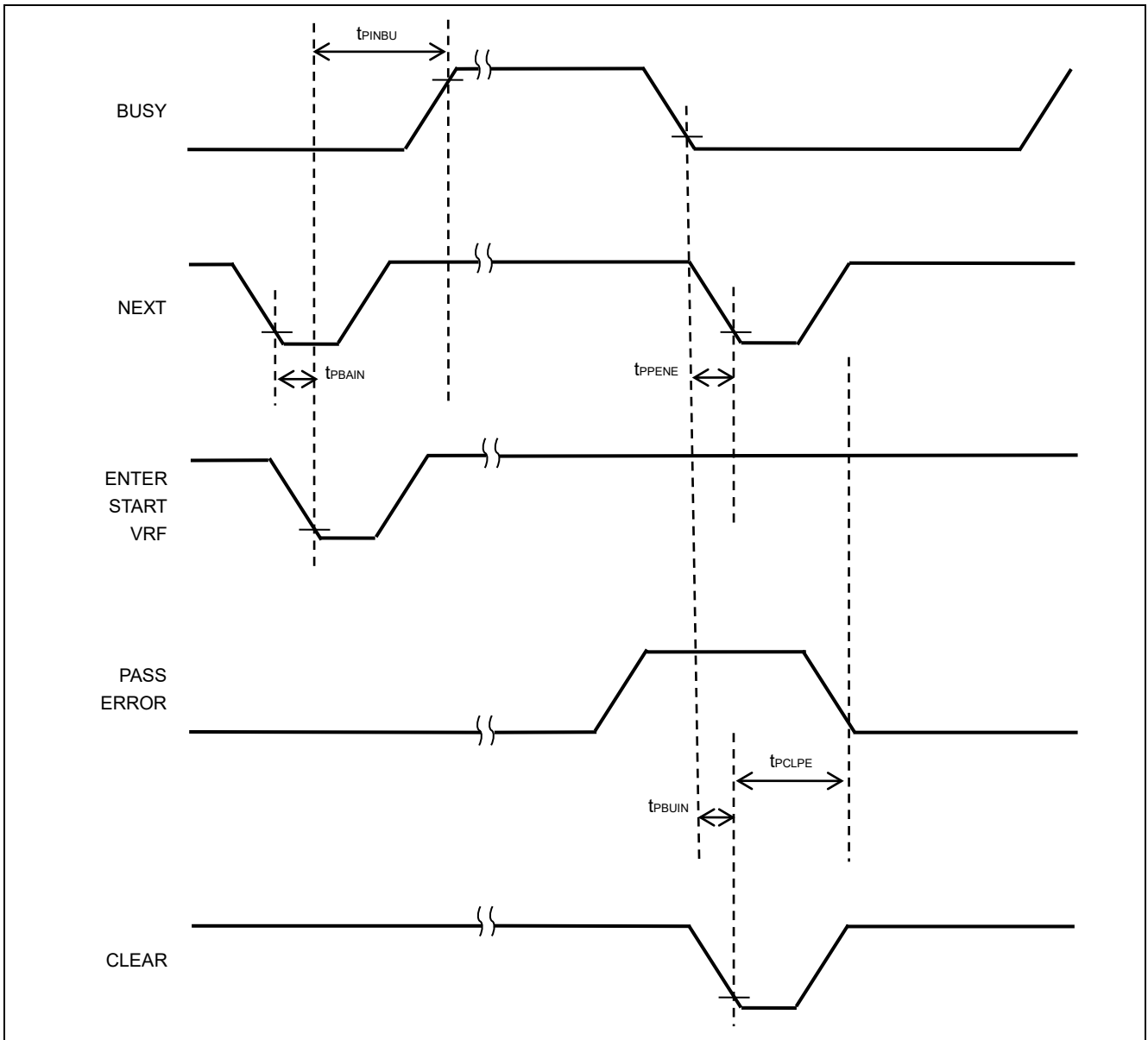

Appendix E. Electrical Specifications of the Target Interface

This chapter gives the electrical specifications of the target interface.

E.1 Absolute Maximum Ratings ($T_A=0$ to 40°C)

Pin name	Symbol	Parameter or Conditions	Ratings	Unit
Vcc	—	Input power-supply voltage	-0.5 to +6.5	V
SO/TxD1/IO3	V_o	Output voltage	-0.5 to $V_{cc} + 0.5 \text{ V}^{*1}$	V
SI/RxD SCK/IO4 RESET FLMD1 TxD2/HS IO1 FLMD0/IO0 IO2 CLK/IO5	V_i	Input voltage	-0.5 to +6.5	V
Vcc	I_o	Output current	+500 ^{*1}	mA
SO/TxD1/IO3 SI/RxD SCK/IO4 RESET FLMD1 TxD2/HS IO1 FLMD0/IO0 IO2 CLK/IO5	I_o	Output current ($-0.3 \text{ V} < V_o < V_{cc} + 0.5 \text{ V}$)	± 50	mA

- Notes:
1. The value must be less than 6.5 V.
 2. The maximum power-supply current is 100 mA when USB bus power is being supplied; however, this depends on the performance of the USB host in terms of the supply of power.
 3. Product quality may suffer if the absolute maximum rating is exceeded even momentarily for any parameter. That is, the absolute maximum ratings are rated values at which the product is on the verge of suffering physical damage, and therefore the product must be used under conditions that ensure that the absolute maximum ratings are not exceeded.

E.2 DC Characteristics (T_A=0 to 40°C)

Pin name	Symbol	Parameter or Conditions	MIN.	TYP.	MAX.	Unit
Vcc	V _{OH}	Output voltage, high	1.2	—	5.5	V
		Output voltage, high (I _{OH} = 100 mA)	V _{CC} - 5%	V _{CC}	V _{CC} + 5%	V
	I _{IH}	Input current, high	—	—	+10	mA
SO/TxD1/IO3	V _{OL1}	Output voltage, low (I _{OL} = 100 μA)	—	0	0.2	V
SI/RxD	V _{OL2}	Output voltage, low (V _{CC} = 1.65 V, I _{OL} = 8mA)	—	—	0.45	V
SCK/IO4	V _{OL3}	Output voltage, low (V _{CC} = 4.5 V, I _{OL} = 32 mA)	—	—	0.55	V
RESET	V _{OH1}	Output voltage, high (I _{OH} = 100 μA)	V _{CC} - 0.1	V _{CC}	—	V
FLMD1	V _{OH2}	Output voltage, high (V _{CC} = 1.65 V, I _{OH} = 8 mA)	1.2	—	—	V
TxD2/HS	V _{OH3}	Output voltage, high (V _{CC} = 4.5 V, I _{OH} = 32 mA)	3.8	—	—	V
IO1	V _{IL1}	Input voltage, low (V _{CC} = 1.2 V)	—	—	V _{CC} × 0.2	V
FLMD0/IO0	V _{IL2}	Input voltage, low (3.0 V < V _{CC} < 3.6 V)	—	—	0.8	V
IO2	V _{IL3}	Input voltage, low (4.5 V < V _{CC} < 5.5 V)	—	—	V _{CC} × 0.3	V
CLK/IO5	V _{IH1}	Input voltage, high (V _{CC} = 1.2 V)	V _{CC} × 0.8	—	—	V
	V _{IH2}	Input voltage, high (3.0 V < V _{CC} < 3.6 V)	2.0	—	—	V
	V _{IH3}	Input voltage, high (4.5 V < V _{CC} < 5.5 V)	V _{CC} × 0.7	—	—	V

Appendix F. Setting the Multiplier

This chapter introduces requirements for the supported MCU groups.

For the range of values that can be selected for "Input Frequency" and "Multiplier", refer to the user's manual for the MCU.

F.1 RX110, RX111, RX113, RX130, RX13T

Input Frequency	Multiplier
2-wire UART: 16 MHz FINE: 8 MHz (VCC < 3V), 32 MHz (VCC ≥ 3V)	CPU 1.0 Peripheral 1.0

F.2 RX140

Input Frequency	Multiplier
2-wire UART: 16 MHz FINE: 32 MHz	CPU 1.0 Peripheral 1.0

F.3 RX220

Input Frequency	Multiplier
32 MHz	CPU 0.5 (VCC < 3 V), 1.0 (VCC ≥ 3 V) Peripheral 0.5 (VCC < 3 V), 1.0 (VCC ≥ 3 V)

F.4 RX230, RX231, RX23E-A, RX23W, RX23E-B

Input Frequency	Multiplier	Speed
8 MHz (VCC < 3 V), 32 MHz (VCC ≥ 3 V)	2-wire UART: CPU 2.0, peripheral 2.0 FINE: CPU 1.0, peripheral 1.0	When the input frequency is 8 MHz, do not select 1,000,000 bps or a higher rate.

F.5 RX23T, RX24T, RX24U

Input Frequency	Multiplier
32 MHz	2-wire UART: CPU 2.0, peripheral 2.0 FINE: CPU 1.0, peripheral 1.0

F.6 RX260, RX261

Input Frequency	Multiplier	Speed
4 MHz (VCC < 1.8 V), 32 MHz (VCC ≥ 1.8 V)	2-wire UART: CPU 2.0, peripheral 2.0 FINE: CPU 1.0, peripheral 1.0	When the input frequency is 4 MHz, select 250,000 bps or a lower rate.

F.7 RX610, RX621, RX62N

Input Frequency	Multiplier
8 MHz ≤ f_x ≤ 14 MHz	CPU 1.0, 2.0, 4.0, 8.0 Peripheral 1.0, 2.0, 4.0, 8.0

Ensure that [Input Frequency] × [Multiplier (CPU)] = 8 MHz to 100 MHz (for ICLK) and [Input Frequency] × [Multiplier (Peripheral)] = 8 MHz to 50 MHz (for PCLK).

F.8 RX62G, RX62T

Input Frequency	Multiplier
8 MHz ≤ f_x ≤ 12.5 MHz	CPU 1.0, 2.0, 4.0, 8.0 Peripheral 1.0, 2.0, 4.0, 8.0

Ensure that [Input Frequency] × [Multiplier (CPU)] = 8 MHz to 100 MHz (for ICLK) and [Input Frequency] × [Multiplier (Peripheral)] = 8 MHz to 50 MHz (for PCLK).

F.9 RX630, RX631, RX63N

RX631: R5F56316, R5F56317, R5F56318, R5F5631F, R5F5631G, R5F5631J, R5F5631W, R5F5631Y

RX63N: R5F563NF, R5F563NG, R5F563NJ, R5F563NW, R5F563NY

Input Frequency	Multiplier
4 MHz ≤ f_x ≤ 16 MHz	CPU 1.0, 2.0, 4.0, 8.0, 16.0 Peripheral 1.0, 2.0, 4.0, 8.0

Ensure that [Input Frequency] × [Multiplier (CPU)] = 4 MHz to 100 MHz (for ICLK) and [Input Frequency] × [Multiplier (Peripheral)] = 4 MHz to 50 MHz (for PCLK).

RX630

RX631: Other than the R5F56316, R5F56317, R5F56318, R5F5631F, R5F5631G, R5F5631J, R5F5631W, and R5F5631Y

RX63N: Other than the R5F563NF, R5F563NG, R5F563NJ, R5F563NW, and R5F563NY

Input Frequency	Multiplier
4 MHz ≤ f_x ≤ 16 MHz	CPU 1.0, 2.0, 4.0, 8.0, 16.0 Peripheral 1.0, 2.0, 4.0, 8.0

Ensure that [Input Frequency] × [Multiplier (CPU)] = 8 MHz to 100 MHz (for ICLK) and [Input Frequency] × [Multiplier (Peripheral)] = 8 MHz to 50 MHz (for PCLK).

F.10 RX634

Input Frequency	Multiplier
4 MHz ≤ f_x ≤ 16 MHz	CPU 1.0, 2.0, 4.0, 8.0, 16.0 Peripheral 1.0, 2.0, 4.0, 8.0

Ensure that [Input Frequency] × [Multiplier (CPU)] = 4 MHz to 54 MHz (for ICLK) and [Input Frequency] × [Multiplier (Peripheral)] = 4 MHz to 32 MHz (for PCLK).

F.11 RX63T

RX63T: R5F563TB, R5F563TC, R5F563TE

Input Frequency	Multiplier
$8 \text{ MHz} \leq f_x \leq 12.5 \text{ MHz}$	CPU 1.0, 2.0, 4.0, 8.0, 16.0 Peripheral 1.0, 2.0, 4.0, 8.0

Ensure that [Input Frequency] × [Multiplier (CPU)] = 8 MHz to 100 MHz (for ICLK) and [Input Frequency] × [Multiplier (Peripheral)] = 8 MHz to 50 MHz (for PCLK).

RX63T: Other than the R5F563TB, R5F563TC, and R5F563TE

Input Frequency	Multiplier
$4 \text{ MHz} \leq f_x \leq 16 \text{ MHz}$	CPU 1.0, 2.0, 4.0, 8.0, 16.0 Peripheral 1.0, 2.0, 4.0, 8.0

Ensure that [Input Frequency] × [Multiplier (CPU)] = 4 MHz to 100 MHz (for ICLK) and [Input Frequency] × [Multiplier (Peripheral)] = 4 MHz to 50 MHz (for PCLK).

F.12 78K0/Dx2, 78K0/Fx2, 78K0/Kx2, 78K0/Kx2-C, 78K0/Lx2, 78K0/Lx3, 78K0/Lx3-M, UPD78F0730, UPD78F8019, UPD78F8020, UPD78F8024/UPD78F8025, UPD78F8032, UPD78F8077

Interface	Clock	Multiplier
CSI Internal OSC	Internal oscillation circuit	Do not change
UART EXCLK	External clock	
UART X1 OSC	External oscillation circuit	
UART Internal OSC	Internal oscillation circuit	

F.13 V850E/IA3, V850E/IA4, V850ES/Dx2, V850ES/Fx2, V850ES/IK1, V850E/Sx2-H, V850E/lx3, V850ES/Hx2, V850ES/IE2

Multiplier	Speed
Do not change	For 2-wire UART communications, do not select 115,200 or 500,000 bps.

F.14 V850E/Sx3-H

Input Frequency	Multiplier
$3 \text{ MHz} \leq f_x \leq 6 \text{ MHz}$	CPU 8.0
$6 \text{ MHz} < f_x \leq 10 \text{ MHz}$	CPU 4.0

F.15 V850ES/Sx2, V850ES/Jx2

Input Frequency	Multiplier	Speed
$2.5 \text{ MHz} \leq f_x \leq 5 \text{ MHz}$	CPU 4.0	For 2-wire UART communications, do not select 115,200 or 500,000 bps.
$5 \text{ MHz} < f_x \leq 10 \text{ MHz}$	CPU 2.0	

F.16 V850ES/Jx3, V850ES/Sx3

Input Frequency	Multiplier	Speed
$2.5 \text{ MHz} \leq f_x \leq 4 \text{ MHz}$	CPU 8.0	For 2-wire UART communications, do not select 500,000 bps.
$4 \text{ MHz} < f_x \leq 5 \text{ MHz}$	CPU 4.0	
$5 \text{ MHz} < f_x \leq 10 \text{ MHz}$	CPU 1.0	

Changing reset vector values in the [Setup] dialog box of the FP6 has no effect since it is not possible with these MCUs.

F.17 V850ES/Kx1, V850ES/Kx1+, V850ES/Kx2

Input Frequency	Multiplier	Speed
$2 \text{ MHz} \leq f_x \leq 5 \text{ MHz}$	CPU 4.0	For 2-wire UART communications, do not select 115,200 or 500,000 bps.
$5 \text{ MHz} < f_x \leq 10 \text{ MHz}$	CPU 1.0	

F.18 V850ES/Jx3-L

Input Frequency	Multiplier	Speed
$2.5 \text{ MHz} \leq f_x \leq 5 \text{ MHz}$	CPU 4.0	For 2-wire UART communications, do not select 500,000 bps.
$5 \text{ MHz} < f_x \leq 10 \text{ MHz}$	CPU 1.0	

Changing reset vector values in the [Setup] dialog box of the FP6 has no effect since it is not possible with these MCUs.

F.19 V850ES/Hx3, V850ES/Fx3

V850ES/Hx3: UPD70F3757

V850ES/Fx3: UPD70F3376A, UPD70F3377A, UPD70F3379, UPD70F3380, UPD70F3381, UPD70F3382, UPD70F3383, UPD70F3384, UPD70F3385

Input Frequency	Multiplier	Speed
$4 \text{ MHz} \leq f_x \leq 6 \text{ MHz}$	CPU 8.0	For 2-wire UART communications, do not select 500,000 bps.
$6 \text{ MHz} < f_x \leq 12 \text{ MHz}$	CPU 4.0	
$12 \text{ MHz} < f_x \leq 16 \text{ MHz}$	CPU 2.0	

V850ES/Hx3: Other than the UPD70F3757

V850ES/Fx3: UPD70F3370A, UPD70F3371, UPD70F3372, UPD70F3373, UPD70F3374, UPD70F3375, UPD70F3378

Input Frequency	Multiplier	Speed
4 MHz	CPU 8.0	For 2-wire UART communications, do not select 500,000 bps.
$4 \text{ MHz} < f_x \leq 8 \text{ MHz}$	CPU 4.0	
$8 \text{ MHz} < f_x \leq 16 \text{ MHz}$	CPU 2.0	

F.20 V850ES/Jx3-H, V850ES/Jx3-U, V850ES/Jx3-E

Multiplier	Speed
Do not change	For 2-wire UART communications, do not select 500,000 bps.

Changing reset vector values in the [Setup] dialog box of the FP6 has no effect since it is not possible with these MCUs.

F.21 V850E/Dx3, V850E/lx4, V850E/lx4-H

Multiplier	Speed
Do not change	For 2-wire UART communications, do not select 500,000 bps.

F.22 V850ES/Fx3-L

Input Frequency	Multiplier	Speed
4 MHz \leq $f_x \leq$ 5 MHz	CPU 4.0	For 2-wire UART communications, do not select 500,000 bps.
5 MHz $<$ $f_x \leq$ 10 MHz	CPU 2.0	
10 MHz $<$ $f_x \leq$ 16 MHz	CPU 1.0	

F.23 V850ES/Dx4, V850ES/Dx4-H

Speed
For 1-wire UART communications, do not select 2,000,000 bps.

F.24 V850E2/Fx4, V850E2/Fx4-M

Input Frequency	Multiplier	Speed
4 MHz	CPU 20.0	For 1-wire UART communications, do not select 2,000,000 bps.
4 MHz $<$ $f_x \leq$ 5 MHz	CPU 16.0	
5 MHz $<$ $f_x \leq$ 8 MHz	CPU 10.0	
8 MHz $<$ $f_x \leq$ 16 MHz	CPU 5.0	
16 MHz $<$ $f_x \leq$ 20 MHz	CPU 4.0	

F.25 V850E2/Fx4-L

UPD70F3579, UPD70F3580, UPD70F3584, UPD70F3585

Input Frequency	Multiplier	Speed
4 MHz	CPU 16.0	For 1-wire UART communications, do not select 2,000,000 bps.
4 MHz $<$ $f_x \leq$ 5 MHz	CPU 9.0	
5 MHz $<$ $f_x \leq$ 8 MHz	CPU 8.0	
8 MHz $<$ $f_x \leq$ 16 MHz	CPU 4.0	
16 MHz $<$ $f_x \leq$ 20 MHz	CPU 1.0	

Other than the UPD70F3579, UPD70F3580, UPD70F3584, UPD70F3585

Input Frequency	Multiplier	Speed
4 MHz	CPU 12.0	For 1-wire UART communications, do not select 2,000,000 bps.
4 MHz $<$ $f_x \leq$ 5 MHz	CPU 9.0	
5 MHz $<$ $f_x \leq$ 8 MHz	CPU 5.0	
8 MHz $<$ $f_x \leq$ 16 MHz	CPU 2.0	
16 MHz $<$ $f_x \leq$ 20 MHz	CPU 1.0	

F.26 V850E2/Fx4-G

UPD70F3592

Input Frequency	Multiplier	Speed
4 MHz	CPU 20.0	For 1-wire UART communications, do not select 2,000,000 bps.
4 MHz < fx ≤ 5 MHz	CPU 16.0	
5 MHz < fx ≤ 8 MHz	CPU 10.0	
8 MHz < fx ≤ 16 MHz	CPU 5.0	
16 MHz < fx ≤ 20 MHz	CPU 4.0	

Other than the UPD70F3592

Input Frequency	Multiplier	Speed
4 MHz	CPU 16.0	For 1-wire UART communications, do not select 2,000,000 bps.
4 MHz < fx ≤ 5 MHz	CPU 9.0	
5 MHz < fx ≤ 8 MHz	CPU 8.0	
8 MHz < fx ≤ 16 MHz	CPU 4.0	
16 MHz < fx ≤ 20 MHz	CPU 1.0	

F.27 V850E2/Mx4

Multiplier	Speed
Do not change	For 1-wire UART communications, do not select 2,000,000 bps.

F.28 SH7146, SH7149

Input Frequency	Multiplier
5 MHz ≤ fx ≤ 12.5 MHz	CPU 1.0, 2.0, 4.0, 8.0 Peripheral 1.0, 2.0, 4.0, 8.0

Ensure that [Input Frequency] × [Multiplier (CPU)] = 10 MHz to 80 MHz (for ICLK) and [Input Frequency] × [Multiplier (Peripheral)] = 10 MHz to 40 MHz (for PCLK).

F.29 SH7214, SH7216

SH7214: R5F72145A, R5F72146A, R5F72147A, R5F72145B, R5F72146B, R5F72147B

SH7216: R5F72165A, R5F72166A, R5F72167A, R5F72165B, R5F72166B, R5F72167B

Input Frequency	Multiplier
10 MHz ≤ fx ≤ 12.5 MHz	CPU 2.0, 4.0, 8.0, 16.0 Peripheral 2.0, 4.0

Ensure that [Input Frequency] × [Multiplier (CPU)] = 20 MHz to 200 MHz (for ICLK) and [Input Frequency] × [Multiplier (Peripheral)] = 20 MHz to 50 MHz (for PCLK).

SH7214: R5F72145G, R5F72146G, R5F72147G, R5F72145H, R5F72146H, R5F72147H
 SH7216: R5F72165G, R5F72166G, R5F72167G, R5F72165H, R5F72166H, R5F72167H

Input Frequency	Multiplier
10 MHz ≤ f_x ≤ 12.5 MHz	CPU 2.0, 4.0, 8.0, 16.0 Peripheral 2.0, 4.0

Ensure that [Input Frequency] × [Multiplier (CPU)] = 20 MHz to 100 MHz (for ICLK) and [Input Frequency] × [Multiplier (Peripheral)] = 20 MHz to 50 MHz (for PCLK).

F.30 SH7253

SH7253: R5F72531

Input Frequency	Multiplier	Pin Setting
16 MHz ≤ f_x ≤ 20 MHz	CPU 4.0 Peripheral 1.0	MD_CLK0: 0 MD_CLKP: 0
	CPU 4.0 Peripheral 2.0	MD_CLK0: 0 MD_CLKP: 1
	CPU 6.0 Peripheral 1.0	MD_CLK0: 1 MD_CLKP: 0
	CPU 6.0 Peripheral 2.0	MD_CLK0: 1 MD_CLKP: 1

SH7253: R5F72533

Input Frequency	Multiplier	Pin Setting
16 MHz ≤ f_x ≤ 20 MHz	CPU 6.0 Peripheral 1.0	MD_CLK0: 0 MD_CLKP: 0
	CPU 6.0 Peripheral 2.0	MD_CLK0: 0 MD_CLKP: 1
	CPU 8.0 Peripheral 1.0	MD_CLK0: 1 MD_CLKP: 0
	CPU 8.0 Peripheral 2.0	MD_CLK0: 1 MD_CLKP: 1

SH7253: R5F72533D

Input Frequency	Multiplier	Pin Setting
16 MHz ≤ f_x ≤ 20 MHz	CPU 6.0 Peripheral 1.0	MD_CLK0: 0 MD_CLKP: 0
	CPU 6.0 Peripheral 2.0	MD_CLK0: 0 MD_CLKP: 1
	CPU 10.0 Peripheral 1.0	MD_CLK0: 1 MD_CLKP: 0
	CPU 10.0 Peripheral 2.0	MD_CLK0: 1 MD_CLKP: 1

F.31 SH72A0

Input Frequency	Multiplier
8 MHz, 10 MHz	CPU 8.0 Peripheral 4.0

F.32 SH72A2

Input Frequency	Multiplier
8 MHz, 10 MHz	CPU 10.0 Peripheral 5.0

Revision History	PG-FP6 V1.16 Flash Memory Programmer User's Manual
------------------	--

Rev.	Date	Description	
		Page	Summary
1.00	Apr.01.25	—	The following items were updated on the basis of the contents of document No. "R20UT5585EJ0100".
		14	"Flash memory" and "Flash area" were added to "Replacing Terms".
		39, 40	Descriptions in section 4.3.2, [Operation Settings] tabbed page, were modified.
		48, 49	Descriptions in section 4.3.4, [Flash Options] tabbed page, were modified.
		95	For "key <type>" in section 7.4.12, lod command, oem_root1 to oem_root3 were added.
		151	Section 13.14, Erase Command, was added.

PG-FP6 V1.16 User's Manual

Publication Date: Rev.1.00 Apr.01.25

Published by: Renesas Electronics Corporation

PG-FP6 V1.16