

NEC

User's Manual

PG-FA-S/F_Line

**Flash Programming Adapter
for S_Line and F_Line
Microcontroller Devices**

Document No. U17213EE1V0UM00
Date Published August 2004

© NEC Corporation 2004
Printed in Germany



This equipment complies with the EMC protection requirements

WARNING

This is a 'Class A' (EN 55022: 1998) equipment. This equipment can cause radio frequency noise when used in the residential area. In such cases, the user/operator of the equipment may be required to take appropriate countermeasures under his responsibility.

EEDT-ST-001-11

CAUTION

This equipment should be handled like a CMOS semiconductor device. The user must take all precautions to avoid build-up of static electricity while working with this equipment. All test and measurement tool including the workbench must be grounded. The user/operator must be grounded using the wrist strap. The connectors and/or device pins should not be touched with bare hands.

EEDT-ST-004-10

- The information in this document is current as of 03.08. 2004. The information is subject to change without notice. For actual design-in, refer to the latest publications of NEC Electronics data sheets or data books, etc., for the most up-to-date specifications of NEC Electronics products. Not all products and/or types are available in every country. Please check with an NEC sales representative for availability and additional information.
- No part of this document may be copied or reproduced in any form or by any means without prior written consent of NEC Electronics. NEC Electronics assumes no responsibility for any errors that may appear in this document.
- NEC Electronics does not assume any liability for infringement of patents, copyrights or other intellectual property rights of third parties by or arising from the use of NEC Electronics products listed in this document or any other liability arising from the use of such NEC Electronics products. No license, express, implied or otherwise, is granted under any patents, copyrights or other intellectual property rights of NEC Electronics or others.
- Descriptions of circuits, software and other related information in this document are provided for illustrative purposes in semiconductor product operation and application examples. The incorporation of these circuits, software and information in the design of customer's equipment shall be done under the full responsibility of customer. NEC Electronics no responsibility for any losses incurred by customers or third parties arising from the use of these circuits, software and information.
- While NEC Electronics endeavors to enhance the quality, reliability and safety of NEC Electronics products, customers agree and acknowledge that the possibility of defects thereof cannot be eliminated entirely. To minimize risks of damage to property or injury (including death) to persons arising from defects in NEC Electronics products, customers must incorporate sufficient safety measures in their design, such as redundancy, fire-containment and anti-failure features.
- NEC Electronics products are classified into the following three quality grades: "Standard", "Special" and "Specific".

The "Specific" quality grade applies only to NEC Electronics products developed based on a customer-designated "quality assurance program" for a specific application. The recommended applications of NEC Electronics product depend on its quality grade, as indicated below. Customers must check the quality grade of each NEC Electronics product before using it in a particular application.

"Standard": Computers, office equipment, communications equipment, test and measurement equipment, audio and visual equipment, home electronic appliances, machine tools, personal electronic equipment and industrial robots.

"Special": Transportation equipment (automobiles, trains, ships, etc.), traffic control systems, anti-disaster systems, anti-crime systems, safety equipment and medical equipment (not specifically designed for life support).

"Specific": Aircraft, aerospace equipment, submersible repeaters, nuclear reactor control systems, life support systems and medical equipment for life support, etc.

The quality grade of NEC Electronics products is "Standard" unless otherwise expressly specified in NEC Electronics data sheets or data books, etc. If customers wish to use NEC Electronics products in applications not intended by NEC Electronics, they must contact NEC Electronics sales representative in advance to determine NEC Electronics 's willingness to support a given application.

Notes: 1. " NEC Electronics" as used in this statement means NEC Electronics Corporation and also includes its majority-owned subsidiaries.

2. " NEC Electronics products" means any product developed or manufactured by or for NEC Electronics (as defined above).

M8E 02.10

Regional Information

Some information contained in this document may vary from country to country. Before using any NEC product in your application, please contact the NEC office in your country to obtain a list of authorized representatives and distributors. They will verify:

- Device availability
- Ordering information
- Product release schedule
- Availability of related technical literature
- Development environment specifications (for example, specifications for third-party tools and components, host computers, power plugs, AC supply voltages, and so forth)
- Network requirements

In addition, trademarks, registered trademarks, export restrictions, and other legal issues may also vary from country to country.

NEC Electronics America Inc.

Santa Clara, California
Tel: 408-588-6000
800-366-9782
Fax: 408-588-6130
800-729-9288

NEC Electronics (Europe) GmbH

Duesseldorf, Germany
Tel: 0211-65 03 1101
Fax: 0211-65 03 1327

Sucursal en España

Madrid, Spain
Tel: 091- 504 27 87
Fax: 091- 504 28 60

Succursale Française

Vélizy-Villacoublay, France
Tel: 01-30-67 58 00
Fax: 01-30-67 58 99

Filiale Italiana

Milano, Italy
Tel: 02-66 75 41
Fax: 02-66 75 42 99

Branch The Netherlands

Eindhoven, The Netherlands
Tel: 040-244 58 45
Fax: 040-244 45 80

Branch Sweden

Taeby, Sweden
Tel: 08-63 80 820
Fax: 08-63 80 388

United Kingdom Branch

Milton Keynes, UK
Tel: 01908-691-133
Fax: 01908-670-290

NEC Electronics Hong Kong Ltd.

Hong Kong
Tel: 2886-9318
Fax: 2886-9022/9044

NEC Electronics Hong Kong Ltd.

Seoul Branch
Seoul, Korea
Tel: 02-528-0303
Fax: 02-528-4411

NEC Electronics Singapore Pte. Ltd.

Singapore
Tel: 65-6253-8311
Fax: 65-6250-3583

NEC Electronics Taiwan Ltd.

Taipei, Taiwan
Tel: 02-2719-2377
Fax: 02-2719-5951

Preface

Target Reader	<p>This manual is intended for users who want to understand the functions of the PG-FA-S/F_Line flash programming adapter.</p> <p>Basic understanding of microcontroller environment is assumed.</p>
Purpose	<p>By using the PG-FA-S/F_Line, program code can easily be erased from, verified or written to the flash memory of an NEC on-chip flash memory microcontroller mounted on the PG-FA-S/F_Line.</p> <p>This manual explains the basic specifications and correct usage of the PG-FA-S/F_Line.</p>
Organization	<p>This manual includes the following chapters:</p> <ul style="list-style-type: none">• Introduction• Hardware description• Supported devices and mount adapters• Circuit diagrams
Conventions	<p>Symbols and notation are used as follows:</p> <p>Weight in data notation : Left is high-order column, right is low order column</p> <p>Active low notation : $\overline{\text{xxx}}$ (pin or signal name is over-scored) or /xxx (slash before signal name)</p> <p>Memory map address: : High order at high stage and low order at low stage</p> <p>Note : Footnote for an item marked with Note in the text</p> <p>Caution : Information requiring particular attention</p> <p>Remark : Supplementary explanation</p> <p>Numeric notation : Binary . . . xxxx or xxxB Decimal . . . XXXX Hexadecimal . . . xxxxH or 0x xxxx</p> <p>Prefixes representing powers of 2 (address space, memory capacity)</p> <p>K (kilo): $2^{10} = 1024$</p> <p>M (mega): $2^{20} = 1024^2 = 1,048,576$</p> <p>G (giga): $2^{30} = 1024^3 = 1,073,741,824$</p>

[MEMO]

Table of Contents

Preface	5
Chapter 1 Introduction	13
1.1 Main Features of the PG-FA-S/F_Line	13
1.2 Package Content	13
1.3 PG-FA-S/F_Line Functional Specification	14
1.4 System Requirements	15
1.5 Related Documents	15
1.6 Document History	15
Chapter 2 Hardware Description	17
2.1 Host Interfaces / Programming Sources	17
2.1.1 USB Host Connector	18
2.1.2 PG-FP4 Connector	18
2.1.3 UART Host Connector	19
2.1.4 Null Modem Cable	20
2.2 Power Supply	21
2.2.1 External power connectors	21
2.3 CREG socket	22
2.4 Clock Sources	22
2.4.1 Oscillator socket	24
2.4.2 Crystal / resonator socket	25
2.5 Device Sockets (for Mount Adapters)	26
2.5.1 Device socket for V850ES/FE2 (64-pin)	26
2.5.2 Device socket for V850ES/FF2 (80-pin)	26
2.5.3 Device socket for V850ES/SG2 and V850ES/FG2 (100-pin, square)	27
2.5.4 Device socket for V850ES/SG2 (100-pin, rectangular)	28
2.5.5 Device socket for V850ES/SJ2 and V850ES/FJ2 (144-pin)	28
2.6 Reset Button	29
2.7 LEDs	30
2.7.1 V _{DD} power LED	30
2.7.2 USB power LED	30
2.7.3 USB activity LED	30
Chapter 3 Supported Devices and Mount Adapters	31
Chapter 4 Circuit Diagrams	33

List of Figures

Figure 2-1:	Pinout of the UART Connector (Sub-D 9-pin male).....	20
Figure 2-2:	Connection Diagram of the Supplied Null-Modem Cable.....	20
Figure 4-1:	Power / Clock	33
Figure 4-2:	PG-FP4 Connector / UART /nWire.....	34
Figure 4-3:	USB-UART Converter	35
Figure 4-4:	Socket Bases 64 / 80	36
Figure 4-5:	Socket Bases 100 / 144	37
Figure 4-6:	Socket Bases 100GF	38

List of Tables

Table 1-1:	PG-FA-S/F_Line Functional Specifications	14
Table 1-2:	Related Documents	15
Table 1-3:	Document History	15
Table 2-1:	Components Functions.....	17
Table 2-2:	Programming Source Priorities.....	17
Table 2-3:	Pinout of the PG-FP4 Connector.....	19
Table 2-4:	Possible Power Sources.....	21
Table 2-5:	Clock Source Selection	22
Table 2-6:	Possible Clock Sources.....	23
Table 2-7:	Clock Priorities.....	23
Table 2-8:	SO2 Pinout	25
Table 3-1:	Supported Mount Adapters.....	31
Table 3-2:	Supported Devices	32

Chapter 1 Introduction

The PG-FA-S/F_Line is a flash programmer and programming adapter for all NEC microcontrollers of the S_Line and F_Line. PG-FA-S/F_Line is designed for three types of operation: It can be used as a USB programmer, it can be used as a UART programmer and it can be used as a programming adapter in combination with a PG-FP4.

1.1 Main Features of the PG-FA-S/F_Line

- Can program any flash device of the S_Line and F_Line microcontroller series (see Table 3-2 on page 32 for a list of supported devices).
- Can be used with FPL software GUI, available on the internet (see the “Serial Flash Writer” section on <http://www.ee.nec.de/update>).
- USB operation: A device can be programmed using a host PC connected to the PG-FA-S/F_Line using a USB cable. No extra hardware is required.
- RS232 operation: A device can be programmed using a host PC connected to the PG-FA-S/F_Line using a null-modem cable (V_{DD} must be supplied externally).
- PG-FP4 operation: A device can be programmed using a PG-FP4 connected to the PG-FA-S/F_Line.
- Self programming operation: The PG-FA-S/F_Line can be used as a minimal target system to check self programming operation (no support).
- Selectable V_{DD} source: For USB operation and for PG-FP4 operation the V_{DD} can be supplied from the host, or optionally externally.
- Selectable clock source: Either an on-board crystal or an on-board oscillator can be used as a clock source. When using PG-FA-S/F_Line in combination with a PG-FP4, the PG-FP4 can be used as the clock source.
- Exchangeable C_{REG} : in case a different value should be used for the on-chip regulators external capacity, it can be placed in a socket.

Note: This product is intended for development and evaluation purposes only. It is not intended to be used in mass production.

1.2 Package Content

After opening the package of the PG-FA-S/F_Line, please first check the content of the box. It should contain the following:

- 1 pcs PG-FA-S/F_Line PCB
- 1 pcs crystal module 5MHz (assembled on the PCB)
- 1 pcs USB cable (A-B type)
- 1 pcs RS232 null modem cable (see Figure 2-2, “Connection Diagram of the Supplied Null-Modem Cable,” on page 20)
- ReadMe booklet

1.3 PG-FA-S/F_Line Functional Specification

Table 1-1: PG-FA-S/F_Line Functional Specifications

Item	Specification
Host interfaces	USB USB type 'B' connector. USB conforms to USB rev. 1.1. Note: USB is only supported on Windows 98, Windows ME, Windows 2000 and Windows XP. Note that the USB port is used to emulate a virtual COM port only as USB is not supported by the FPL software nor by the S_Line or F_Line micro controllers.
	RS-232C Sub-D type 9-pin male connector. Communication speed corresponds to device speed.
	PG-PF4 16 pin connector (2 x 8 x 2.54 mm). This connector can be used with the standard PG-FP4 target connection cable.
Device interface	<p>The devices must be enclosed in a mount adapter (not included in this package). Five socket receptables are available for the following device package types: 64-pin 80-pin 100-pin (square) 100-pin (rectangular) 144-pin Refer to Table 3-1 (page 31) and Table 3-2 (page 32) for a detailed list of devices and sockets supported.</p> <p>The communications interface can be one of the following:</p> USB operation: UARTA0 UART operation: UARTA0 PG-FP4 operation, S_Line: UARTA0, CSIB0 or CSIB0+HS PG-FP4 operation, F_Line: UARTA0, CSIB0, CSIB0+HS, CSIB3 or CSIB3+HS
Supply voltage	S_Line 2.85 V to 3.6 V F_Line 3.5 V to 5.5 V When supplied by USB, the device will be supplied with 3.55V
	S_Line 2.5 MHz to 10 MHz (ext.), see S_Line User's Manual F_Line 4 MHz to 5 MHz (ext.), see F_Line User's Manual By default a crystal module or resonator with 5 MHz is assembled on the PCB.
Environmental conditions	Operating temperature range: 0°C to 40°C Storage temperature range: -15°C to 60°C Humidity: 10 - 80%RH

1.4 System Requirements

To operate the PG-FA-S/F_Line in USB mode, a host PC with a free USB port is required. This host PC must be running the FPL software. The operating system must support USB. Optionally an external power supply can be used.

To operate the PG-FA-S/F_Line in UART mode, a host PC with a free COM port is required. This host PC must be running the FPL software. An external power supply must be used.

To operate the PG-FA-S/F_Line in combination with a PG-FP4, a PG-FP4 is required. Optionally an external power supply can be used.

1.5 Related Documents

These related documents may contain helpful information and will help for a better general understanding.

Table 1-2: Related Documents

Document Name	Document No.
User's Manual FPL, Serial Flash Writer	WEB-00024427
User's Manual PG-FP4, Flash Programmer	U15260EE2V0UM00
All device User's Manuals of all S_Line and F_Line microcontrollers	Consult the internet documentation database and use the keywords S_Line and F_Line for searching

1.6 Document History

Table 1-3: Document History

Date	Revision	Chapter	Description
July 2004	V1.0	All	Initial release

[MEMO]

Chapter 2 Hardware Description

Table 2-1: Components Functions

Component	Function
CN1	V _{DD}
CN2	GND
CN3	PG-FP4
CN4	UART
CN5	Reserved
CN6	USB
CN7-CN17	Device sockets
SO1	C _{REG}
SO2	Crystal / resonator
SO3	Oscillator
SW1	Reset
JP1	Clock source
JP2	Reserved
JP3	Reserved
D3 (red)	LED USB activity
D4 (green)	LED USB power
D6 (green)	LED VDD

2.1 Host Interfaces / Programming Sources

It is mechanically possible to connect the adapter to more than one programming source simultaneously. In this case the sources have different priorities:

Table 2-2: Programming Source Priorities

Priority	Programming source
Highest	USB
Medium	PG-FP4
Lowest	UART

Note: When trying to program from multiple sources simultaneously programming may fail. However no harm to the device or the flash adapter should occur.

2.1.1 USB Host Connector

The USB connection to the host PC is established by CN6 located at the left side of the PG-FA-S/F_Line.

Note: This connection is hot-pluggable.

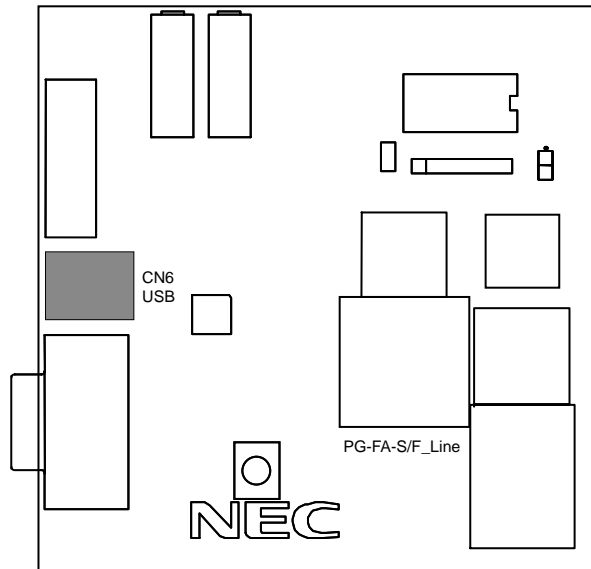

2.1.2 PG-FP4 Connector

The connection to a PG-PF4 is established by CN3 located at the left side of the PG-FA-S/F_Line.

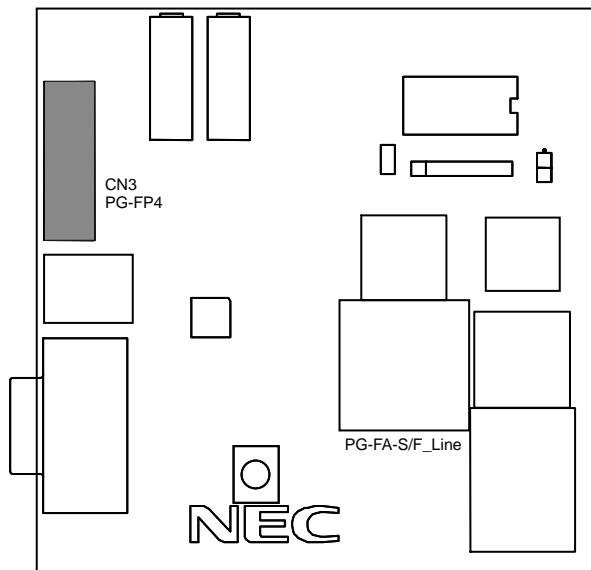

Table 2-3: Pinout of the PG-FP4 Connector

GND	1	2	RESET
SI / RXD	3	4	V _{DD}
SO / TXD	5	6	V _{PP} (n.c.)
SCK	7	8	H/S
CLK	9	10	VDE (n.c.)
V _{DD2} (n.c.)	11	12	FLMD1
n.c.	13	14	FLMD0
n.c.	15	16	n.c.

Note: all signals have V_{DD} level

2.1.3 UART Host Connector

The UART connection to the host PC is established by CN4 located at the left side of the PG-FA-S/F_Line.

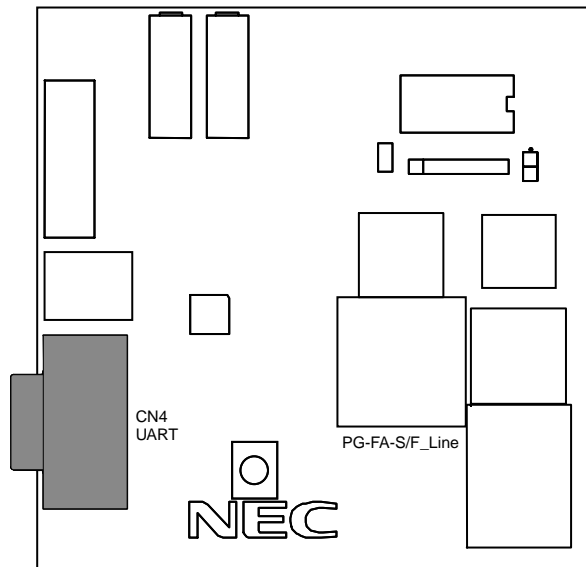
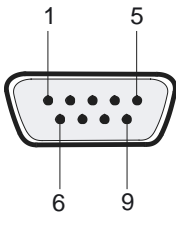

Figure 2-1: Pinout of the UART Connector (Sub-D 9-pin male)

1	DCD	Loop to DTR and DSR	
2	RXD	Connects to RXD of microcontroller	
3	TXD	Connects to TXD of microcontroller	
4	DTR	Loop to DCD and DSR	
5	GND		
6	DSR	Loop to DCD and DTR	
7	RTS	Loop to CTS	
8	CTS	Loop to RTS Can be used for $\overline{\text{RESET}}$	
9	RI	Static L	

Note: all signals have RS-232 levels

2.1.4 Null Modem Cable

The host cable is a standard shielded RS-232 cable of 2 to 3 meters length. The connectors on both sides are Sub-D 9-pin female. The cable used must have the lines RXD/TXD and RTS/CTS crossed (for normal operation with a standard PC).

Figure 2-2: Connection Diagram of the Supplied Null-Modem Cable

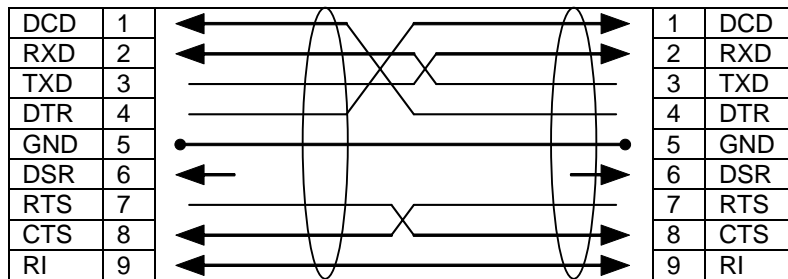

2.2 Power Supply

The microcontroller can be supplied by an external power supply, by USB bus power or by the PG-FP4.

Table 2-4: Possible Power Sources

Programming source	Power source		
	External power supply	USB	PG-FP4
PG-FP4	Yes	No	Yes
UART	Yes	No	No
USB	Yes ^{Note}	Yes	No

Note: When supplying from two sources at the same time programming may fail. However no harm to the device or the flash adapter should occur.

2.2.1 External power connectors

If the microcontroller should be supplied externally, VDD can be applied to CN1 and CN2 located at the left side of the PG-FA-S/F_Line.

- CN1 (red, left): V_{DD}
- CN2 (black, right): GND

Note: When the USB port is connected, it supplies the microcontroller with 3.55 V. You should not connect a lower voltage than 3.55 V to the power connectors if USB is used. A higher voltage than 3.55 V may be applied. The microcontroller is then supplied by the power connectors and not by USB.

Caution: The applied voltage is connected directly to the microcontroller, so be sure that it does not exceed the limits of the device (max. 5.5 V for F_Line; max. 3.6 V for S_Line).

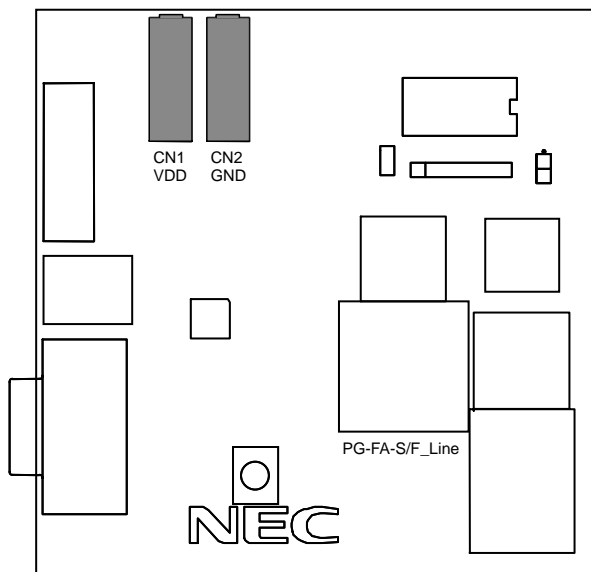

2.3 C_{REG} socket

The internal voltage regulator of the microcontroller device requires an external capacity. This capacity is assembled in socket SO1 and usually has a value of 4.7 μF. Refer to the microcontroller User's Manual for more details.

Pin1 (top): REGC pin of microcontroller
 Pin2 (bottom): GND

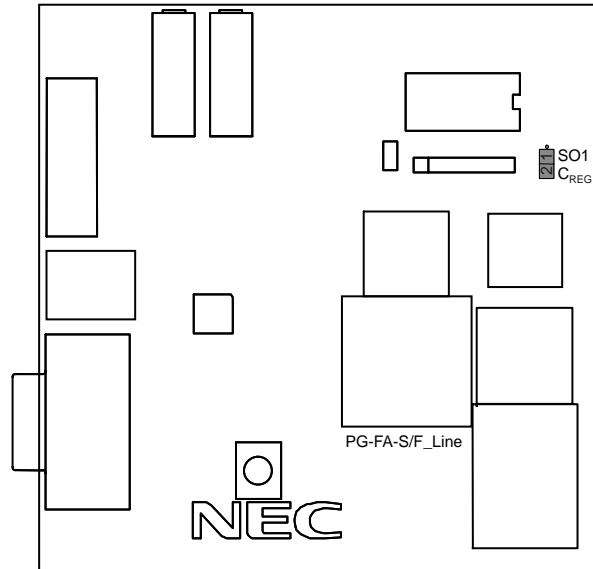

2.4 Clock Sources

A crystal, a resonator or an oscillator (supplied by VDD) can be mounted onto a socket. The clock usually has 5 MHz. The frequency depends on the assembled microcontroller device and its programming mode (usually 2.5 MHz to 5 MHz).

If the UART or USB interface is used for programming, mounting a crystal, resonator or oscillator is mandatory.

A jumper selects the source of the clock: on-board crystal or external clock from PG-FP4 or oscillator.

Table 2-5: Clock Source Selection

JP1	Clock source
Open (default)	Crystal, resonator or PG-FP4
Closed	Oscillator

Table 2-6: Possible Clock Sources

Programming source	Clock source		
	Crystal or resonator	Oscillator	PG-FP4
PG-FP4	Yes	Yes	Yes
UART	Yes	Yes	No
USB	Yes	Yes	No

Table 2-7: Clock Priorities

Priority	Clock source
Highest	PG-FP4
Medium	Oscillator
Lowest	Crystal or resonator

Note: When choosing an incorrect clock source or supplying multiple clocks simultaneously programming may fail. However no harm to the device or the flash adapter should occur.

2.4.1 Oscillator socket

If an oscillator should be used as the clock source for the microcontroller device, it must be assembled in SO3. For this clock source jumper JP1 must be closed.

DIL14 and DIL8-type oscillators can be assembled. When assembling DIL8-type oscillators align pin 1 of the oscillator with pin 1 of the socket.

- Notes:**
1. The oscillator is supplied by V_{DD} (range: 2.85 V to 5.5 V), so be sure it supports this voltage.
 2. Pin 1 has a pull-up of 4.7 K to V_{DD} in case oscillators with /OE on pin 1 are used.

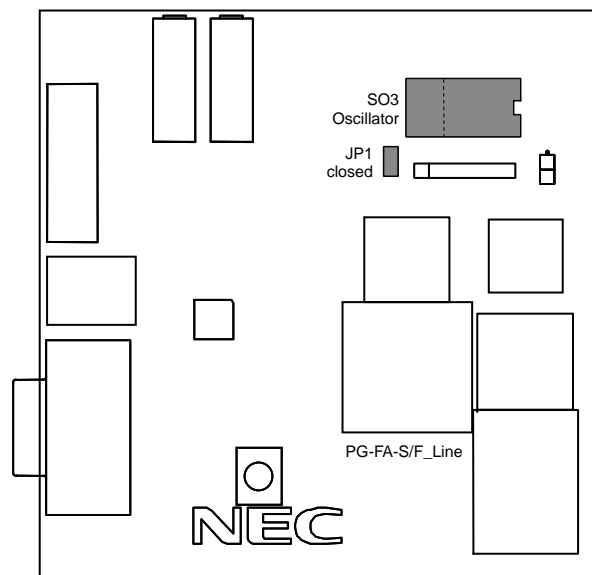

2.4.2 Crystal / resonator socket

If a crystal or a resonator should be used as the clock source for the microcontroller device, it must be assembled in SO2. For this clock source jumper JP1 must be open.

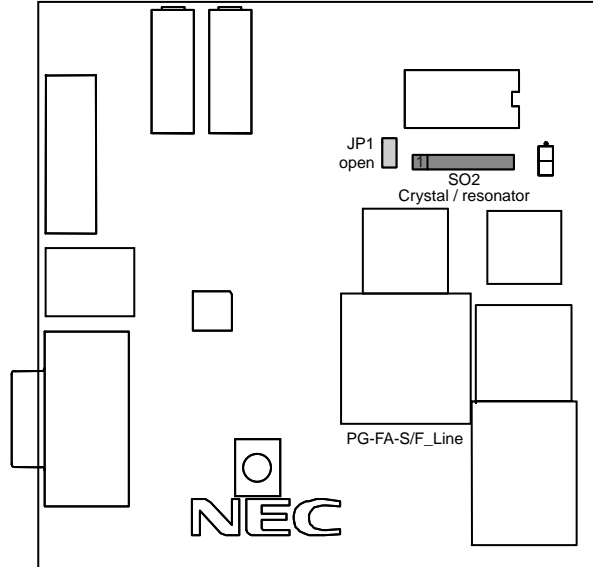

Table 2-8: SO2 Pinout

Pin	Signal	Intended usage
1	GND	
2	X1	
3	X1	
4	GND	
5	X2	
6	X2	
7	GND	

2.5 Device Sockets (for Mount Adapters)

The microcontrollers that are to be programmed must be enclosed in a mount adapter and then placed on one of the five foreseen spots on the PG-FA-S/F_Line.

- Cautions:**
1. Do not place or remove a mount adapter while the board is powered. This may damage the microcontroller device.
 2. Never mount more than one mount adapter at the same time. This may damage the microcontroller devices.

2.5.1 Device socket for V850ES/FE2 (64-pin)

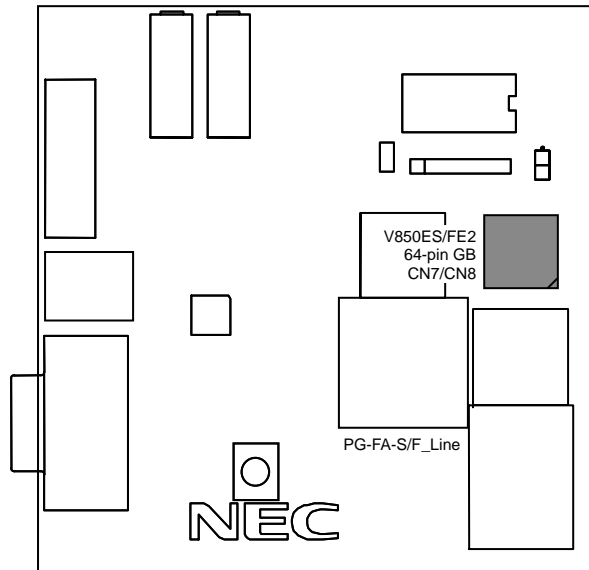

2.5.2 Device socket for V850ES/FF2 (80-pin)

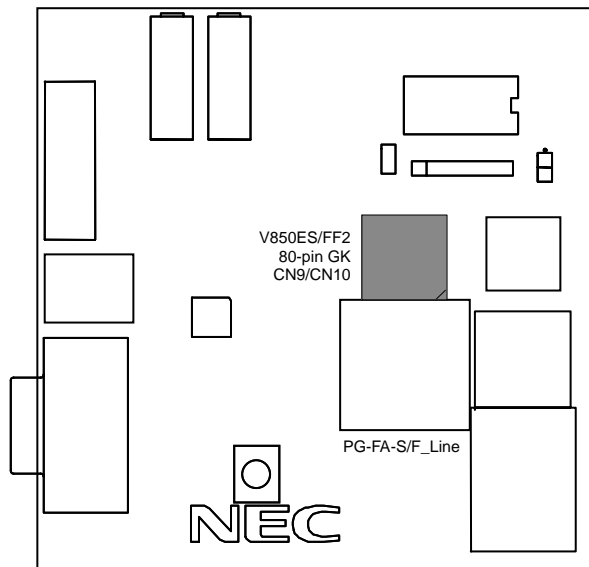

2.5.3 Device socket for V850ES/SG2 and V850ES/FG2 (100-pin, square)

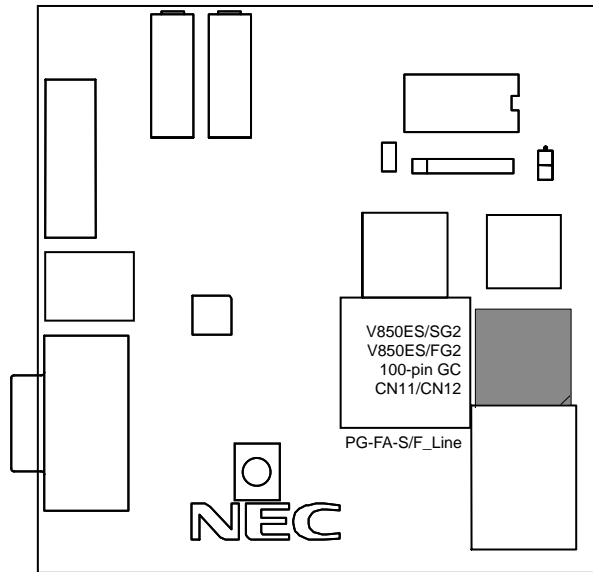

Caution: The receptacles for the 100-pin square and 100-pin rectangular mount adapters have the same appearance and geometry. It is physically possible to place the mount adapter into the wrong receptable. This can damage the microcontroller or the PF-FA-S/F_Line. A mechanical blocking (TP1) should prevent a 100-pin rectangular mount adapter to be placed into the 100-pin square receptable. But it is possible to place a 100-pin square mount adapter into the 100-pin rectangular receptable. Please take care not to mix up the receptables.

2.5.4 Device socket for V850ES/SG2 (100-pin, rectangular)

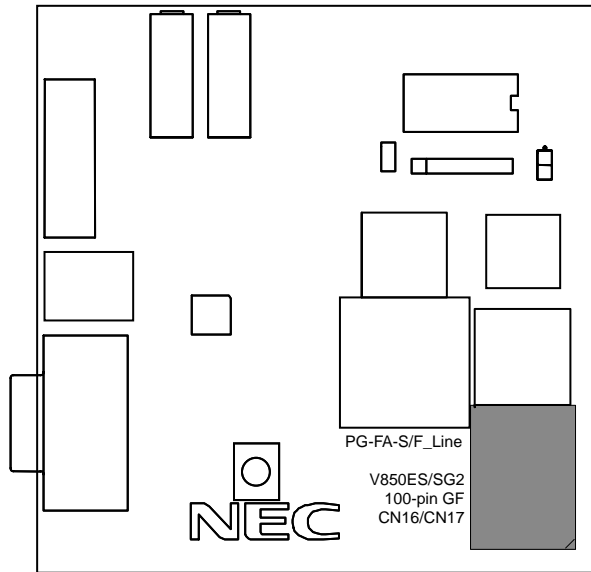

Caution: The receptacles for the 100-pin square and 100-pin rectangular mount adapters have the same appearance and geometry. It is physically possible to place the mount adapter into the wrong receptable. This can damage the microcontroller or the PF-FA-S/F_Line. A mechanical blocking (TP1) should prevent a 100-pin rectangular mount adapter to be placed into the 100-pin square receptable. But it is possible to place a 100-pin square mount adapter into the 100-pin rectangular receptable. Please take care not to mix up the receptables.

2.5.5 Device socket for V850ES/SJ2 and V850ES/FJ2 (144-pin)

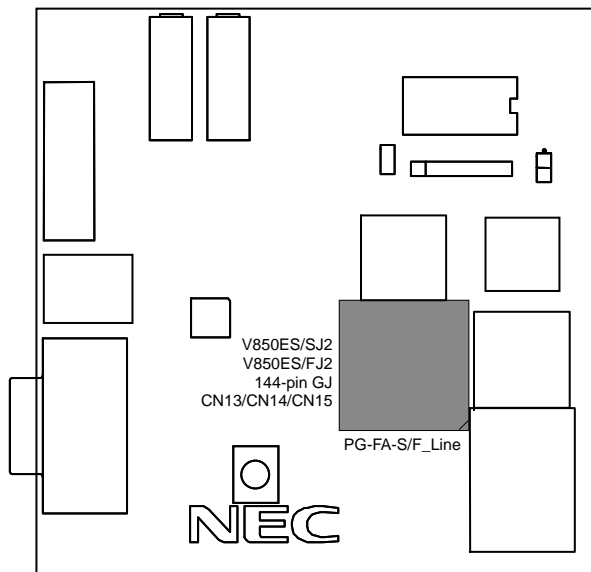

2.6 Reset Button

The microcontroller device can be reset by pressing the reset button. Depending on the setting of the Serial Writer software, this might be necessary during programming. Usually, however, this is not necessary.

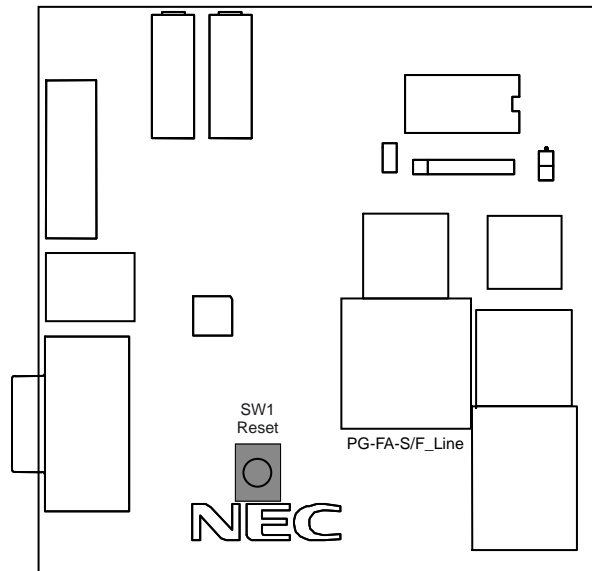

2.7 LEDs

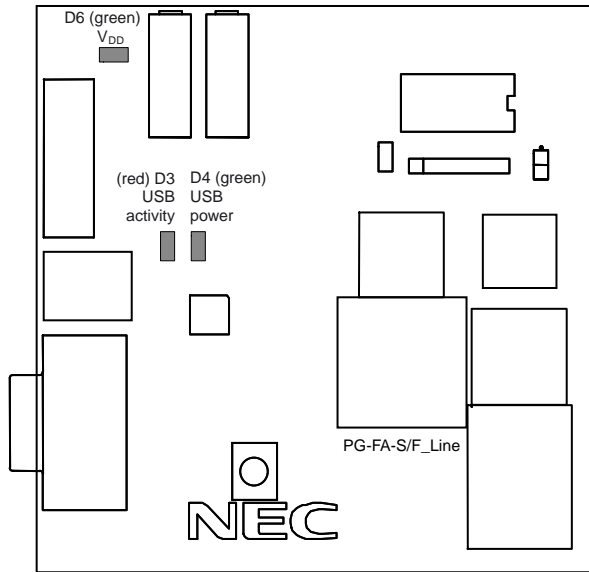

2.7.1 V_{DD} power LED

This green LED lights when V_{DD} is present at the microcontroller. It lights when any power supply is attached (PG-FP4, USB and ext. power supply).

2.7.2 USB power LED

This green LED lights when the USB port is connected and powered.

2.7.3 USB activity LED

This red LED will light when there is activity (send or receive) on the USB bus.

Chapter 3 Supported Devices and Mount Adapters

Table 3-1: Supported Mount Adapters

	S-Line	F-Line
64-pin GB	-	QB-64GB-MA-01S (QB-V850ESFX2-S64GB)
80-pin GC	-	QB-80GK-MA-01S (QB-V850ESFX2-S80GK)
100-pin GC	QB-100GF-MA-01S (QB-V850ESSX2-S100GC)	QB-100GC-MA-01S (QB-V850ESFX2-S100GC)
100-pin GF	QB-100GF-MA-01S (QB-V850ESSX2-S100GF)	-
144-pin GJ	QB-144GJ-MA-01S (QB-V850ESSX2-S144GJ)	QB-144GJ-MA-01S (QB-V850ESFX2-S144GJ)

Table 3-2: Supported Devices

	S-Line	F-Line
64-pin GB	-	μPD3231MXGB(A)-YEN μPD3231MXGB(A1)-YEN
80-pin GC	-	μPD3232MXGK(A)-9EU μPD3232MXGK(A1)-9EU μPD3233MXGK(A)-9EU μPD3233MXGK(A1)-9EU
100-pin GC	μPD70F3261GC-8EU μPD70F3261YGC-8EU μPD70F3263GC-8EU μPD70F3263YGC-8EU μPD70F3281GC-8EU μPD70F3281YGC-8EU μPD70F3281GC-8EU μPD70F3281YGC-8EU	μPD3234MXGC(A)-8EA μPD3234MXGC(A1)-8EA μPD3235MXGC(A)-8EA μPD3235MXGC(A1)-8EA μPD3236MXGC(A)-8EA μPD3236MXGC(A1)-8EA
100-pin GF	μPD70F3261GF-JBT μPD70F3261YGF-JBT μPD70F3263GF-JBT μPD70F3263YGF-JBT μPD70F3281GF-JBT μPD70F3281YGF-JBT μPD70F3281GF-JBT μPD70F3281YGF-JBT	-
144-pin GJ	μPD70F3264GJ-UEN μPD70F3264YGJ-UEN μPD70F3266GJ-UEN μPD70F3266YGJ-UEN μPD70F3284GJ-UEN μPD70F3284YGJ-UEN μPD70F3286GJ-UEN μPD70F3286YGJ-UEN μPD70F3288GJ-UEN μPD70F3288YGJ-UEN	μPD3237MXGJ(A)-UEN μPD3237MXGJ(A1)-UEN μPD3238MXGJ(A)-UEN μPD3238MXGJ(A1)-UEN μPD3239MXGJ(A)-UEN μPD3239MXGJ(A1)-UEN

Chapter 4 Circuit Diagrams

Figure 4-1: Power / Clock

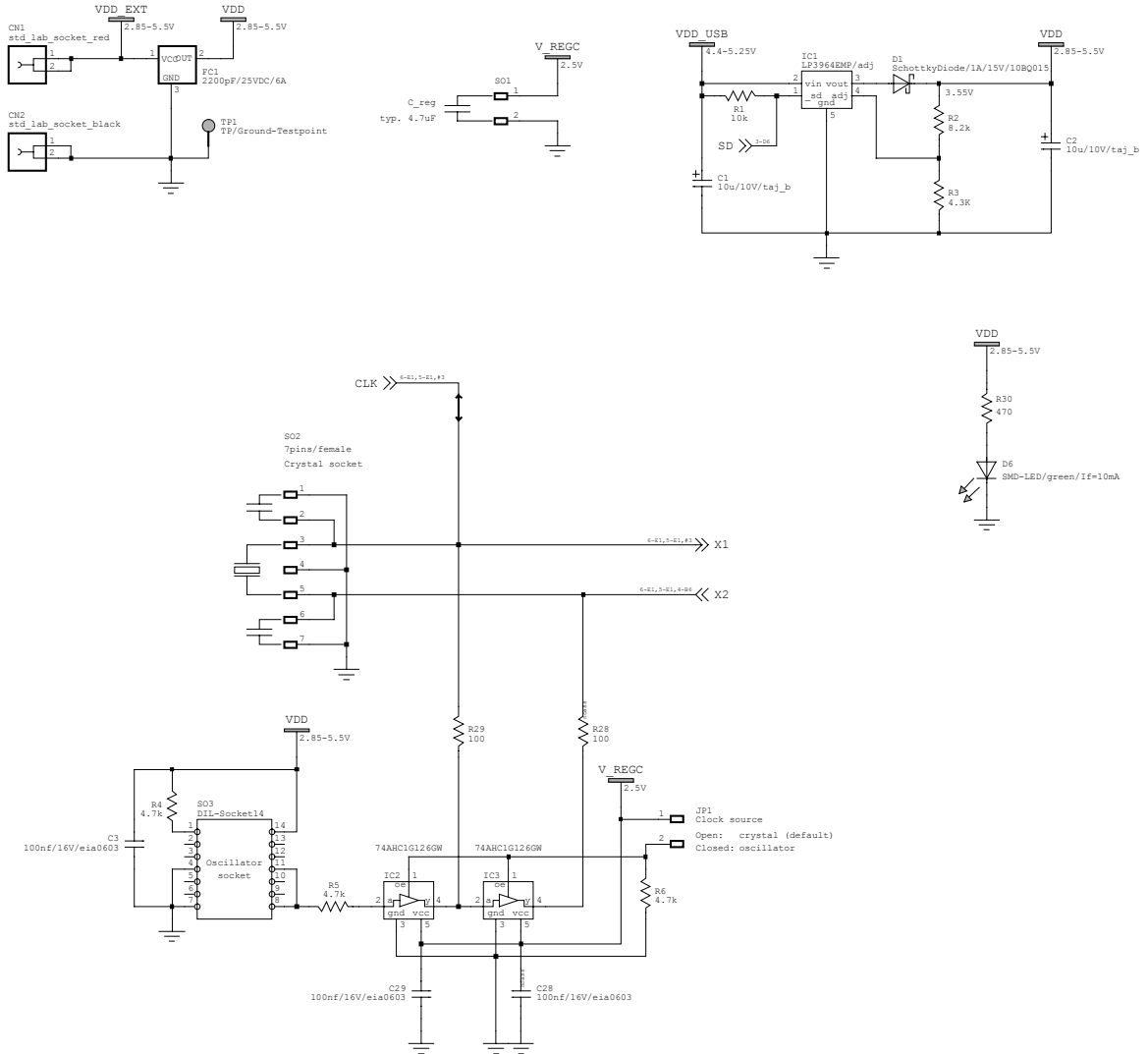

Chapter 4 Circuit Diagrams

Figure 4-2: PG-FP4 Connector / UART / nWire

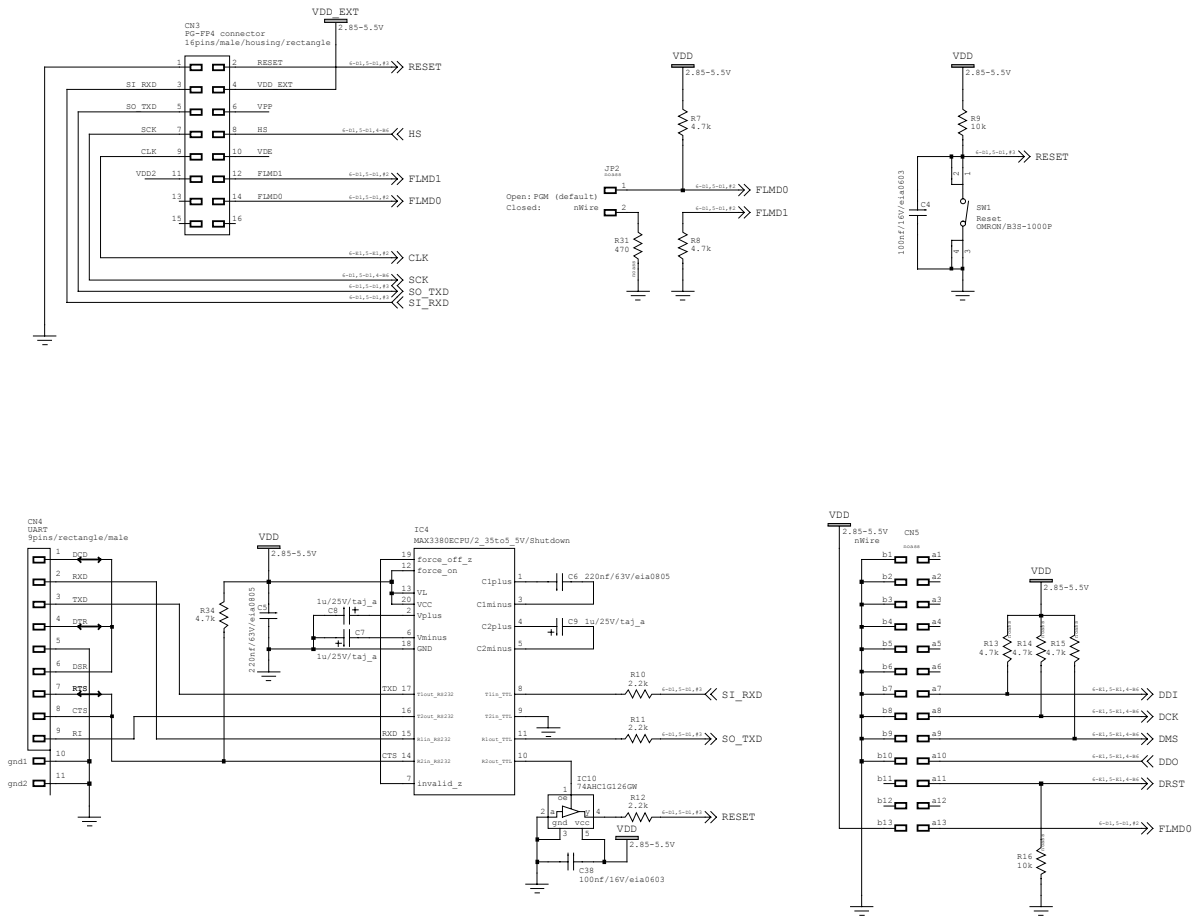

Chapter 4 Circuit Diagrams

Figure 4-3: USB-UART Converter

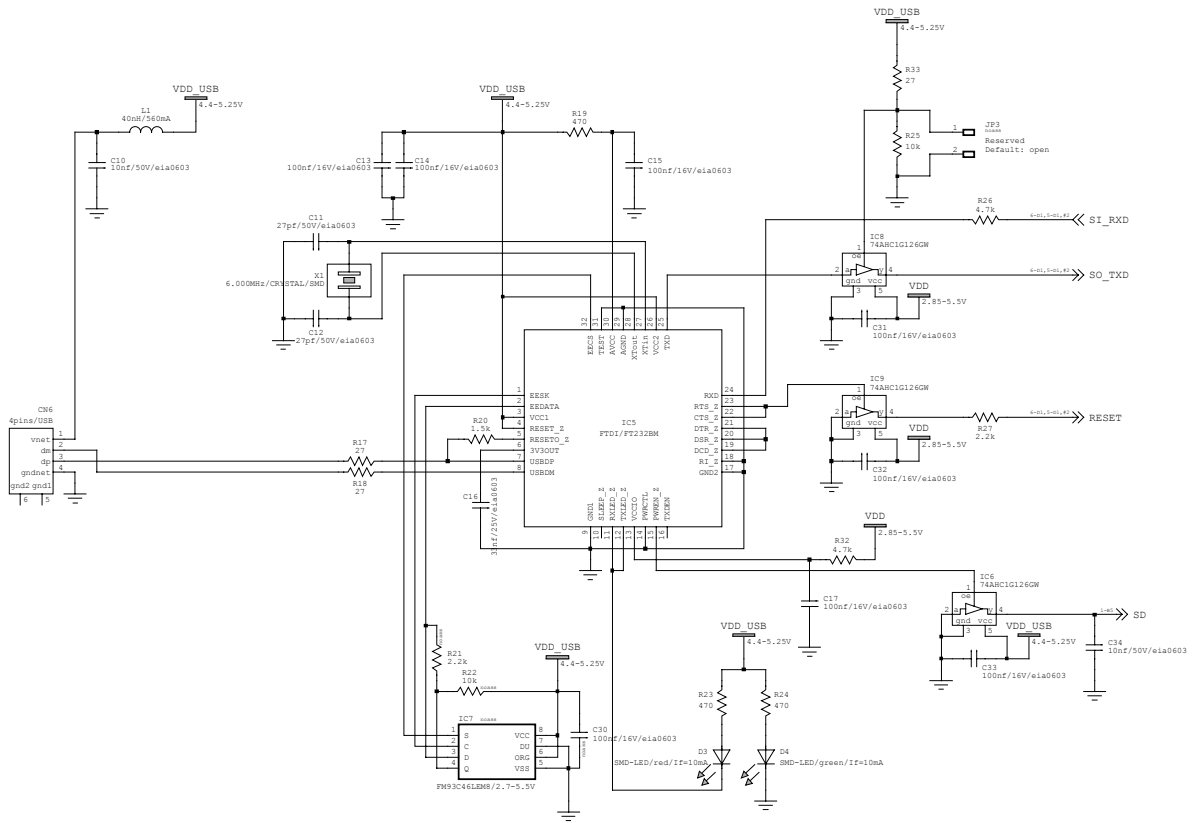
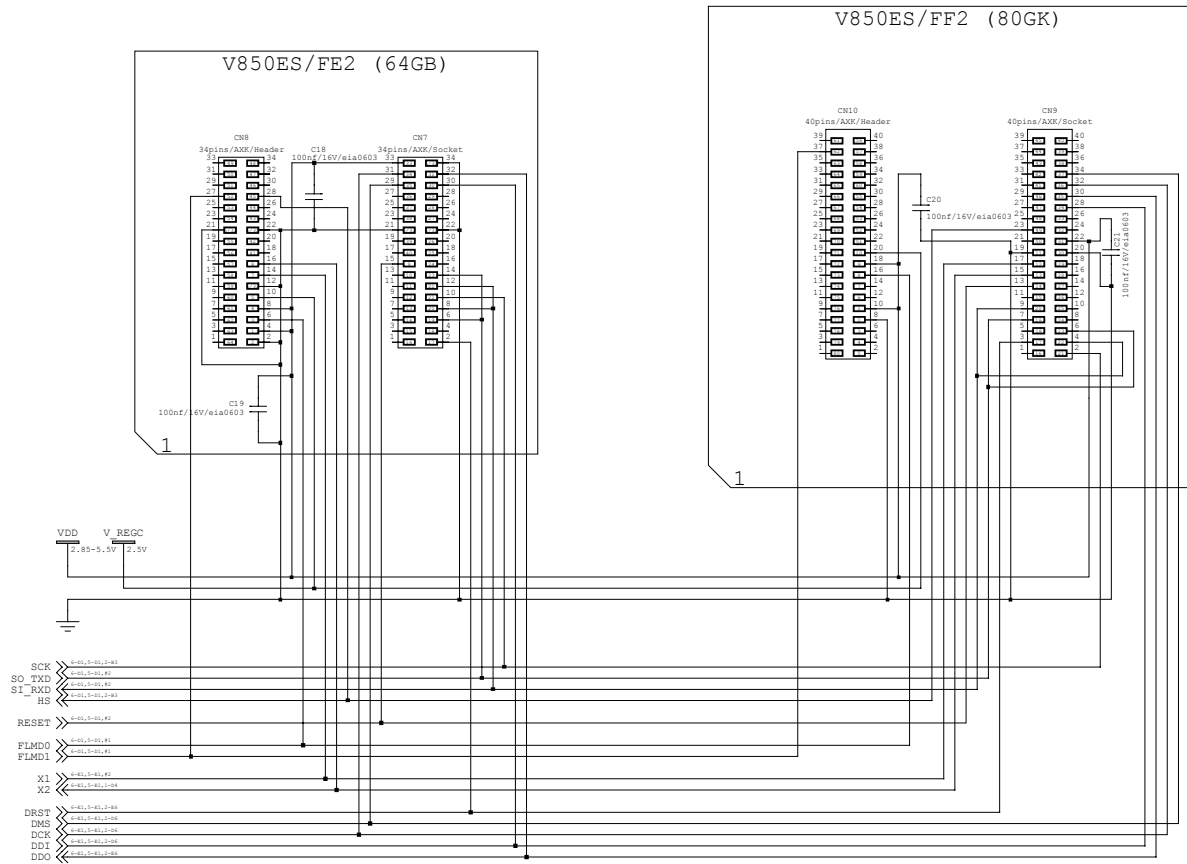

Figure 4-4: Socket Bases 64 / 80



Chapter 4 Circuit Diagrams

Figure 4-5: Socket Bases 100 / 144

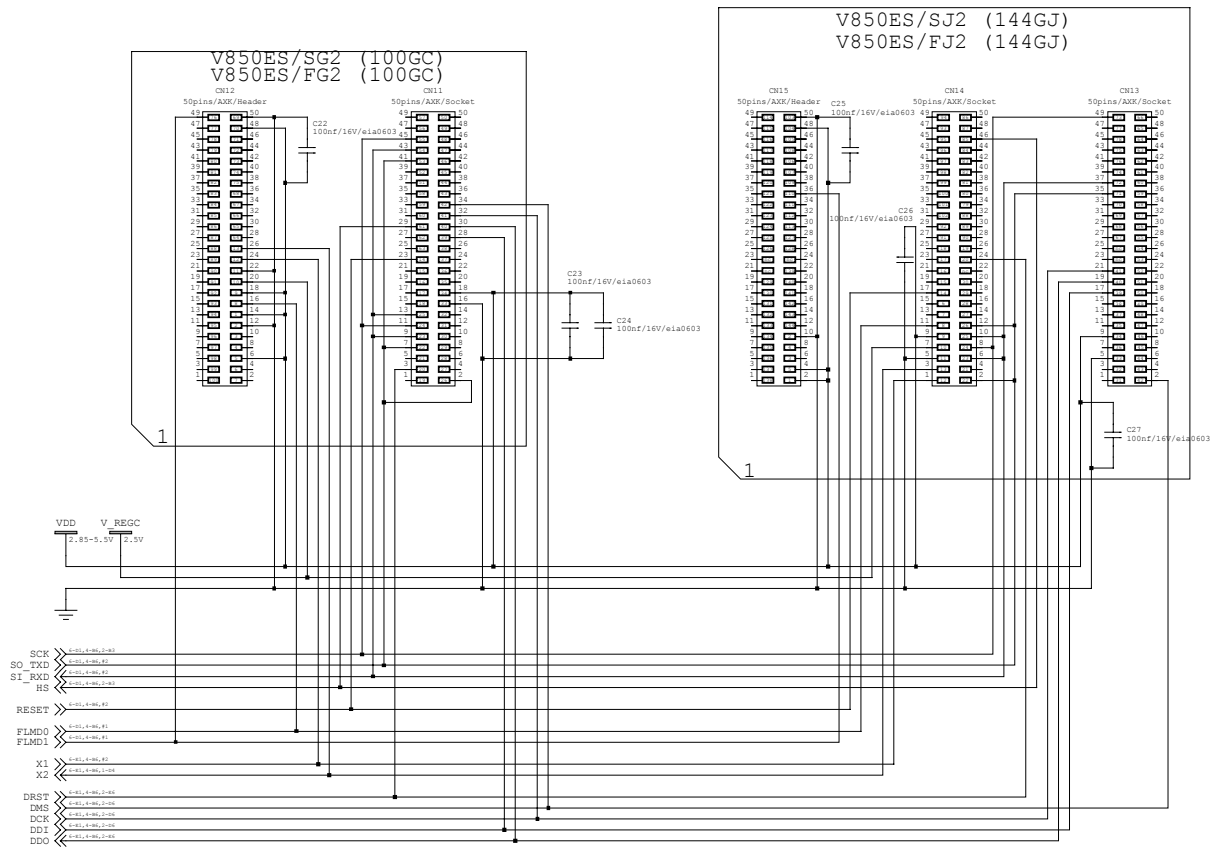
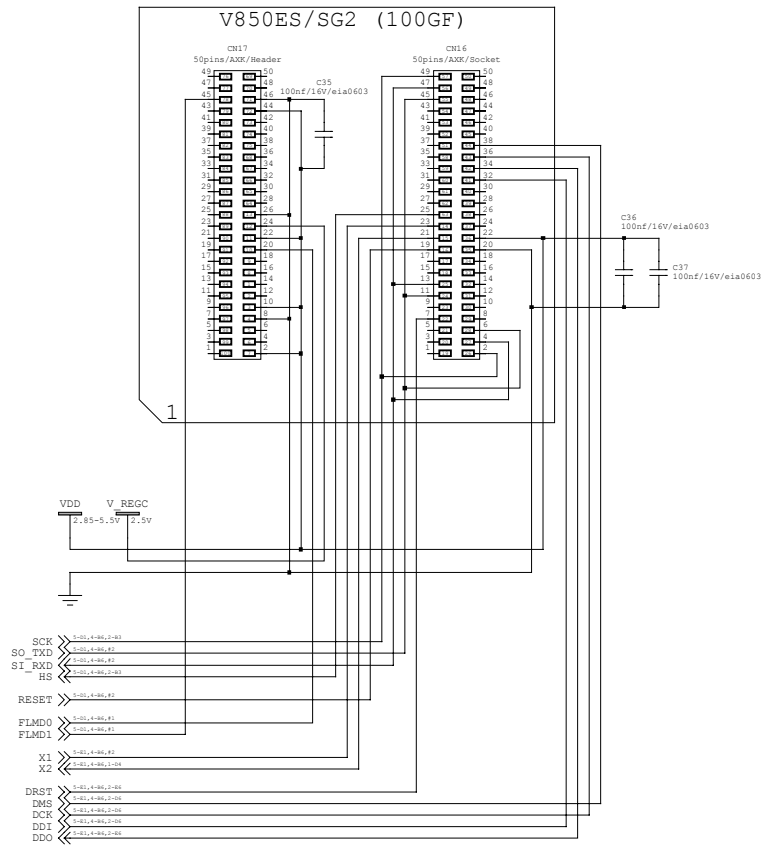

Figure 4-6: Socket Bases 100GF



Facsimile Message

From:

Name

Company

Tel.

FAX

Address

Although NEC has taken all possible steps to ensure that the documentation supplied to our customers is complete, bug free and up-to-date, we readily accept that errors may occur. Despite all the care and precautions we've taken, you may encounter problems in the documentation. Please complete this form whenever you'd like to report errors or suggest improvements to us.

Thank you for your kind support.

North America NEC Electronics America Inc. Corporate Communications Dept. Fax: 1-800-729-9288 1-408-588-6130	Hong Kong, Philippines, Oceania NEC Electronics Hong Kong Ltd. Fax: +852-2886-9022/9044	Asian Nations except Philippines NEC Electronics Singapore Pte. Ltd. Fax: +65-6250-3583
Europe NEC Electronics (Europe) GmbH Market Communication Dept. Fax: +49(0)-211-6503-1344	Korea NEC Electronics Hong Kong Ltd. Seoul Branch Fax: 02-528-4411	Japan NEC Semiconductor Technical Hotline Fax: +81- 44-435-9608
	Taiwan NEC Electronics Taiwan Ltd. Fax: 02-2719-5951	

I would like to report the following error/make the following suggestion:

Document title: _____

Document number: _____ Page number: _____

If possible, please fax the referenced page or drawing.

Document Rating	Excellent	Good	Acceptable	Poor
Clarity	<input type="checkbox"/>	<input type="checkbox"/>	<input type="checkbox"/>	<input type="checkbox"/>
Technical Accuracy	<input type="checkbox"/>	<input type="checkbox"/>	<input type="checkbox"/>	<input type="checkbox"/>
Organization	<input type="checkbox"/>	<input type="checkbox"/>	<input type="checkbox"/>	<input type="checkbox"/>

