

To our customers,

Old Company Name in Catalogs and Other Documents

On April 1st, 2010, NEC Electronics Corporation merged with Renesas Technology Corporation, and Renesas Electronics Corporation took over all the business of both companies. Therefore, although the old company name remains in this document, it is a valid Renesas Electronics document. We appreciate your understanding.

Renesas Electronics website: <http://www.renesas.com>

April 1st, 2010
Renesas Electronics Corporation

Issued by: Renesas Electronics Corporation (<http://www.renesas.com>)

Send any inquiries to <http://www.renesas.com/inquiry>.

Notice

1. All information included in this document is current as of the date this document is issued. Such information, however, is subject to change without any prior notice. Before purchasing or using any Renesas Electronics products listed herein, please confirm the latest product information with a Renesas Electronics sales office. Also, please pay regular and careful attention to additional and different information to be disclosed by Renesas Electronics such as that disclosed through our website.
2. Renesas Electronics does not assume any liability for infringement of patents, copyrights, or other intellectual property rights of third parties by or arising from the use of Renesas Electronics products or technical information described in this document. No license, express, implied or otherwise, is granted hereby under any patents, copyrights or other intellectual property rights of Renesas Electronics or others.
3. You should not alter, modify, copy, or otherwise misappropriate any Renesas Electronics product, whether in whole or in part.
4. Descriptions of circuits, software and other related information in this document are provided only to illustrate the operation of semiconductor products and application examples. You are fully responsible for the incorporation of these circuits, software, and information in the design of your equipment. Renesas Electronics assumes no responsibility for any losses incurred by you or third parties arising from the use of these circuits, software, or information.
5. When exporting the products or technology described in this document, you should comply with the applicable export control laws and regulations and follow the procedures required by such laws and regulations. You should not use Renesas Electronics products or the technology described in this document for any purpose relating to military applications or use by the military, including but not limited to the development of weapons of mass destruction. Renesas Electronics products and technology may not be used for or incorporated into any products or systems whose manufacture, use, or sale is prohibited under any applicable domestic or foreign laws or regulations.
6. Renesas Electronics has used reasonable care in preparing the information included in this document, but Renesas Electronics does not warrant that such information is error free. Renesas Electronics assumes no liability whatsoever for any damages incurred by you resulting from errors in or omissions from the information included herein.
7. Renesas Electronics products are classified according to the following three quality grades: “Standard”, “High Quality”, and “Specific”. The recommended applications for each Renesas Electronics product depends on the product’s quality grade, as indicated below. You must check the quality grade of each Renesas Electronics product before using it in a particular application. You may not use any Renesas Electronics product for any application categorized as “Specific” without the prior written consent of Renesas Electronics. Further, you may not use any Renesas Electronics product for any application for which it is not intended without the prior written consent of Renesas Electronics. Renesas Electronics shall not be in any way liable for any damages or losses incurred by you or third parties arising from the use of any Renesas Electronics product for an application categorized as “Specific” or for which the product is not intended where you have failed to obtain the prior written consent of Renesas Electronics. The quality grade of each Renesas Electronics product is “Standard” unless otherwise expressly specified in a Renesas Electronics data sheets or data books, etc.
 - “Standard”: Computers; office equipment; communications equipment; test and measurement equipment; audio and visual equipment; home electronic appliances; machine tools; personal electronic equipment; and industrial robots.
 - “High Quality”: Transportation equipment (automobiles, trains, ships, etc.); traffic control systems; anti-disaster systems; anti-crime systems; safety equipment; and medical equipment not specifically designed for life support.
 - “Specific”: Aircraft; aerospace equipment; submersible repeaters; nuclear reactor control systems; medical equipment or systems for life support (e.g. artificial life support devices or systems), surgical implantations, or healthcare intervention (e.g. excision, etc.), and any other applications or purposes that pose a direct threat to human life.
8. You should use the Renesas Electronics products described in this document within the range specified by Renesas Electronics, especially with respect to the maximum rating, operating supply voltage range, movement power voltage range, heat radiation characteristics, installation and other product characteristics. Renesas Electronics shall have no liability for malfunctions or damages arising out of the use of Renesas Electronics products beyond such specified ranges.
9. Although Renesas Electronics endeavors to improve the quality and reliability of its products, semiconductor products have specific characteristics such as the occurrence of failure at a certain rate and malfunctions under certain use conditions. Further, Renesas Electronics products are not subject to radiation resistance design. Please be sure to implement safety measures to guard them against the possibility of physical injury, and injury or damage caused by fire in the event of the failure of a Renesas Electronics product, such as safety design for hardware and software including but not limited to redundancy, fire control and malfunction prevention, appropriate treatment for aging degradation or any other appropriate measures. Because the evaluation of microcomputer software alone is very difficult, please evaluate the safety of the final products or system manufactured by you.
10. Please contact a Renesas Electronics sales office for details as to environmental matters such as the environmental compatibility of each Renesas Electronics product. Please use Renesas Electronics products in compliance with all applicable laws and regulations that regulate the inclusion or use of controlled substances, including without limitation, the EU RoHS Directive. Renesas Electronics assumes no liability for damages or losses occurring as a result of your noncompliance with applicable laws and regulations.
11. This document may not be reproduced or duplicated, in any form, in whole or in part, without prior written consent of Renesas Electronics.
12. Please contact a Renesas Electronics sales office if you have any questions regarding the information contained in this document or Renesas Electronics products, or if you have any other inquiries.

(Note 1) “Renesas Electronics” as used in this document means Renesas Electronics Corporation and also includes its majority-owned subsidiaries.

(Note 2) “Renesas Electronics product(s)” means any product developed or manufactured by or for Renesas Electronics.

M306V8T-EPB

User's Manual

Emulation Probe for M16C/60 Series M16C/6V
Group M306V8

Keep safety first in your circuit designs!

1. Renesas Technology Corp. puts the maximum effort into making semiconductor products better and more reliable, but there is always the possibility that trouble may occur with them. Trouble with semiconductors may lead to personal injury, fire or property damage. Remember to give due consideration to safety when making your circuit designs, with appropriate measures such as (i) placement of substitutive, auxiliary circuits, (ii) use of non-flammable material or (iii) prevention against any malfunction or mishap.

Notes regarding these materials

1. These materials are intended as a reference to assist our customers in the selection of the Renesas Technology Corp. product best suited to the customer's application; they do not convey any license under any intellectual property rights, or any other rights, belonging to Renesas Technology Corp. or a third party.
2. Renesas Technology Corp. assumes no responsibility for any damage, or infringement of any third-party's rights, originating in the use of any product data, diagrams, charts, programs, algorithms, or circuit application examples contained in these materials.
3. All information contained in these materials, including product data, diagrams, charts, programs and algorithms represents information on products at the time of publication of these materials, and are subject to change by Renesas Technology Corp. without notice due to product improvements or other reasons. It is therefore recommended that customers contact Renesas Technology Corp. or an authorized Renesas Technology Corp. product distributor for the latest product information before purchasing a product listed herein. The information described here may contain technical inaccuracies or typographical errors. Renesas Technology Corp. assumes no responsibility for any damage, liability, or other loss rising from these inaccuracies or errors. Please also pay attention to information published by Renesas Technology Corp. by various means, including the Renesas Technology Corp. Semiconductor home page (<http://www.renesas.com>).
4. When using any or all of the information contained in these materials, including product data, diagrams, charts, programs, and algorithms, please be sure to evaluate all information as a total system before making a final decision on the applicability of the information and products. Renesas Technology Corp. assumes no responsibility for any damage, liability or other loss resulting from the information contained herein.
5. Renesas Technology Corp. semiconductors are not designed or manufactured for use in a device or system that is used under circumstances in which human life is potentially at stake. Please contact Renesas Technology Corp. or an authorized Renesas Technology Corp. product distributor when considering the use of a product contained herein for any specific purposes, such as apparatus or systems for transportation, vehicular, medical, aerospace, nuclear, or undersea repeater use.
6. The prior written approval of Renesas Technology Corp. is necessary to reprint or reproduce in whole or in part these materials.
7. If these products or technologies are subject to the Japanese export control restrictions, they must be exported under a license from the Japanese government and cannot be imported into a country other than the approved destination. Any diversion or reexport contrary to the export control laws and regulations of Japan and/ or the country of destination is prohibited.
8. Please contact Renesas Technology Corp. for further details on these materials or the products contained therein.

Preface

The M306V8T-EPB is an emulation probe for M16C/60 Series M16C/6V Group M306V8. The M306V8T-EPB is used by connecting to the PC7501 emulator main unit.

This user's manual mainly describes specifications of the M306V8T-EPB emulation probe and how to setup it. For details on the following products, which are used with the M306V8T-EPB, refer to each product's user's manual.

All the components of this product are shown in "1.1 Package components" (page 13). If there is any question or doubt about this product, contact your local distributor.

The related manuals for using this product are listed below. You can download the latest manuals from the Renesas Tools homepage (<http://www.renesas.com/en/tools>).

Related manuals

Item	Manual
Emulator main unit	PC7501 User's Manual
Integrated development environment	High-performance Embedded Workshop User's Manual
Emulator debugger	M16C R8C PC7501 Emulator debugger User's Manual
	M3T-PD30F User's Manual
C compiler	C compiler package for R8C/Tiny, M16C/60, 30, 20, 10 and Tiny Series Compiler User's Manual
Assembler	C compiler package for R8C/Tiny, M16C/60, 30, 20, 10 and Tiny Series Assembler User's Manual

Important

Before using this product, be sure to read this user's manual carefully.

Keep this user's manual, and refer to this when you have questions about this product.

Emulator:

The emulator in this document refers to the following products that are manufactured by Renesas Technology Corp.:

- (1) PC7501 main unit
- (2) Emulation probe
- (3) Package converter board for connecting the user system

The emulator herein does not include the customer's user system and host machine.

Purpose of use of the emulator:

This emulator is a device to support the development of a system that uses the M16C Family M16C/60 Series M16C/6V Group M306V8 of Renesas 16-bit single-chip MCUs. It provides support for system development in both software and hardware.

Be sure to use this emulator correctly according to said purpose of use. Please avoid using this emulator for other than its intended purpose of use.

For those who use this emulator:

This emulator can only be used by those who have carefully read the user's manual and know how to use it.

Use of this emulator requires the basic knowledge of electric circuits, logical circuits, and MCUs.

When using the emulator:

- (1) This product is a development supporting unit for use in your program development and evaluation stages. In mass-producing your program you have finished developing, be sure to make a judgment on your own risk that it can be put to practical use by performing integration test, evaluation, or some experiment else.
- (2) In no event shall Renesas Solutions Corp. be liable for any consequence arising from the use of this product.
- (3) Renesas Solutions Corp. strives to renovate or provide a workaround for product malfunction at some charge or without charge. However, this does not necessarily mean that Renesas Solutions Corp. guarantees the renovation or the provision under any circumstances.
- (4) This product has been developed by assuming its use for program development and evaluation in laboratories. Therefore, it does not fall under the application of Electrical Appliance and Material Safety Law and protection against electromagnetic interference when used in Japan.
- (5) Renesas Solutions Corp. cannot predict all possible situations or possible cases of misuse where a potential danger exists. Therefore, the warnings written in this user's manual and the warning labels attached to this emulator do not necessarily cover all of such possible situations or cases. Please be sure to use this emulator correctly and safely on your own responsibility.
- (6) This product is not qualified under UL or other safety standards and IEC or other industry standards. This fact must be taken into account when taking this product from Japan to some other country.

Usage restrictions:

This emulator has been developed as a means of supporting system development by users. Therefore, do not use it as a device used for equipment-embedded applications. Also, do not use it for developing the systems or equipment used for the following purposes either:

- (1) Transportation and vehicular
- (2) Medical (equipment where human life is concerned)
- (3) Aerospace
- (4) Nuclear power control
- (5) Undersea repeater

If you are considering the use of this emulator for one of the above purposes, please be sure to consult your local distributor.

About product changes:

We are constantly making efforts to improve the design and performance of this emulator. Therefore, the specification or design of this emulator or its user's manual may be changed without prior notice.

About the rights:

- (1) We assume no responsibility for any damage or infringement on patent rights or any other rights arising from the use of any information, products or circuits presented in this user's manual.
- (2) The information or data in this user's manual does not implicitly or otherwise grant a license for patent rights or any other rights belonging to us or third parties.
- (3) This user's manual and this emulator are copyrighted, with all rights reserved by us. This user's manual may not be copied, duplicated or reproduced, in whole or part, without prior written consent of us.

About diagrams:

The diagrams in this user's manual may not all represent exactly the actual object.

Precautions for Safety

Definitions of Signal Words

In both the user's manual and on the product itself, several icons are used to insure proper handling of this product and also to prevent injuries to you or other persons, or damage to your properties.

This chapter describes the precautions which should be taken in order to use this product safely and properly. Be sure to read this chapter before using this product.



This symbol represents a warning about safety. It is used to arouse caution about a potential danger that will possibly inflict an injury on persons. To avoid a possible injury or death, please be sure to observe the safety message that follows this symbol.



DANGER indicates an imminently dangerous situation that will cause death or heavy wound unless it is avoided. However, there are no instances of such danger for the product presented in this user's manual.



WARNING indicates a potentially dangerous situation that will cause death or heavy wound unless it is avoided.



CAUTION indicates a potentially dangerous situation that will cause a slight injury or a medium-degree injury unless it is avoided.

CAUTION

CAUTION with no safety warning symbols attached indicates a potentially dangerous situation that will cause property damage unless it is avoided.

IMPORTANT

This is used in operation procedures or explanatory descriptions to convey exceptional conditions or cautions to the user.

In addition to the five above, the following are also used as appropriate.

△ means WARNING or CAUTION.

Example:



CAUTION AGAINST AN ELECTRIC SHOCK

⊘ means PROHIBITION.

Example:



DISASSEMBLY PROHIBITED

● means A FORCIBLE ACTION.

Example:



UNPLUG THE POWER CABLE FROM THE RECEPTACLE.

⚠ WARNING

Warnings for AC Power Supply:



- If the attached AC power cable does not fit the receptacle, do not alter the AC power cable and do not plug it forcibly. Failure to comply may cause electric shock and/or fire.

- Use an AC power cable which complies with the safety standard of the country.

- Do not touch the plug of the AC power cable when your hands are wet. This may cause electric shock.

- This product is connected signal ground with frame ground. If your developing product is transformless (not having isolation transformer of AC power), this may cause electric shock. Also, this may give an unreparable damage to this product and your developing one.

While developing, connect AC power of the product to commercial power through isolation transformer in order to avoid these dangers.

- If other equipment is connected to the same branch circuit, care should be taken not to overload the circuit.



- When installing this equipment, insure that a reliable ground connection is maintained.



- If you smell a strange odor, hear an unusual sound, or see smoke coming from this product, then disconnect power immediately by unplugging the AC power cable from the outlet.

Do not use this as it is because of the danger of electric shock and/or fire. In this case, contact your local distributor.

- Before setting up this emulator and connecting it to other devices, turn off power or remove a power cable to prevent injury or product damage.

Warnings to Be Taken for This Product:



- Do not disassemble or modify this product. Personal injury due to electric shock may occur if this product is disassembled and modified. Disassembling and modifying the product will void your warranty.

- Make sure nothing falls into the cooling fan on the top panel, especially liquids, metal objects, or anything combustible.

Warning for Installation:



- Do not set this product in water or areas of high humidity. Make sure that the product does not get wet. Spilling water or some other liquid into the product may cause unreparable damage.

Warning for Use Environment:



- This equipment is to be used in an environment with a maximum ambient temperature of 35°C. Care should be taken that this temperature is not exceeded.

 **CAUTION****Cautions to Be Taken for Turning On the Power:**

- Turn ON/OFF the power of the emulator and user system as simultaneously as possible.
- Do not leave either the emulator or user system powered on, because of leakage current the internal circuits may be damaged.
- When turning on the power again after shutting off the power, wait about 10 seconds.

Cautions to Be Taken for Handling This Product:

- Use caution when handling the main unit. Be careful not to apply a mechanical shock.
- Do not touch the connector pins of the emulator main unit and the target MCU connector pins directly. Static electricity may damage the internal circuits.
- Do not pull this emulator by the communications interface cable or the flexible cable for connecting the user system. And, excessive flexing or force may break conductors.
- Do not flex the flexible cable for connecting to the emulator main unit and emulation probe excessively. The cable may cause a break.
- Do not use inch-size screws for this equipment. The screws used in this equipment are all ISO (metric-size) type screws. When replacing screws, use same type screws as equipped before.

Caution to Be Taken for System Malfunctions:

- If the emulator malfunctions because of interference like external noise, do the following to remedy the trouble.
 - (1) Press the RESET button on the emulator front panel.
 - (2) If normal operation is not restored after step (1), shut OFF the emulator once and then reactivate it.

Caution to Be Taken for External Trigger Input Voltage:

- Keep an external trigger input voltage of the emulator main unit less than a V_{cc2} voltage. Overvoltage may cause damage to the internal circuits.

Contents

	Page
Preface.....	3
Important.....	4
Precautions for Safety	6
Contents.....	9
User Registration	11
Terminology	12
1. Outline.....	13
1.1 Package Components	13
1.2 Other Tool Products Required for Development	14
1.3 System Configuration	15
1.3.1 System Configuration	15
1.3.2 Names and Functions of the PC7501 Upper Panel LEDs	16
1.4 Specifications	18
1.5 Operating Environment.....	19
2. Setup.....	20
2.1 Flowchart of Starting Up the Emulator	20
2.2 Installing the Emulator Debugger (Renesas Debugger Package for M16C)	21
2.2.1 Installing the Emulator Debugger.....	21
2.3 Connecting the Host Machine	22
2.4 Connecting the PC7501	23
2.5 Connecting the Power Supply for the Emulator	24
2.6 Turning ON the Power.....	25
2.6.1 Checking the Connections of the Emulator System.....	25
2.6.2 Turning ON/OFF the Power	25
2.6.3 LED Display When the Emulator Starts Up Normally	26
2.7 Downloading Firmware.....	27
2.7.1 When It is Necessary to Download Firmware	27
2.7.2 Downloading Firmware in Maintenance Mode.....	27
2.8 Self-check	28
2.8.1 Self-check Procedure	28
2.8.2 If an Error is Detected in the Self-check.....	29
2.9 Connecting the User System.....	30
2.9.1 Connecting the User System	31
2.10 Switch Settings	32
2.10.1 Setting Switches of Emulation Probe	32
2.10.2 Writing Data to the OSDROM	36
2.10.3 Pullup of Emulation Ports.....	37
2.11 Selecting Clock Supply.....	38
2.11.1 Clocks.....	38
2.11.2 Using an Internal Oscillator Circuit Board	38
2.11.3 Using the Oscillator Circuit on the User System	42
2.11.4 Using the Internal Generator Circuit.....	42

	Page
3. Usage (How to Use the Emulator Debugger)	43
3.1 Starting Up the Emulator Debugger	43
3.1.1 INIT Dialog Box	43
3.1.2 MCU Setting Dialog Box	48
3.1.3 Checking Connections of the Emulator System	51
3.2 Editor (Source) Window	52
3.3 Hardware Breakpoint Setting Window	55
3.4 Trace Window	60
3.5 RAM Monitor Window	63
4. Hardware Specifications	64
4.1 Target MCU Specifications	64
4.2 Access Timing	65
4.2.1 Operation Timing of Memory Expansion Mode and Microprocessor Mode (Vcc1=Vcc2=Vcc3=3.3V)	65
4.3 Differences between the Actual MCU and Emulator	70
4.4 Connection Diagrams	73
4.5 External Dimensions	75
4.5.1 External Dimensions of the Emulation Probe	75
4.5.2 External Dimensions of the M306V8T-PTC	76
4.6 Notes on Using This Product	77
5. Troubleshooting	82
5.1 Flowchart to Remedy the Troubles	82
5.2 When the Emulator Debugger Does Not Start Up Properly	83
5.3 How to Request for Support	86
6. Maintenance and Guarantee	87
6.1 User Registration	87
6.2 Maintenance	87
6.3 Guarantee	87
6.4 Repair Provisions	87
6.5 How to Make Request for Repair	88

User Registration

When you have purchased the emulator presented in this user's manual, please be sure to register it. As the hardware tool user registration FAX sheet is included with this manual, fill it in and FAX it to your local distributor or email the same contents to the following address. Your registered information is used for only after-sale services, and not for any other purposes. Without user registration, you will not be able to receive maintenance services such as a notification of field changes or trouble information. So be sure to carry out the user registration.

For more information about user registration, please email to the following address.

regist_tool@renesas.com

Terminology

Some specific words used in this user's manual are defined as follows:

Emulator system

This means an emulator system built around the PC7501 emulator. The PC7501 emulator system is configured with an emulator main unit, emulation probe, host machine and the integrated development environment High-performance Embedded Workshop.

Emulator main unit (Hereafter PC7501)

This means an emulator main unit for M16C Family.

Emulation probe

This means the emulation probe (this product) for the M16C Family M16C/60 Series M16C/6V Group M306V8 MCUs.

Integrated development environment High-performance Embedded Workshop

This tool provides powerful support for the development of embedded applications for Renesas microcomputers. It has an emulator debugger function allowing for the emulator and emulation probe to be controlled from the host machine via an interface. Furthermore, it permits a range of operations from editing a project to building and debugging it to be performed within the same application. What's more, it supports version management.

Emulator debugger

This means a software tool starting up from the High-performance Embedded Workshop to control the emulator and this product and enables debugging.

Firmware

Program that analyzes contents of communication with the emulator debugger and controls the emulator hardware. This program is installed in the flash memory in the emulator main unit. This program is downloadable from the emulator debugger to upgrade the firmware or to support other MCUs.

Host machine

This means a personal computer used to control the emulator main unit and emulation probe.

Software break

A software break is a function to break the program before the system executes an instruction at the specified address. The instruction at the preset address will not be executed.

Hardware break

A hardware break is a function to break the program when the system detects a write/read of data to/from memory or a leading/trailing edge of the signal entered from the external trace cable. The former break function is called address break; and the latter break function is called trigger break. While the instruction at the address where the software break is set is not executed, a hardware break is performed after the specified instruction is executed.

Target MCU

This means the MCU you are going to debug.

User system

This means a user's application system using the microcomputer to be debugged.

User program

This means the program you are going to debug.

Evaluation MCU

This means the MCU mounted on the emulation probe which is operated in the specific mode for tools.

*

In this user's manual, this symbol is used to show active Low. (e.g. RESET*: Reset signal)

1. Outline

This chapter describes the package components, the system configuration, the specifications of the emulator functions and the operating environment.

1.1 Package Components

The M306V8T-EPB package consists of the following items. When unpacking it, check to see if your M306V8T-EPB contains all of these items.

Table 1.1 Package components

Item	Quantity
M306V8T-EPB emulation probe	1
M306V8T-PTC (pre-mounted) converter board for 116-pin 0.65-mm-pitch LQFP	1
NQPACK116SB, YQPACK116SB and YQ-GUIDE(x4) for connecting the M306V8T-PTC and user system	1
OSC-3 (16MHz) oscillator circuit board	1
OSC-2 oscillator circuit bare board	1
Network registers for ports P0--P5 pullup (51kΩ x 8)	6
Hardware tool user registration FAX sheet (English)	1
Hardware tool user registration FAX sheet (Japanese)	1
M306V8T-EPB User's Manual (this manual)	1
M306V8T-EPB User's Manual (Japanese)	1
M306V8T-EPB Supplementary Document (English)	1
M306V8T-EPB Supplementary Document (Japanese)	1

- * Please keep the M306V8T-EPB's packing box and cushion material in your place for reuse at a later time when sending your product for repair or other purposes. Always use these packing box and cushion material when transporting this product.
- * If there is any question or doubt about the packaged product, contact your local distributor.
- * NQPACK116SB, YQPACK116SB and YQ-GUIDE are trademarks of Tokyo Eletech Corporation. For purchasing or technical information, contact your local distributor.

1.2 Other Tool Products Required for Development

To bring forward programs development on an M16C/60 Series of the M16C/6V Group M306V8 MCUs, the products listed below are necessary in addition to those contained package above. Get them separately.

Table 1.2 Other tool products required for development

Product	Product name
Emulator main unit	PC7501
Emulator debugger	Renesas Debugger Package for M16C Family
	M3T-PD30

* For purchasing these products, contact your local distributor.

1.3 System Configuration

1.3.1 System Configuration

Figure 1.1 shows a configuration of the M306V8T-EPB system.

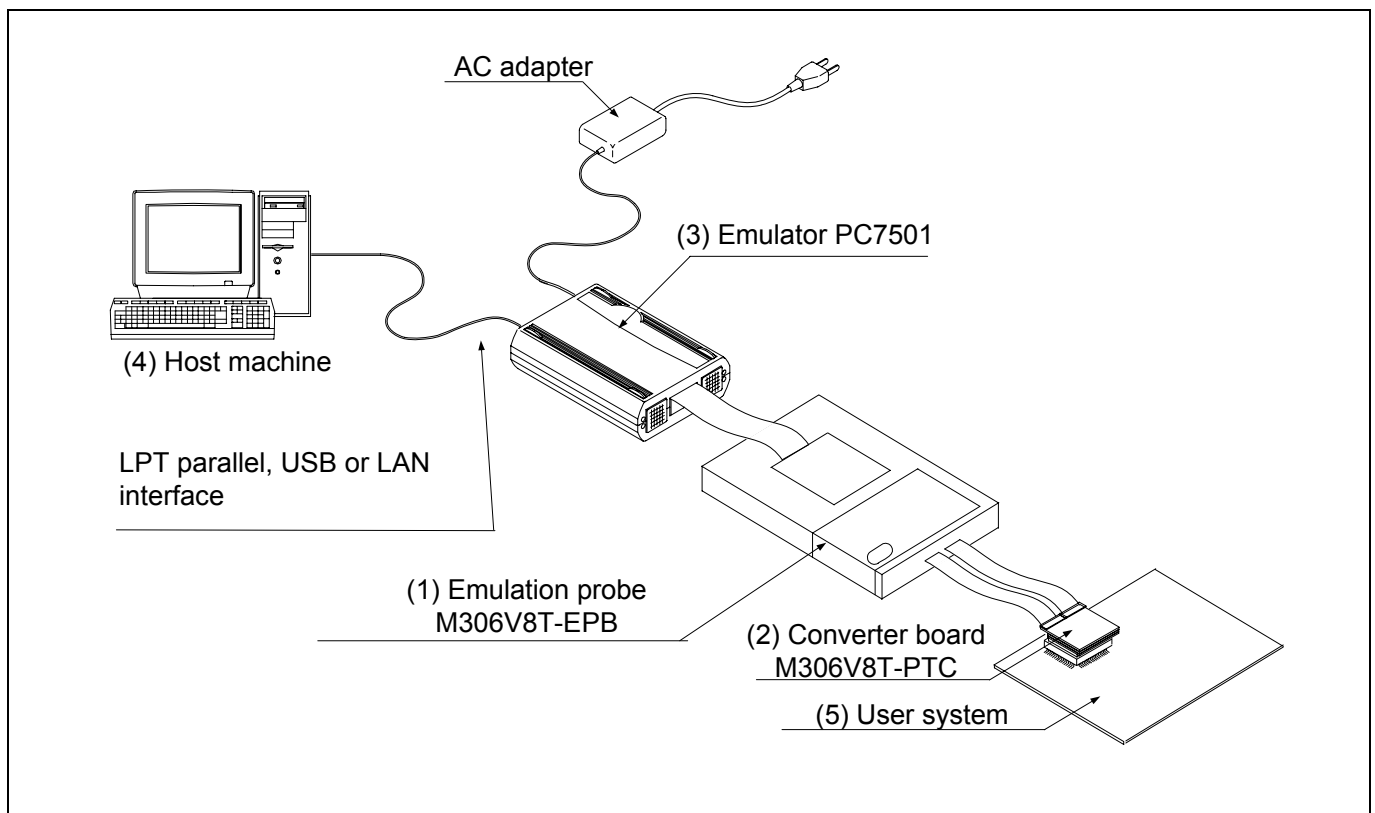

Figure 1.1 System configuration

(1) Emulation probe M306V8T-EPB

This is an emulation probe for the M16C/60 Series M16C/6V Group M306V8 MCUs and contains an evaluation MCU.

(2) Converter board M306V8T-PTC

This is a converter board for connecting to 116-pin 0.65-mm-pitch LQFP foot pattern on the user system. For details, refer to "2.9 Connecting the User System" (page 30).

(3) Emulator main unit PC7501

The emulator main unit for the M16C family to be used with this product.

(4) Host machine

A personal computer to control the emulator.

(5) User system

This is your application system.

This emulator cannot supply the power to the user system. Therefore design your system so that the user system is powered separately.

1.3.2 Names and Functions of the PC7501 Upper Panel LEDs

Figure 1.2 shows the names of the LEDs on the upper panel of the emulator.

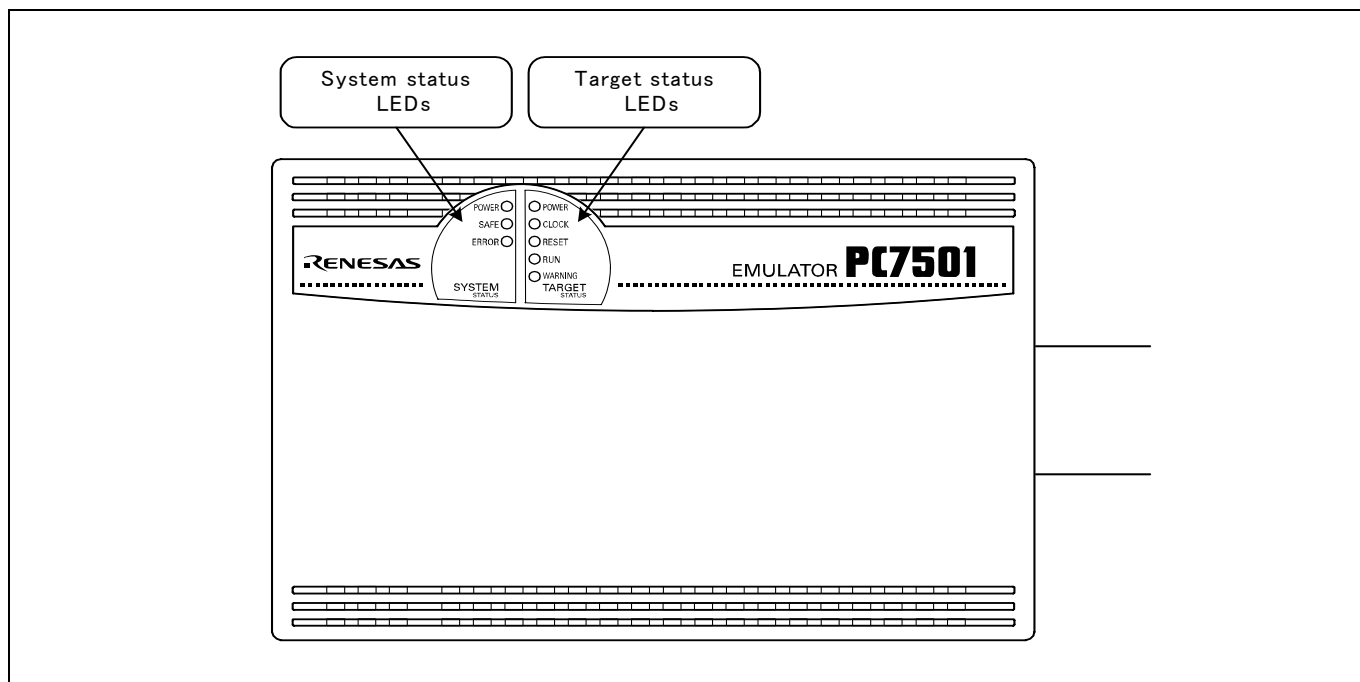

Figure 1.2 Names of the LEDs on the upper panel of the PC7501

(1) System Status LEDs

The system status LEDs indicate the emulator PC7501's power supply, firmware operating status, etc. Table 1.3 lists the definition of each system status LED.

Table 1.3 Definitions of the system status LEDs

Name	Status	Meaning
POWER	ON	Emulator system power supply is turned ON.
	OFF	Emulator system power supply is turned OFF.
SAFE	ON	Emulator system is operating normally.
	Flashing	1. The self-check is being executed. 2. Downloaded firmware is being written into memory. 3. If the ERROR LED is flashing on at the same time or alternately, it indicates that the self-check error occurred.
	OFF	PC7501 system is not operating normally (system status error).
ERROR	ON	PC7501 system is not operating normally (system status error).
	Flashing	1. Firmware is being downloaded. 2. If the SAFE LED is flashing at the same time or alternately, it indicates that the self-check error occurred.
	OFF	PC7501 system is operating normally.

(2) Target Status LEDs

The target status LEDs indicate operating status of the target MCU and power supply of the user system. Table 1.4 lists the definition of each target status LED.

Table 1.4 Definition of the target status LEDs

Name	Status	Meaning
POWER	ON	Power is supplied to the user system.
	OFF	Power is not supplied to the user system.
CLOCK	ON	Target MCU clock is oscillating.
	OFF	Target MCU clock is not oscillating.
RESET	ON	Target MCU is being reset.
	OFF	Target MCU is not being reset.
RUN	ON	User program is being executed.
	OFF	User program has been halted.
WARNING	ON	Address 00000h and 00001h have been read out wrongly.
	OFF	Address 00000h and 00001h have not been read out wrongly.

IMPORTANT

Note on Usage in Memory Expansion or Microprocessor Mode:

- When you use this product in memory expansion or microprocessor mode, be sure to design your system so that pins RDY* and HOLD* are not active at startup. Otherwise, it cannot startup normally.

Note on the Target Status POWER LED:

- If your MCU has two or more Vcc terminals, the LED does not light unless power is supplied to all the terminals.

Note on the Target Status CLOCK LED:

- If the LED is not turned on, check the following.
 - (1) After powering on the PC7501 (before starting up the emulator debugger):
Make sure that the oscillator circuit board is properly installed in the PC7501 and it is oscillating normally.
 - (2) After the emulator debugger is started up (after the Init dialog box settings are completed):
Make sure that the oscillator selected in the Init dialog box is oscillating normally.

Note on Accessing Addresses 00000h and 00001h:

- With the M16C/60 Series MCUs, when a maskable interrupt is generated, the interrupt data (interrupt number and interrupt request level) stored in addresses 00000h and 00001h are read out. Also, the interrupt request bit is cleared when address 00000h or 00001h is read out. Consequently, when the address 00000h or 00001h readout instruction is executed or when address 00000h or 00001h is read out in the cause of a program runaway, a malfunction occurs in that the interrupt is not executed despite the interrupt request, because the request bit of the highest priority interrupt factor enabled is cleared.
For this malfunction, when the reading out to address 00000h or 00001h is generated excluding the interrupt, the WARNING LED (yellow) lights up to alarm. When this LED lights, there is a possibility of wrong read access, therefore check the user program.

1.4 Specifications

Tables 1.5 lists the specifications of the M306V8T-EPB.

Table 1.5 Specifications of the M306V8T-EPB

Applicable MCU	M16C/60 Series M16C/6V Group M306V8
Applicable MCU mode	Single-chip mode Memory expansion mode 16 bit bus width (Normal, Memory expansion mode 2) Microprocessor mode 16 bit bus width (Normal, Memory expansion mode 2)
Maxi. ROM/RAM capacity	1. MCU internal flash ROM: 516KB (0F000h--0FFFFh, 80000h--FFFFFFh) 2. MCU internal RAM: 16KB (00400h--043FFh) 3. MCU internal flash OSDRAM: 4KB (08000h--08FFFh) 4. MCU internal flash OSDROM: 128KB (30000h--4FFFFh)
Applicable power supply	Vcc1 = Vcc2 = Vcc3: 3.15--3.45 V
Maximum operating frequency	Power supply voltage 3.15 to 3.45 V: 16 MHz
Emulation memory	1. Access area: Flash ROM of MCU Max. operating frequency: 10 MHz 2. External area (CS3*--CS0* area) Possible to allocate up to 4 areas by 4 KB - Maximum operating frequency (at 3.3 V) 0 wait: 6 MHz 1--3 wait: 16 MHz
Basic debugging functions	- Download - Address match break (max. 8 points) - Software break (max. 64 points) - Program execution/stop (allows free-run execution supporting software breaks) - Memory reference/setting (reference/setting C-variables, run-time execution) - Register reference/setting - Disassemble display - C-level debugging, etc.
Real-time trace function	- 256K-cycle bus information recordable (Bus, external trigger, time stamp) - 5 trace modes supported (Break/Before/About/After/Full) - Can be recorded ON/OFF by events
Real-time RAM monitor function	- 4,096 bytes (256 bytes x 16) - Data/last access result
Hardware break function	8 points (Execution address, bus detection, interrupt, external trigger signal)
Execution time measurement function	Time between program start and stop Maximum/minimum/average execution time and pass count of specified four zones. Count clock: Equal to MCU Clock or 16 MHz
C0 coverage	8,192 KB (256 KB x 32 blocks)
External trigger input/event output	External trigger input (MCU-dependent-voltage CMOS level x8) or event output (break x1, event x7)
Host machine interface	- LPT parallel (ECP, EEP, Byte/compatibility and Nibble/compatibility modes) - USB (USB 1.1, full-speed)* - LAN (10BASE-T)
Power supply to emulator	Supplied from included AC adapter (power supply voltage: 100--240 V, 50/60 Hz)
Connecting the User System (see 2.9 "Connecting the User System" on page 30)	M306V8T-PTC (pre-mounted) converter board for 116-pin 0.65-mm-pitch LQFP (116P6A-A)

* Available to connect the host machine that supports USB 2.0.

With the USB interface, not all hardware (such as host machine, USB devices, USB hub) combination will work and guaranteed.

1.5 Operating Environment

Be sure to use this emulator with the operating environmental of the emulator and host machine listed in Tables 1.6 and 1.7.

Table 1.6 Operating environmental conditions

Item	Description
Operating temperature	5 to 35°C (no dew)
Storage temperature	-10 to 60°C (no dew)

Table 1.7 Operating environment of the host machine

Item	Description
Host machine	IBM PC/AT compatibles
OS	Windows Me Windows 98SE Windows XP Windows 2000
CPU	Pentium III 600 MHz or more recommended
Memory	128 MB or more recommended
Pointing device such as mouse	Mouse or any other pointing device usable with the above OS that can be connected to the main body of the host machine.
CD drive	Needed to install the emulator debugger or refer to the user's manual

* Windows and Windows NT are either registered trademarks or trademarks of Microsoft Corporation in the United States and other countries.

2. Setup

This chapter describes the preparation for using this product, the procedure for starting up the emulator and how to change settings.

2.1 Flowchart of Starting Up the Emulator

The procedure for starting up the emulator is shown in Figure 2.1. For details, refer to each section hereafter. And, when the emulator does not start up normally, refer to “5. Troubleshooting” (page 82).

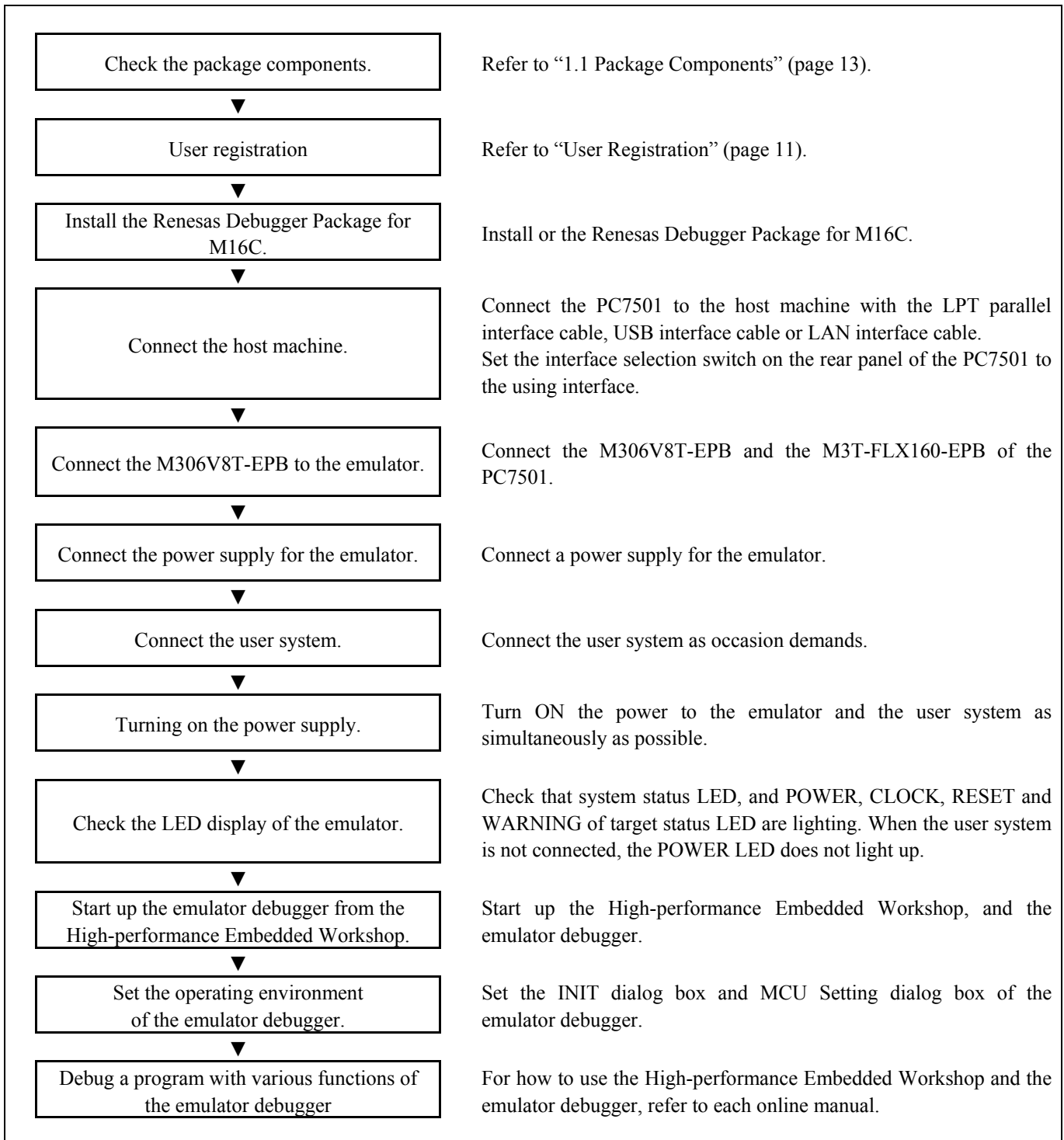

Figure 2.1 Flowchart of starting up the emulator

2.2 Installing the Emulator Debugger (Renesas Debugger Package for M16C)

If the OS used in your host machine is Windows XP or 2000, this installation must be executed by a user with administrator rights. Be aware that users without administrator rights cannot complete the installation.

Install the emulator debugger Renesas Debugger Package for M16C following the procedure described below.

2.2.1 Installing the Emulator Debugger

(1) Downloading the Renesas Debugger Package for M16C

Download the Renesas Debugger Package for M16C from the URL below.

http://download.renesas.com/eng/mpumcu/upgrades/in_circuit_emulators/m16c/index.html

(2) Launching the installer

Start the “setup.exe” program.

(3) Entering the user information

In the “user information” dialog box, enter the user information (contractor, section, contact address, and host machine).

The supplied information will be turned into a format by which technical support will be provided by e-mail.

(4) Selecting components

In the “component selection” dialog box, select the components you want to install. In this dialog box you can change the directory in which to install.

(5) Completing the installation

A dialog box will be displayed indicating that setup has been completed. It means that the installation you made is completed.

2.3 Connecting the Host Machine

When connecting the emulator PC7501 to a host machine, you can choose your desired interface from LPT parallel interface, USB interface and LAN interface. Use the interface selection switch on the emulator PC7501's rear panel to specify your desired interface. Figure 2.2 shows the outline to connect each interface cable.

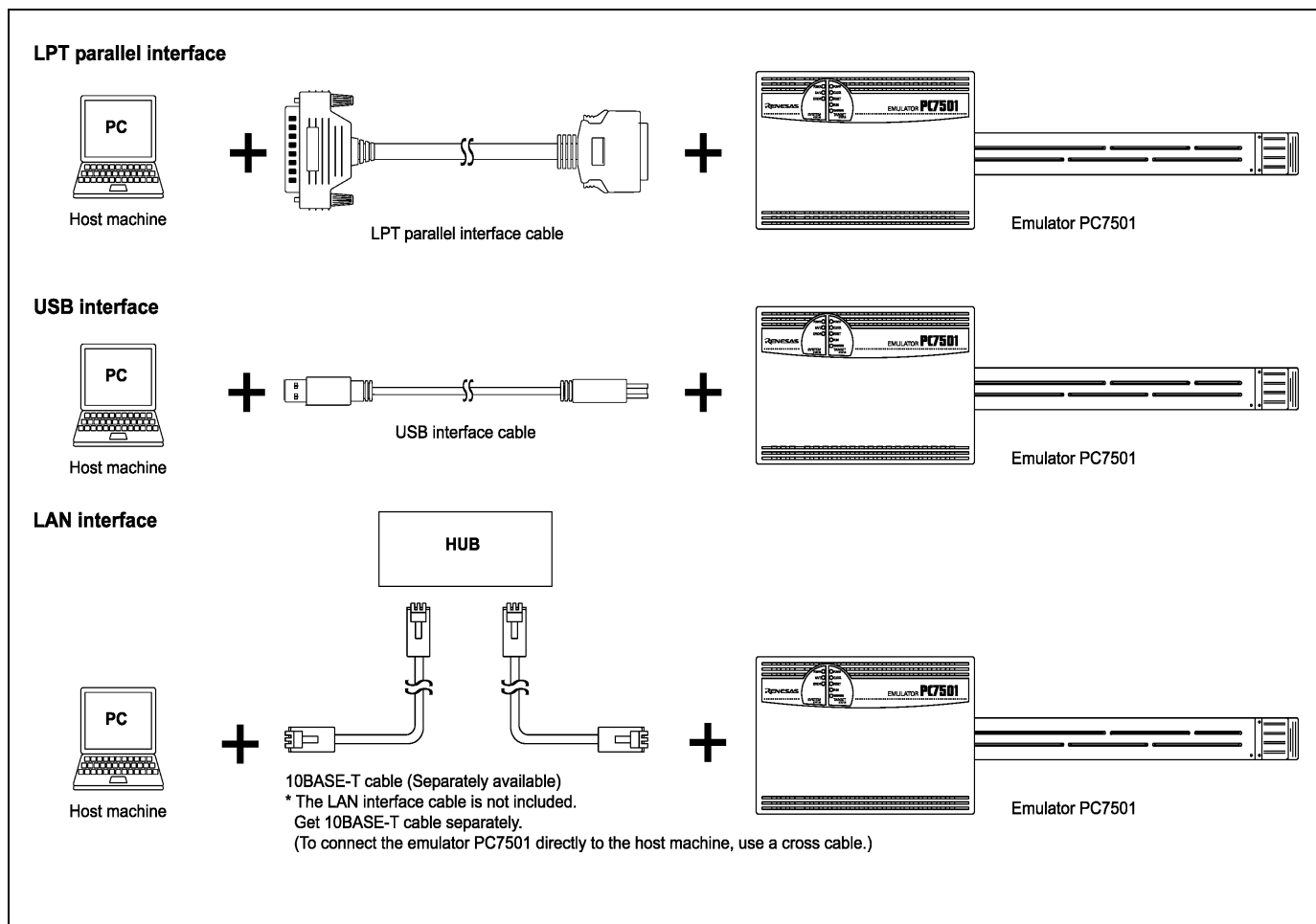

Figure 2.2 Outline for interface cable connections

2.4 Connecting the PC7501

Figure 2.3 shows how to connect the PC7501 and the emulation probe.

 <p>M306V8T-EPB M306V8T-PTC</p>	<p>(1) Slide the upper cover of the M306V8T-EPB to the M306V8T-PTC side. (2) Remove the upper cover.</p>
 <p>M306V8T-EPB M306V8T-PTC</p>	<p>(3) Unscrew the two screws. (4) Remove the metal plate.</p>
 <p>M3T-FLX160-EPB M306V8T-EPB M306V8T-PTC</p>	<p>(5) Connect CN1 and CN2 of the M3T-FLX160-EPB to J1 and J2 of the M306V8T-EPB, respectively.</p> <p>* Place the CN1 of the M3T-FLX160-EPB under the metal plate to connect the M306V8T-EPB. Place the flexible cable on the upper side of the metal plate.</p>
 <p>M3T-FLX160-EPB M306V8T-EPB M306V8T-PTC</p> <p>Enlarged view</p>	<p>(6) Attach the metal plate. (7) Tighten the two screws.</p>
 <p>M306V8T-EPB M306V8T-PTC</p>	<p>(8) Attach the upper cover. (9) Slide the upper cover of the M306V8T-EPB to the PC7501 side.</p>

Figure 2.3 Connecting the PC7501 and emulation probe

⚠ CAUTION

Cautions for Connecting the PC7501:

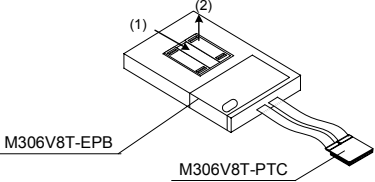
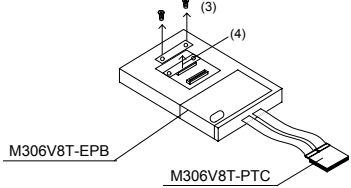
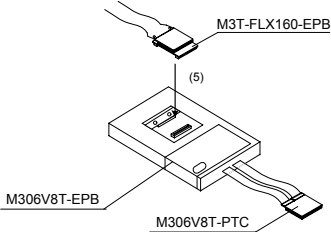
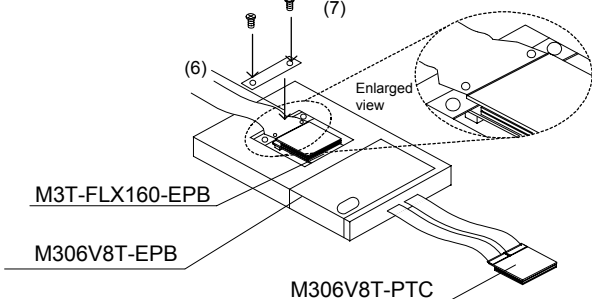
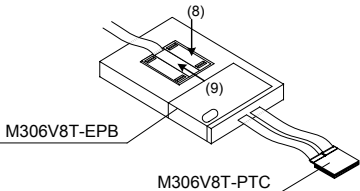

- When connecting the emulation probe, be sure to hold the both sides of the emulation probe horizontally and insert it directly.
- Always shut OFF power before connecting the emulation probe. Otherwise, internal circuits may be damaged.
- The connectors of the M306V8T-EPB are guaranteed for only 50 insertion/removal iterations.

2.5 Connecting the Power Supply for the Emulator

The power is supplied from AC adapter to the emulator PC7501. Here following explains how to connect the AC adapter.

- (1) Turn OFF the power to the PC7501.
- (2) Connect the DC cable of AC adapter to the PC7501.
- (3) Connect the AC power cable to the AC adapter.
- (4) Connect the AC power cable to the receptacle.

CAUTION

Cautions for AC Adapter:



- Use only the AC adapter included in PC7501 package.
- The included AC adapter is for PC7501. Do not use it for other product.
- Before installing this equipment or connecting it to other equipment, disconnect the AC power cable from its outlet to prevent injury or accident.
- The DC plug on the included AC adapter has the below polarity.



- The included AC adapter has no power supply switch. The AC adapter is always active while connecting the AC power cable. Check if the power is supplied by the LED of AC adapter.

2.6 Turning ON the Power

2.6.1 Checking the Connections of the Emulator System

Before turning the power ON, check the connection of the interface cable with host machine, PC7501, emulation probe, and user system.

2.6.2 Turning ON/OFF the Power

- Turn ON the power of the emulator and user system as simultaneously as possible.
- Turn OFF the power of the emulator and user system as simultaneously as possible.
- Do not leave either the emulator or user system powered on, because of leakage current the internal circuits may be damaged.
- When turning ON the power again after shutting OFF the power, wait for about 10 seconds.

IMPORTANT

Notes on Power Supply:

- The emulator's pin Vcc is connected to the user system in order to monitor user system voltage. For this reason, the emulator cannot supply power to the user system. Therefore, provide the user system with a separate power supply from that of the emulator.
- The voltage of the user system should be as follows.
$$3.15 \text{ V} \leq V_{cc1} = V_{cc2} = V_{cc3} \leq 3.45 \text{ V}$$
- Do not change user system power supply voltage after power has been activated.

2.6.3 LED Display When the Emulator Starts Up Normally

Figure 2.4 shows upper panel LED lighting status when the emulator started up properly. Check it when starting up the emulator system.

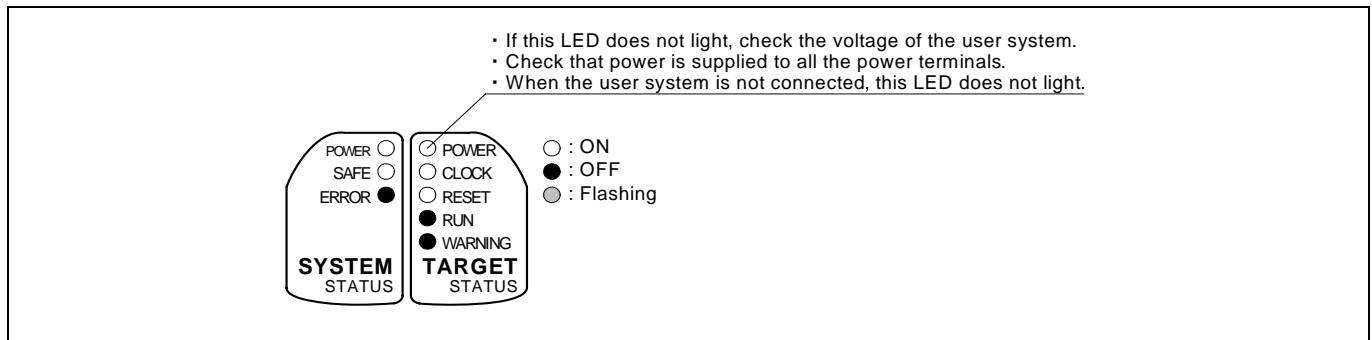

Figure 2.4 LED display when the power turned on PC7501

IMPORTANT

Note on Memory Expansion or Microprocessor Mode:

- To use the memory expansion or microprocessor mode, be sure to set pins RDY* and HOLD* so that they are not active at startup. Otherwise the emulator system will not start up correctly.

Note on the Target Status POWER LED:

- If your MCU has two or more Vcc terminals, the LED does not light unless power is supplied to all the terminals.

Note on the Target Status CLOCK LED:

- If the LED is not turned on, check the following.
 - (1) After powering on the PC7501 (before starting up the emulator debugger):
Make sure that the oscillator circuit board is properly installed in the PC7501 and it is oscillating normally.
 - (2) After the emulator debugger is started up (after the Init dialog box settings are completed):
Make sure that the oscillator selected in the Init dialog box is oscillating normally.

2.7 Downloading Firmware

2.7.1 When It is Necessary to Download Firmware

It is necessary to download the firmware in the cases listed below. Normally, the following are automatically detected when the emulator debugger is started up, and the firmware is downloaded.

- When you use this product for the first time
- When the firmware has been upgraded
- When the emulator debugger or firmware has been upgraded
- When you use this product with a PC7501 which was used with another emulation probe before

When you use this product for the first time or when the power is unexpectedly shut down, redownload the firmware in maintenance mode.

2.7.2 Downloading Firmware in Maintenance Mode

Download firmware in the special mode called maintenance mode as explained here following. Figure 4.2 shows LED displays when downloading firmware.

The user system must not be connected when you download the firmware.

- (1) Set the interface select switch on the rear panel of the PC7501 to the LPT side and connect the LPT parallel interface cable to the PC7501 and the host machine.
- (2) Within 2 seconds of activating power to the emulator, press the system reset switch on the PC7501 front panel to start maintenance mode. When the emulator is switched to maintenance mode, the System Status SAFE LED begins to flash.
- (3) Start up the emulator debugger. When settings in the Init dialog box are complete, the dialog which urges to download the firmware will appear. Download firmware following messages. Required time for downloading the firmware is about 60 seconds.

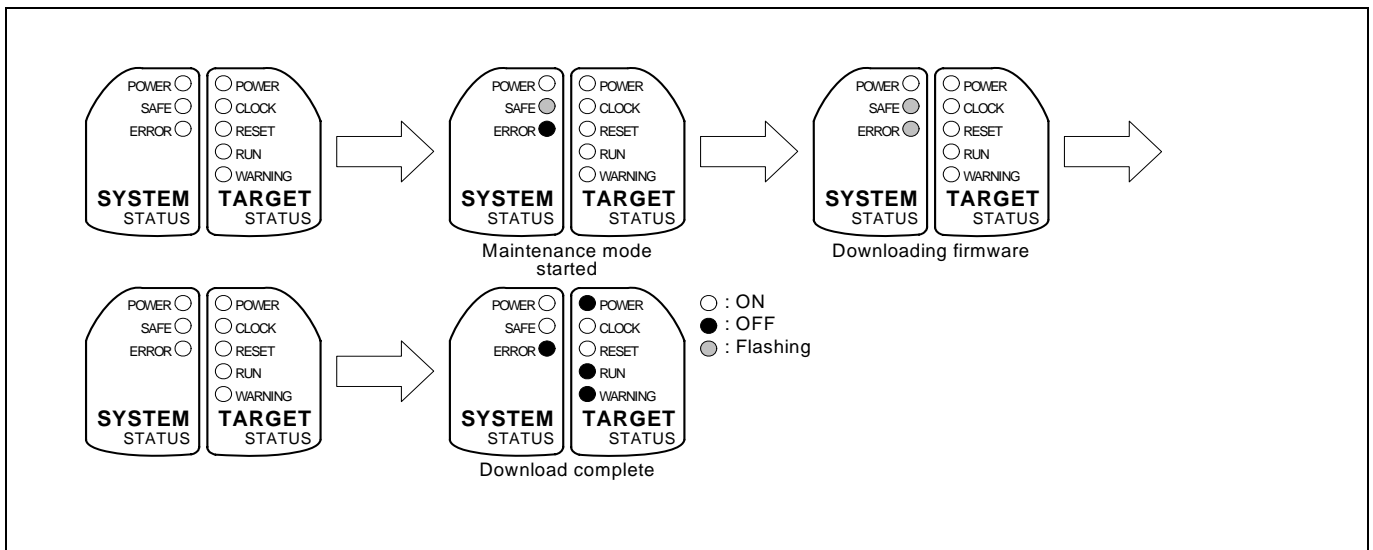

Figure 2.5 LEDs during firmware download

IMPORTANT

Note on Downloading Firmware:

- Do not shut OFF power while firmware is being downloaded. Doing so, the emulator will not start up properly. If power is shut off by mistake, redownload the firmware in maintenance mode.

2.8 Self-check

2.8.1 Self-check Procedure

To run the self-check of the emulator, do so as explained here below. While the self-check is in progress, the LEDs will change as shown in Figure 2.6.

- (1) If the user system is connected, disconnect it.
- (2) Set the switches as the factory-settings to execute the self-check (see Table 2.1 on page 34 and Table 2.2 on page 35).
- (3) Within 2 seconds of activating power to the emulator, press the system reset switch on the emulator front panel to switch the emulator to maintenance mode.
- (4) Check the "SAFE" LED starts flashing and then press the system reset switch again.
- (5) The self-check will start. If the normal result is displayed in about 30 seconds, the self-check terminated normally.

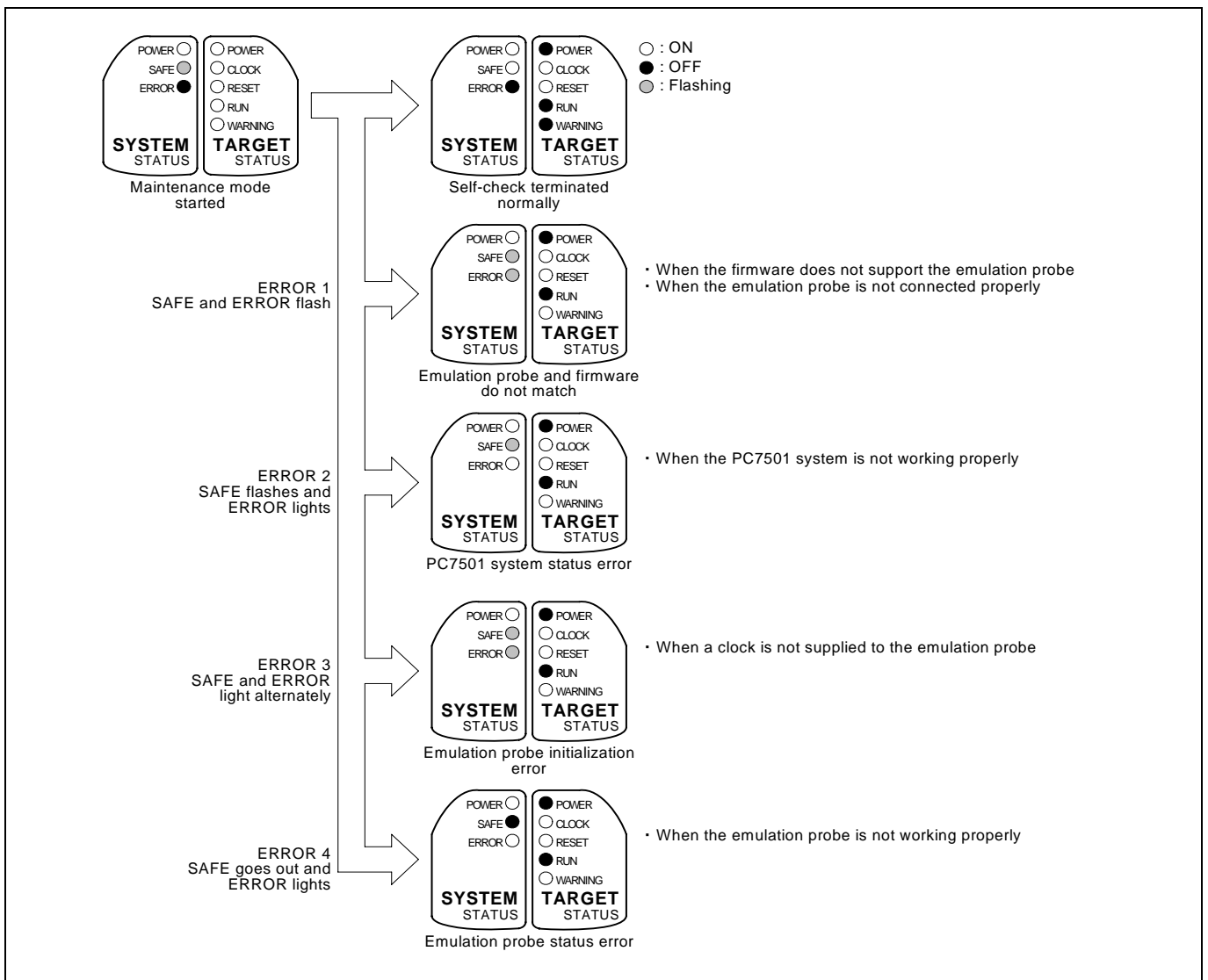

Figure 2.6 LED displays in the self-check

2.8.2 If an Error is Detected in the Self-check

If the self-check does not result normally (ERROR 1 to ERROR 4 in Figure 2.6), check the following.

- (1) Recheck the connection of the emulation probe and PC7501.
- (2) Redownload the proper firmware.

IMPORTANT

Note on the Self-check:

- Perform the self-check while not connecting the user system.
- If the self-check does not result normally (excluding user system errors), the emulation probe may be damaged. Then contact your local distributor.

2.9 Connecting the User System

Figure 2.7 shows how to connect this product according to your user system.

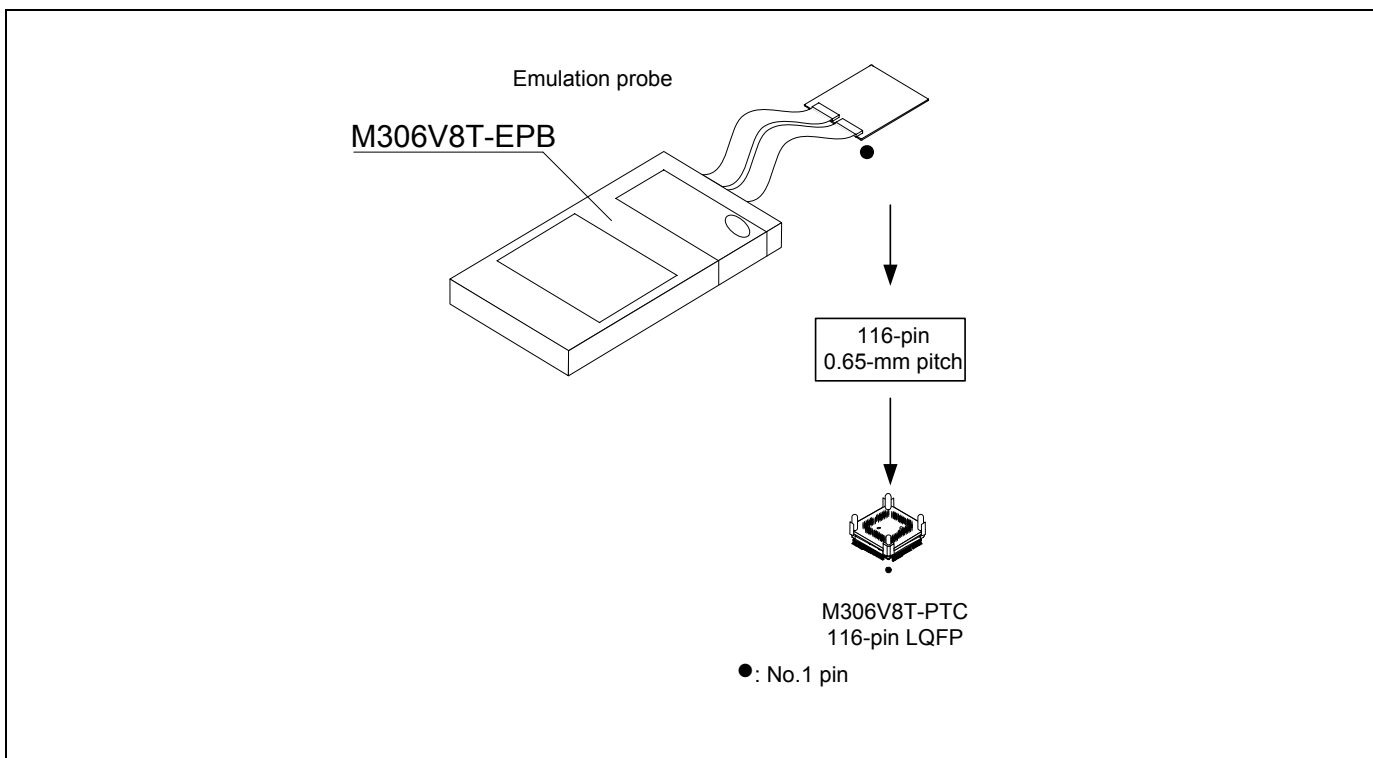

Figure 2.7 Connecting the user system according to user systems

CAUTION

Note on Connecting the User System:



- Take care not to attach a converter board in a wrong direction. It may cause a fatal damage to the emulator and user system.

2.9.1 Connecting the User System

When connecting the emulation probe to a 116-pin 0.65-mm-pitch foot pattern on the user system, follow the procedures below.

- (1) Mount the NQPACK116SB (included) to the user system.
- (2) Connect the YQPACK116SB (included) to the NQPACK116SB and secure it with the YQ-Guide's.
- (3) Connect M306V8T-PTC to the YQPACK116SB.

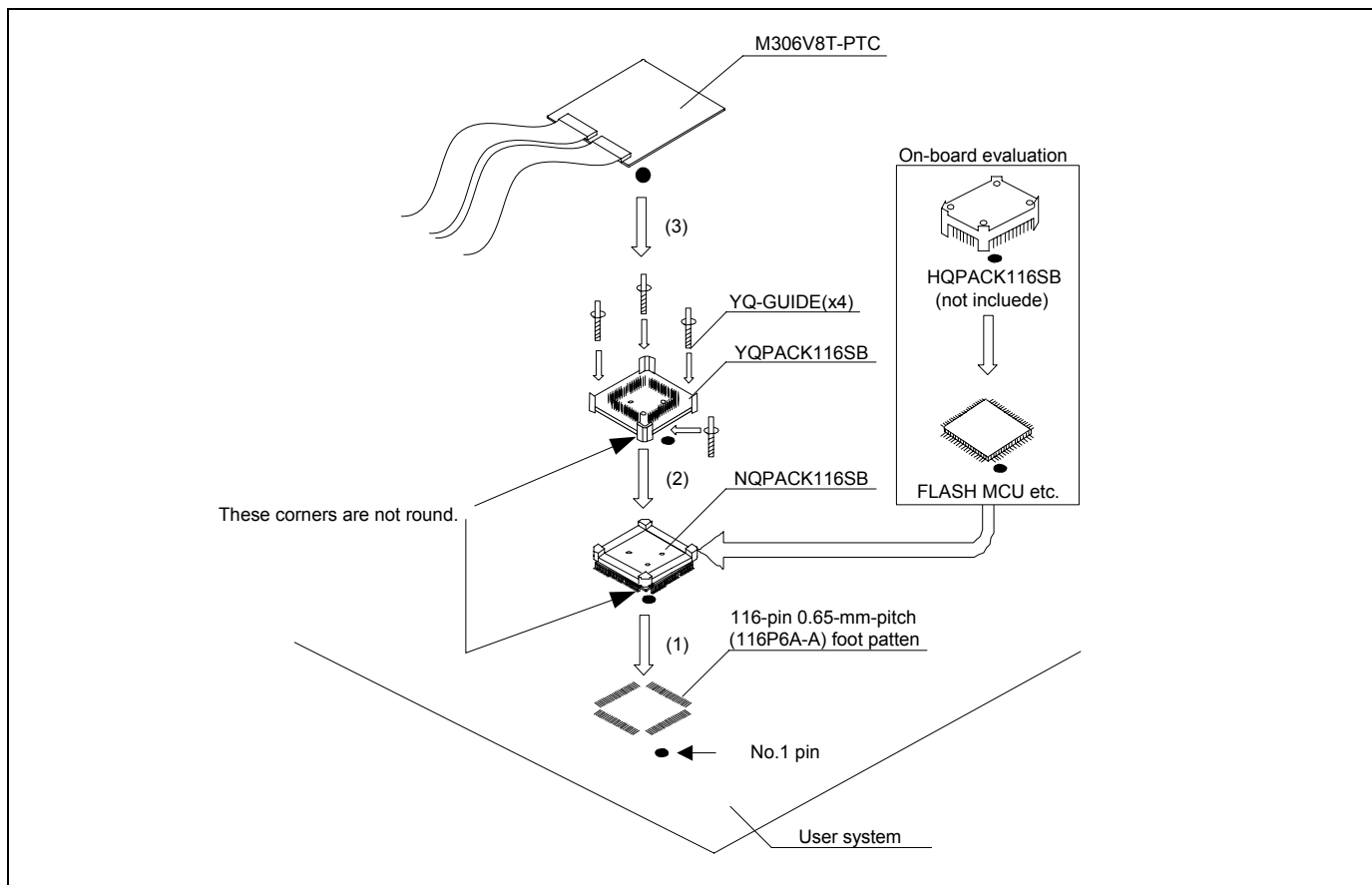

Figure 2.8 Connecting to an 116-pin 0.65-mm-pitch foot pattern

* NQPACK, YQPACK, YQSOCKET, YQ-GUIDE and HQPACK are trademarks of Tokyo Eletech Corporation.

⚠ CAUTION

Notes on Connecting the User System:



- Take care not to attach a converter board in a wrong direction. It may cause a fatal damage to the emulator and user system.

2.10 Switch Settings

2.10.1 Setting Switches of Emulation Probe

Set the switches of the emulation probe according to the condition. Figure 2.9 shows the positions of the switches of the M306V8T-EPB.

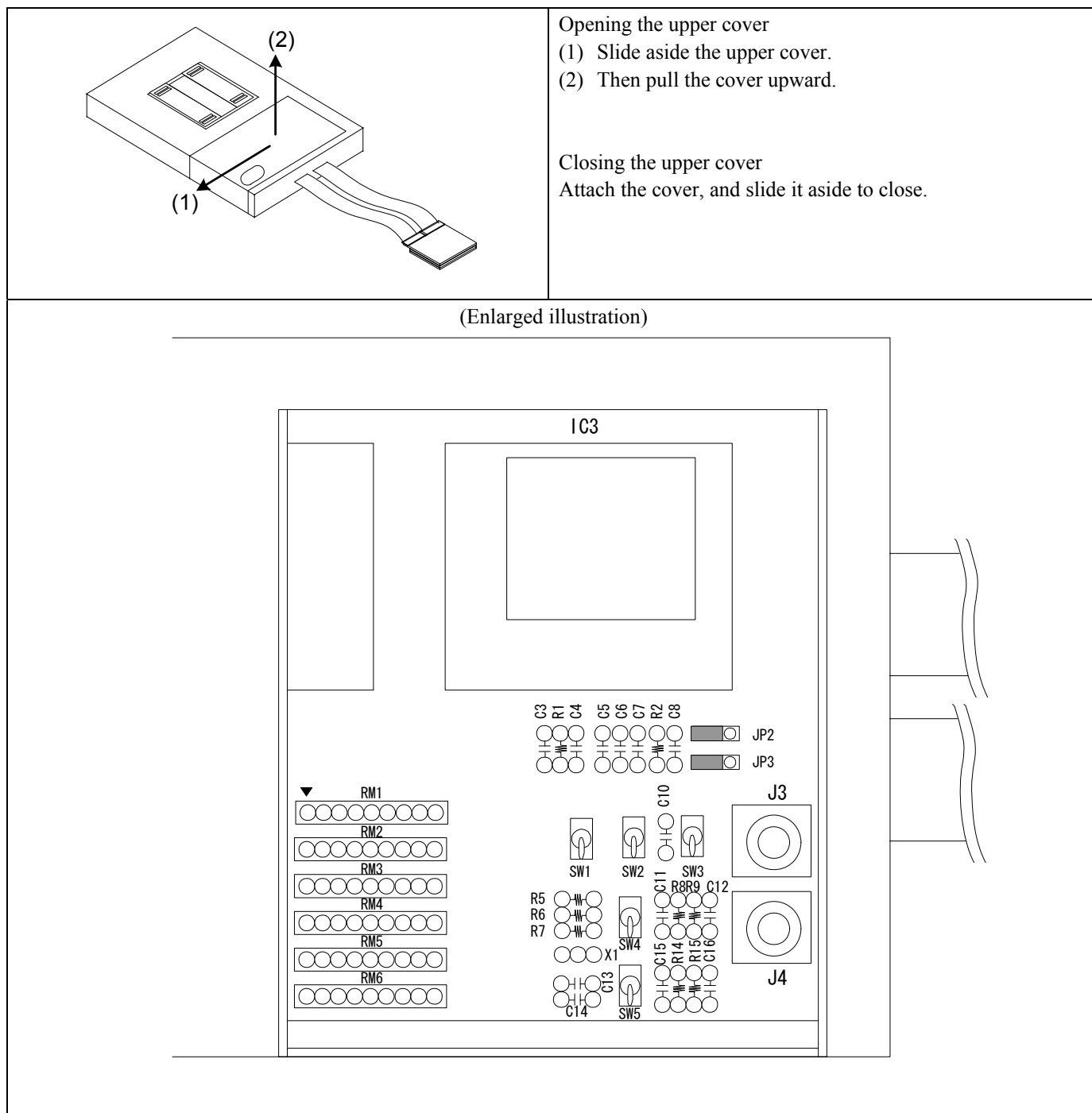

Figure 2.9 Positions of the switches

(1) Circuits for JP2, JP3, SW1 to SW5 on the M306V8T-EPB board, OSD resistor, capacitors, etc.

Figure 2.10 shows these circuits.

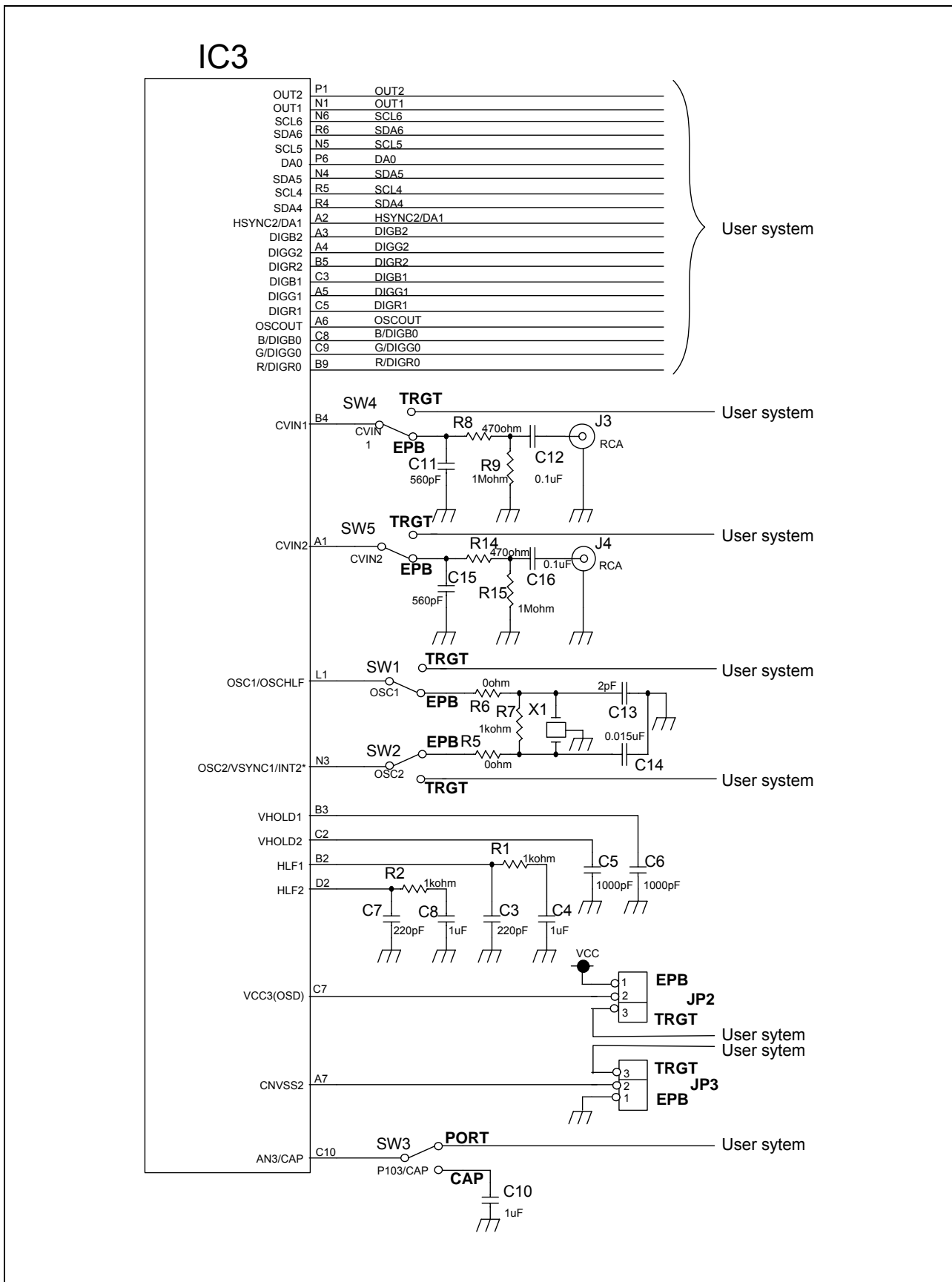

Figure 2.10 Circuits for JP2, JP3, SW1 to SW5, and OSD

(1) Setting JP2, JP3, SW1 to SW5 on the M306V8T-EPB

Tables 2.1 and 2.2 show the settings of JP2, JP3, SW1 to SW5 on the M306V8T-EPB.

Table 2.1 Switch settings of the M306V8T-EPB (JP2, JP3, SW1 to SW5) (1/2)









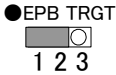

Switch	Switch name	Setting	Description
JP2	VCC3	 <p>(Factory-setting)</p>	Connects pin VCC3 of the evaluation MCU to the internal power supply of the M306V8T-EPB. When the user system is not connected, use this setting.
			Connects pin VCC3 of the evaluation MCU to the user system.
JP3	CNVSS2	 <p>(Factory-setting)</p>	Connects pin CNVSS2 of the evaluation MCU to GND in the M306V8T-EPB. When the user system is not connected, use this setting.
			Connects pin CNVSS2 of the evaluation MCU to the user system.
SW1,SW2	OSC1,OSC2	 <p>(Factory-setting)</p>	Connects pins OSC1 and OSC2 of the evaluation MCU to the internal circuit of the M306V8T-EPB. When the user system is not connected, use this setting
			Connects pins OSC1 and OSC2 of the evaluation MCU to the user system.

Table 2.3 Switch settings of the M306V8T-EPB (JP2, JP3, SW1 to SW5) (2/2)

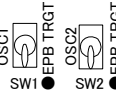
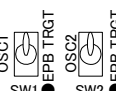
Switch	Switch name	Setting	Description
SW3	P103/CAP	 (Factory-setting)	Connects pin P103/CAP of the evaluation MCU to the user system.
			Connects pin P103/CAP of the evaluation MCU to the internal circuit of the M306V8T-EPB.
SW4	CVIN1	 (Factory-setting)	Connects pin CVIN1 of the evaluation MCU to the internal circuit of the M306V8T-EPB. When the user system is not connected, use this setting.
			Connects pin CVIN1 of the evaluation MCU to the user system.
SW5	CVIN2	 (Factory-setting)	Connects pin CVIN2 of the evaluation MCU to the internal circuit of the M306V8T-EPB. When the user system is not connected, use this setting.
			Connects pin CVIN2 of the evaluation MCU to the user system.

IMPORTANT

Notes on Switch Settings:

- Be sure to turn of the power before setting the switches or connecting the cables. Otherwise, the internal circuits may be damaged.
- Use the SW1 and SW2 only in the combination of the setting described in Table 2.1.

2.10.2 Writing Data to the OSDROM

This product is not able to write data into the OSDROM (internal resources of the evaluation MCU). Remove the evaluation MCU of IC3 from the IC socket and write data to the OSDROM using the dedicated programmer.

Figure 2.11 shows removing and attaching the evaluation MCU (1 to 6).

An IC socket lever is on the right side in the figure. The lever may be on the left side, but the evaluation MCU will be removed and attached in the same procedure.

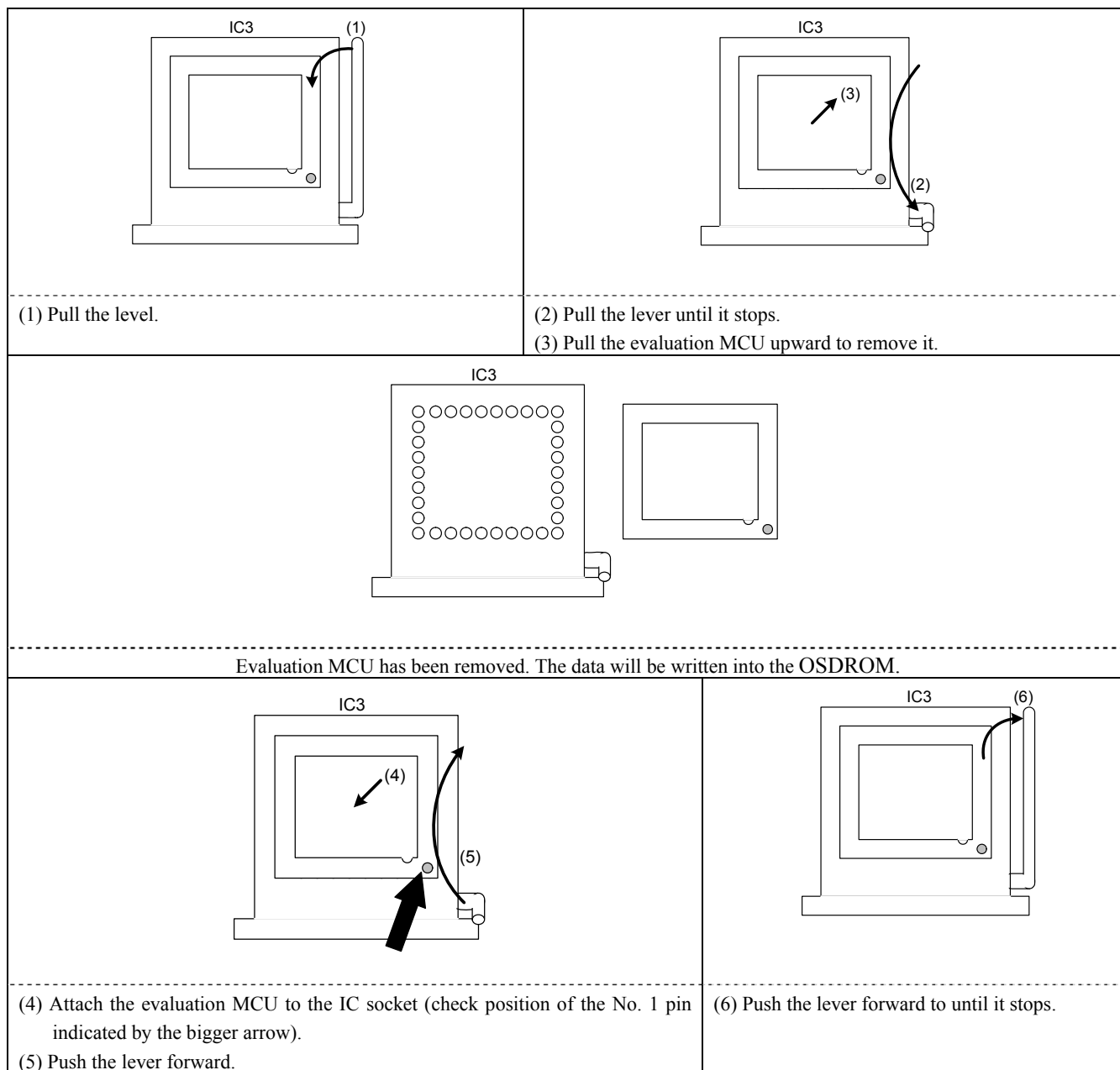

Figure 2.11 Removing/attaching evaluation MCU

IMPORTANT

Notes on Removing/Attaching Evaluation MCU:

- Before removing or attaching the evaluation MCU, be sure to turn OFF the power supply. Otherwise, the internal circuit may be damaged.
- When attaching the evaluation MCU to the IC socket, check the position of No.1 pin, Incorrect attachment may cause a break of evaluation MCU.

2.10.3 Pullup of Emulation Ports

Because this product emulates some I/O ports (P0 to P5, P10), you can not pullup ports P0 to P5 by the pullup control registers. Install the included resistor arrays (51 kΩ) as necessary. Figure 2.12 shows the positions of the pullup resistors. And, Table 2.3 lists the emulation port numbers and the pullup resistor part numbers.

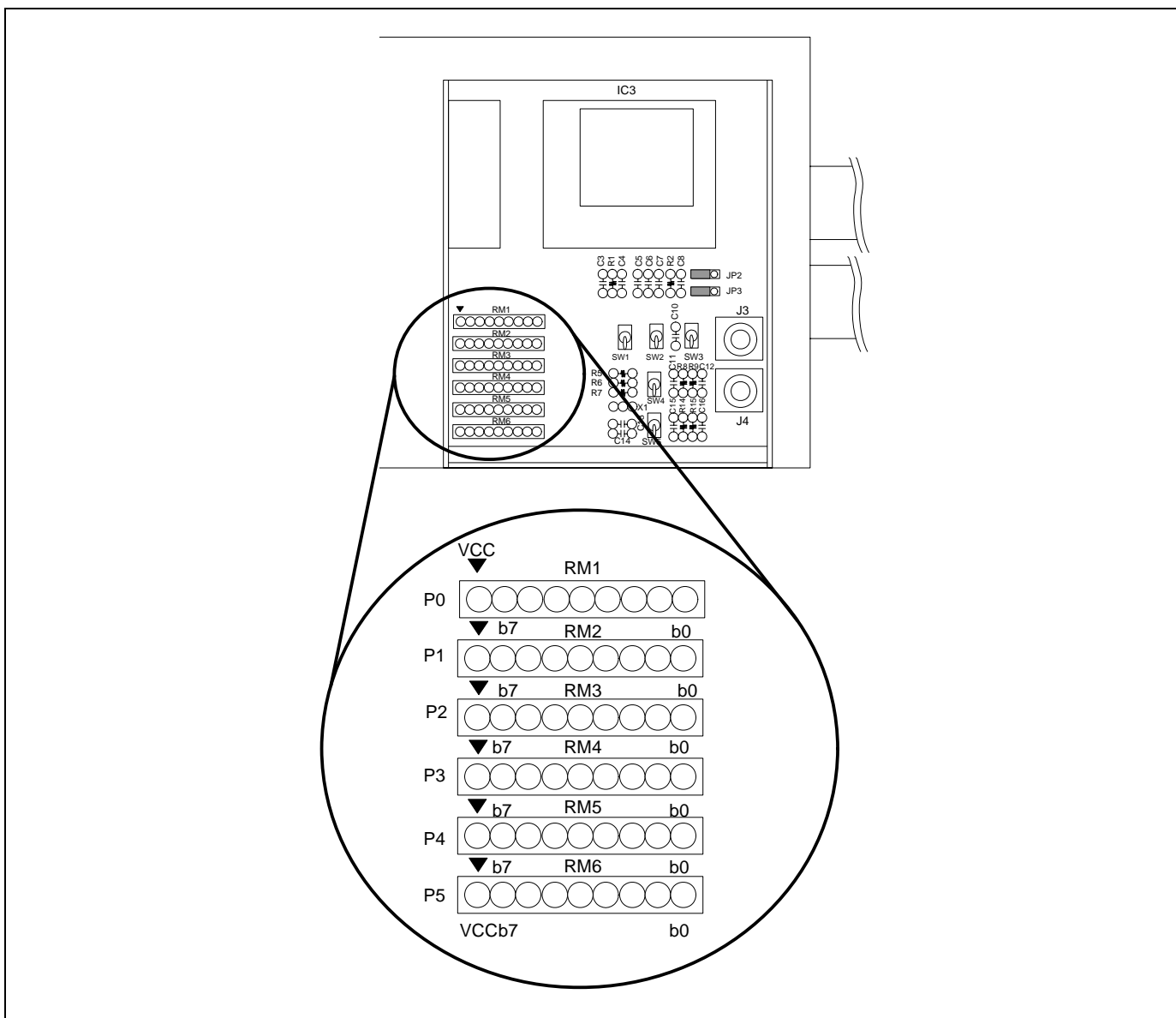

Figure 2.12 Positions of the pullup resistors

Table 2.3 Emulation ports and pullup resistor part numbers

Port	Resistor part
P00--P07	RM1 (51 kΩ pullup)
P10--P17	RM2 (51 kΩ pullup)
P20--P27	RM3 (51 kΩ pullup)
P30--P37	RM4 (51 kΩ pullup)
P40--P47	RM5 (51 kΩ pullup)
P50--P57	RM6 (51 kΩ pullup)

2.11 Selecting Clock Supply

2.11.1 Clocks

You can choose a clock supplied to the evaluation MCU by the Emulator tab in the Init dialog box of the emulator debugger. Table 2.4 shows the clocks and their initial settings.

Table 2.4 Clock supply to the MCU

Clock	Display of emulator debugger	Description	Default setting
Main (X _{IN} -X _{OUT})	Internal	Internal oscillator circuit board (OSC-3 or OSC-2)	Yes
	External	Oscillator circuit on the user system	-
	Generate	Internal generator circuit (1.0--16.0 MHz)	-
Sub (X _{CIN} -X _{COU} T)	Internal	Internal oscillator circuit (32.768 kHz)	-
	External	Oscillator circuit on the user system	Yes

IMPORTANT

Notes on Changing the Clock Supply:

- The clock supply can be set by the Init dialog box when starting up the emulator debugger or inputting CLK command on the script window.

2.11.2 Using an Internal Oscillator Circuit Board

(1) Kinds of Oscillator Circuit Boards

The PC7501 comes with an oscillator circuit board OSC-3 (30 MHz). And an oscillator circuit board OSC-3 (16 MHz) and an oscillator circuit board OSC-2 (bare board) are included with this product. If you use the internal oscillator circuit board OSC-3 (16 MHz) or OSC-2 of the PC7501 as a main clock, choose "Internal" in the emulator debugger after replacing oscillator circuit boards to change a clock supplied to an MCU.

(2) Replacing an Oscillator Circuit Board

1. Remove the four screws of both sides of this product and lift off the upper cover (see Figure 2.13).

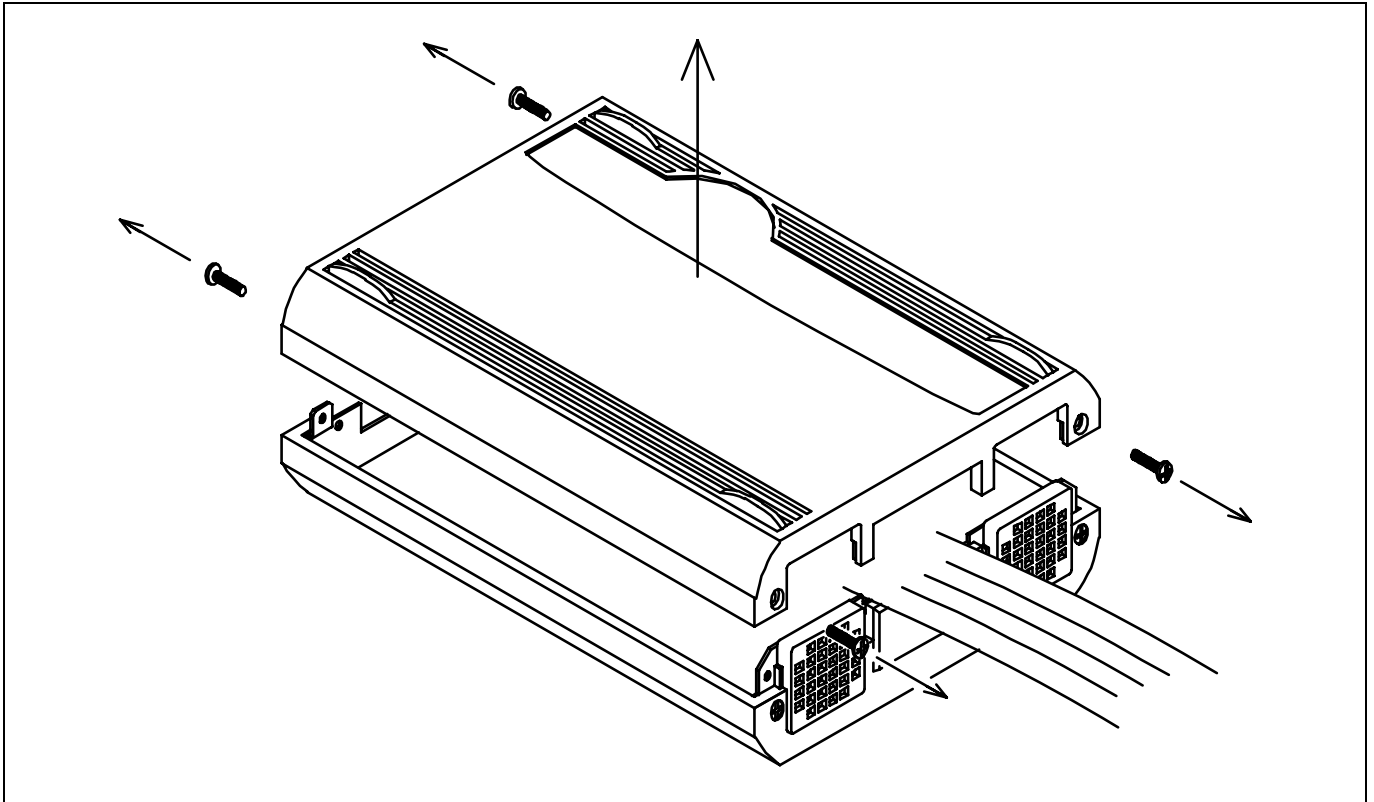

Figure 2.13 Removing the upper cover

1. Replace the oscillator circuit board (see Figure 2.14).

	<p>The oscillator circuit board of the PC7501 is in the lower right corner of the board.</p>
	<p>Unscrew the screw securing the oscillator circuit board.</p>
	<p>Lift off the oscillator circuit board.</p>
	<p>Attach another oscillator circuit board to the connector.</p>
	<p>Secure the new oscillator circuit board with the screw.</p>

Figure 2.14 Replacing the oscillator circuit board

2. Reinstall the upper cover and secure the four screws.

⚠ CAUTION

Note on Replacing the Oscillator Circuit Board:

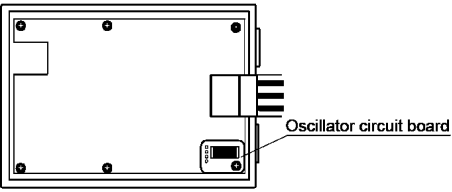
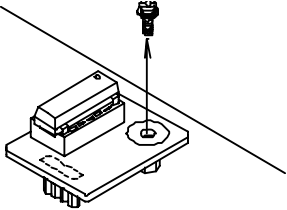
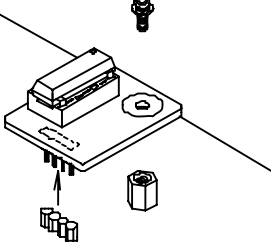
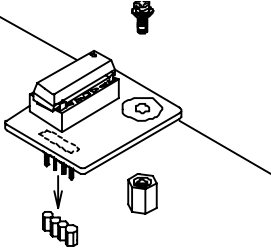
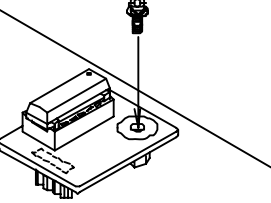

- Always shut OFF power when removing the upper cover or replacing oscillator circuit board. Otherwise, internal circuits may be damaged.

(3) Using the Internal Oscillator Circuit Bare Board

To use the emulation probe at a frequency you like, build a desired oscillator circuit on the included OSC-2 oscillator circuit bare board. Figure 2.15 shows an external view of the OSC-2 oscillator circuit bare board and where the connector pins are located. Figure 2.16 shows the circuitry of the oscillator circuit bare board OSC-2. Use the number of oscillator circuits recommended by the oscillator manufacturer.

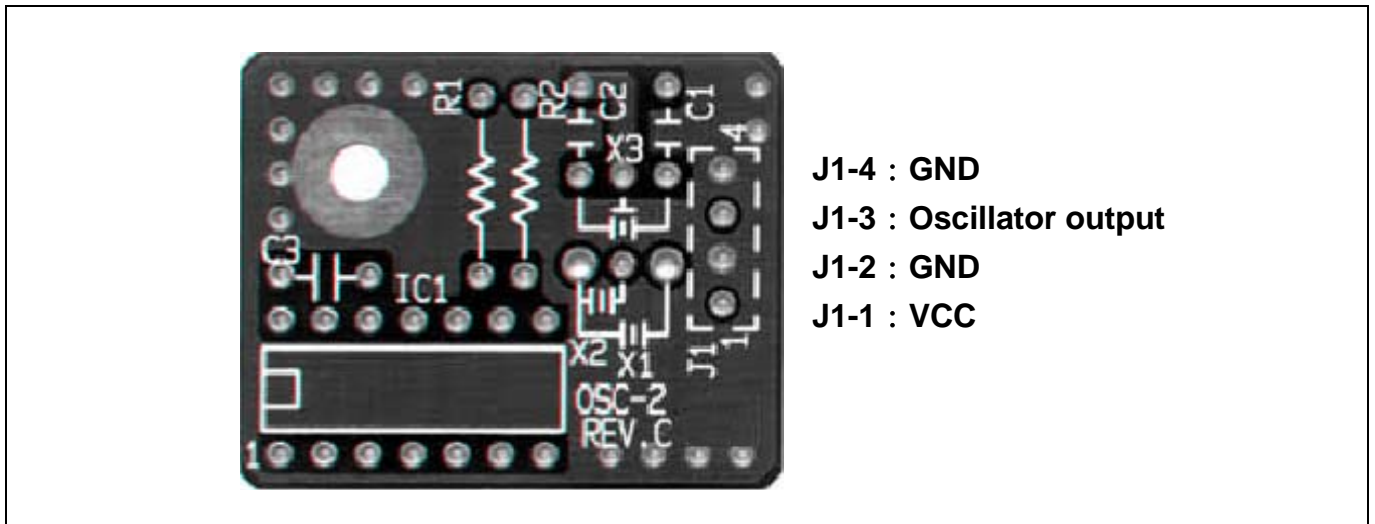

Figure 2.15 External view of the oscillator circuit board OSC-2 and its connector pin positions

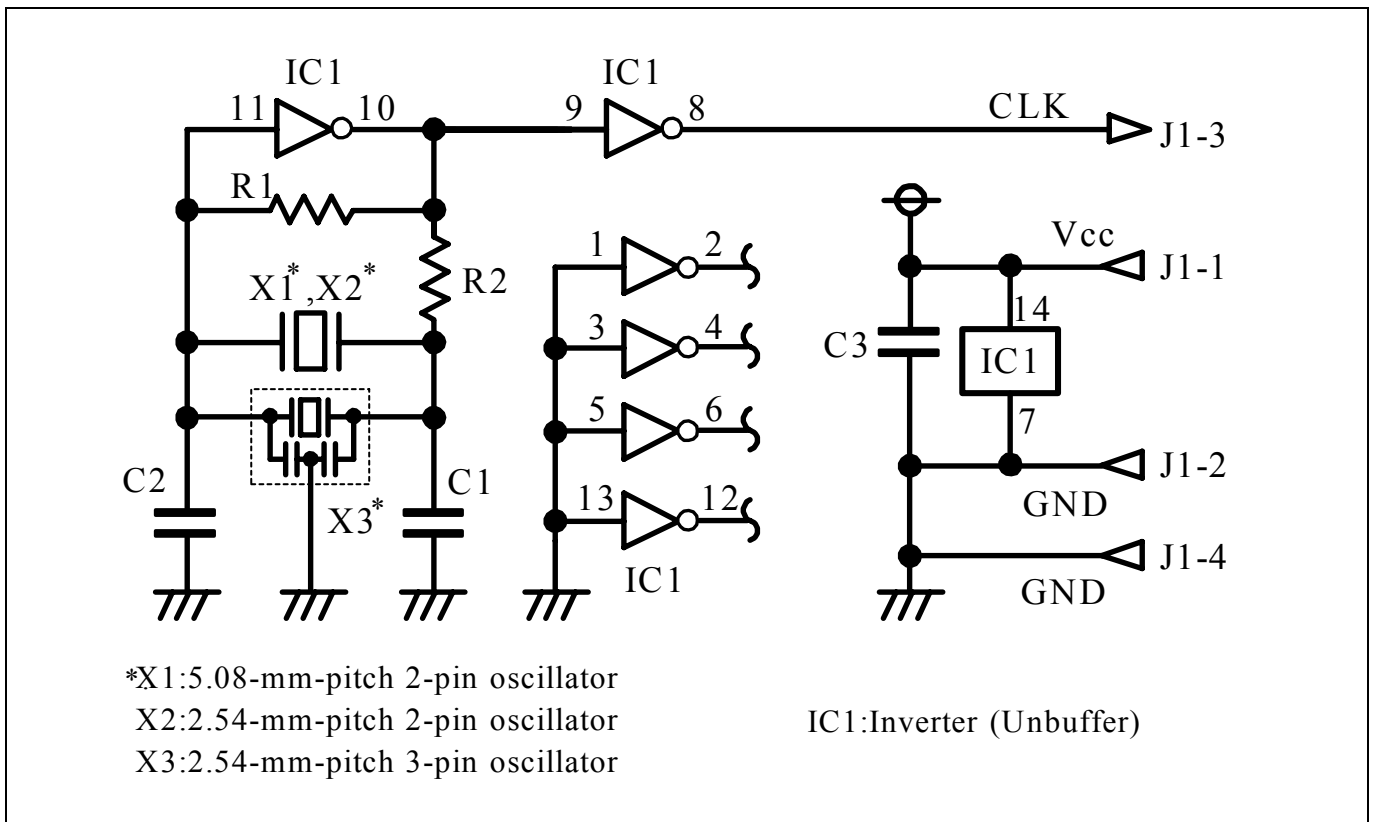

Figure 2.16 Circuits of the oscillator circuit bare board OSC-2

2.11.3 Using the Oscillator Circuit on the User System

To operate this product with an external clock, construct the oscillator circuit as shown in Figure 2.17 in the user system and input the oscillator output at 50% duty (within the operating range of the evaluation MCU) into pin X_{IN} . And pin X_{OUT} should be open. Choose "External" in the emulator debugger to use this clock.

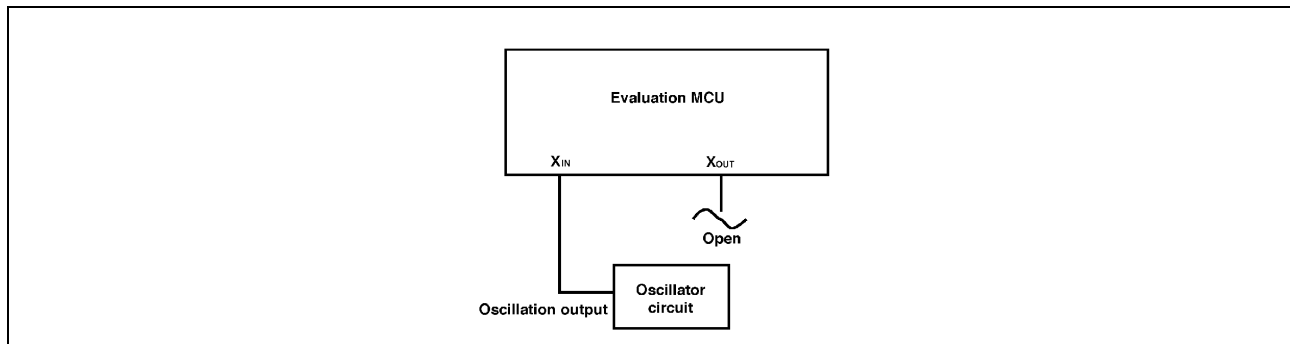

Figure 2.17 External oscillator circuit

Make note that in the oscillator circuit shown in Figure 2.18 where a resonator is connected between pins X_{IN} and X_{OUT} , oscillation does not occur because a converter board and other devices are used between the evaluation MCU and the user system. It is same for sub-clock oscillator circuits (X_{CIN} and X_{COUT}).

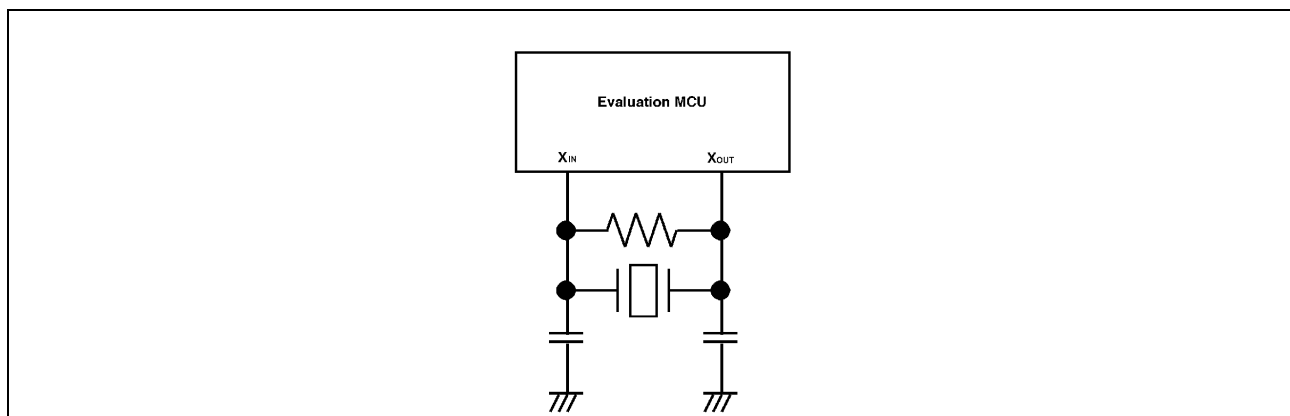

Figure 2.18 Circuit in which oscillation does not occur

2.11.4 Using the Internal Generator Circuit

The dedicated circuit in the PC7501 can generate any arbitrary frequency specified by the emulator debugger, and it can be supplied as a main clock. It does not depend on either the oscillator circuit board in the PC7501 or the oscillator circuit on the user system. If you want to debug programs without the user system or change a frequency temporarily, you can check its operation before purchasing an oscillator. If you want to use the internal generator circuit in the PC7501 as a main clock, choose "Generate" in the emulator debugger and specify a frequency you like to use this clock.

Although you can change a frequency between 1.0 and 99.9 MHz by 0.1 MHz for the PC7501, do not specify a value exceeding the maximum input frequency of the X_{IN} of an MCU.

IMPORTANT

Note on Using the Internal Generator Circuit:

- The internal generator circuit is equipped for temporary debugging purposes. Temperature characteristics of frequencies are not guaranteed.
- Be sure to evaluate your system with an oscillator or oscillator module whose frequency is same as that of the internal oscillator circuit (internal clock) for final evaluation purposes.

3. Usage (How to Use the Emulator Debugger)

This chapter describes how to start up the emulator debugger from the High-performance Embedded Workshop.

3.1 Starting Up the Emulator Debugger

When debugging the completed programs, switch the session. The session can be changed by the drop down list of the tool bar shown below.



You will have as many sessions created as the number of targets you selected when creating a project, so select the session that corresponds to the target to be connected from the drop-down list. To connect to the PC7501 + M16C Emulation Probe, select "SessionM16C_R8C_PC7501_Emulator."

3.1.1 INIT Dialog Box

After specifying the session, an Init dialog box to connect the target is displayed. The Init dialog box is used to set the items that need to be set when the emulator debugger starts up. The contents set in this dialog box remain effective the next time you start the debugger. When you have finished settings (1) through (4), click OK.

(1) MCU tab

1 Specifying the MCU file

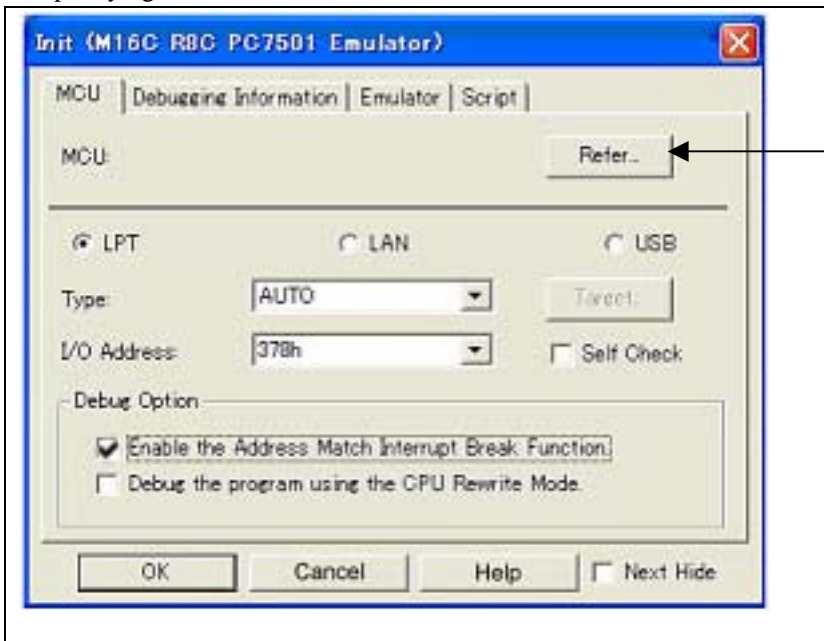

Specifying the MCU file

Specifying the MCU file

- (1) Click the "Refer..." Button.
- (2) "Select MCU File" dialog box will be displayed. Specify the MCU file "M16C6V_512.MCU" for the target MCU.

- The MCU file contains the information specific to the target MCU.
- The MCU file you have selected is displayed in the MCU section of the MCU tab.

2. Specifying the communication interface

Specifying the communication interface (LPT communication)

- For selecting the LPT communication, click the radio button "LPT" of the MCU tab.
- For the Type area, specify the LPT interface communication mode to be used.
- Specify the I/O address of the parallel port at the I/O address area.
- For BIOS setup, the following addresses are available.
 - 378h
 - 278h

Specifying the communication interface (LAN communication)

- For selecting the LAN communication, click the radio button "LAN" of the MCU tab.
- Specify the IP address of the emulator at the IP address area.
- Specify the IP address by one byte of decimal number separating each four bytes with a period.
- Specify the port number at the Port area.

Specifying the communication interface (USB communication)

- For selecting the USB communication, click the radio button "USB" of the MCU tab
- The emulators connected by USB cable are shown at Serial No. area.
- Select the serial No. of the emulator you are going to connect.

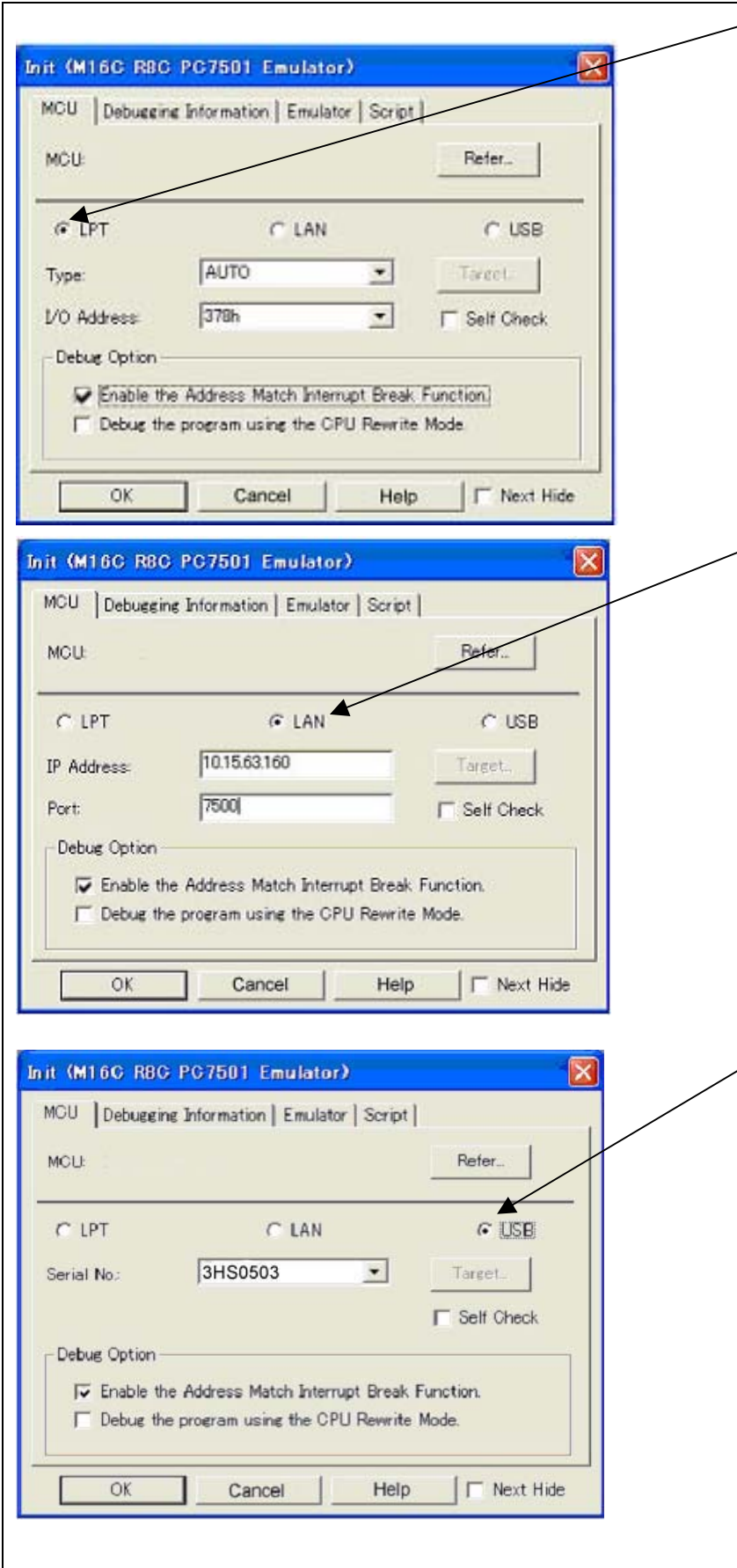

3. Executing the self-check

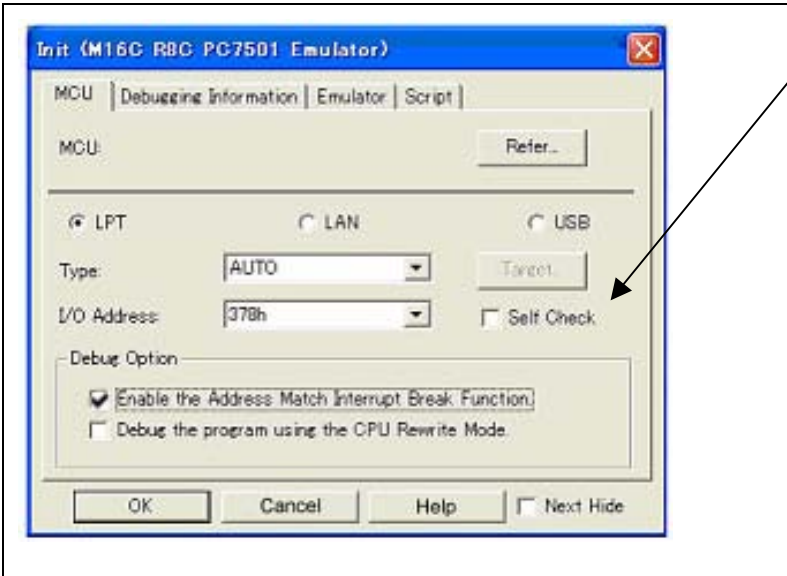

Executing the self-check

Enable this function when you want the emulator to be self-checked at startup. Be sure to select the check box only when you want the emulator to be self-checked at startup.

This function may be enabled in the following cases:

- When you are using the emulator you have just purchased, and fail to download the firmware.
- When you successfully download the firmware, but fail to start up the emulator
- When you want to confirm whether the emulator is operating normally because, for example, the MCU runs out of control or something is wrong with the trace results

This function can be enabled only when you are starting up the emulator debugger.

4. Using or not using the address match break function

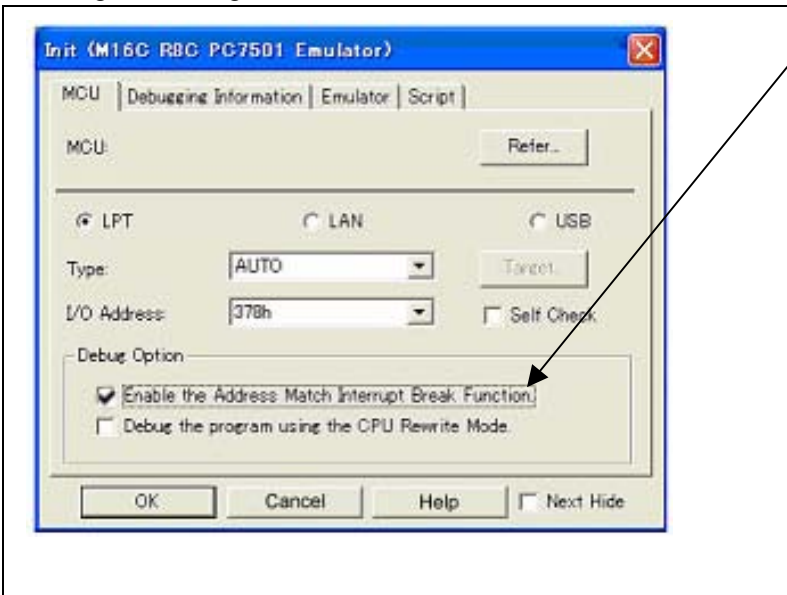

Using or not using the address match break function

Specify whether or not to use the address match break function.

- To use the address match break function (default), Select the check box. In this case, the address match interrupt is used by the emulator, and cannot be used in the user program.
- When not using the address match break function, Deselect the check box. In this case, the address match interrupt can be used in the user program.

This option can be selected or deselected only when you are starting up the emulator debugger.

5. Using or not using CPU rewrite mode

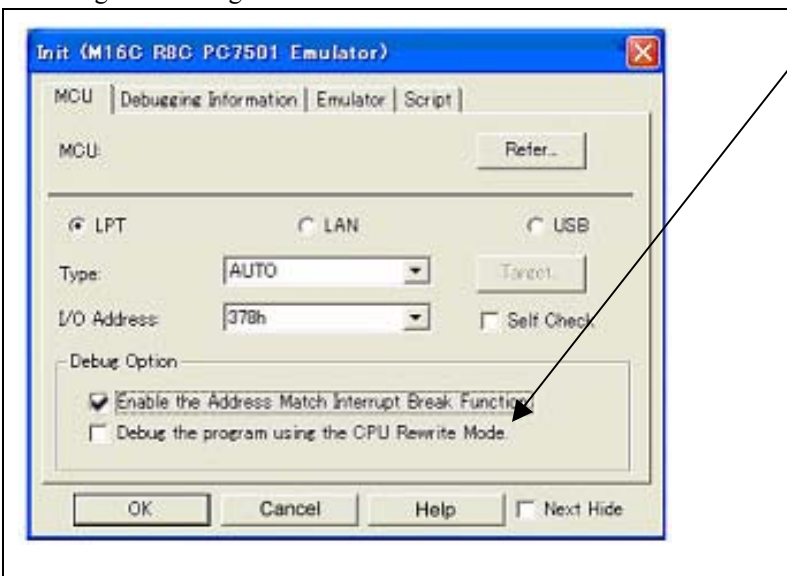

Using or not using CPU rewrite mode

Specify whether or not to debug in CPU rewrite mode. To debug the user system that uses CPU rewrite mode, select the check box. This option can be selected or deselected only when you are starting up the emulator debugger.

[Supplementary explanation]

When debugging in CPU rewrite mode is enabled, the following functions cannot be used while executing the user program:

- Setting the address match breakpoint
- Software breakpoint setting in the internal ROM area
- Execution of COME in the internal ROM area

(2) Debugging Information tab

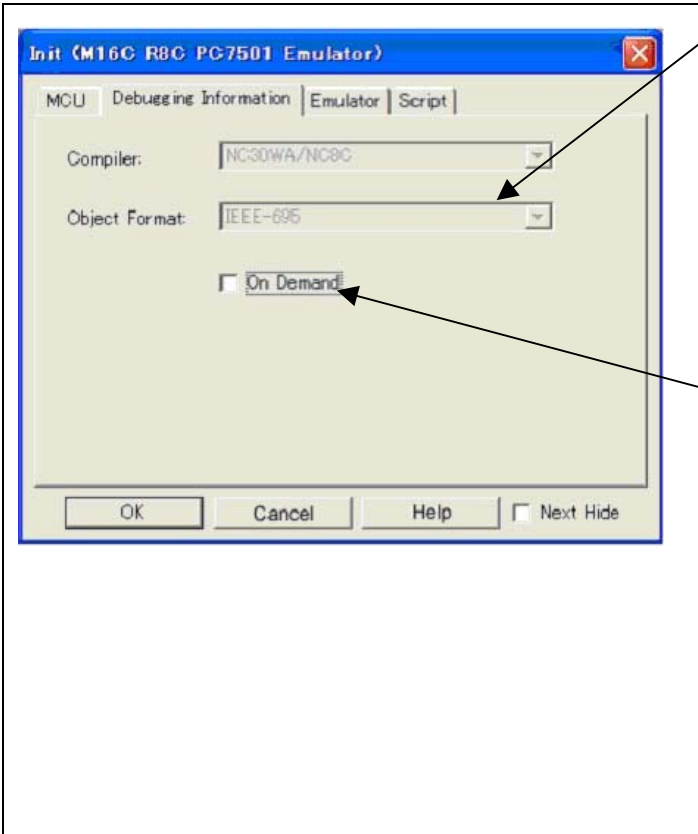

Specifying the compiler used and the object format

Specify the compiler you are using and the format of the object file output by the compiler.

- Compiler
Select the compiler you are using.
(By default, the C compiler from Renesas is selected.)
- Object Format
Select the format of the object file that is output by the compiler you are using.

Specifying the method for storing debug information

There are two methods for storing debug information: on-memory method where data is held in memory and an on-demand method where data is held in a temporary file.

When selecting the on demand method, check the [On Demand] check box.

- On Memory
Debugging information is stored in the internal memory of your computer. This method is suitable when the load module (user program) size is small.
- On Demand
Debugging information is stored in a reusable temporary file on the hard disk of your computer.
Because the stored debugging information is reused, the next time you download the same load module it can be downloaded at high speed. This method is suitable when the load module (user program) size is large.

(3) Emulator tab

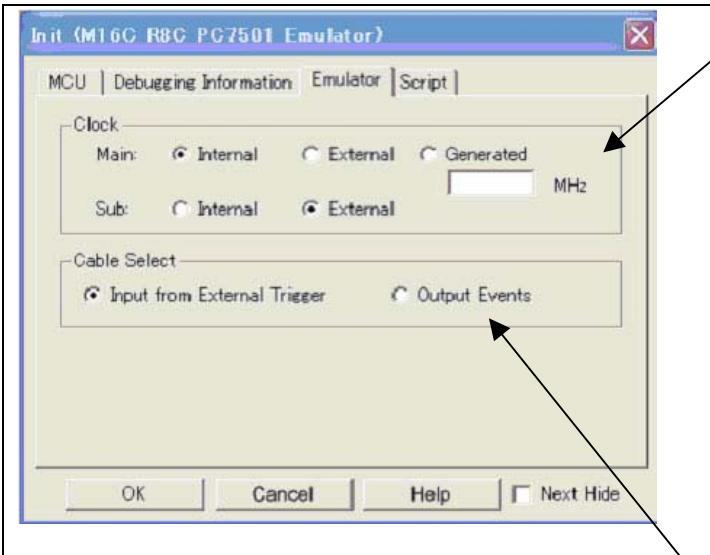

Specifying the target clock

Specify the clock sources supplied to the MCU (main clock and sub clock). Select the appropriate clock sources according to the clock used by your target MCU.

- Internal (default)
Emulator PC7501's internal clock
- External
User system clock
- Generated
Clock created in PC7501

The option you have specified here remains effective the next time you start up.

Selecting the event output/trigger input cable

Select input/output of the event output/trigger input cable of the PC7501.

- Input from External Trigger (default)
Inputs the external trigger from the cable
- Output Events
Outputs events from the cable

“Input from External Trigger” is set at startup (the previous setting becomes null).

(4) Automatically executing a script command

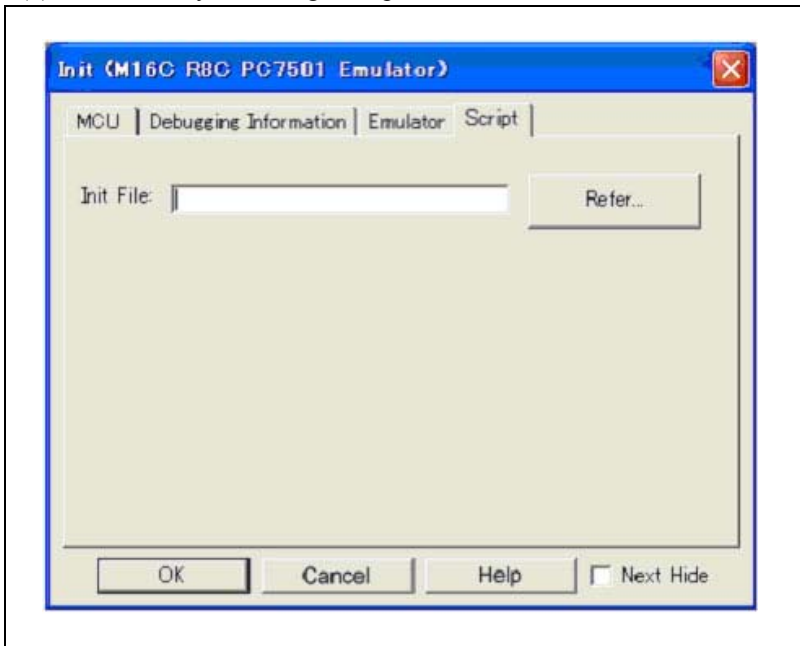
**Automatically executing a script command**

To automatically execute a script command when starting up the debugger, click the “Refer...” button and specify the script file to be executed.

Clicking the “Refer...” button brings up a file selection dialog box. The script file you have selected is displayed in the Init File: section of the dialog box shown here. If you do not want to automatically execute a script command, delete the character string displayed in the Init File: section of the dialog box.

What you specify here is reflected at only startup. If you specify back again in the Init dialog box after startup, whatever you specified has no effect. (Be sure to restart the emulator debugger.)

3.1.2 MCU Setting Dialog Box

MCU setting dialog box sets the information of the user system. It will be displayed after closing the Init dialog box.

(1) MCU tab

1. MCU Setting

Specifying the processor mode
Select the appropriate processor mode that suits your system.

Specifying the bus width
When specifying memory expansion mode or microprocessor mode, select "16-bit" for "External Data Bus Width".

Using or not using the memory space expansion function
Specifies whether or not to use the memory space expansion function when selecting memory expansion mode or microprocessor mode. When using the memory space expansion function, select "4MB Mode". When not, select "Normal Mode"

Using or not using the internal reserved area expansion
Specifies whether or not to expand the internal reserved area. Check this box if the internal reserved area expansion bit (PM13) is "1".
PM13=0:
Internal RAM area: 00400h--03FFFh
Internal ROM area: D0000h--FFFFFh
PM13=1:
Internal RAM area: 00400h--043FFFh
Internal ROM area: 80000h--FFFFFh

Switching the CS2 area
Specifies CS2 area. When using the CS2 switching bit (data block enable bit) (PM10) as "1", check this box.
PM10 = 0: 09000h--26FFFh
PM10 = 1: 10000h--26FFFh

IMPORTANT

Notes on Selecting a Processor Mode:

- When setting single-chip mode or memory expansion mode, the level of pin CNVSS of the MCU status should be "L". The MCU status shows the pin level of the user system.
- When setting microprocessor mode, the level of pin CNVSS of the MCU status should be "H".
- When setting memory expansion mode or microprocessor mode, pins RDY* and HOLD* of the user system should be "H".
- When the user system is not connected, all modes are available.

2. Option

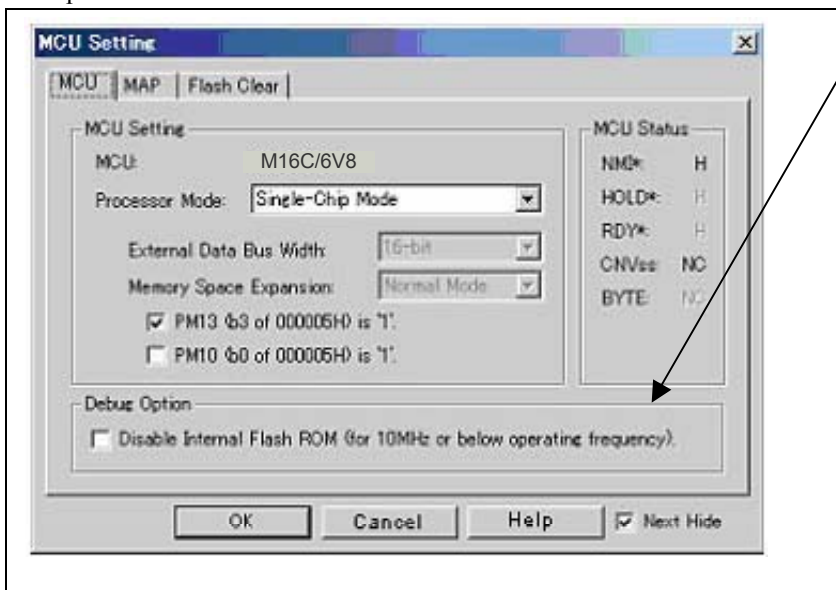
**Setting the debug options**

Check the box when not downloading the program to the internal flash ROM of the MCU. If this box is checked, the working efficiency (downloading, software break, etc.) will be improved because the program is downloaded in the emulation memory in the PC7501. However, maximum operating frequency is 10MHz. The box is unchecked by default.

3. MCU Status

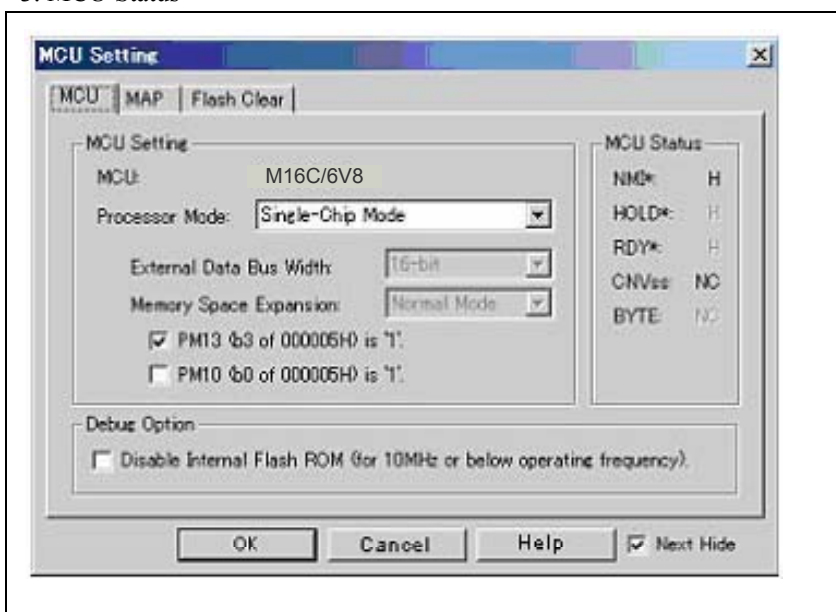
**Referring to the MCU Status**

It shows the status of each MCU pin. Check it to see if the MCU status matches the selected processor mode. "NC" means that the pin status is indeterminate.

IMPORTANT

Notes on Selecting a Processor Mode:

- The MCU status is shown in "MCU Status" of the EMEM dialog box. Check that it matches to the processor mode to be set.
- Check that the RDY* and HOLD* are "H" level. If they are "L" level, as the MCU enters a wait status and the emulator debugger cannot receive the signal from the MCU, an error is displayed.

(2) MAP tab

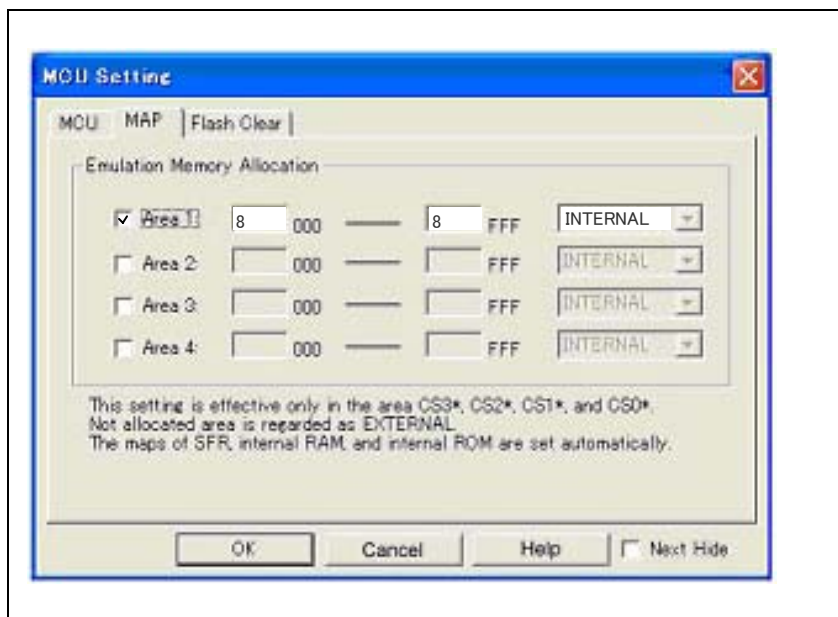
Specifying the emulation memory allocation

Sets the memory area assigned to the emulation memory by 4KB. Up to four areas can be set.

An area set to [INTERNAL] will be allocated to the emulation memory. An unchecked area or an unset area will be allocated to external area.

The setting is effective only in the CS3*, CS2*, CS1* and CS0*. The maps of SFR, internal ROM and RAM are set automatically.

Be sure to set the OSDRAM area (8000h -- 8FFFh) to INTERNAL, and set the OSDROM area (30000h -- 4FFFFh) to EXTERNAL (default).

(3) Flash Clear

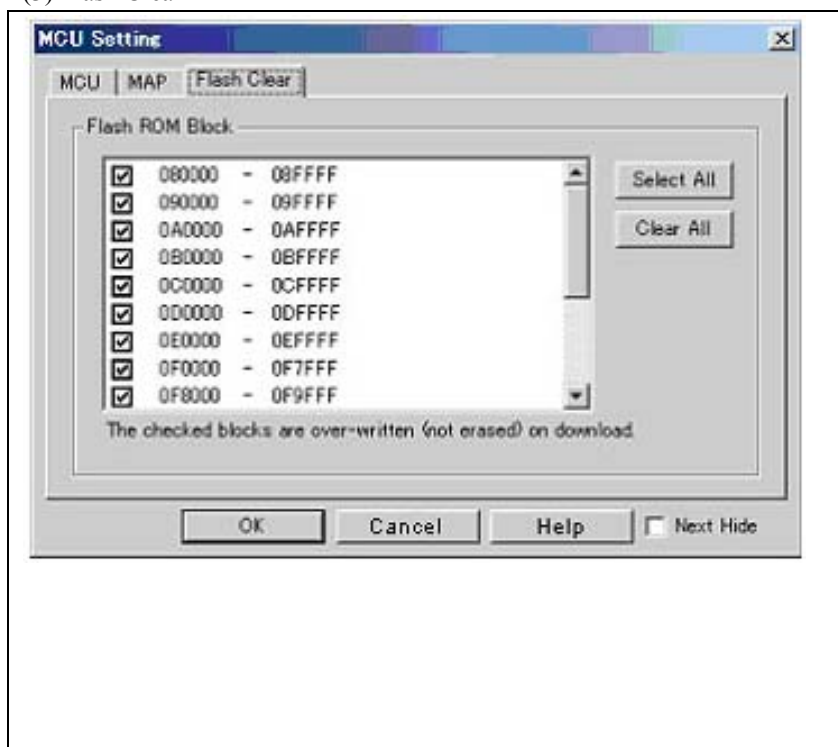
Setting to clear the MCU's internal flash ROM

Specify whether or not you want the MCU's internal flash ROM to be cleared when downloading the user program or data. (When cleared, the content of the flash ROM is initialized to 0xFF.) The MCU's internal flash ROM is listed in block units.

- Any block which has had its check box selected is not cleared when downloading. The memory content of this block remains intact unless overwritten by downloading.
- Any block which has had its check box deselected is cleared when downloading.
- Click the Select All button, and all blocks will be selected (marked by a check mark, so that none of the blocks is cleared when downloading).
- Click the Clear All button, and all blocks will be deselected (check marks removed, so that all of them are cleared when downloading).

The option you have specified here remains effective the next time you start up.

3.1.3 Checking Connections of the Emulator System

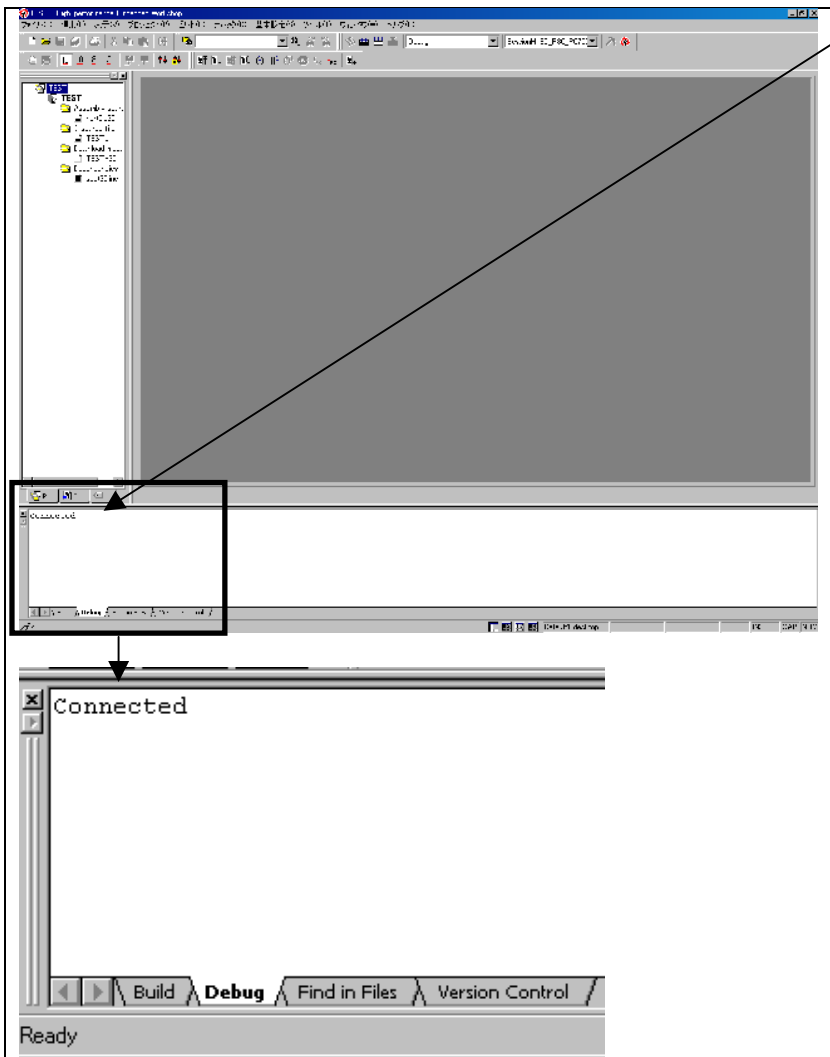
**Checking connections of the emulator system**

When the emulator debugger is connected correctly to the emulator after you've finished setting up the Init dialog box and the MCU Setting dialog box, you will see a message "Connected" displayed on the Debug tab of the Output window.

3.2 Editor (Source) Window

(1) Program window

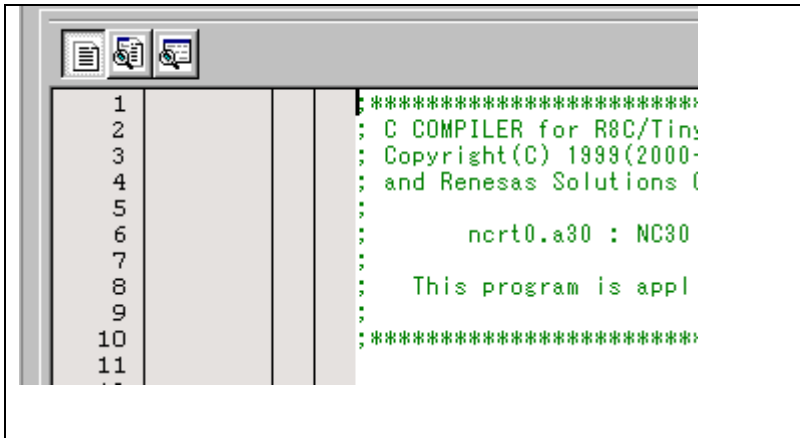

Editor (Source) window

The editor (source) window is a window that always shows the content of the source file corresponding to the current position of the program counter. It automatically opens when the emulator starts up. The program counter position is identified by the yellow background color. Here, you can execute the program up to the cursor position, set or clear software breakpoints, and line-assemble the source file.

Because the present emulator uses the MCU's internal flash ROM, the initial value for the ROM area data at the time of purchase is "FFh."

(2) Program execution



CPU reset

Resets the CPU.

Go

Runs the program beginning with the current PC position.

Reset Go

Runs the program after reset.

Step In

Single-steps the program executing each statement (including those in functions).

Step Over

Single-steps the program executing each function call as one step.

Step Out

Exists a function and stops at a statement in the program next to the one that called the function.

STOP

Stops the program.

(3) Setting break points

1. Screen after software breakpoint setup

63			N_BZERO .macro TOP_,SECT_
64	f0039	●	mov.b #00H, R0L
65	f003a		mov.w #(TOP_ & 0FFFFH), A1
66	f003d	●	mov.w #sizeof SECT_, R3
67	f0041		sstr.b
68			.endm
69			
70			N_BCOPY .macro FROM_,TO_,SECT_
71	f0061		mov.w #(FROM_ & 0FFFFH), A0
72	f0064		mov.b #(FROM_ >>16), R1H
73	f0067		mov.w #TO_, A1
74	f006a		mov.w #sizeof SECT_, R3
75	f006e	➡	smovf.b
76			.endm
77			
78			BZERO .macro TOP_,SECT_
79	f009d		push.w #sizeof SECT_ >> 16
80	f00a1		push.w #sizeof SECT_ & 0ffffh
81	f00a5		pusha TOP_ >>16
82	f00a9		pusha TOP_ & 0ffffh
83			

Breakpoint setup screen

There are three types of breakpoints as described below.

- Address match breakpoint

This breakpoint can be set only when you chose to use the address match break function on the MCU tab of the Init dialog box.

A breakpoint can be set or cleared by double-clicking in the address match breakpoint display area in the editor (source) window. (A blue circle is displayed at the setting line)

Up to eight breakpoints can be set. When this limit is exceeded, software breakpoints are set.

The address match break causes the program to stop before executing the address at which a breakpoint is set.
- Software breakpoint

A software breakpoint can be set or cleared by double-clicking the software breakpoint display area in the editor (source) window (A red circle is displayed at the setting line).

This is rewritten to a break instruction, therefore, because of rewriting flash ROM, program execution starts with a delay of several seconds after setting ROM area.

If the breakpoint you set is a software breakpoint, the program stops before executing the instruction at the set breakpoint.
- Hardware breakpoint

A hardware breakpoint can be set or cleared by right-clicking the breakpoint display area.

If the breakpoint you set is a hardware breakpoint, the program stops after executing the instruction at the set breakpoint (after several cycles).

(4) Executing up to the cursor position (Come command)

1. Specifying the Come command

60		;	-----
61		;	Initialize Macro declaration
62		;	-----
63		N_BZERO	.macro TOP_,SECT_
64	f0039	mov.b	#00H, R0L
65	f003a	mov.w	##(TOP_ & 0FFFFH), A1
66	f003d	mov.w	##sizeof SECT_ , R3
67	f0041	sstr.b	
68		.endm	
69			
70		N_BCOPY	.macro FROM_,TO_,SECT_
71	f0061	mov.w	##(FROM_ & 0FFFFH),A0
72	f0064	mov.b	##(FROM_ >>16),R1H
73	f0067	mov.w	##TO_ ,A1
74	f006a	mov.w	##sizeof SECT_ , R3
75	f006e	smovf.b	
76		.endm	
77			

Setup procedure for executing COME command

(1) Click the line in the program display area at which you want the program to execute.



(2) Click the Come button

2. After the Come command has finished

60		;	-----
61		;	Initialize Macro declaration
62		;	-----
63		N_BZERO	.macro TOP_,SECT_
64	f0039	mov.b	#00H, R0L
65	f003a	mov.w	##(TOP_ & 0FFFFH), A1
66	f003d	mov.w	##sizeof SECT_ , R3
67	f0041	sstr.b	
68		.endm	
69			
70		N_BCOPY	.macro FROM_,TO_,SECT_
71	f0061	mov.w	##(FROM_ & 0FFFFH),A0
72	f0064	mov.b	##(FROM_ >>16),R1H
73	f0067	mov.w	##TO_ ,A1
74	f006a	mov.w	##sizeof SECT_ , R3
75	f006e	smovf.b	
76		.endm	
77			

3.3 Hardware Breakpoint Setting Window

(1) Breakpoint setup dialog box

1. Opening the hardware breakpoint setup dialog box



Hardware Break Point
 Clicking this button opens the hardware breakpoint setup dialog box.

2. Hardware Break Point Setting Window in initial state

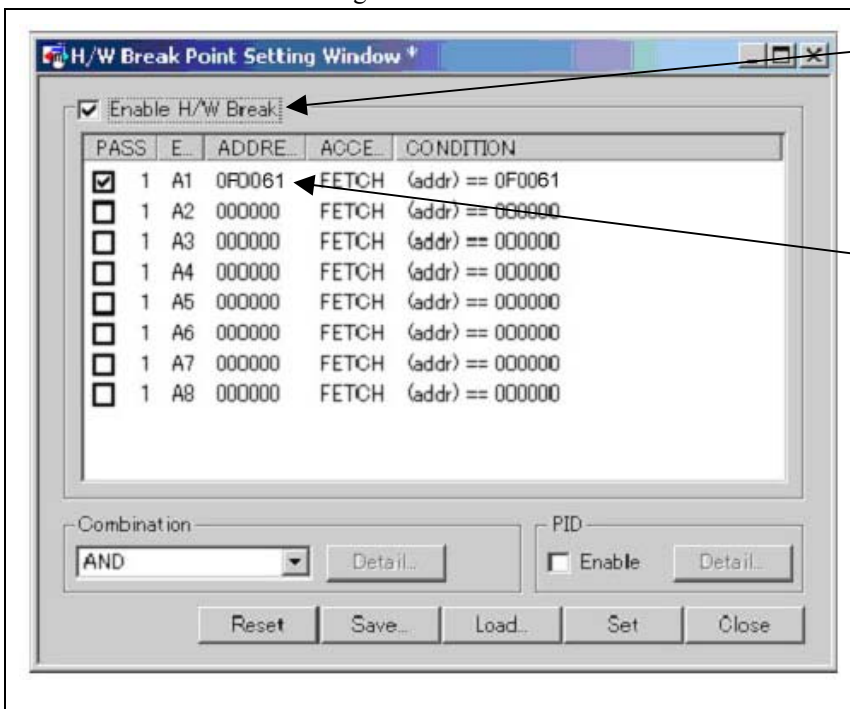

H/W breakpoint Setting Window in initial state
 Select the "Enable H/W Break" check box, and this break function will be enabled, allowing you to set hardware breakpoints.

Setting Break Event
 Click the event line at which you want set a break event.

3. Opening the break event setting dialog box



Specifying the event type

Click to select the event type you want to set.

- FETCH
Detects an instruction prefetch.
- DATA ACCESS
Detects a memory access.
- BIT SYMBOL
Detects a bit access.
- INTERRUPT
Detects an interrupt occurrence or interrupt termination.
- TRIGGER
Detects a signal from the external trace signal input cable.

(2) When FETCH is selected

1. Window for setting addresses

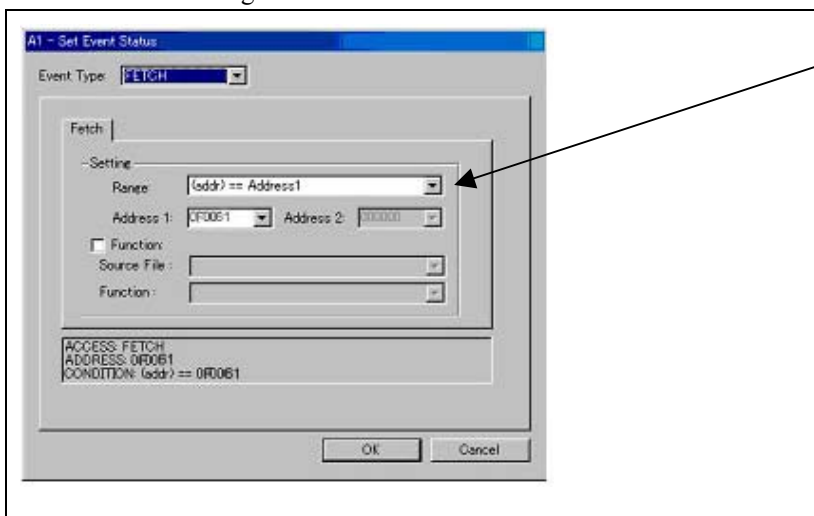

Setting the address

You can set eight conditions, e.g., a specified address, a specified address range, etc. When you have finished setting the address, click OK.

(3) When DATA ACCESS is selected

1. Window for setting the address

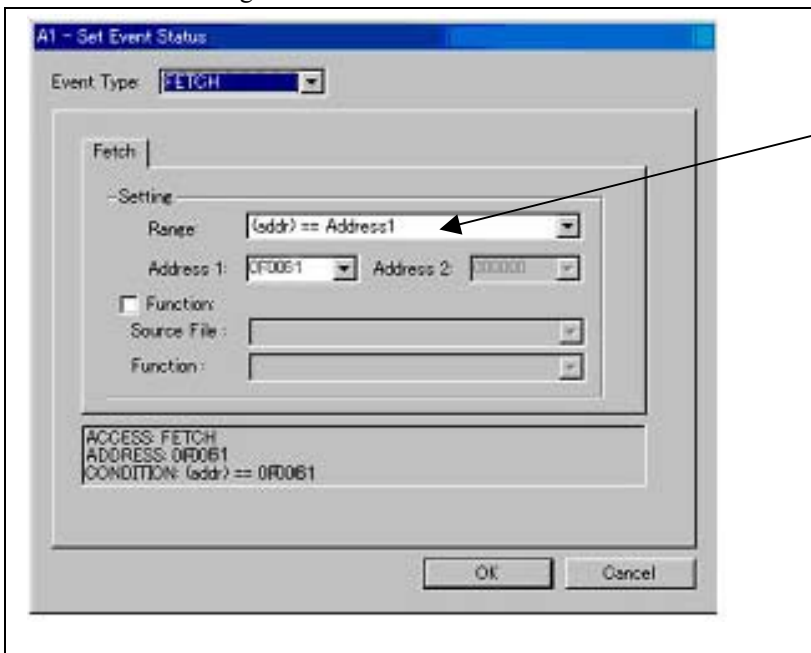

Setting the address
 You can set eight conditions, e.g., a specified address, a specified address range, etc.
 When you have finished setting the address, click OK.

2. Window for setting data

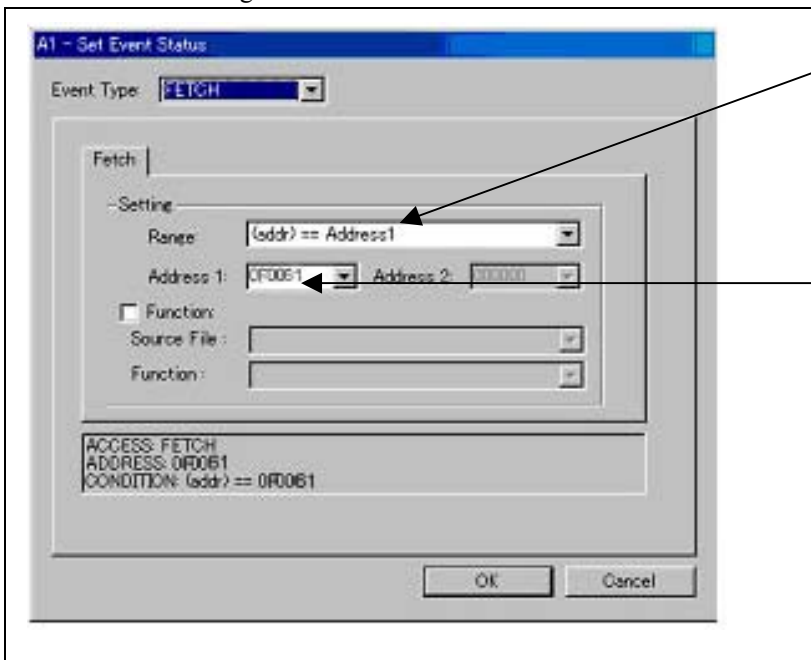

Setting data
 You can set eight conditions, e.g., a specified data, a specified data range, etc.

Setting the access condition
 You can set three conditions, e.g., read, write, and read/write. When you have finished setting the data and access condition, click OK.

3. Example Data Settings

Setting events for wordwise accesses to the even-addresses

STE.W A0,20E8h(A0=5423h)

Cycle	Label	Address	Data	BUS	BHE	BIU	R/W	RWT	CPU
-00023		0020E8	5423	16b	0	DW	W	0	CW

High-order and low-order data effective

Setting events for wordwise accesses to the odd-addresses

STE.W A0,20E5h(A0=AB79h)

Cycle	Label	Address	Data	BUS	BHE	BIU	R/W	RWT	CPU
-00021		0020E5	79AB	16b	0	DW	W	0	CB
-00020		0020E6	79AB	16b	1	DW	W	0	CB

Odd-address high-order data effective

Even-address low-order data effective

Setting events for wordwise accesses to the even-addresses

STE.B R0L,[A1A0](R0L=E5h,A1=0000h,A0=20E2h)

Cycle	Label	Address	Data	BUS	BHE	BIU	R/W	RWT	CPU
-00022		0020E2	00E5	16b	1	DB	W	0	CB

Low-order data effective

Setting events for wordwise accesses to the odd-addresses

STE.B R0L,[A1A0](R0L=E6h,A1=0000h,A0=20E3h)

Cycle	Label	Address	Data	BUS	BHE	BIU	R/W	RWT	CPU
-00022		0020E3	E600	16b	0	DB	W	0	CB

High-order data effective

Setting a break event

A1
Address 1 : 0020E8
Data 1 : 5423
MASK : FFFF
Access : WRITE

Setting a break event (using 2 events)

A1 A2
Address 1 : 0020E5 Address 1 : 0020E6
Data 1 : 7900 Data 1 : 00AB
MASK : FF00 MASK : 00FF
Access : WRITE Access : WRITE

Set the combinatorial events to AND.

Setting a break event

A1
Address 1 : 0020E2
Data 1 : 00E5
MASK : 00FF
Access : WRITE

Setting a break event

A1
Address 1 : 0020E3
Data 1 : E600
MASK : FF00
Access : WRITE

(4) Setting the combinatorial event condition

1. Window for setting the combinatorial event condition

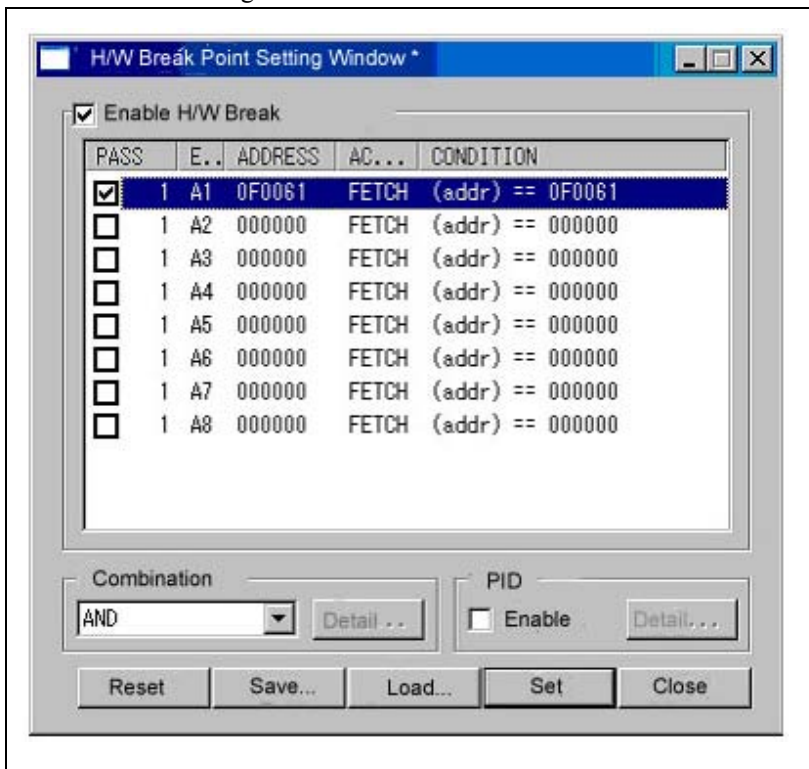
**Setting the combinatorial event condition**

There are following four conditions that you can choose for the combinatorial events.

- AND
The program breaks when all of the specified events occur.
- AND (Same Time)
The program breaks when the specified events occur at the same time.
- OR
The program breaks when one of the specified events occurs.
- STATE TRANSITION
The program breaks when the state transition diagram goes into the break state.

For each event, a pass count (number of passing) is specifiable (1--255). When "AND" (same time) is specified for Combination, you can not specify the pass count (fixed to one).

When you have finished setting the combinatorial event condition, click the "Set" button.

3.4 Trace Window

The trace window is used to show the results of real-time trace measurements.

(1) Trace window

1. Trace window display

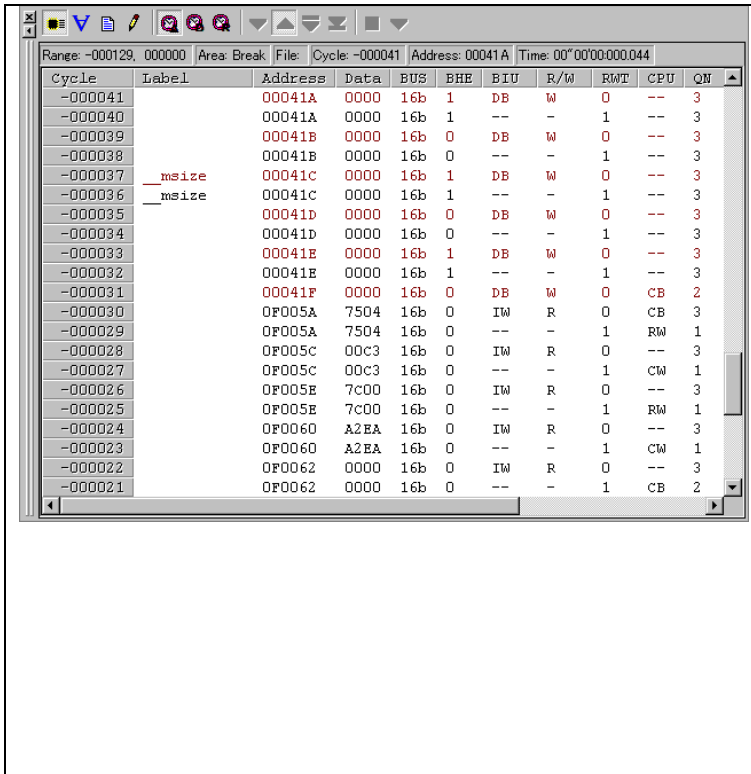

Cycle	Label	Address	Data	BUS	BHE	BIU	R/W	RWT	CPU	QM
-000041		00041A	0000	16b	1	DB	W	0	--	3
-000040		00041A	0000	16b	1	--	--	1	--	3
-000039		00041B	0000	16b	0	DB	W	0	--	3
-000038		00041B	0000	16b	0	--	--	1	--	3
-000037	_msize	00041C	0000	16b	1	DB	W	0	--	3
-000036	_msize	00041C	0000	16b	1	--	--	1	--	3
-000035		00041D	0000	16b	0	DB	W	0	--	3
-000034		00041D	0000	16b	0	--	--	1	--	3
-000033		00041E	0000	16b	1	DB	W	0	--	3
-000032		00041E	0000	16b	1	--	--	1	--	3
-000031		00041F	0000	16b	0	DB	W	0	CB	2
-000030		0F005A	7504	16b	0	IW	R	0	CB	3
-000029		0F005A	7504	16b	0	--	--	1	RW	1
-000028		0F005C	00C3	16b	0	IW	R	0	--	3
-000027		0F005C	00C3	16b	0	--	--	1	CW	1
-000026		0F005E	7c00	16b	0	IW	R	0	--	3
-000025		0F005E	7c00	16b	0	--	--	1	RW	1
-000024		0F0060	A2EA	16b	0	IW	R	0	--	3
-000023		0F0060	A2EA	16b	0	--	--	1	CW	1
-000022		0F0062	0000	16b	0	IW	R	0	--	3
-000021		0F0062	0000	16b	0	--	--	1	CB	2

Trace window

The trace window is used to show the results of real-time trace measurements. It has the following four display modes:

- Bus mode
Bus information per cycle can be inspected. The contents are displayed in order of execution paths.
- Disassemble + data access mixed mode
The executed instruction and the content of the accessed data can be inspected together. Contents are displayed in order of the execution paths.
- Disassemble mode
The execution paths of the executed instructions can be inspected. The contents are displayed in order of execution paths.
- Source mode
The execution paths of the source program can be inspected.

These modes can be switched over using the respective toolbar buttons.

The trace window shows the measurement result when a real-time trace measurement has finished. The trace window remains blank until the real-time trace measurement in progress finishes.

2. Trace window (Bus display)

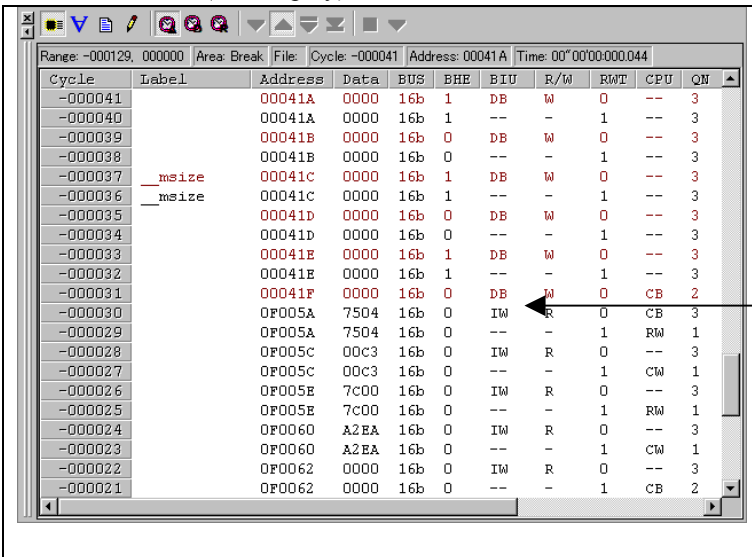

Explanation of the trace window (bus display)

The following explains the displayed contents, from left to right.

- Address
Shows the status of the address bus.
- Data
Shows the status of the data bus.
- BUS
Shows the width of the external data bus. In the present emulator, only "16b" for 16 bits wide bus is displayed.
- BHE*
Shows the status (0 or 1) of the BHE (Byte High Enable) signal. If this signal = 0, the odd-address data is valid.
- BIU
Shows the status between the BIU (Bus Interface Unit) and memory or I/O.

Symbol Status

- : No change
- DMA : Data access except for CPU
- INT : Starts INTACK sequence
- IB : Instruction code read (bytes) by CPU
- DB : Data access (bytes) by CPU
- IW : Instruction code read (words) by CPU
- DW : Data access (words) by CPU

- R/W
Shows the status of the data bus. Displayed as "R" for Read, "W" for Write, and "--" for no access.

- RWT
This is the signal to indicate a valid bus cycle. When valid, RWT = 0. The Address, Data, and the BIU signals are effective when this signal is 0.

- CPU
Shows the status between the CPU and BIU (Bus Interface Unit).

Symbol Status

- CB : Op-code read (bytes)
- RB : Operand read (bytes)
- QC : Clears instruction queue buffer
- CW : Op-code read (words)
- RW : Operand read (words)

- QN
Shows the byte count stored in the instruction queue buffer. The display range is 0 to 4.

- 76543210
Shows the level of external trace signal input cable EXTIN0 to EXTIN7.

- h" m' s: ms. us
Shows the elapsed time after starting the user program.

3. Trace window (Disassemble display)

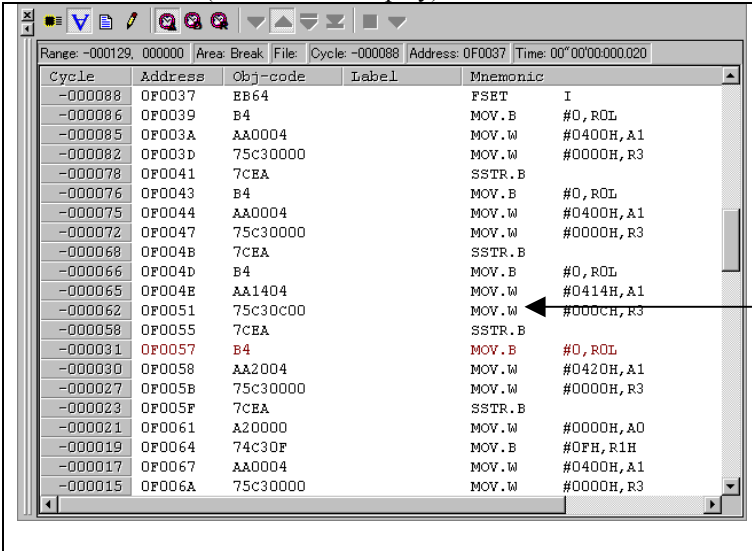

4. Trace window (Source display)

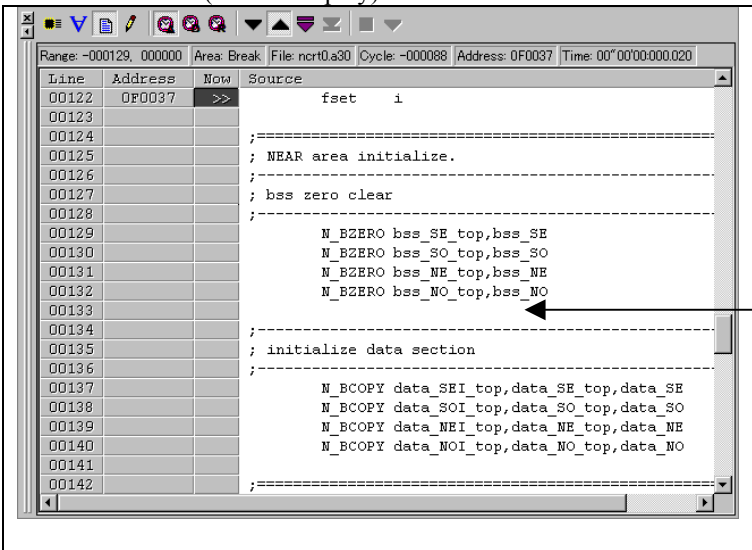

(2) Trace point setup window

1 Trace point setup window

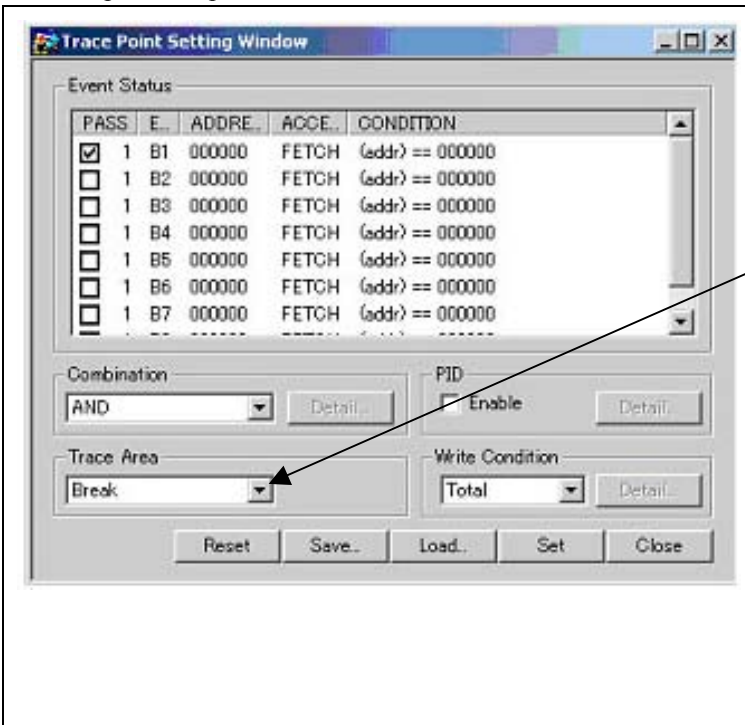

Trace Point Setting Window in initial state

 Clicking this toolbar button opens the trace point setting window.

You can set events in the same way as for the hardware breakpoints.

Specifying a trace range

You can specify a trace range for the trace event.

- Break
256K cycles of instruction execution before the user program stopped is recorded.
- Before
256K cycles of instruction execution before a trace point condition was met is recorded.
- About
128K cycles of instruction execution before and after a trace point condition was met is recorded.
- After
256K cycles of instruction execution after a trace point condition was met is recorded.
- Full
256K cycles of instruction execution after a trace began is recorded.

2. Setting the trace write condition

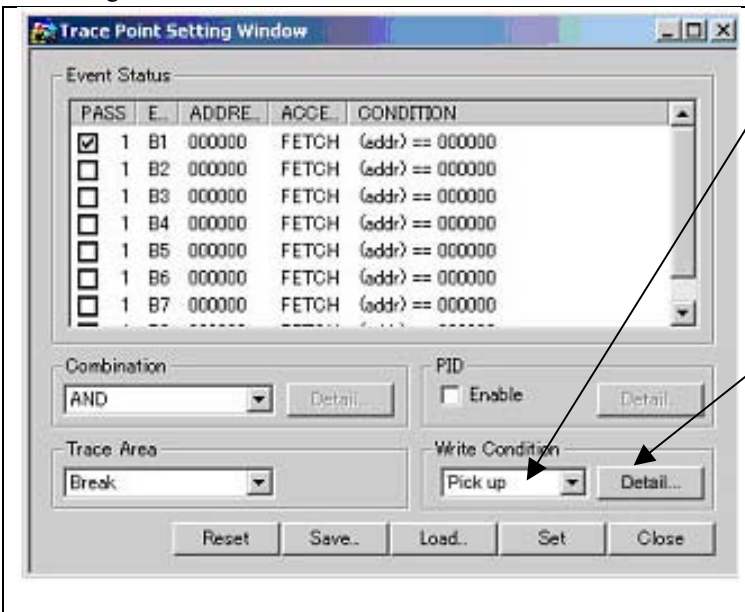

Setting the trace write condition

You can specify a condition for the cycles to be written into the trace memory.

- Total
All cycles are written into memory.
- Pick up
Only the cycles in which the specified condition was met are written into memory.
- Exclude
Only the cycles in which the specified condition was not met are written into memory.

When you have finished setting the trace write condition, click this button. The Realtime-trace Write Condition dialog box shown below will appear.

3. Realtime trace Write Condition dialog box

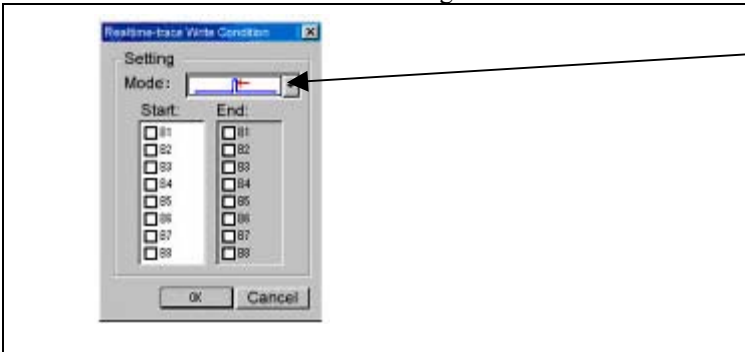

Write mode

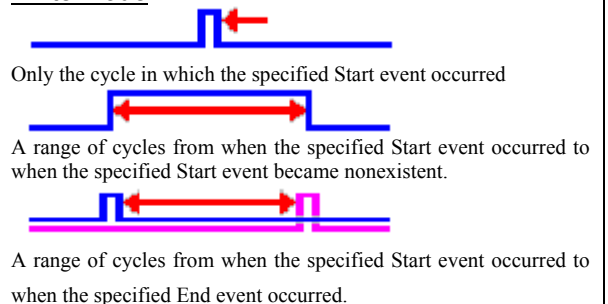

3.5 RAM Monitor Window

This function makes it possible to make reference to the changes in memory contents without impairing the real-time performance for target program execution. The emulator PC7501 system is provided with the 4KB RAM monitor area. This RAM monitor area can be divided into the 16-block area in units of arbitrary continuous address or 256 bytes for mapping or layout.

(1) RAM monitor window

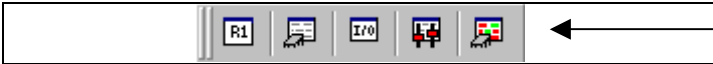

RAM monitor
Clicking this button opens the RAM monitor window.

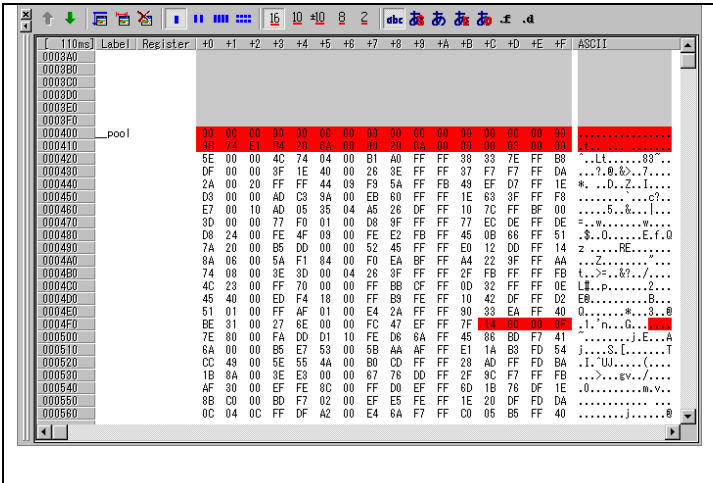

Changing the RAM monitor display area
You can change the manner in which the RAM monitor area you have set in the above dialog box is displayed.

- : Shows the blocks at the preceding addresses.
- : Shows the blocks at the following addresses.

The background colors of the data display and the code display sections change with the access attribute as described below.

- Green : Addresses accessed for read
- Red : Addresses accessed for write
- White : Addresses not accessed

The background colors can be changed as necessary.

1. RAM monitor area setting window in initial state

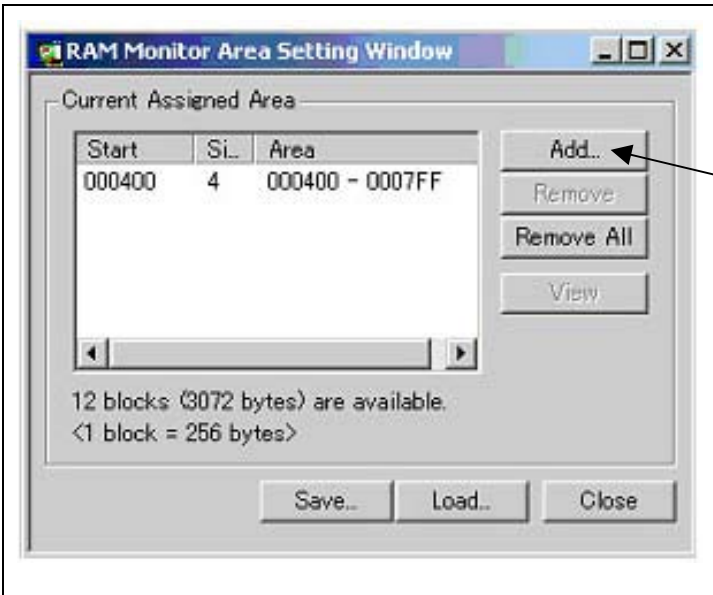

RAM Monitor Area Setting Window in initial state
By default, the monitor area is set to 000400h through 0007FFh. To change it, click the line you want to set.

Specifying the start address
You can set the start address of the RAM area to be monitored. To add a RAM monitor area, click the "Add..." button. The RAM Monitor Area Setting Window will be displayed.

2. RAM monitor area setting dialog box

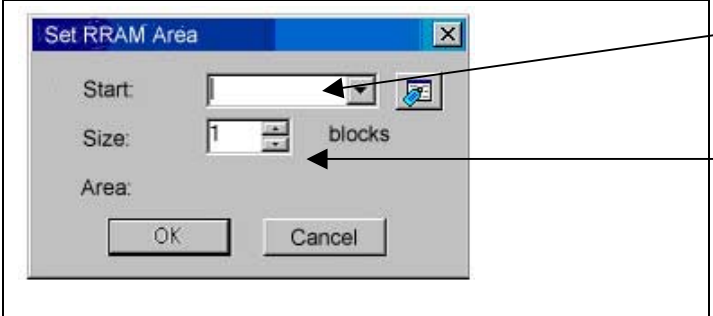

Specifying the start address
You can set the start address of the RAM area to be monitored.

Specifying the size
You can set the size to be monitored by specifying the number of blocks from the start address. One block is 256 bytes in size.

4. Hardware Specifications

This chapter describes specifications of this product.

4.1 Target MCU Specifications

Table 4.1 lists the specifications of target MCUs which can be debugged with this product.

Table 4.1 Specifications of target MCUs for the M306V8T-EPB

Item	Description
Applicable MCU	M16C/60 Series M16C/6V Group M306V8
Evaluation MCU	M306V8FJGS ROM size : 512KB + 4KB , RAM size : 16KB
Applicable MCU mode	Single-chip mode Memory expansion mode 16 bit bus width (NORMAL, 4MB) Microprocessor mode 16 bit bus width (NORMAL, 4MB)
Maxi. ROM/RAM capacity	1. MCU internal flash ROM: 516KB (0F000h--0FFFFh, 80000h--FFFFFh) 2. MCU internal RAM: 16KB (00400h--043FFh) 3. MCU internal flash OSDRAM: 4KB (08000h--08FFFh) 4. MCU internal flash OSDROM: 128KB (30000h--4FFFFh)
Power supply voltage	$3.15 \text{ V} \leq V_{cc1} = V_{cc2} = V_{cc3} \leq 3.45 \text{ V}$
Operating voltage/frequency	Power supply voltage 3.15 to 3.45 V; 16 MHz

4.2 Access Timing

Because this product emulates some ports, access timings are different from those of the actual MCUs. Chapter 4.2.1 describes the access timing using this product.

4.2.1 Operation Timing of Memory Expansion Mode and Microprocessor Mode (Vcc1=Vcc2=Vcc3=3.3V)

(1) Separate Bus Timing

Table 4.2 and Figure 4.1 show the bus timing in memory expansion mode and microprocessor mode.

Table 4.2 Memory expansion mode and microprocessor mode (3-wait, accessing external area)

Symbol	Item	Actual MCU [ns]		This product [ns]	
		Min.	Max.	Min.	Max.
td(BCLK-AD)	Address output delay time		30		36
th(BCLK-AD)	Address output hold time (BCLK standard)	4		See left	
th(RD-AD)	Address output hold time (RD standard)	0		-3	
th(WR-AD)	Address output hold time (WR standard)	(*2)		(*3)	
td(BCLK-CS)	Chip-select output delay time		30		See left
th(BCLK-CS)	Chip-select output hold time (BCLK standard)	4		See left	
td(BCLK-ALE)	ALE signal output delay time		30		See left
th(BCLK-ALE)	ALE signal output hold time	-4		See left	
td(BCLK-RD)	RD signal output delay time		30		33
th(BCLK-RD)	RD signal output hold time	0		See left	
td(BCLK-WR)	WR signal output delay time		30		38
th(BCLK-WR)	WR signal output hold time	0		See left	
td(BCLK-DB)	Data output delay time (BCLK standard)		40		43
th(BCLK-DB)	Data output hold time (BCLK standard)	4		See left	
td(DB-WR)	Data output delay time (WR standard)	(*1)		See left	
th(WR-DB)	Data output hold time (WR standard)	(*2)		(*3)	

*1 Calculated by the following formula according to the frequency of BCLK.

$$\frac{(n - 0.5) \times 10^9}{f(BCLK)} - 40 \quad [\text{ns}] \quad n: "3" \text{ for 3-wait}$$

*2 Calculated by the following formula according to the frequency of BCLK.

$$\frac{0.5 \times 10^9}{f(BCLK)} \quad [\text{ns}]$$

*3 Calculated by the following formula according to the frequency of BCLK.

$$\frac{0.5 \times 10^9}{f(BCLK)} - 17 \quad [\text{ns}]$$

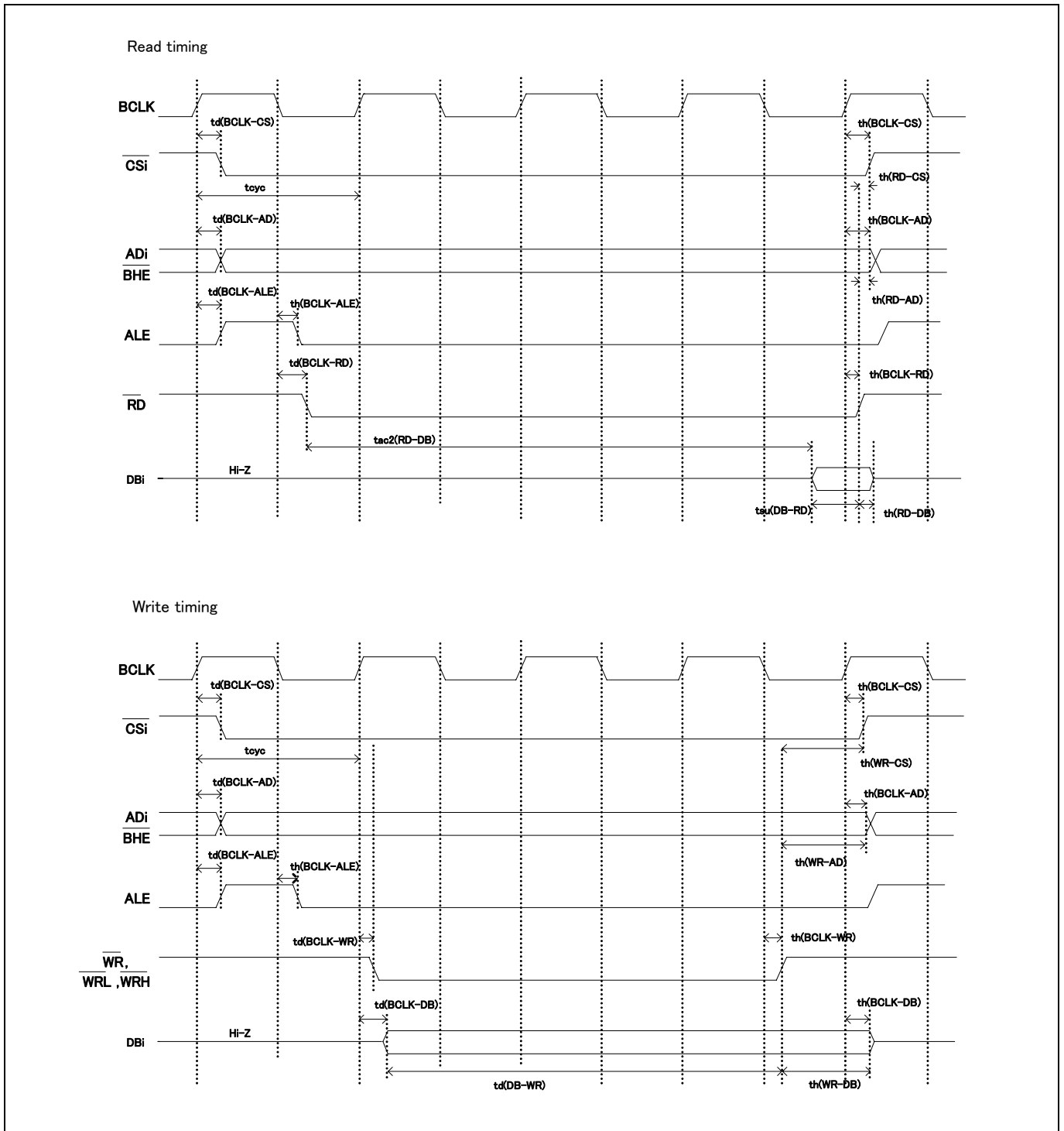

Figure 4.1 Memory expansion mode and microprocessor mode (3-wait, accessing external area)

(2) Multiplex Bus Timing

Table 4.3 and Figure 4.2 show the bus timing in memory expansion mode and microprocessor mode (2-wait, accessing external area, using multiplex bus).

Table 4.3 Memory expansion mode and microprocessor mode (2-wait, accessing external area, using multiplex bus)

Symbol	Item	Actual MCU [ns]		This product [ns]	
		Min.	Max.	Min.	Max.
td(BCLK-AD)	Address output delay time		50		See left
th(BCLK-AD)	Address output hold time (BCLK standard)	4		See left	
th(RD-AD)	Address output hold time (RD standard)	(*1)		(*4)	
th(WR-AD)	Address output hold time (WR standard)	(*1)		(*4)	
td(BCLK-CS)	Chip-select output delay time		50		See left
th(BCLK-CS)	Chip-select output hold time (BCLK standard)	4		See left	
th(RD-CS)	Chip-select output hold time (RD standard)	(*1)		See left	
th(WR-CS)	Chip-select output hold time (WR standard)	(*1)		See left	
td(BCLK-RD)	RD signal output delay time		40		See left
th(BCLK-RD)	RD signal output hold time	0		See left	
td(BCLK-WR)	WR signal output delay time		40		See left
th(BCLK-WR)	WR signal output hold time	0		See left	
td(BCLK-DB)	Data output delay time (BCLK standard)		50		See left
th(BCLK-DB)	Data output hold time (BCLK standard)	4		See left	
td(DB-WR)	Data output delay time (WR standard)	(*2)		See left	
th(WR-DB)	Data output hold time (WR standard)	(*1)		See left	
td(BCLK-ALE)	ALE output delay time (BCLK standard)		40		See left
th(BCLK-ALE)	ALE output hold time (BCLK standard)	-4		See left	
td(AD-ALE)	ALE output delay time (Address standard)	(*3)		See left	
th(ALE-AD)	ALE output hold time (Address standard)	(*4)		See left	
td(AD-RD)	After address RD signal output delay time	0		-25	
td(AD-WR)	After address WR signal output delay time	0		-25	
tdz(RD-AD)	Address output floating start time		8		25

*1 Calculated by the following formula according to the frequency of BCLK.

$$\frac{0.5 \times 10^9}{f(BCLK)} \quad [\text{ns}]$$

*2 Calculated by the following formula according to the frequency of BCLK.

$$\frac{(n - 0.5) \times 10^9}{f(BCLK)} - 50 \quad [\text{ns}] \quad n: "2" \text{ for 2-wait}$$

*3 Calculated by the following formula according to the frequency of BCLK.

$$\frac{0.5 \times 10^9}{f(BCLK)} - 40 \quad [\text{ns}]$$

*4 Calculated by the following formula according to the frequency of BCLK.

$$\frac{0.5 \times 10^9}{f(BCLK)} - 15 \quad [\text{ns}]$$

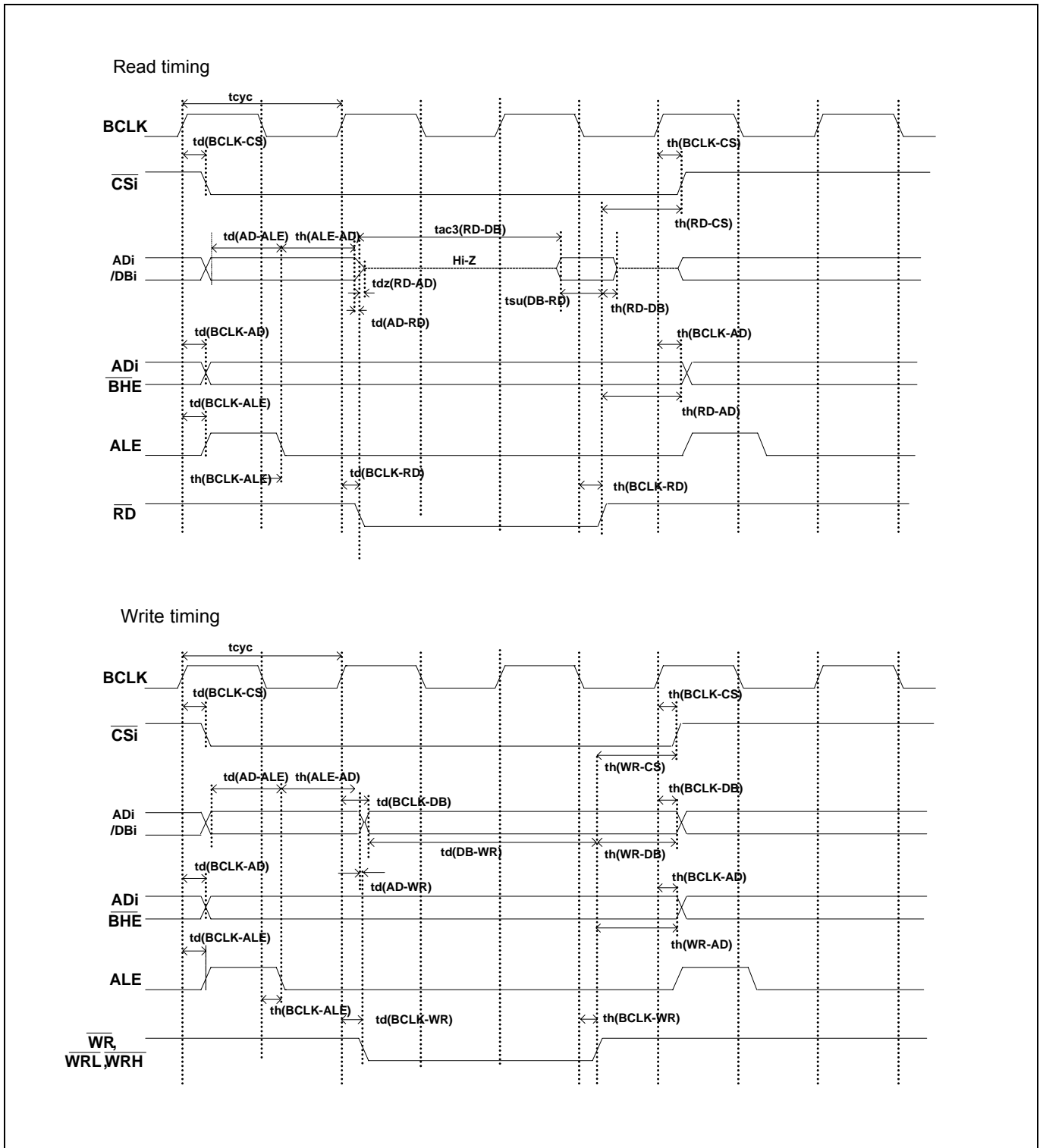

Figure 4.2 Memory expansion mode and microprocessor mode (2-wait, accessing external area, using multiplex bus)

(3) Timing Requirements

Tables 4.4 and Figure 4.3 list the timing requirements.

Table 4.4 Timing requirements

Symbol	Item	Actual MCU [ns]		This product [ns]	
		Min.	Max.	Min.	Max.
tsu(DB-RD)	Data input setup time	50		75	
tsu(RDY-BCLK)	RDY* input setup time	40		60	
tsu(HOLD-BCLK)	HOLD* input setup time	50		70	
th(RD-DB)	Data input hold time	0		See left	
th(BCLK-RDY)	RDY* input hold time	0		See left	
th(BCLK-HOLD)	HOLD* input hold time	0		See left	
td(BCLK-HLDA)	HLDA* output delay time		40		See left

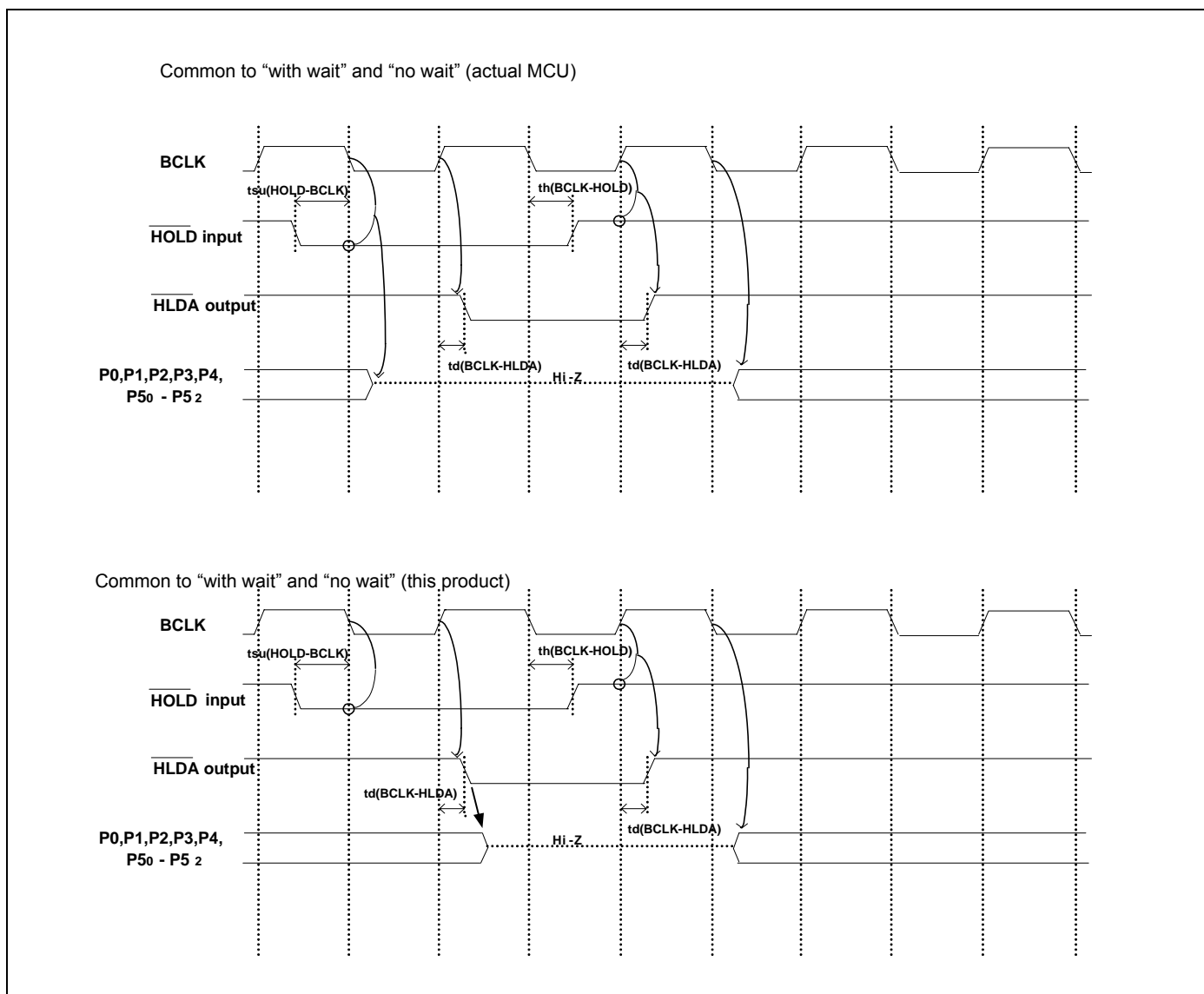

Figure 4.3 Timing requirements

* Compared with an actual MCU, this product enters high-impedance state after a 0.5 cycle delay.

4.3 Differences between the Actual MCU and Emulator

Differences between the actual MCU and emulator are shown below. When debugging the MCU using this product, be careful about the following precautions.

IMPORTANT

Note on Differences between the Actual MCU and Emulator:

- Operations of the emulator system differ from those of actual MCUs as listed below.
 - (1) Reset condition
Set the time for starting up (0.2 V_{CC} to 0.8 V_{CC}) 1 μs or less.
 - (2) Initial values of internal resource data of an MCU at power-on
 - (3) Interrupt stack pointer (ISP) after a reset is released
 - (4) Capacities of the internal memories (ROM, RAM, OSDRAM and OSDROM)
The evaluation MCU of this product has RAM of 16 KB (00400h--043FFh) and flash ROM of 4 KB (0F000h--0FFFFh) + 512 KB (80000h--FFFFFFh), OSDRAM of 4 KB (8000h--8FFFh) and OSDROM of 128KB (30000h--4FFFh).
 - (5) Oscillator circuit
In the oscillator circuit where an oscillator is connected between pins X_{IN} and X_{OUT}, oscillation does not occur because a converter board is used between the evaluation MCU and the user system. It is same for pins X_{CIN} and X_{COUT}. For notes on when using the oscillator circuit on the user system, refer to "2.11.3 Using the Oscillator Circuit on the User System " (page 42).
 - (6) A/D conversion
The characteristics of the A/D converter differ from those of actual MCU because there are a converter board and other devices between the evaluation MCU and the user system.
 - (7) Ports P0 to P5, P10
This product emulates some I/O ports (P0 to P5, P10). Therefore, the electrical characteristics of these ports differ from those of an actual MCU.
 - (8) Address and status of BHE*
When the internal RAM or ROM area of an MCU is accessed during user program execution, actual MCUs retain a preceding address and status of BHE*, while this product does not.
 - (9) Status of a data bus
In stop or wait mode, actual MCUs retain a preceding status of a data bus, while with this product a data bus is floating.
 - (10) Operation after releasing the reset
After releasing the reset, for about max. 380 cycles, a program to control the emulator will be executed. Note that this will be included in the user program execution time and tracing result.

Note on RESET* Input:

- A low input to pin RESET* from the user system is accepted only when a user program is being executed (only while the RUN status LED on the emulator's upper panel is lit).

Note on RDY* Input:

- Be sure to input "L" to pin RDY* of the user system during the user program executing (when the RUN status LED on the PC7501's upper panel is lit). Inputting "L" to pin RDY* during the user program stopping may cause a malfunction of the emulator.

Note on HOLD* Input:

- Be sure to input "L" to pin HOLD* of the user system during the user program executing (when the RUN status LED on the PC7501's upper panel is lit). Inputting "L" to pin HOLD* during the user program stopping may cause a malfunction of the emulator.

IMPORTANT

Notes on Reset Vector Area:

- Memory in the emulator main unit is always selected as a reset vector area (FFFFCh--FFFFFh) in order to operate the evaluation MCU in the emulator-dedicated mode. Set the contents of the reset vector area in one of the following ways.
 - (1) Download a user program to an area including the reset vector area.
 - (2) Set the reset vector using a memory window of the emulator debugger etc.
- A reset vector area can be changed only when a program is stopped.
- Do not access the reset vector area as data. It may not be accessed properly, and the program may not run properly in the next bus cycle.

Notes on Stack Area:

- With this product, a maximum 8 bytes of the user stack is consumed as a work area. Therefore, ensure the +8 byte maximum capacity used by the user program as the user stack area. If the user stack does not have enough area, do not use areas which cannot be used as stack (SFR area, RAM area which stores data, or ROM area) as work area. Using areas like this is a cause of user program crashes and destabilized emulator control.
- With this product, the interrupt stack pointer (ISP) is set to 00500h and used as stack area after the reset is released.

Notes on Maskable Interrupts:

- Even if a user program is not being executed (including when run-time debugging is being performed), the evaluation MCU keeps running so as to control the emulation probe. Therefore, timers and other components do not stop running. If a maskable interrupt is requested when the user program is not being executed (including when run-time debugging is being performed), the maskable interrupt request cannot be accepted, because the emulator disables interrupts. The interrupt request is accepted immediately after the user program execution is started.
- Take note that when the user program is not being executed (including when run-time debugging is being performed), a peripheral I/O interruption is not accepted.

Note on DMA Transfer:

- With this product, the user program is stopped with a loop program to a specific address. Therefore, if a DMA request is generated by a timer or other source while the user program is stopped, DMA transfer is executed. However, make note of the fact that DMA transfer while the program is stopped may not be performed correctly. Also note that the below registers have been changed to generate DMA transfer as explained here even when the user program is stopped.
 - (1) DMA0 transfer count register TCR0
 - (2) DMA1 transfer count register TCR1

IMPORTANT

Notes on Pullup Control:

- Because this product emulates some I/O ports (P0 to P5, P10), you can not pullup ports P0 to P5 by the pullup control registers, Install the included resistor arrays (51 kΩ) as necessary.
- The initial value of pullup control register 1 PUR1 of this product is different from that of an actual MCU. When a Vcc level is input to pin CNVss, the value of an actual MCU is “02h” (bit 1 PU11 is “1”), while that of this product is “00h”.

Note on Setting "1" to Protect Bit 2 (PCR2) with Sub Clock:

- When the CPU clock is set to the sub-clock (low-speed mode or low power dissipation mode), even if you enable the PRC2 bit, writing to the register protected by the PRC2 bit (PD9, address 0362h and 0366h registers) cannot be done properly. When you enable the PRC2 bit and write to the register protected by the PRC2 (PD9, address 0362h and 0366h registers), do not set the CPU clock to the sub-clock.

Note on Setting "1" to Protect Bit 2 (PRC2) in Division by 2 Mode:

- Under the following conditions, even if you enable the PRC2 bit, writing to the register protected by the PRC2 bit (PD9, address 0362h and 0366h registers) cannot be done properly.
 - (1) Between when stop mode is released and when a hardware reset is executed
 - (2) Between when low power dissipation mode is enabled and when a hardware reset is executed
 Therefore, if the condition (1) or (2) applies, when you enable the PRC2 bit and write to the register protected by the PRC2 (PD9, address 0362h and 0366h registers), set the CPU clock neither to the main clock in division by 2 mode nor to the on-chip oscillator clock in division by 2 mode.

Note on the Input Thresholds for the Pins P1_5/D13/INT3, P1_6/D14/INT4 and P1_7/D15/INT5

- With this product, regarding pins P1_5/D13/INT3, P1_6/D14/INT4 and P1_7/D15/INT5, a device which port or data bus inputs to and a device which INT interrupt inputs to are different as follows:
 - Device which port or data bus inputs to: Port emulation FPGA (input level: TTL)
 - Device which INT interrupt inputs to: Evaluation MCU for emulating peripheral functions (input level: CMOS Schmidt)
 Therefore, the port input level can be read as “H” immediately after an INT interrupt (falling), and the port input level can be read as “H” immediately before an INT interrupt (rising).

Note on Final Evaluation:

- Be sure to evaluate your system with an evaluation MCU. Before starting mask production, evaluate your system and make final confirmation with a CS (Commercial Sample) version MCU.

4.4 Connection Diagrams

Figure 4.4 shows a connection diagram of the M306V8T-EPB. This connection diagram mainly show the circuit to be connected to the user system. The circuits not connected to the user system such as the emulator's control system are omitted. Tables 4.5 and 4.6 show IC electric characteristics of this product for reference purpose.

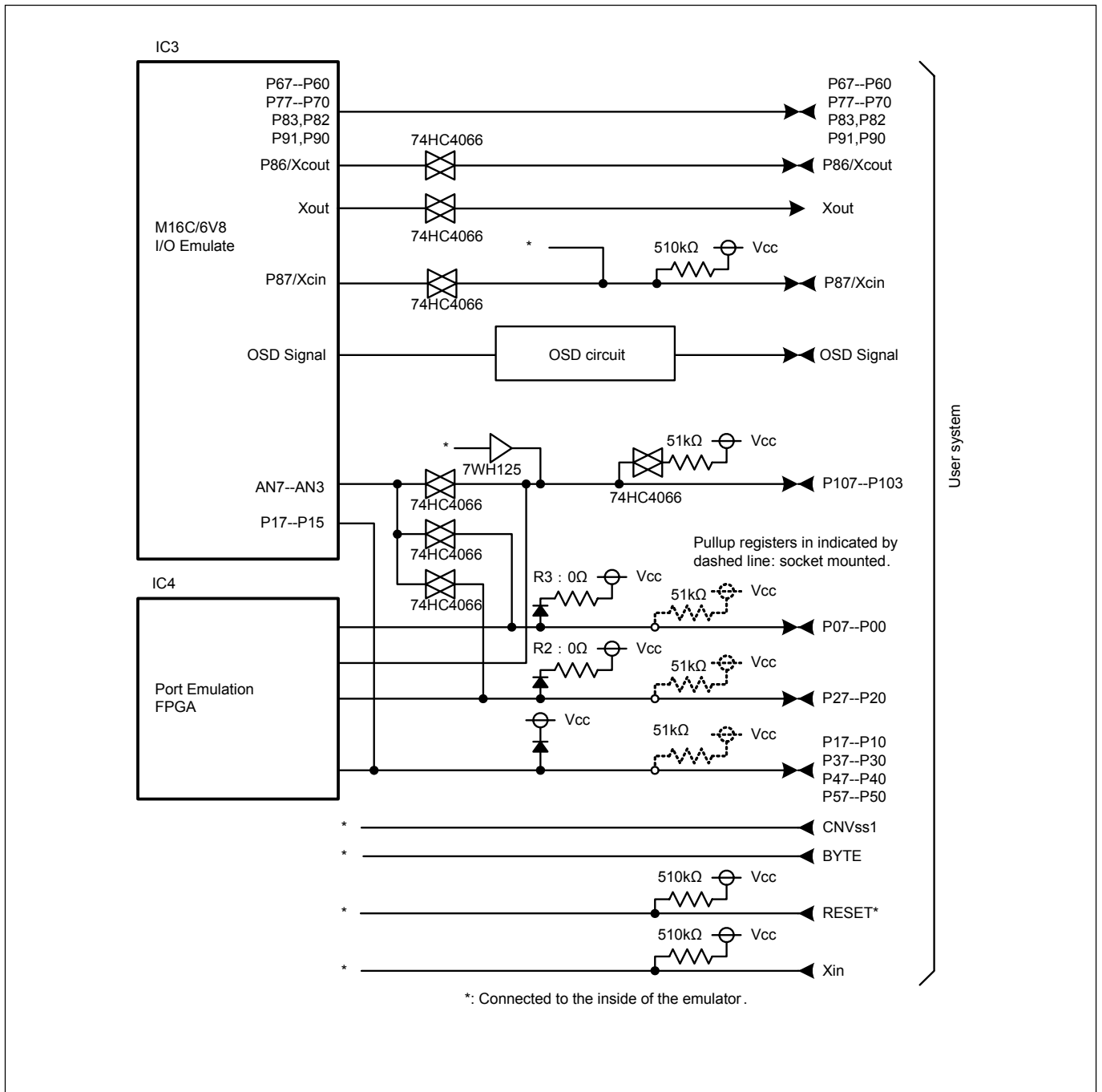

Figure 4.4 Connection diagram

Table 4.5 Electrical characteristics of the 74HC4066

Symbol	Item	Condition	Standard values			Unit
			VCC	Min.	Standard	
R _{ON}	ON resistor	4.5V	-	96	170	Ω
ΔR _{ON}	ON resistor difference	4.5V	-	10	-	
I _{OFF}	Leak current (Off)	12.0V	-	-	±100	μA
I _Z	Leak current (On, output: open)	12.0V	-	-	±100	

Table 4.6 Electrical characteristics of port emulation FPGA

Symbol	Item	Condition	Standard values			Unit
			Min.	Standard	Max.	
V _{IH}	"H" level input voltage		2.0	-	5.5	V
V _{IL}	"L" level input voltage		-0.5	-	0.8	
V _{OH}	"H" level output voltage	I _{OH} =-8mA DC, V _{CC} =4.75V	2.4	-	-	
		I _{OH} =-8mA DC, V _{CC} =3.00V	2.4	-	-	
V _{OL}	"L" level output voltage	I _{OL} =8mA DC, V _{CC} =4.75V	-	-	0.45	
		I _{OL} =8mA DC, V _{CC} =3.00V	-	-	0.45	
I _{OZ}	Leak current (Tristate)	V _O =V _{CC} or GND	-40	-	40	μA
C _{IN}	I/O pin input capacitance	V _{IN} =0V, f=1.0MHz	-	-	8	pF

4.5 External Dimensions

4.5.1 External Dimensions of the Emulation Probe

Figure 4.5 shows external dimensions of the M306V8T-EPB.

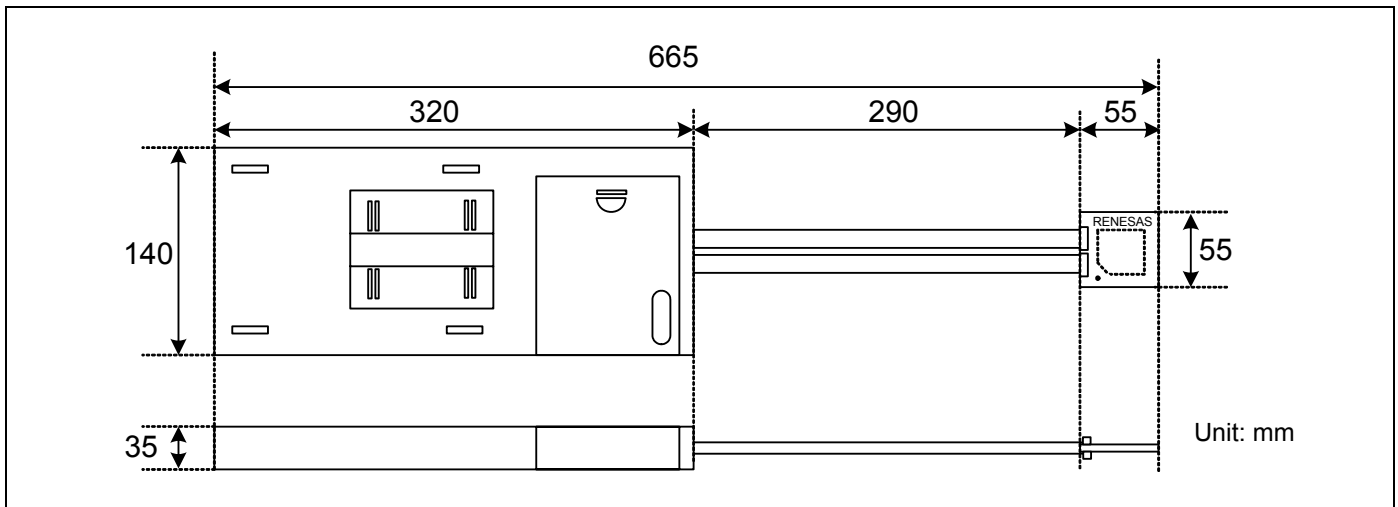

Figure 4.5 External dimensions of the emulation probe

4.5.2 External Dimensions of the M306V8T-PTC

Figure 4.6 shows external dimensions of the converter board M306V8T-PTC for a 116-pin LCC (included with the M306V8T-EPB).

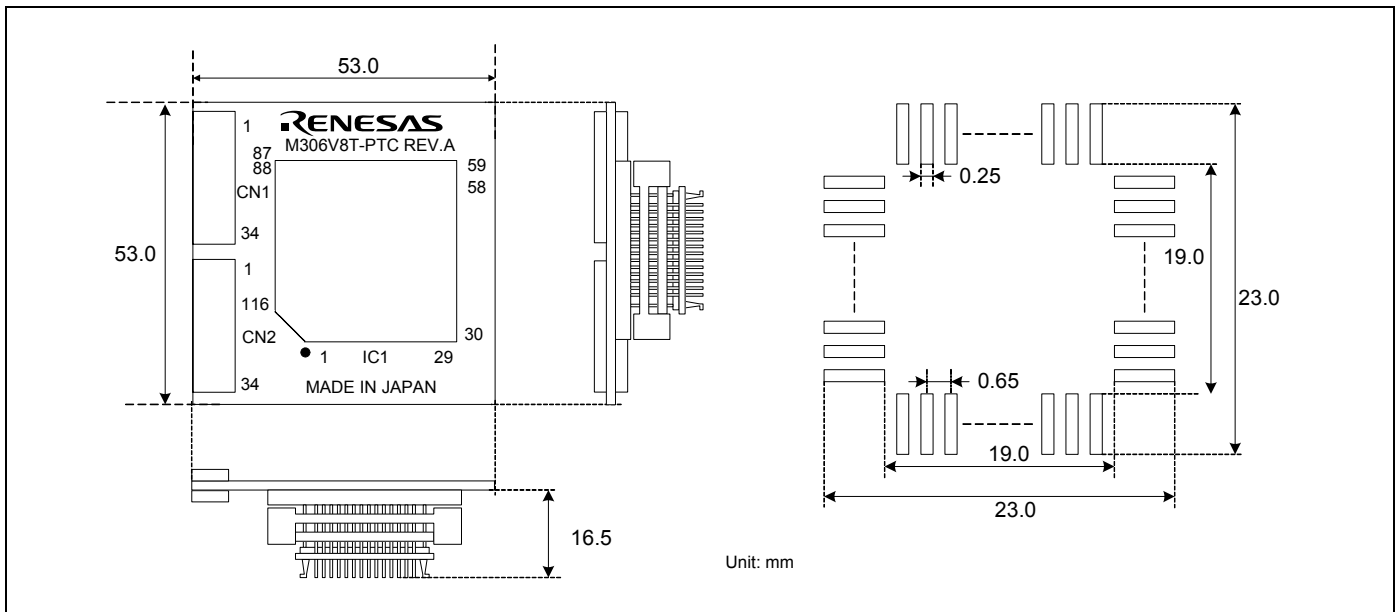

Figure 4.6 External dimensions of the M306V8T-PTC

4.6 Notes on Using This Product

Notes on using this product are listed below. When debugging the MCU using the emulator, be careful about the following precautions.

IMPORTANT

Note on the Version of the Emulator Debugger:

- Be sure to use this product with one of the following emulator debuggers.
 1. Renesas Debugger Package for M16C R8C PC7501 V.1.00.00 Release 01 or later
 2. M3T-PD30F V.2.20 Release 1 or later

Note on Selecting the MCU File:

- Select the MCU file "M16C6V8.mcu" at emulator startup.

Notes on Downloading Firmware:

- Before using this product for the first time, it is necessary to download the dedicated firmware. Please note that, to do this, it is necessary to start up the emulator main unit in maintenance mode. For downloading firmware, see "2.7 Downloading Firmware" (page 27). Once the firmware has been downloaded, the product can be used by simply turning on the power.
- Do not shut off the power while downloading the firmware. If this happens, the product will not start up properly. If the power is shut off unexpectedly, redownload the firmware.
- Download the firmware with the user system not connected.

Notes on Self-check:

- If the self-check does not result normally (excluding user system errors), the emulation probe may be damaged. Then contact your local distributor.
- Run the self-check with the user system not connected.

Note on Quitting the Emulator Debugger:

- To restart the emulator debugger, always shut power to the emulator module off once and then on again.

Note on Display of MCU Status:

- "MCU status" you can refer to in the MCU tab of the MCU Setting dialog box of the emulator debugger shows pin levels of the user system. Make sure that proper pin levels are specified according to the mode you use.
 - (1) When single-chip mode is used:
CNVss: Low
 - (2) When memory expansion mode 16-bit data bus width is used:
CNVss: Low, BYTE: Low, HOLD*: High, RDY*: High
 - (3) When microprocessor mode 16-bit data bus width is used:
CNVss: High, BYTE: Low, HOLD*: High, RDY*: High

IMPORTANT

Note on Clock Supply to the MCU:

- A clock supplied to the evaluation MCU is selected by the Emulator tab in the Init dialog box of the emulator debugger.
 - (1) When "Internal" is selected:

A clock generated by the oscillator circuit board in the PC7501 is supplied. It is continually supplied regardless of the status of the user system clock and that of the user program execution.
 - (2) When "External" is selected:

A clock generated by the oscillator in the user system is supplied. It depends on the status of the oscillation (on/off) of the user system.
 - (3) When "Generate" is selected:

A clock generated by the dedicated circuit in the PC7501 is supplied. It is continually supplied regardless of the status of the user system clock and that of the user program execution.

Note on Operating Frequency:

- You can not use this product with a main clock (X_{IN} - X_{OUT}) less than 1 MHz. To use it with a main clock less than 1 MHz, contact your local distributor.

Notes on Map Settings:

- Be sure to set the OSDRAM area (8000h -- 8FFFh) to INTERNAL.
- Be sure to set the OSDROM area (30000h -- 4FFFFh) to EXTERNAL.

Note on Stop and Wait Modes:

- Do not single step an instruction shifting to stop or wait mode. It may cause communication errors.

Note on the Watchdog Function:

- If the reset circuit of the user system has a watchdog timer, disable it when using the emulator.

Note on Access Prohibited Area:

- You cannot use internally reserved areas. Write signals to the areas will be ignored, and values read will be undefined.

Note on Protect Register:

- The protect is not canceled when bit 2 of protect register PRCR (PRC2), which enables writing into the PD9, address 0362h and 0366h registers, is changed with the below procedure.
 - (1) Step execution of an instruction setting PRC2 to "1"
 - (2) Setting a break point between an instruction setting PRC2 to "1" and a point where the PD9, address 0362h and 0366h registers are set
 - (3) Setting PRC2 to "1" by the memory window or script window

IMPORTANT

Note on Breaks:

- The area displaying break points in the program window of the emulator debugger shows the following breaks.
 - (1) Address-match break
This is a debugging function which breaks a program, using the address-match interrupt function of the MCU, immediately before the system executes an instruction at a specified address. The instruction at the preset address will not be executed.
 - (2) Software break
This is a debugging function which generates a BRK interruption by changing an instruction at a specified address to a BRK instruction (00h) to break a program immediately before the system executes an instruction at a specified address. The instruction at the preset address will not be executed.
 - (3) Hardware break
This is a debugging function which breaks a program by setting the detection of an execution of an instruction at a specified address as a break event. The program will break after the instruction at the specified address is executed.

Notes on Software Breaks:

- Software breaks change the instruction at a specified address to a BRK (00h). Therefore, take note that when you reference the result of a trace in bus mode, "00h" is displayed.
- The BRK instruction can be used for the emulator only. You cannot use it in a user program.
- You can neither set nor cancel a software breakpoint in the internal ROM area of an MCU during user program execution, while you can set or cancel it in the internal RAM area of an MCU or an area where chip select CS3* to CS0* are set to INTERNAL (emulation memory).

Notes on Address-Match Breaks:

- As the processing speed of setting and canceling address-match breaks is relatively fast, you can save the times of writing into the internal flash ROM of an MCU. Therefore, address-match breaks precede the other breaks when setting breakpoints in the internal flash ROM area of an MCU.
- Address-match breaks can be set only in RAM and ROM areas of an MCU.
- Address-match breaks can be set at up to eight points. The other breaks are set as software breaks.
- Address-match breaks can be set or canceled even when the user program is being executed.

Notes on Power Supply to the User System:

- Pins Vcc1 and Vcc2 are connected to the user system to observe the voltage. Therefore, the power is not supplied to the user system from the emulator, design your system so that the user system is powered separately.
- The voltage of the user system should be as follows.
 $3.15\text{ V} \leq V_{cc1} = V_{cc2} = V_{cc3} \leq 3.45\text{ V}$
- Do not change the voltage of the user system after turning on the power.

IMPORTANT

Notes on Internal Flash ROM of the MCU:

- In single-chip mode and memory expansion modes, this product downloads a user program to the flash ROM of an MCU. By checking "Debug Option" in the MCU tab of the MCU setting dialog box of the emulator debugger, you can disable the operation of the internal flash ROM of the MCU to use the emulation memory. The maximum operating frequencies are as follows.
 - (1) "Debug Option " unchecked
Access area: Flash ROM of MCU
Max. operating frequency: 16 MHz (0 wait, 1 wait)
 - (2) "Debug Option " checked
Access area: Emulation memory of the PC7501
Max. operating frequency: 10 MHz (0 wait, 1 wait)
- Because the number of write/erase cycles of the internal flash ROM of the MCU is limited, it must be replaced at the end of its service-life.
- If the following errors occur frequently when downloading a program, replace the MCU board.
 - (1) Flash ROM erase error occurred ERROR (16258)
 - (2) Flash ROM verify error occurred ERROR (16259)
 To purchase products for replacement, contact your local distributor.

Note on Memory Area Expansion Function (Normal Mode):

- During debugging in memory expansion mode or microprocessor mode with this product, the emulation memory can be allocated. The emulation memory can be specified up to 4 areas by 4 MB in the MAP tab of the MCU setting dialog box of the emulator debugger.
Each maximum operating frequency is as follows.

- Maximum operating frequency (at 3.3 V) 0 wait:	6 Hz
1 wait to 3 wait:	16 MHz

Note on Memory Area Expansion Function (4-MByte Mode):

- When using the memory area expansion function (4-Mbyte mode), please note that the memory to which the evaluation MCU is connected differs depending on processor modes and debugger settings. For details, refer to the table below.

Areas connected when using the memory area expansion function (4-Mbyte mode)

Processor mode	PM13 ^{*1}	OFS ^{*2}	Accessed area of target MCU	Banks 0--5	Bank 6	Bank 7
Memory expansion mode	1	0	5000h--7FFFh	EXT ^{*3}	EXT	MAP ^{*4}
		1	5000h--7FFFh	EXT	EXT	MAP
	0	0	5000h--7FFFh	EXT	EXT	MAP
			8000h--BFFFh	EXT	EXT	MAP
		1	5000h--7FFFh	EXT	EXT	MAP
			8000h--BFFFh	EXT	MAP	---
Microprocessor mode	---	0	5000h--7FFFh	EXT	EXT	MAP
			8000h--BFFFh	EXT	EXT	---
			C000h--FFFFh	---	---	MAP
		1	5000h--7FFFh	EXT	EXT	MAP
			8000h--BFFFh	EXT	MAP	---

*1: Indicates bit 3 at address 00005h.

*2: Indicates bit 2 at address 0000Bh.

*3: Indicates memory access in the user system.

*4: Indicates area access dependent on how the MAP tab of the debugger's MCU settings dialog box is set (INT: internal emulation memory of the PC7501, EXT: memory in the user system).

IMPORTANT

Notes on Debugging in CPU Rewrite Mode:

- When you debug an M16C/60 Series MCUs in CPU rewrite mode, do not change the block 0 area (FF000h--FFFFFh) of the flash memory. Otherwise, the emulator will be uncontrollable.
- If you check "Debug the program using CPU Rewrite Mode" in the MCU tab of the Init dialog box of the emulator debugger, you cannot use the following functions.
 - (1) Setting software breakpoints in an internal ROM area
 - (2) Executing COME in an internal ROM area
- In CPU rewrite mode and erase suspend mode, do not stop the program. And do not single step an instruction shifting to CPU rewrite mode or erase suspend mode. The emulator will be uncontrollable in CPU rewrite mode and erase suspend mode.
- To reference data after executing CPU rewrite, stop the program at other than a rewrite control program area and use the memory window etc.

As the following interrupt vectors are used by the emulator system, the read data is different from expected value.

 - (1) BRK instruction (FFFE4h--FFFE7h)
 - (2) Address match (FFFE8h--FFFEbH)
 - (3) Single-step (FFFECh--FFFEFh)
 - (4) DBC (FFFF4h--FFFF7h)

Notes on Address-Match Interrupts:

- When you use the address-match interrupt function in a user program, uncheck "Enable the Address Match Interrupt Break Function" in the MCU tab of the Init dialog box of the emulator debugger. Thus, normal software breaks are used for the internal RAM and ROM areas of an MCU.
- Do not set a software break at an address where an address-match interrupt occurs. Otherwise, a user program may be run out of control. Set a software or hardware break in the top address in address-match interrupt processing.
- When you single step an address where an address-match interrupt occurs, the program stops after executing the first instruction after returning from address-match interrupt processing.

Note on Accessing Addresses 00000h and 00001h:

- With the M16C/60 Series MCUs, when a maskable interrupt is generated, the interrupt data (interrupt number and interrupt request level) stored in addresses 00000h and 00001h are read out. Also, the interrupt request bit is cleared when address 00000h or 00001h is read out. Consequently, when the address 00000h or 00001h readout instruction is executed or when address 00000h or 00001h is read out in the cause of a program runaway, a malfunction occurs in that the interrupt is not executed despite the interrupt request, because the request bit of the highest priority interrupt factor enabled is cleared.

For this malfunction, when the reading out to address 00000h or 00001h is generated excluding the interrupt, the WARNING LED (yellow) lights up to alarm. When this LED lights, there is a possibility of wrong access, therefore check the user program.

5. Troubleshooting

This chapter describes how to troubleshoot when this product does not work properly.

5.1 Flowchart to Remedy the Troubles

Figure 5.1 shows the flowchart to remedy the troubles from when power to the emulator is activated until the emulator debugger starts up. Check this while the user system is disconnected. For the latest FAQs visit the Renesas Tools Homepage.

<http://www.renesas.com/en/tools>

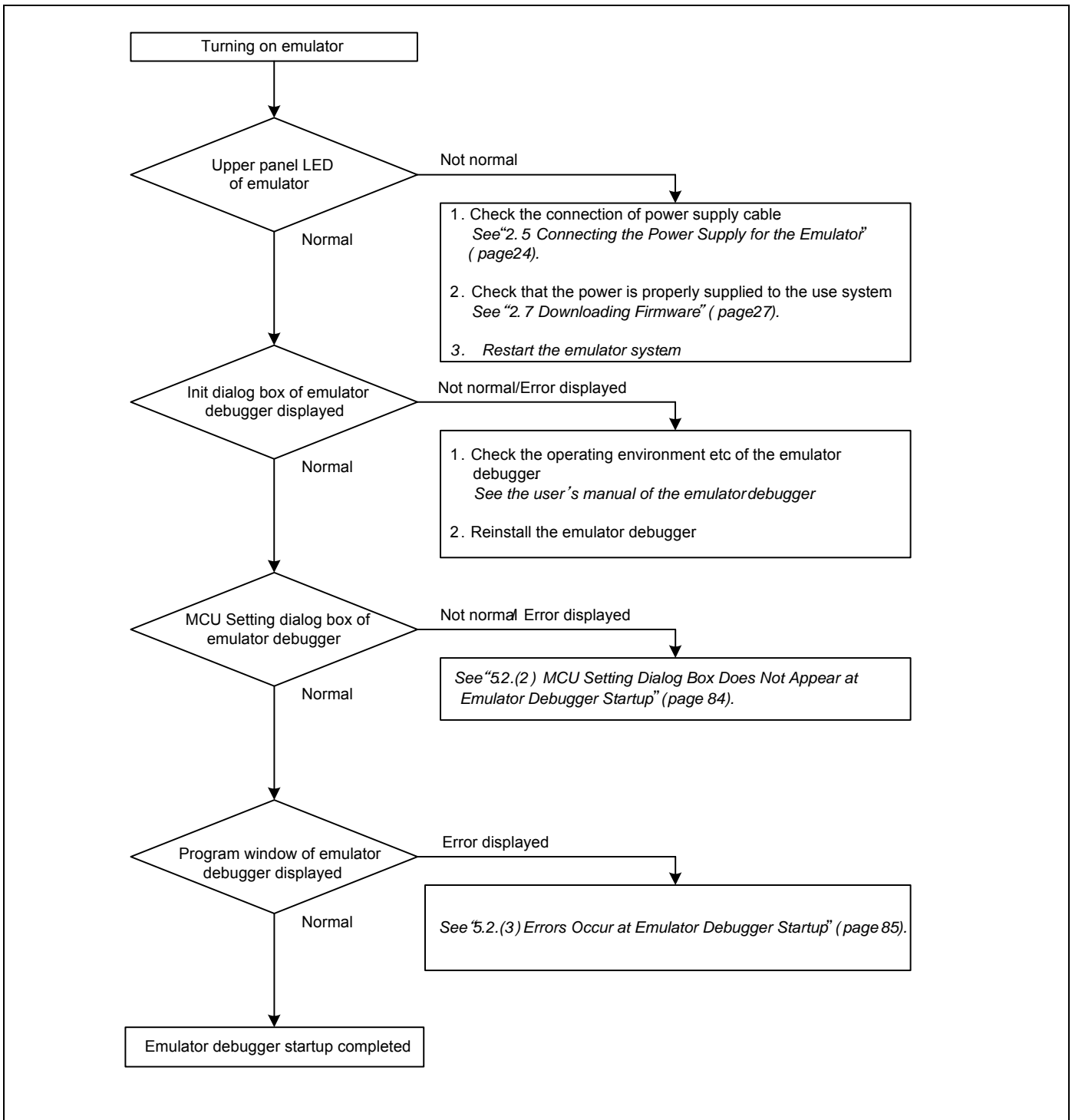

Figure 5.1 Flowchart to remedy the troubles

5.2 When the Emulator Debugger Does Not Start Up Properly

(1) When the LEDs of the PC7501 Do Not Display Normally

Table 5.1 Errors LEDs show and their checkpoints

Error	Connection to the user system	Checkpoint
LEDs do not light up.	-	Check that the power cable is connected. <i>See "2.5 Connecting the Power Supply for the Emulator" (page 24) and the user's manual of the PC7501.</i>
All LEDs remain lit.	-	Recheck the connection between the PC7501 and this product. <i>See "2.4 Connecting the PC7501" (page 23).</i>
Target Status POWER LED does not light up.	Connected	Check that power (Vcc) is properly supplied to the user system and that the user system is properly grounded.
Target Status CLOCK LED does not light up.	Not connected	(1) Check that both the main and sub clocks of the emulator debugger are not set to "EXT". <i>See the CLK command of the emulator debugger.</i> (2) Check the oscillation circuit in the emulator is oscillating. <i>See "2.11 Selecting Clock Supply" (page 38).</i>
	Connected	When the clock is supplied from an external oscillator, check that the oscillator circuit in the user system is oscillating properly.
Target Status RESET LED does not go out.	Connected	Check that the reset pin of the user system is pulled up.

(2) MCU Setting Dialog Box Does Not Appear at Emulator Debugger Startup

Table 5.2 Checkpoints of errors at debugger startup

Error	Checkpoint
Communication error occurred. Data was not sent to the target.	Check all emulator debugger settings, interface cable settings and switches on the rear of the PC7501 match. <i>See the user's manuals of PC7501 and emulator debugger.</i>
User system cannot be properly built.	(1) Download the proper firmware. <i>See "2.7 Downloading Firmware" (page 27).</i> (2) Recheck the connection between the PC7501 and this product. <i>See "2.4 Connecting the PC7501" (page 23).</i>
Emulator's version is not the same version as the firmware in the target.	Download the proper firmware. <i>See "2.7 Downloading Firmware" (page 27).</i>
Target MCU is in the reset state.	(1) Check the reset pin of the user system is pulled up. (2) Check the reset pin of the user system has changed from "L" to "H" level.
Target MCU cannot be reset.	(1) In memory expansion mode or microprocessor mode, check pins RDY* and HOLD* are at "H" level. (2) If the reset circuit of the user system has a watchdog timer, disable the watchdog timer. (3) Check that power is properly supplied to the user system and that the user system is properly grounded.
Target is in "HOLD" state.	(1) In memory expansion mode or microprocessor mode, check pins RDY* and HOLD* at "H" level. (2) The MCU is either in stop mode or wait mode. Either reset the MCU or cancel the mode with an interrupt. <i>See MCU specifications.</i>
Target clock is stopped.	When the clock is supplied from an external oscillator, check that the oscillator circuit in the user system is oscillating properly.
Target MCU is not receiving power.	Check that power is properly supplied to the user system and that the user system is properly grounded.

(3) Errors Occur at Emulator Debugger Startup

Table 5.3 Checkpoints of errors at debugger startup

Error	Checkpoint
Target MCU is uncontrollable.	<ol style="list-style-type: none">(1) Check that the NQPACK etc. mounted on the user system is soldered properly.(2) Check that the connector is installed properly to the user system.(3) In memory expansion mode or microprocessor mode, check pins RDY* and HOLD* are at "H" level.

5.3 How to Request for Support

After checking the items in "5 Troubleshooting", send the following information to your local distributor.

Customer Information

- Company:
- Address:
- Department:
- Name:
- Phone:
- Fax:
- Email address:

Product information

- Software name:
- Version:
- Host machine:
- OS:

PDxx support information

1. Target MCU:
2. Emulator (Check one that applies):
 PC4701U PC4701M PC4701HS PC4701L PC7501 Other
3. Emulator's serial number:
4. Product name of the emulation pod/probe:
5. Serial number of the emulation pod/probe:
6. Interface:
 USB LPT parallels LAN Serial Dedicated parallel
7. Optional product used:
8. Serial number of the optional product:

Remarks:

For prompt response, please specify the following information:

(1) Operating environment

- Operating voltage: _____ [V]
- Operating frequency: _____ [MHz]
- Clock supply to the MCU: Internal oscillator/External oscillator

(2) Condition

- The emulator debugger starts up/does not start up
- The error is detected/not detected in the self-check
- Frequency of errors: always/frequency (_____)

(3) Problem

6. Maintenance and Guarantee

This chapter describes how to maintenance, repair provisions and how to request for repair.

6.1 User Registration

When you purchase our product, be sure register as a user. For user registration, refer to "User registration" (page 11) of this user's manual.

6.2 Maintenance

- (1) If dust or dirt collects on any equipment of your emulation system, wipe it off with a dry soft cloth. Do not use thinner or other solvents because these chemicals can cause the equipment's surface coating to separate.
- (2) When you do not use this product for a long period, for safety purposes, disconnect the power cable from the power supply.

6.3 Guarantee

If your product becomes faulty within one year after its purchase while being used under good conditions by observing "IMPORTANT" and "Precautions for Safety" described in this user's manual, we will repair or replace your faulty product free of charge. Note, however, that if your product's fault is raised by any one of the following causes, we will repair it or replace it with new one with extra-charge:

- Misuse, abuse, or use under extraordinary conditions
- Unauthorized repair, remodeling, maintenance, and so on
- Inadequate user's system or misuse of it
- Fires, earthquakes, and other unexpected disasters

In the above cases, contact your local distributor. If your product is being leased, consult the leasing company or the owner.

6.4 Repair Provisions

(1) Repair with extra-charge

The products elapsed more than one year after purchase can be repaired with extra-charge.

(2) Replacement with extra-charge

If your product's fault falls in any of the following categories, the fault will be corrected by replacing the entire product instead of repair, or you will be advised to purchase new one, depending on the severity of the fault.

- Faulty or broken mechanical portions
- Flaw, separation, or rust in coated or plated portions
- Flaw or cracks in plastic portions
- Faults or breakage caused by improper use or unauthorized repair or modification
- Heavily damaged electric circuits due to overvoltage, overcurrent or shorting of power supply
- Cracks in the printed circuit board or burnt-down patterns
- Wide range of faults that makes replacement less expensive than repair
- Unlocatable or unidentified faults

(3) Expiration of the repair period

When a period of one year elapses after the model was dropped from production, repairing products of the model may become impossible.

(4) Transportation fees at sending your product for repair

Please send your product to us for repair at your expense.

6.5 How to Make Request for Repair

If your product is found faulty, follow the procedure below to send your product for repair.

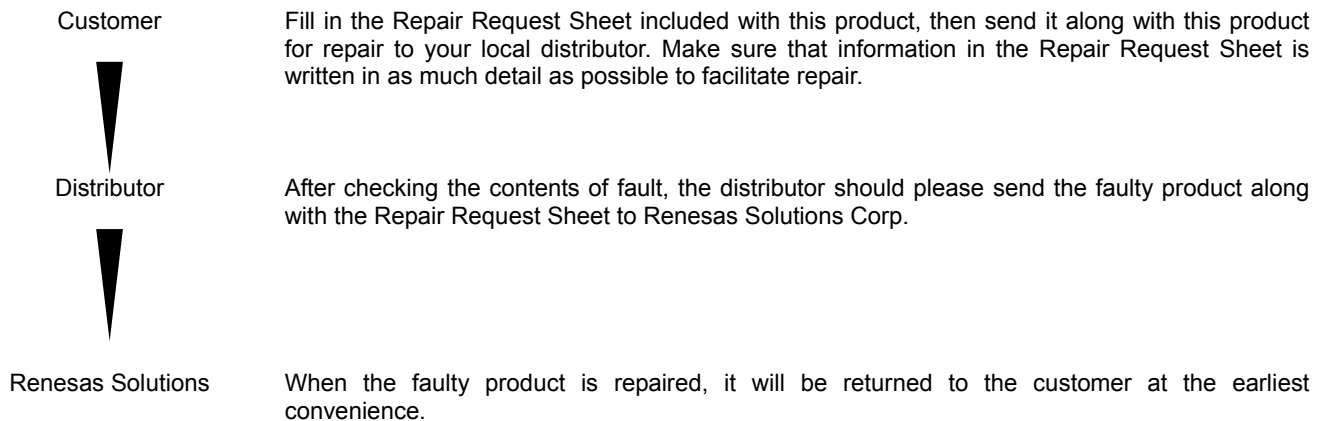

CAUTION

Note on Transporting the Product:

- When sending your product for repair, use the packing box and cushion material supplied with this product when delivered to you and specify handling caution for it to be handled as precision equipment. If packing of your product is not complete, it may be damaged during transportation. When you pack your product in a bag, make sure to use conductive polyvinyl supplied with this product (usually a blue bag). When you use other bags, they may cause a trouble on your product because of static electricity.

Emulation Probe for M16C/60 Series M16C/6V Group M306V8
User's Manual
M306V8T-EPB

Publication Date: Aug. 1, 2005 Rev.1.00

Published by: Sales Strategic Planning Div.
 Renesas Technology Corp.

Edited by: Microcomputer Tool Development Department
 Renesas Solutions Corp.

© 2005. Renesas Technology Corp. and Renesas Solutions Corp., All rights reserved. Printed in Japan.

M306V8T-EPB User's Manual



Renesas Electronics Corporation

1753, Shimonumabe, Nakahara-ku, Kawasaki-shi, Kanagawa 211-8668 Japan

REJ10J0777-0100(T)