

To our customers,

---

## Old Company Name in Catalogs and Other Documents

---

On April 1<sup>st</sup>, 2010, NEC Electronics Corporation merged with Renesas Technology Corporation, and Renesas Electronics Corporation took over all the business of both companies. Therefore, although the old company name remains in this document, it is a valid Renesas Electronics document. We appreciate your understanding.

Renesas Electronics website: <http://www.renesas.com>

April 1<sup>st</sup>, 2010  
Renesas Electronics Corporation

Issued by: Renesas Electronics Corporation (<http://www.renesas.com>)

Send any inquiries to <http://www.renesas.com/inquiry>.

## Notice

1. All information included in this document is current as of the date this document is issued. Such information, however, is subject to change without any prior notice. Before purchasing or using any Renesas Electronics products listed herein, please confirm the latest product information with a Renesas Electronics sales office. Also, please pay regular and careful attention to additional and different information to be disclosed by Renesas Electronics such as that disclosed through our website.
2. Renesas Electronics does not assume any liability for infringement of patents, copyrights, or other intellectual property rights of third parties by or arising from the use of Renesas Electronics products or technical information described in this document. No license, express, implied or otherwise, is granted hereby under any patents, copyrights or other intellectual property rights of Renesas Electronics or others.
3. You should not alter, modify, copy, or otherwise misappropriate any Renesas Electronics product, whether in whole or in part.
4. Descriptions of circuits, software and other related information in this document are provided only to illustrate the operation of semiconductor products and application examples. You are fully responsible for the incorporation of these circuits, software, and information in the design of your equipment. Renesas Electronics assumes no responsibility for any losses incurred by you or third parties arising from the use of these circuits, software, or information.
5. When exporting the products or technology described in this document, you should comply with the applicable export control laws and regulations and follow the procedures required by such laws and regulations. You should not use Renesas Electronics products or the technology described in this document for any purpose relating to military applications or use by the military, including but not limited to the development of weapons of mass destruction. Renesas Electronics products and technology may not be used for or incorporated into any products or systems whose manufacture, use, or sale is prohibited under any applicable domestic or foreign laws or regulations.
6. Renesas Electronics has used reasonable care in preparing the information included in this document, but Renesas Electronics does not warrant that such information is error free. Renesas Electronics assumes no liability whatsoever for any damages incurred by you resulting from errors in or omissions from the information included herein.
7. Renesas Electronics products are classified according to the following three quality grades: “Standard”, “High Quality”, and “Specific”. The recommended applications for each Renesas Electronics product depends on the product’s quality grade, as indicated below. You must check the quality grade of each Renesas Electronics product before using it in a particular application. You may not use any Renesas Electronics product for any application categorized as “Specific” without the prior written consent of Renesas Electronics. Further, you may not use any Renesas Electronics product for any application for which it is not intended without the prior written consent of Renesas Electronics. Renesas Electronics shall not be in any way liable for any damages or losses incurred by you or third parties arising from the use of any Renesas Electronics product for an application categorized as “Specific” or for which the product is not intended where you have failed to obtain the prior written consent of Renesas Electronics. The quality grade of each Renesas Electronics product is “Standard” unless otherwise expressly specified in a Renesas Electronics data sheets or data books, etc.
  - “Standard”: Computers; office equipment; communications equipment; test and measurement equipment; audio and visual equipment; home electronic appliances; machine tools; personal electronic equipment; and industrial robots.
  - “High Quality”: Transportation equipment (automobiles, trains, ships, etc.); traffic control systems; anti-disaster systems; anti-crime systems; safety equipment; and medical equipment not specifically designed for life support.
  - “Specific”: Aircraft; aerospace equipment; submersible repeaters; nuclear reactor control systems; medical equipment or systems for life support (e.g. artificial life support devices or systems), surgical implantations, or healthcare intervention (e.g. excision, etc.), and any other applications or purposes that pose a direct threat to human life.
8. You should use the Renesas Electronics products described in this document within the range specified by Renesas Electronics, especially with respect to the maximum rating, operating supply voltage range, movement power voltage range, heat radiation characteristics, installation and other product characteristics. Renesas Electronics shall have no liability for malfunctions or damages arising out of the use of Renesas Electronics products beyond such specified ranges.
9. Although Renesas Electronics endeavors to improve the quality and reliability of its products, semiconductor products have specific characteristics such as the occurrence of failure at a certain rate and malfunctions under certain use conditions. Further, Renesas Electronics products are not subject to radiation resistance design. Please be sure to implement safety measures to guard them against the possibility of physical injury, and injury or damage caused by fire in the event of the failure of a Renesas Electronics product, such as safety design for hardware and software including but not limited to redundancy, fire control and malfunction prevention, appropriate treatment for aging degradation or any other appropriate measures. Because the evaluation of microcomputer software alone is very difficult, please evaluate the safety of the final products or system manufactured by you.
10. Please contact a Renesas Electronics sales office for details as to environmental matters such as the environmental compatibility of each Renesas Electronics product. Please use Renesas Electronics products in compliance with all applicable laws and regulations that regulate the inclusion or use of controlled substances, including without limitation, the EU RoHS Directive. Renesas Electronics assumes no liability for damages or losses occurring as a result of your noncompliance with applicable laws and regulations.
11. This document may not be reproduced or duplicated, in any form, in whole or in part, without prior written consent of Renesas Electronics.
12. Please contact a Renesas Electronics sales office if you have any questions regarding the information contained in this document or Renesas Electronics products, or if you have any other inquiries.

(Note 1) “Renesas Electronics” as used in this document means Renesas Electronics Corporation and also includes its majority-owned subsidiaries.

(Note 2) “Renesas Electronics product(s)” means any product developed or manufactured by or for Renesas Electronics.

# M306K9T2-CPE

User's Manual

Compact Emulator with Real-time Trace  
Functions for M306K9

- NQPACK, YQPACK, YQSOCKET, YQ-GUIDE, HQPACK, TQPACK and TQSOCKET are products of Tokyo Eletech Corporation.

#### **Keep safety first in your circuit designs!**

- Renesas Technology Corporation and Renesas Solutions Corporation put the maximum effort into making semiconductor products better and more reliable, but there is always the possibility that trouble may occur with them. Trouble with semiconductors may lead to personal injury, fire or property damage. Remember to give due consideration to safety when making your circuit designs, with appropriate measures such as (i) placement of substitutive, auxiliary circuits, (ii) use of nonflammable material or (iii) prevention against any malfunction or mishap.

#### **Notes regarding these materials**

- These materials are intended as a reference to assist our customers in the selection of the Renesas Technology product best suited to the customer's application; they do not convey any license under any intellectual property rights, or any other rights, belonging to Renesas Technology Corporation, Renesas Solutions Corporation or a third party.
- Renesas Technology Corporation and Renesas Solutions Corporation assume no responsibility for any damage, or infringement of any third-party's rights, originating in the use of any product data, diagrams, charts, programs, algorithms, or circuit application examples contained in these materials.
- All information contained in these materials, including product data, diagrams, charts, programs and algorithms represents information on products at the time of publication of these materials, and are subject to change by Renesas Technology Corporation and Renesas Solutions Corporation without notice due to product improvements or other reasons. It is therefore recommended that customers contact Renesas Technology Corporation, Renesas Solutions Corporation or an authorized Renesas Technology product distributor for the latest product information before purchasing a product listed herein. The information described here may contain technical inaccuracies or typographical errors. Renesas Technology Corporation and Renesas Solutions Corporation assume no responsibility for any damage, liability, or other loss rising from these inaccuracies or errors. Please also pay attention to information published by Renesas Technology Corporation and Renesas Solutions Corporation by various means, including the Renesas home page (<http://www.renesas.com>).
- When using any or all of the information contained in these materials, including product data, diagrams, charts, programs, and algorithms, please be sure to evaluate all information as a total system before making a final decision on the applicability of the information and products. Renesas Technology Corporation and Renesas Solutions Corporation assume no responsibility for any damage, liability or other loss resulting from the information contained herein.
- Renesas Technology semiconductors are not designed or manufactured for use in a device or system that is used under circumstances in which human life is potentially at stake. Please contact Renesas Technology Corporation, Renesas Solutions Corporation or an authorized Renesas Technology product distributor when considering the use of a product contained herein for any specific purposes, such as apparatus or systems for transportation, vehicular, medical, aerospace, nuclear, or undersea repeater use.
- The prior written approval of Renesas Technology Corporation and Renesas Solutions Corporation is necessary to reprint or reproduce in whole or in part these materials.
- If these products or technologies are subject to the Japanese export control restrictions, they must be exported under a license from the Japanese government and cannot be imported into a country other than the approved destination. Any diversion or reexport contrary to the export control laws and regulations of Japan and/or the country of destination is prohibited.
- Please contact Renesas Technology Corporation or Renesas Solutions Corporation for further details on these materials or the products contained therein.

#### **Precautions to be taken when using this product**

- This product is a development supporting unit for use in your program development and evaluation stages. In mass-producing your program you have finished developing, be sure to make a judgment on your own risk that it can be put to practical use by performing integration test, evaluation, or some experiment else.
- In no event shall Renesas Solutions Corporation be liable for any consequence arising from the use of this product.
- Renesas Solutions Corporation strives to renovate or provide a workaround for product malfunction at some charge or without charge. However, this does not necessarily mean that Renesas Solutions Corporation guarantees the renovation or the provision under any circumstances.
- This product has been developed by assuming its use for program development and evaluation in laboratories. Therefore, it does not fall under the application of Electrical Appliance and Material Safety Law and protection against electromagnetic interference when used in Japan.
- This product is not qualified under UL or other safety standards and IEC or other industry standards. This fact must be taken into account when taking this product from Japan to some other country.
- For inquiries about the contents of this document or product, fill in the text file the installer of the emulator debugger generates in the following directory and email to your local distributor.

\\SUPPORT\Product-name\SUPPORT.TXT

Renesas Tools Homepage <http://www.renesas.com/en/tools>

# Preface

The M306K9T2-CPE is a compact emulator with the real-time trace functions for the M16C/6K Group M306K9 of 16-bit microcomputers.

This user's manual mainly describes specifications of the M306K9T2-CPE and how to set up and operate it. For details on emulator debugger M3T-PD30M, C compiler M3T-NC30WA (entry version) and integrated development environment TM, refer to each product's user's manual.

If there is any question about this product, contact your local distributor.

## To use the product properly

### Precautions for Safety



- In both this user's manual and on the product itself, several icons are used to insure proper handling of this product and also to prevent injuries to you or other persons, or damage to your properties.
- The icons' graphic images and meanings are given in "Chapter 1. Precautions for Safety". Be sure to read this chapter before using the product.

# Terminology

Some specific words used in this user's manual are defined as follows:

- **Emulator**

This means the M306K9T2-CPE (this product).

- **Emulator system**

This means an emulator system built around the M306K9T2-CPE emulator. The M306K9T2-CPE emulator system is configured with an emulator, host machine and emulator debugger.

- **Host machine**

This means a personal computer used to control the emulator.

- **Emulator debugger**

This means a software tool, M3T-PD30M V.2.00 or later to control the emulator from the host machine through an communications interface.

- **Evaluation MCU**

This means the microcomputer mounted on the emulator which is operated in the specific mode for development tools.

- **Target MCU**

This means the microcomputer you are going to debug.

- **Target system**

This means a user's application system using the microcomputer to be debugged.

- \*

In this user's manual, this symbol is used to show active LOW. (e.g. RESET\*: Reset signal)

# Contents

Chapter 1. Precautions for Safety .....	7
1.1 Safety Symbols and Meanings .....	8
Chapter 2. Usage .....	15
2.1 Name of Each Part .....	16
(1) System Configuration .....	16
(2) Name of Each Part of the Emulator .....	17
2.2 Starting Up the Emulator .....	19
2.3 Emulator Initial Settings .....	20
(1) MCU Power Supply Selection Jumpers .....	20
(2) Function Selection Switches .....	21
2.4 Connecting the Emulator System .....	22
(1) Connecting the USB Interface Cable .....	22
(2) Connecting the Power Cable .....	22
2.5 Connecting the Target System (As Occasion Demands) .....	23
(1) Connecting to a 144-pin 0.4-mm-pitch foot pattern .....	24
2.6 Turning On the Power .....	25
(1) Checking the Connection of the Emulator System .....	25
(2) Turning On the Power .....	25
(3) LED Display When the Emulator Starts Up Normally .....	26
2.7 Starting Up Emulator Debugger PD30M .....	27
2.8 Setting the Operating Environment of Emulator Debugger PD30M .....	27
2.9 When Emulator Debugger PD30M Starts Up Normally .....	27
Chapter 3. Changing the Settings .....	29
3.1 Using the Emulator without the Target System .....	30
3.2 Using the Emulator with the Target System .....	30
3.3 Selecting a Clock Supplied to an MCU .....	31
(1) How to Select a Clock Supplied to an MCU .....	31
(2) Using the Oscillator Circuit on the Target System .....	32
(3) Changing the Internal Oscillator Circuit of the Emulator .....	33
(4) Replacing Oscillator Circuit Boards .....	34
3.4 Mounting A-D Conversion Bypass Capacitors .....	35
Chapter 4. Specifications .....	37
4.1 Specifications .....	38
4.2 Memory Map .....	39
4.3 Connection Diagram .....	40
4.4 Emulator External Dimensions .....	41

Chapter 5. Troubleshooting .....	43
5.1 Troubleshooting Until the Emulator Starts Up .....	44
(1) Troubleshooting When the Emulator Starts Up .....	45
(2) Troubleshooting When Emulator Debugger PD30M Starts Up .....	46
5.2 Troubleshooting When Using Emulator Debugger PD30M .....	47
5.3 If Emulator Operation is Abnormal .....	48
(1) Self-check Procedure in Self-check Mode .....	48
(2) If an Error is Detected in the Self-check .....	49
5.4 How to Request for Support .....	50
Chapter 6. Maintenance and Guarantee .....	51
6.1 Maintenance .....	52
6.2 Guarantee .....	52
6.3 Repair Provisions .....	52
6.4 How to Request for Repair .....	53



# Chapter 1. Precautions for Safety

This chapter describes precautions for using this product safely and properly. For precautions for the emulator debugger, refer to user's manual included with your product.



1.1 Safety Symbols and Meanings .....	8
<b>WARNING</b> Warning for Handling This Product .....	9
Warning for Installation .....	9
Warning for Use Environment .....	9
<b>CAUTION</b> Cautions to Be Taken for Turning On the Power .....	9
Cautions to Be Taken for Handling This Product .....	9
Cautions to Be Taken for System Malfunctions .....	9
<b>IMPORTANT</b> Notes on Differences between the Actual MCU and Emulator .....	10
Note on MCU Functions That Cannot Be Used with This Emulator .....	11
Note on Restrictions in Using the Emulator (1/2) .....	12
Note on Restrictions in Using the Emulator (2/2) .....	13
Note on Controlling MCU Pins .....	13
Notes on the Target System (Power Supply, Order of Powering On) .....	13

# Chapter 1. Precautions for Safety

In both the User's Manual and on the product itself, several icons are used to insure proper handling of this product and also to prevent injuries to you or other persons, or damage to your properties.

This chapter describes the precautions which should be taken in order to use this product safely and properly. Be sure to read this chapter before using this product.

## 1.1 Safety Symbols and Meanings

	<b>WARNING</b>	If the requirements shown in the "WARNING" sentences are ignored, the equipment may cause serious personal injury or death.
	<b>CAUTION</b>	If the requirements shown in the "CAUTION" sentences are ignored, the equipment may malfunction.
	<b>IMPORTANT</b>	It means important information on using this product.

In addition to the three above, the following are also used as appropriate.

△ means WARNING or CAUTION.  
Example:  **CAUTION AGAINST AN ELECTRIC SHOCK**

⊘ means PROHIBITION.  
Example:  **DISASSEMBLY PROHIBITED**

● means A FORCIBLE ACTION.  
Example:  **UNPLUG THE POWER CABLE FROM THE RECEPTACLE.**

The following pages describe the symbols "WARNING", "CAUTION", and "IMPORTANT".

## **WARNING**

### **Warning for Handling This Product:**



- Do not disassemble or modify this product. Disassembling or modifying this product can cause damage.

### **Warning for Installation:**



- Do not set this product in water or areas of high humidity. Spilling water or some other liquid into the main unit can cause an unreparable damage.

### **Warning for Use Environment:**



- This equipment is to be used in an environment with a maximum ambient temperature of 35°C. Care should be taken that this temperature is not exceeded.

## **CAUTION**

### **Cautions to Be Taken for Turning On the Power:**



- Turn on the power of the emulator and target system as simultaneously as possible.
- Turn off the power of the emulator and target system as simultaneously as possible.
- Do not leave either the emulator or target system powered on, because of leakage current the internal circuits may be damaged.
- When turning on the power again after shutting off the power, wait about 10 seconds.

### **Cautions to Be Taken for Handling This Product:**



- Use caution when handling the main unit. Be careful not to apply a mechanical shock.
- Do not touch the connector pins of the emulator main unit and the target MCU connector pins directly. Static electricity may damage the internal circuits.
- Do not pull the compact emulator main unit by the USB interface cable for connecting to the target system. The cable may cause a break.
- Do not use inch-size screws for this equipment. The screws used in this equipment are all ISO (meter-size) type screws. When replacing screws, use same type screws as equipped before.

### **Cautions to Be Taken for System Malfunctions**



- If the emulator malfunctions because of interference like external noise, do the following to remedy the trouble.
  - (1) Press the RESET button on the emulator upper board.
  - (2) If normal operation is not restored after step (1), shut OFF the emulator once and then reactivate it.

# IMPORTANT

## Notes on Differences between the Actual MCU and Emulator:

- Operations of the emulator differs from those of flash version MCUs as listed below.

(1) Reset condition

Set the time for starting up (0.2 to 0.8 Vcc) 1  $\mu$ s or less.

(2) Data values of ROM areas at power-on

When power is turned on, the ROM areas of the emulator are defaulted to 04h.

(3) Register values when power is turned on

When power is turned on, the emulator's register values are defaulted to 0. However, the program counter is defaulted to the reset vector value (E0000h) initially set by the emulator.

(4) Internal memory (RAM and ROM) capacity, etc.

Because the internal memories (RAM and ROM) are emulated by the emulation memory, the capacity and assignment of the emulator's internal memories differ from those of the actual MCU. For memory mapping, see "4.2 Memory Map" (page 39).

(5) MCU functions

Some MCU functions cannot be used in the emulator system. For details, refer to "Note on MCU Functions That Cannot Be Used with This Emulator" (page 11).

(6) DBC\*, single-step and BRK instruction interrupt vector table addresses

As the emulator uses the DBC\*, single-step and BRK instruction interrupt vector table addresses, when data is read out from these addresses, the data are different from expected values.

Factor of interruption	Vector table addresses	Data read
DBC* <sup>1</sup>	FFFF4h--FFFF7h	Indefinite
Single-step* <sup>1</sup>	FFFECh--FFFEFh	Indefinite
BRK instruction	FFFE4h--FFFE7h	Indefinite

\*1 Interruption for the emulator only

(7) A-D and D-A converter function

As A-D and D-A converters have a pitch converter board between the evaluation MCU and the target system, some characteristics are slightly different from those of the actual MCU.

- As a pitch converter board and other devices are used between the evaluation MCU and the target system, some characteristics are slightly different from those of the actual MCU. Therefore, be sure to evaluate your system with an evaluation MCU. Before starting mask production, evaluate your system and make final confirmation with a CS (Commercial Sample) version MCU.

# IMPORTANT

## Note on MCU Functions That Cannot Be Used with This Emulator:

- The following MCU features cannot be used with this emulator.
  - (1) Debugging cannot be done with this emulator in neither memory expansion nor microprocessor mode.

M306K9 MCUs are specifically designed for use in single-chip mode.

    - When using this emulator, normally set the processor mode bit in the processor mode register to "single-chip mode".
    - When using this emulator, set pins M0 and M1 to "L" level.
  - (2) Oscillation circuits that use a resonator cannot be used.

Because a control circuit is situated between the evaluation MCU and the target system, oscillation circuits that connect a resonator between pins X<sub>IN</sub> and X<sub>OUT</sub> will not oscillate. The same applies to the sub-clock oscillation circuit (X<sub>CIN</sub>, X<sub>COU</sub>T): oscillation circuits with a resonator cannot be used. See "3.3 Selecting a Clock Supplied to an MCU" (page 31).
  - (3) Watchdog timers cannot be used.

MCU watchdog timers can only be used during program execution (free running). Disable watchdog timers in all other program operations (break, dump, forced stop, etc.).

Also, if the target system has a watchdog timer in its reset circuit, disable it, when you use the emulator.
  - (4) The BRK instruction cannot be used.

The BRK instruction cannot be used. The vector address of the BRK interrupt is normally indicated in the emulator work area, and the vector address value cannot be changed.
  - (5) Single-step interrupts cannot be used.

Single-step interrupts cannot be used. The vector address of a single-step interrupt is normally indicated in the emulator work area, and the vector address value cannot be changed.
  - (6) The DBC\* interrupt (debug interrupt) cannot be used.

The DBC\* interrupt cannot be used. The vector address of the DBC\* interrupt is normally indicated in the emulator work area, and the vector address value cannot be changed.
  - (7) Flash memory and EPROM modes are not emulated.

This emulator does not emulate flash memory and EPROM modes. Also, the emulator does not emulate CPU rewrite mode in flash memory mode.

# IMPORTANT

## Note on Restrictions in Using the Emulator (1/2):

- The following restrictions apply to this emulator.
  - (1) Debug command execution when the BCLK is stopped  
When the BCLK is stopped, debug commands (break, dump, single-step, forced stop, etc.) cannot be executed. The BCLK can stop in the following cases.
    - When the target clock is not oscillating
    - When the target MCU is in stop mode
    - When the target MCU is in wait mode
  - (2) MCU status while a program is stopped  
With this emulator, the program is stopped with a loop program to a specific address. Note that, in this case, peripheral circuits are still operating.
  - (3) Interrupts during single-step execution  
Interrupts are disabled during single-step execution. Accordingly, interrupt processing is not performed even if an interrupt request is sent.
  - (4) Address matched interrupt  
Do not set software breaks for an address for which an address matched interrupt is set. In step execution, do not execute addresses that generate address matched interrupts.
  - (5) Stop and wait modes  
Do not use a single-step for an instruction that shifts to stop mode. Operation does not shift to wait mode when the instruction that shifts to wait mode is executed as a single-step.
  - (6) Stack area  
With this emulator, user stacks specified by ISP consume 4 bytes. If there is not enough user stack area, using other areas not designed for use as stacks (SFR area, RAM area that stored data or ROM area) can damage the user program or destabilize emulator control. Therefore, ensure a maximum +4 bytes of the area used by the user program as user stack area.
  - (7) Trace results for addresses that set software breaks  
Software breaks replace the original instruction with the BRK instruction that generates the BRK interrupt. When trace results are viewed in the bus display, "00h" is displayed by fetching (by instruction) the address that sets the software break, however in the reverse assembly display, the "BRK" instruction is displayed.
  - (8) Reading MCU's internal resources  
When the registers that are listed below are read with an emulator, those results will be the following (the data in the MCU are not effected).
    - Results of real-time trace: The data values of the cycles read are not displayed correctly.
    - Real-time RAM monitor: The data values read are not displayed correctly.

Register	Symbol
DMA source pointers 0, 1	SAR0, SAR1
DMA destination pointers 0, 1	DAR0, DAR1
DMA transfer counters 0, 1	TCR0, TCR1
DMA control registers 0, 1	DM0CON, DM1CON

- (9) Debug command execution during user program execution  
The real-time aspect of the user program is not guaranteed when debug commands such as dump are executed during user program execution.
- (10) Reset vector area
  - Memory in the emulator main unit is always selected as a reset vector area.
  - You can change data in the reset vector area only when the user program is stopped.

# IMPORTANT

## Note on Restrictions in Using the Emulator (2/2):

- The following restrictions apply to this emulator.
  - (11) DMA transfer

With this product, the program is stopped with a loop program to a specific address. Therefore, if a DMA request is generated while the program is stopped, DMA transfer is executed. However, make note that DMA transfer while the program is stopped may not be performed correctly. Also note that the below registers have been changed to generate DMA transfer as explained here even when the program is stopped.

    - DMA0 transfer counter: TCR0
    - DMA1 transfer counter: TCR1
  - (12) Software and hardware breaks

It is not possible to use a software break and a hardware break at the same time. If doing so, this product may not operate normally.

## Note on Controlling MCU Pins:

- Some MCU pins are controlled by the emulator.
  - (1) RESET\* input

The RESET\* input from the target system is accepted only while a user program is being executed (only while the RUN status LED of the emulator is lit).
  - (2) NMI\* input

The NMI\* input from the target system is accepted only while a user program is being executed (only while the RUN status LED of the emulator is lit).

## Notes on the Target System (Power Supply, Order of Powering On):

- When the target system is connected, be sure to set the JP1 of the emulator to "EXT".
  - This emulator cannot supply the power to the target system. Therefore design your system so that the target system is powered separately.
  - This emulator consumes max. 500 mA of electric current from the target system.
  - The voltage of the target system should be within the range of 3.0 to 3.6 V.
  - Do not change the voltage of the target system after turning on the power.
  - Before powering on your emulator system, check that the host machine, the emulator, the converter board and target system are all connected correctly. Next, turn on the power to each equipment following the procedure below.
    - (1) Turn ON/OFF the target system and the emulator as simultaneously as possible.
    - (2) When the emulator debugger starts up, check the target status LEDs on the emulator to see if this product is ready to operate.
      - Is the power supplied? ..... Check that target status LED (POWER) is ON.\*<sup>1</sup>
      - Is the clock supplied? ..... Check that target status LED (CLOCK) is ON.
- \*<sup>1</sup> When the target system is not connected, the target status LED (POWER) is not lit.

# MEMO



# Chapter 2. Usage

This chapter describes how to operate this product.

2.1 Name of Each Part .....	16
2.2 Starting Up the Emulator .....	19
2.3 Emulator Initial Settings .....	20
2.4 Connecting the Emulator System .....	22
2.5 Connecting the Target System (As Occasion Demands) .....	23
2.6 Turning On the Power .....	25
2.7 Starting Up Emulator Debugger PD30M .....	27
2.8 Setting the Operating Environment of Emulator Debugger PD30M .....	27
2.9 When Emulator Debugger PD30M Starts Up Normally .....	27

# Chapter 2. Usage

## 2.1 Name of Each Part

### (1) System Configuration

Figure 2.1 shows the system configuration for this emulator.

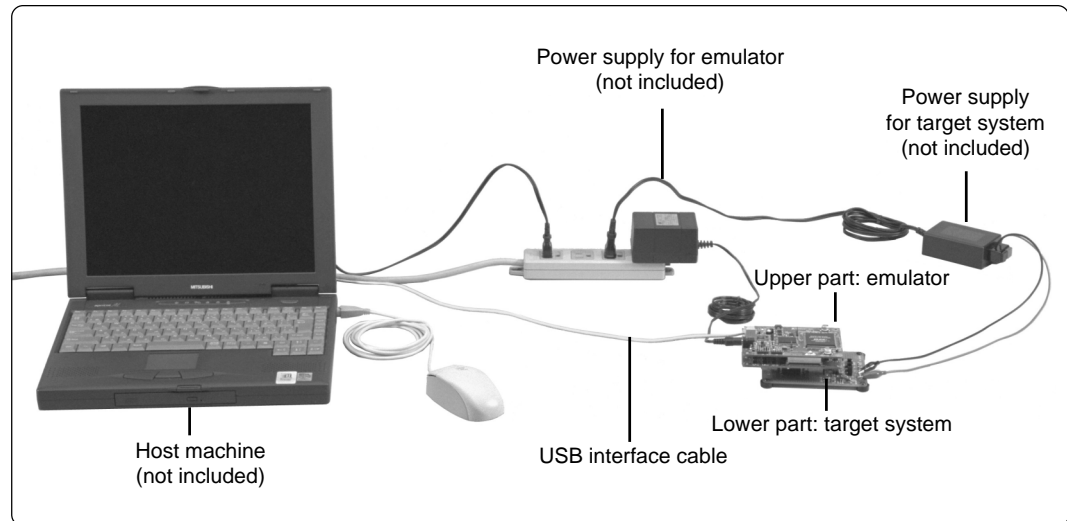

Figure 2.1 System configuration

#### (1) Emulator M306K9T2-CPE (included)

This is a compact emulator for the M16C/6K Group M306K9 of 16-bit microcomputers with the real-time trace functions (hereafter, emulator).

#### (2) USB interface cable (included)

This is an interface cable for the host machine and the emulator.

#### (3) Power supply for emulator (not included)

This is a power supply for the emulator. Supply 5.0 V  $\pm$ 5% (DC).

Prepare the power supply separately. The power cable is included with this product.

Note: Be aware that there are some AC adapters whose power supply voltage varies rather widely with its load. You are recommended to use an AC adapter with a switching power supply or a stabilized power supply.

#### (4) Target system (not included)

This is your application system. This emulator can be used without the target system.

#### (5) Power supply for the target system (not included)

This is a power supply for the target system. As this emulator cannot supply the power to the target system, supply the power to the target system separately from the emulator.

#### (6) Host machine (not included)

This is a personal computer for controlling the emulator.

## (2) Name of Each Part of the Emulator

Figure 2.2 shows the name of each part of the emulator.

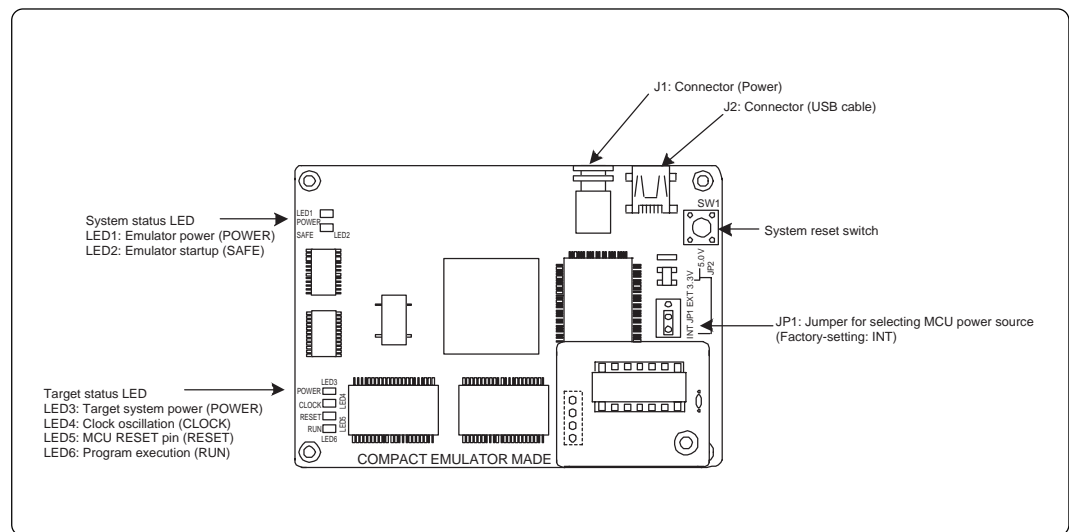

Figure 2.2 Name of each part of the emulator (upper side of the M306K9T2-CPE)

### (1) System status LEDs

The system status LEDs indicate the emulator main unit's power supply. Table 2.1 lists the definition of system status LED.

Table 2.1 Definition of system status LEDs

Name	Number	Color	Status	Function
POWER	LED1	Orange	ON	Power is supplied to the emulator.
			OFF	Power is not supplied to the emulator.
SAFE	LED2	Green	ON	Emulator system has started normally.
			OFF	Emulator system has not started normally.

### (2) Target status LEDs

The target status LEDs indicate the target MCU's power supply and operating status. Table 2.2 lists the definition of each target status LEDs.

Table 2.2 Definition of target status LEDs

Name	Number	Color	Status	Function
POWER	LED3	Orange	ON	Power is supplied to the target MCU.
			OFF	Power is not supplied to the target MCU.
CLOCK	LED4	Green	ON	BCLK is output from the target MCU.
			OFF	BCLK is not output from the target MCU.
RESET	LED5	Red	ON	Target MCU is being reset.
			OFF	Target MCU is not being reset.
RUN	LED6	Green	ON	User program is being executed.
			OFF	User program is not being executed.

### (3) System reset switch

By pressing the system reset switch, you can initialize the emulator system. Table 2.3 shows the functions of the system reset switch depending on the state of the emulator.

*Table 2.3 Functions of the system reset switch*

State of Emulator	Function
When the user's program is halted	Initializes the emulator and waits for a command from the emulator debugger.
When the user's program is executed	Stops the user's program, initializes the emulator, and waits for a command from the emulator debugger.

## CAUTION

### **Note on a System Reset:**

- After pressing the system reset switch, reboot the emulator debugger PD30M. Otherwise the display of emulator debugger and the actual value (in the emulator) may not match.
- When the emulator debugger does not start up normally even after rebooting, turn off the emulator and then turn on again.

## 2.2 Starting Up the Emulator

The procedure for starting up the emulator is shown in Figure 2.3. For details, refer to each section hereafter. And, when the emulator does not start up normally, refer to "Chapter 5. Troubleshooting" (page 43).

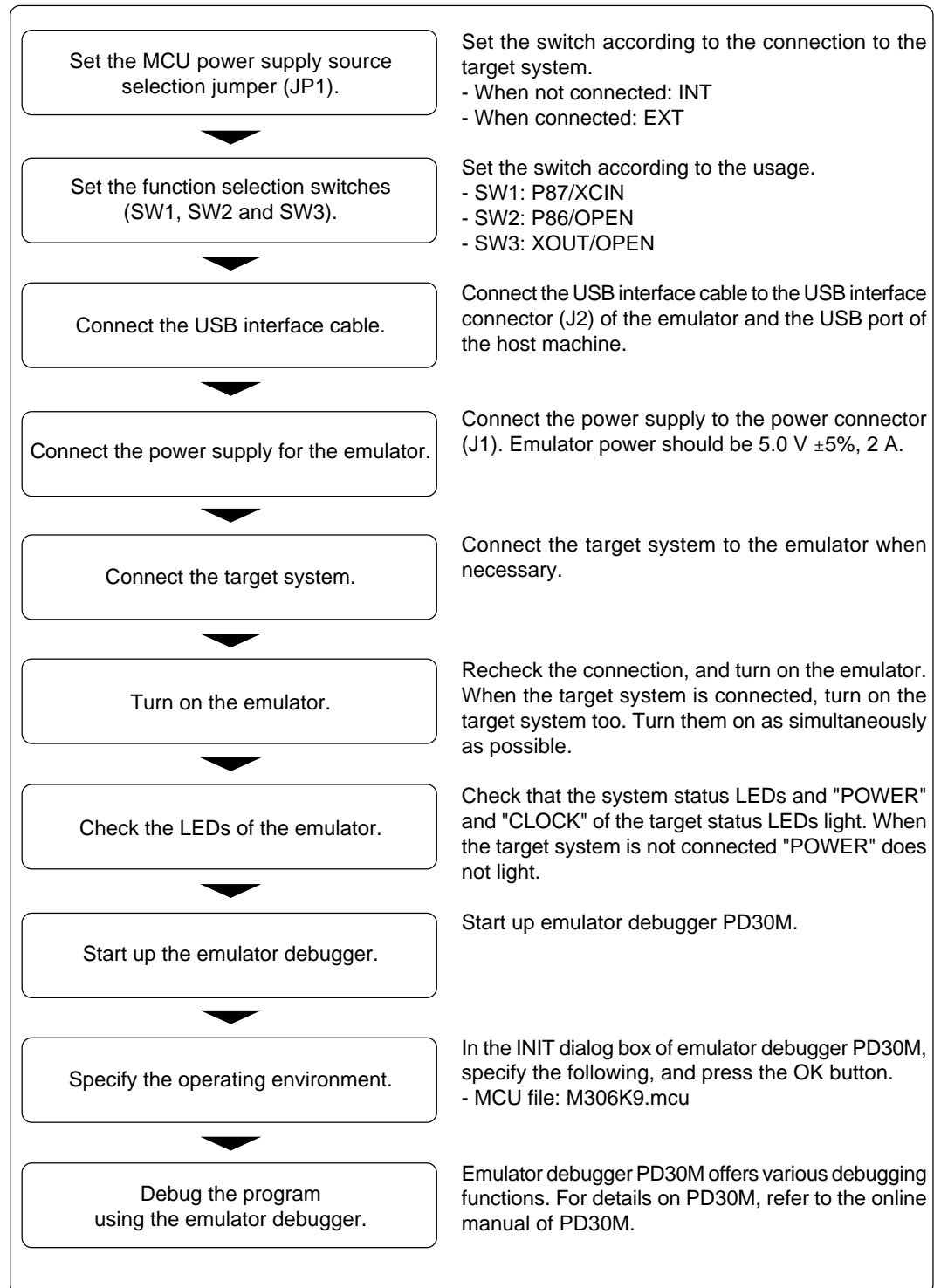

Figure 2.3 Procedure for starting up the emulator

## 2.3 Emulator Initial Settings

Set the MCU power supply selection jumpers and the function selection switch of the emulator according to conditions of use.

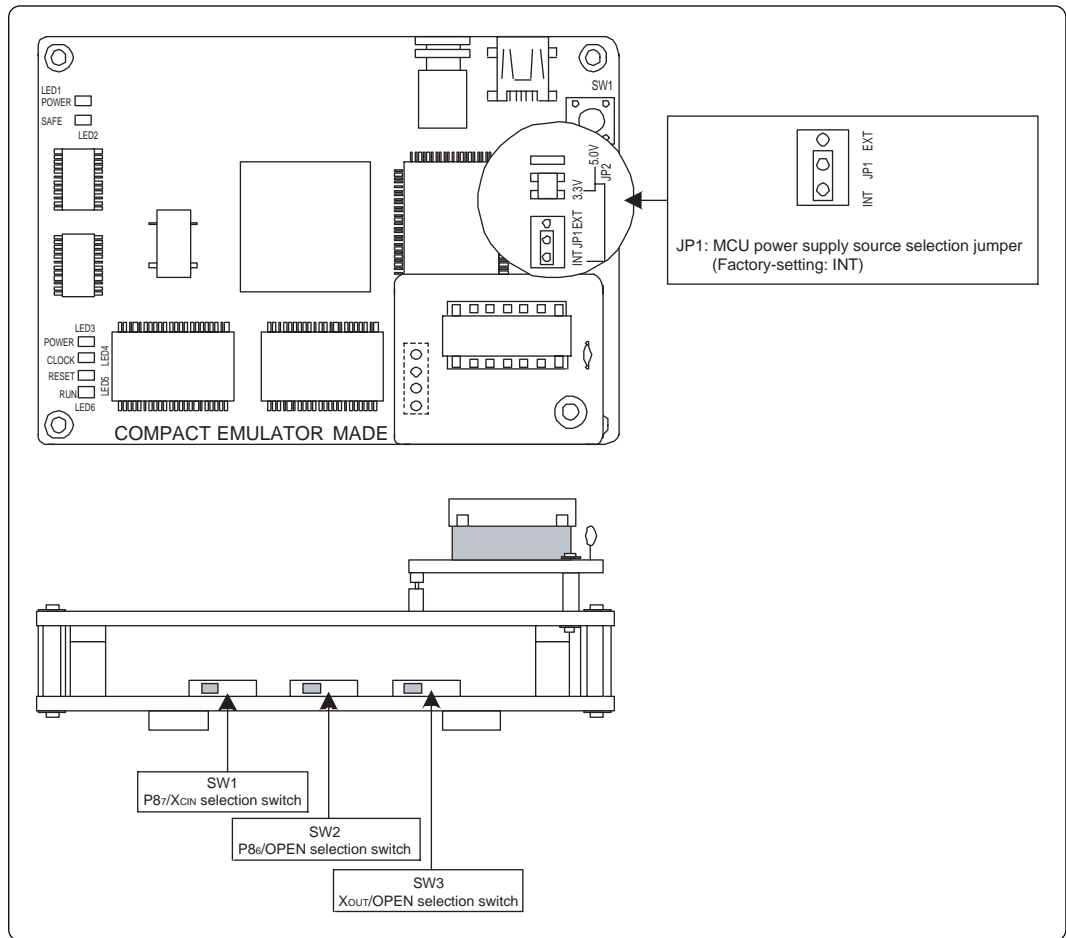

Figure 2.4 Emulator initial settings

### (1) MCU Power Supply Selection Jumpers

This is the jumper switch to select power supply to the MCU. As shown in Table 2.4 below, set the switch according to the connection to the target system.

Table 2.4 Setting MCU power supply selection jumpers

Connection to the target system	MCU power supply source selection jumper (JP1)	Description
Not connected	INT	Supplied from the emulator. The MCU operating voltage is 3.3 V.
Connected	EXT	Supplied from the target system. This emulator consumes max. 500 mA of electrical current from the target system.

## (2) Function Selection Switches

According to the usage, set these switches as described in Table 2.5 below.

Table 2.5 Setting function selection switches

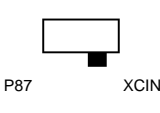
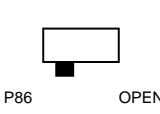
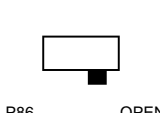
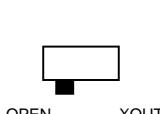
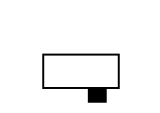
Signal	Switch	Setting	Description
P87/XCIN	SW1	 <p>P87 XCIN Factory-setting</p>	Connects pin P87/XCIN of the MCU to the target system (uses pin P87/XCIN as P87).
		 <p>P87 XCIN</p>	Connects pin P87/XCIN of the MCU to the sub-clock oscillator circuit (32.768 kHz).
P86/XCOUT	SW2	 <p>P86 OPEN Factory-setting</p>	Connects pin P86/XCOUT of the MCU to the target system (uses pin P86/XCOUT as P86/XCOUT).
		 <p>P86 OPEN</p>	Does not connect pin P86/XCOUT of the MCU.
XOUT	SW3	 <p>OPEN XOUT Factory-setting</p>	Does not connect pin XOUT of the MCU.
		 <p>OPEN XOUT</p>	Connects pin XOUT of the MCU to the target system.

### CAUTION

#### Note on Setting Switches and Jumper Switches:

- Always shut OFF the emulator before changing the setting of the switches and jumper switches, and connecting the cable.

## 2.4 Connecting the Emulator System

How to connect the emulator system is described hereafter.

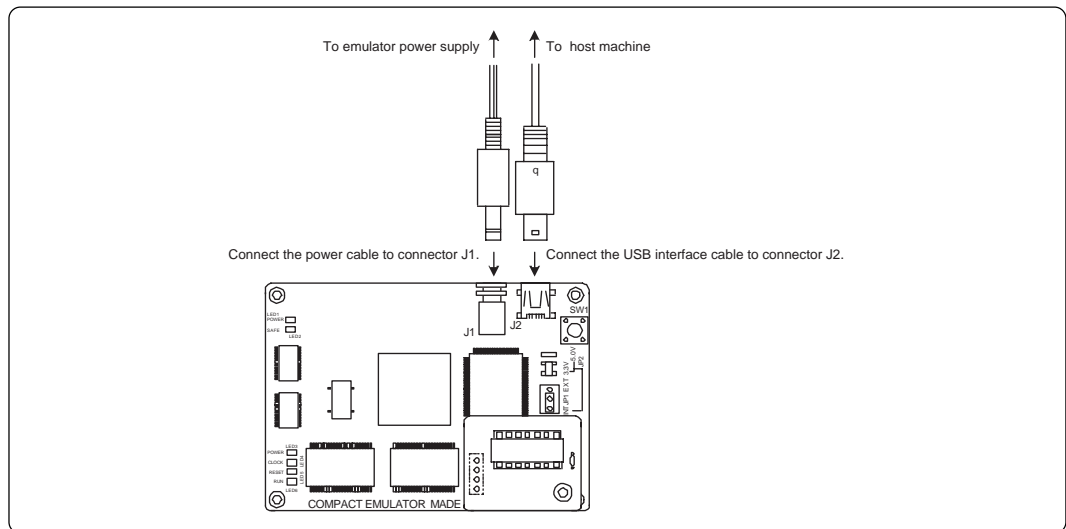

Figure 2.5 Connecting the emulator system

### (1) Connecting the USB Interface Cable

Connect the USB interface cable (included) to the USB interface connector (J2) and the USB port of the host machine (see Figure 2.5).

### (2) Connecting the Power Cable

Connect the power supply for the emulator to the power connector (J1). The specification of the power supply for the emulator is listed in Table 2.6.

Table 2.6 Specification of power supply of the emulator

Power supply voltage	DC 5.0 V $\pm$ 5%, 2 A
----------------------	------------------------

Figures 2.6 and 2.7 show the specifications of the power connector and an applicable plug, respectively.

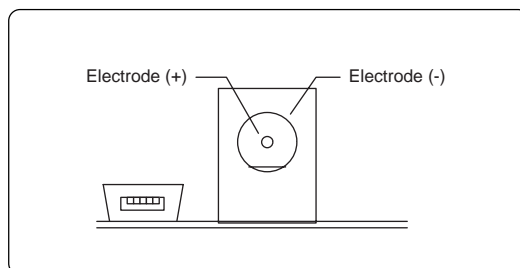

Figure 2.6 Specification of the power connector

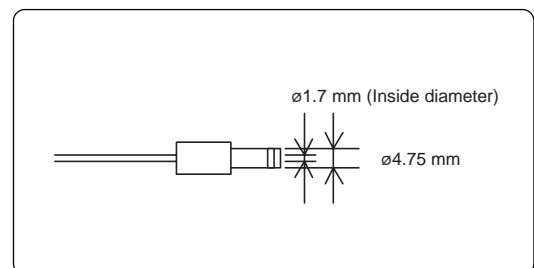

Figure 2.7 Specification of an applicable plug

## ⚠ CAUTION

### Note on Connecting the Power Supply of the Emulator:

- Be careful about the polarity of the power supply. Connecting to the wrong electrode could destroy internal circuits.
- The power cable included in this product package is colored red (+) and black (-).
- Do not apply a voltage exceeding the specified voltage of the product (5.0 V  $\pm$ 5%), because it may cause burn injuries and the failure of internal circuits.



## 2.5 Connecting the Target System (As Occasion Demands)

To connect the target system you need a pitch converter board (not included) shown in Figure 2.8. Be sure to align the position of No. 1 pin to connect it.

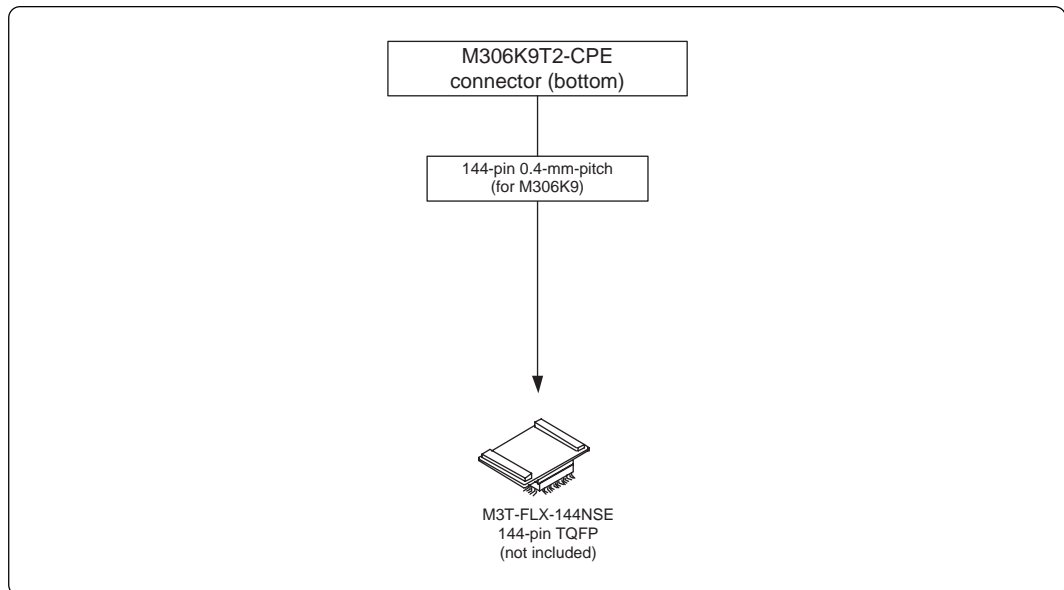

Figure 2.8 Connecting to the target system

### CAUTION

#### Notes on Connecting Target Systems:

- Take care not to attach the converter board in a wrong direction. It may cause a fatal damage to the compact emulator.
- Always shut OFF the emulator and the target system when connecting and disconnecting the target system.

## (1) Connecting to a 144-pin 0.4-mm-pitch Foot Pattern

Figure 2.9 shows how to connect this product to a 144-pin 0.4-mm-pitch foot pattern on the target system with the M3T-FLX-144NSE, and here following is its procedure.

- (1) Mount the NQPACK144SE included with the M3T-FLX-144NSE to the target system.  
For details on the M3T-FLX-144NSE, refer to its user's manual.
- (2) Attach the YQPACK144SE included with the M3T-FLX-144NSE to the NQPACK144SE.
- (3) Insert the YQ-GUIDE's included with this product to the YQPACK144SE.
- (4) Attach the M306K9T2-CPE to the M3T-FLX-144NSE.
- (5) Attach the M3T-FLX-144NSE to the YQPACK144SE.

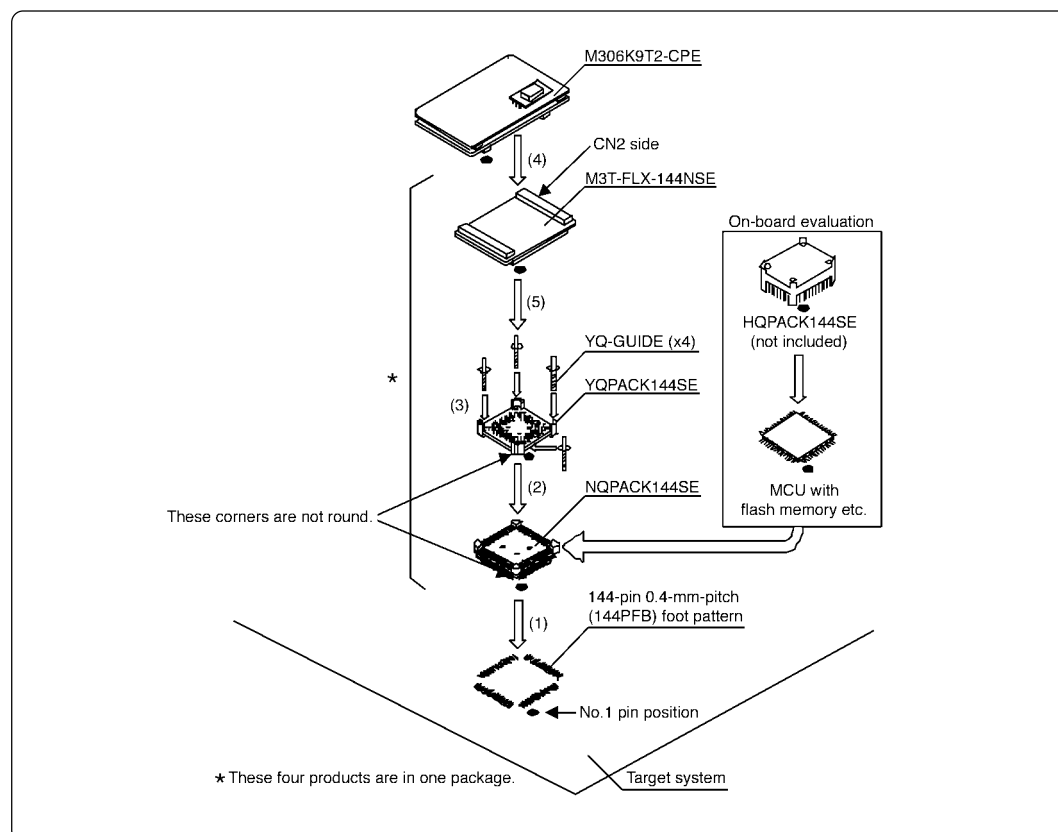

Figure 2.9 Connecting to a 144-pin 0.4-mm-pitch foot pattern

## CAUTION

### Notes on Connecting the Target System:

- Take care not to attach the converter board in a wrong direction. It may cause a fatal damage to the compact emulator.
- The small connectors of the M3T-FLX-144NSE are guaranteed for only 50 insertion/removal iterations.

## 2.6 Turning On the Power

### (1) Checking the Connection of the Emulator System

Before turning the power ON, check the connection of the host machine and the emulator main unit.

### (2) Turning On the Power

Power ON the target system and the emulator main unit as simultaneously as possible.

## CAUTION

### Notes on Power Supply:

- **As this emulator cannot supply power to the target system, provide the target system with a separate power supply from that of the emulator.**
- This emulator consumes max. 500 mA of electrical current from target system. Therefore, set the power supply of the target system considering this consumption.
- Keep target system power supply voltage within the range of 3.0 to 3.6 V.
- Do not change target system power supply voltage after power has been activated.

### (3) LED Display When the Emulator Starts Up Normally

After the emulator starts up, check the status of the LEDs to see whether the emulator operation is enabled or not.

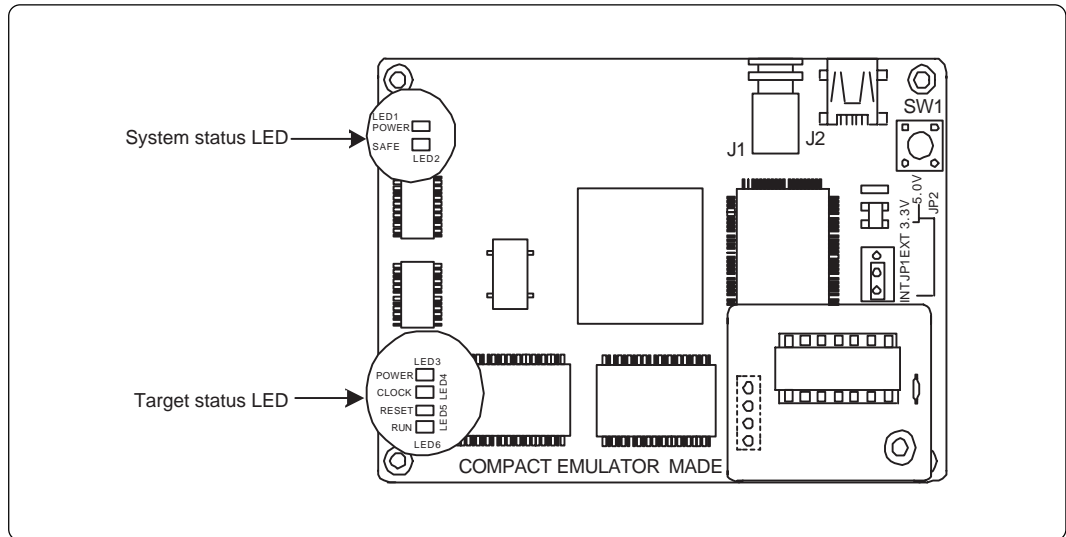

Figure 2.10 Positions of system status LEDs and target status LEDs

#### (1) System status LEDs

Check that the LED1 of the system status LEDs is lit immediately after the power is activated. If it is not lit, shut off the emulator and check the power supply for the emulator is properly connected.

#### (2) Target status LEDs

Target status LEDs light as shown in Figure 2.11 when the target system is not connected and as shown in Figure 2.12 when a target system is connected. **For about 5 seconds after power is turned on, all the target status LEDs light up normally.**

If the target status LEDs do not light as shown in Figure 2.11 or Figure 2.12, see "5.1 Troubleshooting Until the Emulator Starts Up" (page 44).

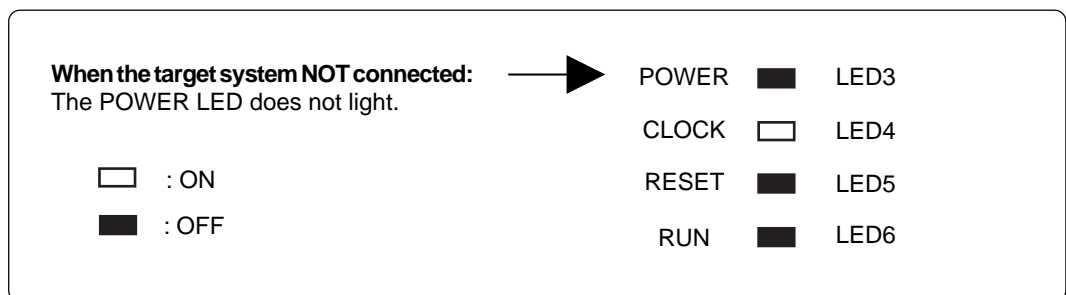

Figure 2.11 LED display when the emulator starts up normally (target not connected)

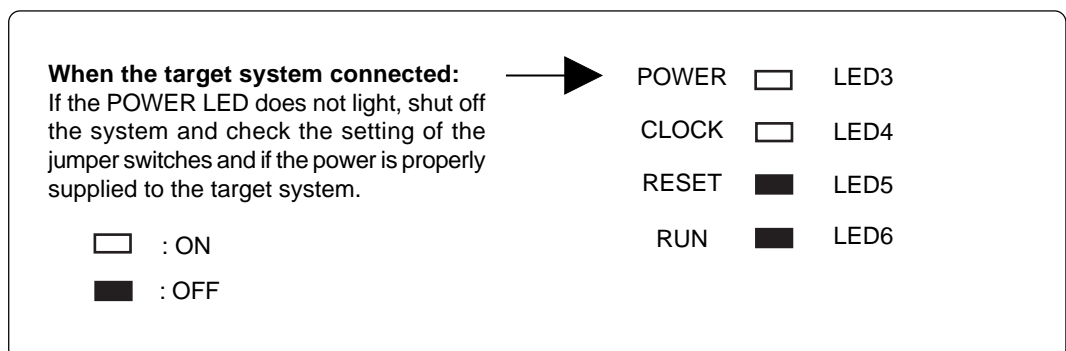

Figure 2.12 LED display when the emulator starts up normally (target connected)

## 2.7 Starting Up Emulator Debugger PD30M

After checking the emulator has started up normally, start up emulator debugger PD30M.

To start up the emulator debugger, follow the steps below.

Click the Start button of Windows.

And select Program (P) -> [RENESAS-TOOLS] -> [PD30M V.2.00 Release 1] -> [PD30M].



## 2.8 Setting the Operating Environment of Emulator Debugger PD30M

After starting up PD30M, as the Init dialog box will open, set as shown in Figure 2.13. For details on the Init dialog box, refer to the user's manual of PD30M.

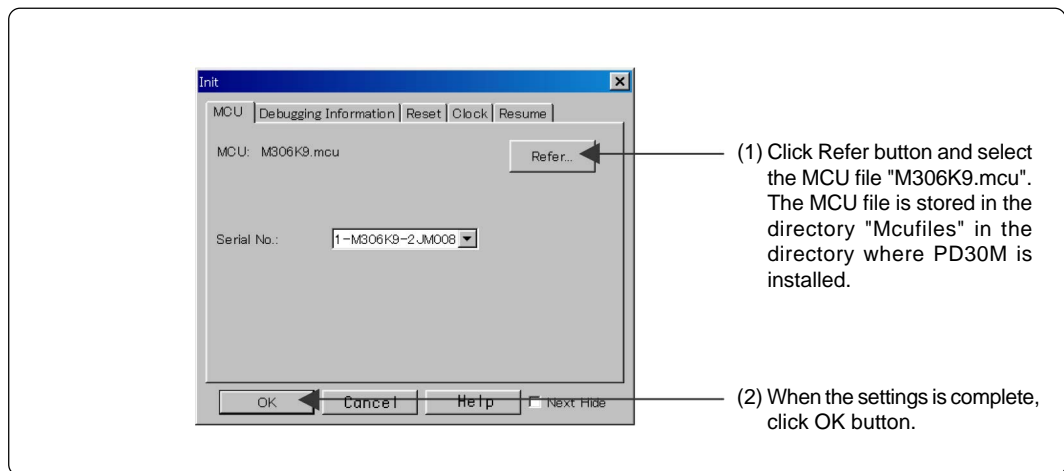

Figure 2.13 Setting the Init dialog box

## 2.9 When Emulator Debugger PD30M Starts Up Normally

Figure 2.14 shows the window display when PD30M starts up normally.

If an error has been detected and PD30M has not started up, refer to "5.1 Troubleshooting Until the Emulator Starts Up" (page 44).

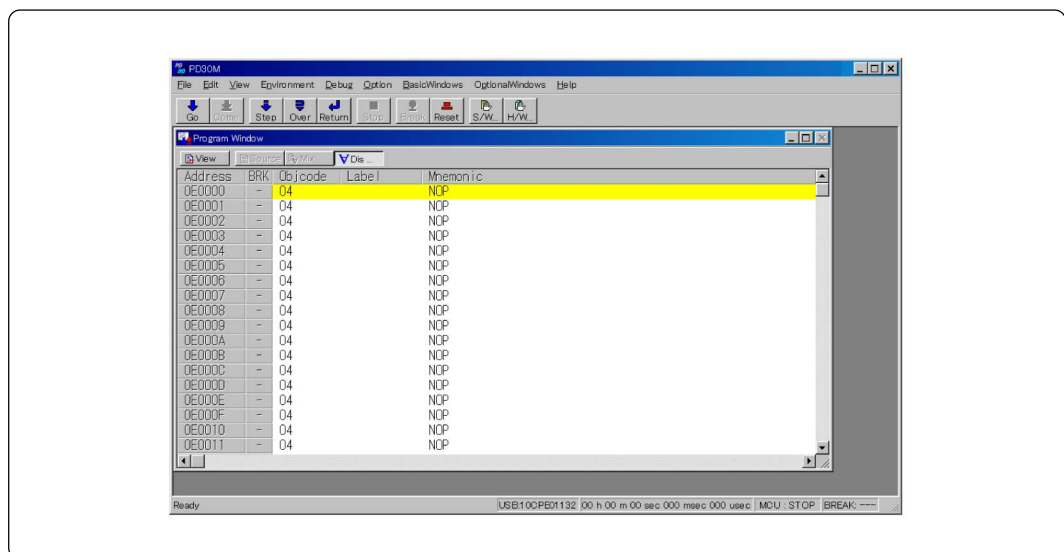

Figure 2.14 Window display of PD30M when it has started up normally

# MEMO

# Chapter 3. Changing the Settings

This chapter describes how to change the setting of this product.

3.1 Using the Emulator without the Target System .....	30
3.2 Using the Emulator with the Target System.....	30
3.3 Selecting a Clock Supplied to an MCU .....	31
3.4 Mounting A-D Conversion Bypass Capacitors .....	35

# Chapter 3. Changing the Settings

## 3.1 Using the Emulator without the Target System

How to use the emulator without the target system is shown below.

- (1) Set the "MCU power supply source selection jumper" to INT side (see page 20).

The target MCU operates with 3.3 V of power supply voltage supplied from the emulator.

## 3.2 Using the Emulator with the Target System

How to use the emulator with the target system is shown below.

- (1) Set the "MCU power supply source selection jumper" to EXT side (see page 20).

When using the emulator with the target system, set the "MCU power supply source selection jumper" to EXT side.

- (2) Connect the target system (see page 23).

Connect the emulator to the target system via a pitch converter board (not included).

- (3) Connect the power supply for the emulator (see page 25).

As the emulator cannot supply power to the target system, provide the target system with a separate power supply from that of the emulator.



### 3.3 Selecting a Clock Supplied to an MCU

There are two ways to supply a clock to the MCU, using the oscillator circuit of the emulator or using the oscillator circuit on the target system. Table 3.1 lists the factory-settings of each clock supply.

Table 3.1 Clock supply to the MCU

Clock	Description	Display of emulator debugger	Default setting
X <sub>IN</sub> -X <sub>OUT</sub> (main clock)	Internal oscillator circuit of emulator (16 MHz)	Internal	Yes
	Target system	External	-
X <sub>CIN</sub> -X <sub>COU</sub> T (sub-clock)	Internal oscillator circuit of emulator (32.768 kHz)	Internal	-
	Target system	External	Yes

## IMPORTANT

### Note on Changing the Clock Supply:

- For using pins X<sub>CIN</sub>-X<sub>COU</sub>T, it is necessary to set the function selection switch (SW1) of the emulator to XCIN side. For details, refer to "2.3 (2) Function Selection Switches" (page 21).

#### (1) How to Select a Clock Supplied to an MCU

Change a clock by the Clock tab of the Init dialog box when starting up the emulator debugger or the CLK command input on the script window. For details, refer to user's manual of the emulator debugger.

##### (1) Selecting by the Init dialog box

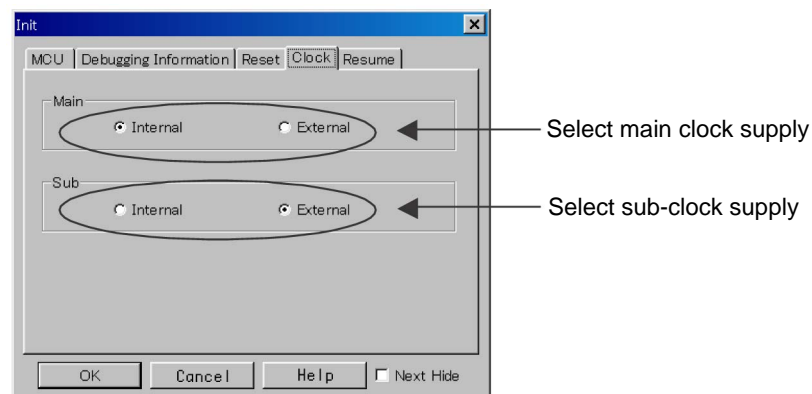

##### (2) Selecting by CLK command

Examples of CLK command input by the script window is shown below.

Example 1) When X<sub>IN</sub>-X<sub>OUT</sub> (main clock) is supplied internally and X<sub>CIN</sub>-X<sub>COU</sub>T (sub-clock) is supplied externally:

CLK INT, EXT

Example 2) When X<sub>IN</sub>-X<sub>OUT</sub> (main clock) is supplied externally and X<sub>CIN</sub>-X<sub>COU</sub>T (sub-clock) is supplied internally:

CLK EXT, INT

## (2) Using the Oscillator Circuit on the Target System

To operate the compact emulator with the oscillator circuit on the target system, construct the oscillator circuit as shown in Figure 3.1 in the target system and input the oscillator output at 50% duty (within the operating range of the evaluation MCU) into pin  $X_{IN}$ . And pin  $X_{OUT}$  should be open. It is same for sub-clock oscillator ( $X_{CIN}$  and  $X_{COUT}$ ).

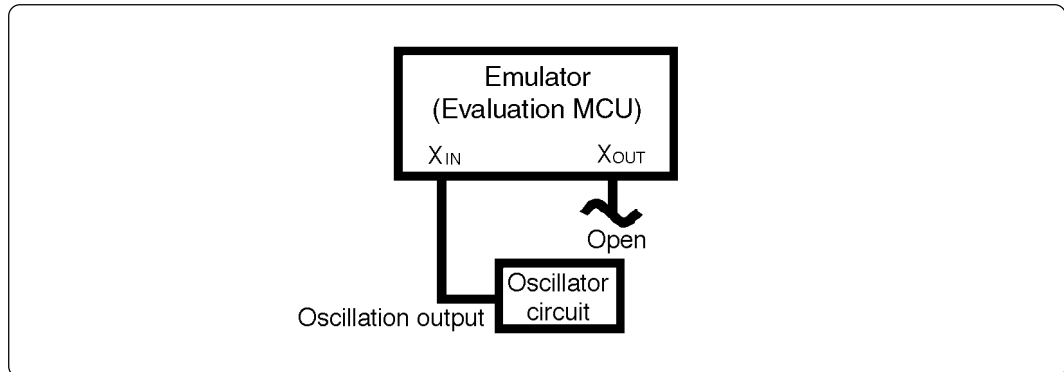

Figure 3.1 External oscillator circuit

Make note of the fact that in the oscillator circuit shown in Figure 3.2 where a resonator is connected between pins  $X_{IN}$  and  $X_{OUT}$ , oscillation does not occur because an emulation circuit is used between the evaluation MCU and the target system. It is same for sub-clock oscillator circuits ( $X_{CIN}$  and  $X_{COUT}$ ).

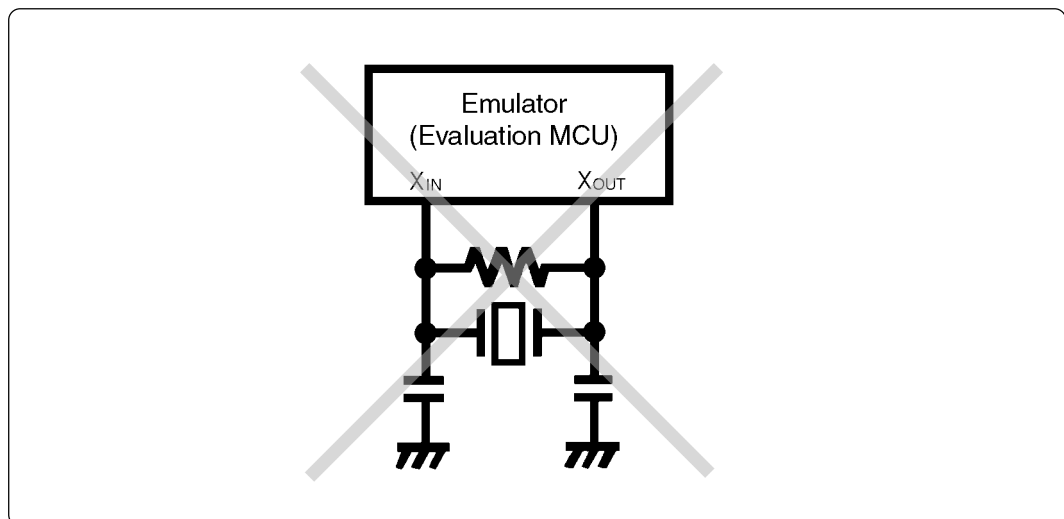

Figure 3.2 Circuit in which oscillation does not occur (same for  $X_{CIN}$ - $X_{COUT}$ )

## IMPORTANT

### Notes on Operating an Oscillator Circuit on the Target System:

- To operate this product with an external clock, construct the oscillator circuit as shown in Figure 3.6 in the target system and input the oscillator output at 50% duty (within the operating range of the evaluation MCU) into pin  $X_{IN}$ . And pin  $X_{OUT}$  should be open.
- Make note that in the oscillator circuit shown in Figure 3.2 where a resonator is connected between pins  $X_{IN}$  and  $X_{OUT}$ , oscillation does not occur because a converter board and other devices are used between the evaluation MCU and the target system. It is same for sub-clock oscillator circuits ( $X_{CIN}$  and  $X_{COUT}$ ).

### (3) Changing the Internal Oscillator Circuit of the Emulator

An oscillator circuit board for 16 MHz (OSC-3) is mounted on this product. To use this product at a frequency other than 16 MHz, build the desired oscillator circuit on the included OSC-2 oscillator circuit board (bare board) and replace the board installed in this product when shipped from the factory.

Figure 3.3 shows an external view of the OSC-2 oscillator circuit board (bare board) and where connector pins are located. Figure 3.4 shows the circuitry of the OSC-2 oscillator circuit board (bare board). Use the number of oscillator circuits recommended by the oscillator manufacturer.

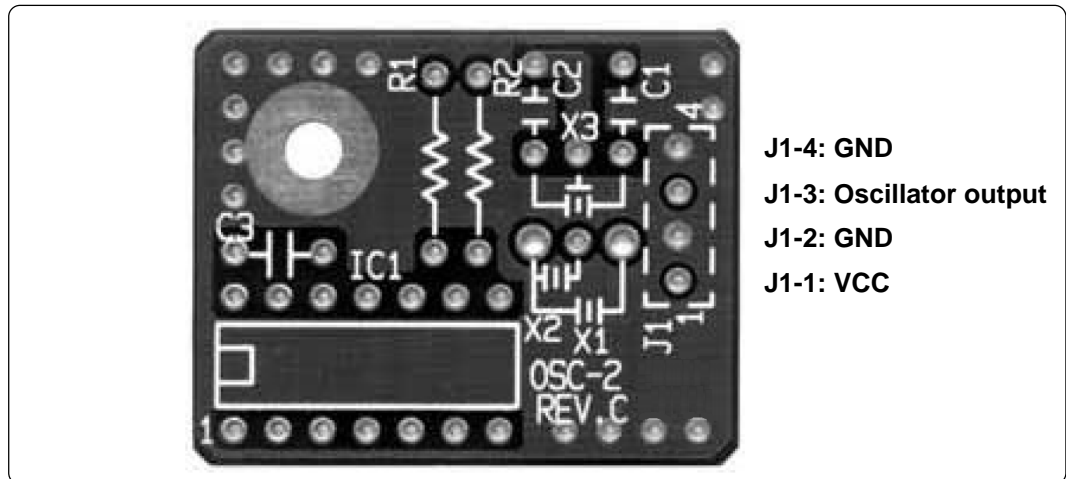

Figure 3.3 External view of the oscillator board (OSC-2) and connector pin assignment

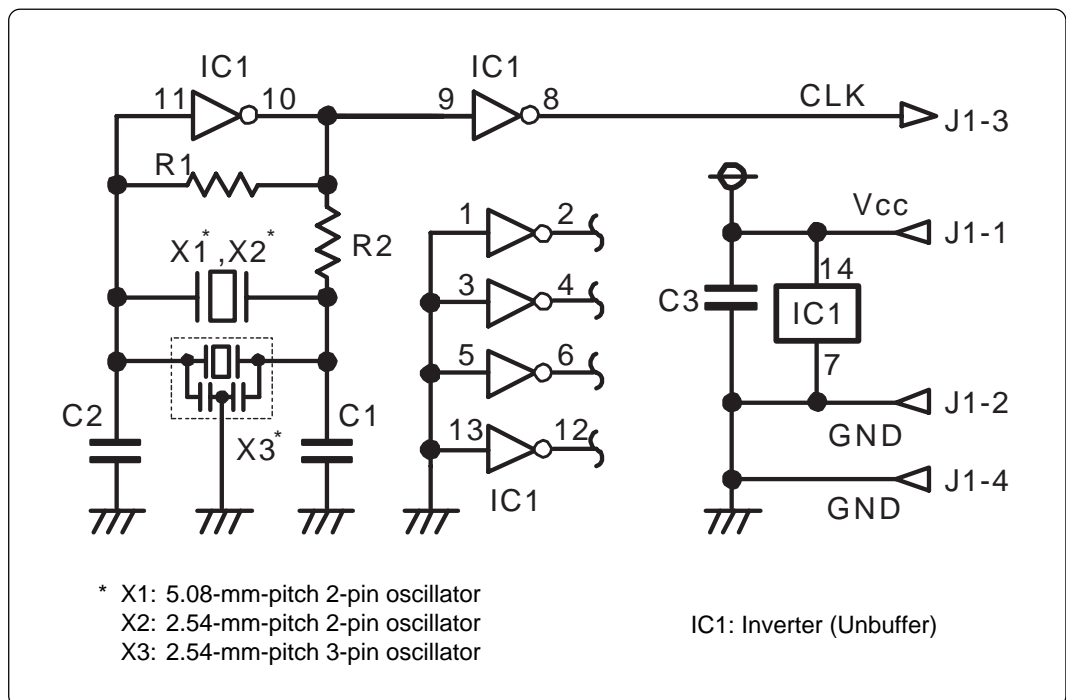

Figure 3.4 Circuit of the oscillator circuit board (OSC-2)

#### (4) Replacing Oscillator Circuit Boards

Figure 3.5 shows how to replace the oscillator circuit boards.

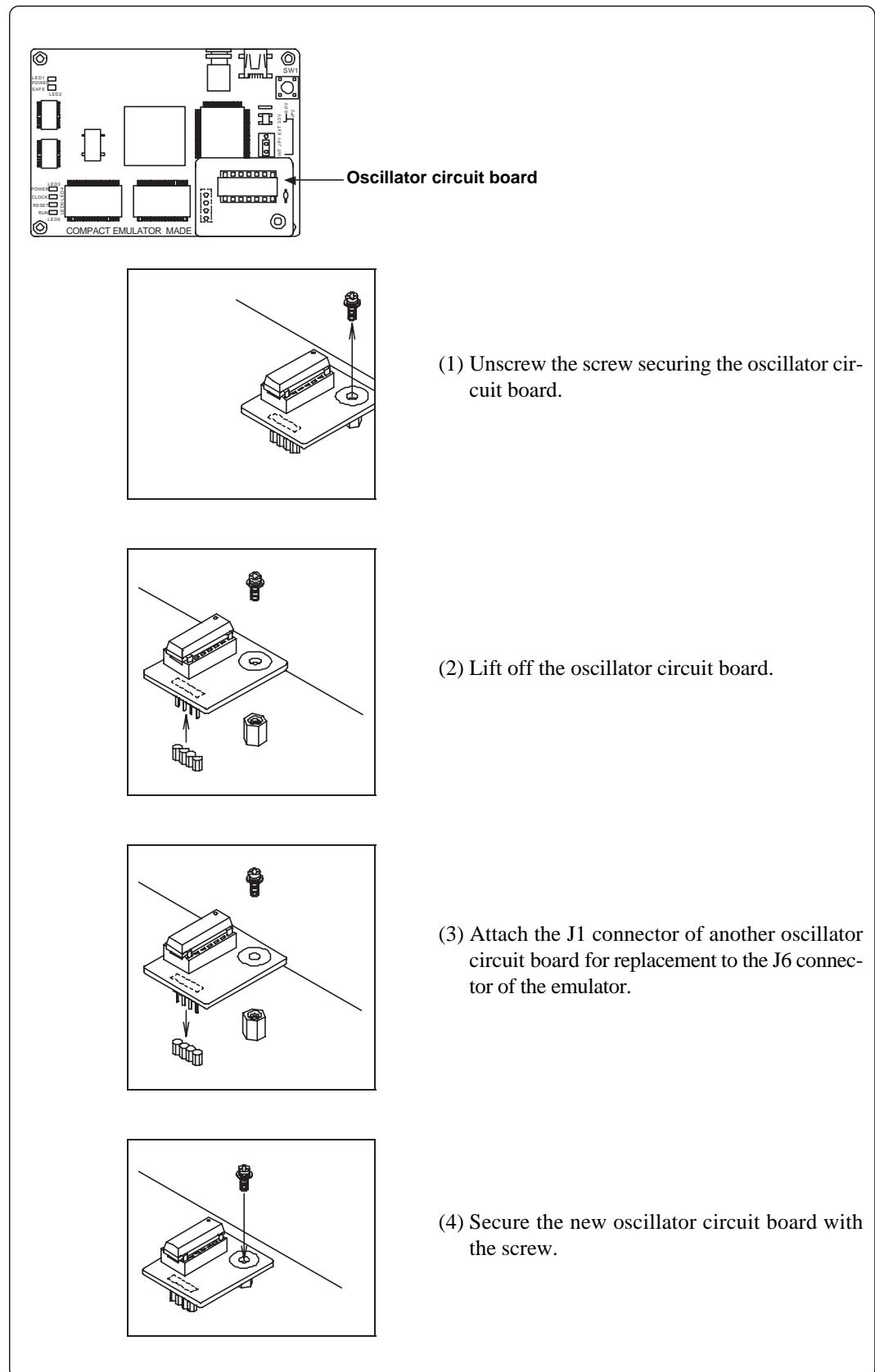

Figure 3.5 Replacing oscillator circuit boards

### 3.4 Mounting A-D Conversion Bypass Capacitors

There is a foot pattern on the M306K9T-EPBM board for mounting bypass capacitors for the A-D conversion circuit near the MCU. Mount suitable bypass capacitors as occasion demands. Figure 3.6 shows where they are installed and the configuration of this product.

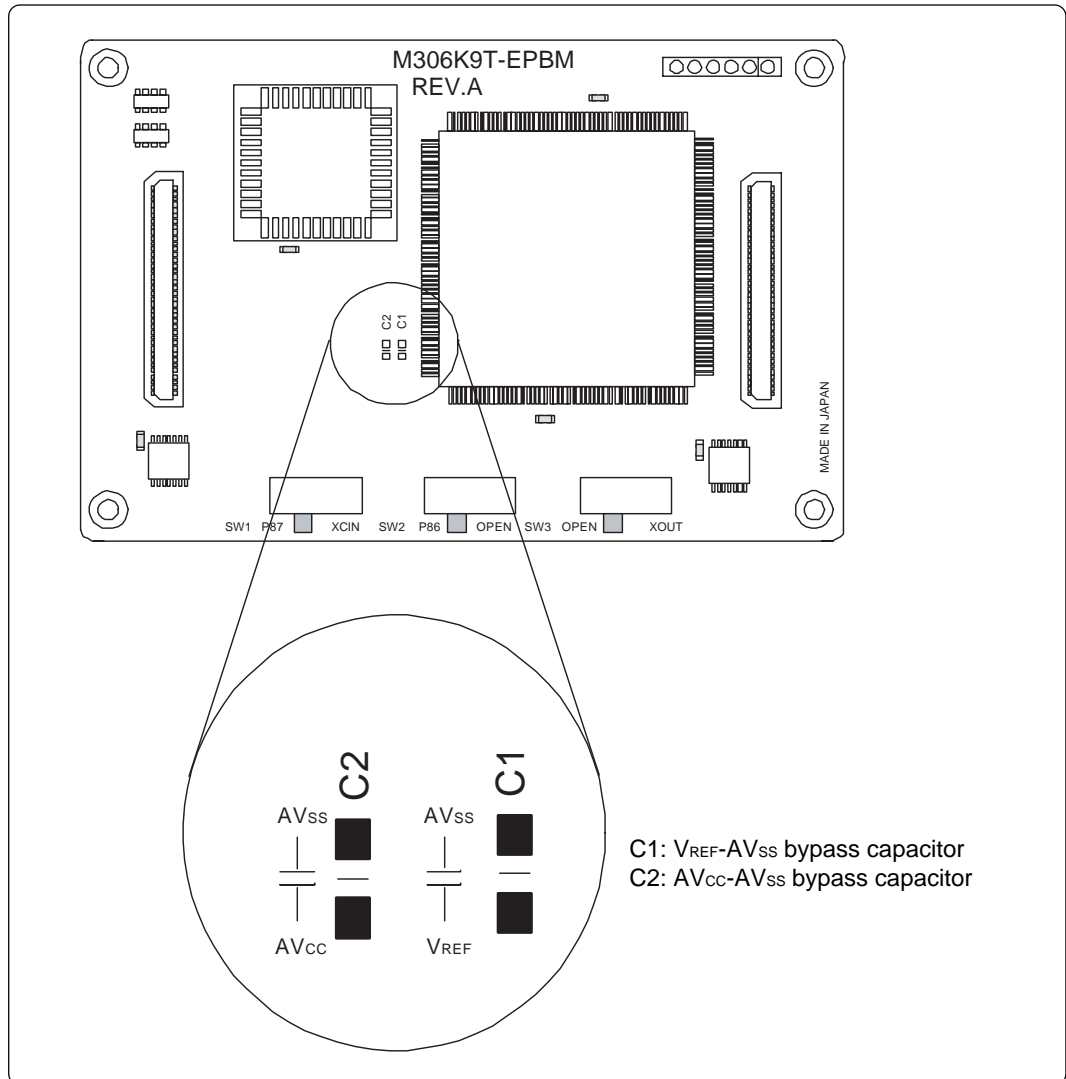

Figure 3.6 Foot pattern for A-D conversion bypass capacitors

## IMPORTANT

### Note on the A-D Converter Function:

- Because a converter board and other devices are used between the evaluation MCU and the target system, the A-D converter operates differently from that of an actual MCU. Make the final evaluation of the A-D converter with an actual MCU.

# MEMO

# Chapter 4. Specifications

This chapter describes specifications of this product.

4.1 Specifications .....	38
4.2 Memory Map .....	39
4.3 Connection Diagram .....	40
4.4 Emulator External Dimensions .....	41

# Chapter 4. Specifications

## 4.1 Specifications

Table 4.1 lists specifications of the M306K9T2-CPE.

*Table 4.1 Specifications of the M306K9T2-CPE*

Applicable MCUs	M16C/6K Group M306K9	
Usable mode	Single-chip mode	
Evaluation MCU	M30622SAFP, M306K9F0LFP	
Emulation memory	For internal RAM area: 5 KB For internal ROM area: 128 KB	
Clock supply	Main clock ( $X_{IN}$ )	Internal oscillator circuit (OSC-3) Switchable to external oscillator input
	Sub clock ( $X_{CIN}$ )	Clock mounted on emulator (32.768 kHz) Switchable to external oscillator input
Maximum operating frequency	16 MHz at 3.3 V (divide-by-1, no-wait)	
Minimum operating frequency	32.768 kHz	
Applicable target power supply	With the target (JP1 = EXT)	3.0 to 3.6 V (supplied from pin Vcc of the target system)
	Without the target (JP1 = INT)	Fixed to 3.3 V (supplied from the emulator)
Basic debugging functions	<ul style="list-style-type: none"> <li>• Download, software break (max. 64 points)</li> <li>• Program execution/stop (allows free-run execution supporting software breaks)</li> <li>• Memory reference/setting (reference/setting C-variables, run-time execution)</li> <li>• Register reference/setting</li> <li>• Disassemble display</li> <li>• C-level debugging, etc.</li> </ul>	
Real-time trace function	<ul style="list-style-type: none"> <li>• 32K-cycle bus information recordable (Address: 20 bits, Data: 16 bits, MCU status: 12 bits)</li> <li>• 2 trace modes supported (Before Break mode/After Go mode)</li> </ul>	
Real-time RAM monitor function	1024 bytes	
Hardware break function	1 point (Address break, R/W break, 256 pass counts)	
Execution time measurement function	Time between program start to stop	
Operating temperature	5 to 35°C (no dew)	
Storage temperature	-10 to 60°C (no dew)	
Connection to target system	For M306K9: 144-pin 0.4-mm-pitch QFP (144PFB-A) converter board M3T-FLX-144NSE (option)	
Power supply for emulator	DC 5.0 V $\pm$ 5% (2 A) externally supplied (prepare the power supply separately)	
Host machine interface	USB (USB 1.1 full-speed, mini-B standard connector used)	



## 4.2 Memory Map

Figure 4.1 shows memory maps when using the emulator. For the memory map of the actual MCU, refer to the user's manual of your MCU.

Make note of the fact that the memory map of the actual MCU differ from that of the emulator. Do not access to the area noted "Do Not Access" in the memory map when using the emulator. Otherwise, the emulator may malfunction.

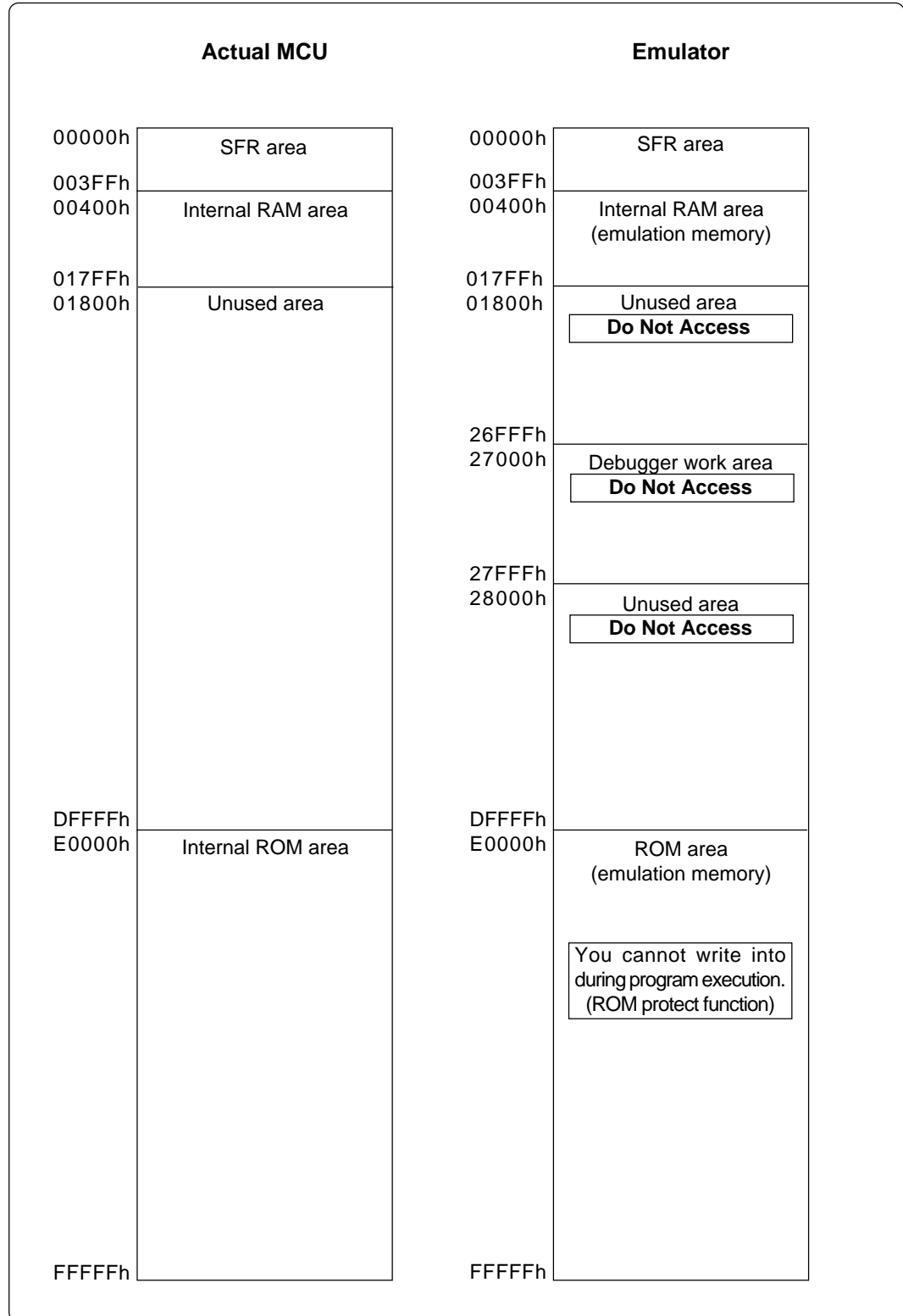

Figure 4.1 Memory map when using the emulator

### 4.3 Connection Diagram

Figure 4.2 shows the connection diagram of M306K9T2-CPE. This connection diagram mainly shows the interface section, and the circuits which are not connected to the target system such as the emulator's control system are omitted.

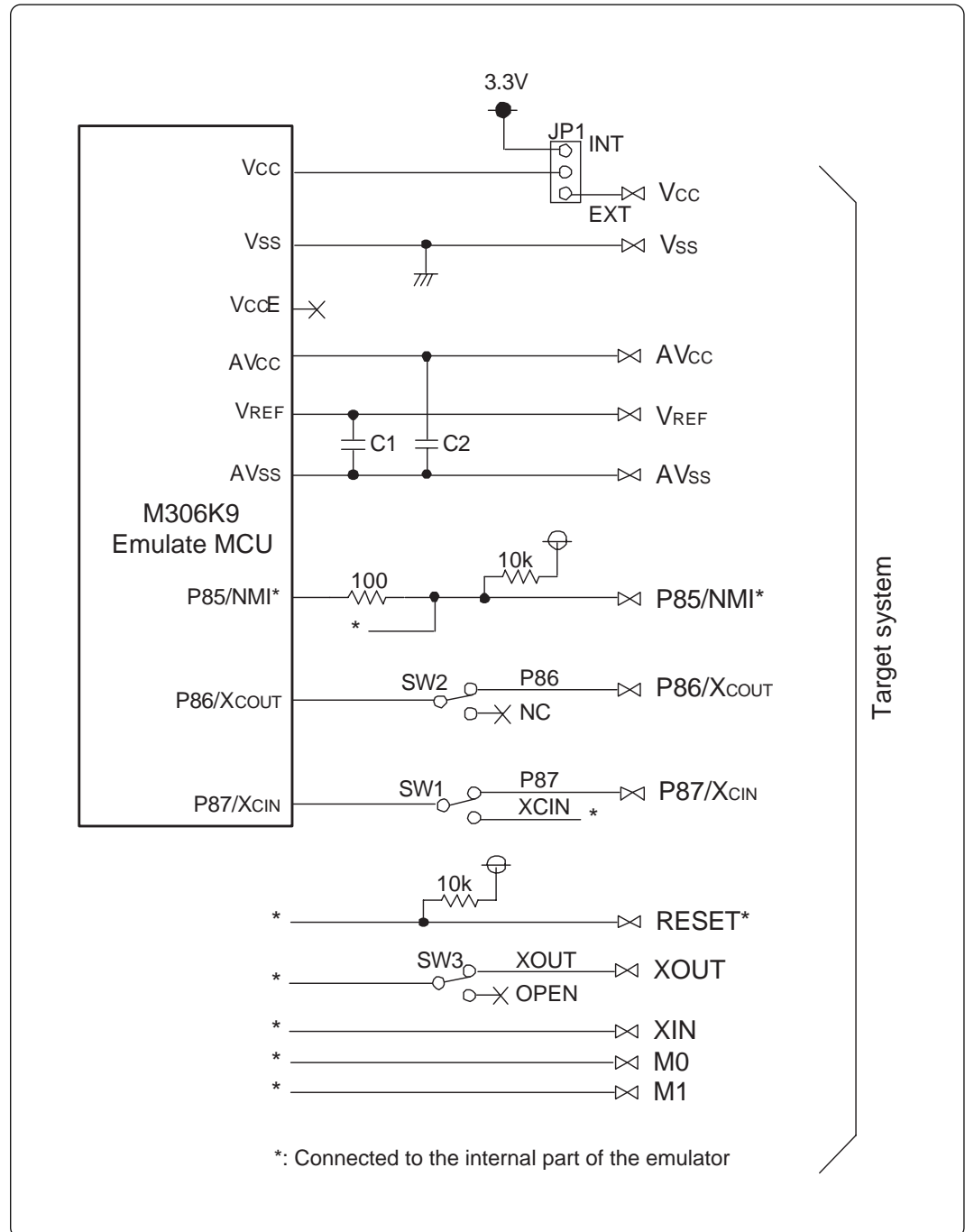

Figure 4.2 Connection diagram (emulation circuits)

## 4.4 Emulator External Dimensions

Figure 4.3 shows external dimensions of the emulator.

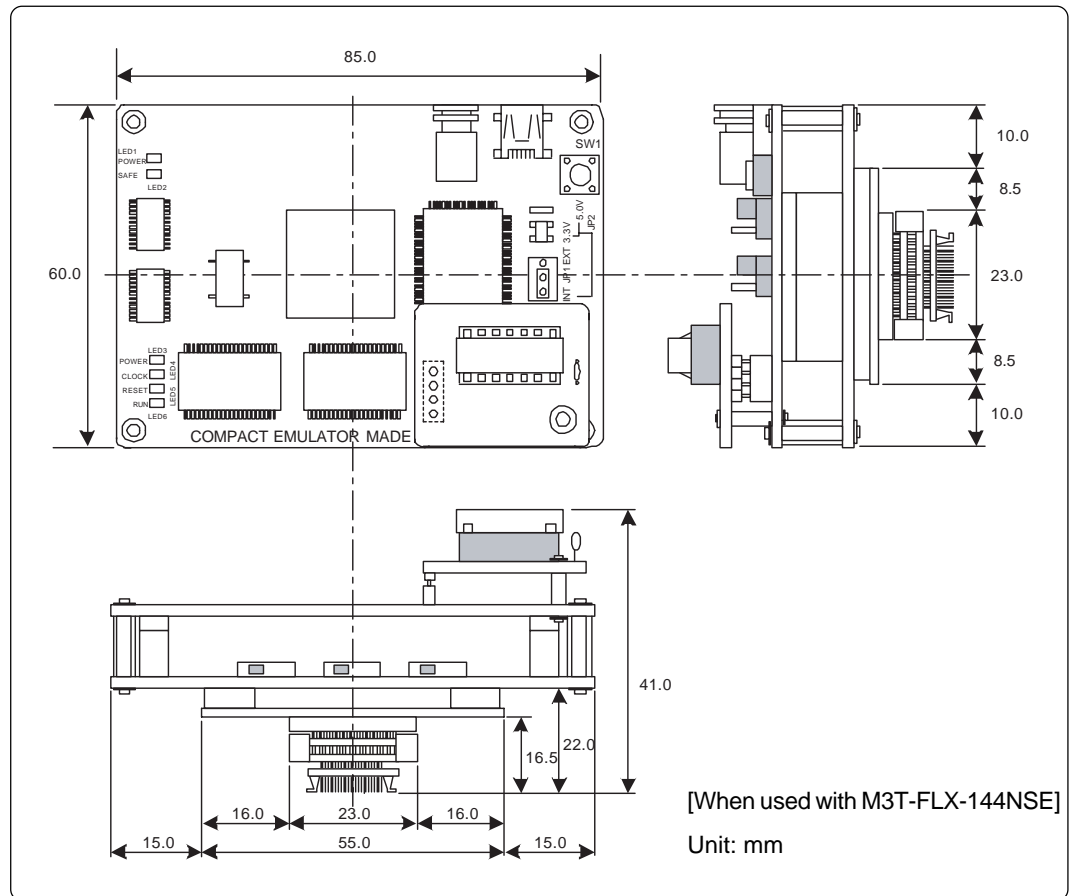

Figure 4.3 Emulator external dimensions

# MEMO

# Chapter 5. Troubleshooting

This chapter describes how to troubleshoot when this product does not work properly.

5.1 Troubleshooting Until the Emulator Starts Up .....	44
5.2 Troubleshooting When Using Emulator Debugger PD30M .....	47
5.3 If Emulator Operation is Abnormal .....	48
5.4 How to Request for Support .....	50

# Chapter 5. Troubleshooting

## 5.1 Troubleshooting Until the Emulator Starts Up

Figure 5.1 shows the flowchart to remedy the troubles from when power to the emulator is activated until the emulator debugger starts up.

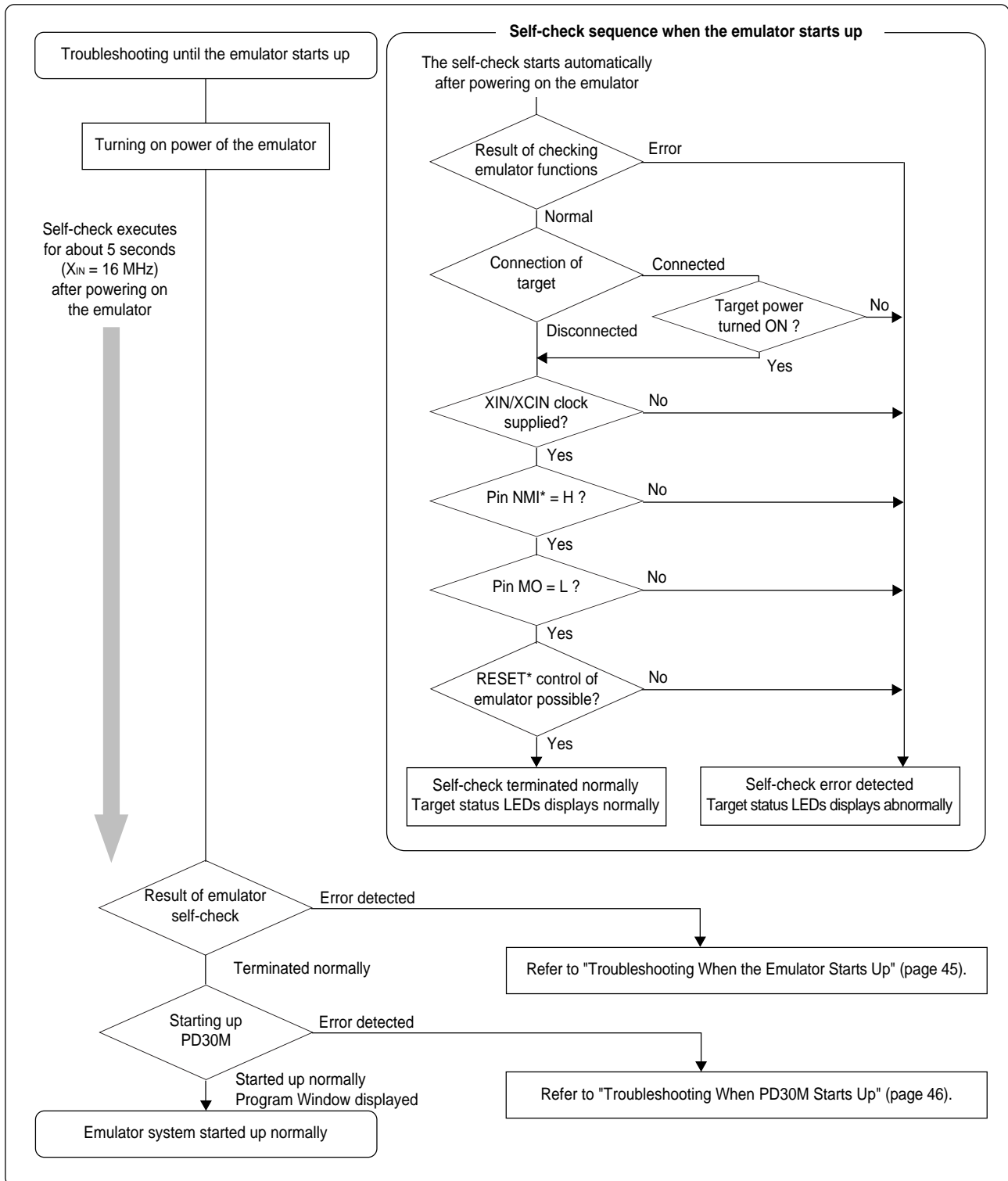

Figure 5.1 Flowchart to remedy the troubles

## (1) Troubleshooting When the Emulator Starts Up

Tables 5.1 and 5.2 list how to remedy the troubles when the target status LEDs of the emulator shows abnormal after powering on the emulator.

When an error is detected, shut off the emulator and the target system and follow the steps in Tables 5.1 and 5.2. Then, reboot the emulator and the target system.

Table 5.1 Error display and how to remedy it when starting up the emulator (1/2)

LED display				Connection to the target system	Problem & remedy
POWER	CLOCK	RESET	RUN		
■	■	■	■	-	The emulator system does not work properly. - If the SAFE LED is blinking, startup M3T-PD30M and download the firmware. - Check the supply to power to the emulator. - The emulator may be damaged. Contact your local distributor.
■	■	■	⏏	Connected	The target system is not powered. - Check that the MCU power supply source selection jumper J1 is set to EXT. - Check that the emulator is powered. - Check that the target system is powered.
■	■	■	■	Not connected	The emulator system does not work properly. - Check that the MCU power supply source selection jumper J1 is set to INT. - Check that the emulator is powered.
■	■	⏏	■	-	Clock is not supplied to the emulator. - Check that an oscillator circuit board (OSC-2 or OSC-3) is attached. - Check that an oscillator or oscillation module on an oscillator circuit board (OSC-2 or OSC-3) is operating properly.
■	■	⏏	⏏	Connected	The emulator does not start up properly because pin NMI* is held "L". - Check that pin NMI* is held High.
■	■	■	■	Not connected	The emulator system does not work properly. - The emulator may be damaged. Contact your local distributor.
■	⏏	■	⏏	Connected	The emulator does not start up properly because pin M0 is held "H". - This product is an emulator which operates only in single-chip mode. Check that pin M0 is held Low.
■	⏏	⏏	■	Not connected	The emulator system does not work properly. - The emulator may be damaged. Contact your local distributor.
■	⏏	⏏	■	Connected	The emulator does not start up properly because an internal clock of the MCU is not oscillating. - Check that the power voltage is within the range of MCU specifications. - The oscillation frequency of an oscillator circuit board (OSC-2 or OSC-3) is within the range of MCU specifications.
■	■	■	■	Not connected	The emulator system does not work properly. - The emulator may be damaged. Contact your local distributor.

Table 5.2 Error display and how to remedy it when starting up the emulator (2/2)

LED display				Connection to the target system	Problem & remedy
POWER	CLOCK	RESET	RUN		
■	⏏	⏏	⏏	-	The emulator system does not work properly. - The emulator may be damaged. Contact your local distributor.
⏏	■	■	■		
⏏	■	■	⏏		
⏏	■	⏏	■		

## (2) Troubleshooting When Emulator Debugger PD30M Starts Up

Table 5.3 lists error messages and how to remedy them when starting up PD30M.

Table 5.3 Error message and how to remedy it when starting up PD30M

Error message	Connection to the target system	Remedy
Communication ERROR. Can't accept data.	-	- Check that the emulator's target status LEDs. If they are blinking, the emulator has not started up properly. Check the settings explained in "(1) Troubleshooting When the Emulator Starts Up". - Check that the USB cable is connected properly.
Not compact emulator.	-	- Check that an emulator other than the compact emulator (such as PC4701, or PC7501) is not connected.
Target MCU is not given clock.	Connected	- If the Clock tab in the Init dialog box is set to External, check that an oscillator of the target system is operating properly.
	Not connected	- If the Clock tab in the Init dialog box is set to External, change it to Internal.
Target MCU is unable to reset.	Connected	- If the Clock tab in the Init dialog box is set to External, check that an oscillator of the target system is operating properly.
	Not connected	- If the Clock tab in the Init dialog box is set to External, change it to Internal.
Version of PD30M and the firmware on the target are not same.	-	Contact your local distributor.
Please download the firmware to target.	-	Contact your local distributor.



## 5.2 Troubleshooting When Using Emulator Debugger PD30M

When PD30M has started up normally, however, errors occurred while using it, remedy the troubles referring Table 5.4.

Table 5.4 Error message and how to remedy it when using PD30M

Error message	Connection to the target system	Remedy
Target MCU is not given clock.	Connected	- If the external clock supply is selected, check that the target system's oscillation circuit works properly. Also, if using the sub-clock, see "2.3 (2) Function Selection Switches" (page 21).
	Not connected	- If the external clock supply is selected, change it to internal supply. Also, if using the sub-clock, see "2.3 (2) Function Selection Switches" (page 21).
Target MCU is unable to reset.	Connected	- If the external clock supply is selected, check that the target system's oscillation circuit works properly. Also, if using the sub-clock, see "2.3 (2) Function Selection Switches" (page 21).
	Not connected	- If the external clock supply is selected, change it to internal supply. Also, if using the sub-clock, see "2.3 (2) Function Selection Switches" (page 21).
Target MCU is reset state.	Connected	- The target MCU has been reset. Cancel the reset of the MCU.
Target MCU is HOLD state.	Connected	- If the external clock supply is selected, check that the target system's oscillation circuit works properly. Also, if using the sub-clock, see "2.3 (2) Function Selection Switches" (page 21). - The MCU may be in stop or wait mode. Either reset the MCU or cancel the mode with an interrupt.
	Not connected	- If the external clock supply is selected, check that the target system's oscillation circuit works properly. Also, if using the sub-clock, see "2.3 (2) Function Selection Switches" (page 21). - The MCU may be in stop or wait mode. Either reset the MCU or cancel the mode with an interrupt.
Target MCU is not given power.	Connected	- Check that the power supply and GND are properly connected to the target system.

### 5.3 If Emulator Operation is Abnormal

The self-check is a function to check the memory etc. mounted in the emulator. The self-check is executed when the emulator starts up, and detailed check is executed by following the procedure below.

Set the switches as shown in Table 5.5 below to execute the self-check. Be sure to disconnect the target system.

Table 5.5 Switch settings for the self-check

Switch	Setting
MCU power supply source selection jumper (JP1)	INT
P87/XCIN selection switch (SW1)	P87
P86/OPEN selection switch (SW2)	P86
XOUT/OPEN selection switch (SW3)	OPEN

#### (1) Self-check Procedure in Self-check Mode

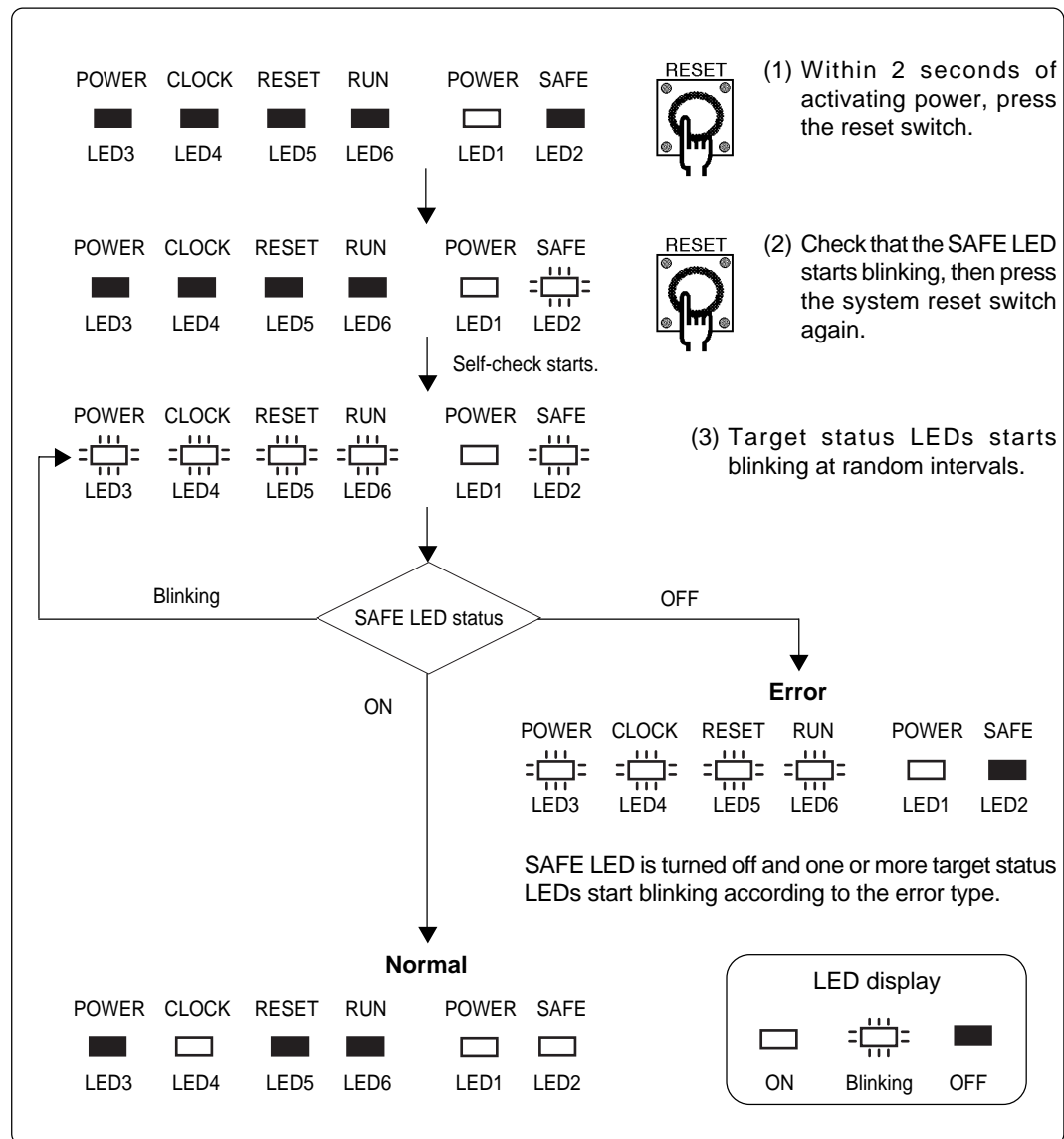

























































Figure 5.2 Self-check procedure

## (2) If an Error is Detected in the Self-check

Table 5.6 lists how to remedy the troubles if the target status LED display is abnormal in the self-check.

When an error is detected, shut off the emulator and the target system and follow the steps in the Table 5.6. Then, reactivate the power of the emulator and the target system.

Table 5.6 Error display in the self-check and how to remedy it

LED display				Problem & remedy
POWER	CLOCK	RESET	RUN	
 : Blinking  : OFF				The emulator system does not work properly. - Check that power is supplied to the emulator. - The emulator may be damaged. Contact your local distributor.
				
				A clock is not supplied to the emulator. - Check that the oscillator circuit board (OSC-3) is attached.
				The emulator system does not work properly. - The emulator may be damaged. Contact your local distributor.
				
				
				
				
				
				
				
				
				
				
				

## CAUTION

### Notes on the Self-check:

- Be sure to disconnect the target system before executing the self-check.
- If the self-check does not result normally, the emulator may be damaged. Then, contact your local distributor.
- Use the preinstalled oscillator circuit board OSC-3 (16 MHz) to execute the self-check.

## 5.4 How to Request for Support

After checking the items in "Chapter 5 Troubleshooting", fill in the text file the installer of the emulator debugger generates in the following directory and email to your local distributor.

\\SUPPORT\product name\SUPPORT.TXT

For prompt response, please specify the following information:

(1) Operating environment

- Operating voltage: X.X [V]
- Operating frequency: XX.X [MHz]
- Clock supply to the MCU: Internal oscillator/External oscillator
- Target system: Connected/Not connected

(2) Condition

- The emulator debugger starts up/does not start up
- The error is detected/not detected in the self-check
- Frequency of errors: always/frequency ( )

(3) Problem

# Chapter 6. Maintenance and Guarantee

This chapter describes how to maintenance, repair provisions and how to request for repair.

6.1 Maintenance .....	52
6.2 Guarantee .....	52
6.3 Repair Provisions.....	52
6.4 How to Request for Repair .....	53

# Chapter 6. Maintenance and Warranty

## 6.1 Maintenance

If dust or dirt collects on any equipment of your emulation system, wipe it off with a dry soft cloth. Do not use thinner or other solvents because these chemicals can cause the equipment's surface coating to separate.

## 6.2 Guarantee

If your product becomes faulty within twelve months after its purchase while being used under good conditions by observing "Precautions for Safety" described in Chapter 1 of this user's manual, we will repair or replace your faulty product free of charge. Note, however, that if your product's fault is raised by any one of the following causes, we will repair it or replace it with new one with extra-charge:

- Misuse, abuse, or use under extraordinary conditions
- Unauthorized repair, remodeling, maintenance, and so on
- Inadequate user's system or misuse of it
- Fires, earthquakes, and other unexpected disasters

In the above cases, contact your local distributor. If your product is being leased, consult the leasing company or the owner.

## 6.3 Repair Provisions

### (1) Repair with extra-charge

The products elapsed more than twelve months after purchase can be repaired with extra-charge.

### (2) Replacement with extra-charge

If your product's fault falls in any of the following categories, the fault will be corrected by replacing the entire product instead of repair, or you will be advised to purchase new one, depending on the severity of the fault.

- Faulty or broken mechanical portions
- Flaw, separation, or rust in coated or plated portions
- Flaw or cracks in plastic portions
- Faults or breakage caused by improper use or unauthorized repair or modification
- Heavily damaged electric circuits due to overvoltage, overcurrent or shorting of power supply
- Cracks in the printed circuit board or burnt-down patterns
- Wide range of faults that makes replacement less expensive than repair
- Unlocatable or unidentified faults

### (3) Expiration of the repair period

When a period of twelve months elapses after the model was dropped from production, repairing products of the model may become impossible.

### (4) Transportation fees at sending your product for repair

Please send your product to us for repair at your expense.

## 6.4 How to Request for Repair

If your product is found faulty, follow the procedure below to send your product for repair.

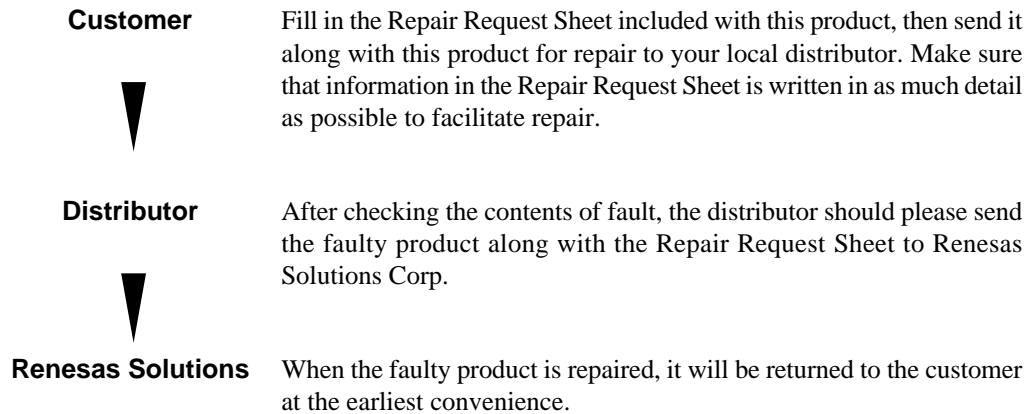

### CAUTION

#### Note on Transporting the Product:



- When sending your product for repair, use the packing box and cushion material supplied with this product when delivered to you and specify handling caution for it to be handled as precision equipment. If packing of your product is not complete, it may be damaged during transportation. When you pack your product in a bag, make sure to use conductive polyvinyl supplied with this product (usually a blue bag). When you use other bags, they may cause a trouble on your product because of static electricity.

# MEMO



# M306K9T2-CPE User's Manual

---

Rev. 1.00  
May 1, 2003  
REJ10J0042-0100Z

COPYRIGHT ©2003 RENESAS TECHNOLOGY CORPORATION  
AND RENESAS SOLUTIONS CORPORATION ALL RIGHTS RESERVED

**M306K9T2-CPE**  
**User's Manual**



**Renesas Electronics Corporation**

1753, Shimonumabe, Nakahara-ku, Kawasaki-shi, Kanagawa 211-8668 Japan

REJ10J0042-0100Z