

To our customers,

Old Company Name in Catalogs and Other Documents

On April 1st, 2010, NEC Electronics Corporation merged with Renesas Technology Corporation, and Renesas Electronics Corporation took over all the business of both companies. Therefore, although the old company name remains in this document, it is a valid Renesas Electronics document. We appreciate your understanding.

Renesas Electronics website: <http://www.renesas.com>

April 1st, 2010
Renesas Electronics Corporation

Issued by: Renesas Electronics Corporation (<http://www.renesas.com>)

Send any inquiries to <http://www.renesas.com/inquiry>.

Notice

1. All information included in this document is current as of the date this document is issued. Such information, however, is subject to change without any prior notice. Before purchasing or using any Renesas Electronics products listed herein, please confirm the latest product information with a Renesas Electronics sales office. Also, please pay regular and careful attention to additional and different information to be disclosed by Renesas Electronics such as that disclosed through our website.
2. Renesas Electronics does not assume any liability for infringement of patents, copyrights, or other intellectual property rights of third parties by or arising from the use of Renesas Electronics products or technical information described in this document. No license, express, implied or otherwise, is granted hereby under any patents, copyrights or other intellectual property rights of Renesas Electronics or others.
3. You should not alter, modify, copy, or otherwise misappropriate any Renesas Electronics product, whether in whole or in part.
4. Descriptions of circuits, software and other related information in this document are provided only to illustrate the operation of semiconductor products and application examples. You are fully responsible for the incorporation of these circuits, software, and information in the design of your equipment. Renesas Electronics assumes no responsibility for any losses incurred by you or third parties arising from the use of these circuits, software, or information.
5. When exporting the products or technology described in this document, you should comply with the applicable export control laws and regulations and follow the procedures required by such laws and regulations. You should not use Renesas Electronics products or the technology described in this document for any purpose relating to military applications or use by the military, including but not limited to the development of weapons of mass destruction. Renesas Electronics products and technology may not be used for or incorporated into any products or systems whose manufacture, use, or sale is prohibited under any applicable domestic or foreign laws or regulations.
6. Renesas Electronics has used reasonable care in preparing the information included in this document, but Renesas Electronics does not warrant that such information is error free. Renesas Electronics assumes no liability whatsoever for any damages incurred by you resulting from errors in or omissions from the information included herein.
7. Renesas Electronics products are classified according to the following three quality grades: "Standard", "High Quality", and "Specific". The recommended applications for each Renesas Electronics product depends on the product's quality grade, as indicated below. You must check the quality grade of each Renesas Electronics product before using it in a particular application. You may not use any Renesas Electronics product for any application categorized as "Specific" without the prior written consent of Renesas Electronics. Further, you may not use any Renesas Electronics product for any application for which it is not intended without the prior written consent of Renesas Electronics. Renesas Electronics shall not be in any way liable for any damages or losses incurred by you or third parties arising from the use of any Renesas Electronics product for an application categorized as "Specific" or for which the product is not intended where you have failed to obtain the prior written consent of Renesas Electronics. The quality grade of each Renesas Electronics product is "Standard" unless otherwise expressly specified in a Renesas Electronics data sheets or data books, etc.

"Standard": Computers; office equipment; communications equipment; test and measurement equipment; audio and visual equipment; home electronic appliances; machine tools; personal electronic equipment; and industrial robots.

"High Quality": Transportation equipment (automobiles, trains, ships, etc.); traffic control systems; anti-disaster systems; anti-crime systems; safety equipment; and medical equipment not specifically designed for life support.

"Specific": Aircraft; aerospace equipment; submersible repeaters; nuclear reactor control systems; medical equipment or systems for life support (e.g. artificial life support devices or systems), surgical implantations, or healthcare intervention (e.g. excision, etc.), and any other applications or purposes that pose a direct threat to human life.
8. You should use the Renesas Electronics products described in this document within the range specified by Renesas Electronics, especially with respect to the maximum rating, operating supply voltage range, movement power voltage range, heat radiation characteristics, installation and other product characteristics. Renesas Electronics shall have no liability for malfunctions or damages arising out of the use of Renesas Electronics products beyond such specified ranges.
9. Although Renesas Electronics endeavors to improve the quality and reliability of its products, semiconductor products have specific characteristics such as the occurrence of failure at a certain rate and malfunctions under certain use conditions. Further, Renesas Electronics products are not subject to radiation resistance design. Please be sure to implement safety measures to guard them against the possibility of physical injury, and injury or damage caused by fire in the event of the failure of a Renesas Electronics product, such as safety design for hardware and software including but not limited to redundancy, fire control and malfunction prevention, appropriate treatment for aging degradation or any other appropriate measures. Because the evaluation of microcomputer software alone is very difficult, please evaluate the safety of the final products or system manufactured by you.
10. Please contact a Renesas Electronics sales office for details as to environmental matters such as the environmental compatibility of each Renesas Electronics product. Please use Renesas Electronics products in compliance with all applicable laws and regulations that regulate the inclusion or use of controlled substances, including without limitation, the EU RoHS Directive. Renesas Electronics assumes no liability for damages or losses occurring as a result of your noncompliance with applicable laws and regulations.
11. This document may not be reproduced or duplicated, in any form, in whole or in part, without prior written consent of Renesas Electronics.
12. Please contact a Renesas Electronics sales office if you have any questions regarding the information contained in this document or Renesas Electronics products, or if you have any other inquiries.

(Note 1) "Renesas Electronics" as used in this document means Renesas Electronics Corporation and also includes its majority-owned subsidiaries.

(Note 2) "Renesas Electronics product(s)" means any product developed or manufactured by or for Renesas Electronics.

H8S, H8SX Family E10A-USB Emulator

Additional Document for User's Manual
Supplementary Information on Using
the H8SX/1655F and H8SX/1652F

Renesas Microcomputer Development
Environment System

H8SX Family / H8SX/1600 Series

E10A-USB for H8SX/1655F HS1655KCU01HE

Notes regarding these materials

1. This document is provided for reference purposes only so that Renesas customers may select the appropriate Renesas products for their use. Renesas neither makes warranties or representations with respect to the accuracy or completeness of the information contained in this document nor grants any license to any intellectual property rights or any other rights of Renesas or any third party with respect to the information in this document.
2. Renesas shall have no liability for damages or infringement of any intellectual property or other rights arising out of the use of any information in this document, including, but not limited to, product data, diagrams, charts, programs, algorithms, and application circuit examples.
3. You should not use the products or the technology described in this document for the purpose of military applications such as the development of weapons of mass destruction or for the purpose of any other military use. When exporting the products or technology described herein, you should follow the applicable export control laws and regulations, and procedures required by such laws and regulations.
4. All information included in this document such as product data, diagrams, charts, programs, algorithms, and application circuit examples, is current as of the date this document is issued. Such information, however, is subject to change without any prior notice. Before purchasing or using any Renesas products listed in this document, please confirm the latest product information with a Renesas sales office. Also, please pay regular and careful attention to additional and different information to be disclosed by Renesas such as that disclosed through our website. (<http://www.renesas.com>)
5. Renesas has used reasonable care in compiling the information included in this document, but Renesas assumes no liability whatsoever for any damages incurred as a result of errors or omissions in the information included in this document.
6. When using or otherwise relying on the information in this document, you should evaluate the information in light of the total system before deciding about the applicability of such information to the intended application. Renesas makes no representations, warranties or guaranties regarding the suitability of its products for any particular application and specifically disclaims any liability arising out of the application and use of the information in this document or Renesas products.
7. With the exception of products specified by Renesas as suitable for automobile applications, Renesas products are not designed, manufactured or tested for applications or otherwise in systems the failure or malfunction of which may cause a direct threat to human life or create a risk of human injury or which require especially high quality and reliability such as safety systems, or equipment or systems for transportation and traffic, healthcare, combustion control, aerospace and aeronautics, nuclear power, or undersea communication transmission. If you are considering the use of our products for such purposes, please contact a Renesas sales office beforehand. Renesas shall have no liability for damages arising out of the uses set forth above.
8. Notwithstanding the preceding paragraph, you should not use Renesas products for the purposes listed below:
 - (1) artificial life support devices or systems
 - (2) surgical implantations
 - (3) healthcare intervention (e.g., excision, administration of medication, etc.)
 - (4) any other purposes that pose a direct threat to human lifeRenesas shall have no liability for damages arising out of the uses set forth in the above and purchasers who elect to use Renesas products in any of the foregoing applications shall indemnify and hold harmless Renesas Technology Corp., its affiliated companies and their officers, directors, and employees against any and all damages arising out of such applications.
9. You should use the products described herein within the range specified by Renesas, especially with respect to the maximum rating, operating supply voltage range, movement power voltage range, heat radiation characteristics, installation and other product characteristics. Renesas shall have no liability for malfunctions or damages arising out of the use of Renesas products beyond such specified ranges.
10. Although Renesas endeavors to improve the quality and reliability of its products, IC products have specific characteristics such as the occurrence of failure at a certain rate and malfunctions under certain use conditions. Please be sure to implement safety measures to guard against the possibility of physical injury, and injury or damage caused by fire in the event of the failure of a Renesas product, such as safety design for hardware and software including but not limited to redundancy, fire control and malfunction prevention, appropriate treatment for aging degradation or any other applicable measures. Among others, since the evaluation of microcomputer software alone is very difficult, please evaluate the safety of the final products or system manufactured by you.
11. In case Renesas products listed in this document are detached from the products to which the Renesas products are attached or affixed, the risk of accident such as swallowing by infants and small children is very high. You should implement safety measures so that Renesas products may not be easily detached from your products. Renesas shall have no liability for damages arising out of such detachment.
12. This document may not be reproduced or duplicated, in any form, in whole or in part, without prior written approval from Renesas.
13. Please contact a Renesas sales office if you have any questions regarding the information contained in this document, Renesas semiconductor products, or if you have any other inquiries.

Contents



Section 1	Connecting the Emulator with the User System	1
1.1	Components of the E10A-USB Emulator	1
1.2	Connecting the E10A-USB Emulator with the User System	3
1.3	Pin Assignments of the E10A-USB Connector.....	5
1.4	Example of Emulator Connection.....	6
Section 2	Specification of the Emulator's Software	9
2.1	Differences between the H8SX/1655F, H8SX/1652F, and the Emulator	9
2.2	The H8SX/1655F E10A-USB Emulator Specific Functions and Notes	12
2.2.1	Emulator Driver Selection	12
2.2.2	Hardware Break Functions	13
2.2.3	Notes on Setting the [Breakpoint] Dialog Box	15
2.2.4	Sequential Break Function.....	16
2.2.5	Note on Using the JTAG Clock (TCK)	16
2.2.6	Trace Function.....	16
2.2.7	Parallel Transfer.....	17
2.2.8	Debugging in the External Flash Memory	20
2.2.9	Performance Analysis	26

Section 1 Connecting the Emulator with the User System

1.1 Components of the E10A-USB Emulator

The H8SX/1655F E10A-USB emulator supports the H8SX/1655F and H8SX/1652F (hereafter referred to as the MCU unless the description is specific to any of them). Table 1.1 lists the components of the E10A-USB emulator.

Table 1.1 Components of the Emulator

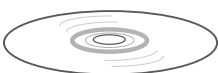
Classification	Component	Appearance	Quantity	Remarks
Hardware	Emulator box		1	HS0005KCU01H: Depth: 65.0 mm, Width: 97.0 mm, Height: 20.0 mm, Mass: 72.9 g or HS0005KCU02H ¹ : Depth: 65.0 mm, Width: 97.0 mm, Height: 20.0 mm, Mass: 73.7 g
	User system interface cable		1	14-pin type: Length: 20 cm, Mass: 33.1 g
	USB cable		1	Length: 150 cm, Mass: 50.6 g
Software	H8SX/1655F E10A-USB emulator setup program, H8S, H8SX Family E10A-USB Emulator User's Manual, Supplementary Information on Using the H8SX/1655F and H8SX/1652F ² , and Test program manual for HS0005KCU01H and HS0005KCU02H		1	HS0005KCU01SR, HS0005KCU01HJ-H8S, HS0005KCU01HE-H8S, HS1655KCU01HJ, HS1655KCU01HE, HS0005TM01HJ, and HS0005TM01HE (provided on a CD-R)

- Notes: 1. When HS0005KCU02H is purchased, the 36-pin type cable is provided; however, it is not available for this MCU.
2. Additional document for the MCUs supported by the emulator is included. Check the target MCU and refer to its additional document.

1.2 Connecting the E10A-USB Emulator with the User System

Before connecting an E10A-USB emulator (hereafter referred to as the emulator) with the user system, a connector must be installed in the user system so that a user system interface cable can be connected. When designing the user system, refer to the connector and recommended circuits shown in this manual.

Before designing the user system, be sure to read the H8S, H8SX Family E10A-USB Emulator User's Manual and the hardware manual for related MCUs.

Connect pins 8, 9, 10, 12, 13, and 14 of the user system connector to GND firmly on the PCB. These pins are used as electrical GND and to monitor the connection of the user system connector. Note the pin assignments of the user system connector.

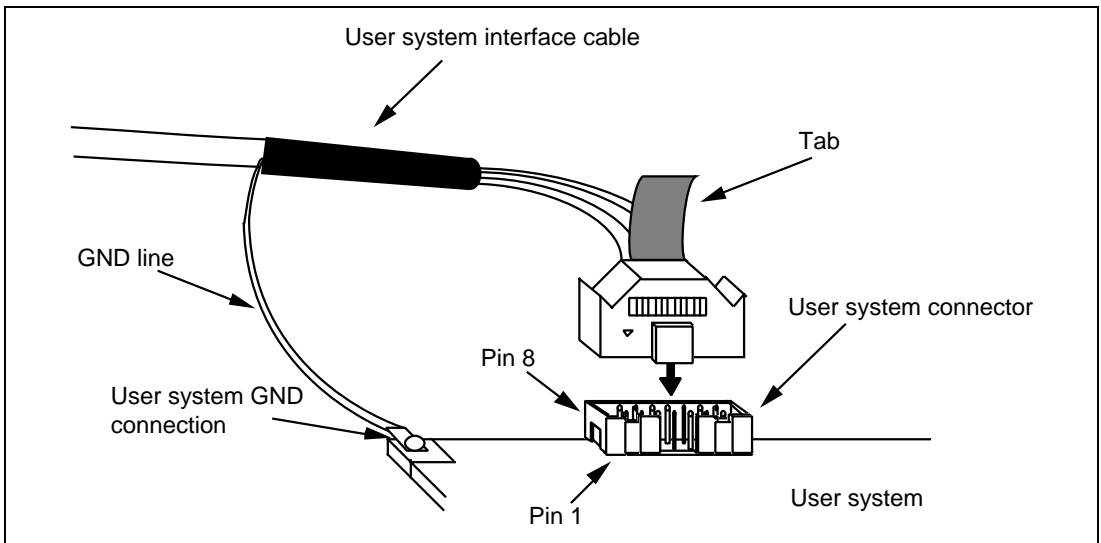

Figure 1.1 Connecting the User System Interface Cable to the User System

- Notes:
1. The pin number assignments of the 14-pin connector differ from those of the E8 emulator; however, the physical location is the same.
 2. Do not place any components within 3 mm of the connector.



WARNING

Be sure to place the GND line of the user system interface cable on the GND of the user system with a screw, etc. Failure to do so will result in a FIRE HAZARD due to an overcurrent and will damage the user system, the emulator product, and the host computer.

1.3 Pin Assignments of the E10A-USB Connector

Figure 1.2 shows the pin assignments of the user system connector.

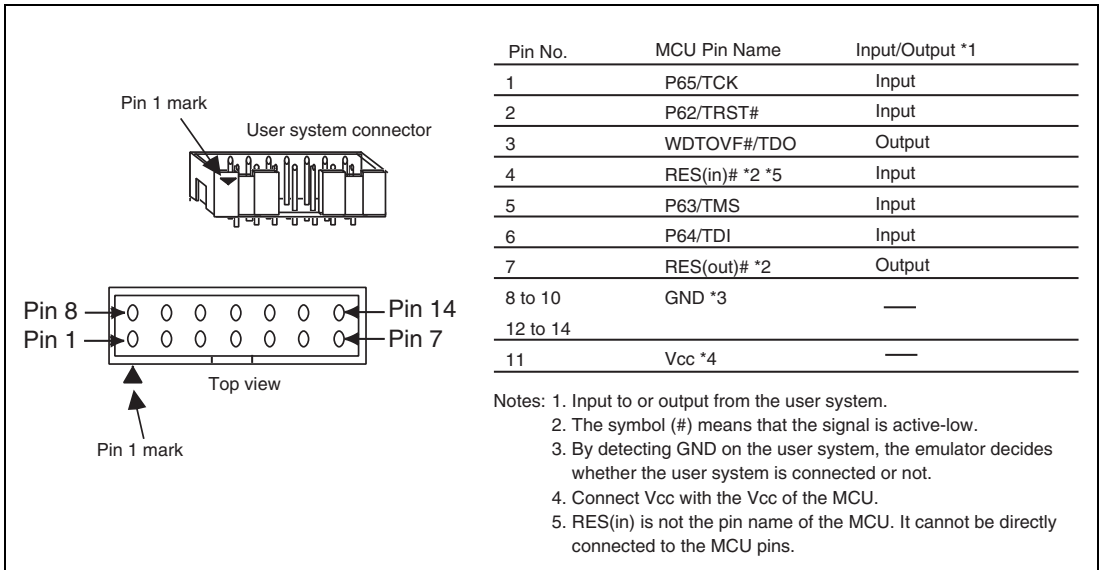

Figure 1.2 Pin Assignments of the User System Connector

1.4 Example of Emulator Connection

The figure shown below is an example of connecting the user system to the emulator.

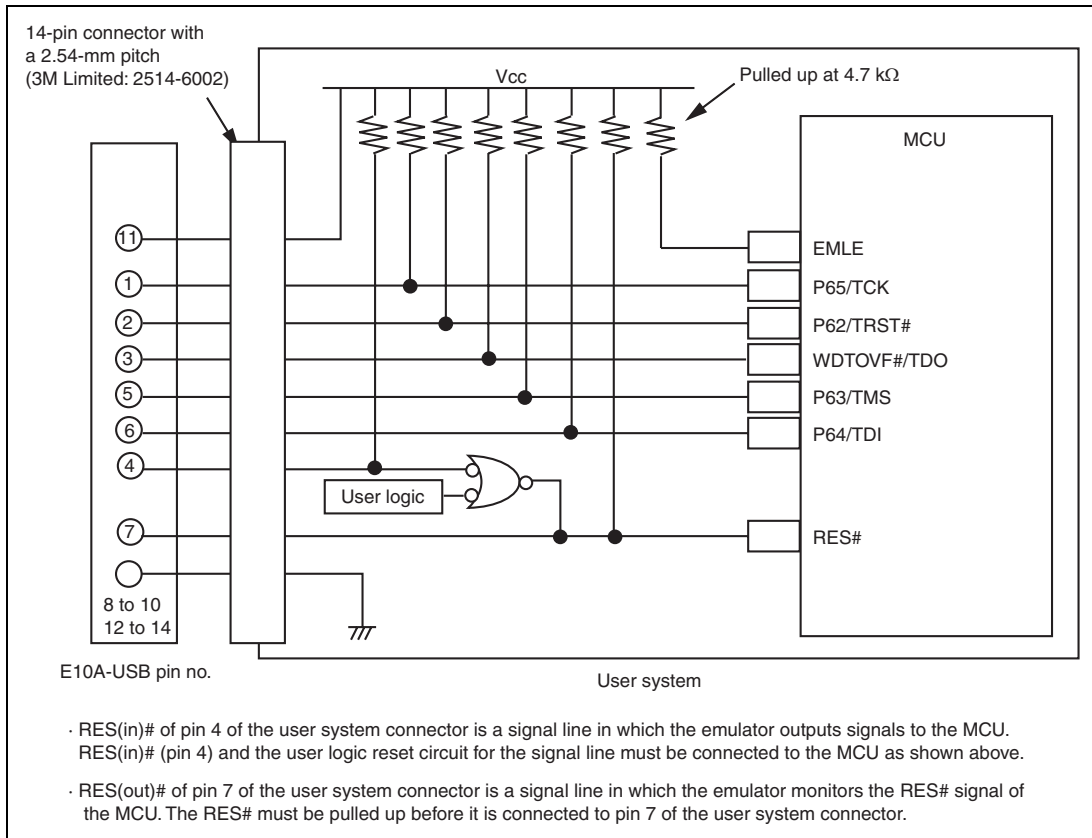

Figure 1.3 Example of Emulator Connection

Notes: 1. P62/TRST#, P65/TCK, P63/TMS, WDTOVF#/TDO, and P64/TDI are used by the emulator. Pull up and connect the emulator and the MCU pins.

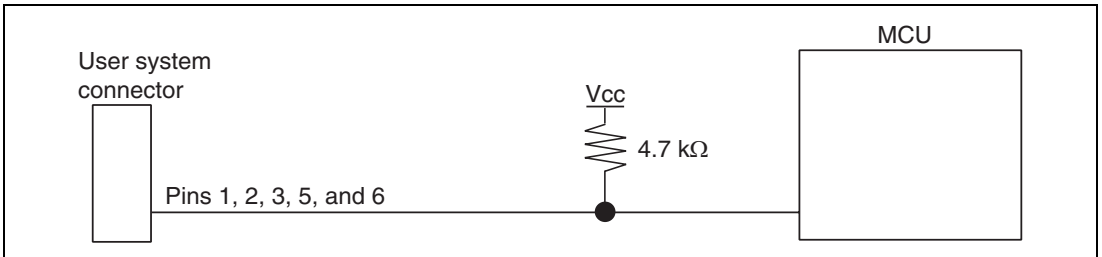

Figure 1.4 Connection of Emulator and MCU

2. If the emulator is connected to the user system, pull up pin EMLE of the MCU, and when the emulator is not connected to the user system, ground the EMLE.

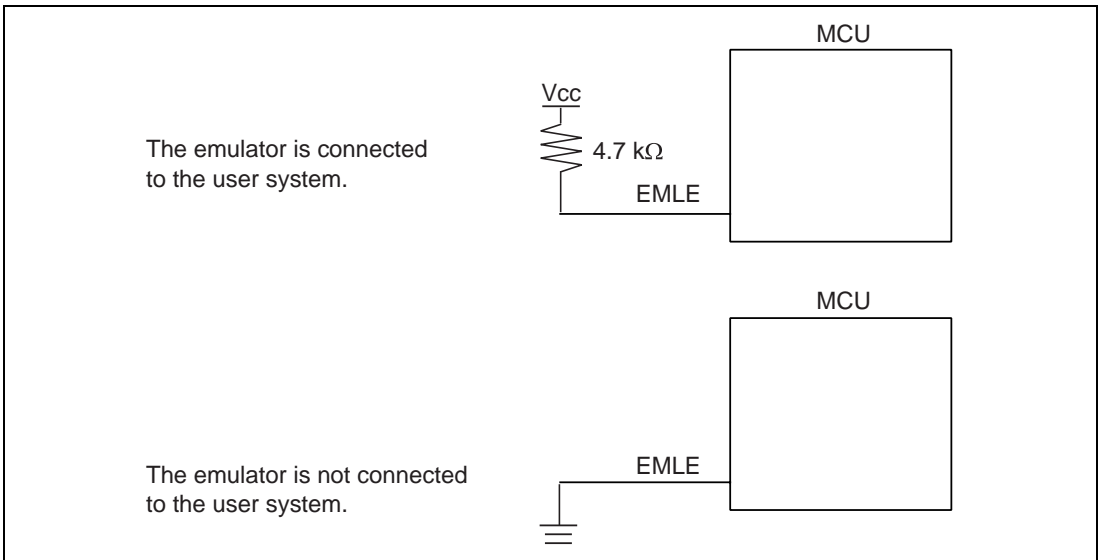

Figure 1.5 Emulator and Pin EMLE

- RES(in)# of pin 4 of the user system connector is a signal line in which the emulator outputs signals to the MCU. RES(in)# of pin 4 and the user logic reset circuit for the signal line must be connected to pin RES# of the MCU as shown in figure 1.6. RES(out)# of pin 7 of the user system connector is a signal line in which the emulator monitors pin RES# of the MCU. The RES# must be pulled up before it is connected to pin 7 of the user system connector.

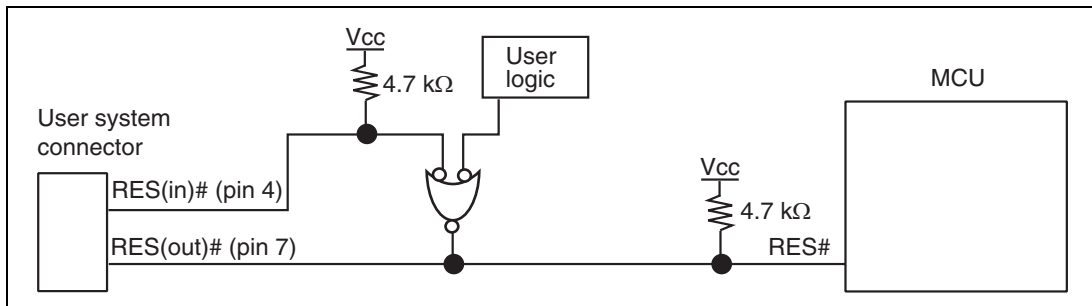

Figure 1.6 Connection of Pin RES#

- Ground pins 8, 9, 10, 12, 13, and 14 of the user system connector.
- Pin 11 of the user system connector must be connected to the user system Vcc (power supply). The amount of voltage permitted to input to the user system connector must be within the guaranteed range of the MCU.
- When the MCU in use is connected to the emulator, the pin functions listed below are not available.

Table 1.2 Pin Functions Not Available

H8SX/1655F and H8SX/1652F

WDTOVF# and P62 to P65

TMO3, TMCI3, TMRI3, and TMO2

IRQ10-B#, IRQ11-B#

DACK2#, DREQ3#, TEND3#, DACK3#

EDACK0-B#, EDREQ1-B#, ETEND1-B#, EDACK1-B#

SCK4

- The symbol (#) means that the signal is active-low.

Section 2 Specification of the Emulator's Software

2.1 Differences between the H8SX/1655F, H8SX/1652F, and the Emulator

1. When the emulator system is initiated, it initializes the general registers and part of the control registers as shown in table 2.1. The initial value of the MCU is undefined. When the emulator is initiated from the workspace, a value to be entered is saved in a session.

For the registers shown in table 2.1, values other than PC or CCR are not changed even if the CPU reset command is issued. If ER7 (SP) is changed as an odd value, it must be modified in the [Register] window.

Table 2.1 Register Initial Values at Emulator Power-On

Register	Initial Value
PC	Reset vector value in the vector address table
ER0 to ER6	H'0
ER7 (SP)	H'10
CCR	1 for I mask, and others undefined
EXR	H'7F
VBR	H'0
SBR	H'FFFFFF00
MACH	H'0
MACL	H'0

2. System Control Register

In the emulator, the internal I/O registers can be accessed from the [IO] window. However, be careful when accessing the system control register. The emulator saves the register value of the system control register at a break and returns the value when the user program is executed. Since this is done during a break, do not rewrite the system control register in the [IO] window.

3. Memory Access during Emulation

If the memory contents are referenced or modified during emulation, realtime emulation cannot be performed because the user program is temporarily halted.

4. The emulator communicates with the MCU by using the P34/TRST#, P37/TCK, P35/TMS, P63/TDO, and P36/TDI pins. These pins cannot be used.

5. The power consumed by the MCU can reach several mA. This is because the user power supply drives ICs to make the communication signal level match the user-system power-supply voltage.
6. Do not use an MCU that has been used for debugging.
If the flash memory is reprogrammed many times, and the MCU is left for a few days, data may be lost due to retention problems.
If the flash memory is reprogrammed many times, the data will not be erased. If an error message is displayed, exchange the MCU for a new one.
7. MCU Operating Mode
Use the emulator in mode 6 (on-chip ROM enabled extended mode) or mode 7 (single-chip initiation mode).
8. Sum Data Displayed in the Program Flash Mode
Sum data, which is displayed in the 'Program Flash' mode, is a value that data in the whole internal ROM areas has been added by bytes.
9. Note on Executing the User Program
The set value is rewritten since the emulator uses flash memory and watchdog timer registers during programming (Go, Step In, Step Out, or Step Over) of the flash memory.
10. Note on Reprogramming the Flash Memory
While the flash memory is reprogrammed during Go operation, actual reprogramming will not be performed if the flash memory is reprogrammed on the [Memory] window. Therefore, the contents will not be displayed correctly on the [Memory] window.
11. Value Set in the [System Clock] Dialog Box when Connecting the Emulator
Input the frequency of the oscillator in use in the [System Clock] dialog box (this also applies when the MCU is multiplied by the PLL circuit). Select the state of the MD_CLK pin of the user system. Do not switch the level on MD_CLK after connection with the emulator.

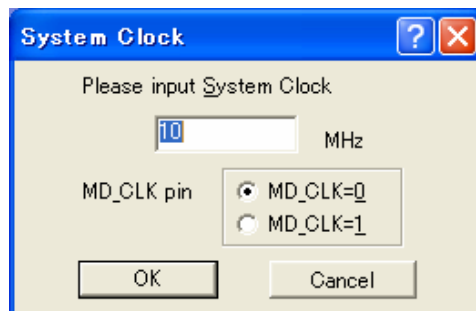

Figure 2.1 [System Clock] Dialog Box

12. Emulation on Programming or Erasing the Internal Flash Memory

A break cannot be generated while the program for programming or erasing the internal flash memory is being called. Note that the following processing also cannot be performed:

- Execution of the [STOP] button
- Auto-update of the watch function and use of the tool-chip watch function
- Memory operation during executing emulation

13. Deep Software Standby Mode and Software Standby Mode

The MCU cannot be accessed by the emulator in deep software standby mode and software standby mode. The emulator prohibits the following operation:

- Execution of the [STOP] button
- Memory access (H'FF is displayed in the [Memory] or [IO] window.)

14. Initialization of I/O registers by the [CPU Reset] function

The internal I/O registers listed below are not initiated by the [CPU Reset] item of the [Debugging] menu or the RESET command. Make sure that the user program handles initialization.

Table 2.2 Non-Initialized Registers

Device	Registers
H8SX/1655F and H8SX/1652F	DPSBYCR, DPSWCR, DPSIER, DPSIFR, DPSBKRn, RSTSR

2.2 The H8SX/1655F E10A-USB Emulator Specific Functions and Notes

- Notes:
1. Do not use an MCU that has been used for debugging.
 2. If the flash memory is reprogrammed many times, and the emulator is left for a few days, data may be lost due to retention problems.
 3. If the flash memory is reprogrammed many times, the data will not be erased. If an error message is displayed, exchange the MCU for a new one.

2.2.1 Emulator Driver Selection

Table 2.3 shows drivers which can be selected in the [Driver Details] dialog box.

Table 2.3 Type Name and Driver

Type Name	Driver
HS0005KCU01H, HS0005KCU02H	Renesas E-Series USB Driver

2.2.2 Hardware Break Functions

Hardware Break Conditions: In the H8SX/1655F E10A-USB emulator, conditions of Break condition 1,2,3,4 can be set. Table 2.4 lists the items that can be specified.

Table 2.4 Hardware Break Condition Specification Items

Items	Description
Address bus condition	Breaks when the MCU address bus value matches the specified value. It is possible to select whether a break is generated before or after prefetched address execution. When [User mask] is selected, a value to be masked "*" can be set. For masked bits, the condition is satisfied for any values.
Data bus condition	Breaks when the MCU data bus value matches the specified value. Byte, word, or longword can be specified as the access data size. When [User mask] is selected, a value to be masked "*" can be set. For masked bits, the condition is satisfied for any values.
Bus master condition	Breaks when the values of DATA, DTC, and DMA cycles match the specified values.
Read or write condition	Breaks in the read or write cycle.
Execution count condition	The condition specified with Break condition 1 breaks after the execution count condition specified here has been satisfied.

Table 2.5 lists the combinations of conditions that can be set in the [Break condition] dialog box.

Table 2.5 Conditions Set in [Break condition] Dialog Box

Dialog Box	Condition				Execution Count Condition
	Address Bus Condition	Data Condition	Bus Master Condition	Read or Write Condition	
[Break condition 1]	<input type="radio"/>	<input type="radio"/>	<input type="radio"/>	<input type="radio"/>	<input type="radio"/>
[Break condition 2]	<input type="radio"/>	<input checked="" type="radio"/>	<input type="radio"/>	<input type="radio"/>	<input checked="" type="radio"/>
[Break condition 3]	<input type="radio"/>	<input checked="" type="radio"/>	<input type="radio"/>	<input type="radio"/>	<input checked="" type="radio"/>
[Break condition 4]	<input type="radio"/>	<input checked="" type="radio"/>	<input type="radio"/>	<input type="radio"/>	<input checked="" type="radio"/>

Note: : Can be set by checking the radio button in the dialog box.

Table 2.6 lists the combinations of conditions that can be set by the BREAKCONDITION_SET command.

Table 2.6 Conditions Set by BREAKCONDITION_SET Command

Channel	Condition				Execution Count Condition (option <countopt>)
	Address Bus Condition (option <addropt>)	Data Condition (option <dataopt>)	Bus Master Condition (option <accessopt>)	Read or Write Condition (option <r/wopt>)	
Break condition 1	<input type="radio"/>	<input type="radio"/>	<input type="radio"/>	<input type="radio"/>	<input type="radio"/>
Break condition 2	<input type="radio"/>	<input checked="" type="radio"/>	<input type="radio"/>	<input type="radio"/>	<input checked="" type="radio"/>
Break condition 3	<input type="radio"/>	<input checked="" type="radio"/>	<input type="radio"/>	<input type="radio"/>	<input checked="" type="radio"/>
Break condition 4	<input type="radio"/>	<input checked="" type="radio"/>	<input type="radio"/>	<input type="radio"/>	<input checked="" type="radio"/>

Note: : Can be set by the BREAKCONDITION_SET command.

Notes on Setting the Break Condition:

1. When [Step In], [Step Over], or [Step Out] is selected, the settings of Break condition are disabled.
2. The settings of Break condition are disabled when an instruction to which a BREAKPOINT has been set is executed.
3. When step over function is used, the settings of BREAKPOINT and Break condition are disabled.
4. When [Go To Cursor] is selected, the settings of Break condition channel 4 are disabled.

2.2.3 Notes on Setting the [Breakpoint] Dialog Box

1. When an odd address is set, the address is rounded down to an even address.
2. A BREAKPOINT is accomplished by replacing instructions. Accordingly, it can be set only to the flash memory or the RAM area. However, a BREAKPOINT cannot be set to the following addresses:
 - An area other than flash memory or RAM
 - An area occupied by the emulator program
3. During step execution, a BREAKPOINT is disabled.
4. A condition set at Break condition is disabled immediately after starting execution when an instruction at a BREAKPOINT is executed. A break does not occur even if a condition of Break condition is satisfied immediately after starting the execution.
5. When execution resumes from the breakpoint address after the program execution stops at the BREAKPOINT, single-step execution is performed at the address before execution resumes. Therefore, realtime operation cannot be performed.
6. Settings of BREAKPOINT and Break condition are invalid while the STEP OVER function is being used.
7. When a BREAKPOINT is set in the external flash memory area, the emulator executes the programs for initializing, programming, and erasing the flash memory (hereafter referred to as an initialization module, a write module, and an erase module, respectively*) to reprogram the external flash memory. Accordingly, the operation of the user program will differ when it is reexecuted after a break occurs.

Note: Prepare initialization, write, and erase modules that are suitable for the external flash memory being used.

2.2.4 Sequential Break Function

The user program is halted when conditions of the Break condition for channels 2 to 4 are matched. This function can be set in the [Emulation mode] drop-down list box of the [Configuration] dialog box.

Table 2.7 Sequential Break condition Specification Items

Items	Description
Sequential Break condition 2-1	Halts a program when a condition is satisfied in the order of Break condition 2, 1. Break condition 1, 2 must be set.
Sequential Break condition 3-2-1	Halts a program when a condition is satisfied in the order of Break condition 3, 2, 1. Break condition 1, 2, 3 must be set.
Sequential Break condition 4-3-2-1	Halts a program when a condition is satisfied in the order of Break condition 4, 3, 2, 1. Break condition 1, 2, 3, 4 must be set.

Note: When Sequential Break condition 4-3-2-1 is set, [Go To Cursor] is not available.

2.2.5 Note on Using the JTAG Clock (TCK)

When the JTAG clock (TCK) is used, set the frequency to lower than that of the system clock. The value of the JTAG clock (TCK) becomes the initial TCK value that has been set at the starting up of the emulator, after [Reset CPU] or [Reset Go] is executed*.

Note: The value of the JTAG clock (TCK) that has been set at the starting up of the emulator is appropriately calculated on the basis of the value entered in the [System clock] dialog box.

2.2.6 Trace Function

The emulator uses the eight-branch-instruction trace function in the MCU, and acquires a trace by operating the user program in realtime. The branch-instruction trace function displays the branch-source address, the mnemonic, and the operand.

2.2.7 Parallel Transfer

- (1) This emulator supports memory accesses during user program execution using a DTC parallel transfer. To enable the DTC parallel transfer, select [Enable] for [Parallel] in the [Configuration] dialog box.

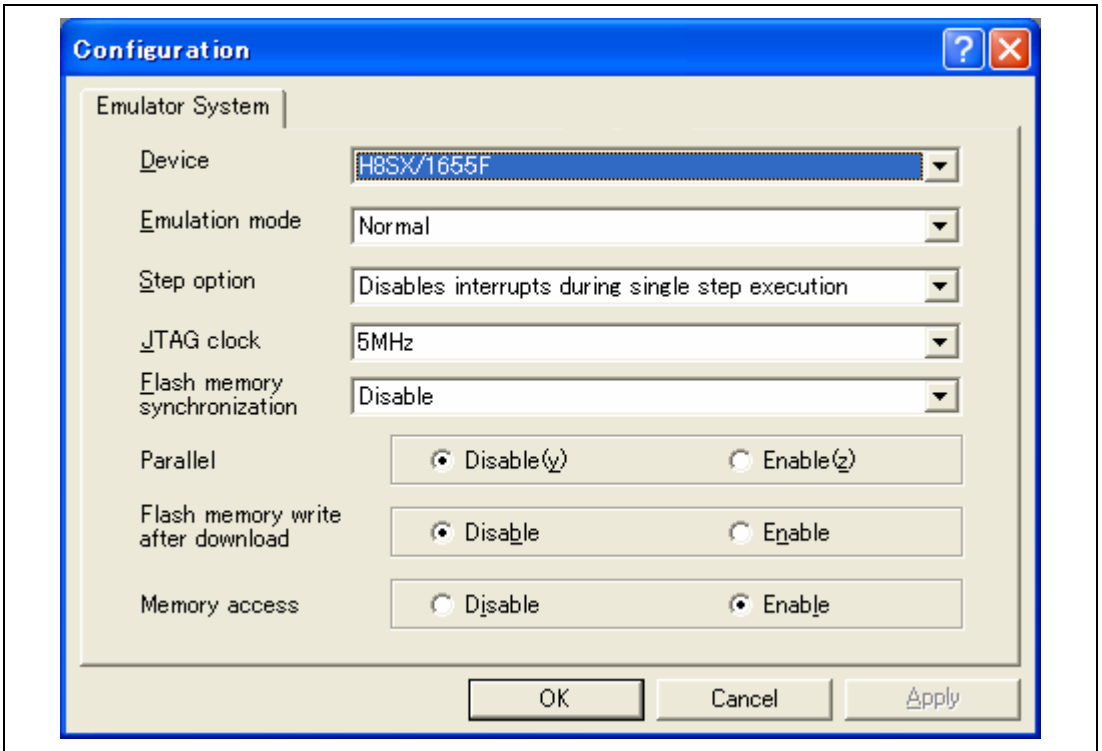

Figure 2.2 [Configuration] Dialog Box

[Parallel] group box: Selects the setting on memory accesses during user program execution.

Table 2.8 [Parallel] Group Box

Disable	Uses no emulator debugging function (DTC parallel transfer) to access memory. A short break occurs. (initial value)
Enable	Uses the emulator debugging function (DTC parallel transfer) to access memory.

(2) Limitations on DTC Parallel Transfer Enabled

- If the reserved area is accessed during DTC parallel transfer, a DMA address error occurs. Be sure to set the interrupt exception processing for the CPU or DMA address error on the user program.
- Use of DTC parallel transfer to access memory is prohibited in software standby mode; H'FF is displayed. If the emulator enters the software standby mode during DTC parallel transfer, correct transfer will not be performed. When the DTC parallel transfer function is used again, reconnect the emulator.
- If the DTC parallel transfer function is used to access I/O registers (I/O areas), accessing memory is prohibited in the range H'FFFF00 to H'FFFF1F (H'FF is displayed).
- If the user program is halted by a breakpoint or a break condition during DTC parallel transfer, correct transfer will not be performed and a dialog box will be displayed. When the DTC parallel transfer function is used again, reconnect the emulator.
- For reserved or external areas, accessing memory is available when external areas are set. H'FF is displayed only when reserved areas are set.

Figure 2.3 shows if an access to each area is possible or not during user program execution.

Address area map	DTC Parallel Transfer Disabled (Short Break)		DTC Parallel Transfer Enabled	
	Read	Write	Read	Write
Flash memory	Possible	Possible *1	Possible	Impossible *1
Reserved or external area	Possible *2	Possible *3	Impossible *4, *6	Impossible *4, *6
Internal RAM	Possible	Possible	Possible	Possible
Reserved or external area	Possible *2	Possible *3	Impossible *4, *6	Impossible *4, *6
Internal I/O area	Possible	Possible	Possible *5	Possible *5
Reserved or external area	Possible *2	Possible *3	Impossible *4, *6	Impossible *4, *6
Internal I/O area	Possible	Possible	Possible *5	Possible *5

Notes:

1. Only writes to the internal buffer. Data is actually written to when the flash memory is programmed next time.
2. Accessing memory is available in the external area. An undefined value is displayed in the reserved area.
3. Accessing memory is available in the external area.
4. A timeout occurs because the DTC stops the transfer when a DMA address error occurs.
5. Accesses by the DTC may not be possible depending on the register (due to the specifications of the DTC).
6. When the reserved area is accessed, H'FF is displayed. Accessing memory is available in the external area.

Figure 2.3 Parallel Accesses in Various Memory Areas

2.2.8 Debugging in the External Flash Memory

This emulator supports debugging in the external flash memory, which is the function to allow downloading of programs to the external flash memory area. Settings for the external flash memory should be made in the [External Flash memory setting] dialog box opened at initiation of the emulator. To display the [External Flash memory setting] dialog box, check [Use External Flash memory setting] in the [Select Emulator mode] dialog box. Debugging function equivalent to that in the H8SX E10A-USB system becomes available in the external flash memory area by specifying the initialization, write, or erase module*¹ and filling information on the external flash memory. Settings made in the [External Flash memory setting] dialog box are retained. Next time this dialog box is launched, the previous settings are displayed. Clicking the [Save] button saves the contents that have been set. The file to be saved (*.EFF: external flash memory data setting file) is loaded by clicking the [Browse...] button for [Select External Flash setting file]. When the file has been set, it is registered as the history (recent 10 files) in the combo box and selected to be loaded. Up to 1024 blocks can be specified for the external flash memory via the [External Flash memory setting] dialog box of the emulator. The maximum size allowed between the start address and the end address of the external flash memory is 16 Mbytes*². Since this function forcibly changes the device settings in the emulator when the initialization, write, or erase module is called, the emulator operates differently with the contents of the user program. To verify the operation of the user program, disable the [Use External Flash memory] check box and activate the emulator.

- Notes:
1. Prepare initialization, write, and erase modules that are suitable for the external flash memory being used.
 2. Make settings in accord with the region of memory on the individual device.

Table 2.9 lists the items contained in the [External Flash memory setting] dialog box.

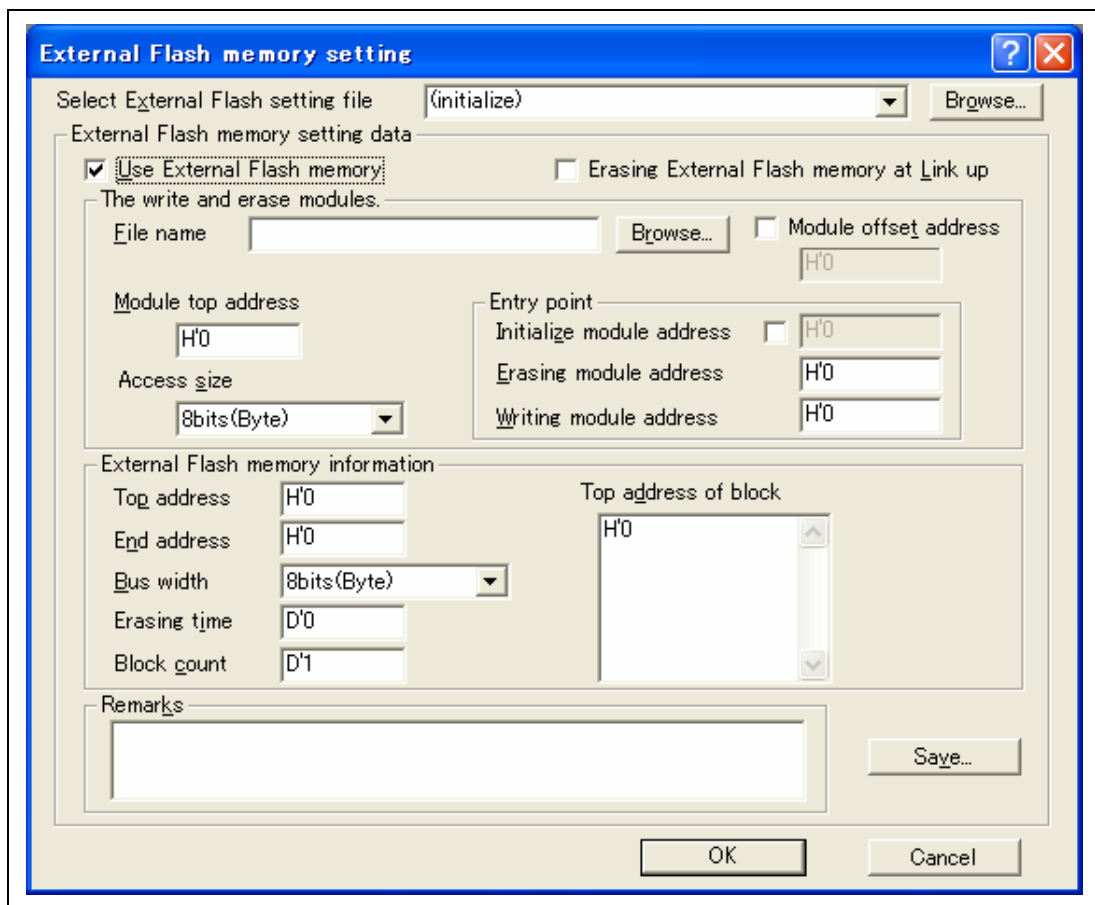

Figure 2.4 [External Flash memory setting] Dialog Box

Table 2.9 Items in [External Flash memory setting] Dialog Box

No.	Item	Description
1	Select External Flash setting file	Specify the data file (*.EFF) for setting the external flash memory. If not specified, select the setting of [recent setting data] (data previously changed) in the combo box. To make a new setting, select [initialize] and input data.
2	Use External Flash memory	Enable or disable use of the external flash memory debugging function. Checked: Enabled Not checked: Disabled (default)
3	Erasing External Flash memory at Link up	Select whether or not to erase the contents of the flash memory at initiation of the emulator. Checked: Erases the contents of the flash memory at initiation of the emulator. Not checked: Reads the contents of the flash memory at initiation of the emulator (default).
4	File name	Specify the file of initialization, write, and erase modules. A program file must be specified for programming the flash memory. Prepare a file suitable for the flash memory being used.
5	Module offset address	Specify the top address by an offset where the initialization, write, erasing modules are to be expanded. (Initial value is H'0). If not specified, disable offset. Checked: Enables offset. Not checked: Disables offset (default). (If the address exceeds H'FFFFFFFF, it will become H'0.)
6	Module top address	Specify the top address where the initialization, write, and erase modules are to be expanded. (The 4-kbyte address areas starting from that address are saved by the emulator; it is possible to expand the initialization, write, and erase modules without affecting on the user program.)
7	Initialize module address	Entry address of the initialization module The initialization module is used to set the device that is required for accessing the external flash memory. If not specified, disable entry. Checked: Enables entry. Not checked: Disables entry (default).
8	Erasing module address	Entry address of the erase module

Table 2.9 Items in [External Flash memory setting] Dialog Box (cont)

No.	Item	Description
9	Writing module address	Entry address of the write module
10	Access size	Select the unit of accesses for transfer of the programs. 8bits(Byte): Bytes 16bits(Word): Words 32bits(Long): Longwords
11	Top address	Top address of the flash memory
12	End address	End address of the flash memory*
13	Bus width	Select the unit of accesses to the flash memory. 8bits(Byte): Bytes 16bits(Word): Words 32bits(Long): Longwords
14	Erasing time	Waiting time for erasure (in seconds) (Specification of a decimal or hexadecimal value is recommended.)
15	Block count	Number of blocks in the flash memory (Specification of a decimal or hexadecimal value is recommended. Up to 1024 blocks can be specified.)
16	Top address of block	Define the start addresses of all blocks. If the flash memory has D'10 blocks, the definition will be as shown below. Press the Return key between the definitions for each of the blocks. Example: H'0 H'1000 H'2000 H'3000 H'4000 H'5000 H'6000 H'7000 H'8000 H'9000
17	Remarks	Use for writing a text. Contents of data that has been set can be entered. If not specified, setting is not needed.

Note: Make settings in accord with the region of memory on the individual device.

2.2.9 Interface with Initialization, Write, and Erase Modules and Emulator Firmware

The initialization, write, and erase modules must be branched from the firmware when the emulator is initiated and the external flash memory is written or read*.

Note: The modules are not called if the external flash memory data is not updated.

To branch from the emulator firmware to the initialization, write, and erase modules, or to return from the initialization, write, and erase modules to the emulator firmware, the following conditions must be observed:

- The size of each initialization, write, or erase module must be consecutive 4 Kbytes or less (including work areas and stack areas).
- Save and return all the general register values and control register values before and after calling the initialization, write, or erase module.
- Return the initialization, write, or erase module to the calling source after processing.
- The initialization, write, and erase modules must be Motorola S-type files.
- For the write module, write data ER1(L) to address ER0(L) and store the top address of flash memory ER2(L) then the result in ER0(L).
- For the erase module, erase the block of address ER0(L) and store the top address of flash memory ER1(L) then the result in ER0(L).
- Set the write size of the write module as described in No. 13 'Bus width' in table 2.9 (byte, word, or longword).
- The initialization module is used to set the device that is required for accessing the external flash memory. Store the result in ER0(L).

The module interface must be as follows to correctly pass the information that is required for accessing flash memory.

Table 2.10 Module Interface

Module Name	Argument	Return Value
Write module	ER0(L): Write address ER1(L): Write data ER2(L): Top address of the flash memory	ER0(L): Result (OK = 0, NG ≠ 0)
Erase module	ER0(L): Address of the block to be erased ER1(L): Top address of the flash memory	ER0(L): Result (OK = 0, NG ≠ 0)
Initialization module	-	ER0(L): Result (OK = 0, NG ≠ 0)

- Notes: 1. The (L) means the longword size.
2. The initialization module is not always set.

2.2.9 Performance Analysis

(1) Measuring Performance

Use the performance analysis function to measure the performance of programs. The performance analysis function does not affect the realtime operation because it uses an on-chip performance-measurement circuit to measure the performance in a specified range.

To open the [Performance Analysis] window, start by selecting [View -> Performance -> Performance Analysis] or clicking on the [PA] toolbar button (). The [Select Performance Analysis Type] dialog box appears.

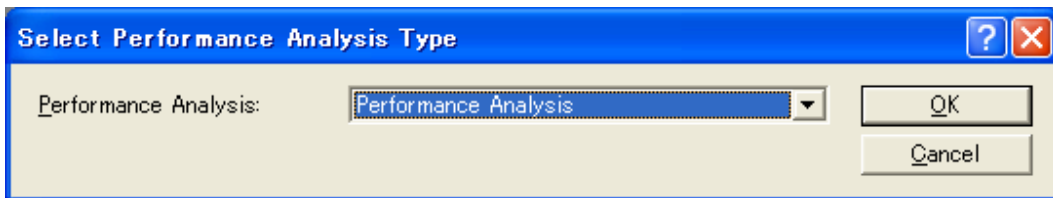

Figure 2.5 [Select Performance Analysis Type] Dialog Box

Click on the [OK] button to open the [Performance Analysis] window.

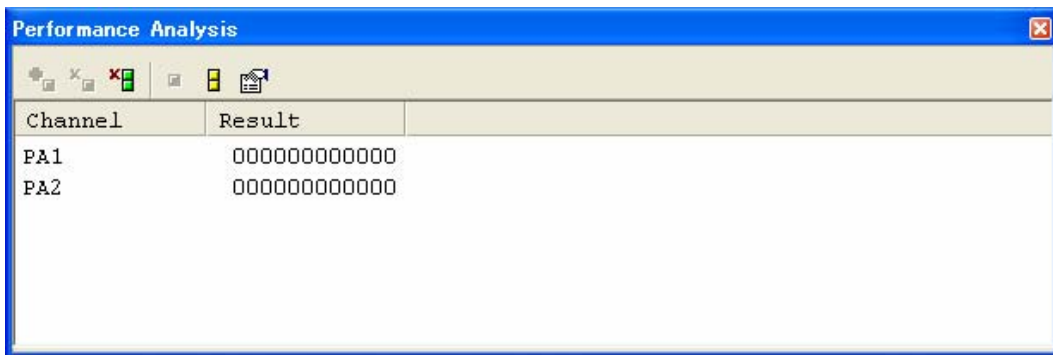

Figure 2.6 [Performance Analysis] Window

Performance-measurement settings should be made in the [Performance Analysis] dialog box.

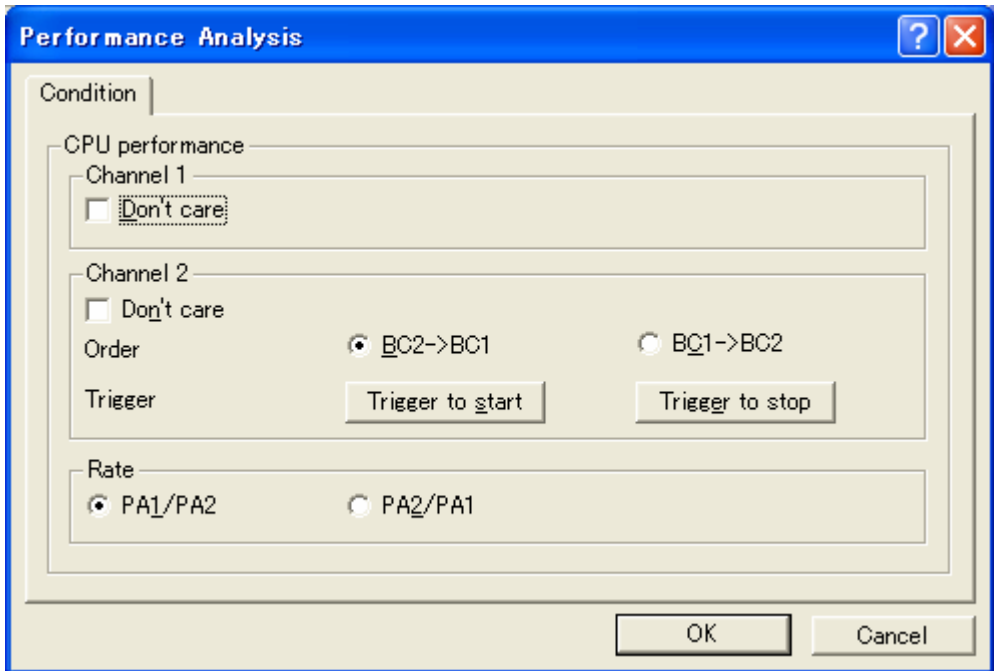

Figure 2.7 [Performance Analysis] Dialog Box

The [Performance Analysis] dialog box contains the following items.

[Channel 1] group box: Settings on PA1

[Don't care] checkbox

Selected:

Performance measurement will not be performed on PA1.

Not selected:

Performance measurement will be performed on PA1.

PA1 is for measuring the number of execution cycles in the entire program.



[Channel 2] group box: Settings on PA2

[Don't care] checkbox	Selected: Performance measurement will <u>not</u> be performed on PA2. Not selected: Performance measurement will be performed on PA2. PA2 is for measuring the number of execution cycles between two points.
[BC2 -> BC1] radio button	Measurement starts with satisfaction of break condition 2 and stops with satisfaction of break condition 1.
[BC1 -> BC2] radio button	Measurement starts with satisfaction of break condition 1 and stops with satisfaction of break condition 2.
[Trigger to start] button	Clicking on this button opens a [Break condition] dialog box for the condition to start measurement.
[Trigger to stop] button	Clicking on this button opens a [Break condition] dialog box for the condition to stop measurement.

[Rate] group box: Form of the measurement results

PA1/PA2	Rate of PA1 to PA2
PA2/PA1	Rate of PA2 to PA1

(2) Measurement Results

The [Performance Analysis] window shows the number of execution cycles measured during execution of the program. The results of measurement are cumulative. To clear them, display the popup menu by right-clicking on the [Performance Analysis] window, then select "Clear Data", "Clear All Data" or one of the following icons:  or .

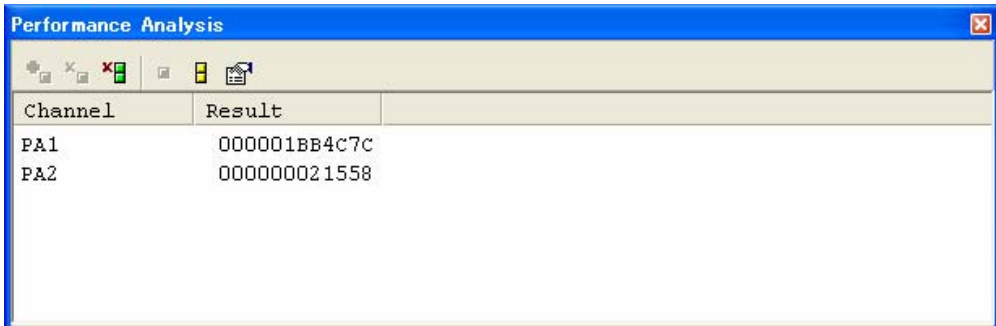

Channel	Result
PA1	000001BB4C7C
PA2	000000021558

Figure 2.8 [Performance Analysis] Window (Results)

PA1: Result on performance channel 1 represented as a 12-digit hexadecimal value

PA2: Result on performance channel 2 represented as a 12-digit hexadecimal value

Note: When the performance counter has overflowed, an asterisk (*) is displayed on the left to the value.

(3) Rate of Measurement Results

Right-click on the [Performance Measurement] window and select [Properties] from the popup menu, or click on the corresponding icon () to check the rate of measurement results on PA1 and PA2.

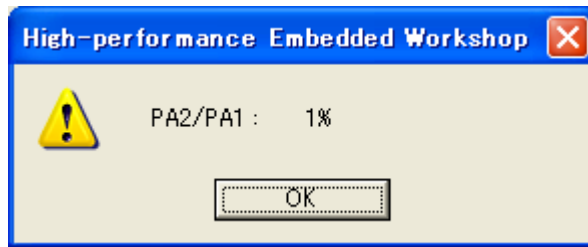

Figure 2.9 Rate of Measurement Results

(4) Other

- On PA1, several cycles are added to the count when stepping is performed or the program ends. So tolerances will be included in the measurement result.
- When PA2 has been selected but BC1 and BC2 are disabled, the program will not be executed.

**H8S, H8SX Family E10A-USB Emulator
Additional Document for User's Manual
Supplementary Information on
Using the H8SX/1655F and H8SX/1652F**

Publication Date: Rev.1.00, December 25, 2008
Rev.2.00, July 31, 2009

Published by: Sales Strategic Planning Div.
Renesas Technology Corp.

Edited by: Customer Support Department
Global Strategic Communication Div.
Renesas Solutions Corp.

Renesas Technology Corp. Sales Strategic Planning Div. Nippon Bldg., 2-6-2, Ohte-machi, Chiyoda-ku, Tokyo 100-0004, Japan



RENESAS SALES OFFICES

<http://www.renesas.com>

Refer to "<http://www.renesas.com/en/network>" for the latest and detailed information.

Renesas Technology America, Inc.
450 Holger Way, San Jose, CA 95134-1368, U.S.A
Tel: <1> (408) 382-7500, Fax: <1> (408) 382-7501

Renesas Technology Europe Limited
Dukes Meadow, Millboard Road, Bourne End, Buckinghamshire, SL8 5FH, U.K.
Tel: <44> (1628) 585-100, Fax: <44> (1628) 585-900

Renesas Technology (Shanghai) Co., Ltd.
Unit 204, 205, AZIACenter, No.1233 Lujiazui Ring Rd, Pudong District, Shanghai, China 200120
Tel: <86> (21) 5877-1818, Fax: <86> (21) 6887-7858/7898

Renesas Technology Hong Kong Ltd.
7th Floor, North Tower, World Finance Centre, Harbour City, Canton Road, Tsimshatsui, Kowloon, Hong Kong
Tel: <852> 2265-6688, Fax: <852> 2377-3473

Renesas Technology Taiwan Co., Ltd.
10th Floor, No.99, Fushing North Road, Taipei, Taiwan
Tel: <886> (2) 2715-2888, Fax: <886> (2) 3518-3399

Renesas Technology Singapore Pte. Ltd.
1 Harbour Front Avenue, #06-10, Keppel Bay Tower, Singapore 098632
Tel: <65> 6213-0200, Fax: <65> 6278-8001

Renesas Technology Korea Co., Ltd.
Kukje Center Bldg. 18th Fl., 191, 2-ka, Hangang-ro, Yongsan-ku, Seoul 140-702, Korea
Tel: <82> (2) 796-3115, Fax: <82> (2) 796-2145

Renesas Technology Malaysia Sdn. Bhd
Unit 906, Block B, Menara Amcorp, Amcorp Trade Centre, No.18, Jln Persiaran Barat, 46050 Petaling Jaya, Selangor Darul Ehsan, Malaysia
Tel: <603> 7955-9390, Fax: <603> 7955-9510

**H8S, H8SX Family E10A-USB Emulator
Additional Document for User's Manual
Supplementary Information on Using the
H8SX/1655F and H8SX/1652F**



Renesas Electronics Corporation

1753, Shimonumabe, Nakahara-ku, Kawasaki-shi, Kanagawa 211-8668 Japan

REJ10J1950-0200