

To our customers,

Old Company Name in Catalogs and Other Documents

On April 1st, 2010, NEC Electronics Corporation merged with Renesas Technology Corporation, and Renesas Electronics Corporation took over all the business of both companies. Therefore, although the old company name remains in this document, it is a valid Renesas Electronics document. We appreciate your understanding.

Renesas Electronics website: <http://www.renesas.com>

April 1st, 2010
Renesas Electronics Corporation

Issued by: Renesas Electronics Corporation (<http://www.renesas.com>)

Send any inquiries to <http://www.renesas.com/inquiry>.

Notice

1. All information included in this document is current as of the date this document is issued. Such information, however, is subject to change without any prior notice. Before purchasing or using any Renesas Electronics products listed herein, please confirm the latest product information with a Renesas Electronics sales office. Also, please pay regular and careful attention to additional and different information to be disclosed by Renesas Electronics such as that disclosed through our website.
2. Renesas Electronics does not assume any liability for infringement of patents, copyrights, or other intellectual property rights of third parties by or arising from the use of Renesas Electronics products or technical information described in this document. No license, express, implied or otherwise, is granted hereby under any patents, copyrights or other intellectual property rights of Renesas Electronics or others.
3. You should not alter, modify, copy, or otherwise misappropriate any Renesas Electronics product, whether in whole or in part.
4. Descriptions of circuits, software and other related information in this document are provided only to illustrate the operation of semiconductor products and application examples. You are fully responsible for the incorporation of these circuits, software, and information in the design of your equipment. Renesas Electronics assumes no responsibility for any losses incurred by you or third parties arising from the use of these circuits, software, or information.
5. When exporting the products or technology described in this document, you should comply with the applicable export control laws and regulations and follow the procedures required by such laws and regulations. You should not use Renesas Electronics products or the technology described in this document for any purpose relating to military applications or use by the military, including but not limited to the development of weapons of mass destruction. Renesas Electronics products and technology may not be used for or incorporated into any products or systems whose manufacture, use, or sale is prohibited under any applicable domestic or foreign laws or regulations.
6. Renesas Electronics has used reasonable care in preparing the information included in this document, but Renesas Electronics does not warrant that such information is error free. Renesas Electronics assumes no liability whatsoever for any damages incurred by you resulting from errors in or omissions from the information included herein.
7. Renesas Electronics products are classified according to the following three quality grades: "Standard", "High Quality", and "Specific". The recommended applications for each Renesas Electronics product depends on the product's quality grade, as indicated below. You must check the quality grade of each Renesas Electronics product before using it in a particular application. You may not use any Renesas Electronics product for any application categorized as "Specific" without the prior written consent of Renesas Electronics. Further, you may not use any Renesas Electronics product for any application for which it is not intended without the prior written consent of Renesas Electronics. Renesas Electronics shall not be in any way liable for any damages or losses incurred by you or third parties arising from the use of any Renesas Electronics product for an application categorized as "Specific" or for which the product is not intended where you have failed to obtain the prior written consent of Renesas Electronics. The quality grade of each Renesas Electronics product is "Standard" unless otherwise expressly specified in a Renesas Electronics data sheets or data books, etc.

"Standard": Computers; office equipment; communications equipment; test and measurement equipment; audio and visual equipment; home electronic appliances; machine tools; personal electronic equipment; and industrial robots.

"High Quality": Transportation equipment (automobiles, trains, ships, etc.); traffic control systems; anti-disaster systems; anti-crime systems; safety equipment; and medical equipment not specifically designed for life support.

"Specific": Aircraft; aerospace equipment; submersible repeaters; nuclear reactor control systems; medical equipment or systems for life support (e.g. artificial life support devices or systems), surgical implantations, or healthcare intervention (e.g. excision, etc.), and any other applications or purposes that pose a direct threat to human life.

8. You should use the Renesas Electronics products described in this document within the range specified by Renesas Electronics, especially with respect to the maximum rating, operating supply voltage range, movement power voltage range, heat radiation characteristics, installation and other product characteristics. Renesas Electronics shall have no liability for malfunctions or damages arising out of the use of Renesas Electronics products beyond such specified ranges.
9. Although Renesas Electronics endeavors to improve the quality and reliability of its products, semiconductor products have specific characteristics such as the occurrence of failure at a certain rate and malfunctions under certain use conditions. Further, Renesas Electronics products are not subject to radiation resistance design. Please be sure to implement safety measures to guard them against the possibility of physical injury, and injury or damage caused by fire in the event of the failure of a Renesas Electronics product, such as safety design for hardware and software including but not limited to redundancy, fire control and malfunction prevention, appropriate treatment for aging degradation or any other appropriate measures. Because the evaluation of microcomputer software alone is very difficult, please evaluate the safety of the final products or system manufactured by you.
10. Please contact a Renesas Electronics sales office for details as to environmental matters such as the environmental compatibility of each Renesas Electronics product. Please use Renesas Electronics products in compliance with all applicable laws and regulations that regulate the inclusion or use of controlled substances, including without limitation, the EU RoHS Directive. Renesas Electronics assumes no liability for damages or losses occurring as a result of your noncompliance with applicable laws and regulations.
11. This document may not be reproduced or duplicated, in any form, in whole or in part, without prior written consent of Renesas Electronics.
12. Please contact a Renesas Electronics sales office if you have any questions regarding the information contained in this document or Renesas Electronics products, or if you have any other inquiries.

(Note 1) "Renesas Electronics" as used in this document means Renesas Electronics Corporation and also includes its majority-owned subsidiaries.

(Note 2) "Renesas Electronics product(s)" means any product developed or manufactured by or for Renesas Electronics.

H8/3160 E6000 Emulator

User's Manual

Renesas Microcomputer
Development Environment
System

H8 Series

AE-3 Series

HS3160EPI60HE-U2

Keep safety first in your circuit designs!

1. Renesas Technology Corp. puts the maximum effort into making semiconductor products better and more reliable, but there is always the possibility that trouble may occur with them. Trouble with semiconductors may lead to personal injury, fire or property damage.
Remember to give due consideration to safety when making your circuit designs, with appropriate measures such as (i) placement of substitutive, auxiliary circuits, (ii) use of nonflammable material or (iii) prevention against any malfunction or mishap.

Notes regarding these materials

1. These materials are intended as a reference to assist our customers in the selection of the Renesas Technology Corp. product best suited to the customer's application; they do not convey any license under any intellectual property rights, or any other rights, belonging to Renesas Technology Corp. or a third party.
2. Renesas Technology Corp. assumes no responsibility for any damage, or infringement of any third-party's rights, originating in the use of any product data, diagrams, charts, programs, algorithms, or circuit application examples contained in these materials.
3. All information contained in these materials, including product data, diagrams, charts, programs and algorithms represents information on products at the time of publication of these materials, and are subject to change by Renesas Technology Corp. without notice due to product improvements or other reasons. It is therefore recommended that customers contact Renesas Technology Corp. or an authorized Renesas Technology Corp. product distributor for the latest product information before purchasing a product listed herein.
The information described here may contain technical inaccuracies or typographical errors. Renesas Technology Corp. assumes no responsibility for any damage, liability, or other loss rising from these inaccuracies or errors.
Please also pay attention to information published by Renesas Technology Corp. by various means, including the Renesas Technology Corp. Semiconductor home page (<http://www.renesas.com>).
4. When using any or all of the information contained in these materials, including product data, diagrams, charts, programs, and algorithms, please be sure to evaluate all information as a total system before making a final decision on the applicability of the information and products. Renesas Technology Corp. assumes no responsibility for any damage, liability or other loss resulting from the information contained herein.
5. Renesas Technology Corp. semiconductors are not designed or manufactured for use in a device or system that is used under circumstances in which human life is potentially at stake. Please contact Renesas Technology Corp. or an authorized Renesas Technology Corp. product distributor when considering the use of a product contained herein for any specific purposes, such as apparatus or systems for transportation, vehicular, medical, aerospace, nuclear, or undersea repeater use.
6. The prior written approval of Renesas Technology Corp. is necessary to reprint or reproduce in whole or in part these materials.
7. If these products or technologies are subject to the Japanese export control restrictions, they must be exported under a license from the Japanese government and cannot be imported into a country other than the approved destination.
Any diversion or reexport contrary to the export control laws and regulations of Japan and/or the country of destination is prohibited.
8. Please contact Renesas Technology Corp. for further details on these materials or the products contained therein.

IMPORTANT INFORMATION

READ FIRST

- **READ this user's manual before using this emulator product.**
- **KEEP the user's manual handy for future reference.**

Do not attempt to use the emulator product until you fully understand its mechanism.

Emulator Product:

Throughout this document, the term "emulator product" shall be defined as the following products produced only by Renesas Technology Corp. excluding all subsidiary products.

- Emulator station
- User system interface cables
- PC interface board
- Optional SIMM memory module
- Optional board

The user system or a host computer is not included in this definition.

Purpose of the Emulator Product:

This emulator product is a software and hardware development tool for systems employing the Renesas microcomputer (hereinafter referred to as the MCU). This emulator product must only be used for the above purpose.

Limited Applications:

This emulator product is not authorized for use in MEDICAL, atomic energy, aeronautical or space technology applications without consent of the appropriate officer of a Renesas sales company. Such use includes, but is not limited to, use in life support systems. Buyers of this emulator product must notify the relevant Renesas sales offices before planning to use the product in such applications.

Improvement Policy:

Renesas Technology Corp. (including its subsidiaries, hereafter collectively referred to as Renesas) pursues a policy of continuing improvement in design, performance, and safety of the emulator product. Renesas reserves the right to change, wholly or partially, the specifications, design, user's manual, and other documentation at any time without notice.

Target User of the Emulator Product:

This emulator product should only be used by those who have carefully read and thoroughly understood the information and restrictions contained in the user's manual. Do not attempt to use the emulator product until you fully understand its mechanism.

It is highly recommended that first-time users be instructed by users that are well versed in the operation of the emulator product.

LIMITED WARRANTY

Renesas warrants its emulator products to be manufactured in accordance with published specifications and free from defects in material and/or workmanship. Renesas, at its option, will repair or replace any emulator products returned intact to the factory, transportation charges prepaid, which Renesas, upon inspection, determine to be defective in material and/or workmanship.

The foregoing shall constitute the sole remedy for any breach of Renesas' warranty. See the Renesas warranty booklet for details on the warranty period. This warranty extends only to you, the original Purchaser. It is not transferable to anyone who subsequently purchases the emulator product from you. Renesas is not liable for any claim made by a third party or made by you for a third party.

DISCLAIMER

RENESAS MAKES NO WARRANTIES, EITHER EXPRESS OR IMPLIED, ORAL OR WRITTEN, EXCEPT AS PROVIDED HEREIN, INCLUDING WITHOUT LIMITATION THEREOF, WARRANTIES AS TO MARKETABILITY, MERCHANTABILITY, FITNESS FOR ANY PARTICULAR PURPOSE OR USE, OR AGAINST INFRINGEMENT OF ANY PATENT. IN NO EVENT SHALL RENESAS BE LIABLE FOR ANY DIRECT, INCIDENTAL OR CONSEQUENTIAL DAMAGES OF ANY NATURE, OR LOSSES OR EXPENSES RESULTING FROM ANY DEFECTIVE EMULATOR PRODUCT, THE USE OF ANY EMULATOR PRODUCT, OR ITS DOCUMENTATION, EVEN IF ADVISED OF THE POSSIBILITY OF SUCH DAMAGES. EXCEPT AS EXPRESSLY STATED OTHERWISE IN THIS WARRANTY, THIS EMULATOR PRODUCT IS SOLD "AS IS", AND YOU MUST ASSUME ALL RISK FOR THE USE AND RESULTS OBTAINED FROM THE EMULATOR PRODUCT.

State Law:

Some states do not allow the exclusion or limitation of implied warranties or liability for incidental or consequential damages, so the above limitation or exclusion may not apply to you. This warranty gives you specific legal rights, and you may have other rights which may vary from state to state.

The Warranty is Void in the Following Cases:

Renesas shall have no liability or legal responsibility for any problems caused by misuse, abuse, misapplication, neglect, improper handling, installation, repair or modifications of the emulator product without Renesas' prior written consent or any problems caused by the user system.

All Rights Reserved:

This user's manual and emulator product are copyrighted and all rights are reserved by Renesas. No part of this user's manual, all or part, may be reproduced or duplicated in any form, in hard-copy or machine-readable form, by any means available without Renesas' prior written consent.

Other Important Things to Keep in Mind:

1. Circuitry and other examples described herein are meant merely to indicate the characteristics and performance of Renesas' semiconductor products. Renesas assumes no responsibility for any intellectual property claims or other problems that may result from applications based on the examples described herein.
2. No license is granted by implication or otherwise under any patents or other rights of any third party or Renesas.

Figures:

Some figures in this user's manual may show items different from your actual system.

Limited Anticipation of Danger:

Renesas cannot anticipate every possible circumstance that might involve a potential hazard. The warnings in this user's manual and on the emulator product are therefore not all inclusive. Therefore, you must use the emulator product safely at your own risk.

SAFETY PAGE

READ FIRST

- **READ** this user's manual before using this emulator product.
- **KEEP** the user's manual handy for future reference.

Do not attempt to use the emulator product until you fully understand its mechanism.

DEFINITION OF SIGNAL WORDS



This is the safety alert symbol. It is used to alert you to potential personal injury hazards. Obey all safety messages that follow this symbol to avoid possible injury or death.



DANGER indicates an imminently hazardous situation which, if not avoided, will result in death or serious injury.



WARNING indicates a potentially hazardous situation which, if not avoided, could result in death or serious injury.



CAUTION indicates a potentially hazardous situation which, if not avoided, may result in minor or moderate injury.



CAUTION used without the safety alert symbol indicates a potentially hazardous situation which, if not avoided, may result in property damage.

NOTE emphasizes essential information.

WARNING

Observe the precautions listed below. Failure to do so will result in a FIRE HAZARD and will damage the user system and the emulator product or will result in PERSONAL INJURY. The USER PROGRAM will be LOST.

- 1. Do not repair or remodel the emulator product by yourself for electric shock prevention and quality assurance.**
- 2. Always switch OFF the E6000 emulator and user system before connecting or disconnecting any CABLES or PARTS.**
- 3. Always before connecting any CABLES, make sure that pin 1 on both sides are correctly aligned.**
- 4. Supply power according to the power specifications and do not apply an incorrect power voltage. Use only the provided power cable.**

CAUTION

This equipment has been tested and found to comply with the limits for a Class A digital device, pursuant to part 15 of the FCC Rules. These limits are designed to provide reasonable protection against harmful interference when the equipment is operated in a commercial environment. This equipment generates, uses, and can radiate radio frequency energy and, if not installed and used in accordance with the instruction manual, may cause harmful interference to radio communications. Operation of this equipment in a residential area is likely to cause harmful interference in which case the user will be required to correct the interference at his own expense.

Introduction

The E6000 emulator is an advanced realtime in-circuit emulator, which allows programs to be developed and debugged for the H8 family microcomputers.

The E6000 emulator can either be used without a user system, for developing and debugging software, or connected via a user system interface cable to a user system, for debugging user hardware.

High-performance Embedded Workshop (hereafter referred to as HEW) is a Graphical User Interface intended to ease the development and debugging of applications written in C/C++ programming language and assembly language for Renesas microcomputers. Its aim is to provide a powerful yet intuitive way of accessing, observing and modifying the debugging platform in which the application is running.

HEW is a powerful development environment for embedded applications targeted at Renesas microcontrollers. The main features are:

- A configurable build engine that allows you to set-up compiler, assembler and linker options via an easy to use interface.
- An integrated text editor with user customizable syntax coloring to improve code readability.
- A configurable environment to run your own tools.
- An integrated debugger which allows you to build and debug in the same application.
- Version control support.

HEW has been designed with two key aims; firstly to provide you, the user, with a set of powerful development tools and, secondly, to unify and present them in a way that is easy to use.

About This Manual

This manual is comprised of two parts: HEW Part and Emulator Debugger Part.

HEW Part: Information on the basic “look and feel” of the HEW and customizing the HEW environment, and detail of the HEW’s build function.

Emulator Debugger Part: Preparation before use, E6000 emulator functions, debugging function, tutorial, and hardware and software specifications of the E6000 emulator.

This manual does not intend to explain how to write C/C++ or assembly language programs, how to use any particular operating system or how best to tailor code for the individual devices. These issues are left to the respective manuals.

Microsoft®, MS-DOS, Windows®, Windows NT® are registered trademarks of Microsoft Corporation.

Visual SourceSafe is a trademark of Microsoft Corporation.

IBM is a registered trademark of International Business Machines Corporation.

All brand or product names used in this manual are trademarks or registered trademarks of their respective companies or organizations.

Document Conventions

This manual uses the following typographic conventions:

Table 1 Typographic Conventions

Convention	Meaning
[Menu->Menu Option]	Bold text with ‘->’ is used to indicate menu options (for example, [File->Save As...]).
FILENAME.C	Uppercase names are used to indicate filenames.
“enter this string”	Used to indicate text that must be entered (excluding the “” quotes).
Key + Key	Used to indicate required key presses. For example, CTRL+N means press the CTRL key and then, whilst holding the CTRL key down, press the N key.
☞ (The “how to” symbol)	When this symbol is used, it is always located in the left hand margin. It indicates that the text to its immediate right is describing “how to” do something.

Components

Check all the components described in the component list unpacking. If the components are not complete, contact a Renesas sales office.

Contents

HEW Part

1.	Overview	1
1.1	Workspaces, Projects and Files	1
1.2	The Main Window	2
1.2.1	The Title Bar	2
1.2.2	The Menu Bar	2
1.2.3	The Toolbars	3
1.2.4	The Workspace Window	5
1.2.5	The Editor Window	7
1.2.6	The Output Window	8
1.2.7	The Status Bar	9
1.3	The Help System	9
1.4	Launching the HEW	10
1.5	Exiting the HEW	10
1.6	Component System Overview	10
2.	Build Basics	11
2.1	The Build Process	11
2.2	Project Files	12
2.2.1	Adding Files to a Project	13
2.2.2	Removing Files from a Project	15
2.2.3	Excluding a Project File from Build	16
2.2.4	Including a Project File in Build	16
2.3	File Extensions and File Groups	17
2.4	Specifying How to Build a File	22
2.5	Build Configurations	23
2.5.1	Selecting a Configuration	24
2.5.2	Adding and Deleting Configurations	25
2.6	Building a Project	26
2.6.1	Building a Project	26
2.6.2	Building Individual Files	26
2.6.3	Stopping a Build	27
2.6.4	Building Multiple Projects	27
2.6.5	The Output Window	28
2.6.6	Controlling the Content of the Output Window	28
2.6.7	Displaying out of date files in the workspace window	30
2.7	File Dependencies	31
2.8	Configuring the Workspace Window	31
2.8.1	Show Dependencies under Each File	31
2.8.2	Show Standard Library Includes	32
2.8.3	Show File Paths	32
2.8.4	Sort files by time order	33
2.9	Setting the Current Project	33
2.10	Inserting a Project into a Workspace	34
2.11	Specifying Dependencies between Projects	35
2.12	Removing a Project from a Workspace	36
2.13	Loading/unloading a Project into/from a Workspace	36
2.14	Relative projects paths in the workspace	37

2.15	User folders in the workspace.....	38
3.	Advanced Build Features	39
3.1	The Build Process Revisited	39
3.1.1	What is a Build?.....	39
3.2	Creating a Custom Build Phase.....	41
3.3	Ordering Build Phases	45
3.3.1	Build Phase Order.....	46
3.3.2	Build File Phase Order.....	49
3.4	Setting Custom Build Phase Options	50
3.4.1	Options Tab.....	51
3.4.2	Output Files Tab	51
3.4.3	Dependent Files Tab	53
3.5	File Mappings	55
3.6	Controlling the Build	57
3.7	Logging Build Output	58
3.8	Changing Toolchain Version	59
3.9	Using an External Debugger	60
3.10	Generating a Makefile.....	63
3.11	Using a makefile inside the HEW system.....	65
3.12	Customizing the HEW linkage order	67
4.	Using the Editor.....	69
4.1	The Editor Window.....	69
4.2	Working with Multiple Files	70
4.2.1	The Editor Toolbars	70
4.2.2	Editor Toolbar Buttons	70
4.2.3	Search Toolbar Buttons.....	72
4.2.4	Bookmarks Toolbar Buttons	72
4.2.5	Templates Toolbar Buttons.....	72
4.3	Standard File Operations.....	73
4.3.1	Creating a New File	73
4.3.2	Saving a File	73
4.3.3	Saving all Files.....	73
4.3.4	Opening a File.....	74
4.3.5	Closing Files	74
4.4	Editing a File.....	75
4.5	Searching and Navigating through Files	76
4.5.1	Finding Text.....	76
4.5.2	Finding Text in Multiple Files	77
4.5.3	Replacing Text.....	78
4.5.4	Jumping to a Specified Line	79
4.6	Bookmarks	80
4.7	Printing a File.....	80
4.8	Configuring Text Layout	81
4.8.1	Page Set-up	81
4.8.2	Changing Tabs	83
4.8.3	Auto Indentation	84
4.9	Splitting a Window	85
4.10	Configuring Text.....	86
4.10.1	Changing the Editor Font.....	86
4.11	Syntax Coloring	87
4.12	Templates.....	89

4.12.1	Defining a Template	89
4.12.2	Deleting a Template	91
4.12.3	Inserting a Template	91
4.12.4	Brace Matching.....	92
4.13	Editor Column management	93
4.14	Enable tooltip watch.....	94
5.	Tools Administration	95
5.1	Tool Locations	96
5.2	HEW Registration Files (*.HRF)	96
5.3	Registering Components	97
5.3.1	Searching Drives for Components	97
5.3.2	Registering a Single Component.....	98
5.4	Unregistering Components.....	98
5.5	Viewing and Editing Component Properties.....	99
5.6	Uninstalling Components.....	101
5.7	Technical Support Issues.....	103
5.8	On-Demand components.....	105
5.9	Custom Project Types	106
6.	Customizing the Environment	113
6.1	Customizing the Toolbar.....	113
6.2	Customizing the Tools Menu	116
6.3	Configuring the Help System.....	118
6.4	Specifying Workspace Options.....	119
6.4.1	Open last workspace at start-up	120
6.4.2	Restore the files on opening workspace.....	120
6.4.3	Display workspace information dialog on opening workspace.....	120
6.4.4	Save workspace before executing any tools.....	121
6.4.5	Prompt before saving workspace	121
6.4.6	Prompt before saving session.....	121
6.4.7	Save auto-recovery info	122
6.4.8	Default directory for new workspaces	122
6.5	Using an External Editor	123
6.6	Customizing File Save	124
6.6.1	Save files before executing any tools.....	124
6.6.2	Prompt before saving files	124
6.7	Using Custom Placeholders	125
6.8	Using the workspace and project log facilities.....	127
6.9	Using the virtual desktop	127
7.	Version Control.....	129
7.1	Selecting a Version Control System.....	130
8.	Using the Custom Version Control System.....	133
8.1	Defining Version Control Menu Options.....	133
8.1.1	System menu options and toolbar buttons.....	135
8.1.2	User menu options	137
8.2	Defining Version Control Commands.....	139
8.2.1	Executable return code.....	139
8.3	Specifying Arguments.....	140
8.3.1	Specifying File Locations	141
8.3.2	Specifying Environment	144

8.3.3	Specifying Comments	145
8.3.4	Specifying a User Name and Password	146
8.4	Controlling Execution	148
8.4.1	Prompt before executing command	148
8.4.2	Run in DOS Window	148
8.4.3	Use forward slash '/' as version control directory delimiter	148
8.5	Importing and exporting a Set-up	149
9.	Using Visual SourceSafe	151
9.1	Attaching Visual SourceSafe to a Workspace	151
9.1.1	Selecting Visual SourceSafe	151
9.1.2	Adding files to Visual SourceSafe	152
9.2	Visual SourceSafe commands	153
9.2.1	Removing a File from Version Control	153
9.2.2	Getting a Read Only Copy of a File from Version Control	153
9.2.3	Checking Out a Writable Copy of a File from Version Control	154
9.2.4	Checking In a Writable Copy of a File into Version Control	154
9.2.5	Undoing a Check Out Operation	154
9.2.6	Viewing the Status of a File	155
9.2.7	Viewing the History of a File	155
9.3	Visual SourceSafe Integration Options	155
10.	Network Facilities	157
10.1	Overview	157
10.1.1	Enabling network access	158
10.1.2	Setting the administrator user's password	158
10.1.3	Adding new users to the system	160
10.1.4	Changing your password	161
10.1.5	Using the network HEW service	161
11.	Difference View	163
12.	Technical Support	167
13.	Navigation facilities	169
13.1	C++ Navigation component	171
13.2	C Function and #defines navigation components	174
14.	Smart Editor	175

Emulator Debugger Part

Section 1	Overview	179
1.1	Features	179
1.2	Warnings	180
1.3	Environmental Conditions	181
1.4	Emulator External Dimensions and Mass	181
Section 2	Preparation before Use	183
2.1	Emulator Preparation	183
2.2	Installing Emulator's Software	183
2.3	Connecting to the User System	184
2.3.1	Connecting the User System Interface Cable Body to the Emulator	184

2.3.2	Connecting the Use System Interface Cable Head.....	185
2.4	Power Supply	185
2.4.1	AC Adapter	185
2.4.2	Polarity	185
2.4.3	Power Supply Monitor Circuit.....	185
2.5	Hardware Interface.....	186
2.5.1	Signal Protection on the Emulator	186
2.5.2	User System Interface Circuits.....	186
2.5.3	Clock Oscillator	186
2.5.4	External Probe/Trigger Output.....	186
2.5.5	Power Supply Circuit	187
2.6	System Check.....	188
2.7	Communication Problems.....	192
2.8	Other Methods for Activating the Emulator.....	192
2.9	Uninstalling the Emulator's Software	192
Section 3 E6000 Emulator Functions		193
3.1	Debugging Features	193
3.1.1	Breakpoints	193
3.1.2	Trace	193
3.1.3	Execution Time Measurements.....	193
3.1.4	Performance Analysis	193
3.1.5	Bus Monitoring	194
3.1.6	Coverage	194
3.2	Complex Event System (CES).....	194
3.2.1	Event Channels	194
3.2.2	Range Channels	195
3.2.3	Breaks	195
3.2.4	Timing.....	195
3.3	Hardware Features	195
3.3.1	Memory.....	195
3.3.2	Clocks	196
3.3.3	Probes.....	196
3.4	Stack Trace Function	196
3.5	Online Help.....	196
Section 4 Preparation before Use.....		197
4.1	Workspaces, Projects, and Files.....	197
4.2	Method for Activating HEW.....	198
4.2.1	Creating a New Workspace (Toolchain Not Used).....	199
4.2.2	Creating a New Workspace (Toolchain Used)	203
4.2.3	Selecting an Existing Workspace	207
4.3	Setting at Emulator Activation.....	208
4.4	Debugger Sessions	210
4.4.1	Selecting a Session.....	210
4.4.2	Adding and Deleting Sessions	211
4.4.3	Saving Session Information	213
4.5	Connecting the Emulator.....	214
4.6	Reconnecting the Emulator	214
4.7	Ending the Emulator	215
Section 5 Debugging.....		217
5.1	Setting the Environment for Emulation	217

5.1.1	Opening the [Configuration Properties] Dialog Box	217
5.1.2	Selecting an MCU Not Included in the List.....	219
5.1.3	Selecting the Interface to be Connected.....	220
5.1.4	Opening the [Memory Mapping] Dialog Box.....	221
5.1.5	Changing the Memory Map Setting.....	222
5.2	Downloading a Program	223
5.2.1	Downloading a Program	223
5.2.2	Viewing the Source Code	224
5.2.3	Viewing the Assembly-Language Code.....	227
5.2.4	Modifying the Assembly-Language Code	227
5.2.5	Viewing a Specific Address.....	228
5.2.6	Viewing the Current Program Counter Address	228
5.3	Debugging with the Command Line Interface	229
5.3.1	Opening the [Command Line] Window.....	229
5.3.2	Specifying a Command File.....	230
5.3.3	Executing a Command File.....	230
5.3.4	Stopping Command Execution	230
5.3.5	Specifying a Log File.....	230
5.3.6	Starting or Stopping Logging.....	231
5.3.7	Entering a Full Path to the File	231
5.3.8	Pasting a Placeholder	231
5.4	Viewing the Registers	232
5.4.1	Opening the [Register] Window	232
5.4.2	Expanding a Bit Register	232
5.4.3	Choosing a Register to be Displayed	233
5.4.4	Splitting Up the Window Display	233
5.4.5	Modifying Register Contents.....	234
5.4.6	Using Register Contents	234
5.4.7	Saving the Currently Displayed Contents	234
5.5	Operating Memory.....	235
5.5.1	Viewing a Memory Area	235
5.5.2	Displaying Data in Different Formats.....	236
5.5.3	Splitting Up the Window Display	236
5.5.4	Viewing a Different Memory Area.....	237
5.5.5	Modifying the Memory Contents.....	237
5.5.6	Selecting a Memory Range.....	237
5.5.7	Finding a Value in Memory.....	238
5.5.8	Filling a Memory Area with a Value	239
5.5.9	Copying a Memory Area	239
5.5.10	Saving and Verifying a Memory Area.....	240
5.5.11	Disabling Update of the Window Contents	241
5.5.12	Updating the Window Contents.....	241
5.5.13	Comparing the Memory Contents.....	242
5.5.14	Loading a Memory Area from a File	243
5.6	Viewing the I/O Memory.....	244
5.6.1	Opening the [IO] Window	244
5.6.2	Expanding the I/O Register Display	244
5.6.3	Manually loading an IO file.....	245
5.6.4	Modifying the I/O Register Contents.....	245
5.6.5	Saving the Currently Displayed Contents	245
5.7	Viewing the Current Status	246
5.8	Reading and Displaying the Emulator Information Regularly.....	247
5.8.1	Opening the [Extended Monitor] Window	247

5.8.2	Selecting Items to be Displayed	248
5.9	Displaying Memory Contents in Realtime	249
5.9.1	Opening the [Monitor] Window	249
5.9.2	Changing the Monitor Settings	251
5.9.3	Temporarily Stopping Update of the Monitor	251
5.9.4	Deleting the Monitor Settings	251
5.9.5	Monitoring Variables	251
5.9.6	Hiding the [Monitor] Window	252
5.9.7	Managing the [Monitor] Window	252
5.10	Viewing the Labels	254
5.10.1	Listing Labels	254
5.10.2	Adding a Label	255
5.10.3	Editing a Label	255
5.10.4	Deleting a Label	256
5.10.5	Deleting All Labels	256
5.10.6	Loading Labels from a File	257
5.10.7	Saving Labels into a File	257
5.10.8	Searching for a Label	257
5.10.9	Searching for the Next Label	258
5.10.10	Viewing the Source Corresponding to a Label	258
5.11	Executing Your Program	259
5.11.1	Running from Reset	259
5.11.2	Continuing Run	259
5.11.3	Running to the Cursor	259
5.11.4	Running from a Specified Address	260
5.11.5	Single Step	261
5.11.6	Multiple Steps	262
5.12	Stopping Your Program	263
5.12.1	Stopping the Program by the [Halt] Toolbar Button	263
5.12.2	Standard Breakpoints (PC Breakpoints)	263
5.13	Elf/Dwarf2 Support	265
5.13.1	C/C++ Operators	265
5.13.2	C/C++ Expressions	265
5.13.3	Supporting Duplicate Labels	266
5.13.4	Debugging an Overlay Program	267
5.14	Viewing the Variables	269
5.14.1	Tooltip Watch	269
5.14.2	Instant Watch	269
5.14.3	[Watch] Window	270
5.14.4	[Locals] Window	276
5.15	Using the Event Points	277
5.15.1	PC Breakpoints	277
5.15.2	Event Points	277
5.15.3	Event Detection System	277
5.15.4	Signals to Indicate Bus States and Areas	278
5.15.5	Opening the [Event] Window	279
5.15.6	Setting PC Breakpoints	279
5.15.7	Setting Event Points	281
5.15.8	Setting Trigger Points	289
5.15.9	Editing Event Points	290
5.15.10	Modifying Event Points	290
5.15.11	Enabling an Event Point	290
5.15.12	Disabling an Event Point	290

5.15.13	Deleting an Event Point	290
5.15.14	Deleting All Event Points	290
5.15.15	Viewing the Source Line for an Event Point	290
5.16	Viewing the Trace Information	291
5.16.1	Opening the [Trace] Window	291
5.16.2	Acquiring Trace Information	291
5.16.3	Specifying Trace Acquisition Conditions	293
5.16.4	Searching for a Trace Record.....	301
5.16.5	Clearing the Trace Information.....	310
5.16.6	Saving the Trace Information in a File	310
5.16.7	Viewing the [Source] Window	311
5.16.8	Trimming the Source	311
5.16.9	Acquiring a Snapshot of the Trace Information.....	311
5.16.10	Temporarily Stopping Trace Acquisition.....	311
5.16.11	Restarting Trace Acquisition	311
5.16.12	Extracting Records from the Acquired Information	312
5.16.13	Calculating the Difference in Time Stamping	322
5.16.14	Analyzing Statistical Information	323
5.16.15	Extracting Function Calls from the Acquired Trace Information	324
5.17	Viewing the Function Call History	325
5.17.1	Opening the [Stack Trace] Window.....	325
5.17.2	Viewing the Source Program	325
5.17.3	Specifying the View.....	326
5.18	Displaying Memory Contents as an Image	327
5.18.1	Opening the [Image] Window.....	327
5.18.2	Automatically Updating the Window Contents	329
5.18.3	Updating the Window Contents.....	330
5.18.4	Displaying the Pixel Information	330
5.19	Displaying Memory Contents as Waveforms	331
5.19.1	Opening the Waveform View Window.....	331
5.19.2	Automatically Updating the Window Contents	332
5.19.3	Updating the Window Contents.....	332
5.19.4	Zoom-In Display.....	332
5.19.5	Zoom-Out Display	332
5.19.6	Resetting the Zoom Display.....	332
5.19.7	Setting the Zoom Magnification	332
5.19.8	Setting the Horizontal Scale.....	332
5.19.9	Non-Display of Cursor.....	333
5.19.10	Displaying the Sampling Information	333
5.20	Analyzing Performance.....	334
5.20.1	Opening the [Performance Analysis] Window	336
5.20.2	Setting Conditions for Measurement	337
5.20.3	Selecting the Address Detection Mode and Resolution	344
5.20.4	Starting Performance Data Acquisition	344
5.20.5	Deleting a Measurement Condition	344
5.20.6	Deleting All Measurement Conditions	344
5.21	Acquiring Code Coverage.....	344
5.21.1	Opening the [Code Coverage] Window	345
5.21.2	Displaying a Source File.....	349
5.21.3	Changing the Address to be Displayed.....	349
5.21.4	Changing the Coverage Range to be Displayed.....	349
5.21.5	Clearing the Coverage Information.....	350
5.21.6	Saving the Coverage Information to a File	351

5.21.7	Loading Coverage Information from a File	351
5.21.8	Updating Coverage Information	351
5.21.9	Preventing Update of Coverage Information	351
5.21.10	[Confirmation Request] Dialog Box	352
5.21.11	Displaying Code Coverage Information in the [Editor] Window	353
Section 6 Tutorial.....		355
6.1	Introduction.....	355
6.2	Running the HEW.....	356
6.3	Downloading the Tutorial Program	357
6.3.1	Downloading the Tutorial Program.....	357
6.3.2	Displaying the Source Program.....	358
6.4	Setting a PC Breakpoint.....	359
6.5	Setting Registers	360
6.6	Executing the Program.....	361
6.7	Reviewing Breakpoints.....	363
6.8	Referring to Symbols.....	364
6.9	Viewing Memory.....	365
6.10	Watching Variables.....	366
6.11	Displaying Local Variables.....	369
6.12	Stepping Through a Program	370
6.12.1	Executing the [Step In] Command	370
6.12.2	Executing the [Step Out] Command	372
6.12.3	Executing the [Step Over] Command	373
6.13	Forced Breaking of Program Executions	374
6.14	Resetting the MCU	374
6.15	Break Function.....	375
6.15.1	PC Break Function	375
6.15.2	Breaking Execution at Event Points	378
6.16	Trace Functions.....	381
6.16.1	Displaying a Trace (when Time Stamping is not Available)	382
6.16.2	Displaying a Trace (when Time Stamping is Available)	388
6.16.3	Statistics	391
6.16.4	Function Calls	395
6.17	Stack Trace Function	396
6.18	Performance Measurement Function	397
6.18.1	Time Of Specified Range Measurement	397
6.19	Monitor Function	400
6.20	What Next?	404
Section 7 Hardware Specifications Specific to This Product		405
7.1	H8/3160 E6000 Emulator Specifications	405
7.1.1	Supported MCU and User System Interface Cable.....	405
7.1.2	Operating Voltage and Frequency Specifications	405
7.2	User System Interface	406
7.2.1	Signal Protection on the Emulator	406
7.2.2	User System Interface Circuits.....	406
7.3	Differences between MCU and Emulator	408
7.3.1	Registers.....	408
7.3.2	EEPROM	409
7.3.3	WDT	409
7.3.4	Security	409

Section 8	Software Specifications Specific to This Product	411
8.1	Software Specifications of the H8/3160 E6000 Emulator	411
8.1.1	Target Hardware	411
8.1.2	Selectable Platforms.....	411
8.1.3	[Configuration Properties] Dialog Box ([General] Page)	412
8.1.4	Memory Mapping Function	415
8.1.5	[Status] Window	415
8.1.6	Extended Monitor Function	417
8.1.7	Signals to Indicate Bus States and Areas	418
8.1.8	Monitoring Function	418
8.1.9	Trigger Points	418
8.1.10	Trace Information	419
8.1.11	Searching for a Trace Record.....	420
8.1.12	Trace Filtering Function	421
8.2	Note on Usage of the H8/3160 E6000 Emulator.....	422
8.2.1	Environment for Execution of the Tutorial Program	422
Appendix A	Troubleshooting	423
Appendix B	Regular Expressions.....	425
Appendix C	Placeholders	427
C.1	What is a Placeholder?.....	427
C.2	Inserting a Placeholder.....	427
C.3	Available Placeholders.....	429
C.4	Placeholder Tips.....	431
Appendix D	I/O File Format	433
D.1	File format (Bit Field Not Supported).....	433
D.2	File format (Bit Field Supported).....	435
Appendix E	Symbol File Format.....	437
Appendix F	HMAKE User Guide	439
F.1	Command line.....	439
F.1.1	Basic structure.....	439
F.1.2	Exit codes.....	439
F.1.3	Parameters.....	439
F.2	File syntax.....	440
F.2.1	Variable declarations	440
F.3	Description blocks	441
F.3.1	Basic outline	441
F.3.2	Special commands	441
F.3.3	Sub command files.....	442
F.4	Comments	443
F.5	Message commands	443
Appendix G	Menus.....	445
Appendix H	Command Lines	449
Appendix I	Diagnostic Test Procedure.....	453
I.1	System Set-Up for Test Program Execution	453

I.2 Diagnostic Test Procedure Using Test Program454

HEW Part

1. Overview

The functions for HEW version V.3.01.04 are explained in this manual. This chapter describes the fundamental concepts of the High-performance Embedded Workshop. It is intended to give users who are new to Windows® applications, filling in the details that are required by later chapters.

1.1 Workspaces, Projects and Files

Just as a word processor allows you to create and modify documents, the High-performance Embedded Workshop allows you to create and modify workspaces. A workspace can be thought of as a container of projects and, similarly, a project can be thought of as a container of project files. Thus, each workspace contains one or more projects and each project contains one or more files. Figure 1.1 illustrates this graphically.

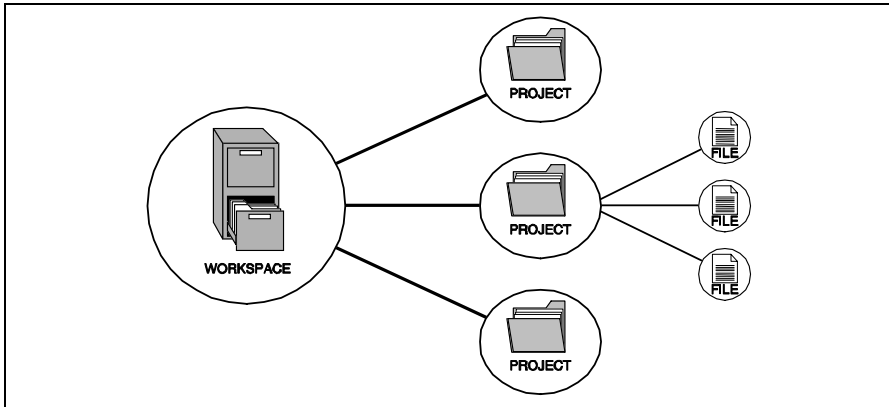

Figure 1.1: Workspaces, Projects and Files

Workspaces allow you to group related projects together. For example, you may have an application that needs to be built for different processors or you may be developing an application and library at the same time. Projects can also be linked hierarchically within a workspace, which means that when one project is built all of its “child” projects are built first.

However, workspaces on their own are not very useful, we need to add a project to a workspace and then add files to that project before we can actually do anything.

1.2 The Main Window

The HEW main window appears as shown in figure 1.2.

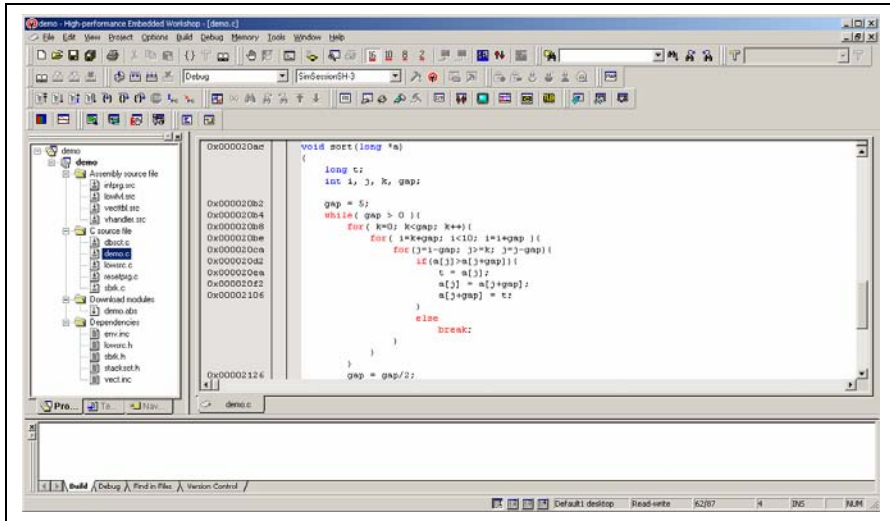

Figure 1.2: HEW Main Window

There are three main windows; the workspace window, the editor window and the output window. The workspace window shows the projects and files which are currently in the workspace, the editor window provides file viewing and editing facilities and the output window shows the results of a various processes (e.g. build, version control commands and so on).

1.2.1 The Title Bar

The title bar displays the name of current activate project and file. It also contains the standard minimize, maximize and close buttons. Click the minimize button to minimize the HEW on the Windows® task bar. Click the maximize button to force HEW to fill the screen. Click the close button to close the HEW (this has the same effect as selecting [File->Exit] or pressing ALT+F4).

1.2.2 The Menu Bar

The menu bar contains eleven menus: File, Edit, View, Project, Options, Build, Debug, Memory, Tools, Window and Help. All of the menu options are grouped logically under these headings. For instance, if you wanted to open a file then the file menu is where you will find the right menu option, if you wanted to set-up a tool then the tools menu is the correct selection. The following sections will cover the functions of the various menu options, as they become relevant. However, at this stage, it is worth taking a few moments to familiarize yourself with the options that each menu provides.

1.2.3 The Toolbars

The toolbars provide a shortcut to the options, which you will use the most often. There are ten default toolbars: Bookmarks, Debug, Debug Run, Editor, Search, Standard, Templates, Version Control, Difference, and Map (as shown in figure 1.3 to 1.12). Toolbars can be created, modified and removed via the [Tools->Customize...] menu option (see chapter 6, “Customizing the Environment”, for further information).

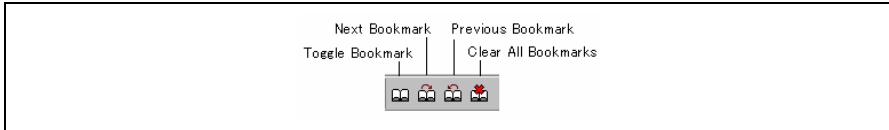

Figure 1.3: Bookmarks Toolbar

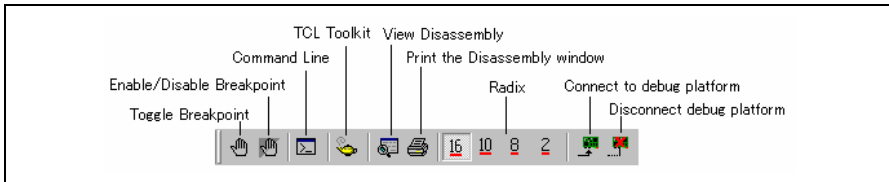

Figure 1.4: Debug Toolbar

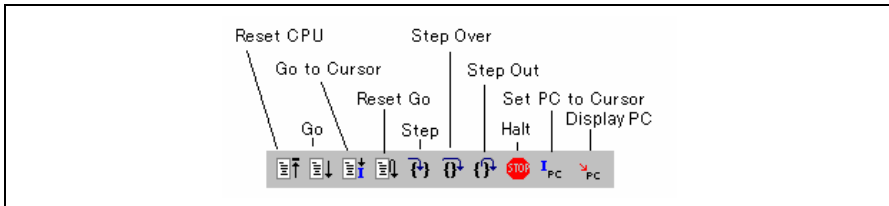

Figure 1.5: Debug Run Toolbar

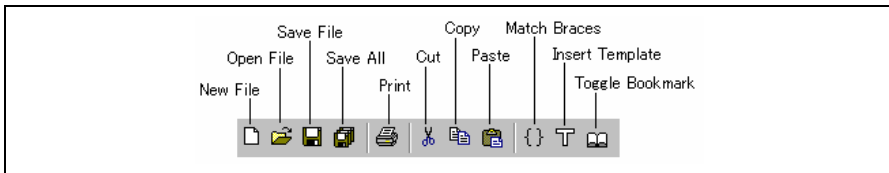

Figure 1.6: Editor Toolbar

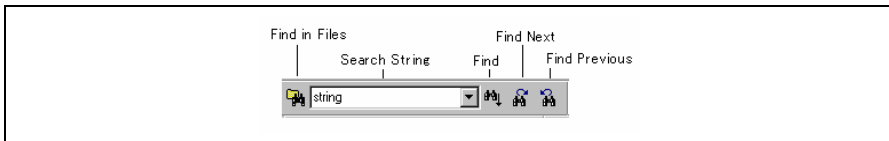

Figure 1.7: Search Toolbar

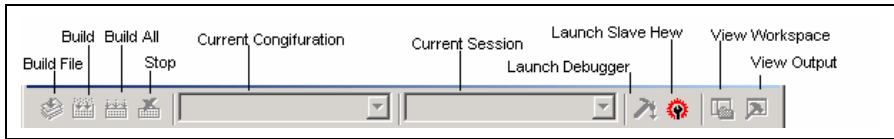

Figure 1.8: Standard Toolbar

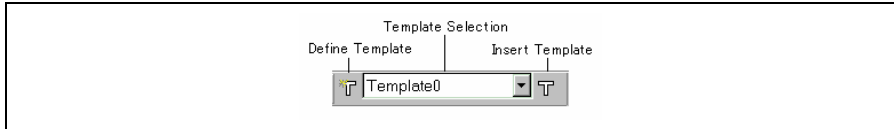

Figure 1.9: Templates Toolbar

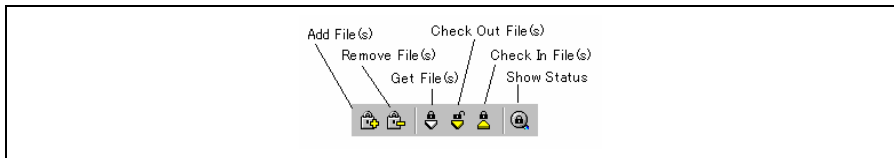

Figure 1.10: Version Control Toolbar

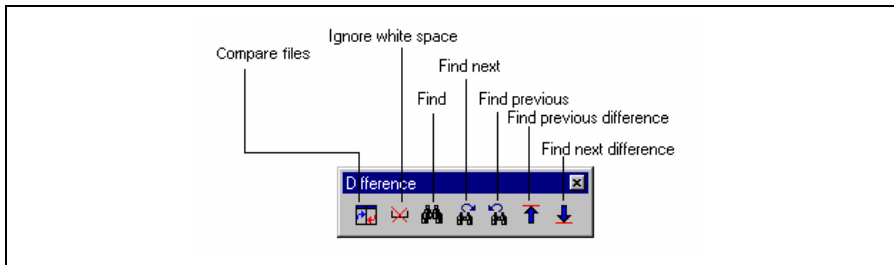

Figure 1.11: Difference Toolbar

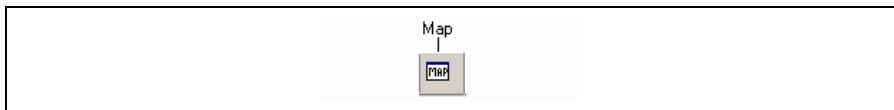

Figure 1.12: Map Toolbar

When the Standard toolbar or a toolbar is docked, it has a control bar as shown in figure 1.13 (i). If you want to move the docked Standard toolbar, click and drag its control bar to the new location. Figure 1.13 (i) shows the Standard toolbar when it is docked and figure 1.13 (ii) shows the Standard toolbar when it is floating.

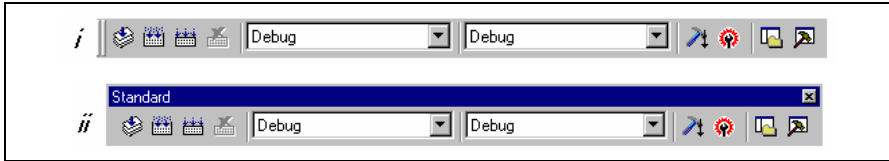

Figure 1.13: Standard Toolbar, Docked and Floating

- To dock a toolbar:
 1. Double-click on the title bar of a floating toolbar.
 - or:
 2. Drag the title bar of a floating toolbar and draw it toward an edge of a docked window, menu bar, toolbar or the HEW main frame, on whose edge you would like to dock the window, until the shape of the floating bar changes.
- To float a toolbar:
 1. Double-click on the control bar of a docked toolbar.
 - or:
 2. Drag the control bar of a docked toolbar and draw it away from the edge of the HEW main frame and from an edge of the other docked windows, toolbar.

1.2.4 The Workspace Window

The “Workspace” window has three panes. The “Projects” tab shows the current workspace, projects and files (figure 1.14). You can quickly open any project file or dependent file by double clicking on its corresponding icon.

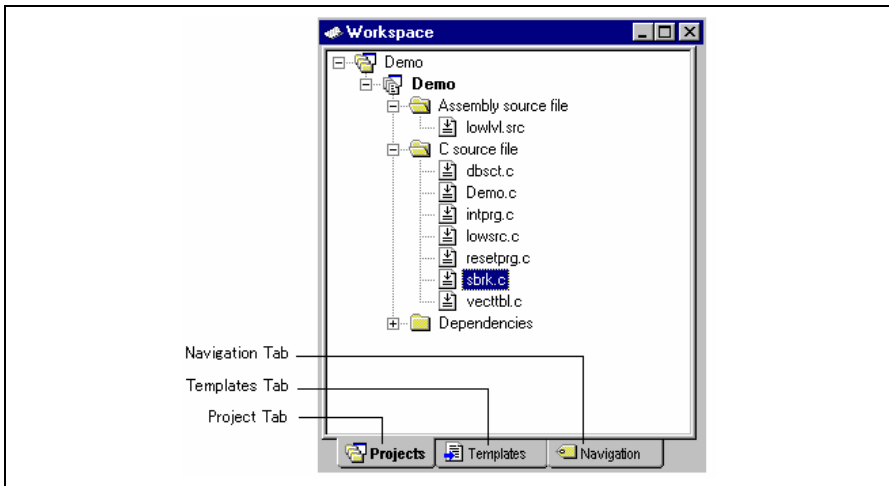

Figure 1.14: Workspace Window Projects Tab

The “Navigation” tab provides jumps to various textual constructs within your project’s files. What is actually displayed within the navigation tab depends upon what components are currently installed. Figure 1.15 shows ANSI C functions. See chapter 2, “Build Basics”, for more information on the “Workspace” window. The “Templates” tab displays template settings. See 4.12, “Templates”, for more information about a template.

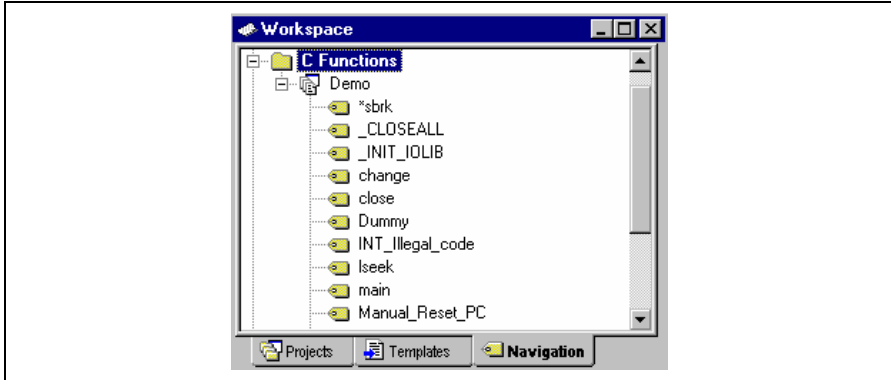

Figure 1.15: Workspace Window Navigation Tab

- To allow the “Workspace” window or the “Output” window docking:
 - Click the right mouse button anywhere inside the “Workspace” window or the “Output” window. Then a pop-up menu will be displayed. If **[Allow Docking]** is checked, docking is allowed; otherwise, docking is not allowed. Select **[Allow Docking]** to check or uncheck it.

When **[Allow Docking]** is checked, you can dock a window to the edge of the HEW main window or to the edge of another docked window. Also if **[Allow Docking]** is checked, you can float them “above” the other HEW windows or outside the HEW main window. Figure 1.16 (i) shows a docked “Workspace” window, and figure 1.16 (ii) shows a floating “Workspace” window.

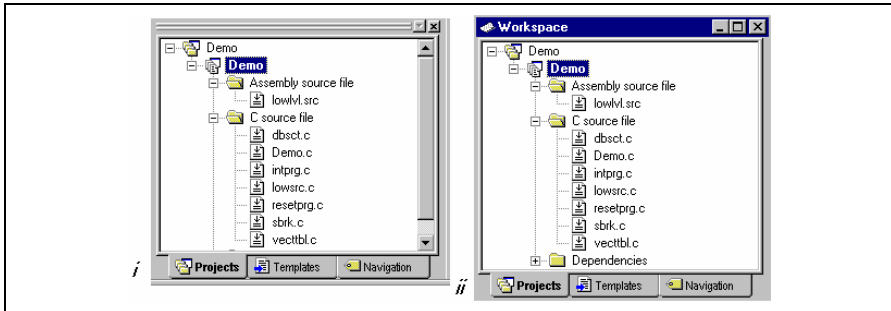

Figure 1.16: Workspace Window, Docked and Floating

When the “Workspace” window or the “Output” window is docked, it has a control bar as shown in figure 1.17. If you want to move a docked window, click and drag its control bar to the new location.



Figure 1.17: Control Bar of Docking Window

- To dock the “Workspace” window or the “Output” window:
[**Allow Docking**] must be checked on the pop-up menu of the window to dock the “Workspace” window or the “Output” window. (The pop-up menu will be displayed when you click the right mouse button anywhere inside the window.) Then you have two ways to dock the window.
 1. Double-click on the control bar of a floating window.or:
 2. Drag the title bar of a floating window and draw it toward an edge of a docked window, menu bar or toolbar, or the HEW main frame, on whose edge you would like to dock the window, until the shape of the floating window changes.

- To float the “Workspace” window or the “Output” window:
[**Allow Docking**] must be checked on the pop-up menu of the window to float the “Workspace” window or the “Output” window. (The pop-up menu will be displayed when you click the right mouse button anywhere inside the window.) Then you have two ways to float the window.
 1. Double-click on the control bar of a docking window.or:
 2. Drag the control bar of a docked window and draw it away from the edge of the HEW main frame and from an edge of the other docked windows, menu bar or toolbar.

- To hide the “Workspace” window or the “Output” window:
Click on the close button, which is located in the top right corner of the window. Or push the right mouse button anywhere inside a floating window and select [**Hide**] on the pop-up menu.

- To display the “Workspace” window or the “Output” window:
Select [**View->Workspace**] or [**View->Output**], respectively.

1.2.5 The Editor Window

The editor window is where you will work with the files of your project. The HEW allows you to have many files open at one time, to switch between them, to arrange them and to edit them in whichever order you want to. By default, the editor window is displayed in a notebook style, where each text file has a separate tab (as shown in figure 1.18).

The editor contains a gutter on the left-hand side of the window. The standard column allows the user to configure the position of bookmarks and software breakpoints quickly and easily.

If you are unsure what purpose a column has or what the information it is displaying is if you place the cursor over the column a tool tip is displayed showing its identity.

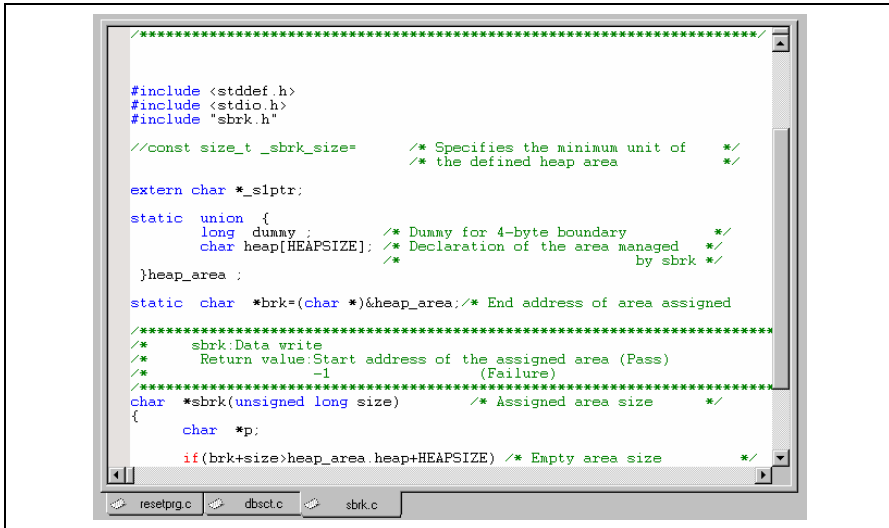

Figure 1.18: Editor Window

The editor window can be customized via the “Format Views” dialog box, which can be invoked via the **[Tools->Format Views...]** menu option. This dialog allows you to configure fonts, colors, tabs and so on for the editor window. It also allows the user to change the look of other views, which have been installed by HEW. If you would prefer to use your favorite editor rather than the HEW internal editor then specify your alternative in the “Options” dialog box, which can be invoked via the **[Tools->Option...]** menu option. For further details on how to use and configure the editor, refer to chapter 4, “Using the Editor”.

1.2.6 The Output Window

The “Output” window by default has four tabs on display. The “Build” tab shows the output from any build process (e.g. compiler, assembler and so on). If an error is encountered in a source file then the error will be displayed in the build tab along with the source file name and line number. To quickly locate a problem, double click on the error to jump to the source file and line.

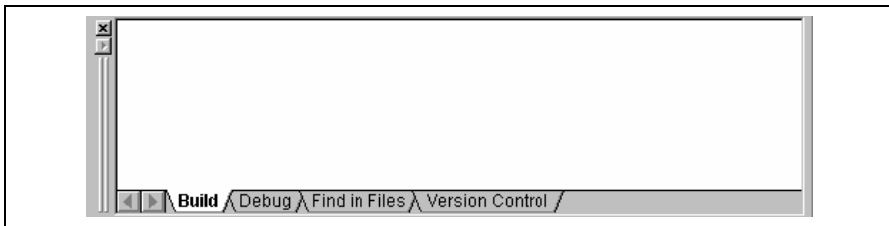

Figure 1.19: Output Window

The “Debug” tab shows the output from any debugger process. Any debug component that needs to display information will send its output to this window.

The “Find in Files” tab displays the results of the last “Find in Files” action. To activate find in files, select the **[Edit->Find in Files...]** menu option, the toolbar button. For further details on how to use find in files, refer to chapter 4, “Using the Editor”.

The “Version Control” tab displays the results of version control actions. The tab is only displayed if a version control system is in use. For further details on version control, refer to chapter 7, “Version Control”.

1.2.7 The Status Bar

The status bar displays information as to the current state of the HEW. Figure 1.20 shows the eight sections of the status bar.

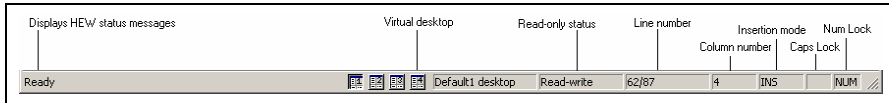

Figure 1.20: Status Bar

1.3 The Help System

The help menu is the rightmost menu on the HEW menu bar. It contains the menu option “Contents” which, when selected, takes you to the main HEW help window.

To obtain help on specific dialogs click on the context sensitive help button, which is located in the top right-hand corner of each dialog box (as shown in figure 1.21).

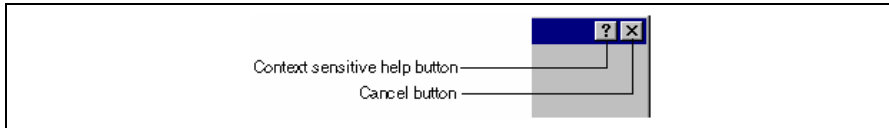

Figure 1.21: Help Button

When this is clicked, the mouse pointer will change to a pointer with a question mark above it. Whilst the mouse pointer is in this state, click on the part of the dialog box that you require assistance on.

Alternatively, select the control that you require help for and then press the **F1** key.

1.4 Launching the HEW

To run the HEW, open the “Start” menu of Windows®, select “Programs”, select “Renesas High-performance Embedded Workshop” and then select the shortcut of the HEW. By default, the “Welcome!” dialog box shown in figure 1.22 will be displayed.

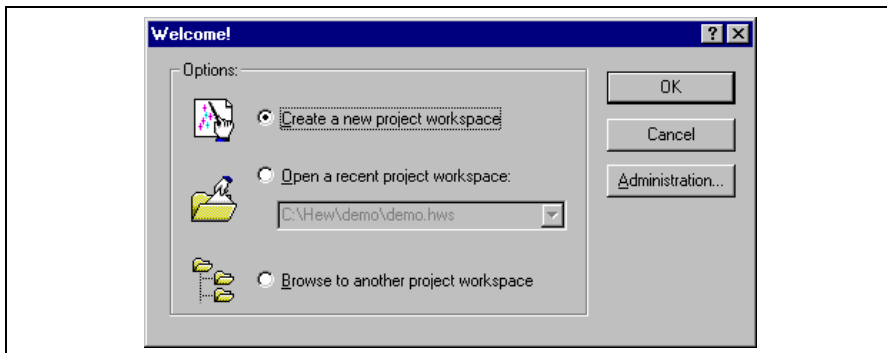

Figure 1.22: Welcome! Dialog

To create a new workspace, select “Create a new project workspace”, and click “OK”. To open one of recent project workspaces, select “Open a recent project workspace”, select a workspace from the drop-down list, and click “OK”. The recent project workspace list displays the same information as that seen in the workspace most recently used file list. This list appears on the file menu. To open a workspace by specifying a workspace file (.HWS file), select “Browse to another project workspace”, and click “OK”. To register a tool to or unregister a tool from the HEW, click the “Administration...” button (see chapter 5, “*Tool Administration*” for details). Click the “Cancel” button to use the HEW without opening a workspace.

1.5 Exiting the HEW

The HEW can be exited by selecting [File->Exit], pressing ALT+F4 or by selecting the close option from the system menu. (To open the system menu, click the icon at the upper-left corner of the HEW title bar.) If a workspace is open then the same workspace closedown procedure is followed as described in the previous section.

1.6 Component System Overview

The HEW allows the user to extend the HEW functionality by adding additional components to the system. This is achieved by registering the component in the Tools Administration dialog box. These components can add windows, menus and toolbars to the HEW system. Examples of the components are the debugger and builder components of HEW. The debugger component adds all of the menus and toolbars associated with the debugger and the builder component does the same for the build functionality. The components you have registered in the system will modify the look and feel of HEW. In some cases you may not have some of the menus which you can see in this manual. For instance if the debugger component is not installed you will not have the “Debug” menu in the HEW main window.

2. Build Basics

This chapter explains the general basic functions of the HEW whilst the more advanced features can be found in chapter 3, “*Advanced Build Features*”.

2.1 The Build Process

The typical build process is outlined in figure 2.1. This may not be the exact build process, which your installation of HEW will use as it depends upon the tools that were provided with your installation of HEW (e.g. you may not have a compiler for instance). In any case, the principles are the same - each step or phase of the build takes a set of project files and then builds them, if all succeeds then the next step or phase is executed.

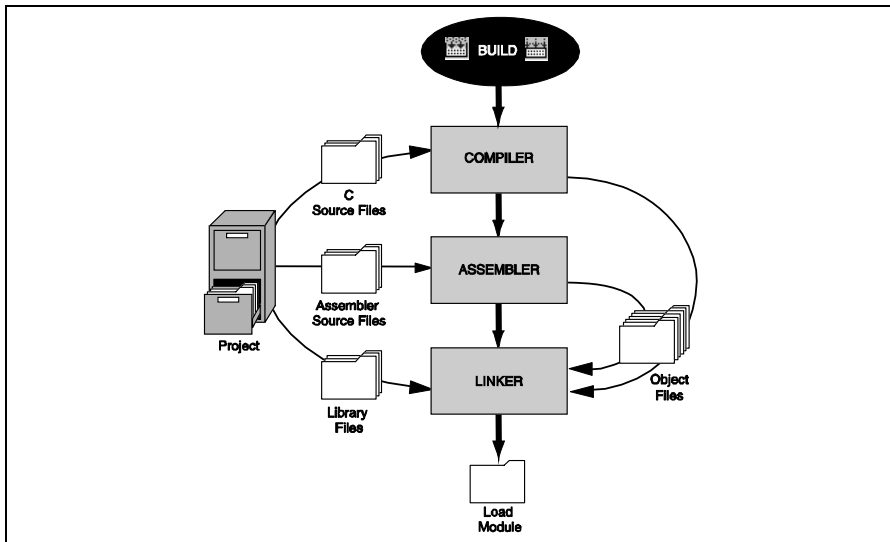

Figure 2.1: Typical Build Process

In the example shown in figure 2.1 the compiler is the first phase, the assembler is the second phase and the linker is the third and final phase. During the compiler phase, the C/C++ source files from the project are compiled in turn, during the assembler phase, the assembler source files are assembled in turn. During the linker phase all library files and output files from the compiler and assembler phases are linked together to produce the load module. This module can then be downloaded and used by the debugger functionality in HEW.

The build process can be customized in several ways. For instance, you can add your own phase, disable a phase, delete phases and so forth. These advanced build issues are left to chapter 3, “*Advanced Build Features*”. In this chapter, only the general principles and basic features will be detailed.

2.2 Project Files

In order for the HEW to be able to build your application, you must first tell it, which files should be in the project, and how each file should be built (figure 2.2).

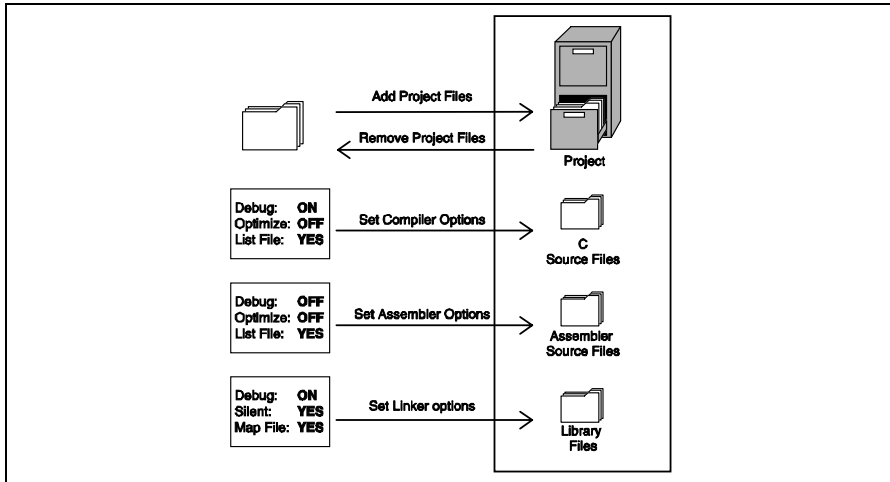

Figure 2.2: Editing a Project

2.2.1 Adding Files to a Project

Before you can build your application you must first inform the High-performance Embedded Workshop, which files it is composed of.

☞ To add a files to a project:

1. Select [**Project->Add Files...**], or click the right mouse button on a project icon in the “Projects” tab of the “Workspace” window and select [**Add Files...**] from the pop-up menu (see figure 2.3), or press **INS** when the “Workspace” window is selected.

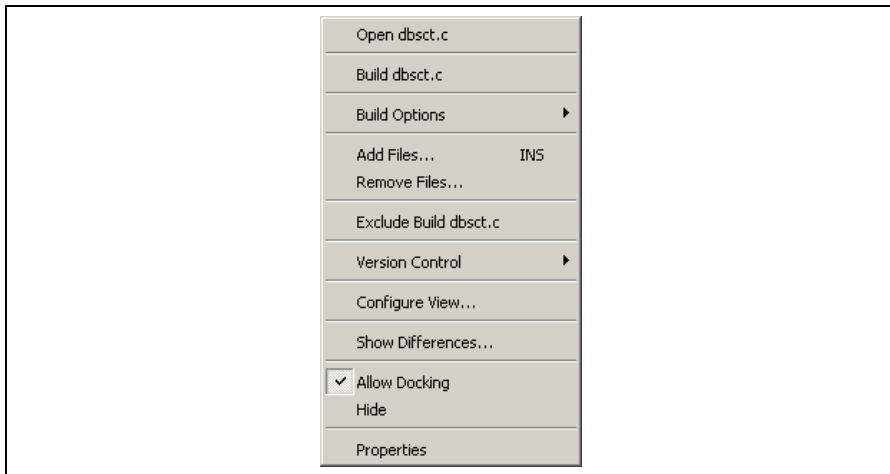

Figure 2.3: Projects Tab Pop-up Menu

2. The “Add” dialog will be displayed.
3. Select the file(s), that you want to add and then click “Add”.

There are a number of other ways to add new files to the project. These are described below:

- Clicking right button on an open file in the editor window displays a pop-up menu option (figure 2.4). If the file is already in the project then the “Add File to Project” menu option is disabled. Selecting the “Add File to Project” then adds the file to the current project.

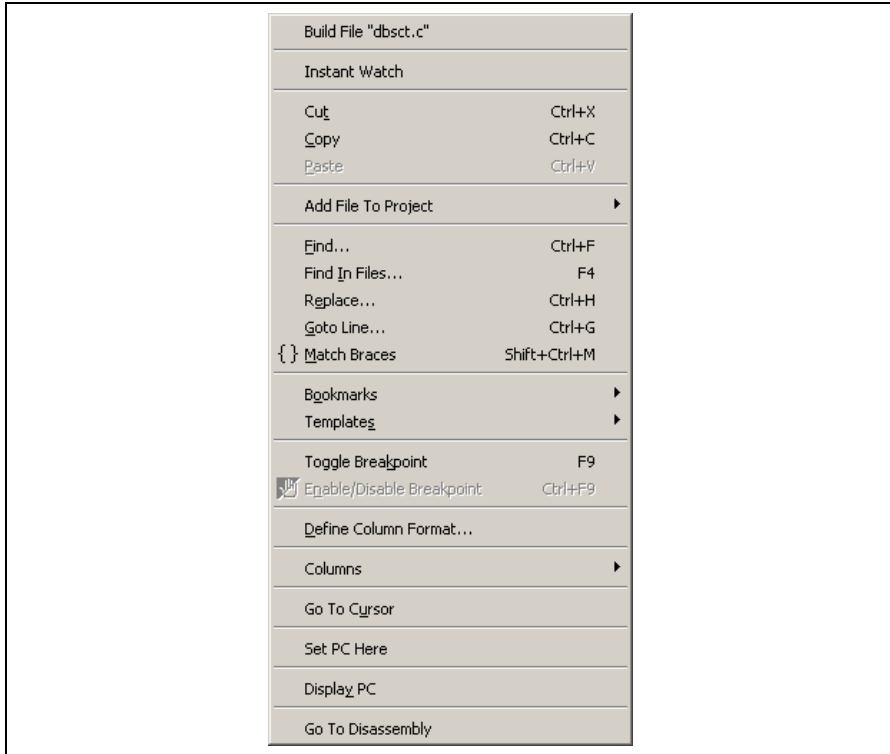

Figure 2.4: Editor Window Pop-up Menu

- In the HEW it is also possible to “Drag and Drop” files from Windows® Explorer onto the workspace window. These files will be automatically added to the project and are displayed in the folder in which they were dragged to.

Note: If you add a file to a project when it is an unrecognized file type then it will still be added to the project. Certain functions will be disabled with reference to this file. When this file is double clicked in the workspace window instead of opening the file in the editor the open operation is passed to Windows® operating system. The default open operation is then carried out as if the file was opened in Windows® Explorer. To view the current defined extensions use the “File Extensions” dialog (see the section on file extensions later in this chapter).

2.2.2 Removing Files from a Project

Files can be individually removed from a project, selections of files can be removed or all files can be removed.

☞ To remove files from a project:

1. Select [**Project->Remove Files...**], or click the right mouse button on a project icon in the “Projects” tab of the “Workspace” window and select [**Remove Files...**] from the pop-up menu (see figure 2.5). The “Remove Project Files” dialog will be displayed (figure 2.6).

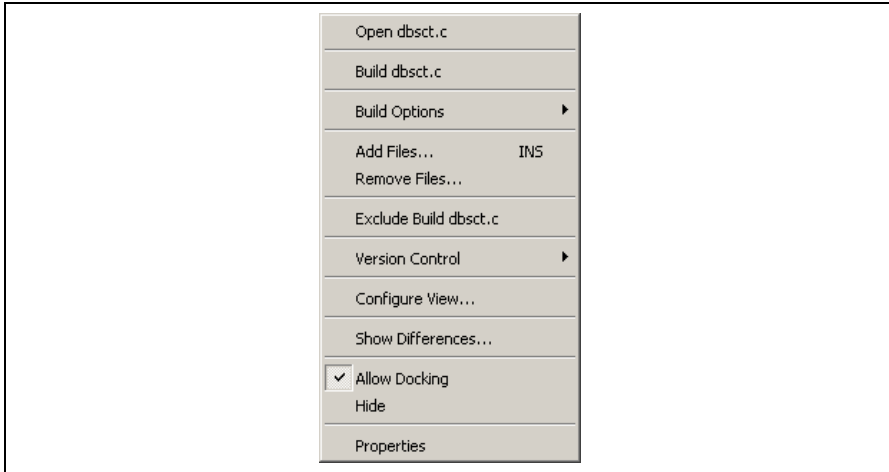

Figure 2.5: Projects Tab Pop-up Menu

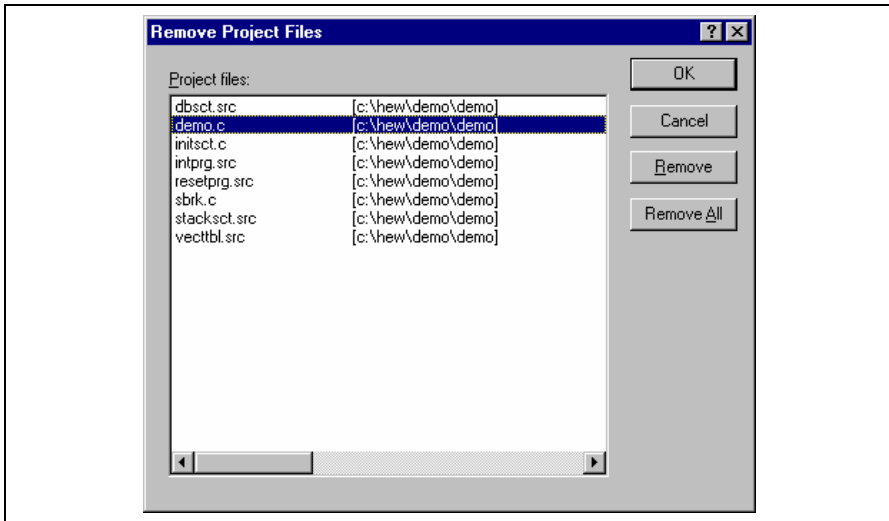

Figure 2.6: Remove Project Files Dialog

2. Select the file or files which you want to remove from the “Project files” list.
 3. Click the “Remove” button to remove the selected files or click “Remove All” to remove all project files.
 4. Click “OK” to remove the files from the project.
- ☞ To remove selected files from a project:
1. Select the files, which you want to remove, in the “Projects” tab of the “Workspace” window. Multiple files can be selected by holding down the **SHIFT** or **CTRL** key.
 2. Press the **DEL** key. The files will be removed.

2.2.3 Excluding a Project File from Build

A file in a project can be individually excluded from build on a configuration by configuration basis.

- ☞ To exclude a file in a project from build:
1. Push the right mouse button on a file, which you want to be excluded from build, in the “Projects” tab of the “Workspace” window.
 2. Select [**Exclude Build file**], where <file> is the selected file, from the pop-up menu (figure 2.5). Then a red cross will be put on the file’s icon, and the file will be excluded from build.

2.2.4 Including a Project File in Build

An excluded file can be included in the project again.

- ☞ To include a file which has been excluded from build:
1. Push the right mouse button on a file, which has been excluded from build, on the “Projects” tab of the “Workspace” window.
 2. Select [**Include Build file**], where <file> is the selected file, from the pop-up menu. Then a red cross will be removed from the file’s icon, and the file will be included in build.

2.3 File Extensions and File Groups

The HEW can identify files by their extension. The system defines certain extensions depending upon the tools, which are being used. For example, if you are using a compiler then the .c extension will be in the “C source file” group and be used as input to the compiler phase (figure 2.1, Typical Build Process). Additionally, the HEW allows you to define your own extensions. For example, if the project you are developing uses assembler source files the default extension may be .src. If you would like to use a different extension instead of .src (e.g. .asm) then you can define a new extension and request that the HEW treats it in the same way as a .src file.

File extensions and file groups can be viewed and modified via the “File Extensions” dialog (figure 2.7). This is invoked by selecting [Project->File Extensions...]. This dialog displays all of the extensions and file groups, which are defined within the current workspace.

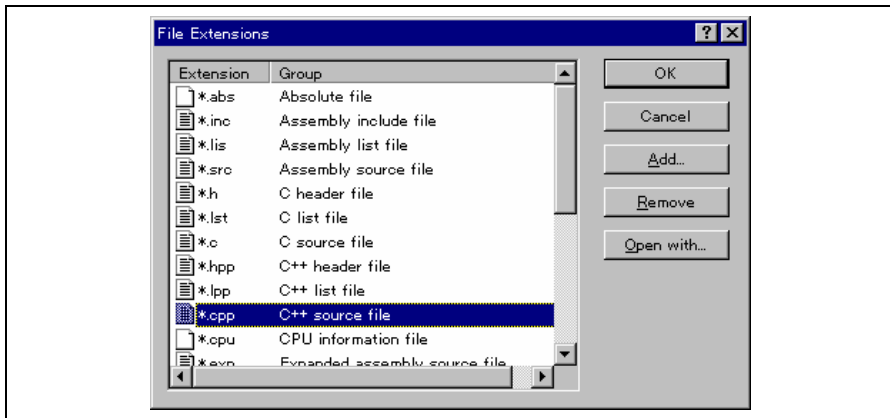

Figure 2.7: File Extensions Dialog

The “File Extensions” list shown in figure 2.7 is divided into two columns. On the left are the file extensions themselves, whilst on the right are the file groups. Many file extensions can belong to the same group. For example, assembler source files may have several extensions in a single project (e.g. .src, .asm, .mar etc) as shown in figure 2.8.

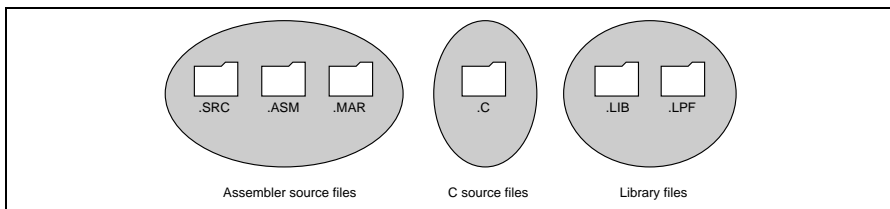

Figure 2.8: File Extensions and Groups

When creating a new extension you should consider whether the extension belongs to a group, which is already defined, or whether you need to create a new file group. If you are adding a completely new type of file then you will want to create a new file group. This process is described below.

- ☞ To create a new file extension in a new file group:
1. Select [**Project->File Extensions...**] from the menu bar. The “File Extensions” dialog will be displayed (figure 2.7).
 2. Click the “Add...” button. The “Add File Extension” dialog will be displayed (figure 2.9).
 3. Enter the extension, which you want to define into the “File extension” field. It is not necessary to type the dot (.) character. The drop list contains all extensions that are undefined in the current project. Selecting one of these extensions will add the text to the file extension field automatically.
 4. Select the “Extension belongs to a new group” option and enter a description, which defines this new file group.
 5. At this stage it is possible to change the associated application. There are four available choices in the “Open” with drop list. These are listed below:
 - Editor
 - None
 - Other
 - Windows default

If the editor is selected, the open file function in the workspace window causes the file to be opened in the HEW editor. If none is selected then the open operation is disabled when the open file function is attempted. Selecting “Other” allows you to configure another tool for the open file operation. See “*To associate an application with a file group*” for more details. If the “Windows default” option is selected then the open file function in the workspace window passes the open file to the Windows operating system. This then selects the default behavior for this file extension as defined in Windows® Explorer.
 6. Click “OK” to add the extension to the “File Extensions” list.

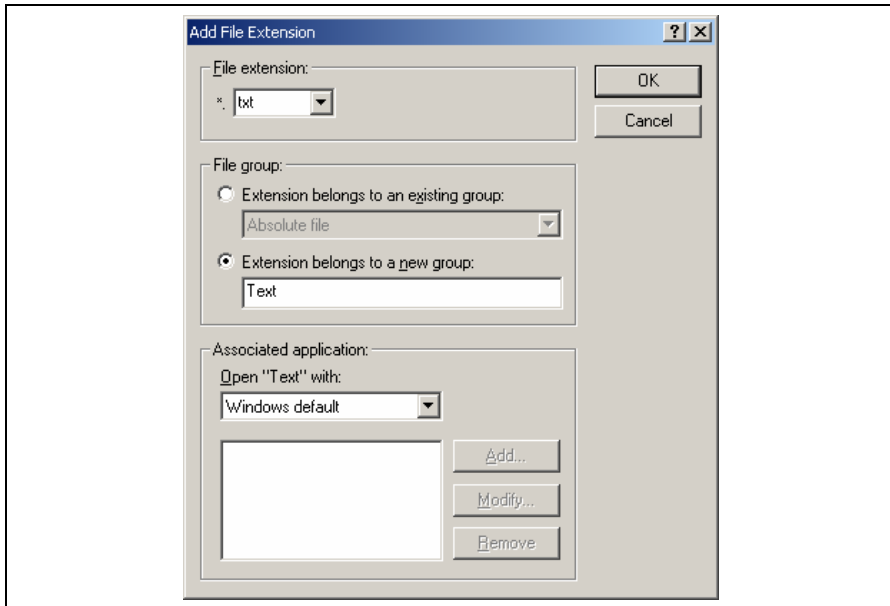

Figure 2.9: Add File Extension Dialog (New Group)

If you want to create a new extension because your project uses a different extension from those accepted by the HEW. For example, a phase might by default use the extension .asm but the HEW only recognizes .src. Then you need to create a new extension and add it to an existing file group. This process is described below.

➡ To create a new file extension in an existing file group:

1. Select [**Project->File Extensions...**] from the menu bar. The “File Extensions” dialog will be displayed (figure 2.7).
2. Click the “Add...” button. The “Add File Extension” dialog will be displayed (figure 2.10).
3. Enter the extension, which you want to define into the “File extension” field. It is not necessary to type the period (.) character. The drop list contains all extensions that are undefined in the current project. Selecting one of these extensions will add the text to the file extension field automatically.
4. Select the “Extension belongs to an existing group” option and select which group you would like to add this new extension.
5. Click “OK” to add the extension to the “File Extensions” list.

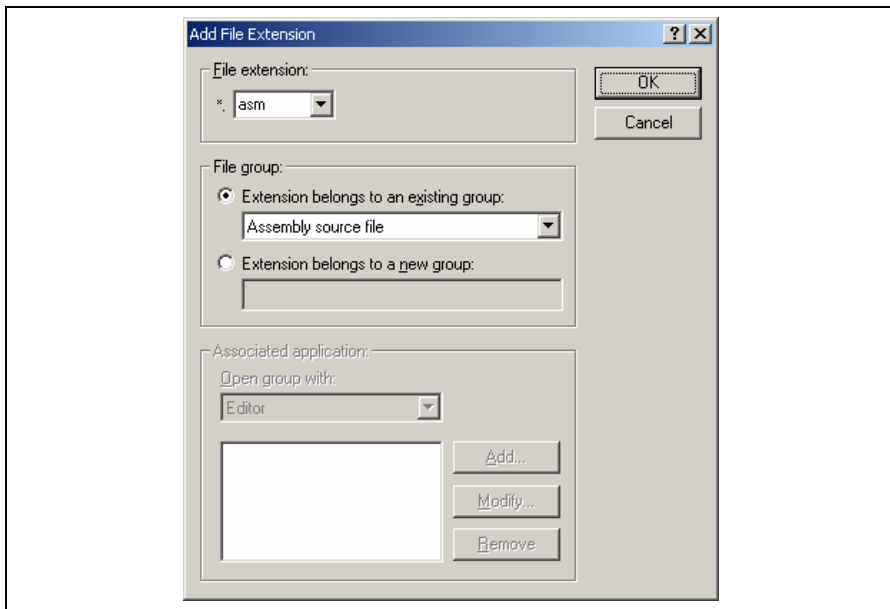

Figure 2.10: Add File Extension Dialog (Existing Group)

In addition to opening a file with the editor, the “File Extensions” dialog allows you to associate any application with any file group so that when you double click on a file in the “Projects” tab of the “Workspace” then the appropriate application is launched with the file. Figure 2.11 shows the association between a word processor and the extension .DOC.

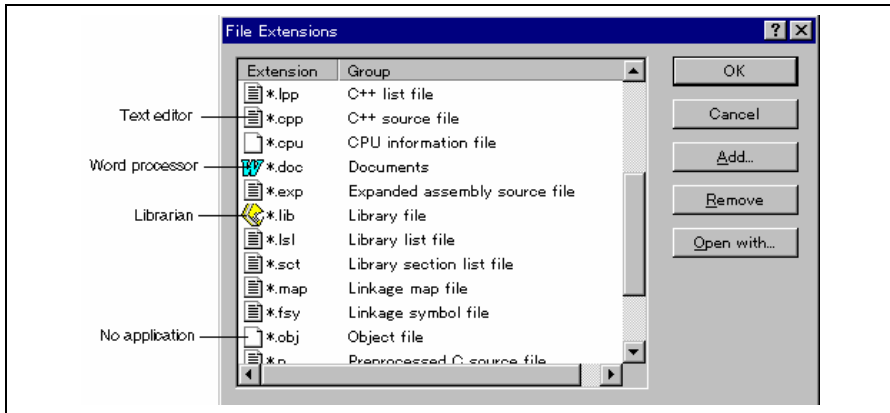

Figure 2.11: File Groups and Applications

- To associate an application with a file group:
 1. Select the file group to be associated from the “File Extensions” dialog (figure 2.11).
 2. Click the “Open with...” button. The “Modify File Extension” dialog will be displayed (figure 2.12).

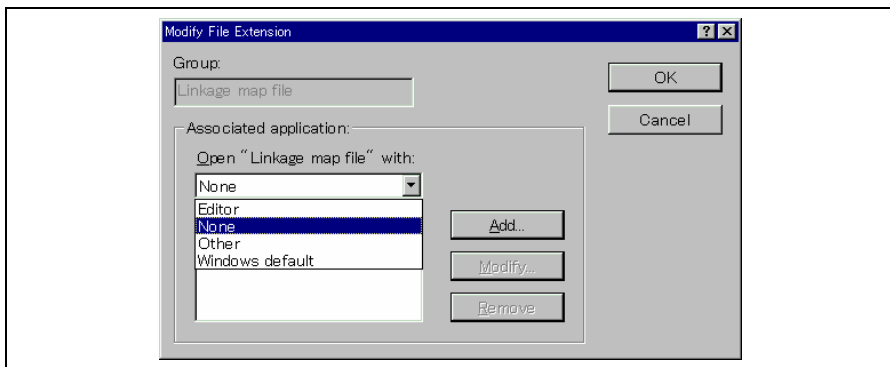

Figure 2.12: Modify File Extension Dialog

3. Select “None” to remove any association, select “Editor” to open this type of file in the internal/external editor or select “Other” if you want to open this type of file with a specific application.

If you select “Other” then you can select from any previously defined application from the drop-down list or specify a new application.

Click “Add...” to define a new application. The “Add Application” dialog will be displayed (figure 2.13). Enter the name of the tool into the “Name” field. Enter the full path to the tool in the “Command” field (do not include any parameters). Enter the parameters that are required to open a file in the “Parameters” field. Be sure to use the \$(FULLFILE) placeholder to specify the location file (see appendix C, “Placeholders”, for more information on placeholders and their uses). Enter the initial directory, in which you would like the application to run, into the “Initial directory” field. Click “OK” to create the application.

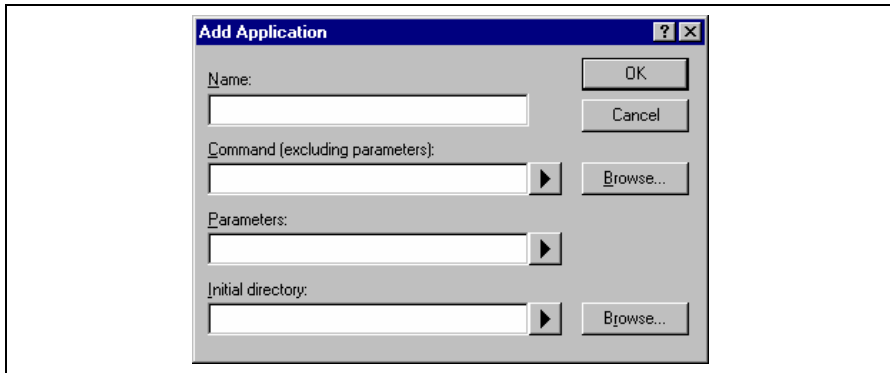

Figure 2.13: Add Application Dialog

Click “Modify...” to modify an application. The “Modify Application” dialog will be displayed. This dialog is the same as the “Add Application” dialog described above except that the “Name” field is read only. Modify the settings as desired and then click “OK”.

4. Click “OK” to set the application for the selected file group.

2.4 Specifying How to Build a File

Once you have added the necessary files to the project the next step is to instruct the HEW on how to build each file. To do this, you will need to select a menu option from the “Options” menu. The contents of this menu depend upon which tools you are using.

- To set options for a build phase:
 1. Select the options menu and find the phase whose options you would like to modify. Select this option.
 2. A dialog will be invoked which allows you to specify the options.
 3. After making your selections, click “OK” to set them.

To obtain further information, use the context sensitive help button or select the area in which you need assistance and then press **F1**.

2.5 Build Configurations

The HEW allows you to store all of your build options into a build configuration (figure 2.14). This means that you can “freeze” all of the options and give them a name. Later on, you can select that configuration and all of the options for all of the build phases will be restored. These build configurations also allow the user to specify debugger settings for a build configuration. This means that each configuration can be targeted at a different end platform. (See Emulator Debugger Part in this manual, for further information).

Figure 2.14 shows three build configurations; “Default”, “MyDebug” and “MyOptimized”. In the first configuration, “Default”, each of the phases (compile and assemble) are set to their standard settings. In the second configuration, “MyDebug”, each of the files are being built with debug information switched on. In the third configuration, “MyOptimized”, each of the files are being built with optimization on full and without any debug information. The developer of this project can select any of those configurations and build them without having to return to the options dialogs to set them again.

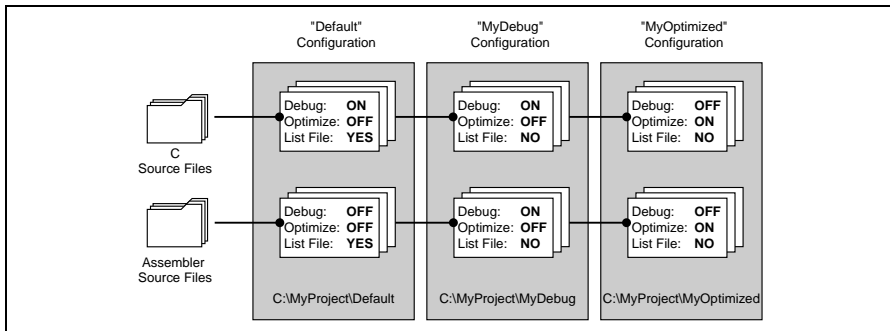

Figure 2.14: Configurations and File Options

2.5.1 Selecting a Configuration

The current configuration can be selected in two ways:

Either:

1. Select it from the drop down list box (figure 2.15) in the toolbar.
2. The configuration is selected.

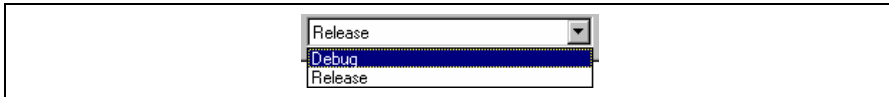

Figure 2.15: Toolbar Selection

or:

1. Select [Options->Build Configurations...]. This will invoke the “Build Configurations” Dialog (figure 2.16).

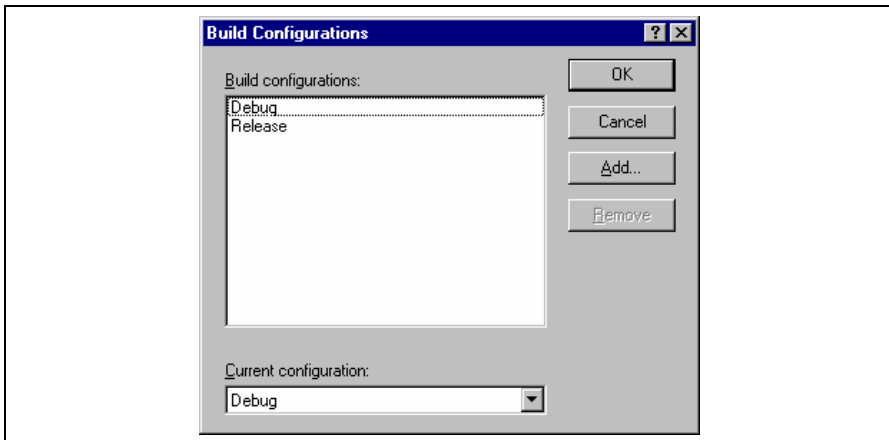

Figure 2.16: Build Configurations Dialog

2. Select the configuration that you want to use from the “Current configuration” drop down list.
3. Click “OK” to set the configuration.

2.5.2 Adding and Deleting Configurations

You can add a new configuration by copying settings from another configuration or delete a configuration. These three tasks are described below.

☞ To add a new configuration:

1. Select [**Options->Build Configurations...**] to display the “Build Configurations” dialog (figure 2.16).
2. Click the “Add...” button. The “Add Configuration” dialog will be invoked (figure 2.17).

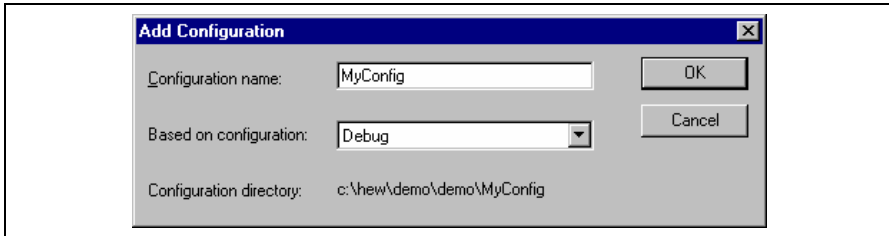

Figure 2.17: Add Configuration Dialog

3. Enter the new configuration name into the “Configuration name” field. As you enter the new configuration name, the directory underneath changes to reflect the configuration directory that will be used. Select one of existing configurations, from which you want to copy a configuration, out of the drop-down list of the “Based on configuration” field. Click “OK” on both dialogs to create the new configuration.
- ☞ To remove a configuration:
1. Select [**Options->Build Configurations...**] to display the “Build Configurations” dialog (figure 2.16).
 2. Select the configuration that you want to remove and then click the “Remove” button.
 3. Click “OK” to close the “Build Configurations” dialog.

2.6 Building a Project

The outline of the build process is shown in figure 2.1.

2.6.1 Building a Project

The build option only compiles or assembles those files that have changed since the last build. Additionally, it will rebuild source files if they depend upon a file that has changed since the last build. For instance, if the file “test.c” #include’s the file “header.h” and the latter has changed since the last build, the file “test.c” will be recompiled.

☞ To perform a build:

Select [**Build->Build**] or click the build toolbar button  or press **F7** or click the right mouse button on a project icon in the “Projects” tab of the “Workspace” window and select [**Build**] from the pop-up menu.

The build all option compiles and assembles all source files, irrespective of whether they have been modified or not, and links all of the new object files produced.

☞ To perform a build all:

Select [**Build->Build All**], or click the build all toolbar button , or click the right mouse button on a project icon in the “Projects” tab of the “Workspace” window and select [**Build All**] from the pop-up menu.

2.6.2 Building Individual Files

The High-performance Embedded Workshop lets you build project files individually.

☞ To build an individual file:

1. Select the file which you want to build from the project window.
2. Select [**Build->Build File**], click the build file toolbar button  or press **CTRL+F7** or click the right mouse button on a file icon in the “Projects” tab of the “Workspace” window and select [**Build <file>**] from the pop-up menu.

2.6.3 Stopping a Build

The High-performance Embedded Workshop allows you to halt the build process.

- ☞ To stop a build:
 1. Select [**Build->Stop Build**] or click the stop build toolbar button (🛑). The build will stop after the current file has been built.
 2. Wait until the message “Compiler Finished” appears in the “Output” window before continuing.
- ☞ To forcibly terminate a current tool
 1. Select [**Build->Terminate Current Tool**]. The HEW will attempt to stop the tool immediately.

Note: Do NOT assume that any output from the tool you terminated is valid. It is recommended that you delete any output files produced and ensure that the phase is executed again.

2.6.4 Building Multiple Projects

The High-performance Embedded Workshop lets you build multiple projects and configurations at once.

- ☞ To build multiple projects:
 1. Select [**Build->Build Multiple**]. The figure displayed in figure 2.18.
 2. The build multiple gives you the choice of which projects and configurations should be built. To select which projects and configurations need to be built select the check box next to the project – configuration combination you want to build. For example, in figure 2.18 if you wanted to build the entire “hewtest2” project you would check the “hewtest2-Debug” and the “hewtest2-Release” selections and leave all other check boxes unchecked.
 3. When you are happy with your chosen selection click the build button and the HEW will then build the projects and configurations you have chosen.
 4. If you want to build all the projects, which you choose, you click the build all button.
 5. Results from the build are displayed in the build window in the same way as the normal build process.

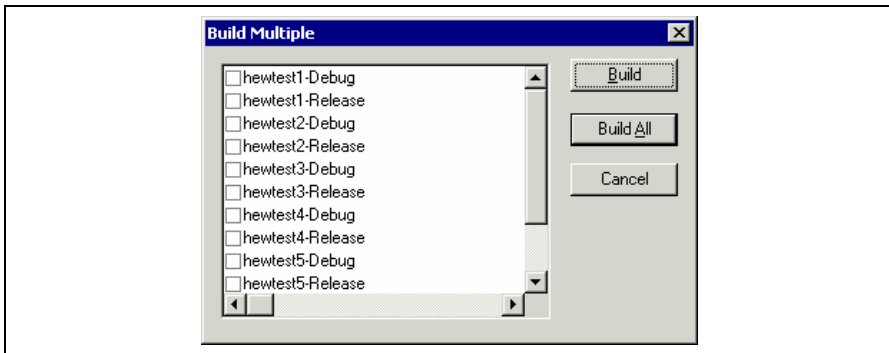

Figure 2.18: Build Multiple Dialog

2.6.5 The Output Window

When a tool executes (i.e. compiler, assembler, linker etc.) its output is displayed in the “Output” window. If any of the tools produce any errors or warnings then they are displayed along with the source file name and the line number at which the error is located. To quickly locate a specific bug, double click on a given error/warning to invoke the current editor.

2.6.6 Controlling the Content of the Output Window

It is often useful to display extra information (such as the command line options that are being applied to a file) during a build. The HEW allows you to specify whether or not you want such options displayed in the “Output” window during a build, build all or build file operation via the “Tools Options” dialog.

- To view or hide extra information during a build:
 1. Select [**Tools->Options...**]. The “Options” dialog will be displayed.
 2. Select the “Build” tab (figure 2.19).
 3. Set the three check boxes in the “Show” group as follows. “Command line” controls whether the command line is shown as each tool is executed. “Environment” controls whether the environment is shown as each tool is executed. “Initial directory” controls whether the current directory is shown as each tool is executed.

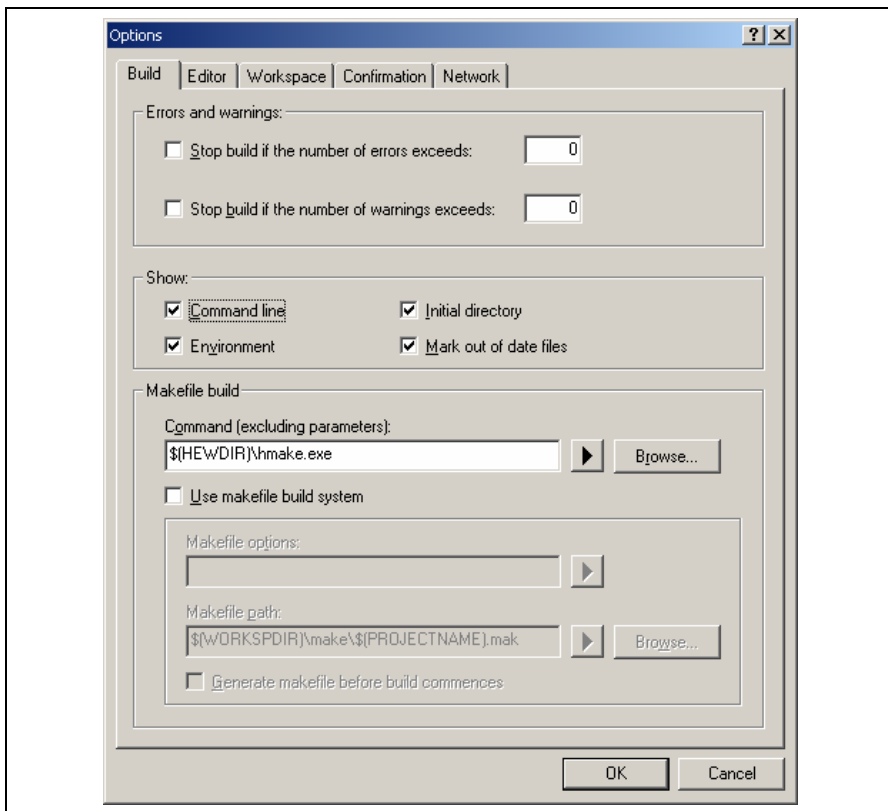

Figure 2.19: Options Dialog Build Tab

2.6.7 Displaying out of date files in the workspace window

Files updated later than the file generated by the previous build (i.e. out of date files) are marked in the workspace window. In figure 2.20 below, file "demo.c" is out of date.

When you click build next time this file will be re-built. This is also displayed for dependent projects of the current project.

The view of these files is updated whenever something that affects the build occurs, e.g. options changing, file addition, dependencies changing, files modified, etc.

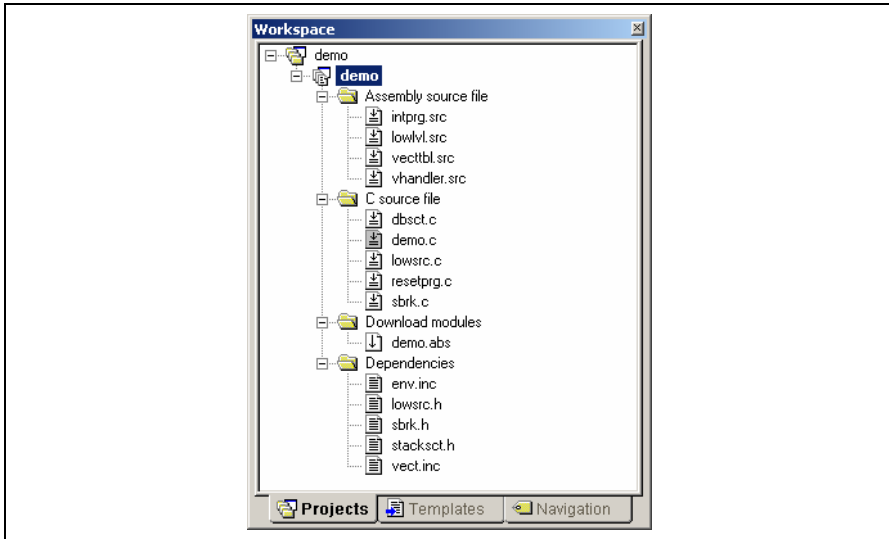

Figure 2.20: Displaying out of date files

- To display out of date files in the workspace window:
 1. Select [Tools->Options...]. The "Options" dialog will be displayed.
 2. Select the "Build" tab (figure 2.19).
 3. Check the "Mark out of date files" check box.
 4. Click OK.

2.7 File Dependencies

A typical project will contain dependencies between files, for example, one C file may “#include” one or more header files. In complex projects, source files will include (or depend upon) others and this can quickly become difficult to manage. However, the HEW provides a dependency scanning mechanism whereby all files in a project are checked for dependencies. Once complete, the project window will display an up-to-date list with all the project file dependencies.

☞ To update a project’s dependencies:

Select [**Build->Update All Dependencies**] or click the right mouse button on a project icon in the “Projects” tab of the “Workspace” window and select [**Update All Dependencies**] from the pop-up menu.

Initially, the dependencies for all files are contained within the “Dependencies” folder (figure 2.21.i).

2.8 Configuring the Workspace Window

If you click the right mouse button anywhere inside the “Projects” tab of the “Workspace” window, a pop-up menu will be invoked. Select the “Configure View...” menu option to modify the way in which information is displayed. The following four sections detail the effect of each option on the “Configure View” dialog.

2.8.1 Show Dependencies under Each File

If you select “Show dependencies under each file”, the dependent files are shown under the including source file as a flat structure, i.e. the files themselves become folders (figure 2.21.ii). If this option is not selected then a separate folder contains all dependencies (figure 2.21.i).

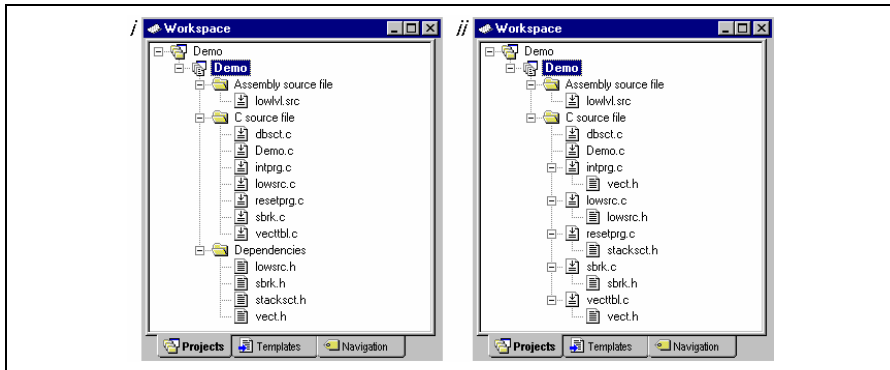

Figure 2.21: Dependencies under Each File

2.8.2 Show Standard Library Includes

By default, any dependent files found in standard include paths will not be shown (figure 2.22.i). For example, in C code, if you write an include statement such as “#include <stdio.h>” then `stdio.h` will not be listed as a dependent file. To view such system include files, select the “Show standard library includes” option (figure 2.22.ii).

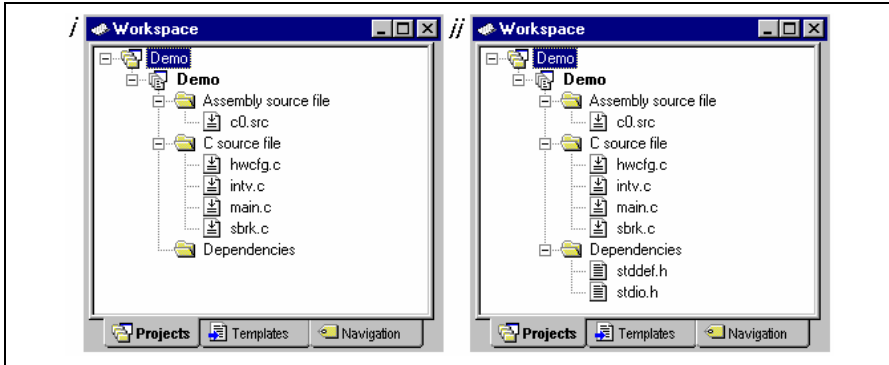

Figure 2.22: Standard Library Includes

2.8.3 Show File Paths

If “Show file paths” is selected, all of the files in the project window are shown with their full path, i.e. from a drive letter (figure 2.23).

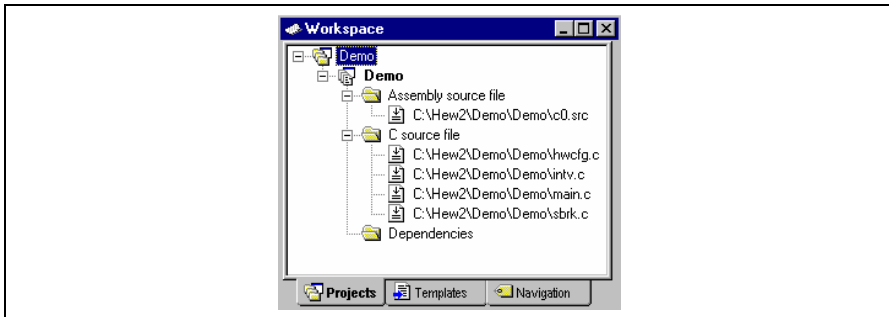

Figure 2.23: File Paths Shown

2.8.4 Sort files by time order

When this option is selected the workspace window is then sorted into file time stamp order.

If files are updated after selecting this option, manually update the order of these files.

☞ To manually update the file order:

1. Select "Refresh order" in the pop-up menu on the "Projects" tab of the "Workspace" window.

2.9 Setting the Current Project

A workspace can contain more than one project but only one of the projects can be active at any time. This active project is the one, which build actions and debug operations can be performed on. It is also possible to change the builder or debugger options for the project. This active project is shown as bold characters.

☞ To set a project as the current project:

1. Select a non-active project from the "Projects" tab of the "Workspace" window.
 2. Click the right mouse button to display the pop-up menu and select the **[Set as Current Project]** option.
- or:
1. Select the project, which you want to make active from the **[Project->Set Current Project]** sub-menu.

2.10 Inserting a Project into a Workspace

When a workspace is created, it contains only one project but, after it is created, you can insert new or existing projects into a workspace.

- ☞ To insert a new project into a workspace:
 1. Select [**Project->Insert Project...**]. The “Insert Project” dialog will be displayed (figure 2.24).
 2. Set the “New Project” option.
 3. Click OK. The “Insert New Project” dialog will be invoked.
 4. Enter the name of the new workspace into the “Name” field. This can be up to 32 characters in length and contain letters, numbers and the underscore character. As you enter the project name the HEW will add a subdirectory for you automatically. This can be deleted if desired.
 5. Click the “Browse...” button to graphically select the directory in which you would like to create the project. Alternatively, you can type the directory into the “Directory” field manually.
 6. The “Project type” list displays all of the available project types (e.g. application, library etc.). Select the type of project that you want to create from this list.
 7. Click “OK” to create the project and insert it into the workspace.

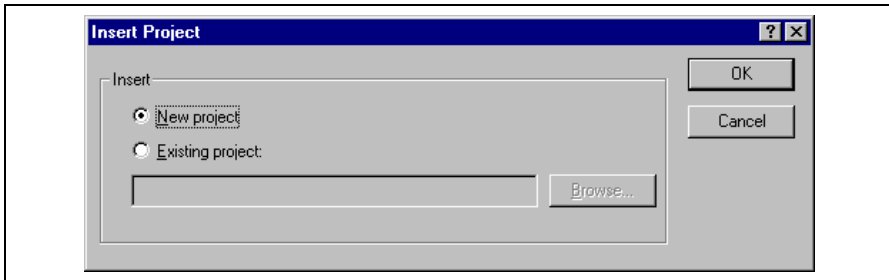

Figure 2.24: Insert Project Dialog

- ☞ To insert an existing project into a workspace:
 1. Select [**Project->Insert Project...**]. The “Insert Project” dialog will be displayed.
 2. Set the “Existing Project” option.
 3. Enter the full path of the project database file (.HWP file) into the edit field or click “Browse...” to search for it graphically.
 4. Click “OK” to insert the existing project into the workspace.

2.11 Specifying Dependencies between Projects

The projects within a workspace can be dependent upon one another so that when one project is built, all its dependent projects are built first. This is useful if another project uses one of the others in the workspace. For example, imagine that a workspace contains two projects. The first project is a library that is included by an application project. In this case the library must have been built and up to date before the second application can build correctly. To achieve this situation we can specify the library as a dependent (i.e. child) project of the application project. This would then allow the library to be built first if it is out-of-date.

When a dependent project is built the HEW attempts to match the configuration in the dependent project with that of the current project. This means that if the current configuration is “Debug” then the HEW will attempt to build the “Debug” configuration in the dependent project. If this matched configuration does not exist then the HEW will use the configuration that was last used in the dependent project.

- To make projects depend upon another:
 1. Select [**Project->Dependent Projects**]. The “Dependent Projects” dialog will be displayed.(figure 2.25)
 2. Select the project to which you would like to add dependents to. When you do this, the “Dependent projects” list will display all of the projects in the workspace (excluding the selected project).
 3. The “Dependent projects” list has a check box for each project listed. Set the associated check boxes to make those projects depend upon the selected project.
 4. Click “OK” to confirm the new project dependencies.

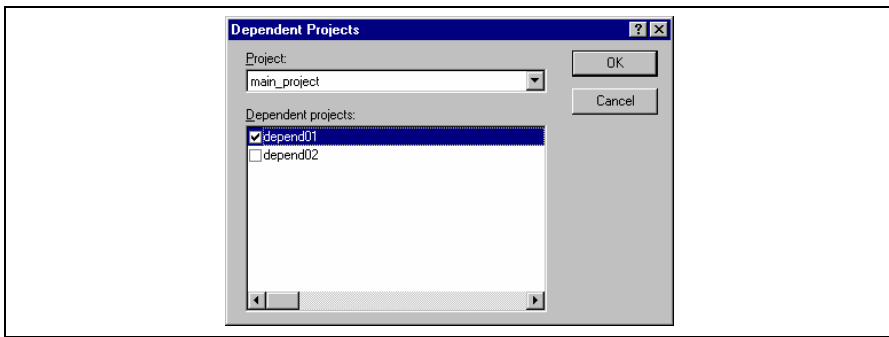

Figure 2.25: Dependent Projects dialog

2.12 Removing a Project from a Workspace

- ☞ To remove a project from a workspace:
 1. Select the project from the “Projects” tab of the “Workspace” window and click the right mouse button to invoke a pop-up menu.
 2. Select the **[Remove Project]** option.
 3. Dialog box is displayed. You confirm to remove the project. In the “Options” dialog box of the “Tools” menu, you can select this confirmation is performed or not.

Note: You cannot remove the current project from the workspace.

2.13 Loading/unloading a Project into/from a Workspace

- ☞ To load a project into a workspace:
 1. Select the project from the “Projects” tab of the “Workspace” window and click the right mouse button to invoke a pop-up menu.
 2. Select the **[Load Project]** option.
- ☞ To unload a project from a workspace:
 1. Select a non-active project from the “Projects” tab of the “Workspace” window and click the right mouse button to invoke a pop-up menu.
 2. Select the **[Unload Project]** option.

Note: You can load or unload plural projects at a time.

2.14 Relative projects paths in the workspace

In the High-performance Embedded Workshop when you add a project to the workspace you can choose to add the project to the workspace using a relative path. This allows you to position a project above the workspace directory and it will still be relocated correctly if you relocate the HEW workspace. The project is always relative to the workspace so if the project is one directory above the workspace before it is moved the HEW will try to find the project in the same relative location after the relocation procedure. This is especially useful if you are using a project shared between more than one workspace.

In older versions of the HEW this project would not have been relocated and would have still tried to access the original project path. The older version of the HEW could only relocate the projects, which were in a subdirectory of the workspace directory. This is still the standard behavior for the High-performance Embedded Workshop.

- ☛ To change a projects relative path flag:
 1. Select the project in the workspace window.
 2. Right click and then select properties.
 3. Click the “Project relative file path” checkbox to switch on or off the relative file path feature. (figure 2.26)
 4. Click “OK”.

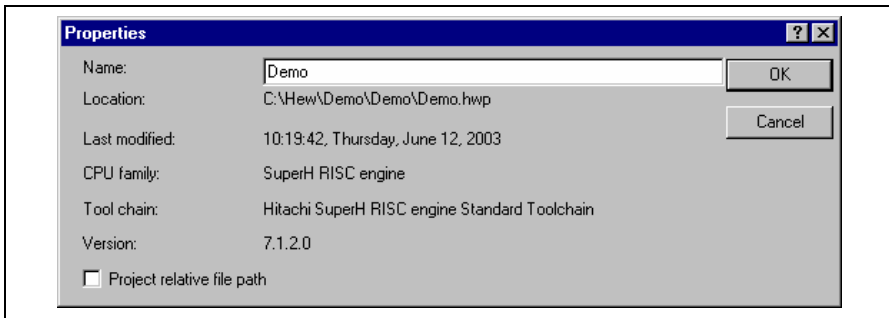

Figure 2.26: Properties Dialog

2.15 User folders in the workspace

In the High-performance Embedded Workshop it is possible to add folders to your workspace window. This allows you to logically group your files into certain areas within a project. The folder can be set to any name and this is entered in a dialog.

- To add a user folder:
 1. Select the project on the “Projects” tab of the workspace window.
 2. Right click and then add folder.
 3. Enter the name and click OK.
 4. You can now drag and drop files into this folder to group them logically.
- To remove a user folder:
 1. Select the folder on the “Projects” tab of the workspace window.
 2. Right click and then select Remove folder. Note that the folder must be empty and that the delete key can also be used instead of the pop-up.
- To modify a user folder name:
 1. Select the folder on the “Projects” tab of the workspace window.
 2. Right click and then select Modify folder name.
 3. Enter the new name in the dialog.
 4. Click “OK”.

3. Advanced Build Features

This chapter explains the advanced build concepts.

3.1 The Build Process Revisited

Chapter 2, “*Build Basics*” began by describing the build process in terms of a compiler, an assembler and a linker (figure 2.1). This will be the case for most installations of the High-performance Embedded Workshop. However, if you want to begin changing the build process (e.g. adding and removing phases) then it is important to understand more about the way in which a build functions.

3.1.1 What is a Build?

Building a project means applying a set of tools upon certain input files in order to produce the desired output. Thus, we apply a compiler upon C/C++ source files in order to create object files, we apply an assembler upon assembler source files in order to create object files and so forth. At each step or “phase” of the build, we apply a different tool upon a different set of input files. Figure 3.1 presents another view of the build process.

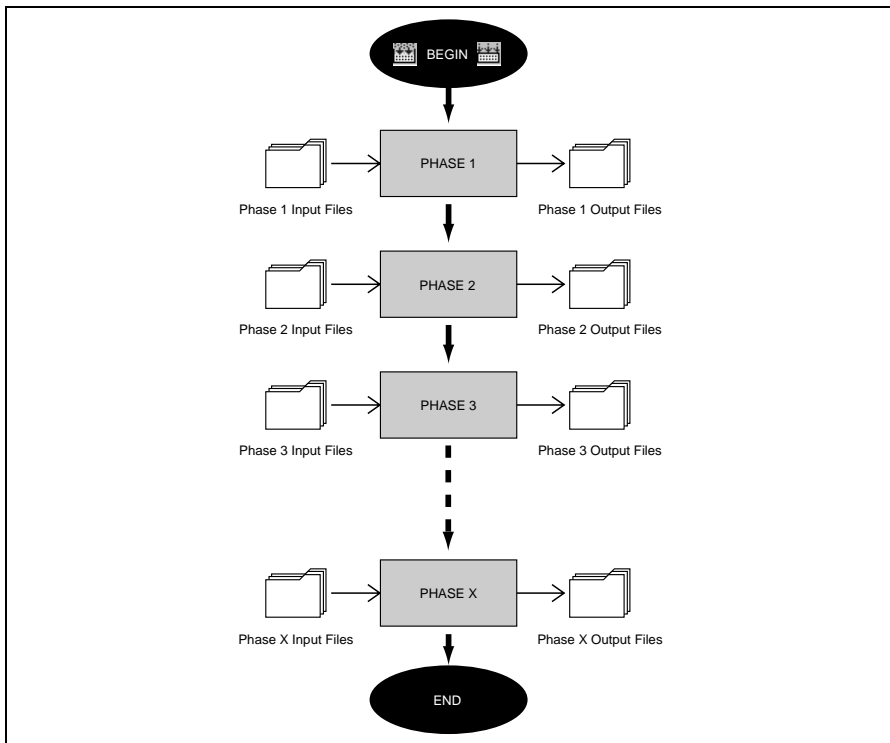

Figure 3.1: Build Process

The High-performance Embedded Workshop provides the ability to change this build process via its “Build Phases” dialog, which can be accessed via the [Options->Build Phases...] (figure 3.2). On the left-hand side are the phases that are defined in the current project (Figure 3.2 shows a standard set of build phases). The remainder of this chapter details the various functions that the “Build Phases” dialog provides.

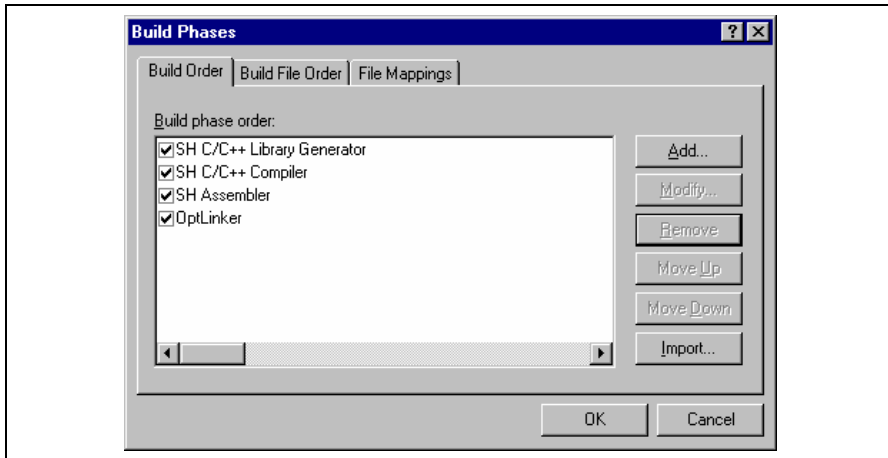

Figure 3.2: Build Phases Dialog

3.2 Creating a Custom Build Phase

If you want to execute another tool before, during or after a standard build process then this can be achieved by creating your own (i.e. custom) build phase.

Select [**Options->Build Phases...**] to invoke the “Build Phases” dialog (figure 3.2) and then click the “Add...” button. This will invoke the new build phase wizard dialog (figure 3.3a).

The first step (as shown in figure 3.3a) asks whether you want to create an entirely new phase or whether you want to add a system phase. A system phase is a “ready made” phase which is already defined within the toolchain you are using (e.g. compiler, assembler, linker, librarian, etc.) or a utility phase (e.g. file copy, complexity analyzer etc.).

The “Add an existing system phase” button is inactive if no more system phases are available. Select the “Create a new custom phase” button to create your own build phase.

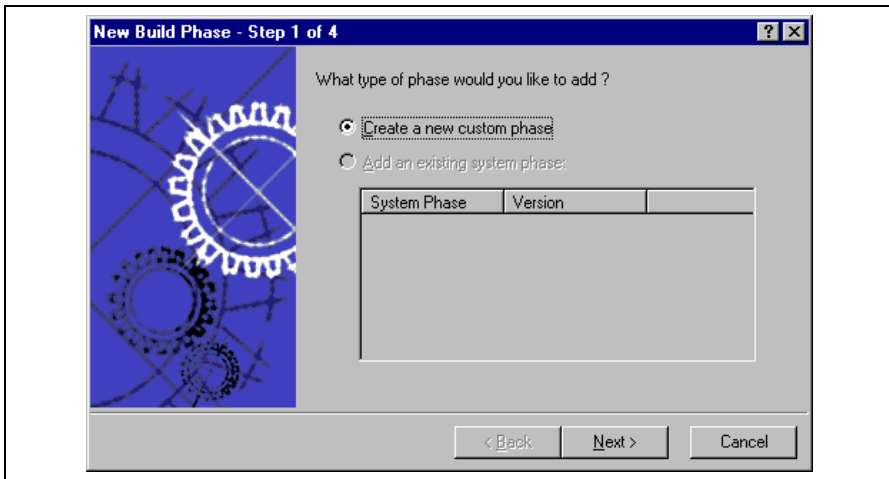

Figure 3.3a: New Build Phase Dialog (Step 1)

The second step (figure 3.3b) asks what type of phase you would like to create. There are two choices: multiple or single. When a multiple phase is executed, the command is applied to each file in the project of a certain file group. For example, if you set the input file group to be C source files then the command will be executed once for each C source file in the project. A single phase is executed once at most during a build.

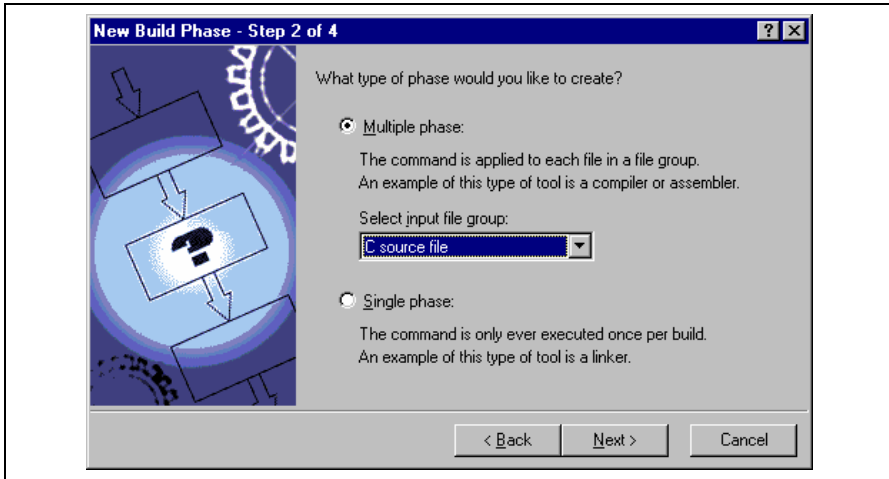

Figure 3.3b: New Build Phase Dialog (Step 2)

The input file group list contains the current file groups defined for the project. It is possible to define multiple input file groups by selecting the “Multiple Groups...” entry in the input file group list. Selecting this list entry displays the dialog in figure 3.3c.

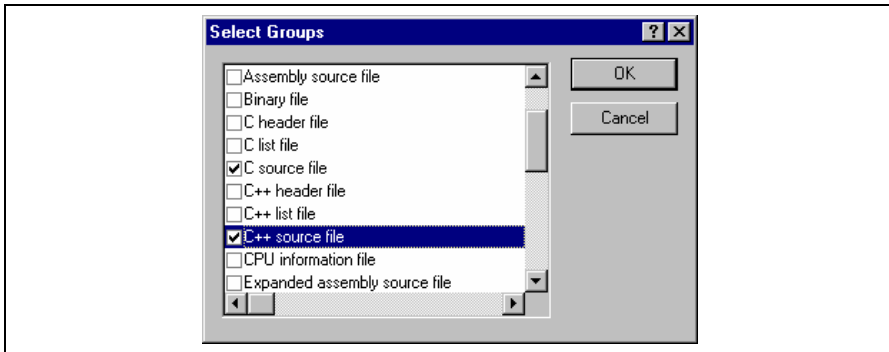

Figure 3.3c: Modify multiple input file groups

Once this choice has been made the input file group selection is displayed as “Multiple Groups...” This dialog allows the user to choose multiple input file groups for the custom phase being added to the project. To select a file group check the box next to the file groups name. One or more file groups can be selected in this dialog.

The third step (figure 3.3d) requests the fundamental information about the new build phase. Enter the name of the phase into the “Phase name” field. Enter the location of the program file into the “Command” field (do not insert any command line options as these options are specified via the [Options] menu of the HEW menu bar). Specify the default options for the phase (i.e. what options you would like new files to take when added to the project) into the “Default options” field. If you have a preferred directory in which you would like this program to run from (i.e. where you want the current working directory to be set to before the tool is executed) then enter it into the “Initial directory” field.

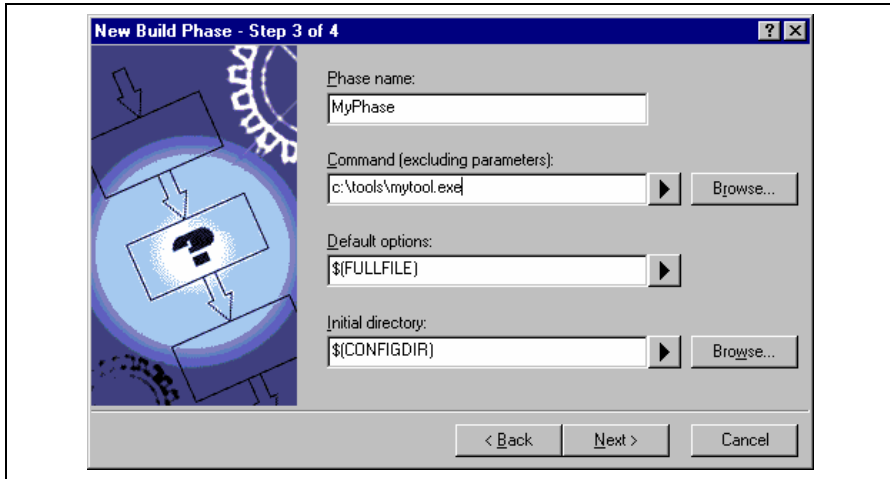

Figure 3.3d: New Build Phase Dialog (Step 3)

The fourth and final step (figure 3.3e) allows you to specify any environment variables, which the phase requires.

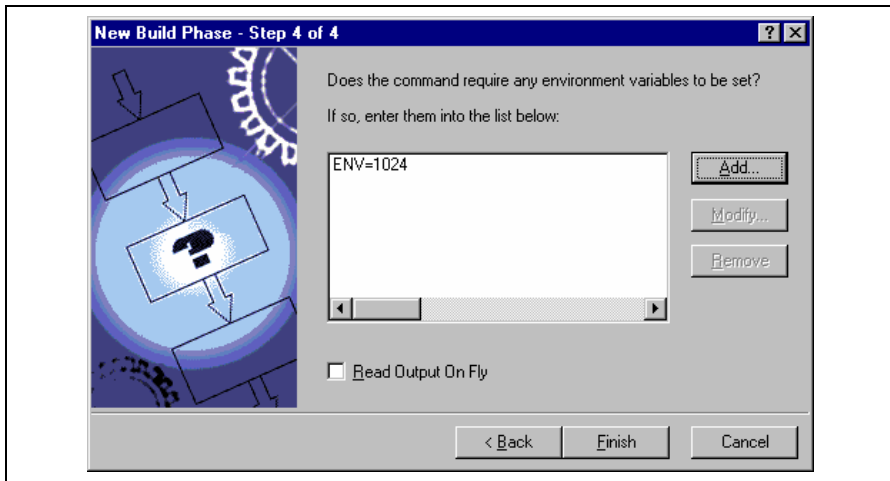

Figure 3.3e: New Build Phase Dialog (Step 4)

To add a new environment variable click the “Add...” button (the dialog shown in figure 3.4 will be invoked). Enter the variable name into the “Variable” field and the variable’s value into the “Value” field and then click “OK” to add the new variable to the list of the fourth step. To modify an environment variables select the variable in the list and then click the “Modify...” button. Make the required changes to the “Variable” and “Value” fields and then click “OK” to add the modified variable to the list. To remove environment variables select the variable that you want to remove from the list and then click the “Remove” button.

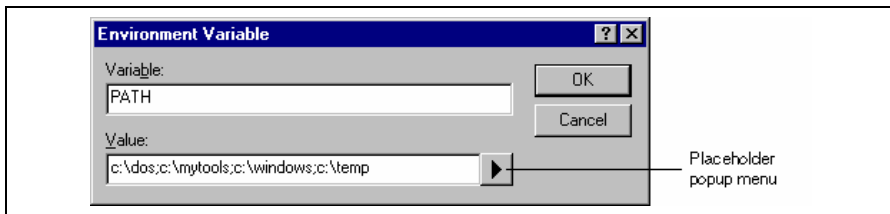

Figure 3.4: Environment Variable Dialog

If the tool you are adding can display its output as the tool is running then use the ‘Read Output On Fly’ option. This will display the tool output as each line of output happens. If this option is set to off then the HEW will store all output, which is being displayed by the tool, and display it in the output window when the tool has finished its operation. This can be a problem when the tool is running an operation that might take many minutes, as it is difficult to see the progress of the current execution.

Note: Using ‘Read Output On Fly’ can cause problems when using certain tools on certain operating systems. If you are having problems with tools locking up or freezing in HEW then uncheck the ‘Read Output On Fly’ option.

Click the “Finish” button to create the new phase. By default the new phase is added to the bottom of the “Build Phase Order” list in the “Build Order” tab of the “Build Phases” dialog (Figure 3.2).

3.3 Ordering Build Phases

In a standard build (shown in figure 3.5), you could add a phase at four different positions: before the compiler, before the assembler, before the linker or after the linker. You may place your own custom phases or move system phases to any position in the build order. It is important to remember that if the output of your custom phase can be input into another phase then the phase order must be correct if the build is to behave as intended.

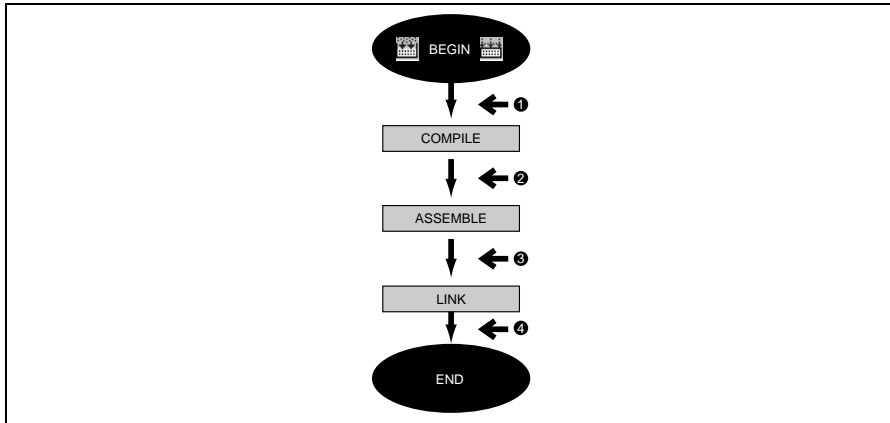

Figure 3.5: Typical Build Process

The build phase dialog provides facilities for ordering build phases via the “Build Phases” dialog. It has two tabs, which are concerned with the ordering of phases: “Build Order” and “Build File Order”. And then you can click “OK” button.

3.3.1 Build Phase Order

The “Build Order” tab (figure 3.6) displays the current order in which phases will be executed when the build (🏠) or build all (🏠) operation is selected. The check box to the left of each phase indicates whether or not it is currently enabled. By clicking this box, the phase can be toggled on or off.

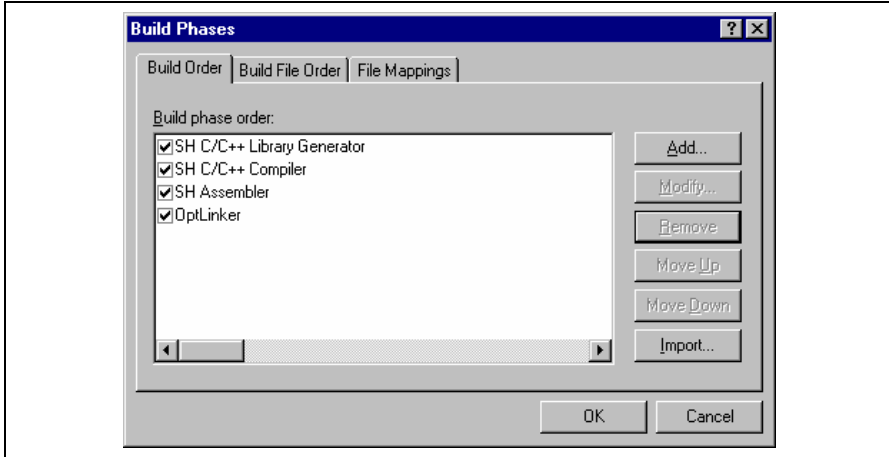

Figure 3.6: Build Phases Dialog Build Order Tab

In addition the following operations can be performed:

- To remove a phase:
 1. Select the phase that you would like to remove.
 2. Click the “Remove” button.
 3. Click the “Yes” button, if a confirmation dialog box.
- To view the properties of a system phase:
 1. Select the system phase that you would like to examine.
 2. Click the “Modify...” button.
 3. System properties are shown as dialog box. Click the “OK” button.
- To move a phase:
 1. Select the phase that you would like to move.
 2. Click the “Move Up” or “Move Down” button.
- To import a phase:
 1. Click the import button. A dialog is displayed which allows the user to browse to an existing project to import a custom phase from.
 2. Choose the location of the project you wish to import a custom phase from. Once selected a dialog is displayed which lists the custom phases in the imported project.
 3. Once you have decided which phase to import highlight it in the list and then click OK. The phase will then be added to the build phases dialog at the bottom of the build order.

- ☞ To modify a custom phase:
1. Select the custom phase that you would like to modify.
 2. Click the “Modify...” button. The modify phase dialog will be invoked with the “Command” tab selected (figure 3.7).
 3. Change the contents of the fields as appropriate.
 4. Set the “Don’t check for input file(s) existence before executing” check box if you don’t want the HEW to abort the execution of the phase if any of the input files don’t exist.
Set the “Read Output On Fly” check box if you want to display the command output to stdout during command execution.

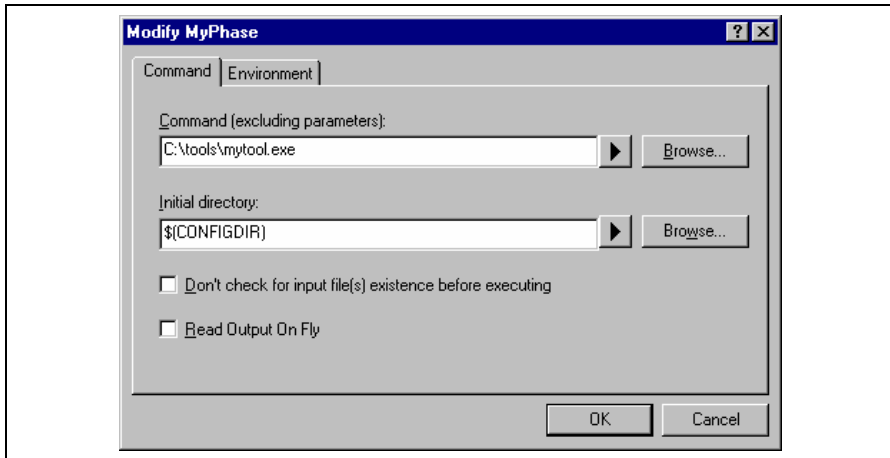

Figure 3.7: Modify Phase Dialog Command Tab

5. Select the “Environment” tab (figure 3.8) to edit the environment settings for the phase.
6. Use the “Add...”, “Modify...” and “Remove” buttons to add, modify and remove environment variables.
The operation is the same as discussed in the previous section.
7. Click “OK” when all modifications have been made.

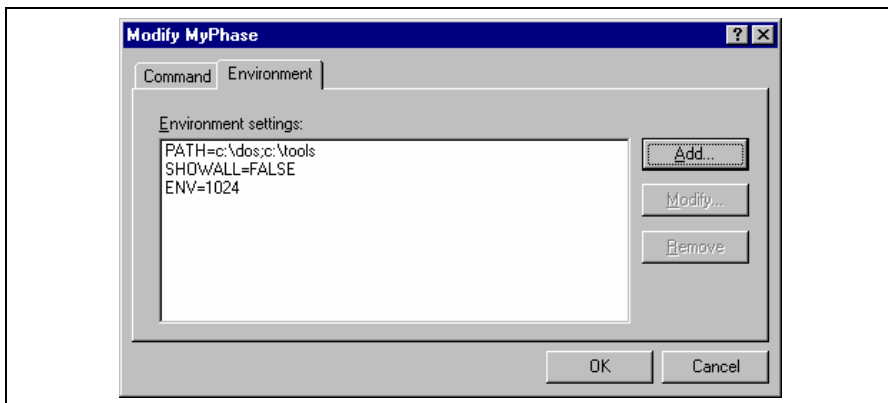



Figure 3.8: Modify Phase Dialog Environment Tab

3.3.2 Build File Phase Order

If you were to select a C source file from the “Workspace” window and then activate **[Build->Build File]** (or press ) you would expect the file to be compiled. Likewise, if you were to select an assembly source file from the workspace window and then activate **[Build->Build File]** you would expect the file to be assembled. The connection between file group and which phase(s) to execute is managed by the “Build File Order” tab of the “Build Phases” dialog (figure 3.9).

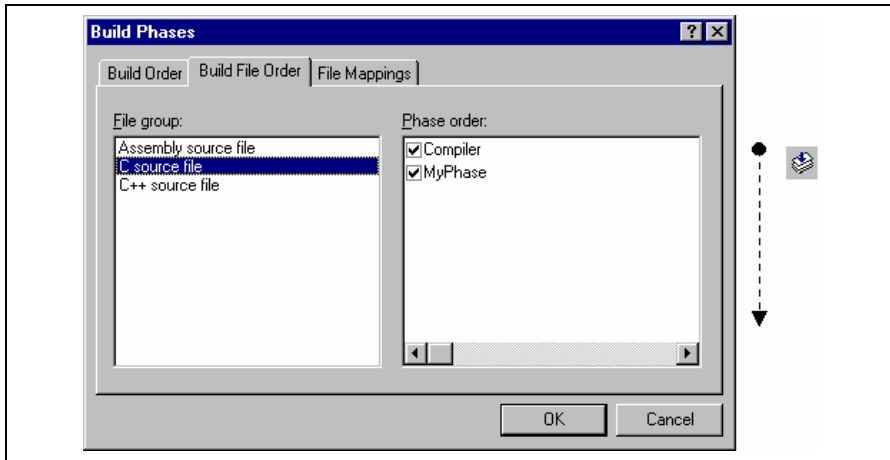

Figure 3.9: Build Phases Dialog Build File Order Tab

The list displays all of the current phases that will be executed when the build file operation is selected upon the file group shown in the “File group” list box. In figure 3.9 the “C source file” file group is selected and the “Compiler” and “MyPhase” phases are associated with it.

Entries in the “Phase order” list, of the “Build File Order” tab, are added automatically as new entries are added to the “Build Order” tab. For example, if you were to add a phase which takes C source files as input then this phase will be automatically added to the list of phases to execute when a build file operation is applied to a C source file. If you don’t want a certain phase to execute when **[Build->Build File]** is selected then clear the check box to the left of the phase name in the “Phase order” list.

3.4 Setting Custom Build Phase Options

Once you have defined a custom phase, you will want to specify the command line options that should be used when it is executed. Each defined phase has a menu option on the **[Options]** menu. To specify options for that phase select it. The dialog that will be invoked depends upon whether the custom phase selected was a multiple or single phase (according to the selection of phase type in figure 3.3b).

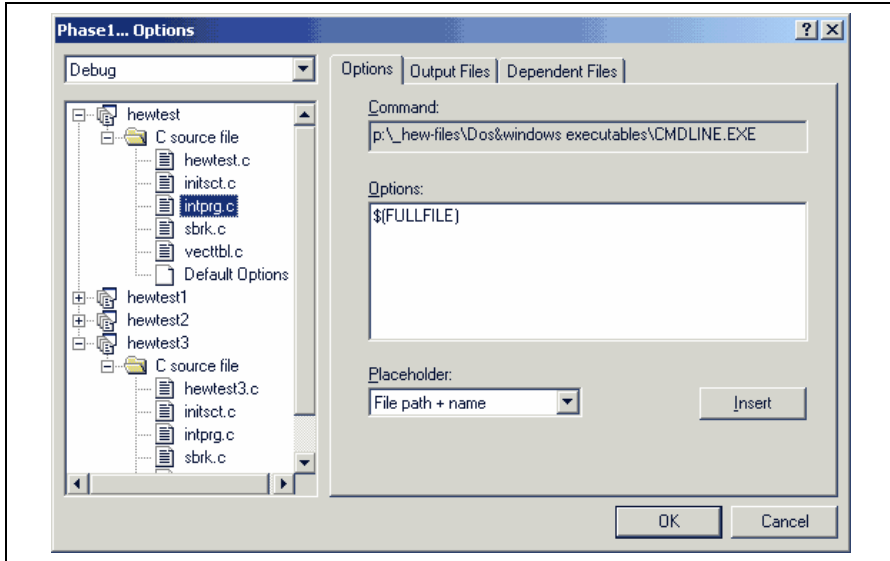

Figure 3.10: Custom Options Dialog

The dialog in figure 3.10 is a custom phase options dialog. The implementation of which is slightly different depending on whether you are using a multiple or single shot phase. On the left-hand side is the project and file list. It is possible to select multiple projects and files in the same way as Windows® explorer to modify the options for more than one selection. On the right-hand side are the 3 options tabs. This is where you set the options that you want to apply to the selected file(s). You can also choose which configuration information is being viewed from the configuration list on the upper left of the dialog box. Each configuration is listed along with a special entry named "Multiple configurations...". If you select multiple configurations then a dialog is displayed which allows you to select more than one configuration. This method is used throughout HEW for modifying multiple configurations at once.

3.4.1 Options Tab

The “Options” tab (figure 3.11) allows you to define the command line options that will be passed to the phase. The “Command” field displays the command, which was entered when you defined the phase (figure 3.3d). Enter into the “Options” field the command line arguments that you would like to pass to the command. If you want to insert a placeholder, select the relevant placeholder from the “Placeholder” drop-down list box and then click the “Insert” button. For a detailed description of placeholders see appendix C, “Placeholders”.

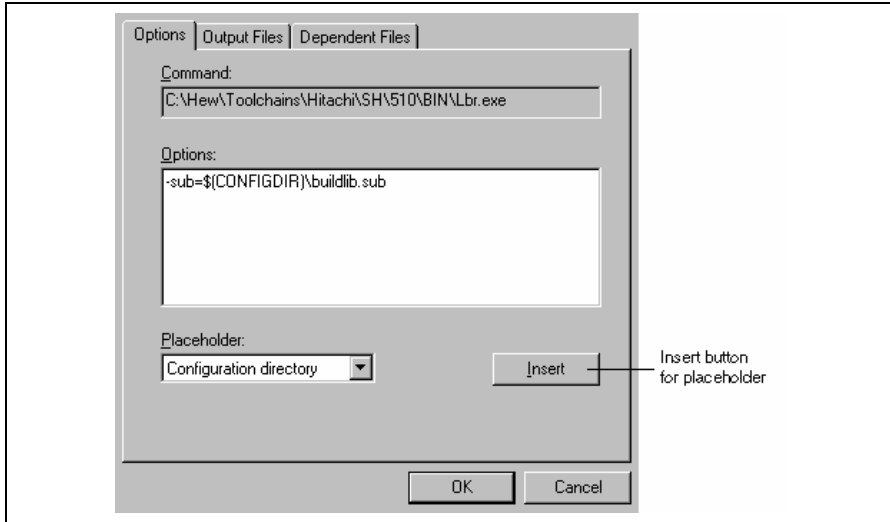

Figure 3.11: Custom Options Options Tab

3.4.2 Output Files Tab

The “Output Files” tab (figure 3.12) is where you can specify the output file or files that will be produced by the phase. Before each file is passed into this phase, the HEW checks that the output files are of a less recent date than the input file. If so, the phase will be executed for that file (i.e. input files have been modified since the output file or files were last produced). If the files are up to date then the phase will not be executed.

Note: If no output files are specified, the phase will execute regardless.

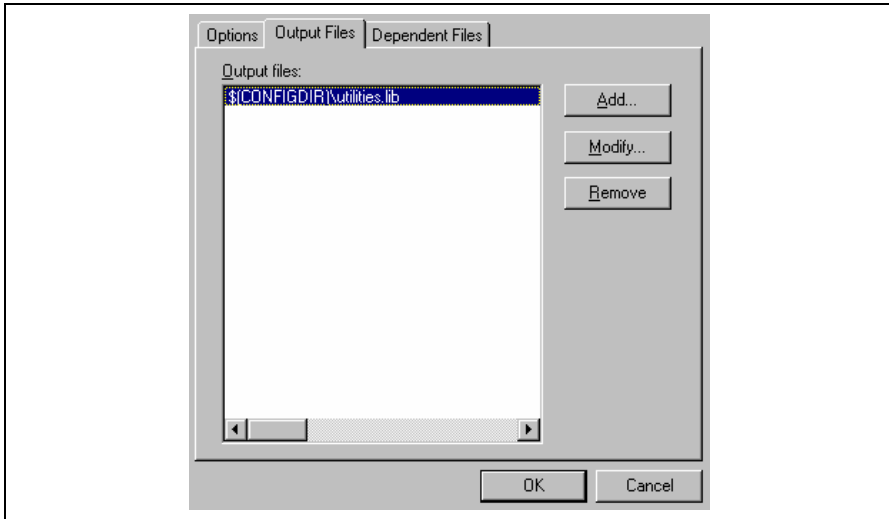

Figure 3.12: Custom Options Output Files Tab

- To add an output file:
 1. Click “Add...”. The “Add Output File” dialog will be invoked (figure 3.13).
 2. Enter the file path or browse to it using the “Browse...” button.
 3. Click “OK” to add this output file to the list.

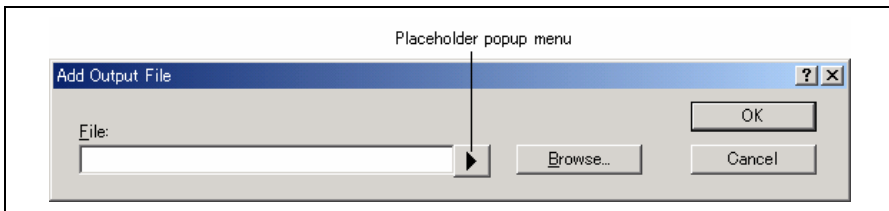

Figure 3.13: Add Output File Dialog

- To modify an output file:
 1. Select the output file that you would like to modify.
 2. Click “Modify...”. The “Modify Output File” dialog, which is the same as figure 3.13 except the title, will be invoked.
 3. Modify the fields as required and then click the “OK” button to add the modified entry back to the list.
- To remove an output file:
 1. Select the output file that you would like to remove.
 2. Click the “Remove” button.

3.4.3 Dependent Files Tab

The “Dependent Files” tab (figure 3.14) is where you can specify the dependent files that are needed by the phase. Before each file is passed into this phase, the HEW checks that the dependent files are of a more recent date than the input file. If so, the phase will be executed for that file (i.e. dependent files have been modified since the input file or files were last modified). If not, the phase is not executed for the files.

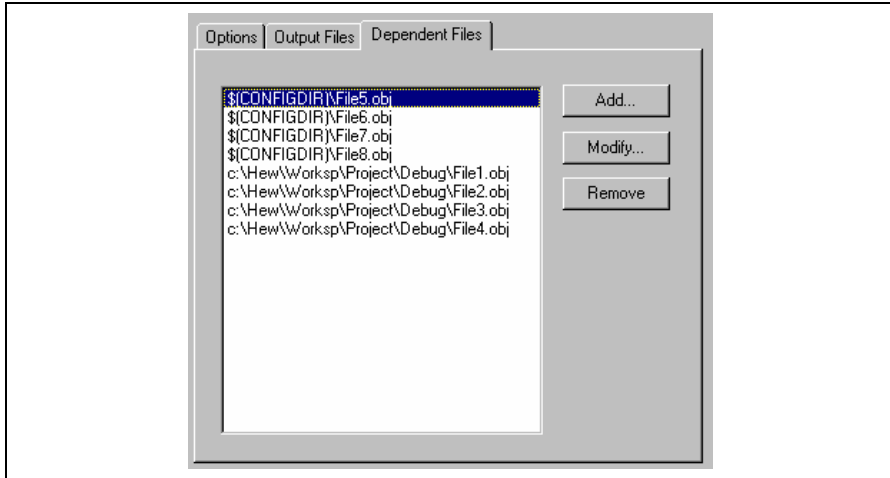

Figure 3.14: Dependent Files Tab in Custom Options

- To add a dependent file:
 1. Click “Add...”. The “Add Dependent File” dialog will be invoked (figure 3.15).
 2. Enter the file path or browse to it using the “Browse...” button.
 3. Click “OK” to add this output file to the list.

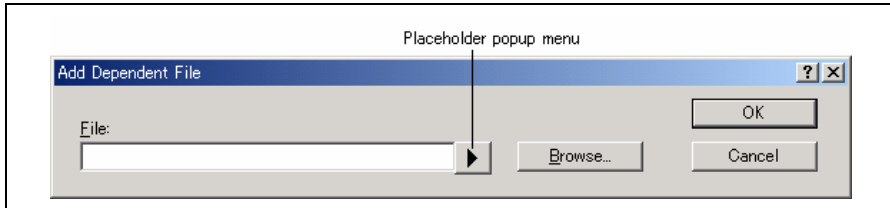

Figure 3.15: Add Dependent File Dialog

- To modify a dependent file:
 1. Select the dependent file that you would like to modify.
 2. Click “Modify...”. The “Modify Dependent File” dialog, which is the same as figure 3.15 except the title, will be invoked.
 3. Modify the fields as required and then click the “OK” button to add the modified entry back to the list.
- To remove a dependent file:
 1. Select the dependent file that you would like to remove.
 2. Click the “Remove” button.

3.5 File Mappings

By default, the files input to a phase are only taken from the project, i.e. all project files of the type specified in the “Select input file group” drop-down list on the “New Build Phase” dialog (figure 3.3b). If you would like a phase to take files output from a previous phase (i.e. intermediate files) then you must define this in the “File Mappings” tab of the “Build Phases” dialog (figure 3.16).

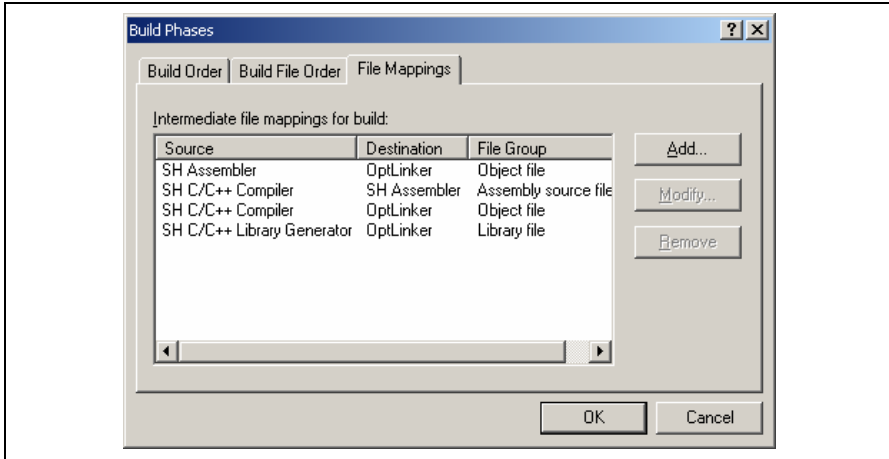

Figure 3.16: Build Phases Dialog File Mappings Tab

A file mapping states that you would like the HEW to pass output files of a certain type produced by one phase (referred to as the source phase) to another phase (referred to as the destination phase). Such intermediate files are passed in addition to the project files.

➤ To add a file mapping:

1. Click “Add...”. The “Define File Mapping” dialog will be invoked (figure 3.17).
2. Select the file group, which you want to pass between the phases from the “File group” drop-down list box.
3. Select the source phase (i.e. which phase generates the files) from the “Source phase” drop-down list box.
4. Select the destination phase (i.e. which phase takes these files) from the “Destination phase” drop-down list box.
5. Click “OK” to create the new mapping.

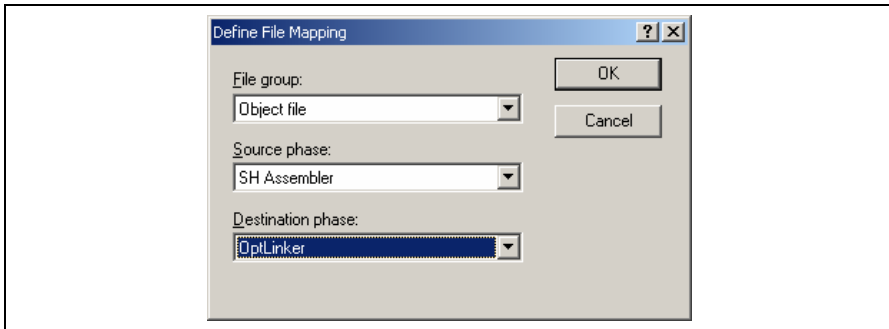

Figure 3.17: Define File Mapping Dialog

➤ To modify a file mapping:

1. Select the mapping to be modified.
2. Click “Modify...” button. The “Define File Mapping” dialog will be invoked (figure 3.17).
3. Modify the options as necessary.
4. Click “OK” to commit the changes.

3.6 Controlling the Build

By default, the High-performance Embedded Workshop will execute all of the phases in a build and only stop if a fatal error is encountered. You can change this behavior by setting the controls on the “Build” tab of the “Options” dialog (figure 3.18).

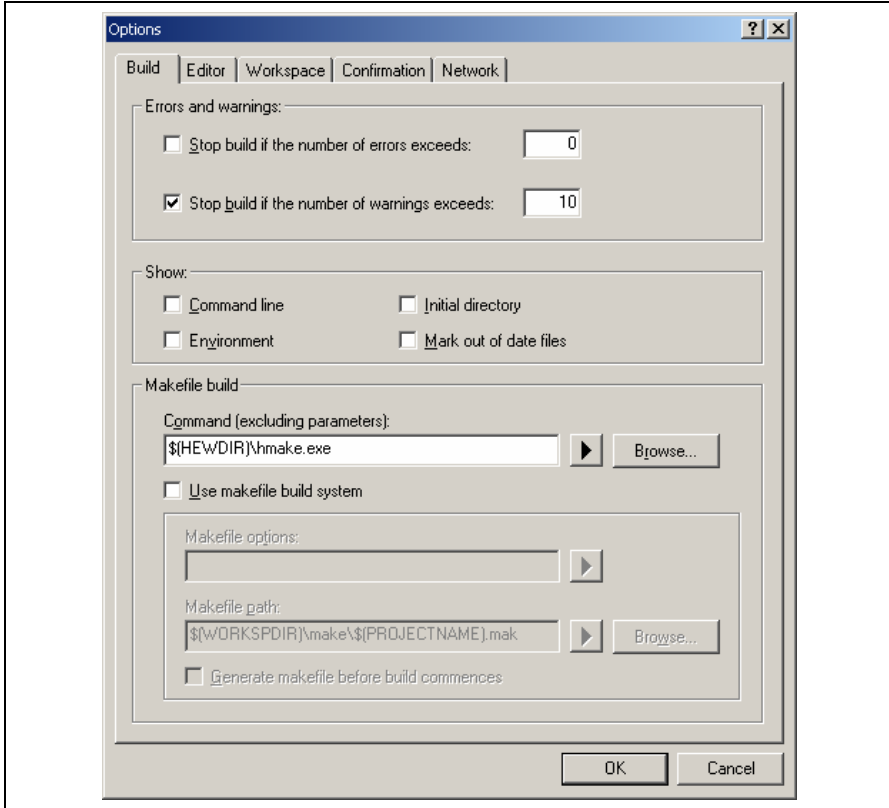

Figure 3.18: Options Dialog Build Tab

Select **[Tools->Options...]** to invoke the dialog. If you want to stop the build when a certain number of errors are exceeded then set the “Stop build if the no. of errors exceed” check box and then specify the error count limit in the edit field to the right. If you want to stop the build when a certain number of warnings are exceeded then set the “Stop build if the no. of warnings exceed” check box and then specify the warning count limit in the edit field to the right.

Note: Irrespective of what these controls are set to, the build will always halt if a fatal error is encountered.

In addition to specifying error and warning count limits, the “Build” tab also allows you to request that the command line, environment and initial directory of each execution should be displayed. Check the appropriate check boxes as necessary.

3.7 Logging Build Output

If you would like to write the results of each build to file then invoke the “Customize” dialog by selecting [Tools -> Customize...] and select the “Log” tab (figure 3.19). Set the “Generate log file” check box and then enter the full path of the log file into the “Path” field or browse to it graphically by clicking the “Browse...” button.

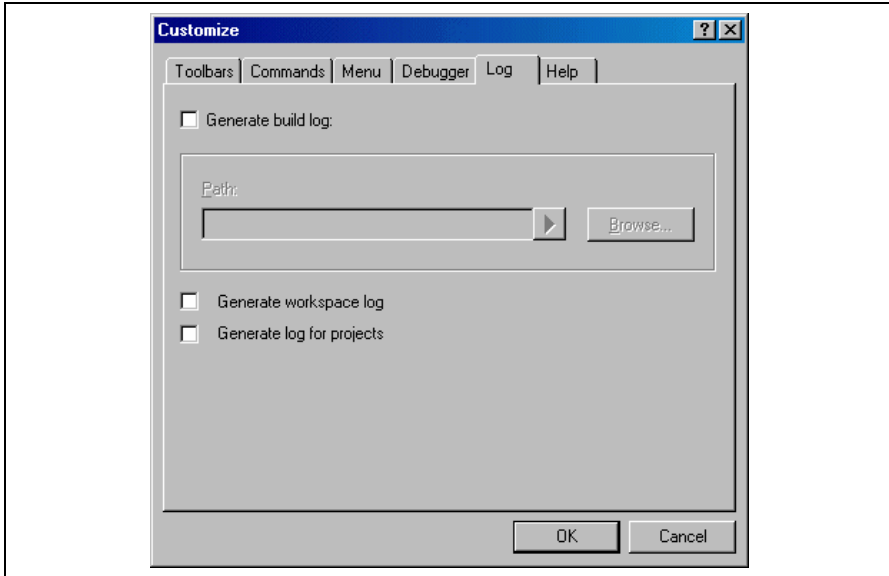

Figure 3.19: Tools Customize Dialog Log Tab

3.8 Changing Toolchain Version

If two or more versions of the same toolchain are registered in the HEW, you can choose a version of the toolchain on the “Change Toolchain Version” dialog shown in Figure . To invoke the dialog, select [Tools->Change Toolchain Version...]. Choose one of the versions from the “Toolchain versions” drop-down list and click the “OK” button to enforce your choice.

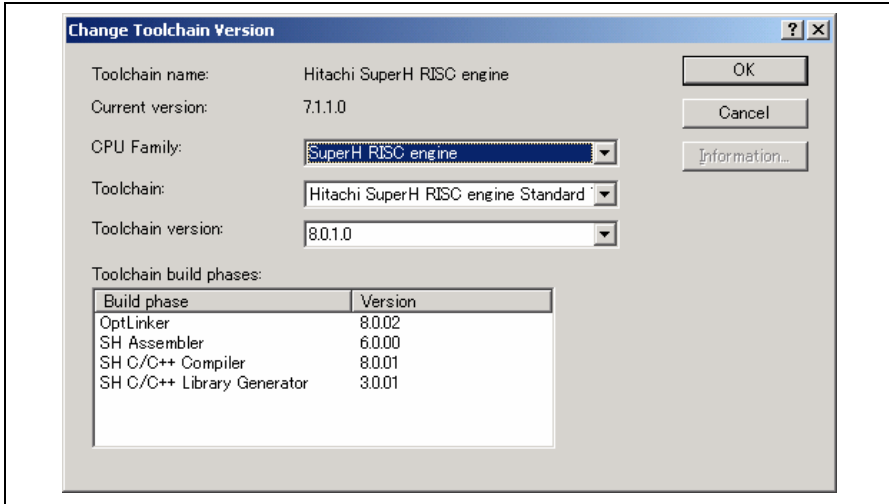

Figure 3.20: Change Toolchain Version Dialog

To show information of toolchain components select a tool from the “Toolchain build phases” list on the “Change Toolchain Version” dialog and click the “Information...” button. Then a tool information dialog (figure 3.21) will show you the information of the tool. Click the “Close” button to close the dialog.

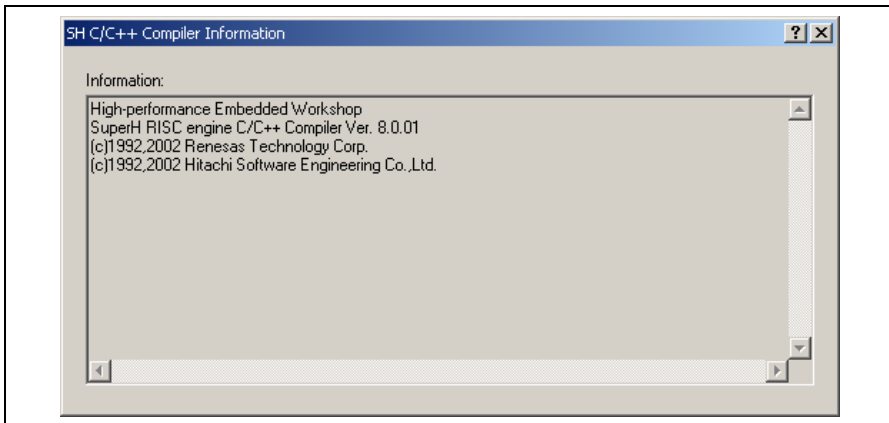

Figure 3.21: Toolchain Information Dialog

3.9 Using an External Debugger

The High-performance Embedded Workshop can launch an external debugger tool. If you want to use another debugger then you must add it to the Tools menu.

The “Debugger” tab of the “Customize” dialog (figure 3.22a, figure 3.22b, figure 3.22c) is where the external debugger related information is configured. You may wish to use an older version of the debugger if certain targets are not currently supported in the new environment. Invoke it by selecting [Tools->Customize...] and then selecting the “Debugger” tab.

The first choice to make is which debug tool you would like to use from the “External debugger selected” drop-down list.

“Hitachi Debugger Interface (version 4.x or greater)”: Use the HDI

“Mitsubishi PD debugger”: Use the PD debugger

“Other external debugger”: Use the other debugger

“Non selected”: Not use the external debugger

Once this has been selected the external debugger must be configured.

☛ To use the HDI:

1. Sets the location of the HDI executable. This must be version HDI 4.0 or greater, otherwise its behavior is not guaranteed.
2. Sets the location of the session file. This tells the HDI which session to load when it is launched.
3. Sets the location of the download module.

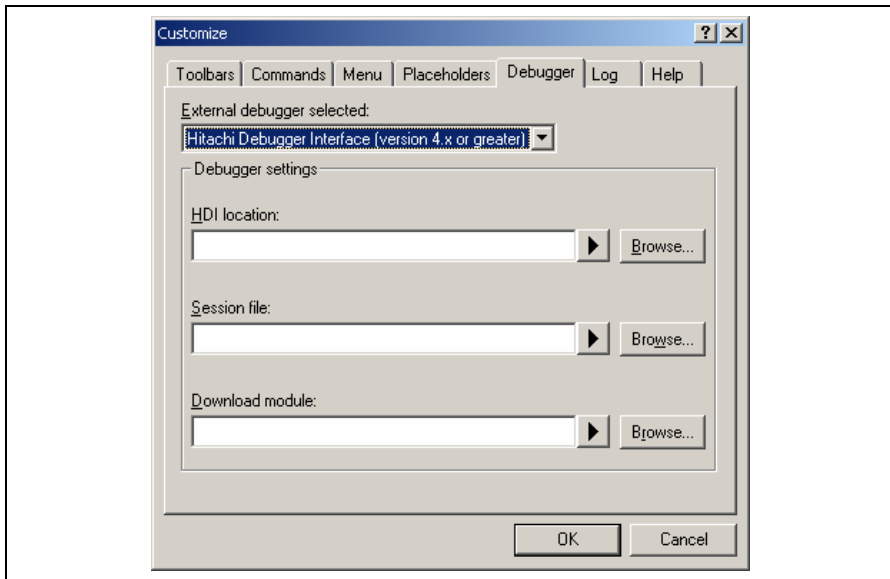

Figure 3.22a: External debugger selected – HDI

- ☞ To use the PD debugger:
 1. Sets the location of the PD debugger executable.
 2. Sets the location of the PD profile file. This tells the PD debugger which session to load when it is launched.
 3. Sets the command line option. This field allows additional options to be specified which can modify the behavior of the external debugger.
 4. Sets the location of the download module.

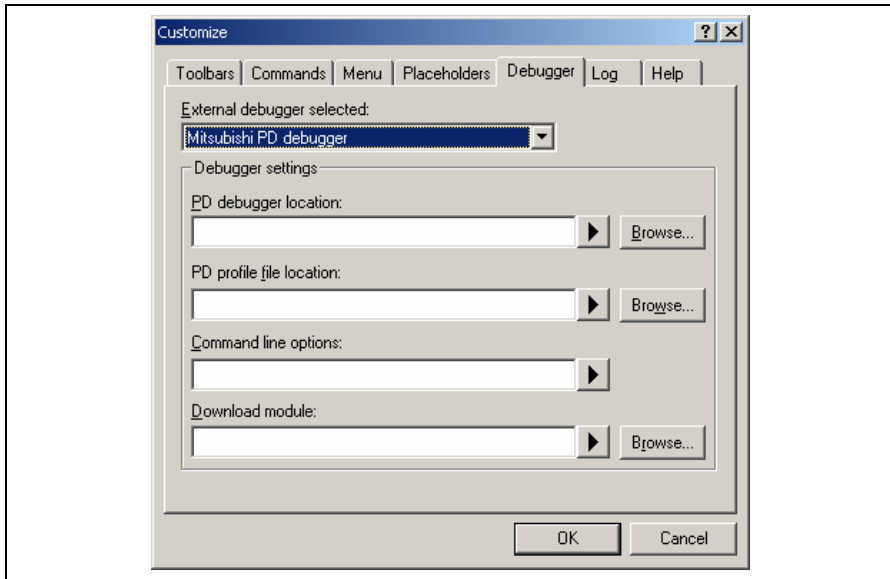

Figure 3.22b: External debugger selected – PD debugger

- ☞ To use the other external debugger except on the HDI or the PD debugger:
 1. Sets the location of the external debugger executable.
 2. Sets the command line option. This field allows additional options to be specified which can modify the behavior of the external debugger.
 3. Sets the location of the download module.

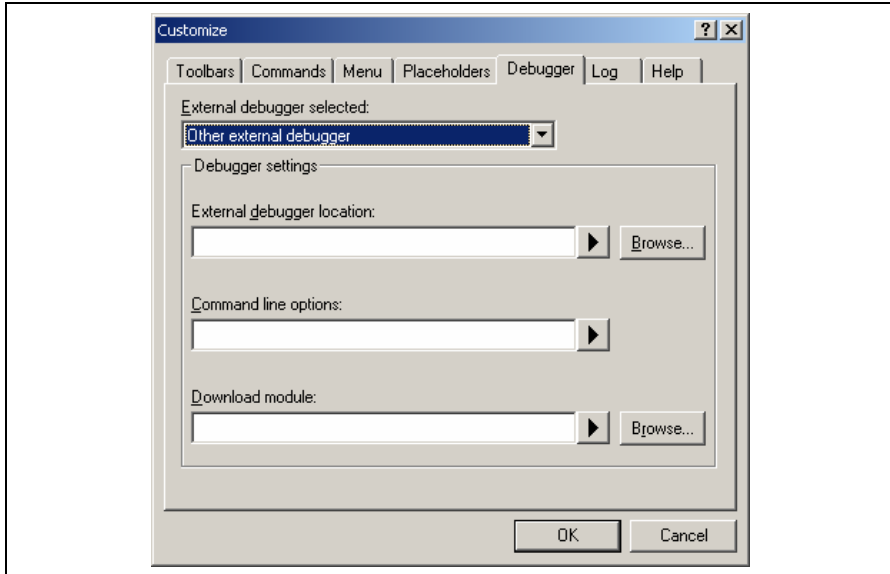

Figure 3.22c: External debugger selected – External debugger except on the HDI or the PD debugger

Click the “Launch External Debugger” toolbar button to invoke the external debugger:



After a build, if the download module has been updated, the HEW will switch back to the debugger to enable immediate debugging. Whilst using the debugger, double clicking in any source window will switch back to the HEW with the source file open at the line, which was double clicked. This operation is not possible with the “Other external debugger”.

3.10 Generating a Makefile

The HEW allows you to generate a makefile, which can be used to build parts of your workspace without HEW. This is particularly useful of you want to send a project to a user who does not have the HEW or if you want to version control an entire build, including the make components.

This version of HEW also supports the integration of the generated makefile and tools into the HEW framework. This allows you to click build menu or toolbar button and then launch the makefile rather than the normal internal HEW build process. For further information, refer to the “*Using a makefile inside the HEW system*” section later in this chapter.

☞ To generate a makefile:

1. Ensure that the project, which you want to generate a makefile for, is the current project.
2. Ensure that the build configuration that you want to build the project with is the current configuration.
3. Select **[Build->Generate Makefile...]**.
4. Select the radio button, which is relevant for your makefile. (See figure 3.23.)
5. Ensure you have selected the correct makefile format. HEW is capable of generating GNUMake, HMake and NMake compatible files.
6. The use static sub-command files check box will generate separate command files in the make destination directory. This is different to the normal style where the sub-command files are generated by the make tool. In the case of the GNUMake file format this must be switched on.
7. Checking “Scan dependencies whilst building makefile” will force a dependency scan to ensure the makefile creation is up to date.
8. Click “OK”.

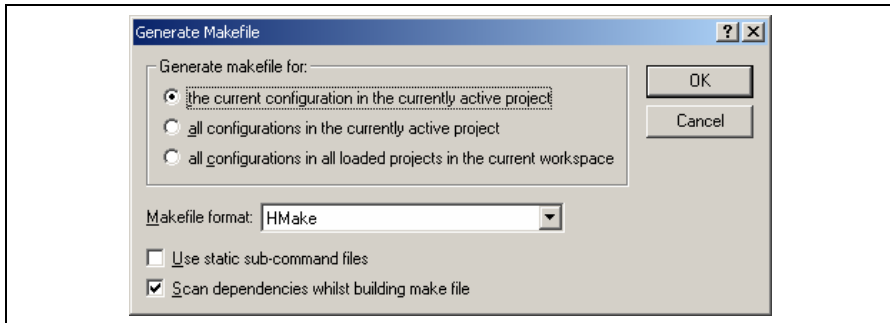

Figure 3.23: Generate Makefile Dialog

The HEW will create a subdirectory “make” within the current workspace directory and then generate the makefile into it. It is named after the selection, with a .mak extension for example the current project and configuration (e.g. project_debug.mak). The executable HMAKE.EXE, located in the HEW installation directory, is provided for you to execute the makefiles generated by the HEW. It is not intended to execute makefiles, which have been user modified. For further details on HMAKE, refer to Appendix F, “*HMAKE User Guide*”.

☞ To execute a makefile:

1. Open a command window and change to the “make” directory where the makefile was generated.
2. Execute HMAKE. Its command line is HMAKE.EXE <makefile>.

Note: The degree portability of a generated makefile is entirely dependent upon how portable the project itself is. For example, any compiler options, which include full paths to an output directory or include file directory, will mean that, when given to another user with a different installation, the build will probably fail. In general use placeholders wherever possible – using a full, specific path should be avoided when possible.

3.11 Using a makefile inside the HEW system

The HEW also allows you to configure the internal build to use a particular make file rather than the internal HEW system when build is clicked.

The standard HEW integrated build should be fine for all of your building requirements. However in some cases you may feel the need to use makefiles rather than relying on the HEW internal make system. The techniques to do this are described below:

- ☞ To set-up the internal makefile execution:
 1. Create a base HEW workspace in which to launch your makefile in. It makes sense if this is the same toolchain as the one to be used in your makefile. Although this is not essential.
 2. Click on [Tools->Options].
 3. Click the build tab (figure 3.24).
 4. Select the makefile command, which should be used. By default this is set to the Renesas make tool shipped with HEW. This is called HMAKE.exe and is located in the HEW installation directory "\$(HEWDIR)".
 5. Click the "Use makefile build system" check box. This tells the HEW that when the build button is clicked that makefile should be executed rather than the internal build.
 6. Setup the makefile path. This defaults to the location, which HEW will generate makefiles to. This item is configuration based so you can have a different makefile for each configuration.

Note:

You do not need to use a makefile generated by HEW. It can be any format as long as your make tool supports it.

7. Setup the makefile options. HMAKE allows the user to specify project or configuration selection options so that different builds can be launched from the same file. Again this item is configuration based so you can have a different makefile options for each configuration. For further details on HMAKE, refer to Appendix F, "HMAKE User Guide", "F.1.3 Parameters".
8. The final option is the generate make file before build. This will launch the default make file creation utility before the makefile is executed. This means the makefile will always be up to date with the HEW project system.
9. Click OK to save the changes.

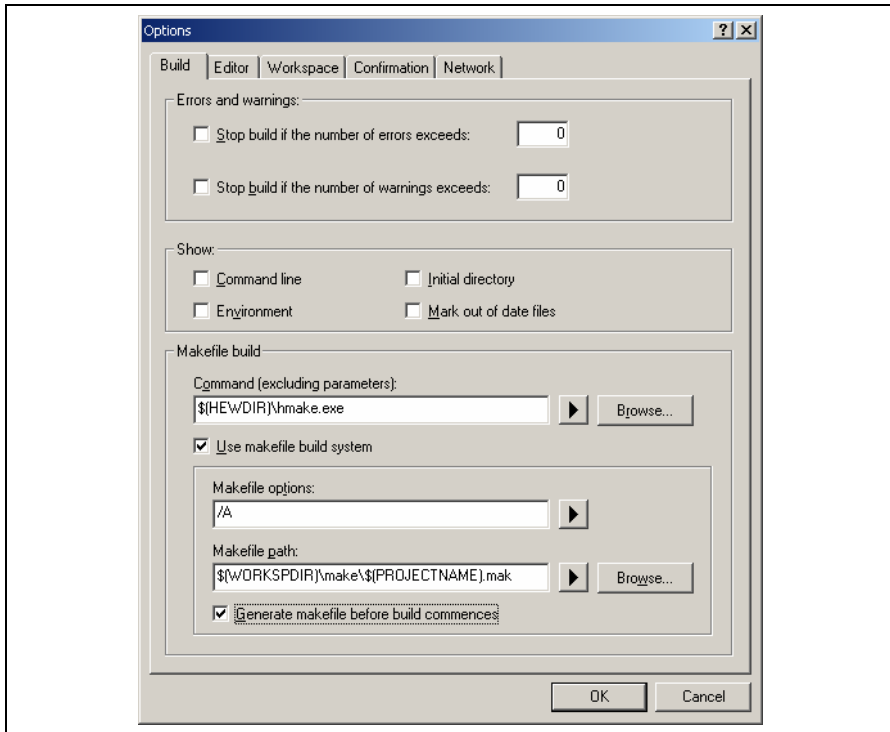

Figure 3.24: Option Dialog Build tab

Once this system is setup the build button, menu and keyboard shortcuts are linked to the makefile tool execution. All output is directed to the output window as in the case of the normal build. If you are using a toolchain supported by HEW errors and warnings can be double-clicked to jump to the source files. The help link should also be supported. Note when using the HMAKE.exe system the build all button will pass a command to HMAKE to force a re-build all operation. When using GNUmake this is not supported.

3.12 Customizing the HEW linkage order

Object module are linked as alphabetical order in HEW default. You can specify the linkage order, if you wish to.

- To switch on manual linkage order facilities:
 1. Click the [Build->Linkage Order...] menu item.
 2. On the dialog displayed click the Use custom linkage order check box (figure 3.25).
 3. Then you can move the objects into whichever order you need. Simply select the module and click the up and down buttons to position it in the desired location.
 4. Each module has a different icon depending on where it originated.
 5. Click OK to verify and save the settings.

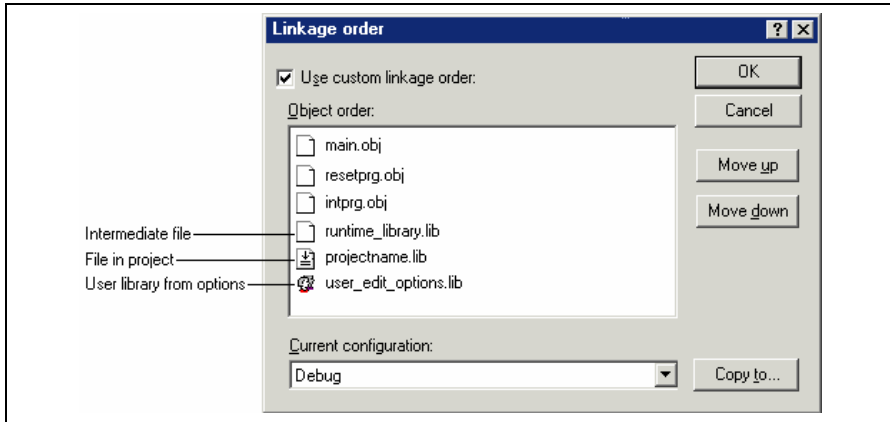

Figure 3.25: Linkage order Dialog

When you are using multiple configurations it is likely that the linkage order will be very similar. To do this effectively you can copy the current settings in the dialog to other configurations. This is described below:

- To copy the linkage order from one configuration to another:
 1. Click the [Build->Linkage order...] menu item.
 2. Select the configuration you wish to copy in the current configuration list. This defaults to the currently loaded configuration.
 3. Click the Copy to... button this displays a dialog and asks you which one of the configurations in the current project you wish to copy the current linkage order to. Select a configuration and click OK.
 4. Click OK to verify and save the changes.

4. Using the Editor

This chapter describes how to use the editor that is provided with the High-performance Embedded Workshop.

4.1 The Editor Window

The editor window (figure 4.1) contains the file windows that are being viewed or edited. Only one window is active at anytime. This window is called the active window (or current window) and its title bar will appear a different color from that of the others (“dbstc.c” is the active window in figure 4.1). All text operations such as typing, pasting text and so forth only affect the active window. To switch to another source file window (i.e. to make some other window the active window) there are a number of methods:

- Click on it if it is visible.
- Press **CTRL+TAB** to cycle through the windows one after another.
- Select the window by name from the “Window” menu.
- Select its tab at the bottom of the editor window.

When a file has been edited, an asterisk (*) is appended to the window’s title bar. The asterisk remains there until the file is saved. The asterisk is also removed if all of the edited changes are undone in the current window.

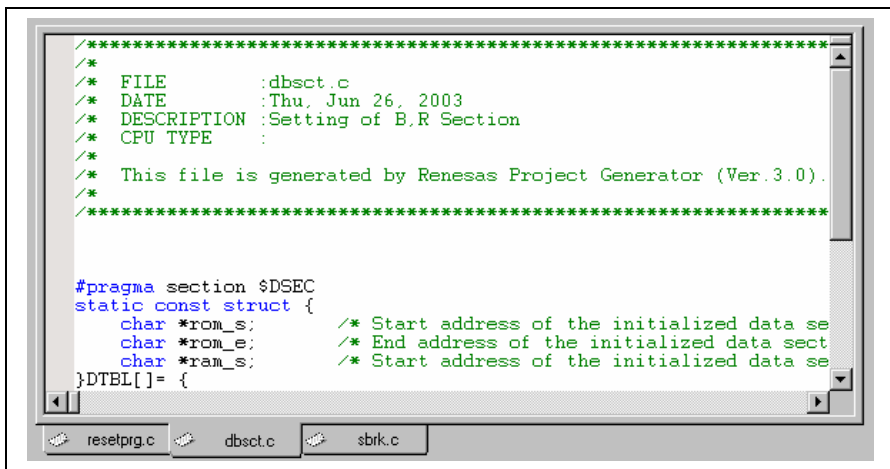

Figure 4.1: Editor Window

4.2 Working with Multiple Files

The file area is where you will work with the files of your project. The editor allows you to have many files open at one time, to switch between them, to arrange them in different configurations and to edit them in whichever order you want to. The operations that you can perform upon the windows are typical of most Windows® applications and they can be found under the **[Window]** menu:

- **[Window->Cascade]**
Arrange all open windows so that they overlap, with the top left of each window visible.
- **[Window->Tile Horizontally]**
Arrange all open windows in sequence (horizontally) so that they occupy the entire editor window with no overlapping edges.
- **[Window->Tile Vertically]**
Arrange all open windows in sequence (vertically) so that they occupy the entire editor window with no overlapping edges.
- **[Window->Arrange Icons]**
Line up all minimized windows at the bottom of the editor window.
- **[Window->Close All]**
Close all open editor windows.

The files within the editor can be displayed in a “notebook” style. This means that each file has a separate tab associated with it to aid in navigating between files.

☞ To show files in notebook:

1. Select **[Tools->Options...]**. The “Tools Options” dialog box will be displayed. Select the “Editor” tab.
2. Set the “Show files in notebook” check box as appropriate.
3. Click “OK” for the new settings to take effect.

4.2.1 The Editor Toolbars

The editor has four related toolbars: Editor, Search, Bookmarks and Templates. They provide a shortcut to the functions of the editor, which you will use most often. The following sections describe each buttons function.

4.2.2 Editor Toolbar Buttons



New File

The new file button creates a new source file window with a default name. When you save the file, you can specify your own filename.



Open File

Click this button if you want to open a file. It invokes a standard file chooser - select the file which you want to open and then click “Open”.



Save File

Saves the active source file.



Save All Files

Saves all of the files in the editor.



Print File

To print the contents of the current window, click this button.



Cut

Clicking this button will remove the current text selection and place a copy of it onto the Windows® clipboard (it can be pasted back to a file with a paste operation).



Copy

This button allows you to copy the current text selection into the Windows® clipboard.



Paste

The paste button copies the contents of the clipboard into the active window at the position of the insertion cursor.



Match Braces

The match braces button highlights text between braces of type { }, [] and (). This is particularly useful when attempting to find out the structure of C/C++ code blocks which are opened with { and closed with }. To use it, select the open brace to match from, or place the cursor before it, and then click this button. For further information on brace matching, refer to the “Brace Matching” section later in this chapter.



Insert Template

To insert a pre-defined template at the current cursor position, click this toolbar button. The “Insert Template” dialog box will be invoked. Select a template name and then click OK. For further information on templates, refer to the “*Templates*” section later in this chapter.



Toggle Bookmark

The High-performance Embedded Workshop editor provides standard bookmark capabilities. To set a bookmark, select the line to mark and click this button (a green mark will then appear in the blank on the left side of the editor window). To remove a bookmark, select the line to remove a bookmark and click this button (the mark in the blank on the left side of the editor window will disappear). For further information on bookmarks, refer to the “*Bookmarks*” section later in this chapter.

4.2.3 Search Toolbar Buttons



Find in Files

To search several files for a text string then click this button. All find results are displayed in the “Find in Files” tab of the “Output” window. For further information, refer to the “*Searching and Navigating Through Files*” section later in this chapter.



Find

Click this button if you want to find a certain text string in the current file. It invokes a find dialog box where you can specify the search parameters.



Find Next

Finds the next occurrence of the current search string.



Find Previous

Finds the previous occurrence of the current search string.

4.2.4 Bookmarks Toolbar Buttons



Toggle Bookmarks

Sets a bookmark at the current line or clears a bookmark at the current line.



Next Bookmark

Jumps to the next bookmark in the current file from the current line.



Previous Bookmark

Jumps to the previous bookmark in the current file from the current line.



Clear All Bookmarks

Clears all bookmarks in the current file.

4.2.5 Templates Toolbar Buttons



Define Template

Specify template text for subsequent insertion.



Insert Template

Insert the template selected in the drop-down list at the current cursor position.

4.3 Standard File Operations

4.3.1 Creating a New File

☞ To create a new editing window:

Select [**File->New**] or click the new file toolbar button () or press **CTRL+N**.

The window will be given an arbitrary name by default. You can provide a new name when you save the file.

4.3.2 Saving a File

☞ To save the contents of an editing window:

1. Ensure that the window, whose contents you want to save, is the active window.
2. Select [**File->Save**] or click the save file toolbar button () or press **CTRL+S**.
3. If the file has not been saved before, a file save dialog box will be displayed. Enter a filename, specify a directory and then click OK to create the file with the name given, in the directory specified.
4. If the file has been saved before, then the file will be updated (no dialog box will be displayed).

☞ To save the contents of an editing window under a new name:

1. Ensure that the window, whose contents you want to save, is the active window.
2. Select [**File->Save As...**].
3. A file save dialog box will be displayed. Enter a filename, specify a directory and then click OK to create the file with the name given, in the directory specified.

4.3.3 Saving all Files

☞ To save the contents of every open editor window:

1. Select [**File->Save All**] or click the save all files toolbar button ()
2. If any of the files has not been saved before, a file save dialog box will be displayed. Enter a filename, specify a directory and then click OK to create the file with the name given, in the directory specified.
3. If any of the files have been saved before, then the file will be updated (no dialog box will be displayed).

4.3.4 Opening a File

☞ To open a file:

1. Select [**File->Open...**] or click the open file toolbar button () or press **CTRL+O**.
2. An open file dialog box will be displayed. Use the directory browser (on the right) to navigate to the directory in which the file you want to open is located. Use the "Files of type" combo box to select the type of file you want to open (or set it to "All Files (*.*)" to see every file in a directory).
3. Once you have located the file select it and click "Open".

The High-performance Embedded Workshop keeps track of the last four files that you have opened and adds them to the file menu under the "Recent Files" sub-menu. This gives you a shortcut to opening files which you have used recently.

☞ To open a recently used file:

Select the [**File->Recent Files**] menu option and from this sub-menu select the desired file.

You can also open a file via the "Projects" tab of the "Workspace" window. Either double click the file you want to open or select it, click the right mouse button (to invoke a pop-up menu) and then choose the [**Open <file>**] menu option (where <file> is the name of the file selected).

4.3.5 Closing Files

☞ To close individual files select one of the following methods:

1. Double click on the editor window's system menu (located at the top left of each window when not maximized).
2. Click on the editor window's system menu (located at the top left of each window when not maximized) and select the "Close" menu option.
3. Ensure that the window that you want to close is the active window and then press **CTRL+F4**.
4. Ensure that the window that you want to close is the active window and then select [**File->Close**].
5. Click on the close button (located at the top right of each window when not maximized).

☞ To close all windows at once:

Select [**Window->Close All**].

4.4 Editing a File

The High-performance Embedded Workshop editor supports standard editing functionality. This is available through the usual methods (i.e. the menu, toolbar and keyboard shortcuts) and is additionally supported via a pop-up menu (or local menu) that is local to each editor window. To invoke it, place the pointer in an open window and click the right mouse button. Table 4.1 outlines the basic operations that are provided by the editor.

Table 4.1 Basic Editing Operations

Operation	Effect	Action
Cut	Removes highlighted text and places it on the Windows® clipboard	Click the cut toolbar button Select [Edit->Cut] Select [Cut] - local menu Press CTRL+X
Copy	Places a copy of the highlighted text into the Windows® clipboard	Click the copy toolbar button Select [Edit->Copy] Select [Copy] - local menu Press CTRL+C
Paste	Copies the contents of the Windows® clipboard into the active window at the position of the insertion cursor	Click the paste toolbar button Select [Edit->Paste] Select [Paste] - local menu Press CTRL+V
Delete	Removes highlighted text (it is not copied to the Windows® clipboard)	Select [Edit->Clear] Select [Clear] - local menu Press Delete
Select All	Selects (i.e. highlights) the entire contents of the active window	Select [Edit->Select All] Select [Select All] - local menu
Undo	Reverses the last editing operation	Select [Edit->Undo] Select [Undo] - local menu Press CTRL+Z
Redo	Repeats the last “undone” editing operation	Select [Edit->Redo] Select [Redo] - local menu Press CTRL+Y

4.5 Searching and Navigating through Files

The High-performance Embedded Workshop editor provides find, replace and file navigation functionality. The following three sections detail how to use these features.

4.5.1 Finding Text

☞ To search for text in the current file:

1. Ensure that the window, whose contents you want to search, is the active window.
2. Position the insertion cursor at the point from which you want to start your search.
3. Select **[Edit->Find...]**, press **CTRL+F**, select **[Find...]** from the editor window's local menu or click the find toolbar button (🔍). The "Find" dialog box will be displayed (figure 4.2).



Figure 4.2: Find Dialog

4. Enter the text that you want to search for into the "Find what" field, or select a previous search string from the drop-down list box. If you select text before invoking the find operation, the selected text will be automatically placed into the "Find what" field.
5. If you would like to search for character string as a whole word then check the "Match whole word only" check box. When this option is not selected, the search will be for any string that is matched by the search string.
6. If you would like your search to be case sensitive (i.e. to distinguish between upper and lower case letters) then check the "Match case" check box.
7. If your search string uses regular expressions then check the "Regular expressions" check box. Refer to Appendix B, "Regular Expressions" for further information.
8. The "Direction" radio buttons allow you to select the direction of the search. Selecting "Down" means that the search will be performed from the insertion cursor towards the bottom of the file. Selecting "Up" means that the search will be performed from the insertion cursor towards the top of the file.
9. Click the "Find Next" button to begin the search. Click "Cancel" to stop the find action.

The High-performance Embedded Workshop editor also allows you to search for a string across many files.

4.5.2 Finding Text in Multiple Files

☞ To search for text in many files:

1. Select [Edit->Find in Files...], select [Find in Files...] from the editor window's local menu or click the find in files toolbar button (🔍). The "Find in Files" dialog box will be displayed (figure 4.3).

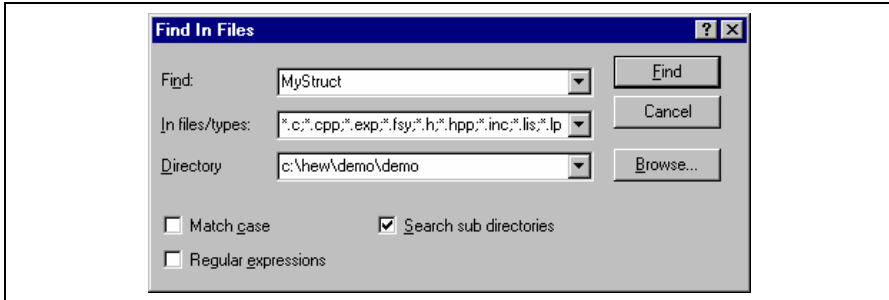

Figure 4.3: Find in Files Dialog

2. Enter the text that you want to search for into the "Find" field, or select a previous search string from the drop-down list box. If you select text before invoking the find operation, the selected text will be automatically placed into the "Find" field.
3. Enter the file extensions of the files you would like to search into the "In files/types" field. If several extensions are specified be sure to separate them with a semicolon (e.g. *.c;*.h).
4. Enter the directory in which you would like to search files into the "Directory" field. Alternatively you may browse to the desired directory graphically if you click the "Browse..." button.
5. If you would like to search the directory specified and all directories below it then check the "Search sub directories" check box. If you just want to search the single directory specified in the "Directory" field then ensure that this check box is not checked.
6. If you would like to search for character string as a whole word then check the "Match case" check box. When this option is not selected, the search will be for any string that is matched by the search string.
7. If you would like your search to be case sensitive (i.e. to distinguish between upper and lower case letters) then check the "Match case" check box.
8. Click "Find" to begin the search. Any matches found will be displayed in the "Find in Files" tab of the "Output" window. To jump to an instance of the string, double click on the desired entry in the "Output" window.

4.5.3 Replacing Text

Replacing text is similar to finding text, as discussed in the previous section. The difference is that when the text is found you have the option to replace it with other text.

☞ To replace text in a file:

1. Ensure that the window, whose contents you want to replace, is the active window.
2. Position the insertion cursor at the point from which you want to start your search.
3. Select [Edit->Replace...], press CTRL+H or select [Replace...] from the editor window's local menu. A replace dialog box will be displayed (figure 4.4).
4. Enter the text that you want to search for into the "Find what" field, or select a previous search string from the drop-down list box. If you select text before invoking the replace operation, the selected text will be automatically placed into the "Find what" field.
5. Enter the text that you want to replace the search string with into the "Replace with" field, or select a previous replace string from the drop-down list box.

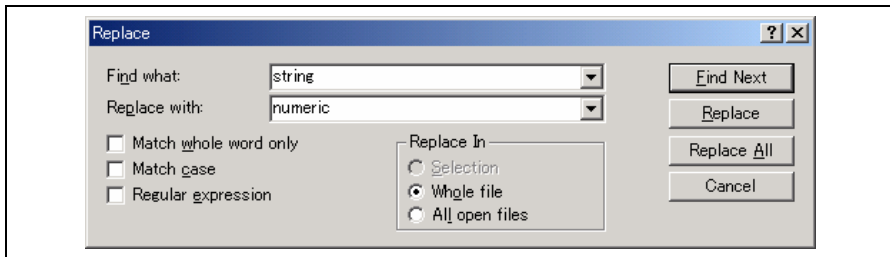

Figure 4.4: Replace Dialog

6. If you would like to search for character string as a whole word then check the "Match whole word only" check box. When this option is not selected, the search will be for any string that is matched by the search string.
7. If you would like your search to be case sensitive (i.e. to distinguish between upper and lower case letters) then check the "Match case" check box.
8. If your search string uses regular expressions then check the "Regular expressions" check box. Refer to appendix B, "Regular Expressions" for further information.
9. If you clicked "Find Next", the editor will search for the first occurrence of the search string. Click "Replace" if you want to replace it. Click "Replace All" to replace all occurrences or click "Cancel" to stop the replace action. If you select "Selection" in "Replace In", selected range of the text is replaced. If you select "whole file", the whole files are replaced. If you select all open files, all files that are currently open in the editor have the replace operation carried out on them.

4.5.4 Jumping to a Specified Line

- ☞ To jump to a line in a file:
 1. Ensure that the window, whose contents you want to replace, is the active window.
 2. Select [**Edit->Goto Line...**], press **CTRL+G**, or select [**Goto Line...**] from the editor window's local menu. A goto line dialog box will be displayed (figure 4.5).
 3. Enter into the dialog box the number of the line that you want to go to, and then click "OK".
 4. The insertion cursor will be placed at the start of the line number specified.

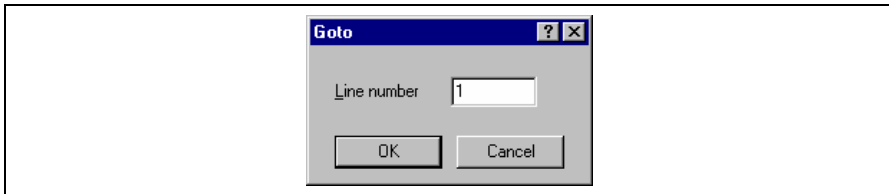







Figure 4.5: Goto Dialog

4.6 Bookmarks

When working with many large files at a time, it can become difficult to locate specific lines or areas of interest. Bookmarks enable you to specify lines that you want to jump back to at a subsequent time. One example of its use is in a large C file where you may want to set a bookmark on each function definition. Once a bookmark has been set, it exists until it is removed or the file is closed.

- ☞ To set a bookmark:
 1. Place the insertion cursor on the line to mark.
 2. Select [**Edit->Bookmarks->Toggle Bookmark**], press **CTRL+F2**, select [**Bookmarks->Toggle Bookmark**] from the local menu or click the toggle bookmark toolbar button ().
 3. A green mark appears in the blank on the left side of the line to indicate the presence of an active bookmark.
- ☞ To remove a bookmark:
 1. Place the insertion cursor on the marked line.
 2. Select [**Edit->Bookmarks->Toggle Bookmark**], press **CTRL+F2**, select [**Bookmarks->Toggle Bookmark**] from the local menu or click the toggle bookmark toolbar button ().
 3. The mark will be removed and the line will return to normal text.
- ☞ To jump to the next bookmark in a file:
 1. Ensure that the insertion cursor is somewhere within the file to be searched.
 2. Select [**Edit->Bookmarks->Next Bookmark**], press **F2** or select [**Bookmarks->Next Bookmark**] from the local menu or click the next bookmark toolbar button ().
- ☞ To jump to the previous bookmark in a file:
 1. Ensure that the insertion cursor is somewhere within the file to be searched.
 2. Select [**Edit->Bookmarks->Previous Bookmark**], press **SHIFT+F2** or select [**Bookmarks->Previous Bookmark**] from the local menu or click the previous bookmark toolbar button ().
- ☞ To remove all bookmarks in a file:
 1. Ensure that the window, whose bookmarks you want to remove is the active window.
 2. Select [**Edit->Bookmarks->Clear All Bookmarks**] or select [**Bookmarks->Clear All Bookmarks**] from the local menu or click the clear all bookmarks toolbar button ().

4.7 Printing a File

- ☞ To print a file:
 1. Ensure that the window, whose contents you want to print, is the active window.
 2. Select [**File->Print...**], or click the print toolbar button () or press **CTRL+P**.

4.8 Configuring Text Layout

The following sections detail how to set-up the layout of the text within the editor windows.

4.8.1 Page Set-up

When you print a file from the High-performance Embedded Workshop editor, the settings in the print dialog box affect the way in which the file is printed (e.g. double or single sided). Control over how the text is formatted on the page can also be controlled via the page set-up option. This allows you to specify the margins (top, bottom, left and right) of your printouts. It is often necessary to set this because some printers cannot print to the edges of an A4 page. Furthermore, some users have their own layout requirements (e.g. a large left hand margin so that code can be placed in an A4 binder).

- To set-up the page margins:
 1. Select [**File->Page Setup...**]. The “Page Setup” dialog will be invoked (figure 4.6).
 2. Enter into the edit fields the margins required (set the “inch” or “mm” radio buttons to set the measurements).
 3. Click “OK” for the new settings to take effect.

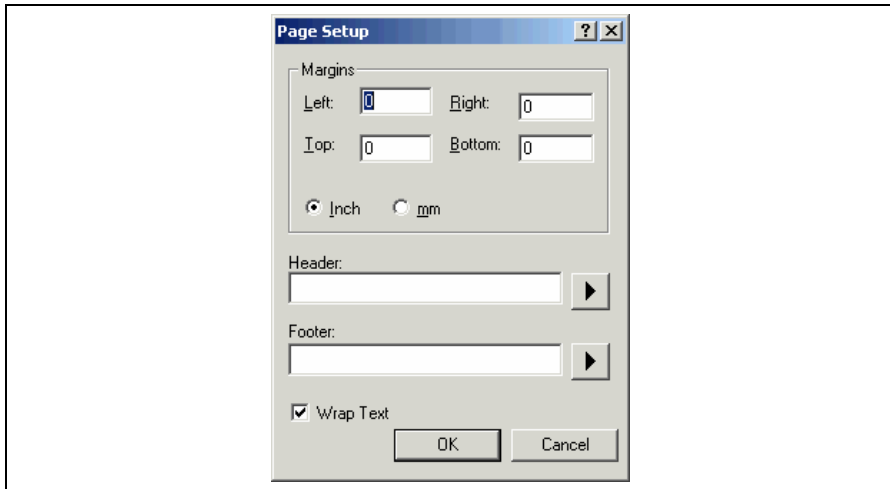

Figure 4.6: Page Setup Dialog

- ☞ To set-up the page header and footers:
 1. Select [**File->Page Setup...**]. The “Page Setup” dialog will be invoked (figure 4.6).
 2. Enter into the header and footer edit fields the text required to be displayed. All normal placeholders are available along with page numbering, text justification and date fields. These are all expanded before the page is to be printed.
 3. Click “OK” for the new settings to take effect.

- ☞ To set-up print wrapping
 1. Select [**File->Page Setup...**]. The “Page Setup” dialog will be invoked (figure 4.6).
 2. Click the wrap text check box. This switches on the wrap text facility when printing so no text is truncated and everything is visible.
 3. Click “OK” for the new settings to take effect.

4.8.2 Changing Tabs

- To change tab size:
 1. Select [**Tools->Options...**]. The “Options” dialog will be displayed. Select the “Editor” tab (figure 4.7).
 2. Enter into the “Tab size” field the number of desired tabs.
 3. Click “OK” for the tab setting specified to take effect.

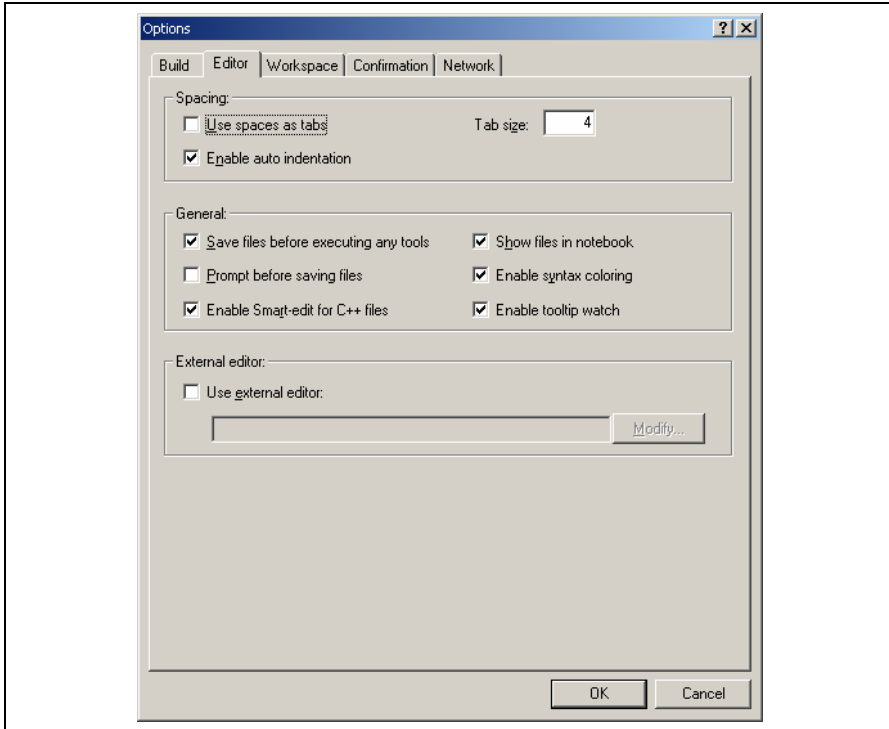

Figure 4.7: Options Dialog Editor Tab

When a **TAB** key is pressed in the editor a tab character is usually stored in the file. However, sometimes it is preferable to store spaces instead. The representation of tab characters can be controlled via the “Options” dialog.

- To use spaces as tabs:
 1. Select [**Tools->Options...**]. The “Options” dialog will be displayed. Select the “Editor” tab (figure 4.7).
 2. Set the “Use spaces as tabs” check box as appropriate.
 3. Click “OK” for the tab setting specified to take effect.

4.8.3 Auto Indentation

When you press return in a standard editor the insertion cursor will move to the next line down, at the first column (i.e. against the left hand side of a window). Auto Indentation is a feature which, when return is pressed, places the insertion cursor on the next line (as before) but under the first non-white space character of the previous line. This enables you to type neat C/C++ or assembler code faster as you don't have to type leading spaces or tabs yourself.

Figure 4.8 illustrates two examples. The first (i) shows the effect of pressing return when the auto indentation feature is disabled - the insertion cursor returns to the left-hand side of the window on the next line. When the line "int z=20" is typed, it is not aligned with the previous two lines. The second example (ii) shows the effect of pressing return when auto indentation is enabled - the insertion cursor drops underneath the "i" of the previous line. Now, when the line "int z=20" is typed, it is automatically aligned (i.e. automatically indented).

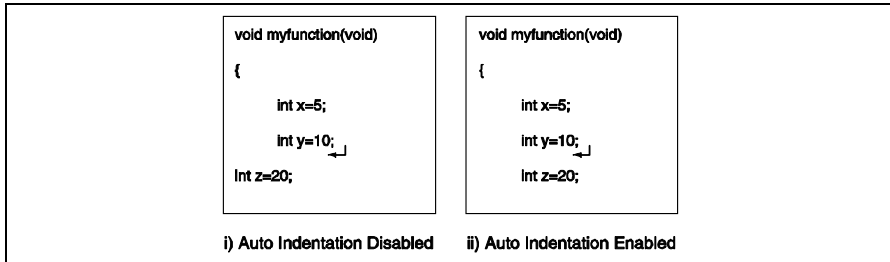

Figure 4.8: Effect of Auto Indentation

- ☞ To enable/disable Auto Indentation:
 1. Select [**Tools->Options...**]. The "Options" dialog will be displayed. Select the "Editor" tab (figure 4.7).
 2. Set the "Enable auto indentation" check box accordingly.
 3. Click "OK" for the setting of the auto indentation check box to take effect.

4.9 Splitting a Window

The High-performance Embedded Workshop editor allows you to split a text window into two. Figure 4.9 shows the split bar button which is located just underneath the maximize button at the top right hand corner of any text window.

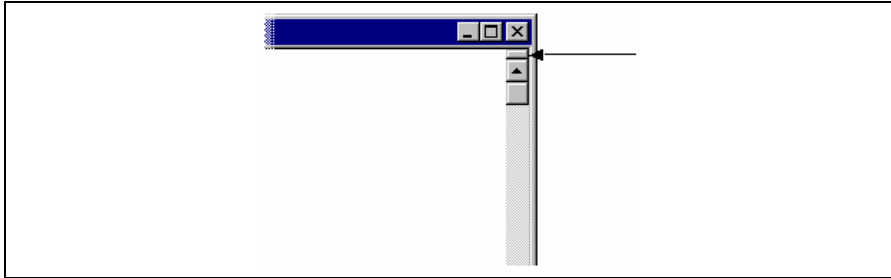

Figure 4.9: Split Bar Button

- To split a window:
Double click on the split bar button to split the window in half or click on the split bar button, keep the button pressed, move the mouse down and then release the mouse button at the point you want to split the window.
- To adjust the position of the split bar:
Click on the split bar itself, keep the button pressed then move the bar to the new position and then release the button.
- To remove the split bar:
Double click on the split bar or move the split bar to the top or bottom of the window.

4.10 Configuring Text

The following sections detail how to change the appearance of the text displayed in the editor windows.

4.10.1 Changing the Editor Font

The High-performance Embedded Workshop allows you to specify the font to be used in its internal editor. All editor windows, regardless of the file type, use the same font.

- To change the editor font:
 1. Select [**Tools->Format Views...**]. The “Format Views” dialog will be displayed. Select the Source icon in the tree (figure 4.10).
 2. Select the desired font from the “Font” list.
 3. Select the size of the font from the “Size” list.
 4. Click “OK” to confirm the new editor settings.

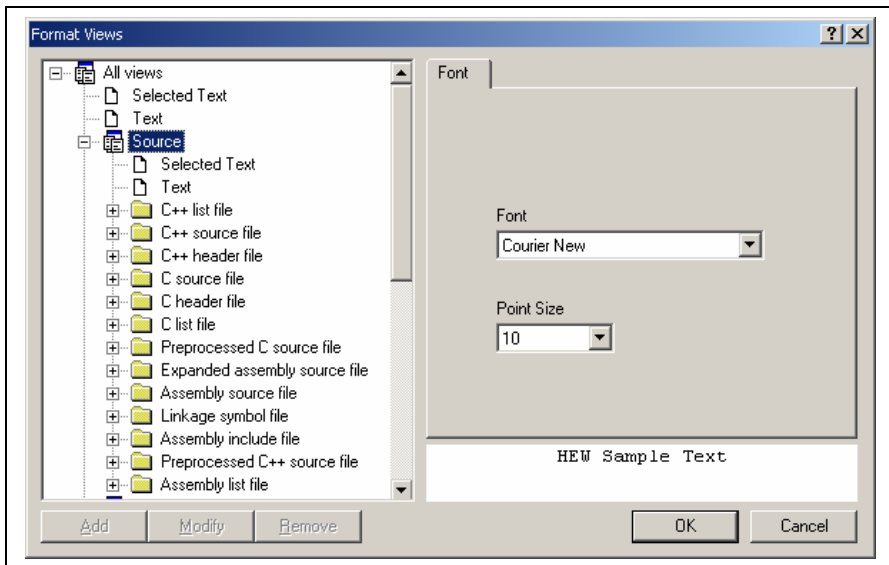

Figure 4.10: Format Views Dialog Font Tab

4.11 Syntax Coloring

To enhance code readability, the HEW editor can display specific strings (i.e. keywords) in different colors. For instance, C source code comments could be shown in green and C types (e.g. int) could be shown in blue.

The coloring method used can be specified on a file group by file group basis. For example, you can define different color schemes for a C source files, text files, map files or even your own files.

- ☞ To change existing colors:
 1. Select [**Tools->Format Views...**]. The “Format Views” dialog will be displayed.
 2. Select the item underneath the icon in the tree you wish to modify the colour for. This should be the file type (e.g. C source file) and correct keyword group (e.g. identifier or pre-processor).
 3. Select the “Colour” tab.
 4. Modify the “Foreground” and “Background” color lists as desired. The color “SYSTEM” refers to the current window foreground and background settings in control panel.
 5. Click “OK” for the new colors to take effect.

- ☞ To create new keyword groups:
 1. Select [**Tools->Format Views...**]. The “Format Views” dialog will be displayed.
 2. Select the file type in the tree to which you wish to add the new keyword group.
 3. Click “Add...” underneath the tree. The “Add Category” dialog box will be displayed (figure 4.11). Enter the name of the keyword group in the “Category Title” field, then click “OK” to create the new keyword group.

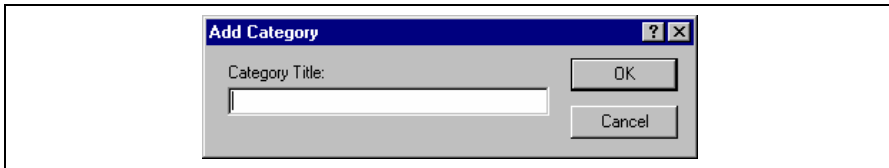

Figure 4.11: Add Category Dialog

- ☞ To create new keywords:
 1. Select [**Tools->Format Views...**]. The “Format Views” dialog will be displayed.
 2. Select the item underneath the source view icon in the tree you wish to modify the syntax highlighting for. This should be the file type (e.g. C source file) and correct keyword group (e.g. identifier or pre-processor).
 3. Select the “Keywords” tab (figure 4.12).

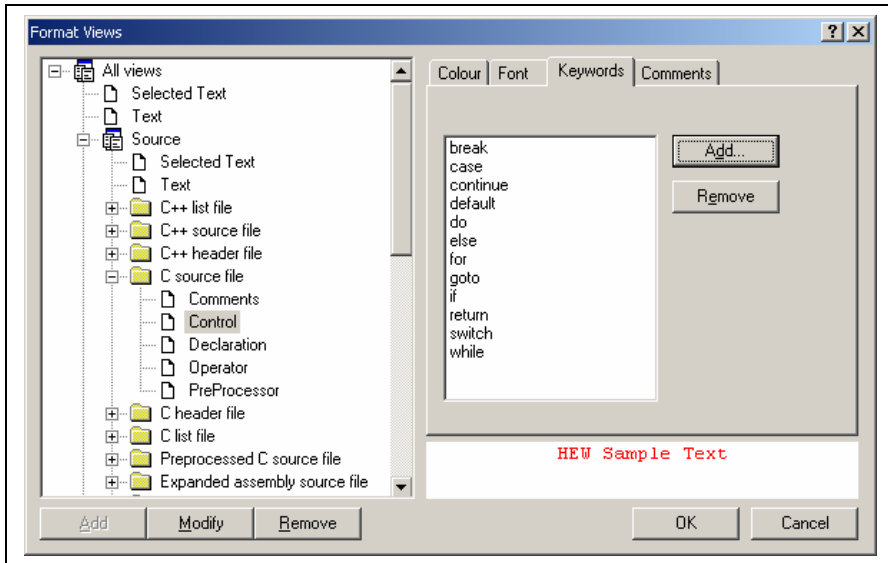

Figure 4.12: Format Views Dialog Keywords Tab

4. Click the “Add...” button to add a keyword. Then the “Add Keyword” dialog (figure 4.13) will be launched. Specify a keyword in the “Keyword” field and click “OK” to close the dialog. To remove a keyword, select the keyword and click the “Remove” button.

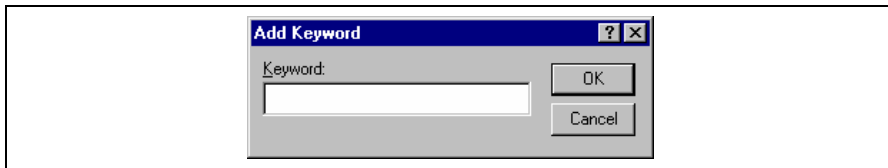

Figure 4.13: Add Keyword Dialog

When you create a new file, syntax coloring will not be active as a new file does not initially have an extension (new files are named arbitrarily by the editor without an extension). In order to activate syntax coloring, you must save the new file with a name, which has one of the above extensions.

- ☞ To disable/enable syntax coloring:
 1. Select [**Tools->Options...**]. The “Options” dialog will be displayed. Select the “Editor” tab (figure 4.7).
 2. Set the “Enable syntax coloring” check box as necessary and then click “OK”.

4.12 Templates

When developing software it is often necessary to enter the same text repeatedly, for instance, when typing a function definition, for loop or a comment block for a function. The High-performance Embedded Workshop editor allows you to specify a block of text (or template), which can be inserted into the currently active editor window. Thus, once a template has been defined, it can be automatically inserted without the need to re-enter it manually.

4.12.1 Defining a Template

➤ To define a template:

1. Select [**Edit->Templates->Define Templates...**], select [**Templates->Define Templates...**] from the local menu, or click on the define template toolbar button (). The dialog shown in figure 4.14 will be displayed.

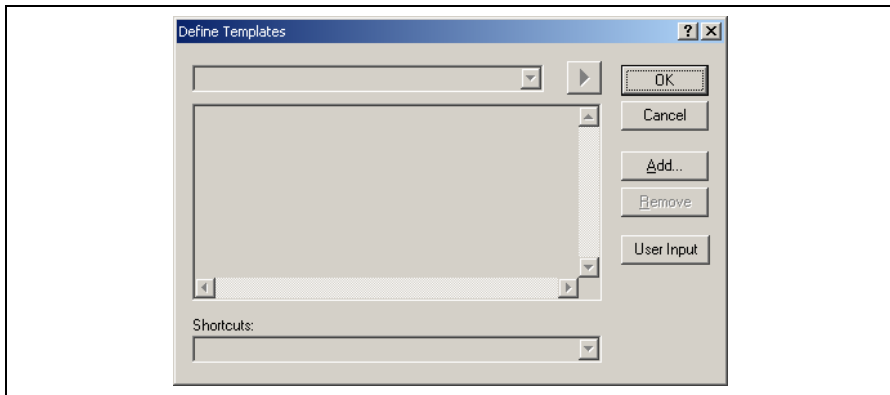

Figure 4.14: Define Template Dialog

2. Click “Add”. A dialog is displayed that asks you to enter your chosen template name. This name must be unique otherwise a duplicated template name message will be displayed and the template will not be added.
3. If you want to modify an existing template use the “Template name” drop down menu to select which template you want to modify.
4. Enter the desired text into the “Template text” text area. You can copy text from another editor window and then paste it into this dialog using **CTRL+V**.
5. There are 10 shortcut keys reserved for templates. If you want to designate one of these select the key in the drop list at the bottom of the edit template dialog. These range from CTRL+0 to CTRL+9.
6. Enter the following placeholder to insert special information when the template is inserted:

Table 4.2 Placeholders Used in Templates

Menu Entry	Placeholder	Replaced With
File path + name	\$(FULLFILE)	Filename (including full path)
File name	\$(FILENAME)	Filename (excluding path including extension)
File leaf	\$(FILELEAF)	Filename (excluding path and extension)
Workspace name	\$(WORKSPNAME)	Workspace name
Project name	\$(PROJECTNAME)	Project name
Line number	\$(LINE)	First line number of template insertion
Time	\$(TIME)	Current time
Date, text	\$(DATE_TEXT)	Current date in text form
Date, day/month/year	\$(DATE_DMY)	Current date, in dd/mm/yy form
Date, month/day/year	\$(DATE_MDY)	Current date, in mm/dd/yy form
Date, year/month/day	\$(DATE_YMD)	Current date, in yy/mm/dd form
User name	\$(USER)	Current windows user
Cursor position	\$(CURSOR)	Insertion cursor – Positions the cursor in this position after template has been inserted

7. Enter the \$(CURSOR) character to specify where the insertion cursor is to be placed after the template has been inserted. If this is not specified then the insertion cursor will be placed after the last character in the template (as in a normal paste operation).

User Input

When defining a template it is possible to define a user input field. Using the following placeholder specifies this \$(USERINPUT<n:1-10|"<some text>"). The n is a number, which identifies the user input identifier. These placeholders can be added manually but the user input button on the define templates dialog adds these placeholders in an automated manner. When the template is inserted into a file a dialog is displayed which allows you to enter some custom text for each of these fields. This text is then inserted instead of the placeholder. You can define ten of these user input fields.

Figure 4.15 shows a list of templates, which is located on the “Templates” tab of the “Workspace” window.

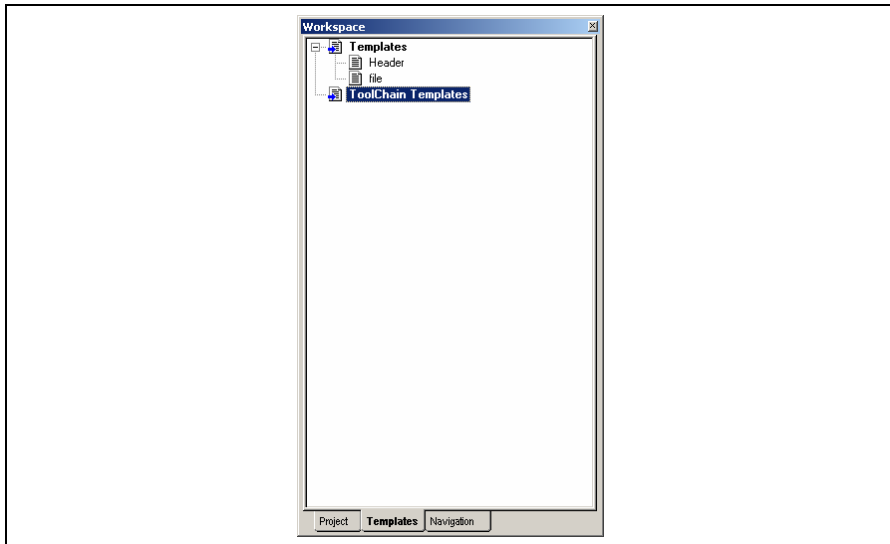



Figure 4.15: Templates view

Any new templates, which have been added to the HEW, are displayed under the templates folder. The toolchain templates folder is for templates, which are read only and have been provided for use in the HEW system by the current toolchain. Templates in this view can be dragged for insertion into an editor file. It is also possible to drag an area of text from the editor into the templates folder for quick template creation. Right clicking on this view displays a pop-up so that you can quickly add a new template, remove the current selection and edit the current selection.

4.12.2 Deleting a Template

- ☞ To delete a template:
 1. Select [**Edit->Templates->Define Templates...**], select [**Templates->Define Templates...**] from the local menu or click on the define template bookmark toolbar button (). The dialog shown in figure 4.14 will be displayed.
 2. Use the Template name drop down list to select the name of the template you wish to remove and then click the “Remove” button.
 3. Clicking “OK” saves the template changes and dismisses the dialog.

4.12.3 Inserting a Template

- ☞ To insert a template:
 1. Select a template in the toolbar, then click the insert template toolbar button (), select [**Edit->Templates->Insert Template...**] or select [**Templates-> Insert Template...**] from the local menu. The dialog is dismissed and the chosen template is added to the current editor window.

Note: It is also possible to use the defined keyboard shortcut or drag the template from the templates view.

4.12.4 Brace Matching.

Complicated source code can often become unwieldy, especially when blocks of C code are deeply nested within each other or when complex logic statements are expressed within an 'if' clause. To help in such situations, the High-performance Embedded Workshop editor provides a match brace feature which highlights text between braces of type { }, () and [].

➤ To find a matching brace:

1. Either highlight the open brace to match from or place the cursor before it.
2. Click the match braces toolbar button () , press **SHIFT+CTRL+M**, select [**Edit->Match Braces**] or select [**Match Braces**] from the local menu.

To check the structure of an entire file, place the cursor at its start and then repeatedly invoke the match brace operation. The editor will successively highlight each pair of braces in turn until there are no more to match.

4.13 Editor Column management

The editor in HEW has the ability to manage columns apart from the main editor column. These can be added and used by debugger feature. You can choose the column to display/undisplay.

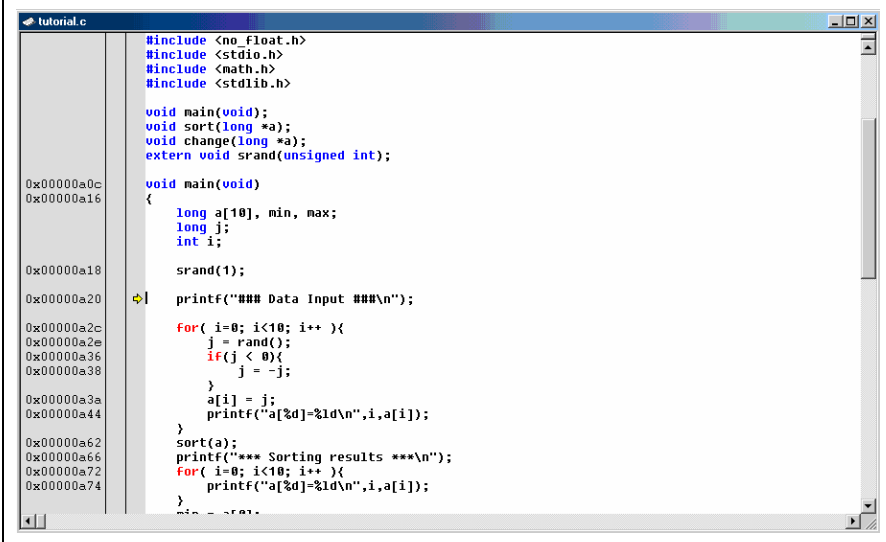

```
tutorial.c
#include <no_float.h>
#include <stdio.h>
#include <math.h>
#include <stdlib.h>

void main(void);
void sort(long *a);
void change(long *a);
extern void srand(unsigned int);

void main(void)
{
    long a[10], min, max;
    long j;
    int i;

    srand(1);

    printf("### Data Input ###\n");

    for( i=0; i<10; i++){
        j = rand();
        if(j < 0){
            j = -j;
        }
        a[i] = j;
        printf("a[%d]=%ld\n",i,a[i]);
    }

    sort(a);
    printf("### Sorting results ###\n");
    for( i=0; i<10; i++){
        printf("a[%d]=%ld\n",i,a[i]);
    }
}
```

0x00000a0c
0x00000a16

0x00000a18

0x00000a20
| printf("### Data Input ###\n");

0x00000a2c
0x00000a2e
0x00000a36
0x00000a38

0x00000a3a
0x00000a44

0x00000a62
0x00000a66
0x00000a72
0x00000a74

Figure 4.16: Editor columns

- To switch off a column in all source files:
 1. Right click on the editor window.
 2. Click the “Define Column Format...” menu item.
 3. The “Global Editor Column States” dialog is displayed (figure 4.17).
 4. The “Check status” shows whether the column is enabled or not. If it is checked it is enabled if the check box is gray this means that in some files the column is enabled and in other files it is not.
 5. Click “OK” for the new column settings to take effect.

- To switch off a column in one source files:
 1. Right click on the editor window, which you wish to remove a column from, and the editor pop-up is displayed.
 2. Click the Columns menu item and a cascaded menu item appears. Each column is displayed in this pop-up menu. If the column is enabled it has a tick next to its name. Clicking the entry will toggle whether the column is displayed or not.

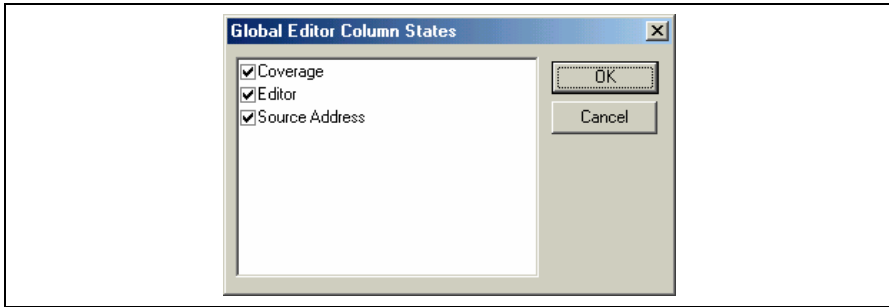

Figure 4.17: Global column state Dialog

4.14 Enable tooltip watch

Select [Tools->Options...] and then select the “Editor” tab (figure 4.7). By checking “Enable tooltip watch”, you can use the Tooltip Watch feature, the quickest way to look at a variable in the source program.

- ☞ To view a tooltip watch on the Editor window:
 1. Display the source file containing the variable that you want to examine on the Editor window (figure 4.18).
 2. Rest the mouse cursor over the variable name that you want to examine - a tooltip will appear near the variable showing a value of that variable.

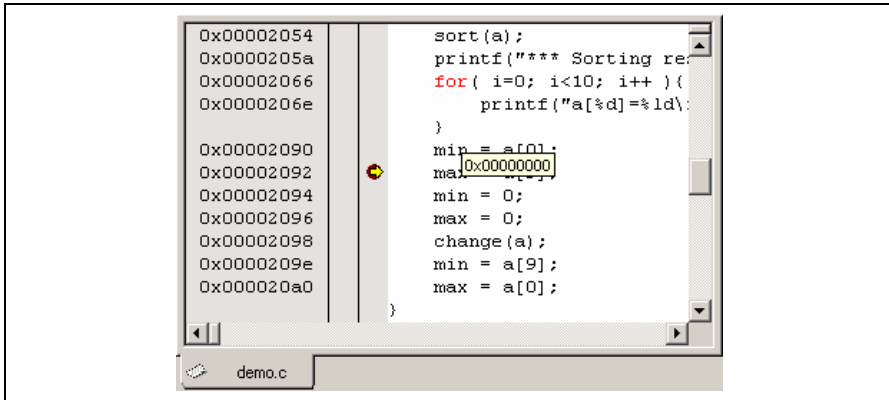

Figure 4.18: Viewing a tooltip watch

5. Tools Administration

You control the components, which can be used by the High-performance Embedded Workshop via the “Tools Administration” dialog (figure 5.1), which is invoked via [Tools->Administration...]. Modification of the “Tools Administration” dialog box is only possible when no workspace is open, while only reference is possible when a workspace is open.

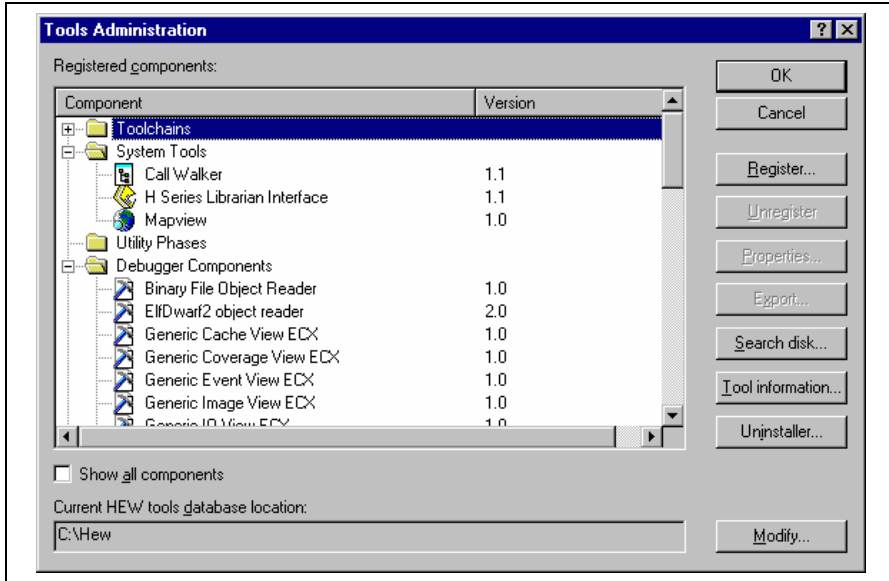

Figure 5.1: Tools Administration Dialog

There are five standard types of component:

- **Toolchains** - a set of build phases (e.g. compiler, assembler, and linker). These components provide the build capability.
- **System Tool** - an application (.EXE), which can be launched from the “Tools” menu. They are often provided as extra applications, which support the toolchain (e.g. an external debugger like the Hitachi Debugging Interface (HDI) or an interactive graphical librarian).
- **Utility Phase** - a “ready made” build phase which supports some specific build functionality (e.g. analyze complexity of source code, count lines of source code, etc.). These components provide added functionality to the build that is not toolchain specific.
- **Debugger Component** – a component that supports some specific debugger functionality (e.g. Target platform, Object reader, etc).
- **Extension Component** – a component that provides key functionality in a certain area of the HEW system. These components cannot be unregistered when installed (e.g. The HEW builder, debugger and flash support).

5.1 Tool Locations

The HEW maintains the locations of HEW compatible components automatically as each new tool is installed. After installation, the HEW stores information about the component (including its location) – this is referred to as *registration*. Although initial registration is automatic, during the course of development or if you want to manage the tools being used in your projects more effectively, you may need to register components yourself. The remainder of this chapter discusses registration and how it affects you.

5.2 HEW Registration Files (*.HRF)

When a HEW compatible component (i.e. toolchain, system tool or utility phase) is installed, part of its installation will include a file with the extension **.HRF** (figure 5.2.i). This file, named a “HEW Registration File”, describes the component to the HEW. The process of registration refers to loading a component’s .HRF file into the tools administration dialog (figure 5.2.ii).

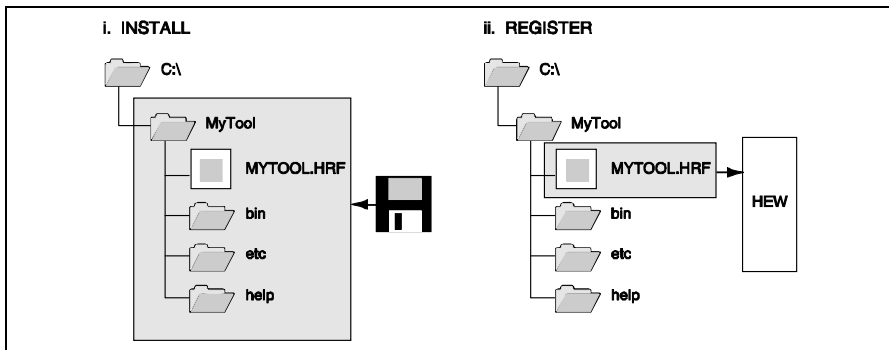

Figure 5.2: HRF File Location and Registration

In order to use a component with HEW it must first be registered. The “Tools Administration” dialog (figure 5.1) shows all currently registered components. To access it, ensure no workspaces are open and then select **[Tools->Administration...]**. If you attempt to access tools administration when there is a workspace open the tools administration dialog is opened but cannot be modified. When HEW is installed by default any new tools are automatically registered.

HEW stores tool information in a tool database file. By default this is created in the HEW application directory, however if you are working in a network environment this directory may be set to another location. It is possible to change the tool directory location.

☞ To change the tools location:

1. Select **[Tools->Administration...]**.
2. Click the “Modify” button for the “Current HEW tools database location” field.
3. Select the directory under which the new tool is located, then click “OK”.
4. This will switch the directory and change the tool location to the new directory. It will be necessary to scan for any new tools that may be in this location this is achieved by using the scan disk or register tool functionality.

5.3 Registering Components

The HEW will automatically attempt to register any new components installed since the last time it was invoked. However, in some circumstances you may need to register components yourself.

5.3.1 Searching Drives for Components

In some cases it is useful to search a drive for HEW compatible components. This is especially useful if the HEW installation was deleted or corrupted as it can recreate your tool information instantly.

☞ To search for components:

1. Click the “Search Disk...” button on the “Tools Administration” dialog (figure 5.1). The “Search Disk for Components” dialog will be displayed (figure 5.3).

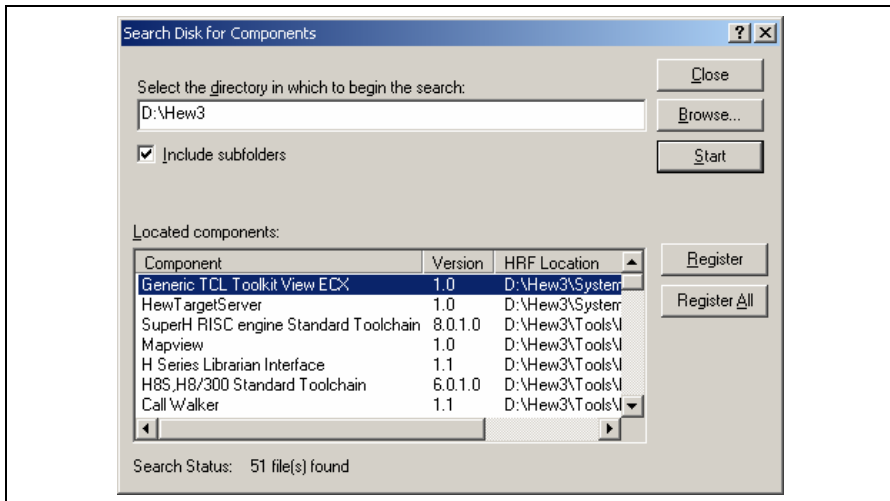

Figure 5.3: Search Disk for Components Dialog

2. Enter the directory in which you would like to search into the top field or browse to it graphically by clicking the “Browse...” button.
3. Check the “Include subfolders” check box if you would like to search the directory specified and all directories below it.
4. Click the “Start” button to begin the search. During the search, the “Start” button will change to a “Stop” button. Click the “Stop” button to halt the search at any time.
5. The results of the search are shown in the “Located components” list. Select a component and click “Register” to register an individual component or click “Register All” to register all located components.
6. Click “Close” to exit the dialog.

5.3.2 Registering a Single Component

The HEW allows you to navigate directly to a single component in order to register it. The HEW Registration File (*.HRF) is located in the root directory of a component's installation.

☞ To register a component:

1. Click the "Register..." button on the "Tools Administration" dialog. A standard file open dialog will be launched with its file filter set to "HEW Registration Files (*.hrf)".
2. Navigate to the .HRF file of the component you would like to register, select it and then click "Select".
3. A dialog will be invoked which displays information regarding the selected tool. Click "Register" to confirm that you want to register the tool or click "Close" to abort the operation.

5.4 Unregistering Components

The components, which are registered with the HEW, affect the way in which it behaves. For example, every compatible system tool, which is registered, will be added to the tools menu when a new project is created. Sometimes this may not be desirable. If so, open the "Tools Administration" dialog, select the component from the "Registered components" list and then click the "Unregister" button. A dialog will be invoked which asks you to confirm this action. Click "Yes" to confirm the action.

Note: Unregistering a component does not remove its installation from hard disk. It simply removes the information, which the HEW was storing about that component (i.e. it "disconnects" it from the HEW). The action can be easily reversed at anytime by registering the tool (see above). If you want to remove a component from the hard disk (i.e. uninstall a component) then refer to the section "*Uninstalling Components*" later in this chapter.

5.5 Viewing and Editing Component Properties

To view information regarding a component, select it from the “Registered components” list and then click the “Properties” button. The properties dialog will be displayed with the “General” tab selected (figure 5.4). This tab displays the name, version and location of the selected component. None of the information on this tab is editable.

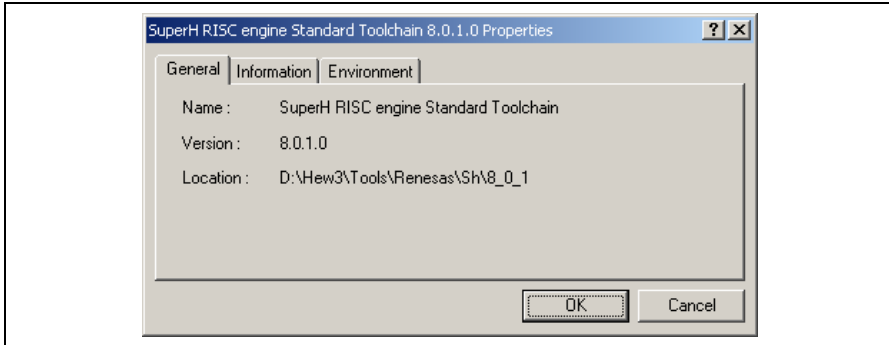

Figure 5.4: Properties Dialog General Tab

Select the “Information” tab to view any information about the component (figure 5.5). This may include copyright information, enhancements, bug fixes, user notes and so on.

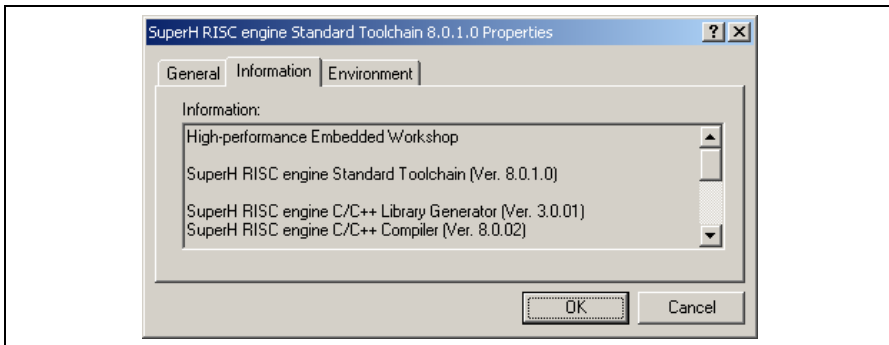

Figure 5.5: Properties Dialog Information Tab

Note that if the tool has a compatibility issue the problem may be reported in this information edit field.

Select the “Environment” tab, if it exists, to view and edit a component’s environment settings (figure 5.6). This dialog is most commonly used to modify the environment of a toolchain.

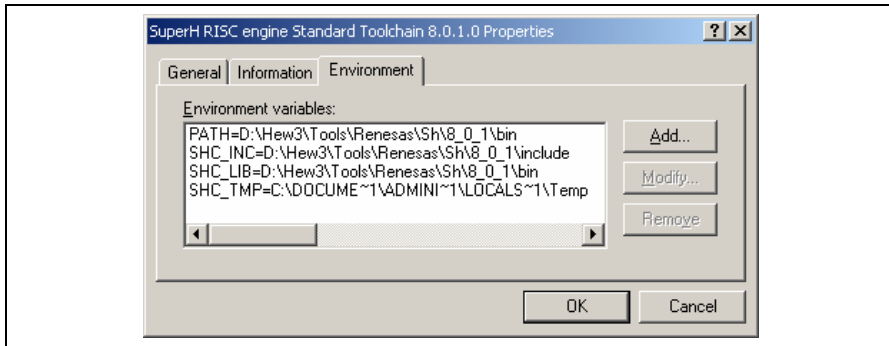

Figure 5.6: Properties Dialog Environment Tab

To add a new environment variable, click the “Add...” button (the dialog shown in figure 5.7 will be invoked). Enter the variable name into the “Variable” field, the variable’s value into the “Value” field and then click “OK” to add the new variable to the “Environment” tab. Placeholder pop-up menus are included to ensure that the environment can be specified as flexibly as possible. For a detailed description of placeholders see appendix C, “Placeholders”.

To modify an environment variable, select the variable that you want to modify from the “Environment” tab and then click the “Modify...” button. Make the required changes to the “Variable” and “Value” fields, and then click “OK” to add the modified variable to the “Environment” tab. To remove an environment variable, select it and then click the “Remove” button.

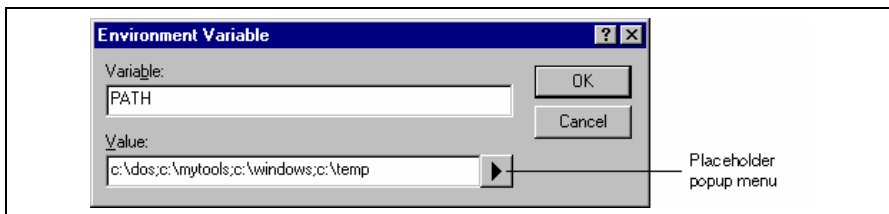

Figure 5.7: Environment Variable Dialog

5.6 Uninstalling Components

The HEW provides a built in uninstaller method, which can remove unregistered components.

☞ To uninstall a component:

1. Select [**Tools->Administration...**].
2. Click on the uninstaller button. The “Uninstall HEW Tool” dialog is invoked (figure 5.8).

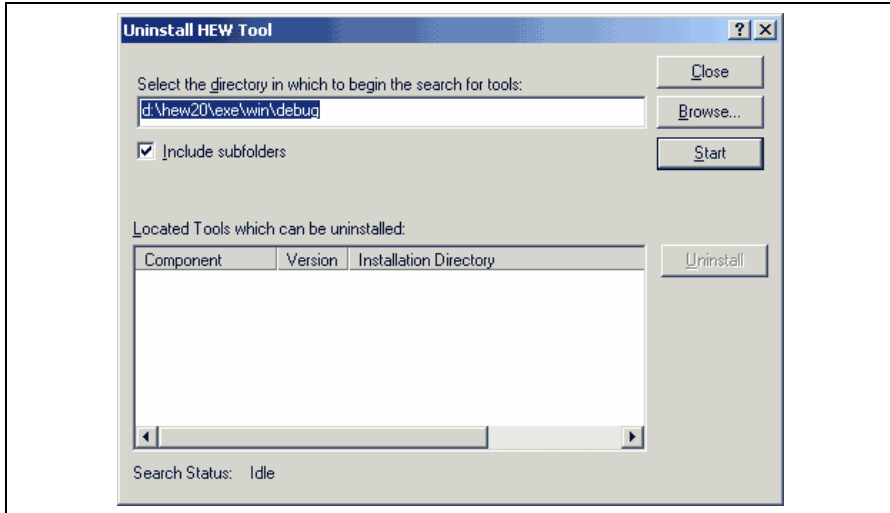

Figure 5.8: Uninstall HEW Tool

3. Enter the directory in which you would like to search into the top field or browse to it graphically by clicking the “Browse...” button.
4. Check the “Include subfolders” check box if you would like to search the directory specified and all directories below it.
5. Click the “Start” button to begin the search. During the search, the “Start” button will change to a “Stop” button. Click the “Stop” button to halt the search at any time.
6. The results of the search are shown in the “Located Tools which can be uninstalled” list. Select a component and click “Uninstall” to uninstall a component.
7. Click “Exit” to exit the dialog.

A component may only be uninstalled if it is not currently registered with the HEW. If you attempt to uninstall a tool, which is registered, then the dialog shown in figure 5.9 will be displayed. In such a case, you must return to the “Tools Administration” dialog via [**Tools->Administration...**], unregister the tool and then invoke the tool uninstaller again.

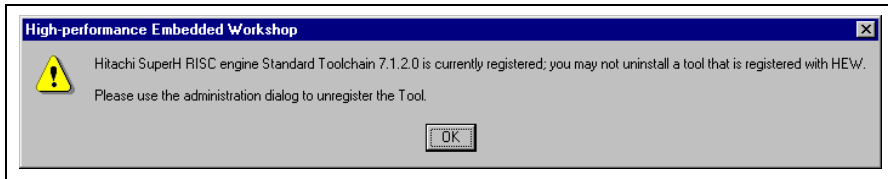

Figure 5.9: Unable to Uninstall Tool

If a tool is not registered with the HEW then the dialog shown in figure 5.10 will be displayed when the “Unregister” button is clicked. This confirmation dialog displays all of the files and folders that will be deleted. If you are certain that these files and folders can be deleted then click the “Yes” button. To abort the uninstall click the “No” or “Cancel” buttons.

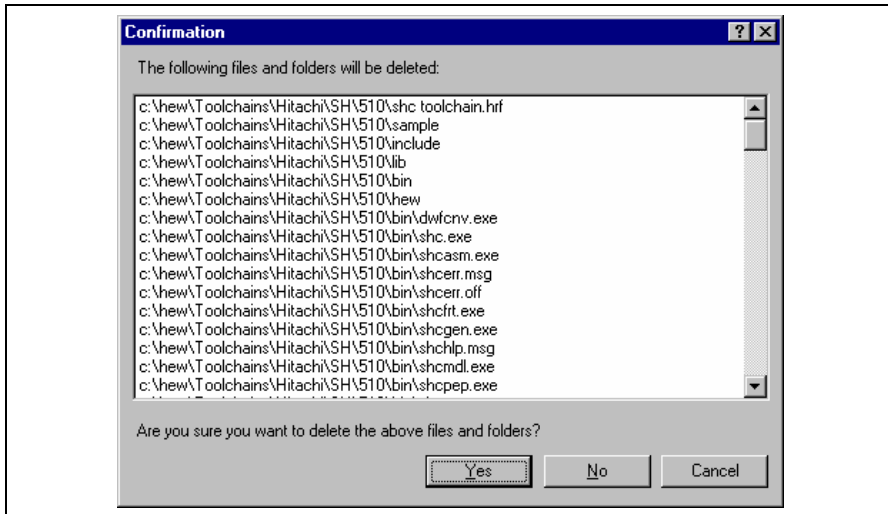

Figure 5.10: Confirmation Dialog

5.7 Technical Support Issues

The “Tools Administration” dialog is also capable of displaying information regarding “hidden” system components. These are part of the HEW itself that cannot be unregistered/registered manually. If you check the “Show all components” check box on the tools administration dialog, extra component folders are displayed (see figure 5.11).

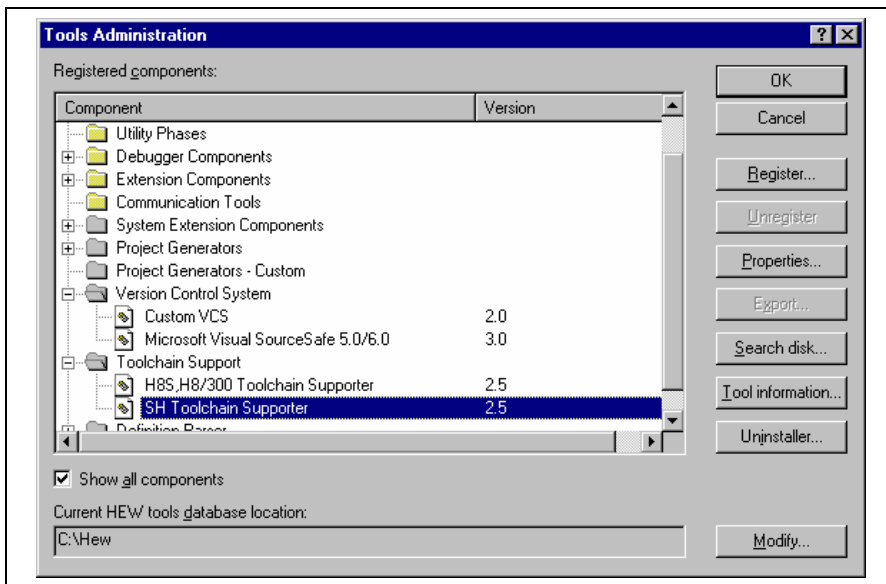

Figure 5.11: All Components Shown

When seeking technical support, you may be asked to give details about some or all of these components. To do so, open the respective folder, select a component and click the “Properties” button. The properties dialog that will be invoked behaves in the same way as discussed previously in this chapter, with the exception that there is no “Environment” tab.

The HEW also has a feature, which outputs tool information regarding the registered components to a file. This allows you to retrieve information on the entire HEW system. This information can then be sent to your technical support contact if you are experiencing problems with the HEW.

☞ To output tool information:

1. Click the [**Tools->Administration**] menu item.
2. Click the “Tool information...” button. A standard windows file save dialog is displayed.
3. Choose the file location and click OK.
4. A file is created in the chosen location with the current registered tool setup of the HEW.

If any of the components have problems these can be seen in the tools administration dialog. If the icon has an additional icon this explains the problem. There are two additional icons that can be displayed. If a component is found but cannot be used due to it being an old version or another dependent component is not available then the icon in figure 5.12 is used to show this. If the component is not located where the registration file says it is then the icon in figure 5.13 is used to show this.

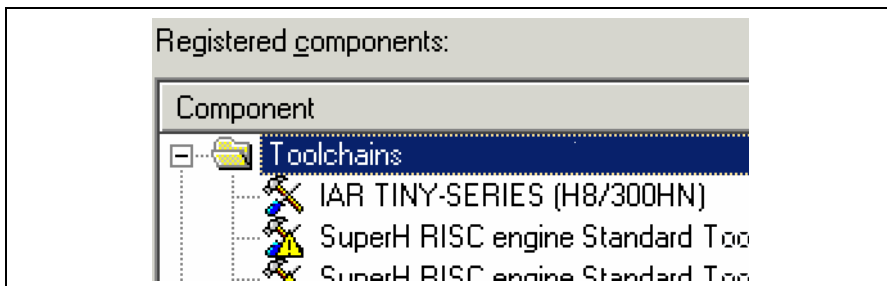

Figure 5.12: Incompatible component found icon

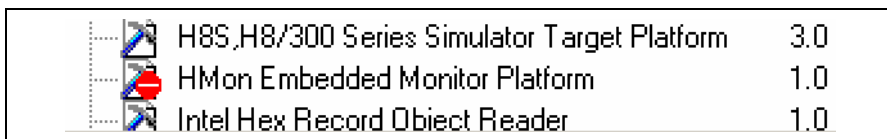

Figure 5.13: Component not found icon

Note:

If the tool has one of these errors then it is possible to get more information by the following method:

- ☞ To get tool error feedback:
 1. Click the [**Tools->Administration**] menu item.
 2. Select the tool in the list that has an issue.
 3. Click “Properties...”
 4. Select the information tab and scroll the edit field to the bottom.
 5. The reason for the problem will be displayed in this area.

5.8 On-Demand components

The HEW version 3.0 onwards has the concept of on-demand components. These components are not automatically loaded by the application or the debugger component. These components can be loaded by the user or as part of the project generation process.

- ☛ To load or unload an on-demand component manually:
 1. Click the [**Project->Components...**] menu item.
 2. The component gallery dialog is displayed. This is displayed in figure 5.14.
 3. Select the component you wish to load. Click the load button. The components image should change to the loaded state.
 4. If you wish to unload a component. Select the component. Click the unload button. The components image should change to the unloaded state.
 5. Click OK to verify the changes.

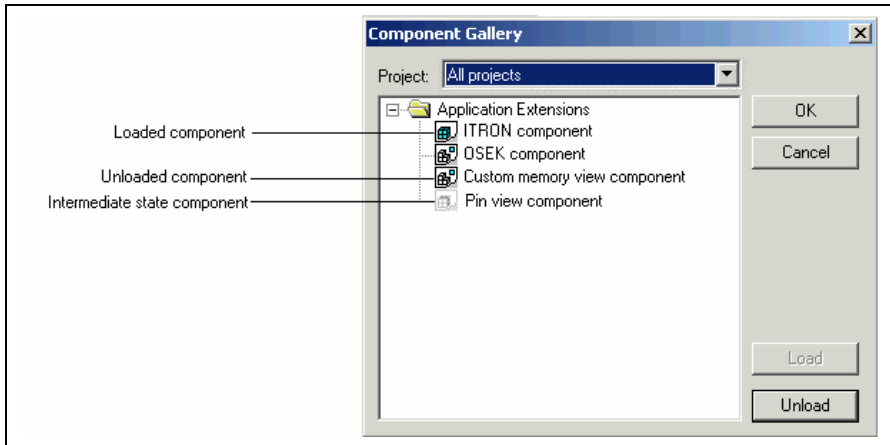

Figure 5.14: Component Gallery

Note:

Each project in your workspace can have different components loaded and unloaded. If you have multiple projects you can use the “Multiple projects...” and “All projects” items to change a components load status over more than one project. If you select a combination which means the component is loaded in one project and not another then the intermediate state icon is displayed.

5.9 Custom Project Types

The [Project->Create Project Type...] menu item in HEW allows you to create a template for your project. This menu item takes the settings of the current project and then creates a project type for you. The user can specify the name of the new type and style of the project generation wizard. Once created these project types appear in the “Tools Administration” dialog and are initially hidden in the system components part of the tools administration tree. To export one of the custom project generators select the “Export” button on the “Tools Administration” dialog. The execution environments of the custom project generators are packaged on the execution file that can be installed. When this file is executed on the target user’s machine, the custom project generator is installed.

Once created custom project type will then appear in the New workspace dialog and can be used to create identical copies of your project.

- To create custom project generator:
 1. Open the workspace that contains the project you wish to convert into a custom project generator.
 2. Set the project you wish to convert as the current project.
 3. Click the [Project->Create project type...] menu item.
 4. The following dialog is displayed:

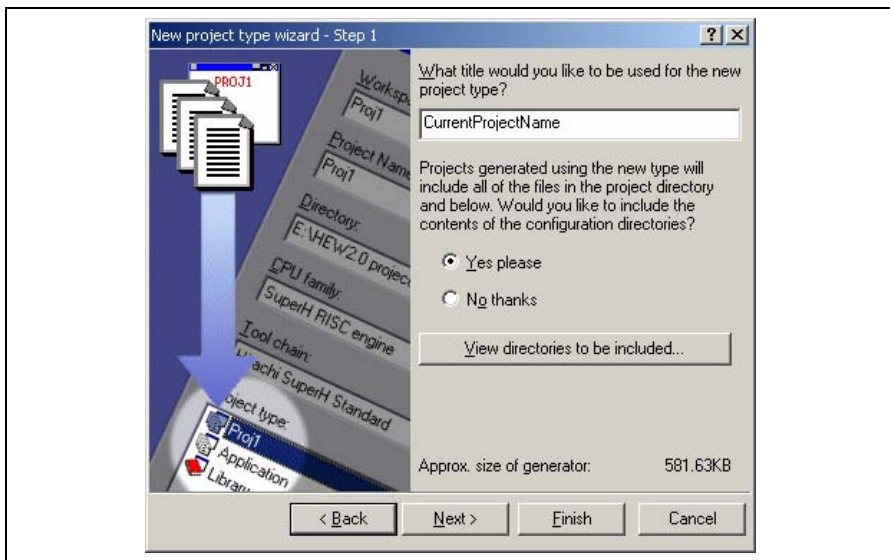

Figure 5.15: New project type wizard – Step 1 Dialog

5. The edit field is set to the current projects name. This will become the name of the new project generator project type that will appear in the new workspace dialog. Change the contents of the fields as appropriate.
6. At this stage you can choose to include the configuration directories or not. In this case it is normal to not include the contents of these directories because normally these are only intermediate files.
7. Then click next. The following dialog is displayed.

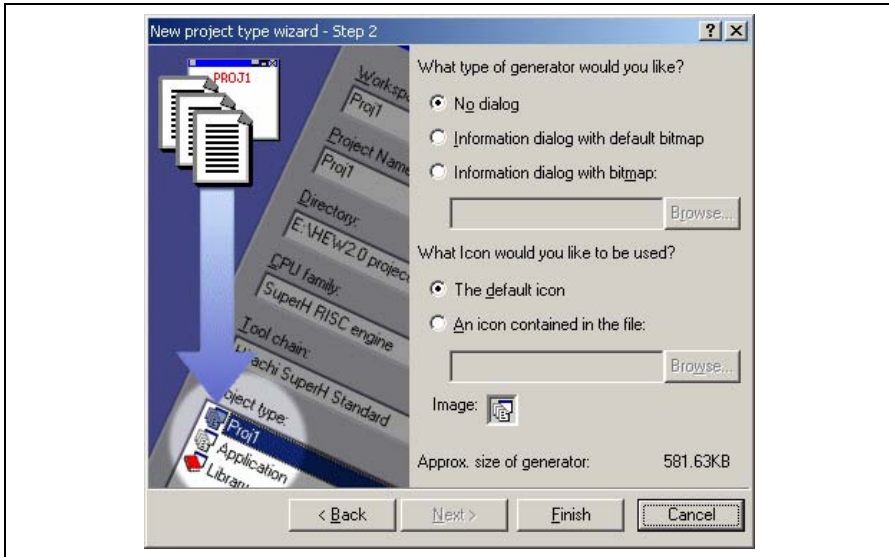

Figure 5.16: New project type wizard – Step 2 Dialog

8. At this stage you can change the wizard graphic and the project icon. By default no dialog is displayed for this wizard. When you wish to display “Project information” dialog box, you should either information dialog with default bitmap or information dialog with bitmap. This selection affects to show icon in the “Project information” dialog.
9. You can also decide to change the icon for the project type at this stage. The default icon is shown but you can choose to use your own custom icon and this will be displayed on the new workspace dialog.
10. When you are happy with the setup of the generator click finish. If you click “Next” button, Step 3 dialog box is shown.

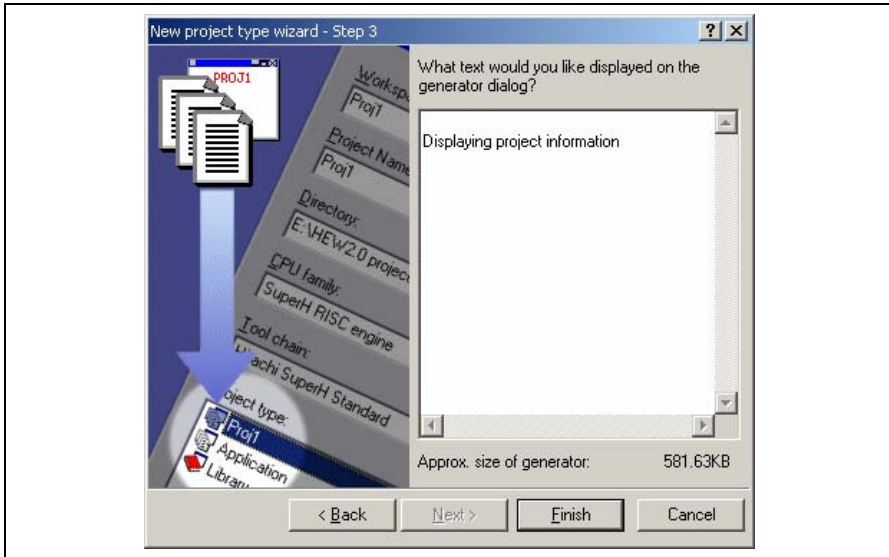

Figure 5.17: New project type wizard – Step 3 Dialog

11. You can enter project information. It will be shown "Project information" in Project information dialog box.
12. You can click "Finish" button. Now the generator will be created in the HEW\system\pgc directory in your HEW installation. It will also automatically appear in the new workspace dialog.

You can see a new project type (In this example, “Current Project Name”) after creating by custom project generator.

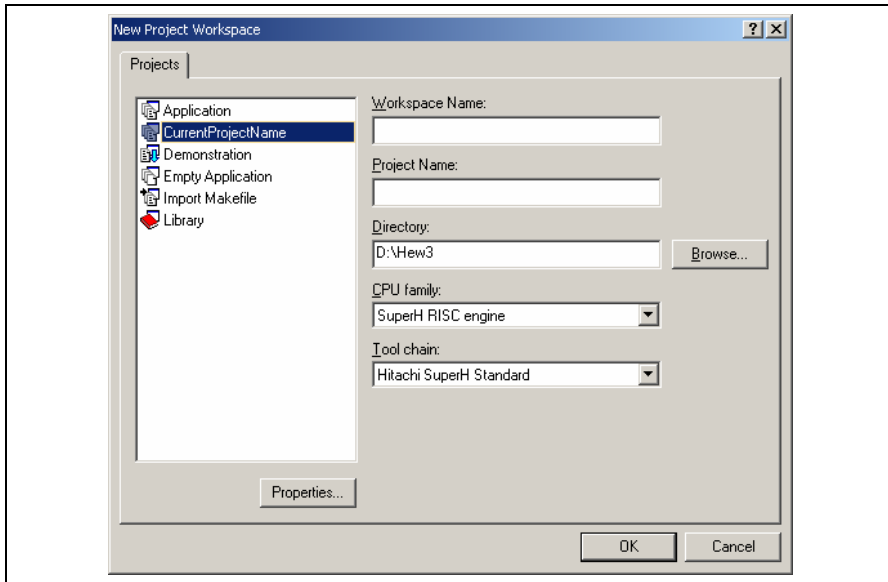

Figure 5.18: New Project Workspace Dialog

You can select a project type and enter workspace and project name then click, OK. This dialog contents come from “Project type wizard - Step 2” and step 3 setting.

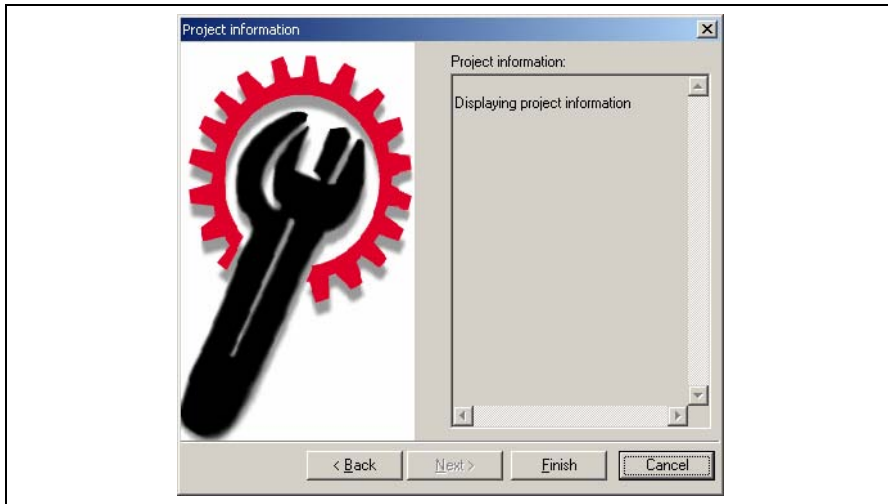

Figure 5.19: Project information Dialog

These can then be exported from the HEW system and be given to other users you need to use your project.

- To export a custom project generator to another user:
 1. Click on [Tools->Administration].
 2. Check the “Show all components” checkbox.
 3. Expand the “Project Generators – Custom” folder.
 4. Select the custom project generator you wish to export.
 5. Click the “Export...” button.

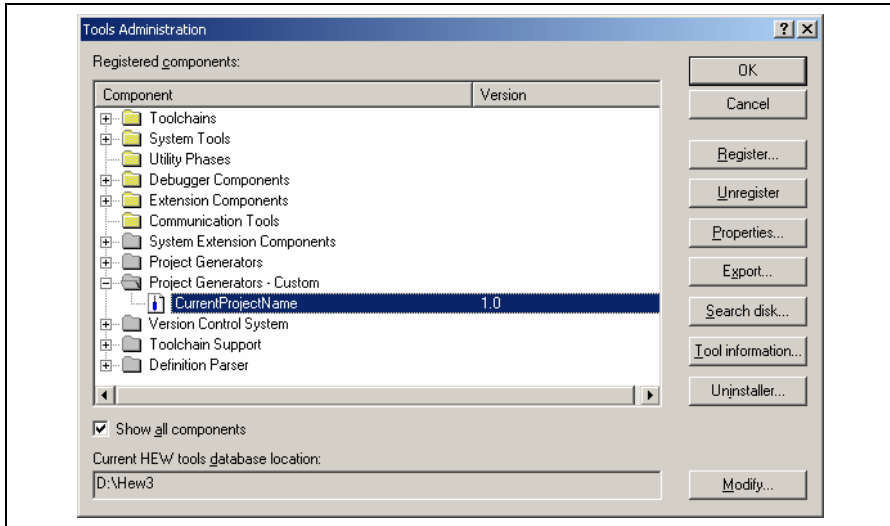

Figure 5.20: Tool Administration Dialog

6. You should enter export directory for custom project generator and click “Export” button. HEW creates some files. When another HEW uses its project, it needs all files under your specified directory.

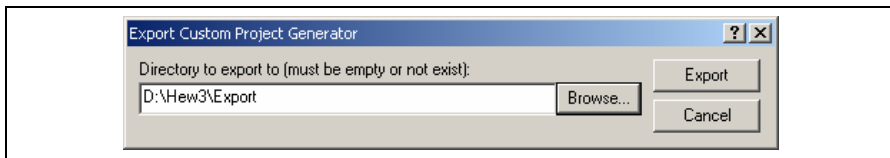

Figure 5.21: Export Custom Project Generator Dialog

This will export the required files along with a “Setup.exe” file which can then be executed on another HEW. This will ask the location of the new users HEW and when Install is clicked the project generator will be added to their HEW system.

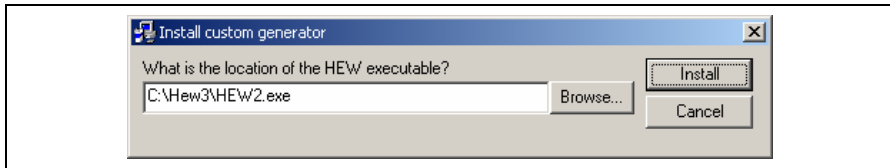

Figure 5.22: Install custom generator Dialog

Once completed the project type will appear in the new workspace dialog.

Note:

A custom project generator can only be used in a HEW which is the same or greater version. If you attempt to use the project generator in an old HEW an error message will be reported.

If your project generator contains a different toolchain to the destination HEW then this will be upgraded when the project is first created.

6. Customizing the Environment

6.1 Customizing the Toolbar

The High-performance Embedded Workshop provides 2 standard toolbars as detailed in chapter 1, “Overview”. In addition to these, you may also construct your own toolbars via the “Customize” dialog (figure 6.1).

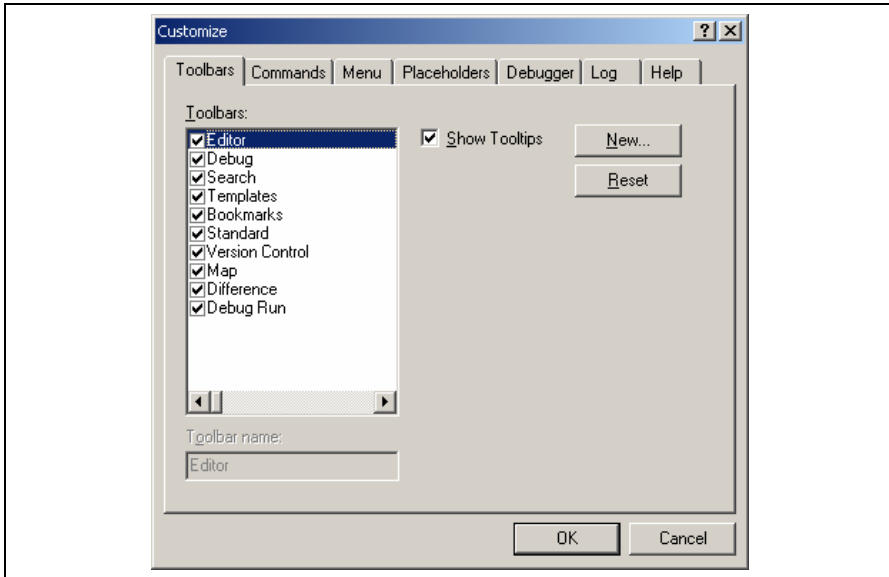

Figure 6.1: Customize Dialog Toolbars Tab

➤ To create a new toolbar:

1. Select [**T**ools->**C**ustomize...]. The dialog shown in figure 6.1 will be displayed.
2. Click the “New...” button. The dialog shown in figure 6.2 will be displayed.
3. Enter the name of the new toolbar into the “Toolbar name” field.
4. Click “OK” to create the new toolbar.

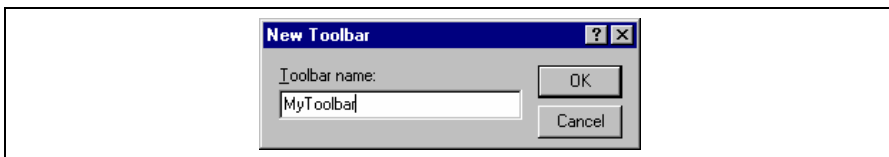

Figure 6.2: New Toolbar Dialog

When a new toolbar is created it will appear undocked (i.e. “floating”) and empty.

➤ To add buttons to a toolbar:

1. Select [**Tools->Customize...**]. The dialog shown in figure 6.1 will be displayed. Select the “Commands” tab (see figure 6.3).
2. Browse the available buttons by selecting the button categories from the “Categories” list. Select a button from the “Buttons” area to display information on its operation.
3. Click and drag a button from the dialog onto the toolbar.

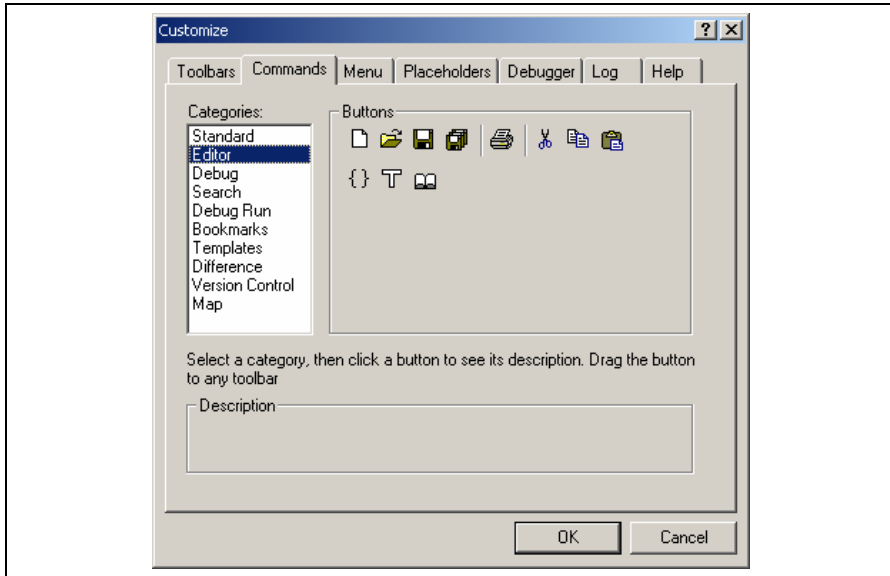

Figure 6.3: Customize Dialog Commands Tab

- To remove buttons from a toolbar:
 1. Select [**Tools->Customize...**]. The dialog shown in figure 6.1 will be displayed. Select the “Commands” tab (see figure 6.3).
 2. Click and drag a button from the toolbar onto the “Buttons” area.
- To remove a user defined toolbar:
 1. Select [**Tools->Customize...**]. The dialog shown in figure 6.1 will be displayed.
 2. Select the user-defined toolbar from the “Toolbars” list, and the “Reset” button in figure 6.1 changes to the “Delete” button. Then click the “Delete” button.
- To reset a standard toolbar back to its original state:
 1. Select [**Tools->Customize...**]. The dialog shown in figure 6.1 will be displayed.
 2. Select the standard toolbar from the “Toolbars” list and then click the “Reset” button.
- To show or hide toolbar tooltips:
 1. Select [**Tools->Customize...**]. The dialog shown in figure 6.1 will be displayed.
 2. Set the “Show Tooltips” check box as desired.
- To modify the toolbar name of a toolbar created by a user:
 1. Select [**Tools->Customize...**]. The dialog shown in figure 6.1 will be displayed.
 2. In the “Toolbars” list, select a toolbar, which has been created by a user and whose name you want to modify.
 3. Modify the name of the toolbar in the “Toolbar name” field.

6.2 Customizing the Tools Menu

The “Tools” menu can be customized to include your own menu options.

➤ To add a new menu option:

1. Select [**Tools->Customize...**]. The dialog shown in figure 6.1 will be displayed. Select the “Menu” tab (see figure 6.4). The first thing for you to decide is whether you are adding a global application wide tool (“Application wide tools:”), which will be available to all of your workspaces. Or whether you wish to add a workspace wide tool (“Workspace wide tool:”), which is only valid for the current workspace. Once you have made the choice choose the relevant section of the dialog.

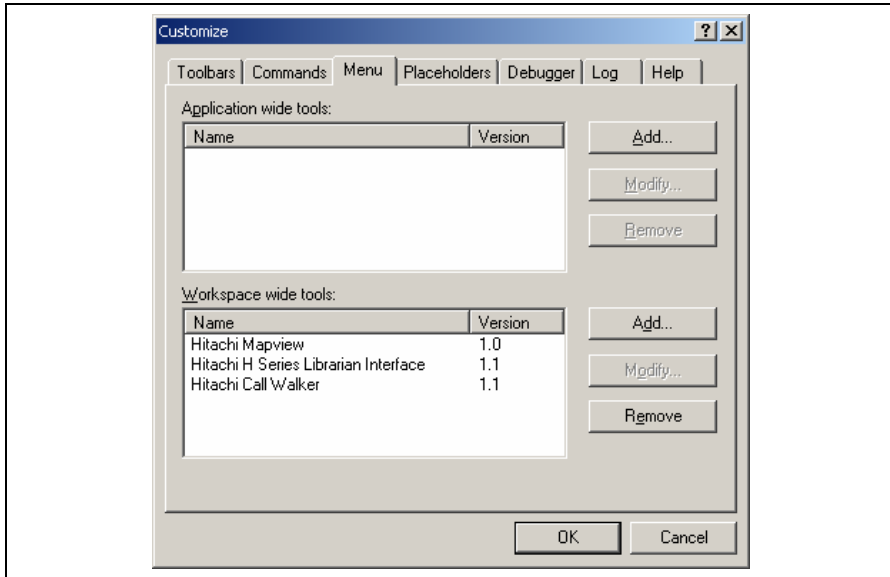

Figure 6.4: Customize Dialog Menu Tab

2. Click the “Add...” button (the dialog shown in figure 6.5 will be invoked). If you would like to add an existing system tool to the menu then select the “Select from existing system tools” radio button, choose the tool from the drop-down list and then click “OK”.
3. Enter the name of the tool into the “Name” field.
4. Enter the command, excluding arguments, into the “Command” field.
5. Enter any arguments that you would like to pass to the command into the “Arguments” field.
6. Enter an initial directory in which you would like the tool to run, into the “Initial directory” field.
7. Click “OK” to add the menu option to the “Tools” menu.

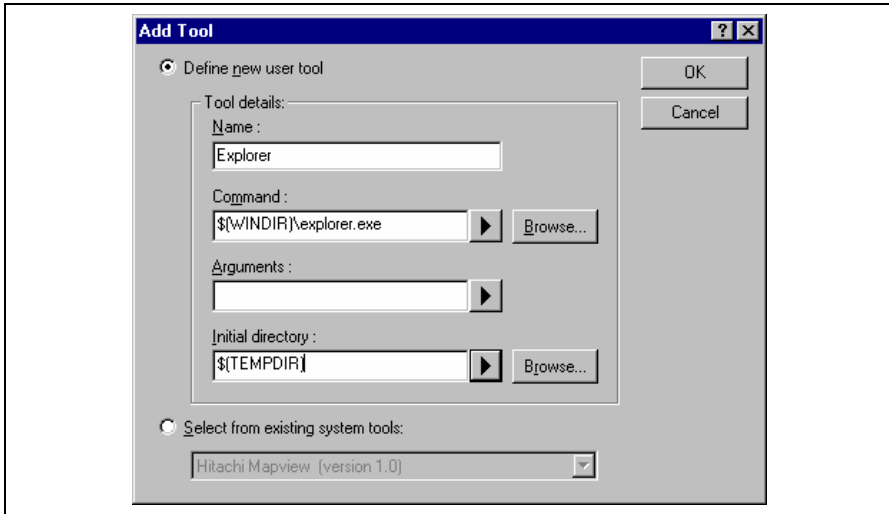

Figure 6.5: Add Tool Dialog

New menu options are added to the bottom of the list (i.e. bottom of the tools menu). The order of menu options in the “Tools” menu can also be modified.

➤ To modify a menu option:

1. Select [**Tools->Customize...**]. The dialog shown in figure 6.1 will be displayed. Select the “Menu” tab (see figure 6.4).
2. Select the menu option that you would like to modify and then click the “Modify...” button.
3. Make the desired changes on the “Modify Tool” dialog (figure 6.6) and then click “OK”.

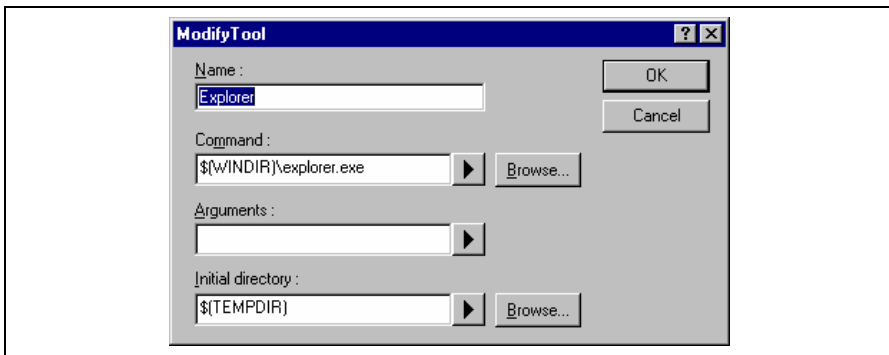

Figure 6.6: Modify Tool Dialog

➤ To remove a menu option:

1. Select [**Tools->Customize...**]. The dialog shown in figure 6.1 will be displayed. Select the “Menu” tab (see figure 6.4).
2. Select the menu option that you would like to remove and then click the “Remove” button.

6.3 Configuring the Help System

The High-performance Embedded Workshop provides context sensitive help within the editor window. In other words, if you select some text in the editor window and then press **F1**, the High-performance Embedded Workshop will attempt to locate help on that selected item. The help files, which will be searched, are listed in the “Help” tab of the “Customize” dialog.

➤ To add a new help file:

1. Select [**Tools->Customize...**]. The dialog shown in figure 6.1 will be displayed. Select the “Help” tab (see figure 6.7).

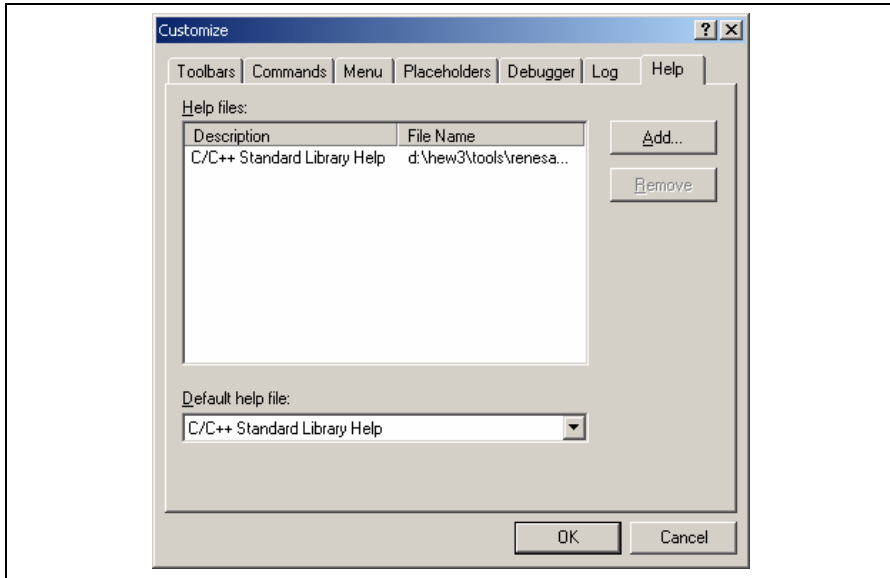

Figure 6.7: Customize Dialog Help Tab

2. Click the “Add...” button. The “Add Help File” dialog will be displayed (figure 6.8).
3. Enter a description of the help file into the “Title” field.
4. Enter the full path of the help file into the “Path” field (or browse to it graphically by clicking on the “Browse...” button).
5. Click “OK” to define the new help file.

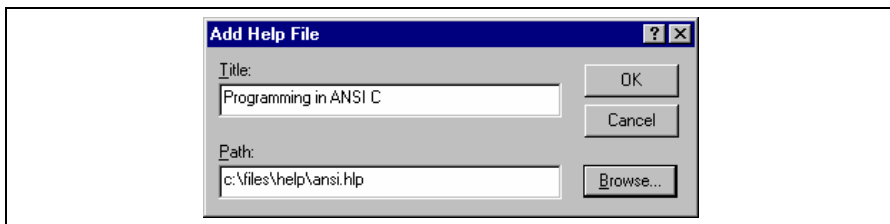

Figure 6.8: Add Help File Dialog

To make a help file the default choice, select it from the “Default help file” drop-down list or set it to “(None)” if you would like to be prompted for a help file when **F1** is pressed.

6.4 Specifying Workspace Options

The High-performance Embedded Workshop allows you to control several aspects of a workspace via the “Options” dialog (figure 6.9). To invoke it select [**T**ools->**O**ptions...], and select the “Workspace” tab.

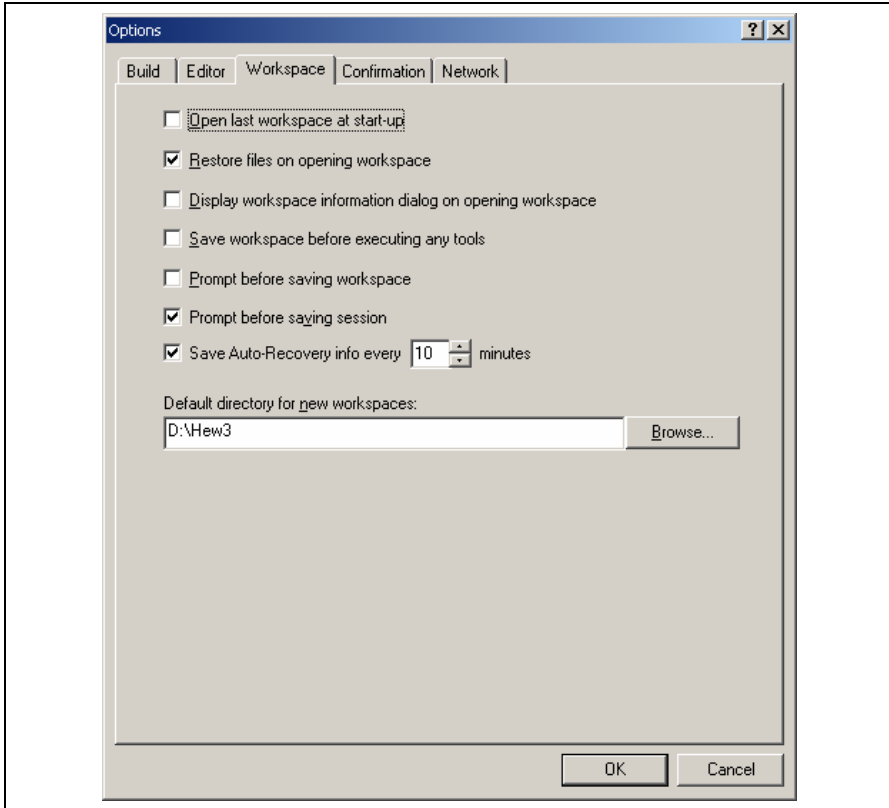

Figure 6.9: Options Dialog Workspace Tab

The following sections explain the options available on this tab.

6.4.1 Open last workspace at start-up

Set this check box if you would like the High-performance Embedded Workshop to automatically open the last workspace you opened when it is launched.

6.4.2 Restore the files on opening workspace

When you close a workspace, the HEW stores, which files were open. When you open a workspace, the HEW can restore (i.e. open) the same files so that you can continue your session in exactly the same state as when you left it. If you would like the files associated with a workspace to be opened when you open a workspace then set this check box.

6.4.3 Display workspace information dialog on opening workspace

When many workspaces are being used, it is sometimes difficult to remember exactly what was contained within each workspace. To help resolve this, the High-performance Embedded Workshop allows you to enter a textual description of each workspace.

- To enter a workspace description:
 1. Select the workspace icon from the “Projects” tab of the “Workspace” window.
 2. Click the right mouse button to invoke the pop-up menu and then select the “Properties” option. The dialog shown in figure 6.10 will be displayed.
 3. Enter the description into the “Information” field.
 4. Check the “Show workspace information on workspace open” check box if you want a workspace properties dialog to be launched on opening a workspace. This check box has the same role as the “Display workspace information dialog on opening workspace” on the “Workspace” tab of the “Options” dialog.
 5. Click “OK” to save the description on the “Information” dialog. Click the “Cancel” button not to save the description.

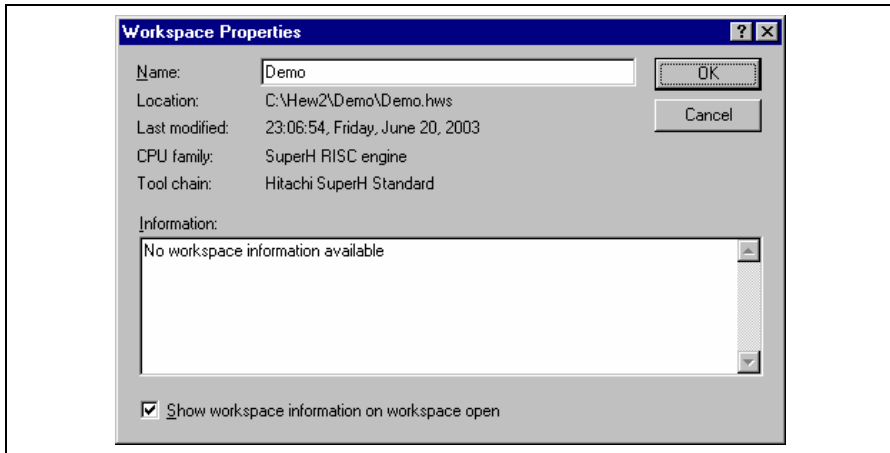

Figure 6.10: Workspace Properties Dialog

When a workspace is opened, the High-performance Embedded Workshop can display this information so that it is possible to determine whether the workspace is the desired workspace. To display this information on opening a workspace, set the “Display workspace information dialog on opening workspace” check box.

6.4.4 Save workspace before executing any tools

To force the High-performance Embedded Workshop into saving the current workspace before executing any build phases (i.e. build, build all or build file operations) or version control commands set the “Save workspace before executing any phases” check box.

6.4.5 Prompt before saving workspace

In addition to the above check box, set this to prompt before saving.

6.4.6 Prompt before saving session

Checking this option will force the High-performance Embedded Workshop into displaying a prompt before the session is saved to disk.

6.4.7 Save auto-recovery info

When you click this option, every ten minutes (as default) HEW saves workspace, project and session temporality. Any changes you have made will be saved to temporary files.

If you open your workspace and the following dialog is displayed it means that the last time the workspace was used problems were encountered. To recover the files check the checkbox alongside the filenames you wish to recover and click OK. Clicking cancel will discard the auto-recovery files and load from the original files.

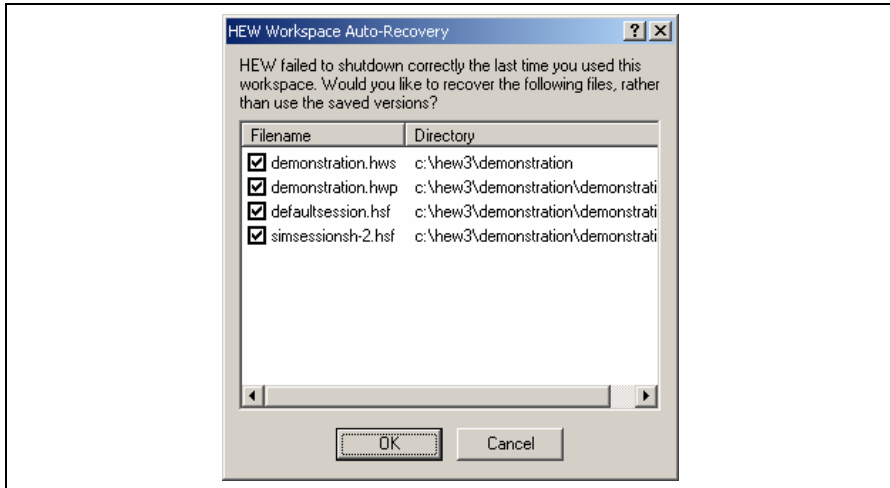

Figure 6.11: HEW Workspace Auto-Recovery Dialog

6.4.8 Default directory for new workspaces

When a new workspace is created the High-performance Embedded Workshop invokes the “New Workspace” dialog. One of the fields on this dialog is the directory in which the new workspace will be created. By default, this is the HEW installation directory. However, if you would like to set this default directory to another location (e.g. “C:\Workspaces”) then enter the desired directory into the field or browse to it graphically via the “Browse...” button.

6.5 Using an External Editor

The High-performance Embedded Workshop allows you to use an external editor. Once an external editor has been specified, it will be launched when the following actions are performed:

- Double clicking on a file in the “Projects” tab of the “Workspace” window.
- Double clicking on an entry in the “Navigation” tab of the “Workspace” window.
- Double clicking on an error/warning in the “Build” tab of the “Output” window.
- Double clicking on an entry in the “Find in Files” tab of the “Output” window.
- Selecting the **[Open <file>]** option from the “Workspace” windows pop-up menu.
- Clicking the “Launch Editor” toolbar button.

☞ To specify an external editor:

1. Select **[Tools->Options...]**. The “Options” dialog will be displayed. Select the “Editor” tab (figure 6.12).

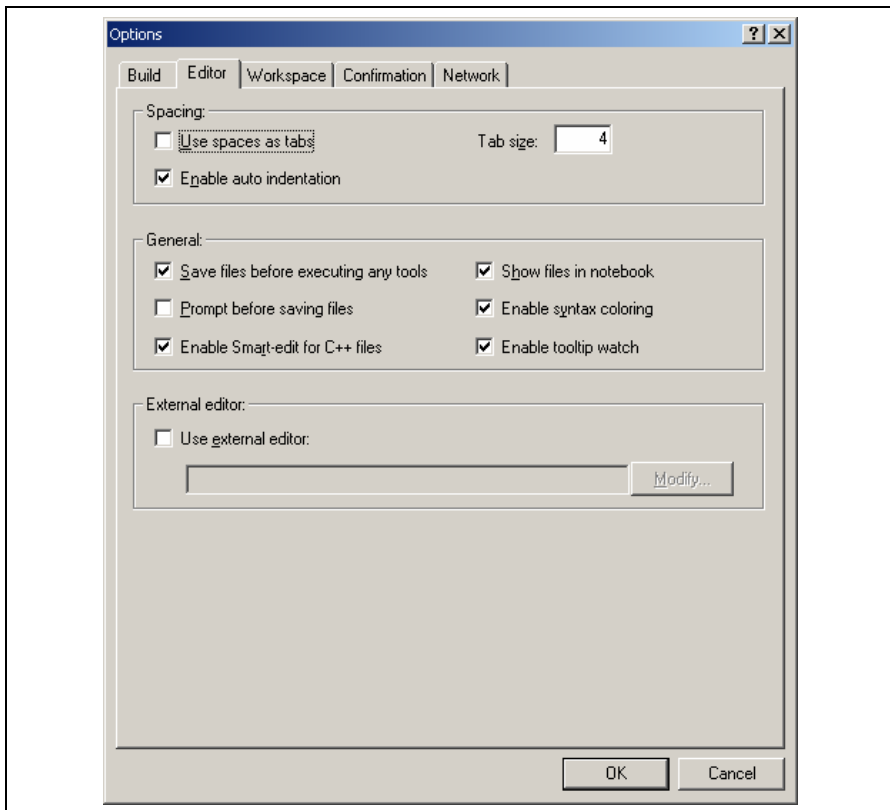

Figure 6.12: Options Dialog Editor Tab

2. Check the “Use external editor” check box.

The “External Editor” dialog will be displayed (figure 6.13).

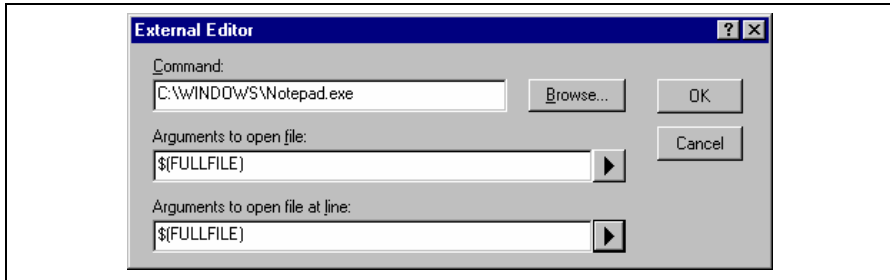

Figure 6.13: External Editor Dialog

3. Enter the path of the executable (without any arguments) into the “Command” field.
4. Enter the arguments required to open a file into the “Arguments to open file” field. Use the \$(FULLFILE) placeholder to represent the path of the file to be opened.
5. Enter the arguments required to open a file at a specific line into the “Arguments to open file at line” field. Use the \$(FULLFILE) placeholder to represent the path of the file to be opened and the \$(LINE) placeholder to represent the line number at which the cursor should be initially positioned.
6. Click “OK” to define the editor.

Note: When using an external editor be aware of the following issues:

- Each time you invoke the external editor, in whichever way, a separate instance of the editor will be launched.
- You must save your own files before you perform a build file, build or build all operation.
- If debugging the external editor will not be used.

6.6 Customizing File Save

The High-performance Embedded Workshop allows you to customize file save on the “Editor” tab of the “Options” dialog (figure 6.12). To open the tab, select [Tools->Options...] and click the “Editor” tab.

The following sections explain the options related to file save.

6.6.1 Save files before executing any tools

To force the High-performance Embedded Workshop into saving edited files before executing any build phases (i.e. build, build all or build file operations) or version control commands, set the “Save files before executing any tools” check box.

6.6.2 Prompt before saving files

In addition to the above check box, set this to prompt before saving.

6.7 Using Custom Placeholders

Throughout the High-performance Embedded Workshop the user can use a number of pre-defined placeholders for directory definitions. For example the user can use the “\$(PROJDIR)” variable to signify the current HEW project directory. This makes it much easier to relocate projects and keep all of the paths correct.

The High-performance Embedded Workshop also has the ability to define custom placeholders. This means you can enter your own custom placeholder definition and decide upon its directory value. Once defined this placeholder becomes available throughout the rest of the HEW system.

The placeholders can be defined on an application wide level so the placeholders are available to all workspaces and projects that use the HEW. The other method of defining the placeholders is using the workspace wide custom placeholders this means the placeholders can only be used in the current workspace. This list is only available when you have a workspace open.

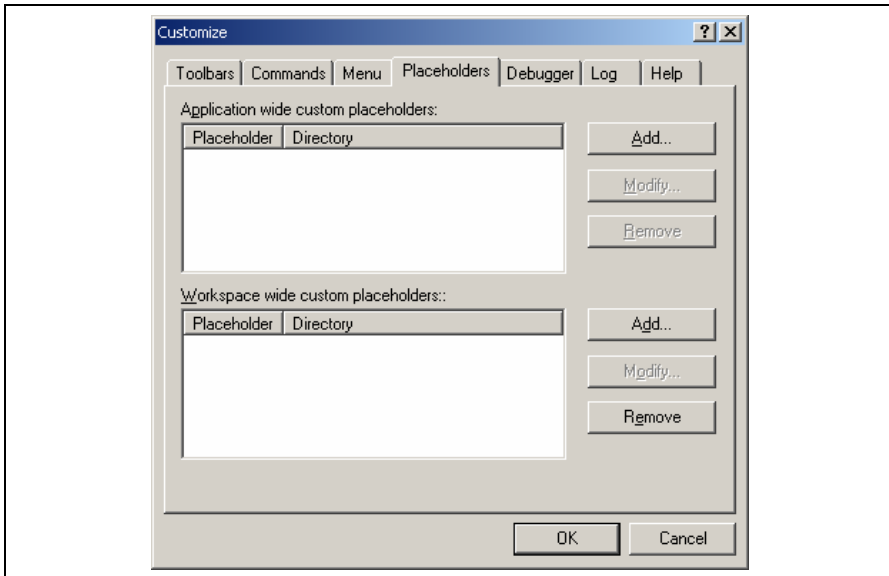

Figure 6.14: Customize Dialog Placeholder Tab

- ☞ To add a custom placeholder:
1. Select [**Tools->Customize...**]. The dialog shown in figure 6.1 will be displayed. Select the “Placeholders” tab (figure 6.14).
 2. Choose whether you need to use an “Application wide custom placeholder” or “Workspace wide custom placeholder”. Click “Add” on the adjacent button to the list you require.
 3. The dialog, add “New Custom Placeholder” dialog is displayed. (figure 6.15)
 4. In the fields provided choose a suitable name for the placeholder and a description of what the placeholder means.
 5. Then choose a directory, which relates to this placeholder. It is possible to use placeholders that are already defined in this field such as \$(PROJDIR).

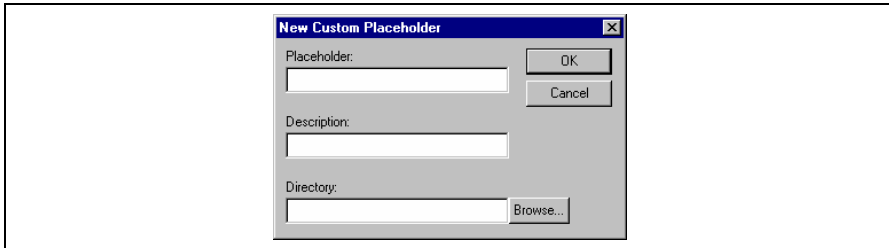

Figure 6.15: New Custom Placeholder Dialog

6.8 Using the workspace and project log facilities

The HEW 3.0 has workspace and project logging facilities integrated into the application. These facilities can be switched on via the log tab on the Tools customize dialog. This option is especially useful when the network database is in operation. This is because user names and changes are logged to this file. This dialog is shown in figure 6.16.

When the workspace log is clicked any workspace changes will be logged to a file with the same name as the workspace with a “.log” extension. This file will be located in the same directory as the workspace file.

When the generate log for projects log is clicked any projects in the current workspace that have changes made to them will be logged to a file with the same name as the project with a “.log” extension. This file will be located in the same directory as the project file.

The log file is updated when the workspace is saved.

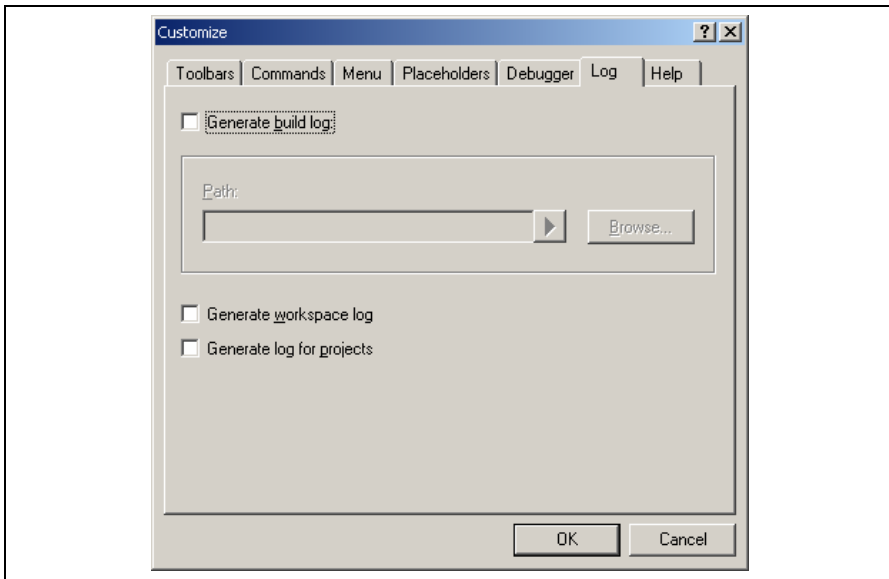

Figure 6.16: Tools customize log tab

6.9 Using the virtual desktop

HEW has implemented the concept of the virtual desktop. This allows window configurations to be defined that can be switched with the click of a button. When a particular button is clicked the windows are hidden or displayed depending on the current settings of that window configuration.

It is possible to have a maximum of 4 desktop configurations in use. When the session is saved the window positions for each configuration are saved to the session file. You can then switch simply between each configuration to gain access to the other windows. The toolbars and windows are dependent on the virtual desktop configuration. Source files are independent of the virtual desktop system and will remain in view.

- ☞ To rename your configuration to a more meaningful name:
 1. Click the [Window->Virtual Desktop] menu item. Select is cascaded menu.
 2. Select the Desktop Manager dialog.
 3. Select the window configuration you wish to change the name for.
 4. Click the rename button. Enter the new meaningful name in the edit field and click OK.
 5. Click OK to keep the changes and revert to the HEW main window.

- ☞ To switch desktop configurations:

There are a number of ways to switch desktop configuration. The first and easiest method is using the virtual desktop buttons located on the status bar. These are shown in figure 6.17.

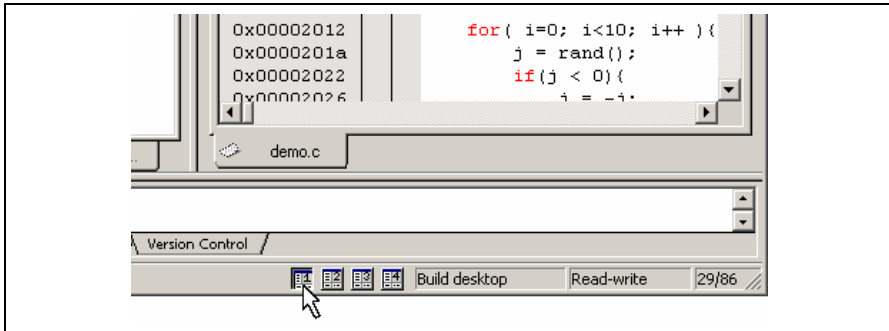

Figure 6.17: Desktop button

In this example the selected desktop is number 1. This has been given the name "Build" by the user. Its description is seen in the edit box to the right on the buttons. Clicking a different desktop selects that button and changes the description control. Once clicked HEW then loads the windows in the new configurations style.

Another method of changing the desktop configuration is as follows:

1. Click the [Window->Virtual Desktop] menu item. Select is cascaded menu.
2. Then select the desktop configuration you wish to view on this menu. The selected item is ticked.
3. Select the menu item and the setup is altered automatically.

Note:

If the configuration has never been used then HEW will copy the current window configuration to the new configuration. You can then modify this setup. When you save the session it will store the positions of your windows for each window configuration.

7. Version Control

The High-performance Embedded Workshop provides facilities for connecting to a version control tool. Some of the reasons why version control tools are used with a project are:

- To maintain the integrity of a project.
- To store each stage of a project.
- To enable different users to co-develop a project by controlling revisions to its source files.

Figure 7.1 illustrates a typical project where a version control system is in use. This shows three users who all use the same-shared network drive to exchange source code. The version control system provides access and updates to the source files.

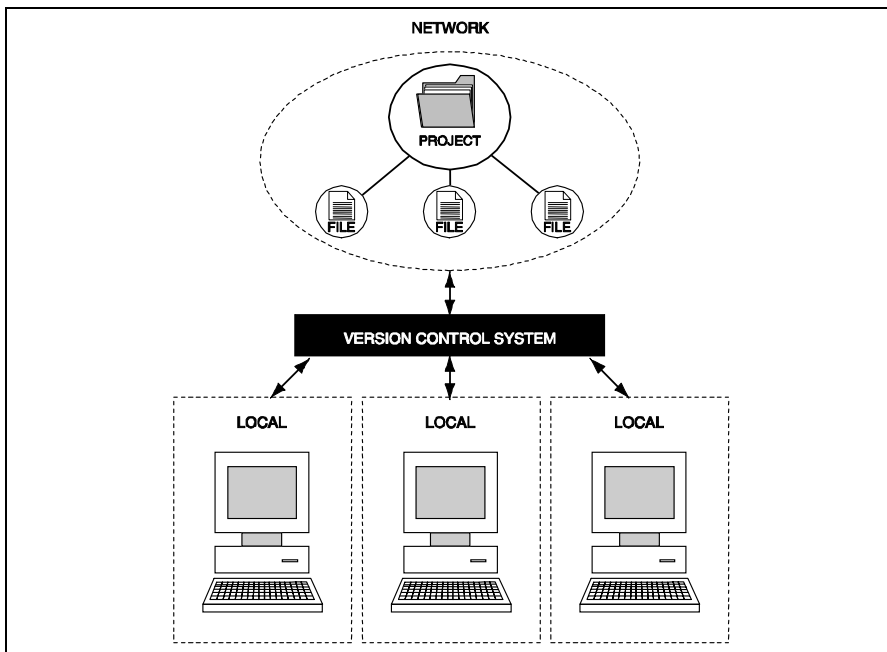

Figure 7.1: Version Control

7.1 Selecting a Version Control System

Initially, the version control sub-menu will appear as shown in figure 7.2. At this time only the [Version Control -> Select...] option is available because a version control system is not yet active for the current workspace.

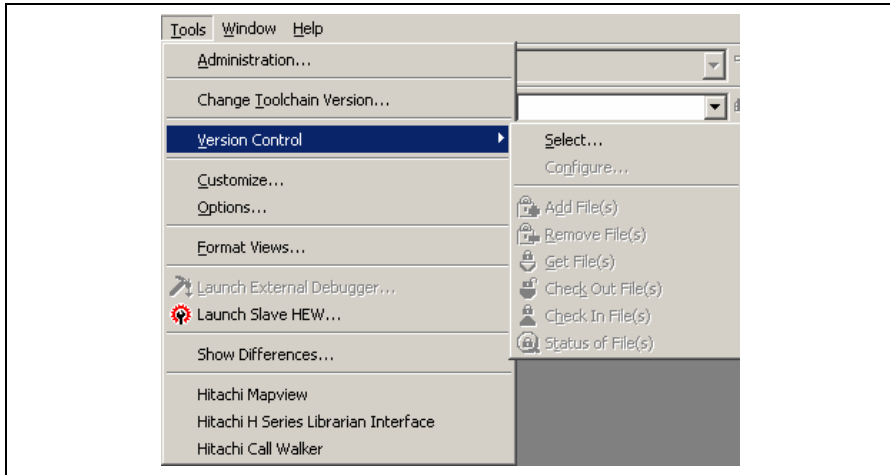

Figure 7.2: Version Control Sub-Menu

- To select a version control system:
 1. Select [Version Control->Select...]. The dialog shown in figure 7.3 will be displayed. This dialog lists all of the supported version control systems.
 2. Select the desired version control system from the “Version control systems” list and click the “Select” button. The “Current version control system” is changed to reflect the new selection.
 3. Click the “OK” button to confirm the selection.

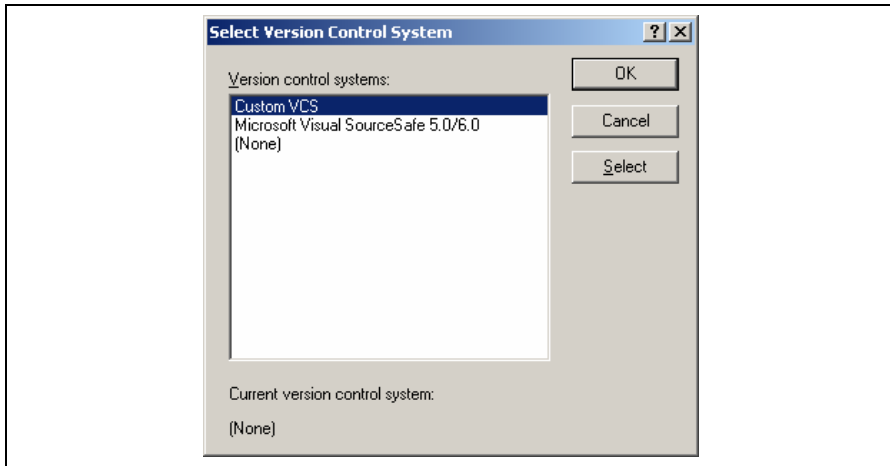

Figure 7.3: Select Version Control System Dialog

Note: Only those version control systems, which have been installed with the HEW, will appear in the “Select Version Control System” dialog (figure 7.3).

Once a version control tool is selected you will notice that the [**Version Control->Configure...**] option has now become available.

The next chapter discusses the usage of the custom version control system.

8. Using the Custom Version Control System

The custom version control system is a configurable addition to the High-performance Embedded Workshop, which allows you to connect to a version control system already installed on your machine. To clarify further, the High-performance Embedded Workshop does not provide a version control tool itself, only a means by which you can integrate the version control system, which you use into your workspaces and projects.

8.1 Defining Version Control Menu Options

The custom version control system allows you to invoke a version control command either by selecting an option from the **[Tools->Version Control]** sub-menu or by clicking a version control toolbar button. When either of these actions are performed, the associated commands are executed and the output is displayed in the “Version Control” tab of the “Output” window.

- To execute a version control menu option or toolbar button:
 1. Select whichever items you would like to apply the version control command to from the “Workspace” window. This may include a workspace, project(s), folder(s) and file(s). When the command is selected, all of the files will be extracted from the selected items and passed, in turn, to the version control command. For example, if you select the workspace icon then all of the files in all of the projects will be passed, in turn, to the version control command. This will include any system files. For example if you select the project item then
 2. Select the required menu option from the **[Tools->Version Control]** sub-menu or click the desired version control toolbar button.

The custom version control support allows you the most flexibility in specifying how a version control system is to be used. To configure it, select **[Version Control->Configure...]**. The “Version Control Setup” dialog will be displayed (figure 8.1).

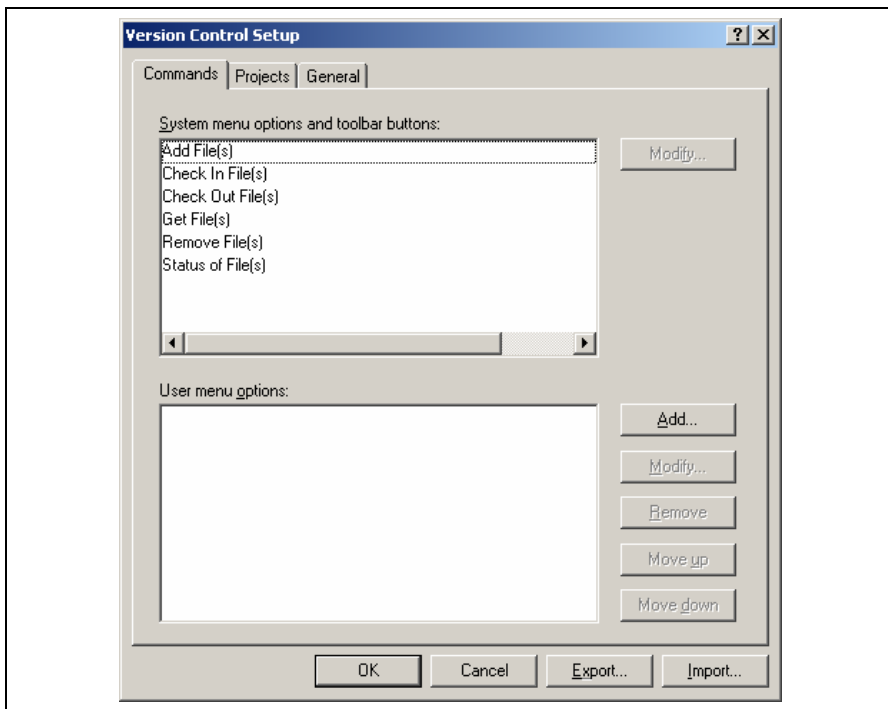

Figure 8.1: Version Control Setup Dialog Commands Tab

The “Commands” tab contains two lists of menu options. The first list, “System menu options and toolbar buttons”, represents those menu options which always appear on the version control sub-menu. These menu options also have an associated toolbar button on the version control toolbar. The second list, “User menu options”, represents those additional user defined options which are added to the bottom of the version control sub-menu. Figure 8.2 shows the structure of the version control sub-menu.

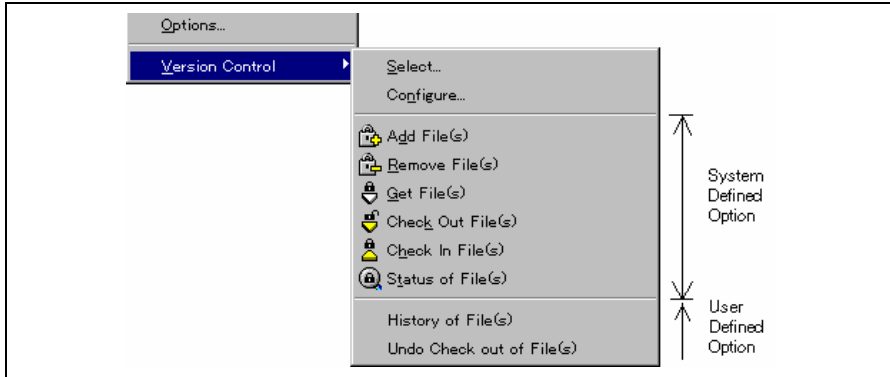

Figure 8.2: Version Control Sub-Menu

8.1.1 System menu options and toolbar buttons

In order to invoke commands from the toolbar or the system defined options of the [Tools->Version Control] sub-menu, you must first define the associated commands that should be executed when they are activated. The names of the options and their intended action are listed in table 8.1.

Table 8.1: System Menu Option

Option	Description
Add File(s)	Add selected file(s) to version control system.
Remove File(s)	Remove selected file(s) from version control system.
Get File(s)	Get a read only local copy of the selected file(s) from version control system.
Check In File(s)	Put back, i.e. update, the selected file(s) in version control system with the local copy.
Check Out File(s)	Get a writable local copy of the selected file(s) from version control system.
Status of File(s)	View the status of the selected file(s).

- ☞ To modify a system menu / toolbar option:
 1. Select [**V**ersion **C**ontrol->**C**onfigure...]. The dialog shown in figure 8.1 will be displayed.
 2. Select the option to be modified from the “System menu options and toolbar buttons” list and then click the “Modify...” button. The dialog shown in figure 8.3 will be displayed. This figure shows a dialog when “Add File(s)” has been selected for example.
 3. Commands are added via the “Add...” button. See the section, “*Defining Version Control Commands*”, later in this chapter for further information.
 4. Close the “Define Command for “<command>”” dialog by clicking “OK”.
 5. Close the “Version Control Setup” dialog by clicking “OK”.

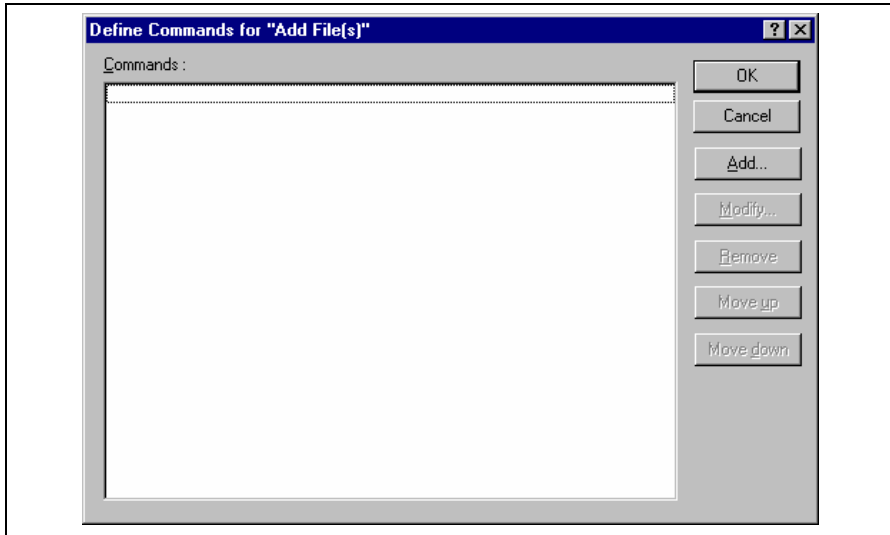

Figure 8.3: Modify System Menu Option (Example)

8.1.2 User menu options

You can create as many user defined menu options as you like, name them how you want and define their order in the menu. User defined menu options do not appear on the version control toolbar.

- ☞ To create a new version control menu option:
 1. Select [**Version Control->Configure...**]. The dialog shown in figure 8.1 will be displayed.
 2. Click the “Add..” button. The dialog shown in figure 8.4 will be displayed.
 3. Enter the name of the menu option into the “Option” field.
 4. Commands are added to the menu option via the “Add..” button. See the section, “*Defining Version Control Commands*”, later in this chapter for further information.
 5. Close the “Add Menu Option” dialog by clicking “OK”.
 6. Close the “Version Control Setup” dialog by clicking “OK”.

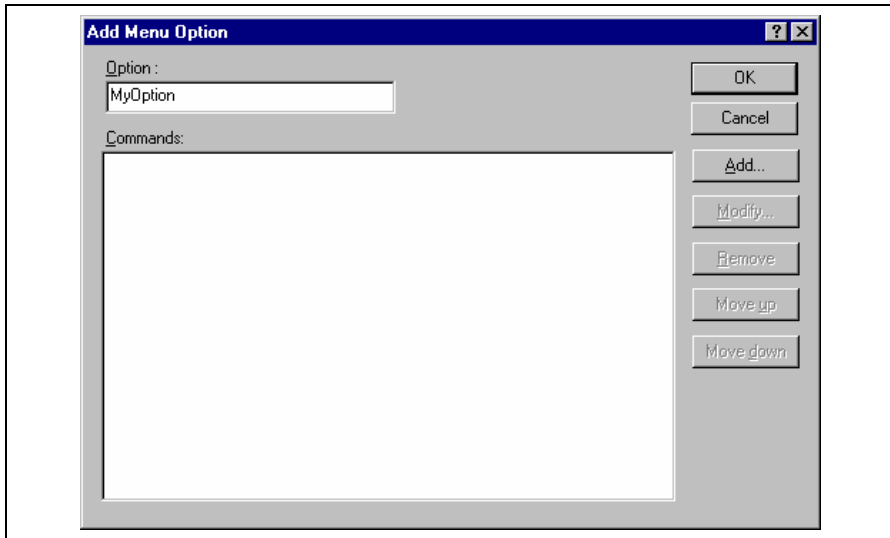

Figure 8.4: Add Menu Option Dialog

- To remove an existing version control menu option:
 1. Select [**Version Control->Configure...**]. The dialog shown in figure 8.1 will be displayed.
 2. Select the menu option to be removed from the “User menu options” list and then click the “Remove” button.
 3. Close the “Version Control Setup” dialog by clicking “OK”.
- To modify an existing version control menu option:
 1. Select [**Version Control->Configure...**]. The dialog shown in figure 8.1 will be displayed.
 2. Select the menu option to be modified from the “User menu options” list and then click the “Modify...” button beside the list. The dialog shown in figure 8.4 will be displayed. (The title of the dialog is “Modify Menu Option”.)
 3. Modify the commands as necessary and then click “OK”.
 4. Close the “Version Control Setup” dialog by clicking “OK”.
- To change the ordering of version control menu options:
 1. Select [**Version Control->Configure...**]. The dialog shown in figure 8.1 will be displayed.
 2. Select the menu option to be moved and then click the “Move up” and “Move down” buttons as necessary.
 3. Close the “Version Control Setup” dialog by clicking “OK”.

8.2 Defining Version Control Commands

Commands are defined when the “Add...” or “Modify...” buttons are clicked on the dialogs shown in figure 8.3 and figure 8.4. In either case, the dialog shown in figure 8.5 is invoked.

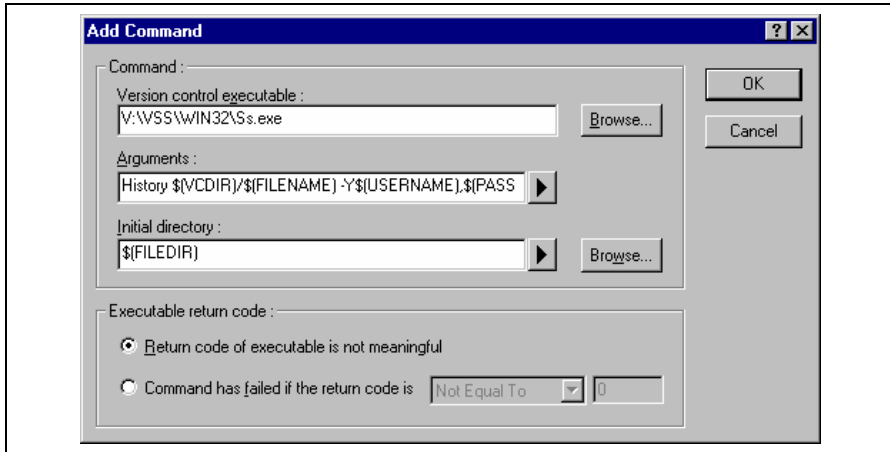

Figure 8.5: Add/Modify Command Dialog

- To define a command:
 1. Enter the full path of the command into the “Version control executable” field or browse to it graphically by clicking the “Browse...” button.
 2. Enter the arguments for the command into the “Arguments” field.
 3. Enter the initial directory in which you would like to run the executable from into the “Initial directory” field or browse to it graphically by clicking the “Browse...” button. In most cases this should be set to the “\${FILEDIR}” placeholder, i.e. execute the command from the same directory as the file.
 4. Set the “Executable return code” options as described in the following section.
 5. Click “OK” to define the new command.

8.2.1 Executable return code

If the return code of the command(s) can be used to indicate a failure then you should select the “Command has failed if the return code is” option and set the two fields to the right as required.

If the “Command has failed if the return code is” option is selected then the HEW will check the return code of each command to determine whether a failure occurred. If so, no further commands will be executed and any other processes which would follow the commands (e.g. build) will not be executed.

If the “Return code of tool is not meaningful” option is selected then the HEW will not check the return code of each. Consequently, all commands will execute regardless.

8.3 Specifying Arguments

It is obvious that arguments must be specified correctly, otherwise the version control tool executed will not function as intended. However, it is also important, when using custom version control support, to specify the arguments in a flexible way as a single version control command can be applied to more than one file. To facilitate this, the “Arguments” field has a placeholder button (refer to appendix C, “Placeholders”, for an in depth discussion of placeholders) which, when clicked on, invokes a pop-up menu of available placeholders (figure 8.6). An explanation of each placeholder and how their values are derived can be found in table 8.2, Arguments Field Placeholders.

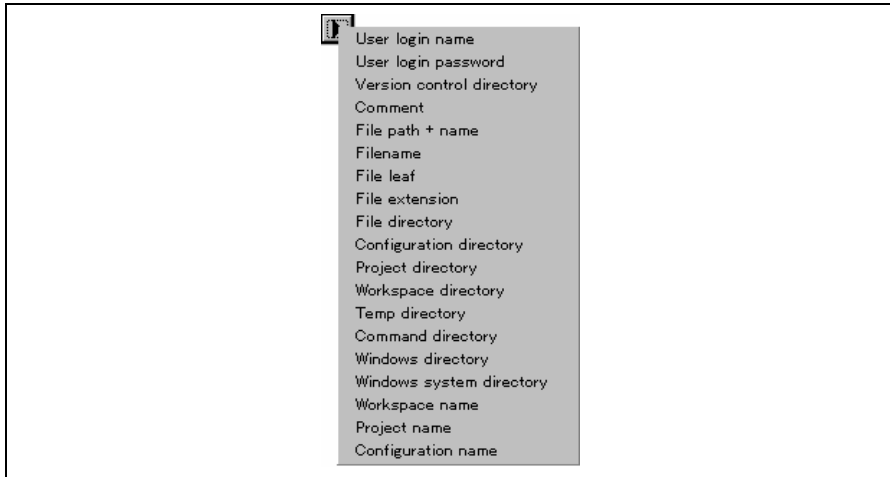

Figure 8.6: Arguments Field Placeholder Pop-up Menu

Table 8.2: Arguments Field Placeholders

Placeholder	Value and How its Determined
User login name	Current user login ("General" tab)
User login password	Current user password ("General" tab)
Version control directory	"Virtual" version control mapping ("Projects" tab)
Comment	Comment specified before command execution
File path + name	Full path and name of file involved in operation
Filename	Filename (including extension) of file involved
File leaf	Filename (excluding extension) of file involved
File extension	Extension of file involved in operation
File directory	Directory of file involved in operation
Configuration directory	Current configuration directory
Project directory	Current project directory
Workspace directory	Current workspace directory
Temp directory	Temporary directory
Command directory	Version control executable directory
Windows directory	Directory where Windows@ is installed
Windows system directory	Directory where Windows@ system files exist
Workspace name	Current workspace name
Project name	Current project name
Configuration name	Current configuration name

8.3.1 Specifying File Locations

When referring to a file's location, be sure to use a placeholder, otherwise the command will only relate to a hardwired file. For example, let's imagine that a version control executable has been selected which uses a `-GET` command to obtain a read only copy of a file. The "Arguments" field could be specified as:

```
-GET "c:\vc\files\project\main.c"
```

However, when executed, this command can only ever get the file MAIN.C. To resolve this problem, HEW uses a system of placeholders and directory mappings. The latter tell the HEW which "working" directories (i.e. where source files are being worked on) map to which "controlled" directories (i.e. where the source files are stored in the version control system). Mappings between these two directory systems can be specified via the "Projects" tab of the "Version Control Setup" dialog (figure 8.7).

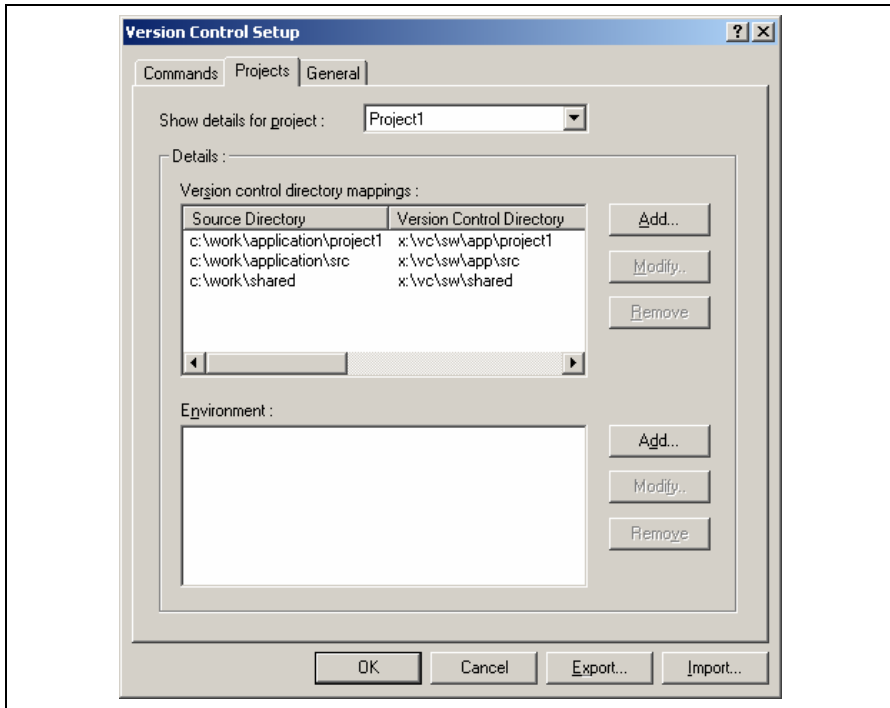

Figure 8.7: Version Control Setup Dialog Projects Tab

➤ To define a new mapping:

1. Select [**Version Control->Configure...**]. The dialog shown in figure 8.1 will be displayed. Select the “Projects” tab, and the dialog shown in figure 8.7 will be displayed.
2. Click the “Add...” button that is next to the “Version control directory mappings” list. The dialog shown in figure 8.8 will be displayed.
3. Enter the source (i.e. “working”) directory into the “Source directory” field or browse to it graphically by clicking the “Browse...” button.
4. Enter the version control directory (i.e. “controlled”) directory into the “Version control directory”.

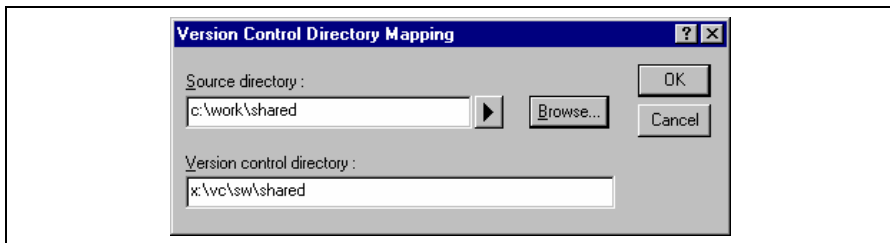

Figure 8.8: Version Control Directory Mapping Dialog

- ☞ To modify an existing mapping:
 1. Select [**Version Control->Configure...**]. The dialog shown in figure 8.1 will be displayed. Select the “Projects” tab, the dialog shown in figure 8.7 will be displayed.
 2. Select the mapping to be modified from the “Version control directory mappings” list and then click the “Modify...” button. The dialog shown in figure 8.8 will be displayed.
 3. Make the necessary changes to the two directories and then click “OK” to confirm the edits.
- ☞ To remove an existing mapping:
 1. Select [**Version Control->Configure...**]. The dialog shown in figure 8.1 will be displayed. Select the “Projects” tab, the dialog shown in figure 8.7 will be displayed.
 2. Select the mapping to be removed from the “Version control directory mappings” list and then click the “Remove” button.

Once the mappings have been defined you can use the “Version control directory” placeholder, \$(VCDIR), to represent the directory in which the project file is stored. Consider the scenario shown in figure 8.9. Here are three directories, which are mapped from a shared version control drive (X:\) to a local drive where the development is being done (C:\).

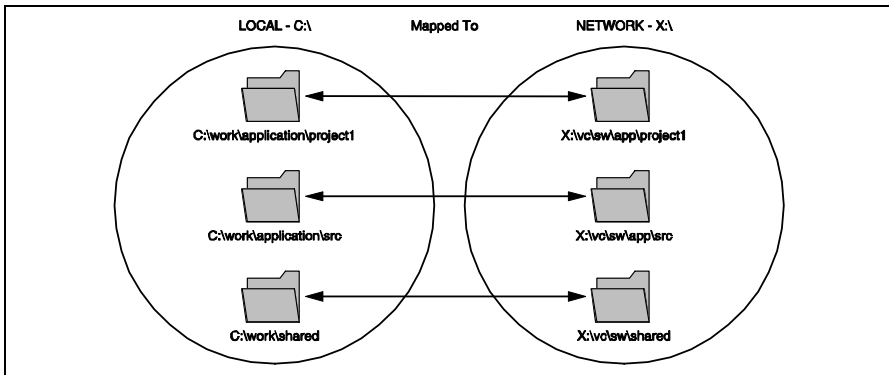

Figure 8.9: Example Mappings

Now let’s imagine that a version control executable has been selected which uses a –GET command to obtain a read only copy of a file. In order to get all of the files in a project we need to use the following command:

```
-GET "$ (VCDIR) \$(FILENAME) "
```

When the HEW executes the command for a given project file, it will replace \$(VCDIR) for the equivalent version control directory in the file mapping.

For example, suppose FILE1.C is located at:

```
c:\work\application\project1\file1.c
```

If the get command is applied to FILE1.C then:

- (1) x:\vc\sw\app\project1 is substituted for \$(VCDIR) as this is the version control directory mapping for c:\work\application\project1.
- (2) FILE1.C is substituted for \$(FILENAME).

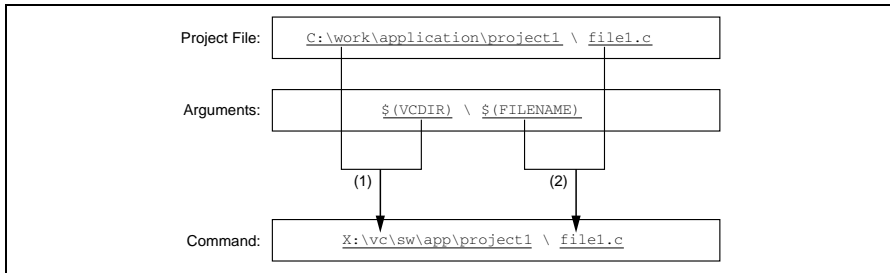

Figure 8.10: Example of Substitution

8.3.2 Specifying Environment

Select the “Projects” tab of the “Version Control Setup” dialog to view the current settings (figure 8.7).

To add a new environment variable click the “Add...” button beside the “Environment” list (the dialog shown in Figure will be invoked). Enter the variable name into the “Variable” field, the variable’s value into the “Value” field and then click “OK” to add the new variable to the “Environment” list.

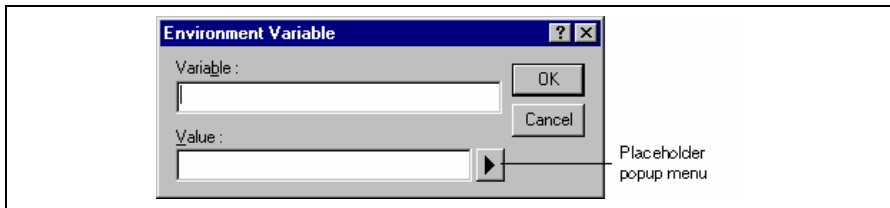

Figure 8.11: Environment Variable Dialog

To modify an environment variable, select the variable that you want to modify from the “Environment” list and then click the “Modify...” button beside it. Make the required changes to the “Variable” and “Value” fields and then click “OK” to add the modified variable back to the list. To remove an environment variable, select the variable that you want to remove from the “Environment” list and then click the “Remove” button beside it.

8.3.3 Specifying Comments

If a command contains the placeholder “\$(COMMENT)” then the HEW will request that you enter the comment when the command is executed (via the dialog as shown in figure 8.12).

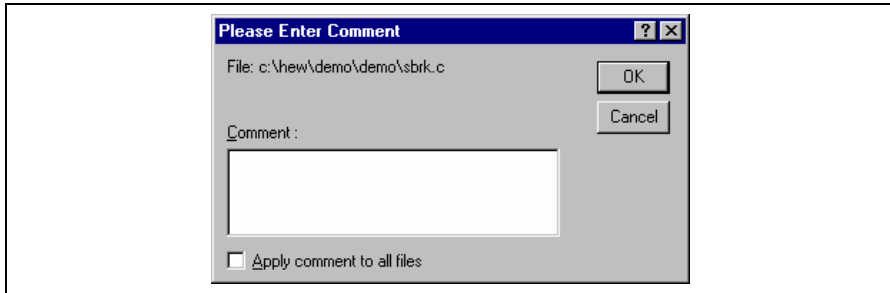

Figure 8.12: Please Enter Comment Dialog

You may specify a comment for each file or, if you would like to specify the same comment for all files, check the “Apply comment to all files” check box before clicking “OK”.

8.3.4 Specifying a User Name and Password

Most version control tools will require you to pass a user name and password on the command line in order to keep files secure and to keep a record of which files were changed by which users. The custom version control support provides two placeholders “User login name”, \$(USERNAME), and “User login password”, \$(PASSWORD). When the command is executed, these placeholders will be replaced with the current settings in the “General” tab of the “Version Control Setup” dialog (figure 8.13).

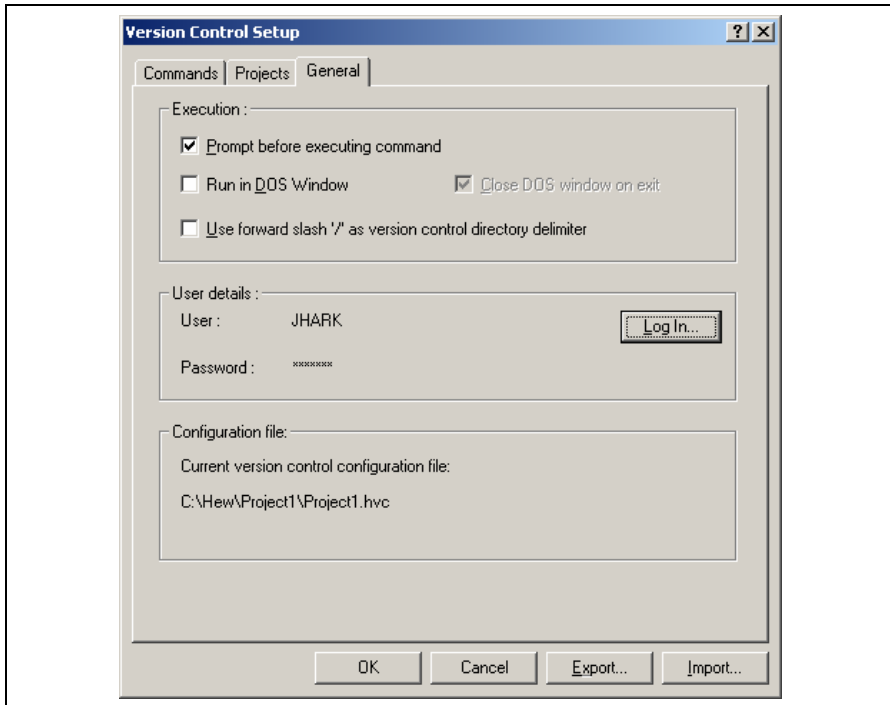

Figure 8.13: Version Control Setup Dialog General Tab

In order to give the \$(USERNAME) and \$(PASSWORD) fields a value you will first need to login. If you have not logged in before a command is executed which uses either of these placeholders then you will be prompted to do so before the command can be executed.

- To login (i.e. specify a user name and password):
 1. Click the “Log in...” button. The dialog shown in figure 8.14 will be displayed.
 2. Enter your user name into the “User name” field.
 3. Enter your password into the “Password” field.
 4. Re-type your password again into the “Confirm password by retyping it below” field.
 5. Click “OK” to set the new user name and password. If there is any inconsistency between the two versions of the password which you entered then you will be requested to type your password again.

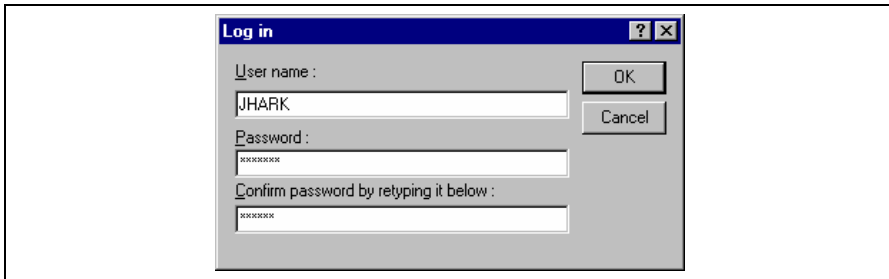

Figure 8.14: Log in Dialog

8.4 Controlling Execution

The “General” tab of the “Version Control Setup” dialog (figure 8.13) allows you to control the way in which the version control tool is executed. It also shows the full path to the current version control configuration file.

8.4.1 Prompt before executing command

If this check box is set then, before any version control commands are executed, a dialog is displayed (figure 8.15) which lists all of the files involved in the operation. Files may be deselected by clearing the associated check box. Clicking “OK” will apply the command to each of the selected files. Clicking “Cancel” will abort the operation.

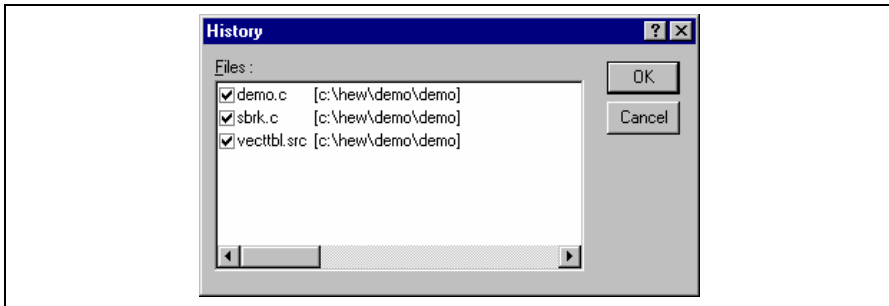

Figure 8.15: Command Prompt Dialog

8.4.2 Run in DOS Window

By default, the output of the version control commands is redirected to the “Version Control” tab of the “Output” window. If you would rather run each command in a separate DOS window then set this check box.

8.4.3 Use forward slash ‘/’ as version control directory delimiter

By default, when the HEW substitutes the placeholder \$(VCDIR) it uses the backward slash character ‘\’ to divide directories. However, if the version control system you are using uses a forward slash character (e.g. Visual SourceSafe) to divide directories then set the “Use forward slash ‘/’ as version control directory delimiter”.

8.5 Importing and exporting a Set-up

Each workspace can have a different version control set-up. The HEW allows you to store the version control settings independently so that you can import them into other workspaces. This greatly reduces the amount of time it takes to configure the same version control settings across several workspaces.

☞ To export a version control set-up:

1. Select [**Version Control->Configure...**]. The dialog shown in figure 8.1 will be displayed.
2. Click the “Export...” button. A standard file save dialog will be displayed. Browse to the directory in which you would like to save the configuration.
3. Enter the name of the file and then click “OK”.

☞ To import a version control set-up:

1. Select [**Version Control->Configure...**]. The dialog shown in figure 8.1 will be displayed.
2. Click the “Import...” button. A standard file open dialog will be displayed. Browse to the *.HVC file which you would like to import.
3. Select the file and then click “OK”.

9. Using Visual SourceSafe

The High-performance Embedded Workshop provides specific support for the Visual SourceSafe version control system. At the time of writing, the HEW can only attach to versions 5.0 and 6.0 of Visual SourceSafe.

The Visual SourceSafe version control system associates a project in your workspace with a project inside a Visual SourceSafe database. It allows you to quickly invoke the standard commands either by selecting an option from the [Tools->Version Control] sub-menu or by clicking a version control toolbar button.

9.1 Attaching Visual SourceSafe to a Workspace

The following sections describe how you can associate Visual SourceSafe with your current workspace.

9.1.1 Selecting Visual SourceSafe

First, you need to select Visual SourceSafe as the version control system.

- ☛ To use Visual SourceSafe 5.0 or 6.0:
 1. Select [Tools->Version Control->Select...]. The “Select Version Control System” dialog will be displayed (figure 7.3) which lists all of the supported version control systems.
 2. Select the “Visual SourceSafe 5.0/6.0” entry from the Version Control Systems list and click the “Select” button.
 3. Click “OK” to confirm the selection. The SourceSafe Login dialog is displayed (figure 9.1).
 4. Enter your Visual SourceSafe login into “Username” and password into “Password”.
 5. Enter into Database path the full path to the Visual SourceSafe database (i.e. SRCSAFE.INI) into which you would like to add this project.
 6. Click “OK”. The “Create SourceSafe Project” dialog is invoked (figure 9.2).
 7. The “Project name” field displays the name of the project (i.e. folder) to be created in the database. If necessary you can change this name to another.
 8. The tree underneath the “Project name” field shows the structure of the database specified in step 6. Select the folder into which you would like to create the folder specified in the “Project name” field.
 9. Click “OK”.
 10. HEW will require you to repeat steps 7-9 for as many projects as are present in the current workspace.

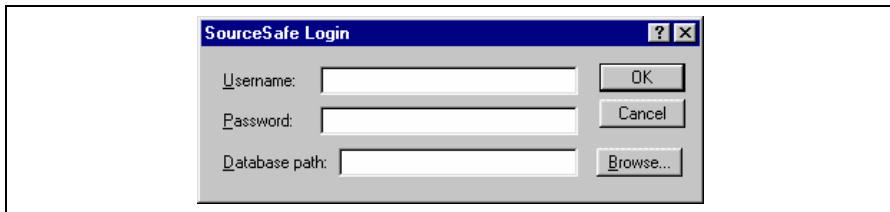

Figure 9.1: SourceSafe Login Dialog

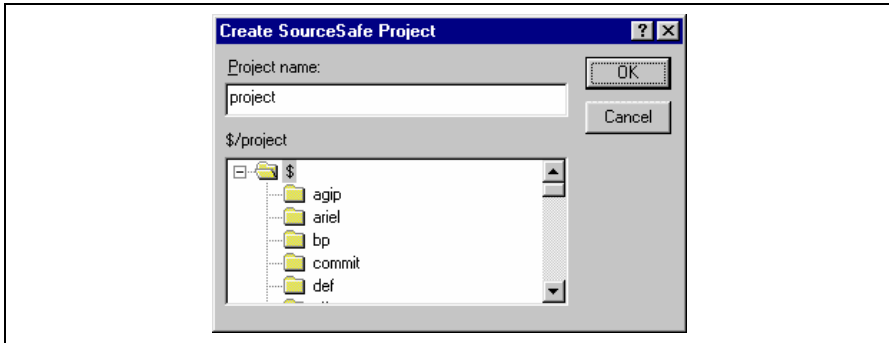

Figure 9.2: Create SourceSafe Project dialog

The HEW has now created the necessary projects within Visual SourceSafe and sets-up the version control toolbar and menu for immediate access. However, although the Visual SourceSafe projects themselves have been created, no files have been added to them.

9.1.2 Adding files to Visual SourceSafe

The previous section has only established the mappings between the project directory on your hard disk (i.e. the working directory) and the project directory in Visual SourceSafe (i.e. the controlled directory). Although the project directory (and any subdirectories) on your hard disk may contain many source files whereas the directly its mapped to in Visual SourceSafe will be initially empty.

Firstly, you must select Visual SourceSafe as the version control system.

☞ To add a file or files to Visual SourceSafe:

1. Select the file(s), which you would like to add to Visual SourceSafe. You may also select a file folder, project folder, a workspace folder or combination thereof. When selecting the project or workspace folder then the system files will be added to the selected file list. For example, selecting the project folder will also add the project file to the file list. If the project file is then checked out and the version is newer than when it was last loaded you will be asked whether you want to reload the project.
2. Click the Add Files toolbar button () or select the **[Tools->Version Control->Add Files]** menu option.

When you add files to Visual SourceSafe the local versions in your working directory will become read only. To check that the add files operation was carried out as you expected, or to quickly review the status of all of the files in a project:

1. Select the project folder whose files you want to check.
2. Click the Status of Files toolbar button () or select the **[Tools->Version Control->Status of Files]** menu option.
3. The status of each file will be displayed in the “Version Control” tab of the “Output” window. The information shown includes whether the file is added to the project, if the file is checked out and, if it is checked out, who did so.

9.2 Visual SourceSafe commands

The following 8 operations are available:

- Add a file to version control
- Remove a file from version control
- Get a read only copy of a file or files
- Check out a read/write copy of a file or files (i.e. for editing)
- Check in a previously checked out file or files (i.e. update Visual SourceSafe with the edits made)
- Undo a previously check out operation on a file or files (i.e. cancel any edits made)*
- View the status of a file
- View the history of a file*

*These commands can only be accessed via the **[Tools->Version Control]** sub-menu whereas all of the other commands can be accessed from both the toolbar and menu.

9.2.1 Removing a File from Version Control

Although files appear in your HEW project (in the “Projects” tab of the “Workspace” window, Visual SourceSafe is not necessarily controlling them.

☞ To remove a file or files from Visual SourceSafe:

1. Select the file(s), which you would like to remove from Visual SourceSafe. You may also select a file folder, project folder, a workspace folder or combination thereof.
2. Click the Remove Files toolbar button () or select the **[Tools->Version Control->Remove Files]** menu option.

9.2.2 Getting a Read Only Copy of a File from Version Control

Visual SourceSafe protects your source files and ensures that only one user can have a writable copy of a controlled file at any one time. However, it is possible for any user to obtain a read only copy of any file.

☞ To get a read only copy of a file or files from Visual SourceSafe:

1. Select the file(s), which you would like to get from Visual SourceSafe. You may also select a file folder, project folder, a workspace folder or combination thereof.
2. Click the Get Files toolbar button () or select the **[Tools->Version Control->Get Files]** menu option.

9.2.3 Checking Out a Writable Copy of a File from Version Control

Visual SourceSafe protects your source files and ensures that only one user can have a writable copy of a controlled file at any one time. The check out operation takes a writable copy of the file from Visual SourceSafe and places it on your local drive. This can only be done if another user does not already check out the file or files in question.

- ☞ To check out a writable copy of a file or files from Visual SourceSafe:
 1. Select the file(s), which you would like to check out from Visual SourceSafe. You may also select a file folder, project folder, a workspace folder or combination thereof.
 2. Click the Check Out Files toolbar button () or select the [Tools->Version Control->Check Out Files] menu option.
 3. When the operation is finished the file has a red tick next to its name. This means you as the current user of HEW has checked it out.

9.2.4 Checking In a Writable Copy of a File into Version Control

Visual SourceSafe protects your source files and ensures that only one user can have a writable copy of a controlled file at any one time. The check out operation takes a writable copy of the file from Visual SourceSafe and places it on your local drive. Once a file is checked out it is edited and then checked back in so that the edits can be made available to other users.

- ☞ To check in edits made to a file or files in Visual SourceSafe:
 1. Select the file(s) upon which you would like to check back into Visual SourceSafe. You may also select a file folder, project folder, a workspace folder or combination thereof.
 2. Click the Check In Files toolbar button () or select the [Tools->Version Control->Check In] menu option.

9.2.5 Undoing a Check Out Operation

Visual SourceSafe protects your source files and ensures that only one user can have a writable copy of a controlled file at any one time. The check out operation takes a writable copy of the file from Visual SourceSafe and places it on your local drive. Once a file is checked out it is edited and then checked back in so that the edits can be made available to other users. However, if the check out operation was carried out by mistake, or perhaps is no longer required, then the operation can be undone.

- ☞ To undo a check out of a file or files from Visual SourceSafe:
 1. Select the file(s) upon which you would like to undo a previous check out operation. You may also select a file folder, project folder, a workspace folder or combination thereof.
 2. Select the [Tools->Version Control->Undo Check Out] menu option.

9.2.6 Viewing the Status of a File

Although files appear in your HEW project (in the Projects tab of the Workspace window), Visual SourceSafe is not necessarily controlling them. Of those files, which are being controlled by Visual SourceSafe, some will be checked in and others will be checked out (i.e. being edited by a user). The status command displays the current status of a file or file(s).

- ☞ To view the status of a file or files in Visual SourceSafe:
 1. Select the file(s) whose status you would like to view. You may also select a file folder, project folder, a workspace folder or combination thereof.
 2. Click the Status of Files toolbar button () or select the [Tools->Version Control->Status of Files] menu option.
 3. If a file has a blue tick next to it a user different to you has checked it out.

9.2.7 Viewing the History of a File

Visual SourceSafe controls the edits to the files in its projects and allows you to view the complete history of these edits right back to the time that the file was first added to the project.

- ☞ To view the history of a file or files in Visual SourceSafe:
 1. Select the file(s) whose history you would like to view. You may also select a file folder, project folder, a workspace folder or combination thereof.
 2. Select the [Tools->Version Control->Show History] menu option.

9.3 Visual SourceSafe Integration Options

You can control the way in which the history and status commands are displayed by selecting [Tools->Version Control->Configure...].

To display the results of a history command in a dialog box then check the “Display dialog box for history” check box or clear it if you would rather display the output in the “Version Control” tab of the “Output” window. To display the results of a status command in a dialog box then check the “Display dialog box for file status” check box or clear it if you would rather display the output in the “Version Control” tab of the “Output” window.

10. Network Facilities

10.1 Overview

The High-performance Embedded Workshop is capable of sharing workspaces and projects across a network. This allows users to concurrently work on shared projects and see each other's changes as they happen. This system can be used in conjunction with version control. The major difference with using this system is that each user can modify and update the workspace and project without making all of the other users reload their project and potentially lose all their changes.

This system is implemented by making one of the machines attached to the network the server machine. All other client machines then use the service this machine is providing. So if one of the client machines adds a new file, the server machine is notified. The server then notifies all other clients the action has taken place. This structure is shown below in figure 10.1.

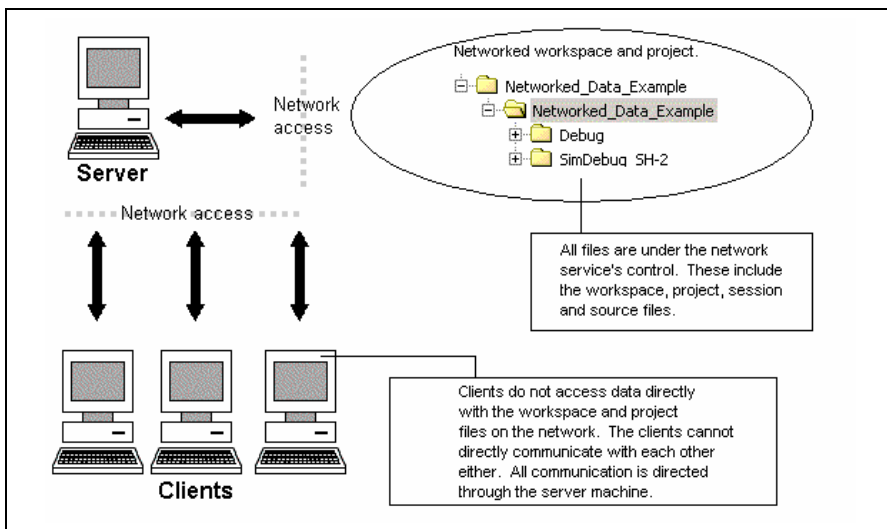

Figure 10. 1: Network database access structure

The network system allows users to be given access rights to files. This allows the project administrator to make sure the only people who can modify the project and source files are allowed to do so. This might allow the administrator to limit each user to only have write capabilities for their own area of the project, other areas would be read only. This could limit any potential conflict or damage one user could do to other areas of the project. These limitations can be set to a number of different levels. This is outlined later in this section.

Note: Certain operations are locked when other clients are carrying them out. This means that if one machine is currently changing the toolchain options all of the other machines can only see read only versions of this data.

Note: The performance of HEW does suffer when using the network facilities. If working in a small team it might be more suitable to use the single user mode and version control.

10.1.1 Enabling network access

- ☞ To use network access:
 1. Select [**Tools->Options**]. The HEW tools options dialog is displayed.
 2. Select the network tab. This is displayed in figure 10.2.
 3. Click the enable network access checkbox. This should add an administrator to the system without a password. The administrator is the only user that can add additional users to the system and change user access rights. The administrator has the highest level of access.
 4. Before leaving the network dialog the administrator must set their password. It is not possible to leave this dialog until this is completed. This is described below.

10.1.2 Setting the administrator user's password

- ☞ To set the password:
 1. Continue from the previous sections steps.
 2. Click the password button. This should have been enabled when the network data access was enabled.
 3. The password dialog is displayed. This is shown in figure 10.3.
 4. The user name is read only in the top field. In this case it should be Admin.
 5. Type the new password into both of the fields and click OK.
 6. This should set the user and password on the [Tools->Options] network tab.
 7. It is now possible to leave the [Tools->Options] dialog.
 8. When the dialog is closed you are asked if you want to save the workspace and then re-open it. This is because the workspace must be re-opened in the shared access mode. If the changes are not saved then they will be lost.
 9. When the workspace is re-opened a dialog is displayed which asks you to log back into the system. Once you have logged in a dialog is displayed which shows your current access rights. For example if you are the admin user the level will be administrator. When this dialog is closed the HEW server window is opened and the network facilities are enabled.

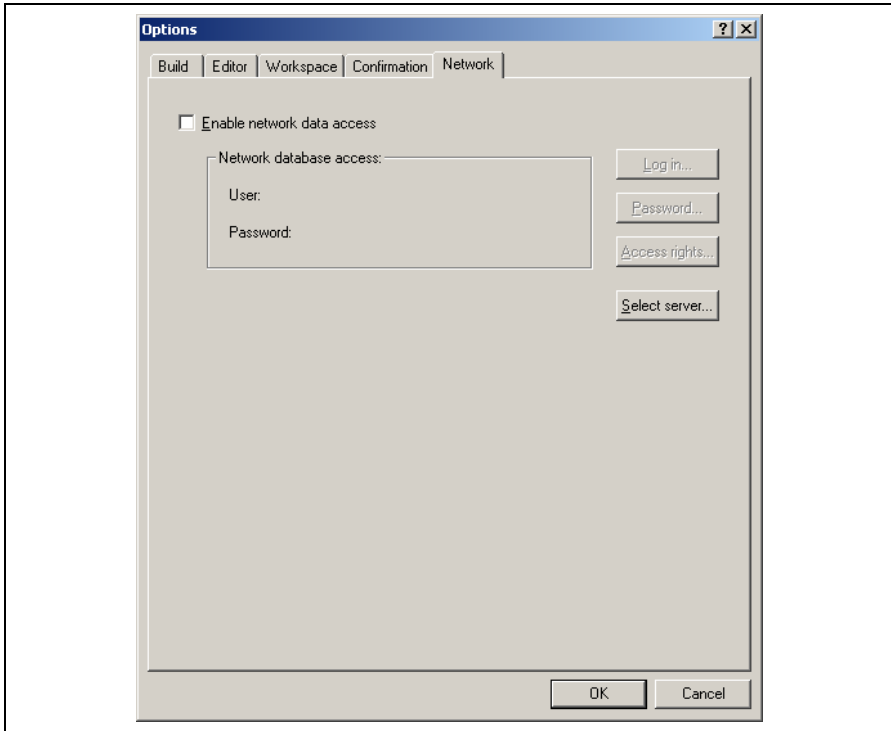

Figure 10. 2: Initial setup of Network tab

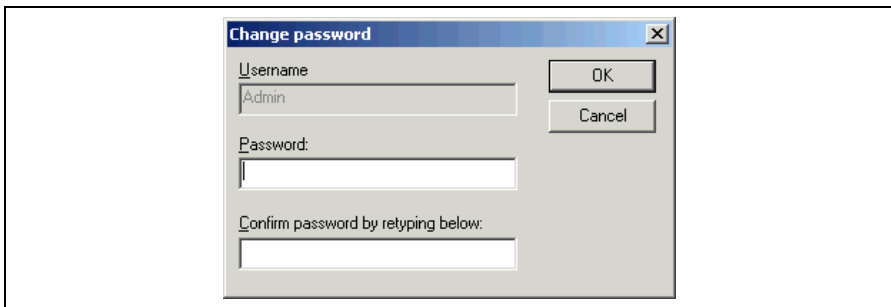

Figure 10. 3: Change password dialog

10.1.3 Adding new users to the system

The initial setting of the network database adds an administrator user and a guest user to the system. The following levels of access are possible in the HEW system:

- **Administrator:**

Full access to every aspect of HEW. The user can add and remove users from the projects and change access rights. The administration user can change the workspace and project files and also the source files.

- **Full read/write access:**

The workspace and project files can be modified, as can the source files. But it is not possible to change user access rights from this access level.

- **Read/write file access:**

Only the source files can be modified. All project settings can only be viewed not modified.

- **Read only:**

All source files and project files can only be viewed as read only. Nothing can be modified.

When any user opens a network-enabled project they must type in their user name and password. Until this is done no access can be granted. Once entered the user is given one of the levels of access as seen above.

☞ To add a new user to the system:

1. Log in with a user who has administrator access rights. The process for doing this is described above.
2. Select [**Tools->Options**]. The HEW tools options dialog is displayed.
3. Select the network tab. This is displayed in Figure 10.2.
4. Click the access rights button. The dialog displayed in Figure 10.4 is displayed.
5. Click the add button. The log in dialog is displayed. This allows you as the administration user to add a new log in name and password. Normally the password should be set to some default text or left blank. Then click OK.
6. Once OK is clicked the user is added with read only rights. To change the access level select the user you wish to modify and then click the required radio button. Then click OK to save the access rights changes.

☞ To remove an existing user to the system:

1. Log in with a user who has administrator access rights. The process for doing this is described above.
2. Select [**Tools->Options**]. The HEW tools options dialog is displayed.
3. Select the network tab. This is displayed in Figure 10.2.
4. Click the access rights button. The dialog displayed in Figure 10.4 is displayed.
5. Select the user you wish to remove in the users list.
6. Press the remove button.
7. Then click OK to save the access rights changes.

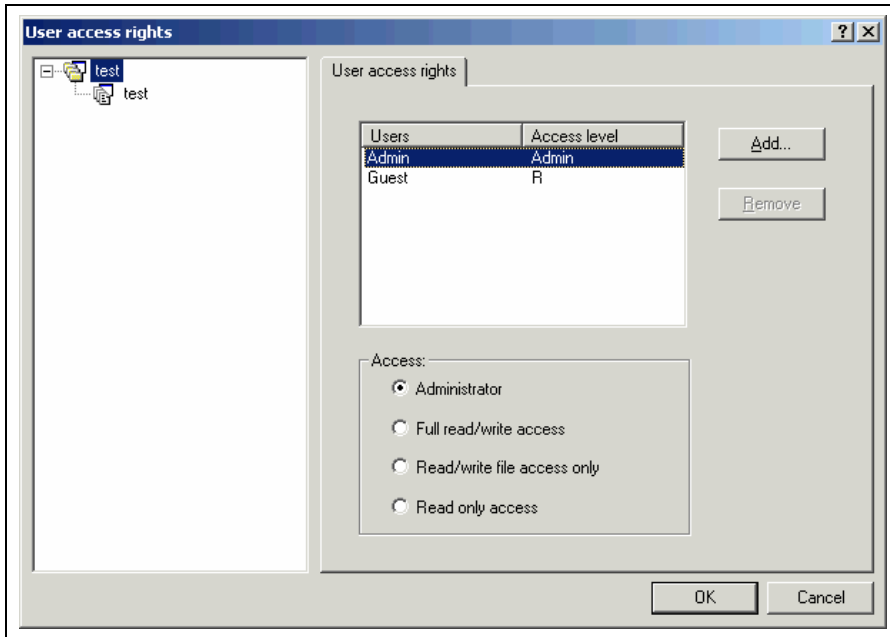

Figure 10. 4: User access rights dialog

10.1.4 Changing your password

To change your password:

1. Log into the HEW network database you are changing your password for. Select **[Tools->Options]**. The HEW tools options dialog is displayed.
2. Select the network tab. This is displayed in Figure 10.2.
3. Click the password button.
4. Enter your new password and confirm it in the second edit box.
5. Click OK.
6. Then click OK to save the password change.

10.1.5 Using the network HEW service

When you connect to a networked project for the first time the HEW automatically connects you to the correct network HEW service. This is defined using machine name. If the service cannot be found using the machine name in the workspace then the dialog displayed in figure 10.5 is shown. Simply type or browse to the machine where the service is located and click OK. If you want to be the server machine then leave the radio button on its default selection, use local machine.

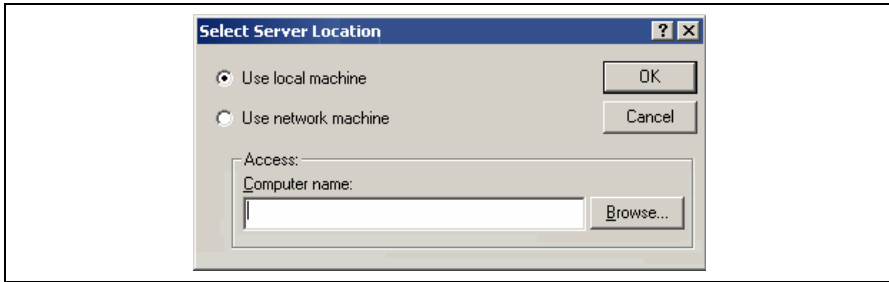

Figure 10. 5: Select machine name

If you have previously been the server of a workspace then the following message will be displayed when you attempt connection to another machine. This dialog is displayed in figure 10.6. Clicking OK then connects your machine to the new location.

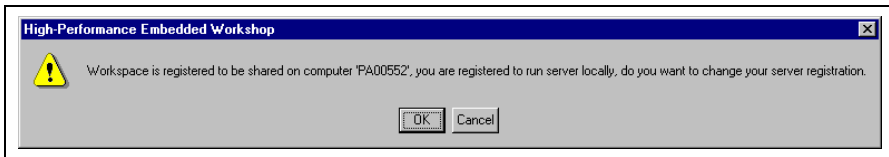

Figure 10. 6: Select machine name

Note: If the network is running multiple HEW workspaces with the network service enabled then a user can only access one of them at one time. The only instance when this is not the case is if the same machine is serving all of the network workspaces.

11. Difference View

The High-performance Embedded Workshop has an integrated difference view. This view allows detailed difference comparisons to be made with local files on the drive and also with files in the version control system. In the HEW version 3.0 onwards the Visual SourceSafe component has this facility.

The difference window can be invoked two ways. The first is from the show differences menu item on the tools menu. The second is via the workspace window pop-up with the same name. When using the pop-up menu the current file selection is automatically added to the edit box. Clicking the show differences menu item displays the dialog shown below in figure 11.1.

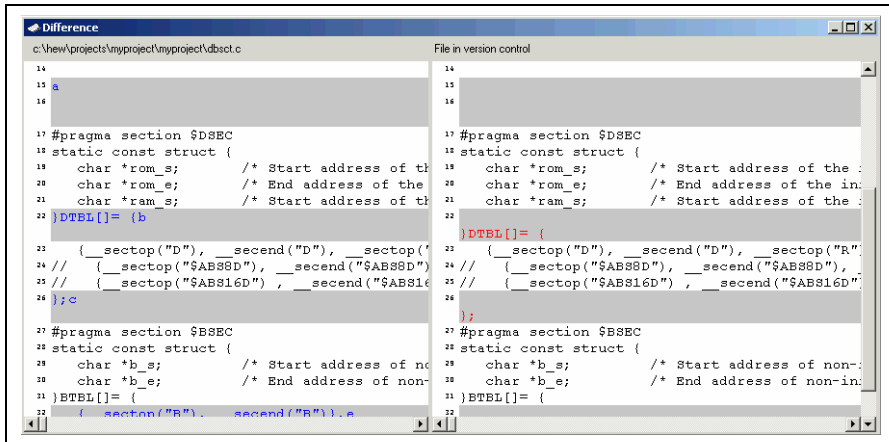

Figure 11. 1: Difference view

- To perform a difference comparison with two files on your local drive:
 1. Select [Tools->Show Differences...]. The difference compare files dialog is displayed. This is shown in figure 11.2.
 2. Ensure the compare with file on drive radio button is enabled.
 3. Enter the first and second file to compare. You can either select a previous difference comparison or browse to a new file.
 4. Clicking the advanced button displays the dialog in figure 11.3. This allows you to perform the difference comparison without taking white space into account. Click OK when you are finished with this options dialog.
 5. Click compare.
 6. The difference view is displayed. The two files being compared are loaded into each side of the split view. Their names are at the top of each window.

- To perform a difference comparison with a local file and a file in SourceSafe:
 1. Ensure the SourceSafe component is enabled. Also note that the file must be have been added into the version control system.
 2. Select [Tools->Show Differences...]. The difference compare files dialog is displayed. This is shown in figure 11.2.
 3. Ensure the compare with version control radio button is enabled.

4. Enter the first file to compare. You can either select a previous difference comparison or browse to a new file.
5. Clicking the advanced button displays the dialog in figure 11.3. This allows you to perform the difference comparison without taking white space into account. Click OK when you are finished with this options dialog.
6. Click Compare.
7. The difference view is displayed as shown in figure 11.1.

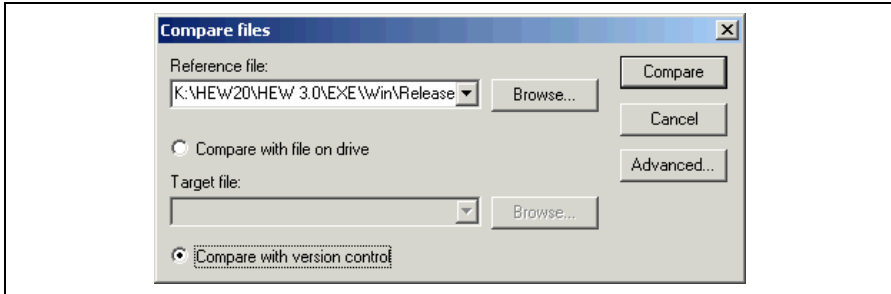

Figure 11. 2: Difference compare files dialog

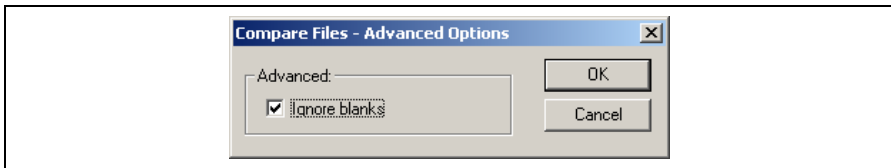

Figure 11. 3: Difference advanced options dialog

The difference view functionality can be accessed in two different ways. The difference view has its own toolbar this is shown in figure 11.4. This functionality can also be accessed via the difference window right mouse button pop-up. This is shown in figure 11.5.

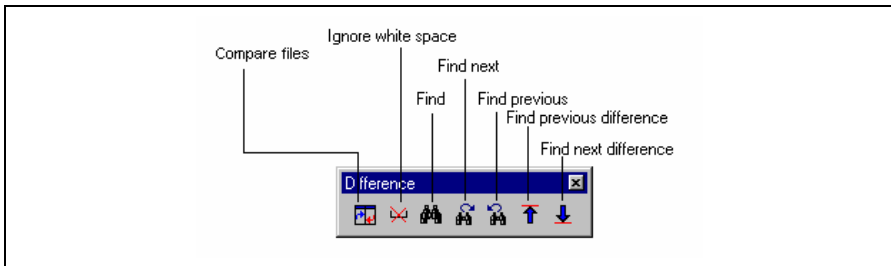

Figure 11. 4: Difference toolbar

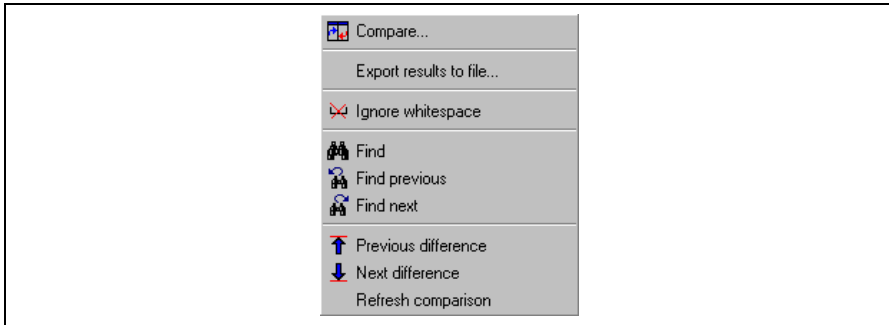

Figure 11. 5: Difference popup menu

The functionality for each menu item is described below:

- **Compare:** This opens a new compare window so that some new files can be compared and the differences displayed.
- **Export results to file:** This opens a dialog which allows you to choose a file to export the current difference results to a textual format.
- **Ignore white space:** The ignore white space option which is on the advanced options dialog can be toggled via this menu item.
- **Find:** Displays a standard find dialog. This uses the same find dialog as the HEW editor.
- **Find next:** Finds the next string that meets the find requirements.
- **Find previous:** Finds the next previous string that meets the find requirements.
- **Previous Difference:** Automatically jumps the view to the next previous difference.
- **Next Difference:** Automatically jumps the view to the next difference.
- **Refresh comparison:** Refreshes the view to manually run the difference comparison again. This can be used if either file has been modified since the last comparison.

The difference window also allows the colours in the view to be customised. This procedure is outlined below:

- ☞ To change the colors viewed in the difference window:
 1. Select [**Tools->Format Views...**]. The format views dialog is displayed.
 2. Expand the difference view. The dialog is shown and looks the same as figure 11.6.
 3. Select the category you want to change. The color display tab is displayed and allows modification. The categories available are Left hand side moved lines, Left hand side different lines, Right hand side moved lines and Right hand side different lines,
 4. Click OK to keep the changes.

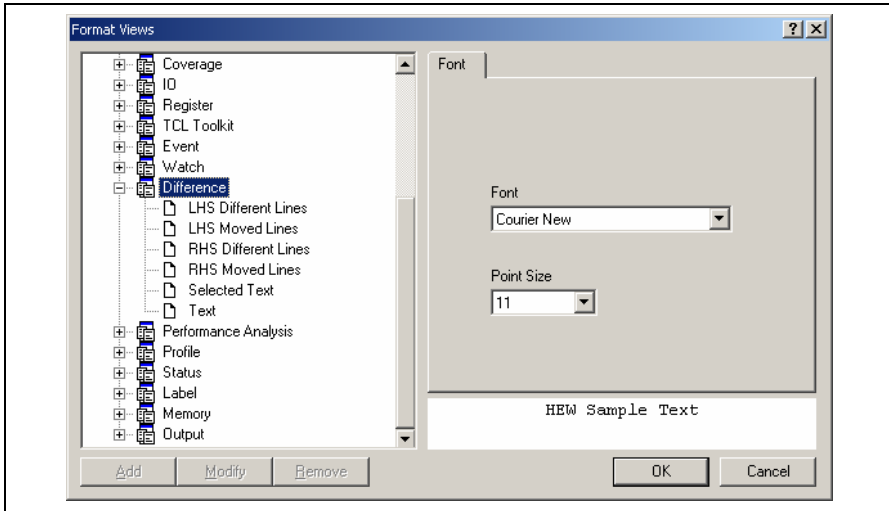

Figure 11. 6: Format views dialog

12. Technical Support

The High-performance Embedded Workshop has a number of integrated technical support features.

- To check for HEW product updates or service packs:
 1. Select [**Help->Technical support->Check website for updates**].
 2. Your default web browser is invoked and defaults to the HEW download page for your region.
 3. Browse this area for HEW updates to fix bugs or add new features.

Occasionally you may experience some unforeseen problems with the HEW application. If a problem does occur that results in a application crash the HEW bug tracking program will be invoked automatically. This allows you to compile a bug report and this can then be sent to your technical support contact in a variety of ways. It is also possible to invoke this tracker program manually. This is described below:

- To create and send a HEW bug report:
 1. Select [**Help->Technical support->Create Bug Report**].
 2. Detailed information is generated from your HEW system. This may take some time. The bug report dialog is then displayed. This is shown in figure 12.1.
 3. It is possible to then add additional information concerning the exact issue you have found in the large edit box.
 4. Once you are happy with your report, you can choose the method of sending the report in the submit drop list. You can print it, e-mail it, or save it to a disk.
 5. Then click submit. This will send the report by the selected method.

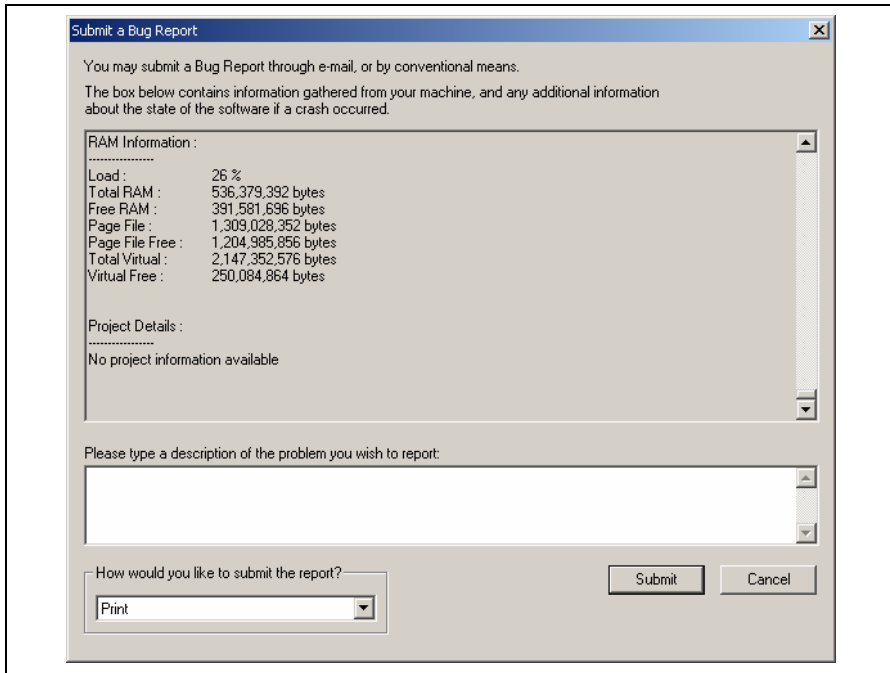

Figure 12. 1: Submit bug report dialog

13. Navigation facilities

The High-performance Embedded Workshop has a number of integrated navigation facilities. The navigation window is located alongside the project and templates window. This view is shown below in Figure 13.1.

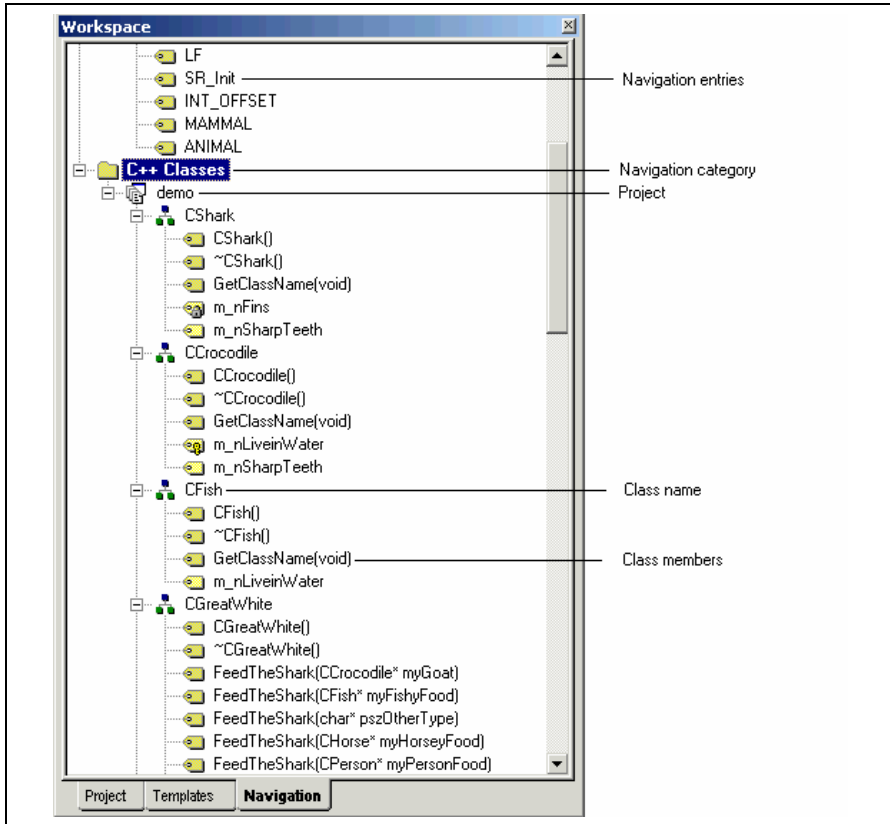

Figure 13.1: Navigation view

The navigation view contains categories for all supported navigation types. In HEW 3.0 the following navigation components are supported as standard:

C Defines: All #defines for C and C++ source files are displayed.

C Functions: All ANSI C standard functions are for C source files displayed.

C++ Classes: All classes, functions and members are displayed for C++ source files.

Each category is displayed in the top level of the view. Underneath each category each project in the workspace is displayed. Then the items belonging to that particular project are displayed below the project icon.

It is possible to disable scanning for certain navigation categories if you do not require the information.

- To switch off a navigation category:
 1. Right click on the Navigation window. The pop-up menu displayed in figure 13.2 is shown.
 2. Select the “Select Categories...” menu item.
 3. The dialog in figure 13.3 is displayed.
 4. Uncheck any categories you are not interested in seeing definitions for.
 5. Click OK.

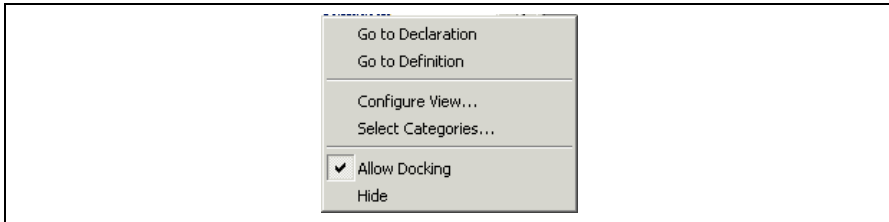

Figure 13. 2: C++ Navigation pop-up menu

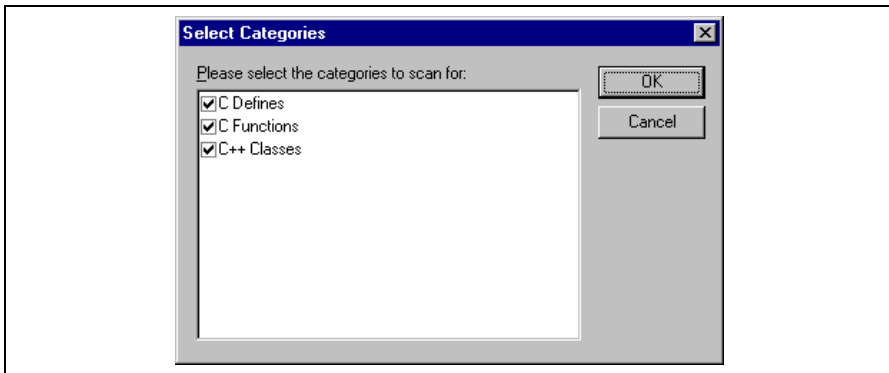

Figure 13. 3: C++ Navigation select categories dialog

Note: The navigation items are displayed gradually as the files are scanned. This means it may take some time if there are many files to fully complete the Navigation view update.

Files are rescanned when they are saved. This means that navigation information will not be available for new classes and functions until the file or files are saved.

13.1 C++ Navigation component

The C++ navigation component is the most complicated of the three supported navigation components. It supports the following structures in the view for C++ source files. The basic structure of the information is shown below in figure 13.4.

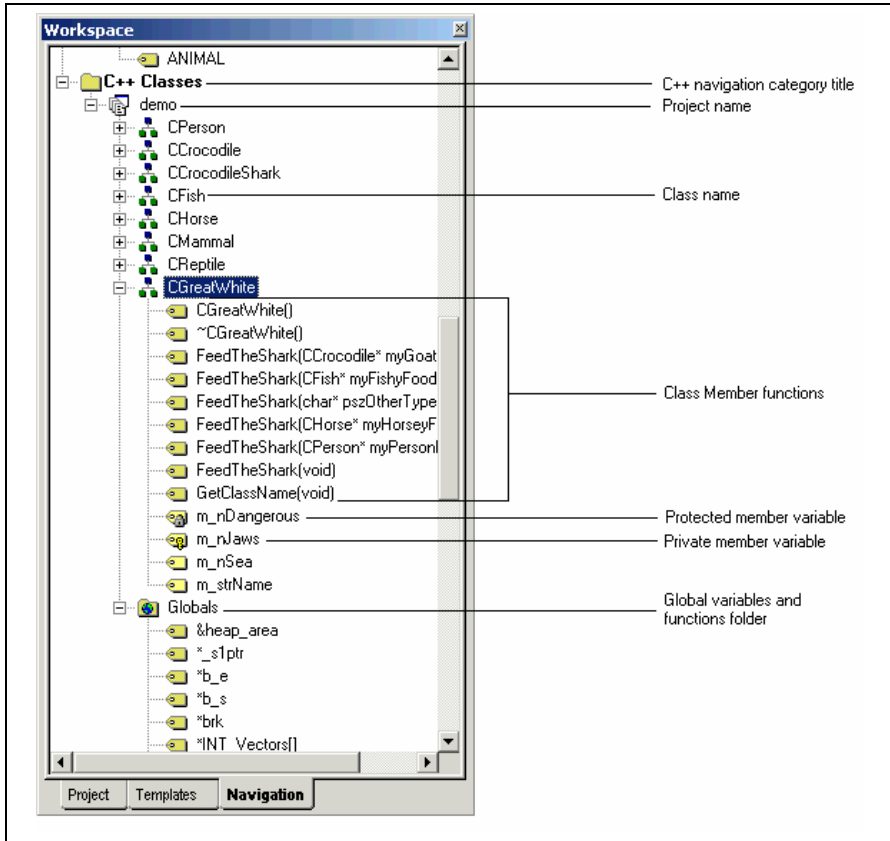

Figure 13. 4: C++ Navigation information

The C++ navigation view uses a number of icons to describe the type of function or variable the icon belongs too. These are listed in the table below:







Icon	Description
	Public member function
	Protected member function
	Private member function
	Public member variable
	Protected member variable
	Private member variable

Figure 13. 5 C++ Navigation Icons

The navigation view allows you to move around your source code quickly and efficiently. Double clicking on a navigation item by default jumps you to the associated navigation items definition. Normally the definition is found in the source file and the declaration is found in the header file.

This default behavior can be modified for this action. This can be achieved via the configure view dialog. The configure view dialog modifies the way data in the Navigation view is displayed.

☞ To configure the C++ navigation views data:

1. Right click on a C++ navigation item in the navigation window. The pop-up menu displayed in figure 13.2 is shown.
2. Select the “Configure view” menu item.
3. The dialog in figure 13.6 is displayed.
4. Decide what items you wish to modify and click OK to accept the changes.

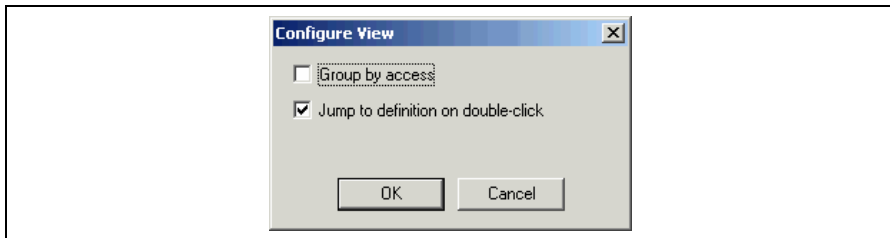

Figure 13. 6 C++ Configure view dialog

The following items are available on the configure view dialog.

- Group by access: This option groups the display of public, protected and private member variables and functions together in the Navigation view.

- Jump to definition on double click: By default this option is checked. If this option is switched off then a dialog is displayed which asks you where you wish to jump. You rather than HEW resolve the ambiguity. This dialog is shown in figure 13.7.

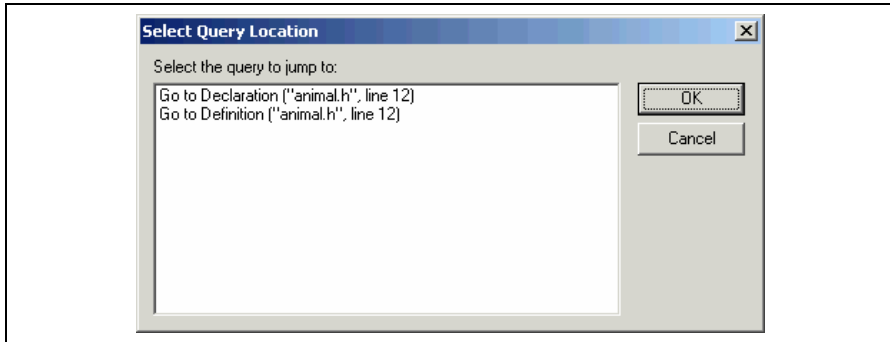

Figure 13. 7 Select Query Location dialog

Another useful facility is the capability of viewing the base or derived classes for a certain selection.

☞ To view the Base or derived classes

1. Select the class that interests you in the Navigation view.
2. Right click and view the pop-up menu.
3. To see the derived classes for the selection click the “Show Derived Classes” menu item. To see the base classes for the selection click the “Show Base Classes” menu item.
4. Depending on the selection a dialog is displayed which shows the class structure selected in an expanded tree format.
5. Click Close to close this dialog once you have the information you require.

13.2 C Function and #defines navigation components

These components simply add the function and #define definitions to the Navigation view. It is then possible to jump to these definitions by double clicking on the label you wish to view.

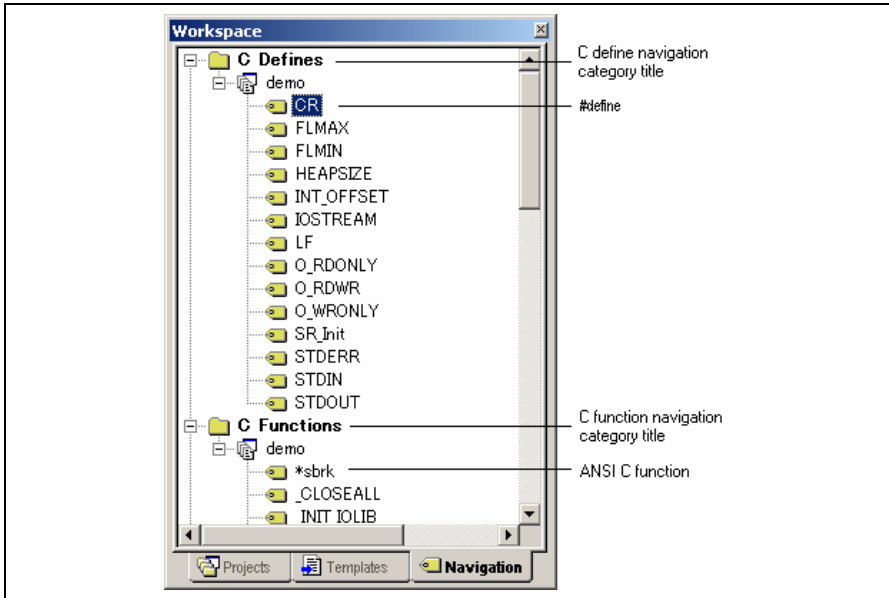

Figure 13. 8 C Function and #defines navigation information

14. Smart Editor

Another feature of the High-performance Embedded Workshop is its smart edit facility. This is enabled by default for all C++ source files. This feature allows the HEW editor to access C++ navigation information and provide auto-completion help when using C++ classes and member functions.

☞ To view the Smart edit status:

1. Click on the [Tools->Options] menu item.
2. Select the “Editor” tab of the tools options dialog.
3. The dialog in figure 14.1 is displayed. The “Enable Smart-edit for C++ files” should be checked.
4. Click OK.

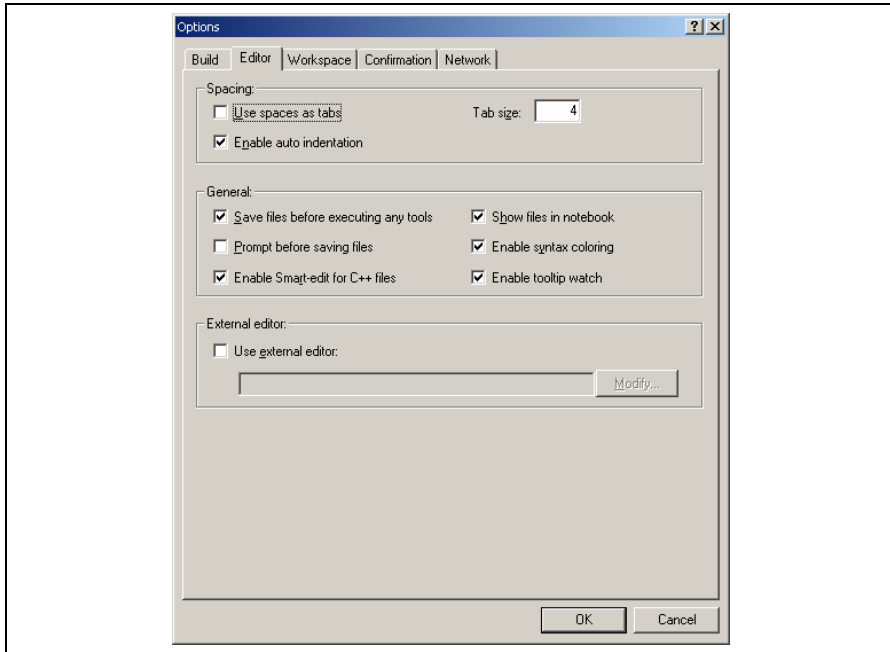

Figure 14.1: Options Dialog Editor Tab

With this option switched on if you are working on a C++ file the smart-edit capability should be enabled.

Note: If the C++ Class navigation category has been switched off the Smart-edit capability of HEW will not be active.

During normal usage the following editor operations will make the smart edit facilities visible.

- ☞ If you are using an object and are trying to access the members using the '.' or '>'. If you do this a pop-up will be displayed which may help you select the correct member more efficiently than typing. Whilst typing the pop-up will keep track of the keys you have pressed to help your selection. If you press

return then the currently selected member will be added. This pop-up is also used when using the '::' method and it is displayed in figure 14.2.

➤ If you are trying to use a C++ function then the dialog in Figure 14.3 is displayed when the first open bracket is entered. This dialog allows you to see what functions are available for the current object. Selecting the function automatically enters the remaining parameters for you.

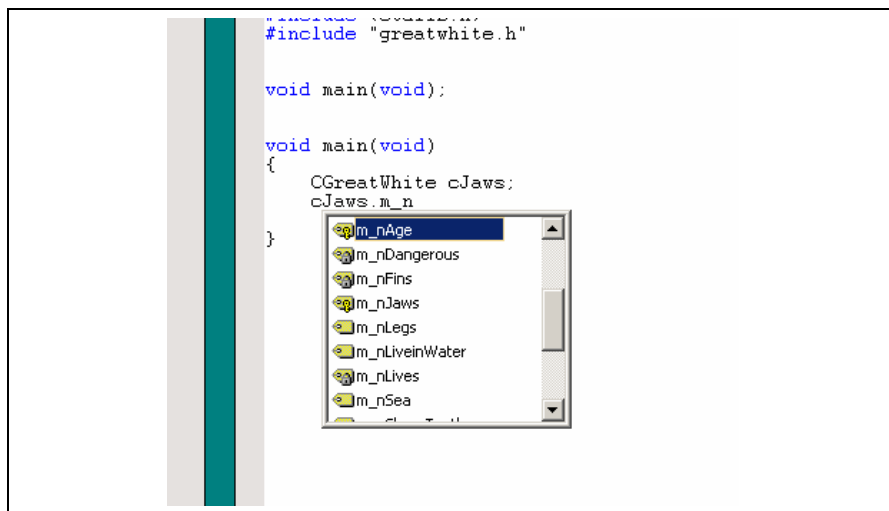

Figure 14.2: Smart-edit member selection

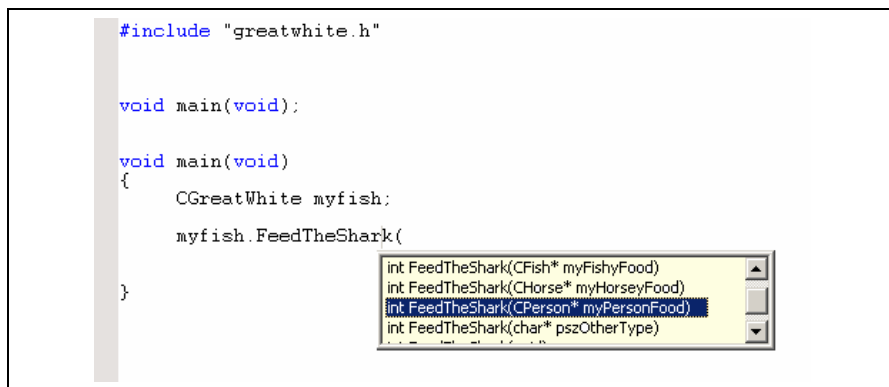

Figure 14.3: Smart -edit function selection

Note: Smart-edit auto completion may not pop-up for a variety of reasons. HEW can only provide help when the file has been scanned by the navigation component. For this to work the file must have been saved.

Another issue is that #defines are not considered so this means that redundant areas of code may still be visible.

Another important consideration is if the syntax of your code is incorrect the smart editor may not be able to parse your code correctly and the smart edit functionality will fail. In this case no pop-up will be displayed.

Please note that Smart-edit does not support macro usage.

Emulator Debugger Part

Section 1 Overview

1.1 Features

- The breakpoint, memory map, performance, and trace can be set through the dialog box.
 - Intuitive user interface
 - Online help
 - Common display and operability
- Supported host interfaces
The PCI interface, PC card (PCMCIA) interface, USB interface, or LAN interface can be used for connecting to the host computer.
- Realtime emulation
Realtime emulation of the user system is enabled at the maximum operating frequency of the CPU.
- Excellent operability
Using the HEW enables user program debugging using a pointing device such as a mouse. The HEW enables high-speed downloading of load module files.
- Various debugging functions
Various break and trace functions enable efficient debugging. Breakpoints and break conditions can be set by the specific window, trace information can be displayed on a window, and command-line functions can be used.
- Memory access during emulation
During emulation, the memory contents can be read and modified.

1.2 Warnings

CAUTION

READ the following warnings before using the emulator product. Incorrect operation will damage the user system and the emulator product. The USER PROGRAM will be LOST.

1. Check all components against the component list after unpacking the emulator.
2. Never place heavy objects on the casing.
3. Do not place the emulator in places where:
 - The temperature becomes high such as in direct sunlight or near a heater. For details, refer to section 1.3, Environmental Conditions.
 - The temperature or humidity changes greatly.
 - There is a lot of dust.
 - There is a lot of vibration. For details, refer to section 1.3, Environmental Conditions.
4. Protect the emulator from excessive impacts and stresses.
5. Only supply the specified voltage and power-supply frequency.
6. When moving the emulator, take care not to vibrate or damage it.
7. After connecting the cable, check that it is connected correctly. For details, refer to section 2, Preparation before Use. Supply power to the connected equipment after connecting all cables. For the supplying procedures, refer to section 2.7, System Check. Cables must not be connected or disconnected while the power is on.

1.3 Environmental Conditions

CAUTION

Observe the conditions listed in table 1.1 when using the emulator. Failure to do so will cause illegal operation in the user system, the emulator product, and the user program.

Table 1.1 Environmental Conditions

Item	Specifications
Temperature	Operating: +10°C to +35°C Storage: -10°C to +50°C
Humidity	Operating: 35% RH to 80% RH, no condensation Storage: 35% RH to 80% RH, no condensation
Vibration	Operating: 2.45 m/s ² max. Storage: 4.9 m/s ² max. Transportation: 14.7 m/s ² max.
Ambient gases	No corrosive gases may be present

1.4 Emulator External Dimensions and Mass

Table 1.2 Emulator External Dimensions and Mass

Item	Specifications
Dimensions	219 × 170 × 54 mm
Mass	Approximately 900 g

Section 2 Preparation before Use

2.1 Emulator Preparation

Unpack the emulator and prepare it for use as follows:

 **WARNING**

READ the reference sections shaded in figure 2.1 before using the emulator product. Incorrect operation will damage the user system and the emulator product. The USER PROGRAM will be LOST.

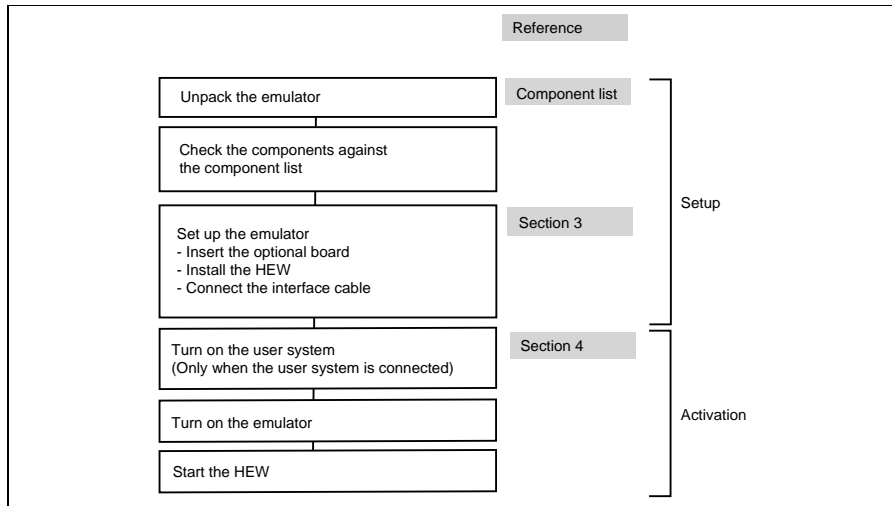

Figure 2.1 Emulator Preparation Flowchart

2.2 Installing Emulator's Software

To install the HEW, refer to the Setup Guide for the E6000 Emulator supplied together with the emulator.

2.3 Connecting to the User System

This E6000 emulator package includes a user system interface cable dedicated for use with the IC card reader. The head of the user system interface cable has the same shape as the IC card, and therefore, the emulator can be easily connected to the IC card reader on the user system by inserting the cable head into the IC card reader. To connect the emulator to the user system, proceed as follows:

- After checking that the emulator power is off, plug the user system interface cable body into the emulator.
- Insert the user system interface cable head into the IC card reader on the user system.
- Turn on and initiate the emulator.

Figure 2.2 gives details of the connectors provided on the emulator.

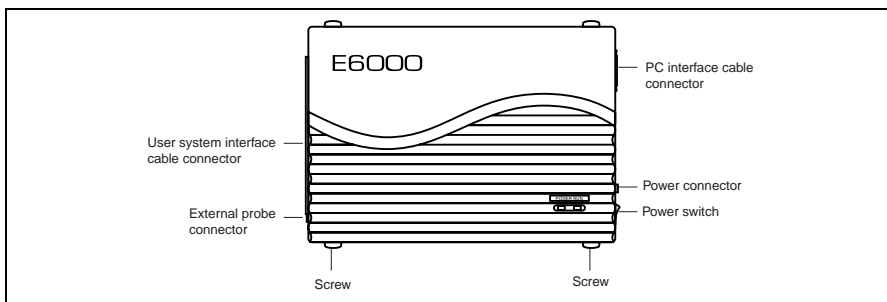

Figure 2.2 E6000 Emulator Connectors

2.3.1 Connecting the User System Interface Cable Body to the Emulator

Plug the user system interface cable body into the emulator, taking care to insert it straight, and push it firmly into place.

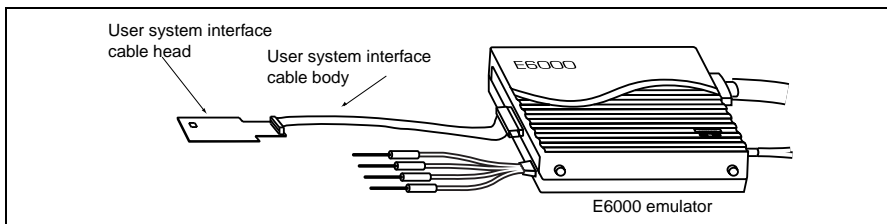

Figure 2.3 External View of the E6000 Emulator

2.3.2 Connecting the Use System Interface Cable Head

After initiating the E6000 emulator, insert the user system interface cable head into the IC card reader on the user system. Note the following when connecting.

- Check that the cable head is facing the right way towards the IC card reader slot.
- When the IC card reader automatically pulls or pushes an IC card into or out of the IC card slot, check the distance in which IC card moves, and place the E6000 emulator at an appropriate distance from the IC card reader.
- Dust or particles on the contact pads on the surface of the cable head will degrade the electrical connection between the cable head and the IC card reader, and the user system interface cable will not operate correctly. To prevent this, clean the contact pads with a dry cloth.

2.4 Power Supply

2.4.1 AC Adapter

The AC adapter supplied with the emulator must be used at all times.

2.4.2 Polarity

Figure 2.4 shows the polarity of the power-supply plug.

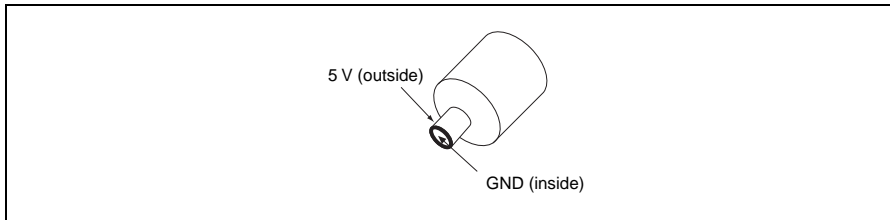

Figure 2.4 Polarity of Power Supply Plug

2.4.3 Power Supply Monitor Circuit

The emulator incorporates a power supply monitor circuit which only lights the green LED when a voltage higher than 4.75 V is supplied. If this LED is not illuminated, you should check the emulator voltage level. An input voltage less than 4.75 V could indicate that enough current cannot be supplied to the emulator.

Note: Use the AC adapter provided for the emulator.

2.5 Hardware Interface

All signals are directly connected to the MCU in the emulator with no buffering with the exception of those listed in section 7, Hardware Specifications Specific to This Product.

2.5.1 Signal Protection on the Emulator

All signals are over/under voltage protected by use of diode arrays. The only exceptions being the AV_{cc} and V_{ref} .

All ports have pull-up resistors except for analog port.

All V_{cc} pins on the cable head assembly are connected together (with the exception of the AV_{cc} pin), and are then monitored by the emulator to detect presence of the powered user system.

2.5.2 User System Interface Circuits

The interface circuit between the MCU in the emulator and the user system has a signal delay of about 8 ns due to the user system interface cable and it includes pull-up resistors. Therefore, high-impedance signals will be pulled up to the high level. When connecting the emulator to a user system, adjust the user system to compensate for propagation delays.

The following diagrams show the equivalent circuit examples of the interface signals. The interface circuits depend on the MCU type. For details, refer to section 7, Hardware Specifications Specific to This Product.

2.5.3 Clock Oscillator

The oscillator circuit has been implemented on the user system interface cable head. For details on the oscillator circuit, refer to the user's manual for each user system interface cable.

2.5.4 External Probe/Trigger Output

An 8-pin connector, marked EXT (on the right under the user system interface cable connector), on the emulator case accommodates four external probe inputs and two trigger outputs. The pin assignment of this connector is shown in figure 2.5.

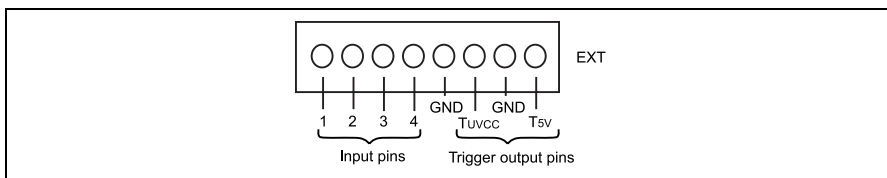

Figure 2.5 External Probe 1 Connector

The interface circuit for the external probe 1 is shown in figure 2.6.

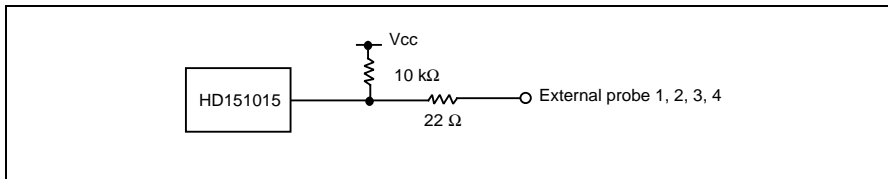

Figure 2.6 Interface Circuit for External Probe 1

The trigger output is controlled by event channel 8 and is an active low signal. The trigger output is available as either TSV (within the range from 2.5 V to 5 V; does not depend on the user V_{cc} level) or TU_{VCC} (the user V_{cc} level).

2.5.5 Power Supply Circuit

CAUTION

When the user system is connected to the E6000 emulator, start up the E6000 emulator and then turn on/off the user system. Failure to do so will result in a FIRE HAZARD and will damage the emulator product and the host computer.

The MCU in the E6000 emulator always operates at 5-V E6000 emulator power supply. This means that no power is taken from the user system. The circuit interfacing the MCU and the user system includes a voltage level shifter to support operation at a low voltage. Therefore, note that even if the user system operates at a voltage lower than 3 V, the MCU in the emulator can operate at the maximum operating frequency.

You can set a user V_{cc} threshold in the range V_{cc} max. – 0 V in the [Configuration] dialog box. If the user V_{cc} drops below this threshold, [User System Voltage] in the [Extended Monitor] window will display Down. Otherwise, OK is displayed. When user system interface cable is not connected, this function does not work.

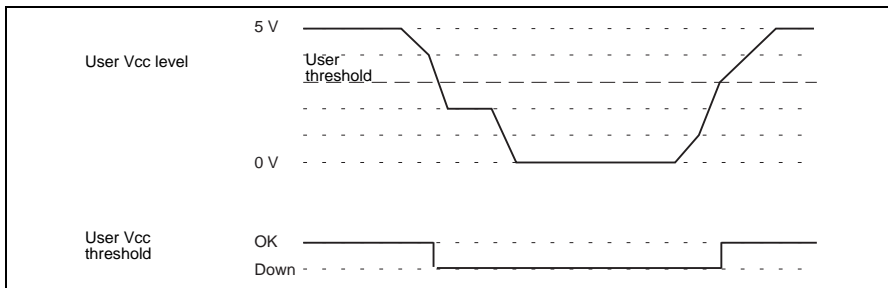

Figure 2.7 Relationship of Vcc between the User System and E6000 Emulator

2.6 System Check

When the software is executed, use the procedure below to check that the emulator is connected correctly. Here, use the workspace for a tutorial provided on the product.

Refer to section 2.8, Other Methods for Activating the Emulator, for the other activating method to create a new project or use a workspace for the HEW of the old version.

1. Connect the emulator to the host computer.
2. Connect the user system interface cable to the connector of the emulator.
3. Turn on the emulator.
4. Activate the HEW from the [Programs] in the [Start] menu (figure 2.8).

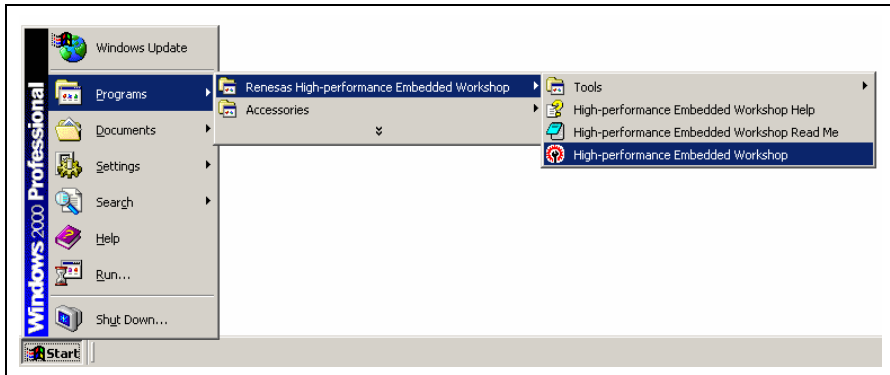

Figure 2.8 [Start] Menu

Note: If 'LAN Driver' is not selected at installation, [Tools] is not displayed.

5. The [Welcome!] dialog box is displayed.

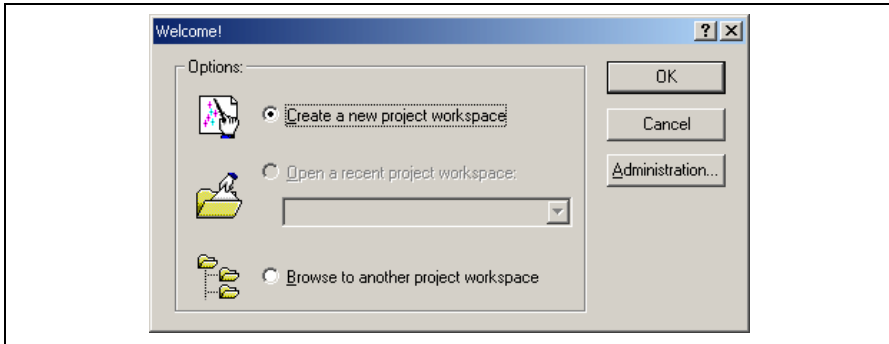

Figure 2.9 [Welcome!] Dialog Box

To use a workspace for the tutorial, select the [Browse to another project workspace] radio button and click the [OK] button.

When the [Open Workspace] dialog box is opened, specify the following directory:
HEW installation destination directory\Tools\Renesas\DebugComp\Platform\E6000\xxxx\Tutorial

After the directory has been specified, select the following file and click the [Open] button.

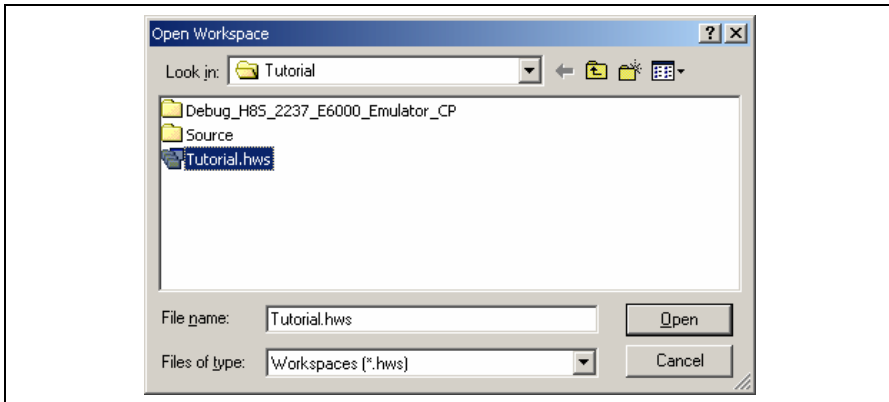

Figure 2.10 [Open Workspace] Dialog Box

When no compiler package or that of a different version is installed, the following message box will be displayed.



Figure 2.11 Message Box

6. The [E6000 Driver Details] dialog box is displayed. This dialog box is only displayed at the first initiation. When only one of interface drivers is selected, this dialog box is not displayed.

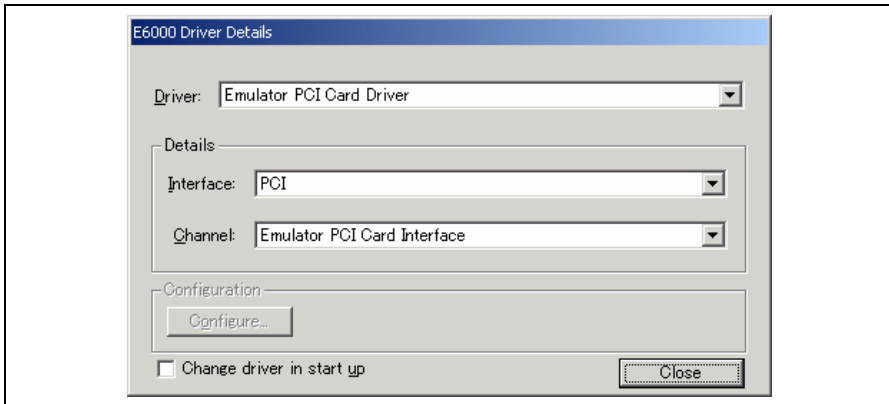

Figure 2.12 [E6000 Driver Details] Dialog Box

- In the [Driver] combo box, select the driver to connect the emulator.
- [Interface] displays the name of the interface to be connected.
- Click the [Close] button.

7. Set up the emulator. During this process, the following dialog box is displayed.



Figure 2.13 [Connecting] Dialog Box

8. When "Connected" is displayed in the [Output] window of the HEW, the emulator initiation is completed.

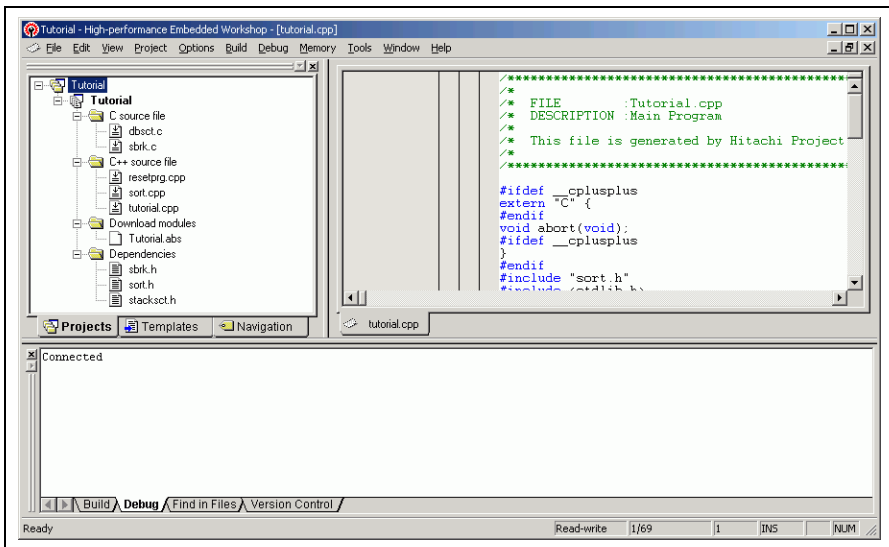

Figure 2.14 HEW Window

2.7 Communication Problems

The following message box will be displayed when the emulator power is turned off or the PC interface cable is not correctly connected.

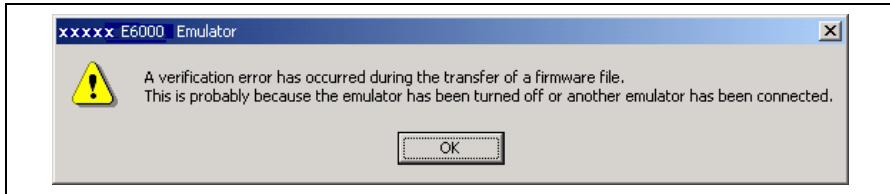

Figure 2.15 Error Message

For information on other errors, refer to the Setup Guide for the E6000 Emulator.

2.8 Other Methods for Activating the Emulator

Refer to section 4, Preparation before Use.

2.9 Uninstalling the Emulator's Software

For details on uninstallation, refer to the Setup Guide for the E6000 Emulator.

Section 3 E6000 Emulator Functions

3.1 Debugging Features

3.1.1 Breakpoints

The emulator provides a comprehensive range of alternative types of breakpoints, to give you the maximum flexibility in debugging applications and user system.

Hardware Break Conditions: Up to 12 break conditions can be defined using the event and range channels in the complex event system (CES). For more information about the hardware break conditions, see section 3.2, Complex Event System (CES).

Program Breakpoints (PC Breakpoints): Up to 256 program breakpoints can be defined. These program breakpoints are set by replacing the user instruction with a BREAK instruction.

3.1.2 Trace

The emulator incorporates a powerful realtime trace facility which allows you to examine MCU activity in detail. The realtime trace buffer holds up to 32768 bus cycles, and it is continuously updated during execution. The buffer is configured as a rolling buffer, which can be stopped during execution and read back by the host computer without halting emulation.

The data stored in the trace buffer is displayed in both source program and assembly languages for ease of debugging. However, if trace filtering is used, only assembly language can be displayed.

The buffer can be set up to store all bus cycles or just selected cycles. This is called trace acquisition and uses the complex event system (CES) to select the parts of the program you are interested in.

It is also possible to store all bus cycles and then just look at selected cycles. This is called trace filtering.

3.1.3 Execution Time Measurements

The emulator allows you to measure the total execution time, or to measure the time of execution between specified events in the complex event system. You can set the resolution of the timer to any of the following values:

20 ns, 125 ns, 250 ns, 500 ns, 1 μ s, 2 μ s, 4 μ s, 8 μ s, or 16 μ s.

At 20 ns the maximum time that can be measured is about six hours, and at 16 μ s the maximum time is about 200 days.

3.1.4 Performance Analysis

The emulator provides functions for measuring the performance of a program. The performance of the specified program range can be displayed either as a histogram or in percentage form. A timer resolution of 20 ns, 40 ns, or 160 ns can be selected. In addition, the execution count of the specified program range can be measured (1 to 65535).

3.1.5 Bus Monitoring

The emulator incorporates a bus monitoring function that monitors and displays the contents of the accessed area in HEW windows without stopping the program execution. Up to eight blocks of 256 bytes can be monitored. In addition, the emulator can output trigger signals from external probe 2 (EXT2) when specified addresses (four points max.) are accessed. Note that, however, some products do not support the bus monitoring function.

3.1.6 Coverage

The emulator provides a coverage function. The coverage function executes programs and obtains and stores histories of data access. This function allows you to know what part of your program has been or has not been tested.

3.2 Complex Event System (CES)

In most practical debugging applications, the program or hardware errors that you are trying to debug occur under a certain restricted set of circumstances. For example, a hardware error may only occur after a specific area of memory has been accessed. Tracking down such problems using simple PC breakpoints can be very time-consuming.

The emulator provides a very sophisticated system for giving a precise description of the conditions you want to examine, called the complex event system. This allows you to define events which depend on the state of a specified combination of the MCU signals.

The complex event system provides a unified way of controlling the trace, break, and timing functions of the emulator.

3.2.1 Event Channels

The event channels allow you to detect when a specified event has occurred. The event can be defined as a combination of one or more of the followings:

- Address or address range
- Address outside range
- Read or Write or either
- Data, with an optional mask
- MCU access type (e.g., instruction prefetch)
- MCU access area (e.g., on-chip ROM and on-chip RAM)
- A signal state on one or more of the four external probes
- A certain number of times that the event must be triggered
- Delay cycles after an event

Up to eight events can be combined into a sequence, in which each event is either activated or deactivated by the occurrence of the previous event in the sequence. For example, you can cause a break if an I/O register is written to after a specified area of RAM has been accessed.

3.2.2 Range Channels

The range channels can be set up to be triggered on a combination of one or more of the following:

- Address or address range (inside the range)
- Read or Write or either
- Data, with an optional mask
- MCU access type (e.g., instruction prefetch)
- MCU access area (e.g., on-chip ROM and on-chip RAM)
- A signal state on one or more of the four external probes
- Delay cycles after an event

The complex event system can be used to control the following functions of the emulator:

3.2.3 Breaks

Use breaks to interrupt program execution when a specified event, or sequence of events, is activated. For example, you can set up a break to halt execution when the program reads from one address, and then writes to another address. The break can also optionally be delayed by up to 65535 bus cycles.

3.2.4 Timing

You can set up two events and then measure the execution time of the program between the activation of the first event and second event.

3.3 Hardware Features

3.3.1 Memory

The emulator provides standard emulation memory as the substitute for on-chip ROM memory and on-chip RAM memory. When the on-chip ROM or RAM memory capacity is insufficient during user program development, this emulation memory can be used instead. However, at the final stage of the development, do not use this emulation memory and verify that the user program correctly operates within the on-chip ROM and RAM.

The definition of each type of memory is as follows:

Table 3.1 Memory Types

Memory Type	Description
On-chip	Uses the MCU on-chip memory.
User	Accesses the user system memory.
Emulator	Accesses the emulation memory.

Note: "User" can not be set on this emulator.

The contents of a specified block of memory can be displayed using the memory function. The contents of memory can be modified at any time, even during program execution, and the results are immediately reflected in all other appropriate windows.

3.3.2 Clocks

The clock can be specified as emulator internal clock or target clock. The frequencies that can be specified as the emulator internal clock depend on the MCU. For details, refer to section 8, Software Specifications Specific to This Product.

3.3.3 Probes

External probes can be connected to the emulator, to make use of signals on the user system for break or trace. The signal for external probe can be set as the condition for the event detection system depending on the low or high level.

3.4 Stack Trace Function

The emulator uses the stack's information to display the name of the calling function for a function at which the program counter is currently pointing. This function can be used only when the load module that has the Dwarf2-type debugging information is loaded. For the usage of this function, refer to section 6.17, Stack Trace Function.

3.5 Online Help

An online help explains the usage of each function or the command syntax that can be entered from the command line window.

Select [Emulator Help] from the [Help] menu to view the emulator help.

Section 4 Preparation before Use

4.1 Workspaces, Projects, and Files

Just as a word processor allows you to create and modify documents, HEW allows you to create and modify workspaces. A workspace can be thought of as a container of projects and, similarly, a project can be thought of as a container of project files. Thus, each workspace contains one or more projects and each project contains one or more files. Figure 4.1 illustrates this graphically.

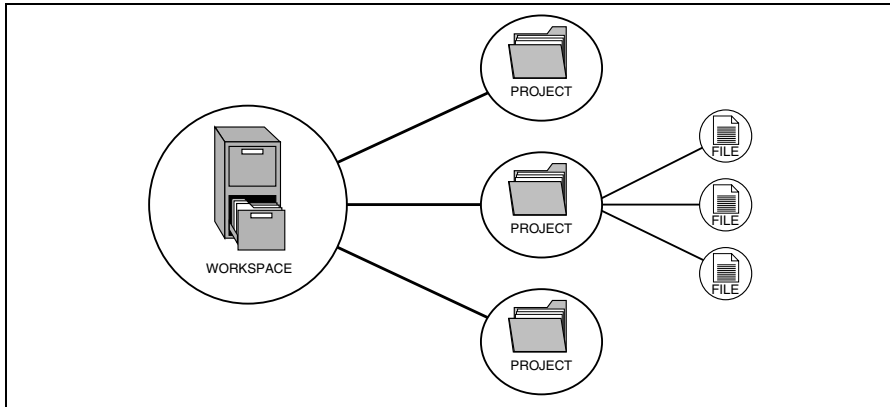

Figure 4.1 Workspaces, Projects, and Files

Workspaces allow you to group related projects together. For example, you may have an application that needs to be built for different processors or you may be developing an application and library at the same time. Projects can also be linked hierarchically within a workspace, which means that when one project is built all of its “child” projects are built first.

However, workspaces on their own are not very useful, we need to add a project to a workspace and then add files to that project before we can actually do anything.

4.2 Method for Activating HEW

To activate the HEW, follow the procedure listed below.

1. Connect the emulator to the host computer.
2. Connect the user system interface cable to the connector of the emulator if you use the user system interface cable. This is not necessary when you do not use the user system interface cable.
3. Turn on the emulator. Be sure to turn on the user system before supplying power to the emulator if you use the user system.
4. Activate the HEW from [Programs] in the [Start] menu.
5. The [Welcome!] dialog box is displayed.

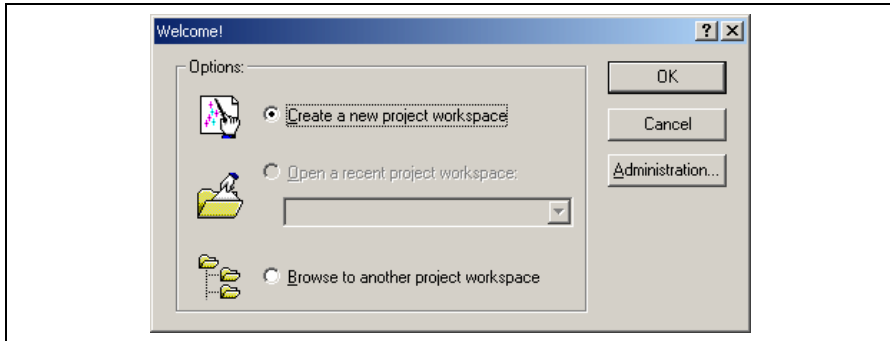

Figure 4.2 [Welcome!] Dialog Box

[Create a new project workspace] radio button: Creates a new workspace.

[Open a recent project workspace] radio button: Uses the current workspace and displays the history of the opened workspace.

[Browse to another project workspace] radio button: Uses the current workspace; this radio button is used when the history of the opened workspace does not remain.

In this section, we describe the following three ways to start up the HEW:

- [Create a new project workspace] - a toolchain is not in use
- [Create a new project workspace] - a toolchain is in use
- [Browse to another project workspace]

The method to create a new workspace depends on whether a toolchain is or is not in use. Note that this emulator product does not include a toolchain. Use of a toolchain is available in an environment where the H8S, H8/300 series C/C++ compiler package has been installed. For details on this, refer to the manual attached to the H8S, H8/300 series C/C++ compiler package.

4.2.1 Creating a New Workspace (Toolchain Not Used)

1. In the [Welcome!] dialog box that is displayed when the HEW is activated, select [Create a new project workspace] radio button and click the [OK] button.

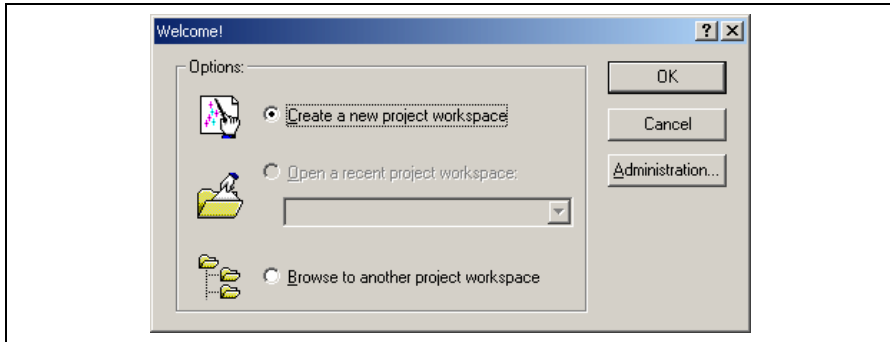

Figure 4.3 [Welcome!] Dialog Box

2. Creation of a new workspace is started. The following dialog box is displayed.

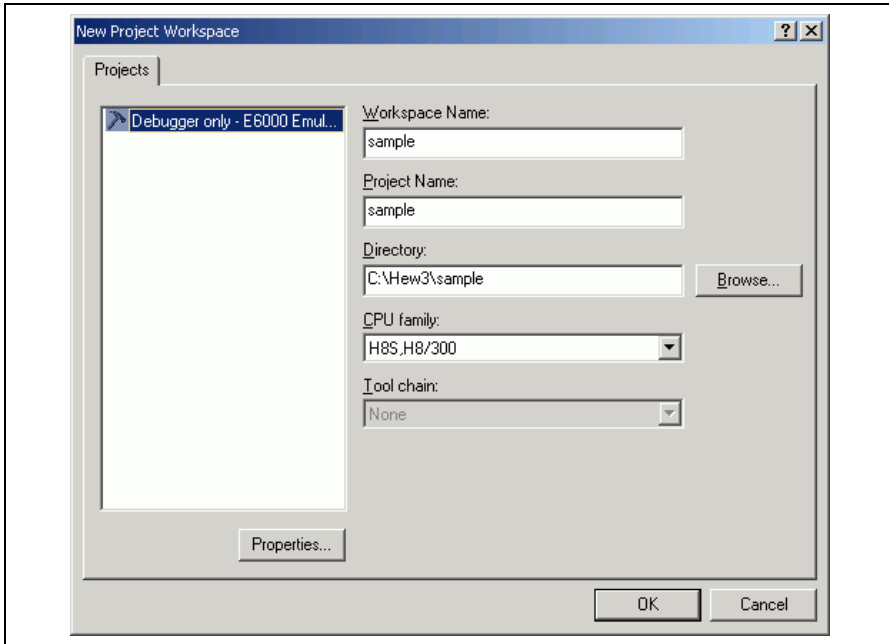

Figure 4.4 [New Project Workspace] Dialog Box

[Workspace Name] edit box: Enter the new workspace name.

[Project Name] edit box: Enter the project name. When the project name is the same as the workspace name, it needs not be entered.

[Directory] edit box: Displays the directory in which the workspace will be created. Click the [Browse...] button to select a directory name or enter a directory name in the [Directory] edit box.

Other list boxes are used for setting the toolchain; the fixed information is displayed when the toolchain has not been installed.

3. Make the required setting for the toolchain. When the setting has been completed, the following dialog box is displayed.

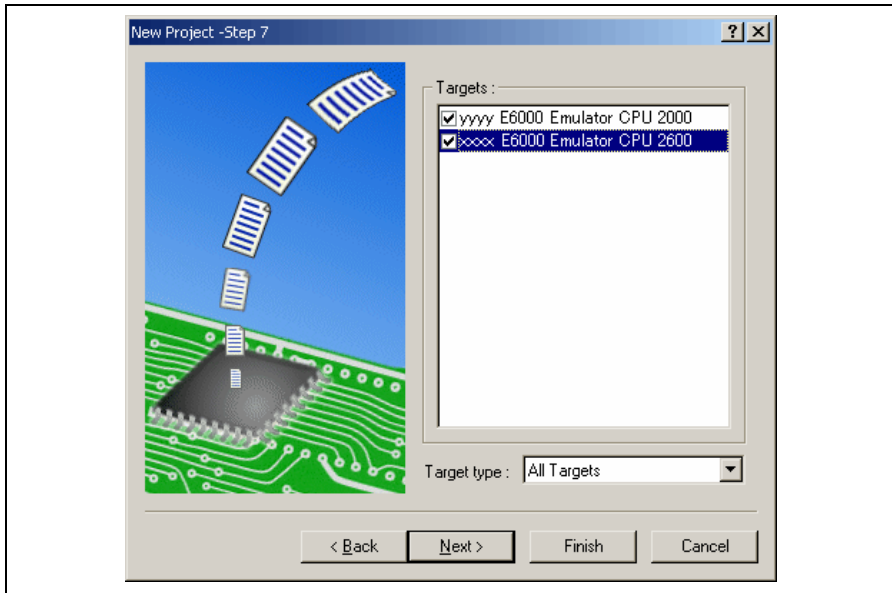

Figure 4.5 [New Project – Step 7] Dialog Box

The target for the session file used when the HEW is activated must be selected here. Check the box against the target platform and then click the [Next] button. For details on the session file, refer to section 4.4, Debugger Sessions.

4. Set the configuration file name. The configuration file saves the state of HEW except for the emulator.

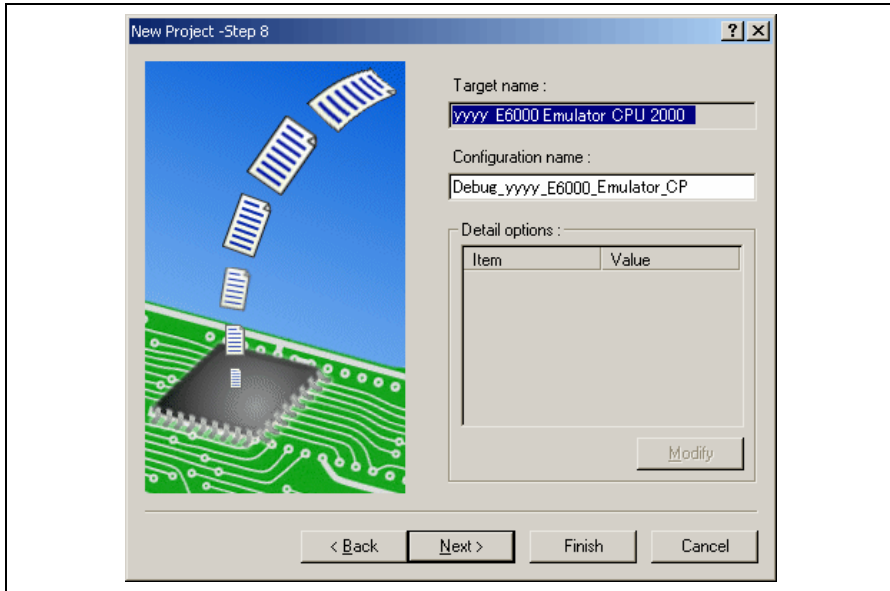

Figure 4.6 [New Project – Step 8] Dialog Box

If multiple target platforms were selected in the [New Project – Step 7] dialog box shown in figure 4.5, set the name of a configuration file for each of them, each time pressing the [Next] button to proceed to the next target.

Setting of the configuration file name is the end of the emulator settings.

Click the [Finish] button to display the [Summary] dialog box. Pressing the [OK] button activates the HEW.

5. After the HEW has been activated, the emulator is automatically connected. The message “Connected” is displayed on the [Debug] tab in the [Output] window to indicate the completion of connection.

4.2.2 Creating a New Workspace (Toolchain Used)

1. In the [Welcome!] dialog box that is displayed when the HEW is activated, select [Create a new project workspace] radio button and click the [OK] button.

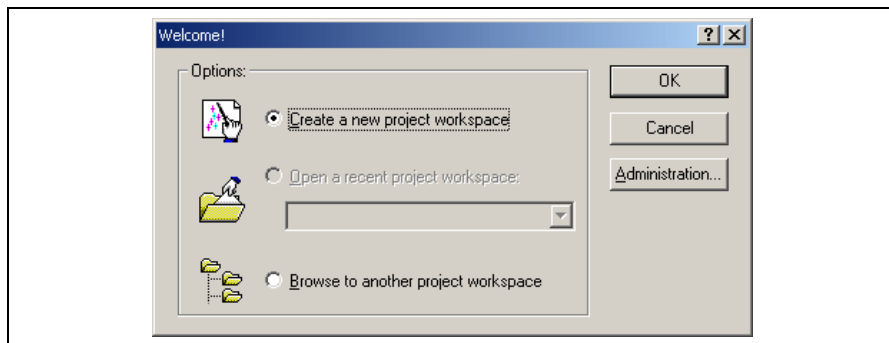

Figure 4.7 [Welcome!] Dialog Box

2. Creation of a new workspace is started. The following dialog box is displayed.

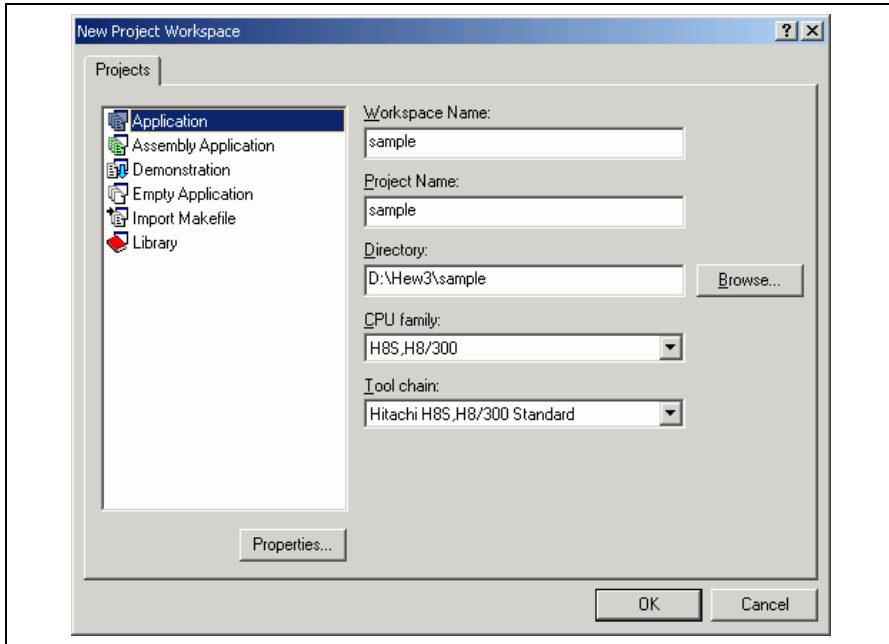

Figure 4.8 [New Project Workspace] Dialog Box

[Workspace Name] edit box: Enter the new workspace name. Here, enter 'test'.

[Project Name] edit box: Enter the project name. When the project name is the same as the workspace name, it needs not be entered.

[Directory] edit box: Displays the directory in which a workspace will be created. Click the [Browse...] button to select a directory or enter the name of a directory in the [Directory] edit box.

[CPU family] combo box: Select the target CPU family.

[Tool chain] combo box: Select the target toolchain name when using the toolchain. Otherwise, select [None].

[Project type] list box: Select the project type to be used.

Notes: 1. When [Demonstration] is selected in the emulator, note the followings:

The [Demonstration] is a program for the simulator attached to the H8S, H8/300 compiler package. To use the generated source file, delete the Printf statement in the source file.

3. Make the required setting for the toolchain. When the setting has been completed, the following dialog box is displayed.

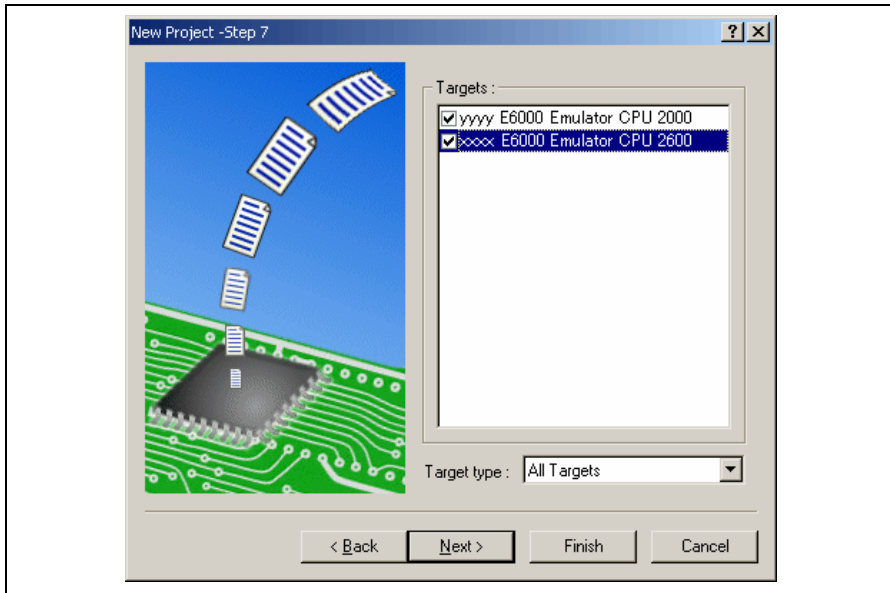

Figure 4.9 [New Project – Step 7] Dialog Box

The target for the session file used when the HEW is activated must be selected here. Check the box against the target platform and then click the [Next] button. For details on the session file, refer to section 4.4, Debugger Sessions.

4. Set the configuration file name. The configuration file saves the state of HEW except for the emulator.

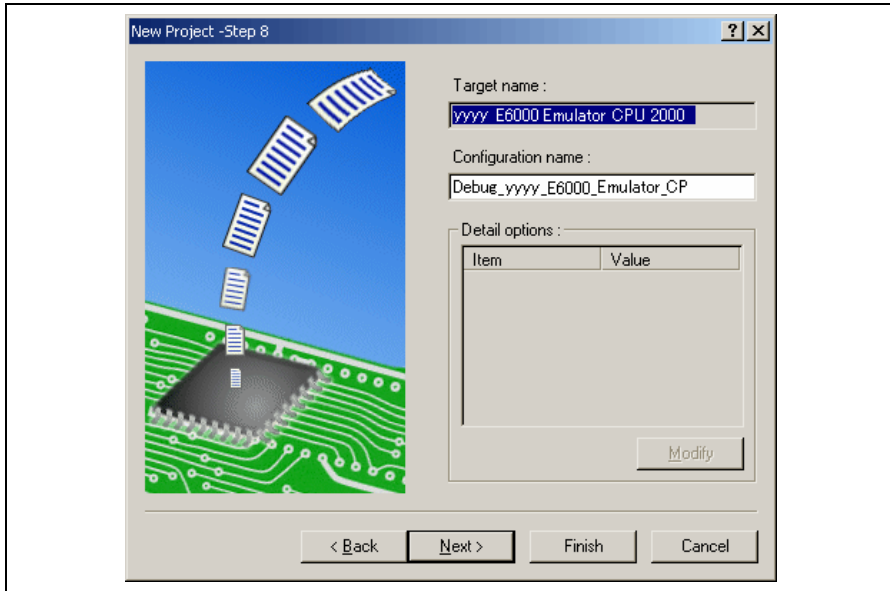

Figure 4.10 [New Project – Step 8] Dialog Box

If multiple target platforms were selected in the [New Project – Step 7] dialog box shown in figure 4.9, set the name of a configuration file for each of them, each time pressing the [Next] button to proceed to the next target.

Setting of the configuration file name is the end of the emulator settings.

Complete the creation of a new workspace according to the instructions on the screen. This activates the HEW.

5. After the HEW has been activated, connect the emulator. However, it is not necessary to connect the emulator immediately after the HEW has been activated.
Select either of the following two ways to connect the emulator: connecting the emulator after the setting at emulator activation or without the setting at emulator activation. For details on the connection of the emulator, refer to section 4.5, Connecting the Emulator.

4.2.3 Selecting an Existing Workspace

1. In the [Welcome!] dialog box that is displayed when the HEW is activated, select [Browse to another project workspace] radio button and click the [OK] button.

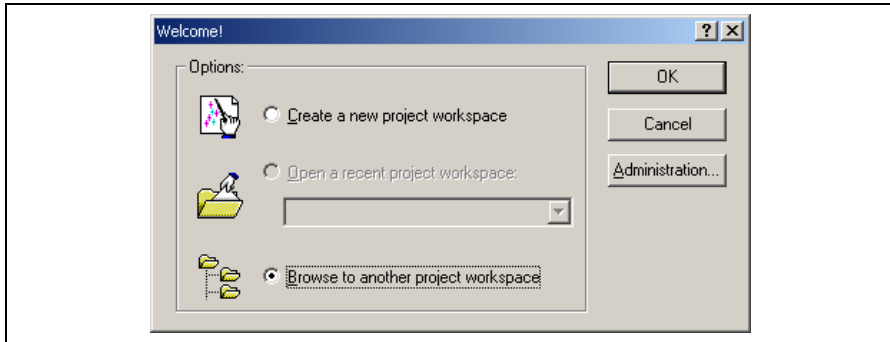

Figure 4.11 [Welcome!] Dialog Box

2. The [Open Workspace] dialog box is displayed. Select a directory in which you have created a workspace. After that, select the workspace file (.hws) and press the [Open] button.

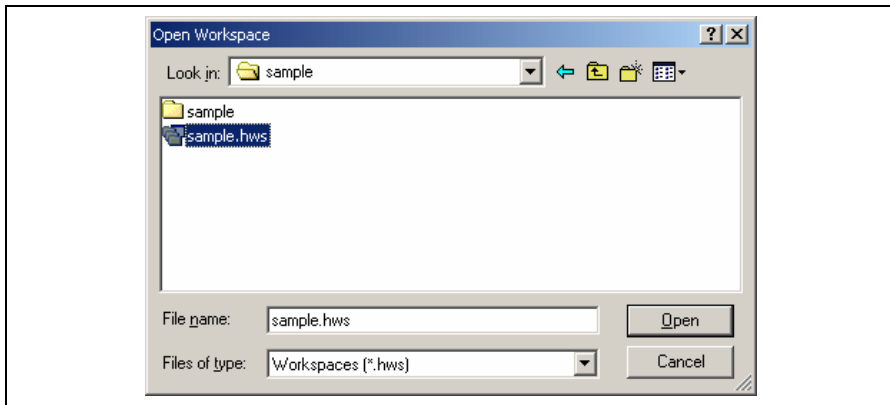

Figure 4.12 [Open Workspace] Dialog Box

3. This activates the HEW and recovers the state of the selected workspace at the time it was saved. When the saved state information of the selected workspace includes connection to the emulator, the emulator will automatically be connected. To connect the emulator when the saved state information does not include connection to the emulator, refer to section 4.5, Connecting the Emulator.

4.3 Setting at Emulator Activation

When the emulator is activated, the command chain can automatically be executed. It is also possible to register multiple load modules to be downloaded. The registered load modules are displayed on the workspace window.

1. Select [Debug settings] from the [Options] menu to open the [Debug Settings] dialog box.

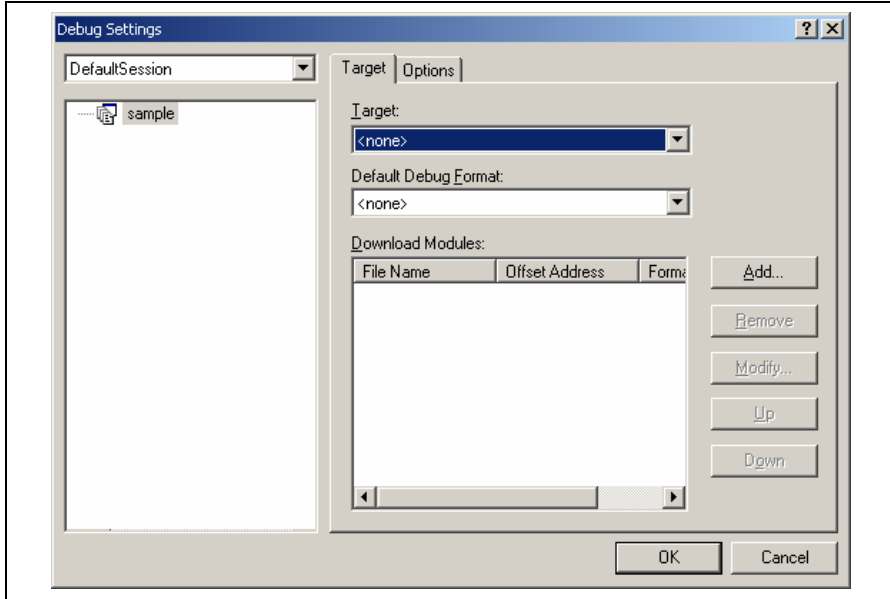

Figure 4.13 [Debug Settings] Dialog Box ([Target] Page)

2. Select the product name to be connected in the [Target] combo box.
3. Select the format of the load module to be downloaded in the [Default Debug Format] combo box, then register the corresponding download module in the [Download Modules] list box.
4. Click the [Options] tab.

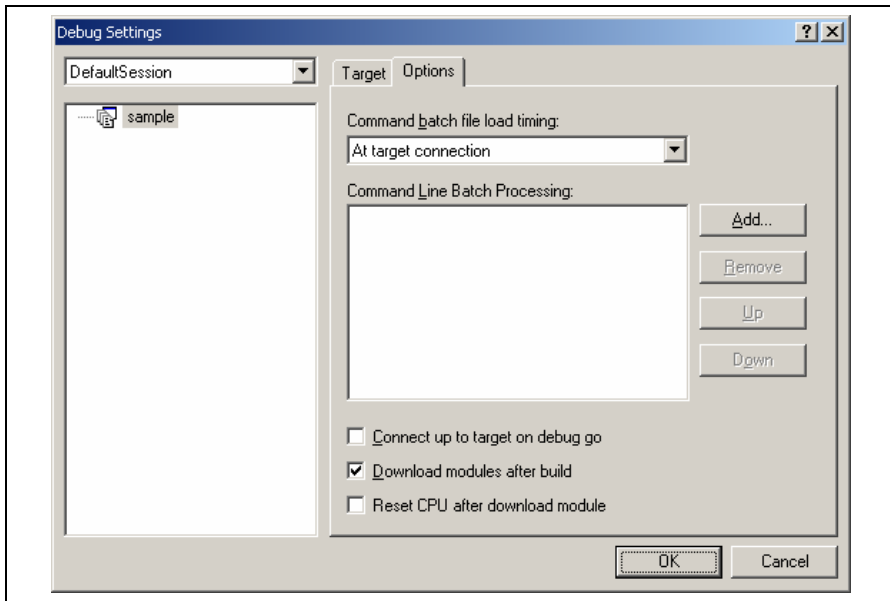

Figure 4.14 [Debug Settings] Dialog Box ([Options] Page)

The command chain that is automatically executed at the specified timing is registered. The following three timings are available:

- At connecting the emulator
- Immediately before downloading
- Immediately after downloading

Specify the timing for executing the command chain in the [Command batch file load timing] combo box. In addition, register the command-chain file that is executed at the specified timing in the [Command Line Batch Processing] list box.

4.4 Debugger Sessions

The HEW stores all of your builder options into a configuration. In a similar way, the HEW stores your debugger options in a session. The debugging platforms, the programs to be downloaded, and each target platform's options can be stored in a session.

Sessions are not directly related to a configuration. This means that multiple sessions can share the same download module and avoid unnecessary program rebuilds.

Each session's data should be stored in a separate file in the HEW project. Debugger sessions are described in detail below.

4.4.1 Selecting a Session

The current session can be selected in the following two ways:

- From the toolbar
Select a session from the combo box (figure 4.15) in the toolbar.



Figure 4.15 Toolbar Selection

- From the dialog box
 1. Select [Options -> Debug Sessions...]. This will open the [Debug Sessions] dialog box (figure 4.16).

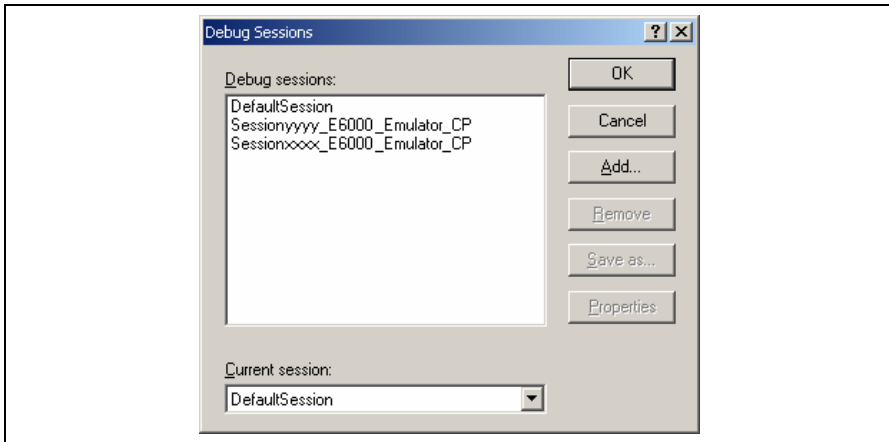

Figure 4.16 [Debug Sessions] Dialog Box

2. Select the session you want to use from the [Current session] combo box.
3. Click the [OK] button to set the session.

4.4.2 Adding and Deleting Sessions

A new session can be added by copying settings from another session or deleting a session.

- To add a new empty session
 1. Select [Options -> Debug Sessions...] to display the [Debug Sessions] dialog box (figure 4.16).
 2. Click the [Add...] button to display the [Add new session] dialog box (figure 4.17).
 3. Check the [Add new session] radio button.
 4. Enter a name for the session.
 5. Click the [OK] button to close the [Debug Sessions] dialog box.
 6. This creates a file with the same name as the entered session name. If the file name already exists, an error is displayed.

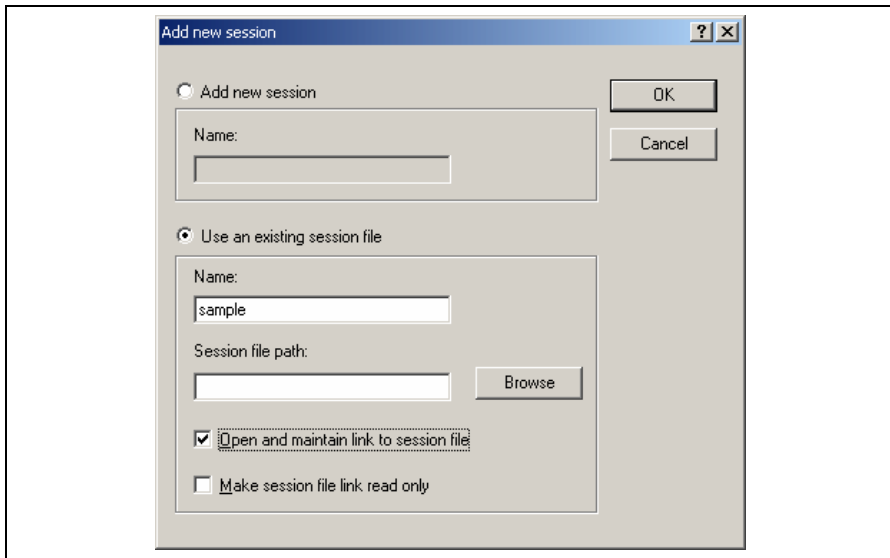

Figure 4.17 [Add new session] Dialog Box

- To import an existing session into a new session file
 1. Select [Options -> Debug Sessions...] to display the [Debug Sessions] dialog box (figure 4.16).
 2. Click the [Add...] button to display the [Add new session] dialog box (figure 4.17).
 3. Check the [Use an existing session file] radio button.
 4. Enter a name for the session.
 5. Browse to the existing session file location that you would like to import into the current project.

If the [Open and maintain link to session file] check box is not checked, the imported new session file is generated in the project directory.

If the [Open and maintain link to session file] check box is checked, a new session file is not generated in the project directory but is linked to the current session file.

If the [Make session file link read only] check box is checked, the linked session file is used as read-only.
 6. Click the [OK] button to close the [Debug Sessions] dialog box.
- To remove a session
 1. Select [Options -> Debug Sessions...] to display the [Debug Sessions] dialog box (figure 4.16).
 2. Select the session you would like to remove.
 3. Click the [Remove] button.

Note that the current session cannot be removed.
 4. Click the [OK] button to close the [Debug Sessions] dialog box.
- To view the session properties
 1. Select [Options -> Debug Sessions...] to display the [Debug Sessions] dialog box (figure 4.16).
 2. Select the session you would like to view the properties for.
 3. Click the [Properties] button to display the [Session Properties] dialog box (figure 4.18).

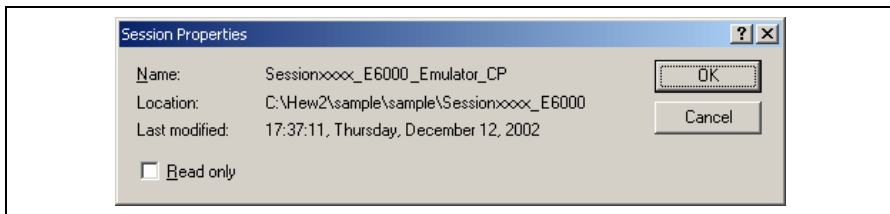

Figure 4.18 [Session Properties] Dialog Box

- To make a session read-only
 1. Select [Options -> Debug Sessions...] to display the [Debug Sessions] dialog box (figure 4.16).
 2. Select the session you would like to make read-only.
 3. Click the [Properties] button to display the [Session Properties] dialog box (figure 4.18).
 4. Check the [Read only] check box to make the link read-only. This is useful if you are sharing debugger-setting files and you do not want data to be modified accidentally.
 5. Click the [OK] button.
- To save a session with a different name
 1. Select [Options -> Debug Sessions...] to display the [Debug Sessions] dialog box (figure 4.16).
 2. Select the session you would like to save.
 3. Click the [Save as] button to display the [Save Session] dialog box (figure 4.19).
 4. Browse to the new file location.
 5. If you want to export the session file to another location, leave the [Maintain link] check box unchecked. If you would like the HEW to use this location instead of the current session location, check the [Maintain link] check box.
 6. Click the [OK] button.

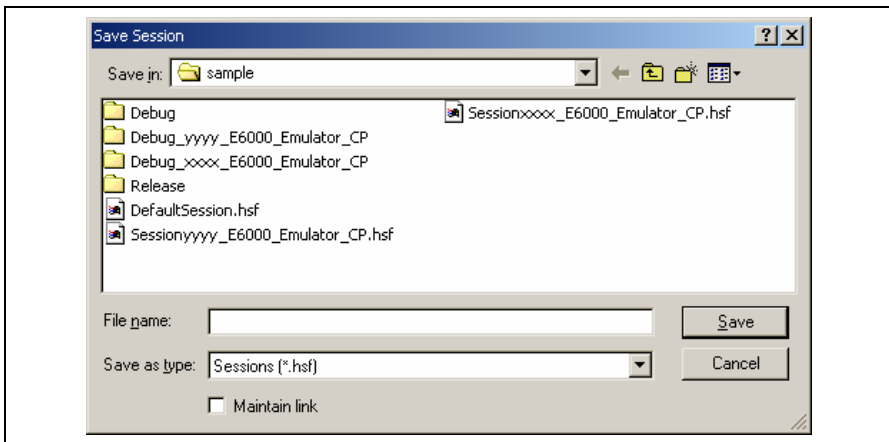

Figure 4.19 [Save Session] Dialog Box

4.4.3 Saving Session Information

- To save a session

Select [File -> Save Session].

4.5 Connecting the Emulator

Select either of the following two ways to connect the emulator:

(a) Connecting the emulator after the setting at emulator activation

Select [Options -> Debug settings...] to open the [Debug Settings] dialog box. It is possible to register the download module or the command chain that is automatically executed at activation. For details on the [Debug Settings] dialog box, refer to section 4.3, Setting at Emulator Activation.

When the dialog box is closed after setting the [Debug Settings] dialog box, the emulator will automatically be connected.

(b) Connecting the emulator without the setting at emulator activation

Connect the emulator by simply switching the session file to one in which the setting for the emulator use has been registered.

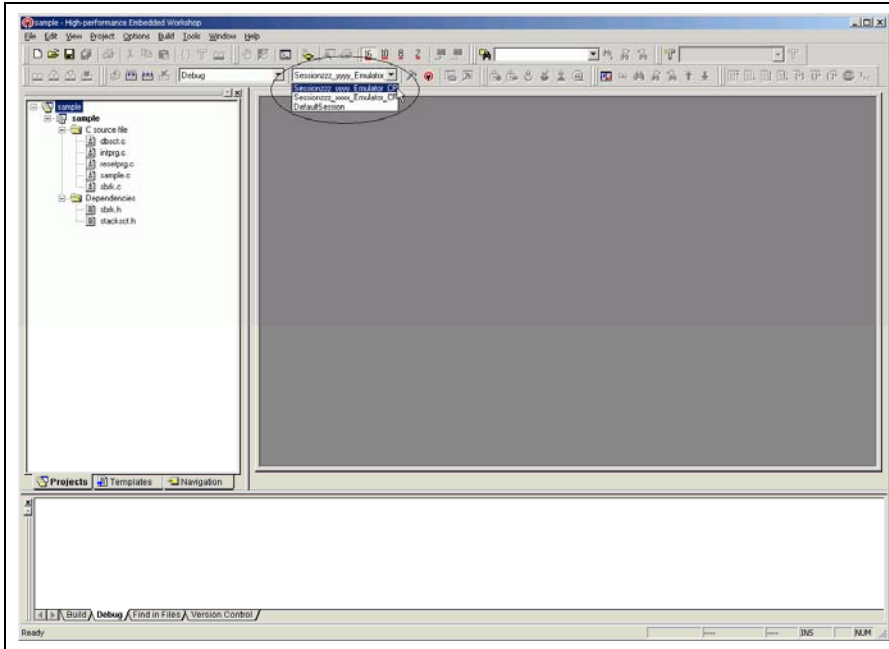

Figure 4.20 Selecting the Session File

In the list box that is circled in figure 4.20, select the session name including the character string that has been set in the [Target name] text box in figure 4.10, [New Project – Step 8] dialog box. The setting for using the emulator has been registered in this session file.

After the session name is selected, the emulator will automatically be connected. For details on the session file, refer to section 4.4, Debugger Sessions.

4.6 Reconnecting the Emulator

When the emulator is disconnected, use the following way for reconnection:

Select [Build -> Debug -> Connect] or click the [Connect] toolbar button (). The emulator is connected.

Note: Before reconnecting the emulator, a load module must be registered to the HEW. For registration, refer to section 4.3, Setting at Emulator Activation.

4.7 Ending the Emulator

When using the toolchain, the emulator can be exited by using the following two methods:

- Canceling the connection of the emulator being activated
- Exiting the HEW

(1) Canceling the connection of the emulator being activated

Select [Disconnect] from the [Debug] menu or click the [Disconnect] toolbar button ().

(2) Exiting the HEW

Select [Exit] from the [File] menu.

A message box is displayed. If necessary, click the [Yes] button to save a session. After saving a session, the HEW exits. If not necessary, click the [No] button to exit the HEW.

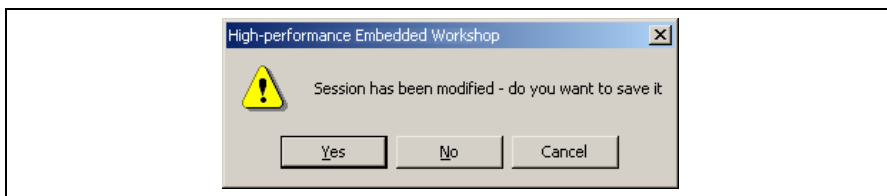



Figure 4.21 [Session has been modified] Message Box

Section 5 Debugging

This section describes the debugging operations and their related windows and dialog boxes.

5.1 Setting the Environment for Emulation

5.1.1 Opening the [Configuration Properties] Dialog Box

Selecting [Options -> Emulator -> System...] or clicking the [Emulator System] toolbar button () opens the [Configuration Properties] dialog box.

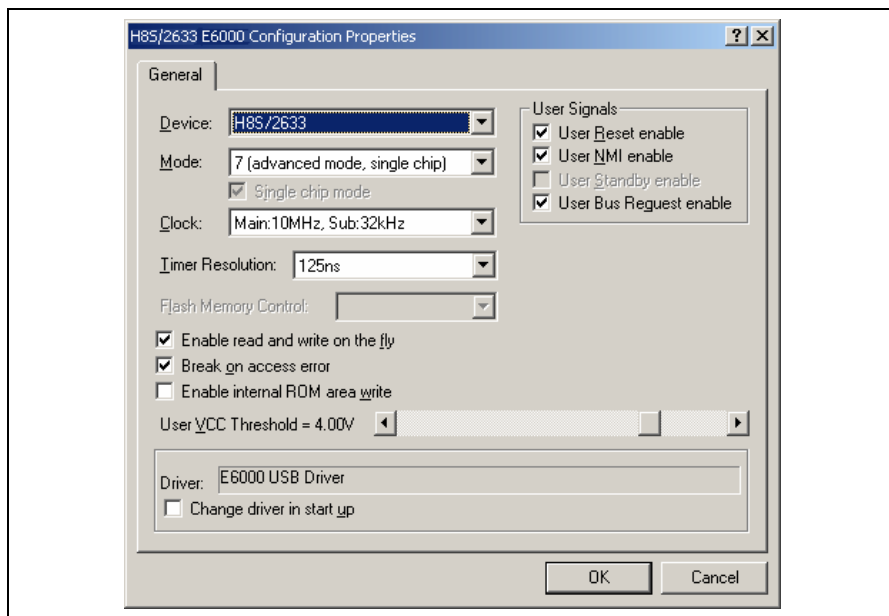

Figure 5.1 [Configuration Properties] Dialog Box ([General] Page)

This dialog allows the user to set conditions for the target MCU before downloading a program to the emulator.

[General] page

[Device]	Selects the MCU to be emulated. To use an MCU not included in the list, select CUSTOM to specify the functions required for this MCU. See the hardware manual for details.
[Mode]	Selects the MCU's operating mode.
[Clock]	Selects the speed of the MCU's clock and sub-clock.
[Timer Resolution]	Selects the resolution of the timer for use in execution time measurement. The value 20 ns, 125 ns, 250 ns, 500 ns, 1 us, 2 us, 4 us, 8 us, or 16 us can be selected. The timer for execution time measurement has a 40-bit counter. At 20 ns the maximum time that can be measured is about six hours, and at 16 μ s the maximum time is about 200 days. When the counter overflows, the maximum time possible for measurement will be displayed with prompt ">" that indicates that the counter has overflowed.
[Enable read and write on the fly]	When this box is checked, it is possible to access the target system memory while the user program is running. Do not check this check box if you require realtime emulation.
[Break on access error]	When this box is checked, a break (the user program stops) occurs if your program accesses a guarded memory area or writes to a write-protected area.
[Enable internal ROM area write]	When this box is checked, writing to the on-chip ROM area is enabled. For the result of writing, see the [Extended Monitor] window.
[User VCC Threshold]	Sets the voltage level for the user system.
[User Signals]	When this box is checked, the reset, NMI, standby, and bus request signals from the user system are enabled.
[Driver]	Displays the E6000 driver that is currently installed.
[Change driver in start up]	When this box is checked, selection of a driver will be available next time the emulator is connected.

Note: The items that can be set in this dialog box vary according to the emulator in use. For details, refer to section 8, Software Specifications Specific to This Product, or the online help.

5.1.2 Selecting an MCU Not Included in the List

Selecting [Custom] in [Device] of the [Configuration Properties] dialog box adds the [Custom Device] page to the dialog box.

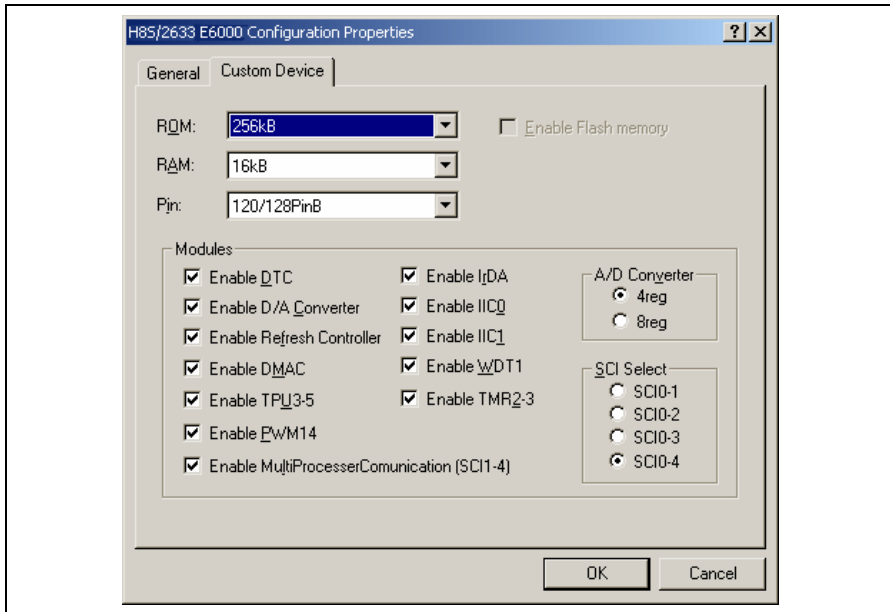

Figure 5.2 [Configuration Properties] Dialog Box ([Custom Device] Page)

Use this page to specify functions for an MCU not included in the list of MCUs. The items are adopted by the device last selected.

[Custom Device] page

[ROM]	Specify the on-chip ROM area size.
[RAM]	Specify the on-chip RAM area size.
[Pin]	Specify the product package.
[Modules]	Check this box to validate on-chip peripherals.

Note: The items that can be set in this dialog box vary according to the emulator in use. Some emulators may not support the [Custom Device] function. For details, refer to section 8, Software Specifications Specific to This Product, or the online help.

5.1.3 Selecting the Interface to be Connected

Checking [Change driver in start up] on the [Configuration Properties] dialog box allows a selection of the driver next time the emulator is connected.

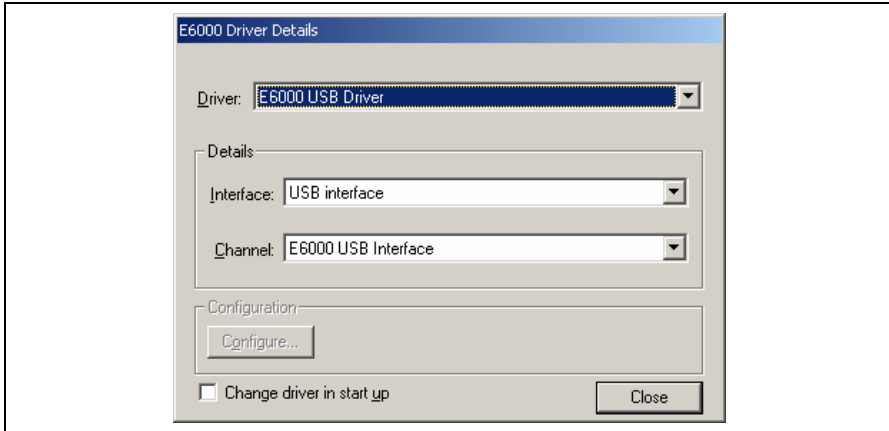

Figure 5.3 [Driver Details] Dialog Box

[Driver]: Selects the driver that connects the HEW and the emulator.

[Details]: Sets the details of the driver being connected.

[Interface]: The name of the interface to be connected. This should not be changed in this emulator.

[Channel]: Channel for the selected interface. This should not be changed in this emulator.

[Configuration]: Driver setting.

[Configure...]: A dialog box for setting will be displayed when the driver supports the configuration dialog. Note that this item is not available with this emulator.

[Change driver in start up]: Checking this box selects the driver when the emulator is connected the next time.

5.1.4 Opening the [Memory Mapping] Dialog Box

Selecting [Options -> Emulator -> Memory Resource...] or clicking the [Emulator Memory Resource] toolbar button () opens the [Memory Mapping] dialog box.

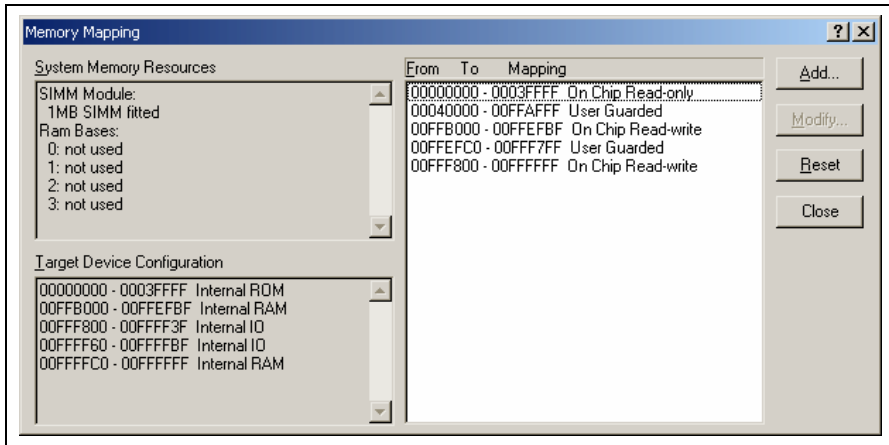

Figure 5.4 [Memory Mapping] Dialog Box

This dialog box displays the current memory map. The E6000 H8S supports four blocks of user memory. These can be 256 kbytes or 1 Mbyte each, depending on the SIMM fitted. Each block can be placed in the address space on a 256-kbyte or 1-Mbyte boundary.

The memory mapping has a granularity of H'40 (D'64) bytes. Each 64-byte block can be set to the internal (emulation) or external memory and can be guarded (access-prohibited), write-protected or read-write.

The H8/300 series E6000 generally incorporates an emulation memory.

In the memory map, the memory can be set as an internal (emulation) or external, guarded (access-prohibited), write-protected, or read/write in a byte unit.

[Add...]: Displays the [Edit Memory Mapping] dialog box, allowing the user to modify the address range and attributes of a memory map.

[Modify...]: Displays the [Edit Memory Mapping] dialog box, allowing the user to modify the address range and attributes of a memory map.

[Reset]: Resets the map memory to its default settings.

[Close]: Closes the dialog box.

The memory configuration of the device being emulated is displayed by the [Memory] sheet in the [Status] window.

Note: Some emulators may not support the emulation memory or the memory mapping function. For details, refer to section 8, Software Specifications Specific to This Product, or the online help.

5.1.5 Changing the Memory Map Setting

Clicking the [Add...] button on the [Memory Mapping] dialog box or clicking the [Modify...] button after selecting the information on the memory map setting you want to change opens the [Edit Memory Mapping] dialog box.

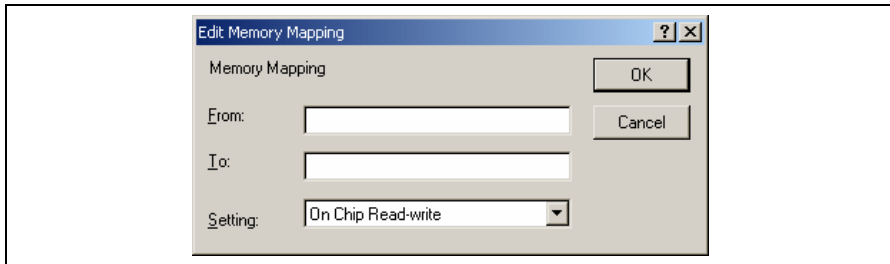

Figure 5.5 [Edit Memory Mapping] Dialog Box

Use this dialog box to change the address range and attributes of a memory map.

[From]: Enter the start address of the map range.

[To]: Enter the end address of the map range.

[Setting]: Enter the memory map setting.
The choices given are listed below. The User (external memory) and Emulator (emulation memory) attributes can be modified.

- On-chip Read-write (Cannot be changed)
- On-chip Read-only (Cannot be changed)
- On-chip Guarded (Cannot be changed)
- User Read-write (Cannot be selected when the single chip mode is selected.)
- User Read-only (Cannot be selected when the single chip mode is selected.)
- User Guarded
- Emulator Read-write
- Emulator Read-only
- Emulator Guarded

5.2 Downloading a Program

This section describes how to download a program and view it as source code or assembly-language mnemonics.

Note: After a break occurs, the HEW displays the location of the program counter (PC) on the editor. In most cases, for example if an Elf/Dwarf2-based project is moved from its original path (at the build), the source file may not be automatically found. In this case, the HEW will open a source file browser dialog box to allow you to manually locate the file. This path will then be used to update any other source files in this debug project.

5.2.1 Downloading a Program

A load module to be debugged must be downloaded.

To download a program, select the load module from [Debug -> Download] or select [Download] from the popup menu opened by clicking the right-hand mouse button on the load module in [Download modules] of the [Workspace] window.

Note: Before downloading a program, it must be registered to the HEW as a load module. For registration, refer to section 4.3, Setting at Emulator Activation.

5.2.2 Viewing the Source Code

Select a source file name in the [Workspace] window and click [Open] in the popup menu to make the HEW open the source file in the integrated editor. It is also possible to display your source files by double-clicking on their names in the [Workspace] window.

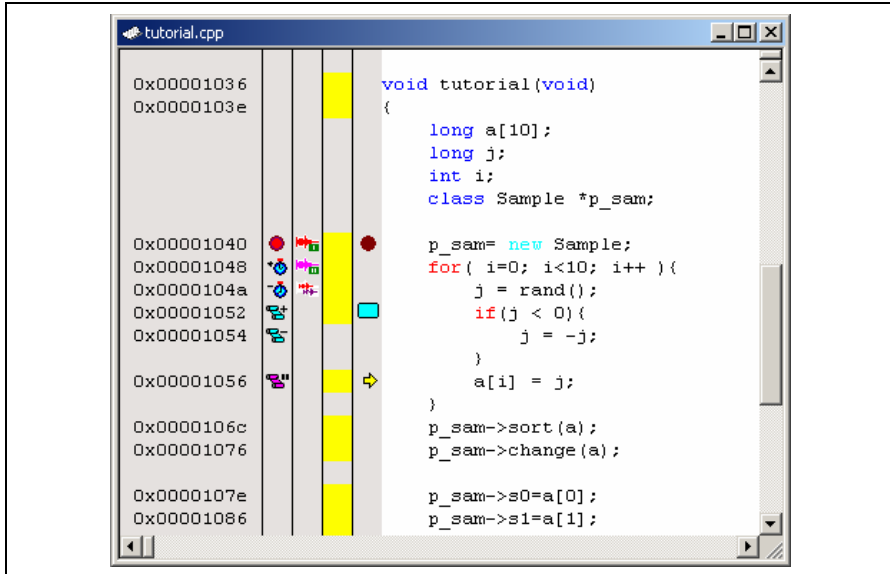

Figure 5.6 Source Window

In this window, the following items are shown on the left as information on lines.

- First column (Source address column): Displays the address information for the source line
- Second column (Event column): Event information (break)
- Third column (EXT.2 Trigger column): EXT.2 Trigger information
- Fourth column (Code Coverage column): Code Coverage
- Fifth column (Editor column): PC, bookmark, and breakpoint information







The Editor window is displayed in the right part of the Source window.

Source address column

When a program is downloaded, an address for the current source file is displayed on the Source address column. These addresses are helpful when setting the PC value or a breakpoint.

Event column





The Event column displays the following items:

- : Address condition break by an event or a range channel
- : Starts time measurement by an event channel
- : Ends time measurement by an event channel
- : Starts a point-to-point range trace
- : Ends a point-to-point range trace
- : Halts trace

These are also set by using the popup menu.

EXT.2 Trigger column

The EXT.2 Trigger column displays the following items:

- : EXT.2-1 trigger condition
- : EXT.2-2 trigger condition
- : EXT.2-3 trigger condition
- : EXT.2-4 trigger condition
- : Two or more EXT.2 trigger conditions



It is also possible to set them by using the popup menu.

Code Coverage column

This column displays code coverage information graphically.

Editor column

Editor column displays the following items:

- : A bookmark is set.
- : A PC Break is set.
- : PC location

☰ To switch off a column in all source files

1. Click the right-hand mouse button on the [Editor] window or select the [Edit] menu.
2. Click the [Define Column Format...] menu item.
3. The [Global Editor Column States] dialog box is displayed.
4. A check box indicates whether the column is enabled or not. If it is checked, the column is enabled. If the check box is gray, the column is enabled in some files and disabled in others. Deselect the check box of a column you want to switch off.
5. Click the [OK] button for the new column settings to take effect.

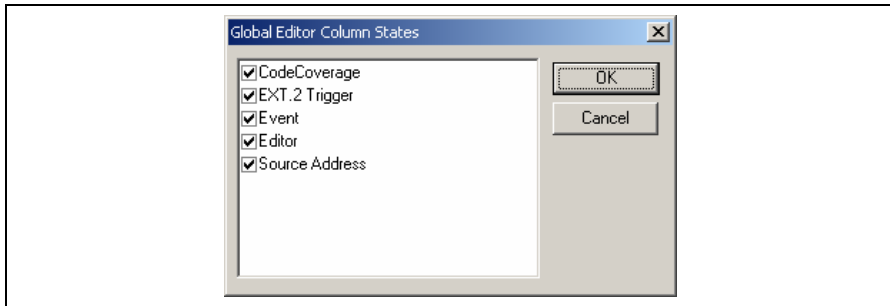

Figure 5.7 [Global Editor Column States] Dialog Box

☰ To switch off a column in one source file

1. Click the right-hand mouse button on the [Editor] window which contains the column you want to remove to display the popup menu.
2. Click the [Columns] menu item to display a cascaded menu item. The columns are displayed in this popup menu. If a column is enabled, it has a tick mark next to its name. Clicking the entry will toggle whether the column is displayed or not.

5.2.3 Viewing the Assembly-Language Code

If there is an address at the cursor position in the [Editor] window, selecting [Go to Disassembly] in the pop-up menu opens the [Disassembly] window.

The first address displayed in the [Disassembly] window is the address where the cursor is placed in the [Editor] window.

If you do not have a source file, but wish to view code in the assembly-language level, either choose [View -> Disassembly...], use the Ctrl + D accelerator, or click on the [Disassembly] window's toolbar button .

The [Disassembly] window opens at the current PC location.

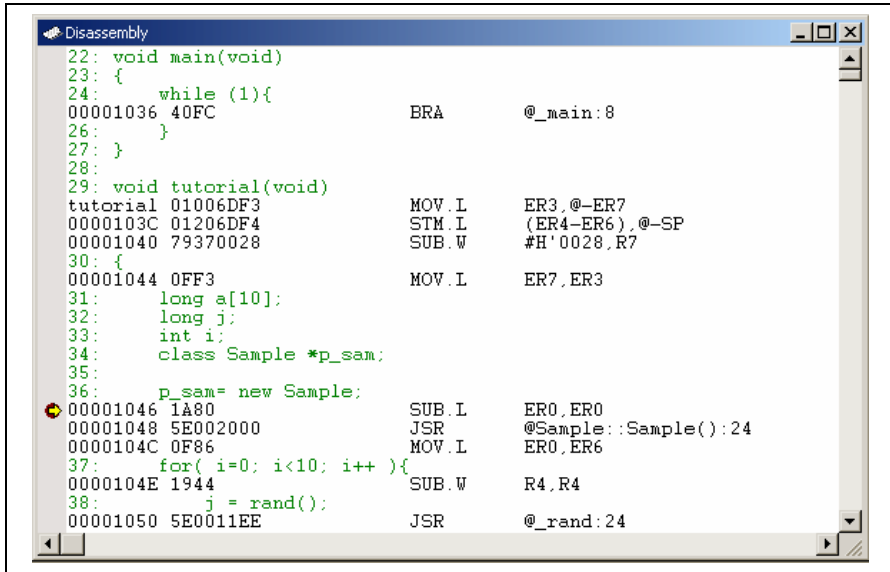

Figure 5.8 [Disassembly] Window

5.2.4 Modifying the Assembly-Language Code

You can modify the assembly-language code by double-clicking on the instruction that you want to change. The [Assembler] dialog box will be opened.

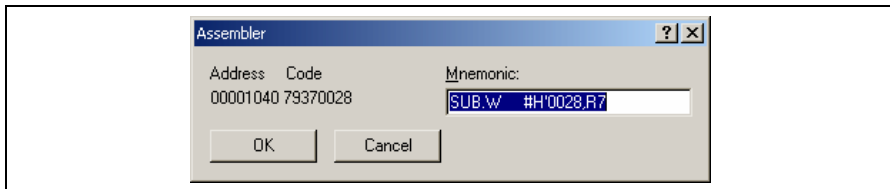

Figure 5.9 [Assembler] Dialog Box

The address, instruction code, and mnemonic are displayed. Enter the new instruction or edit the old instruction in the [Mnemonics] field. Pressing the [Enter] key will replace the memory content with the new instruction and move on to the next instruction. Clicking the [OK] button will replace the memory content with the new instruction and close the dialog box. Clicking the [Cancel] button or pressing the [Esc] key will close the dialog box without modifying the memory contents.

Note: The assembly-language code being displayed is the current memory content. If the memory contents are changed the [Assembler] dialog box and the [Disassembly] window will show the new assembly-language code, but the source file displayed in the [Editor] window will be unchanged. This is the same even if the source file contains assembly codes.

5.2.5 Viewing a Specific Address

When you are viewing your program in the [Disassembly] window, you may wish to look at another area of your program's code. Rather than scrolling through a lot of code in the program, you can go directly to a specific address. Select [Set Address...] from the popup menu, and the dialog box shown in figure 5.10 is displayed.

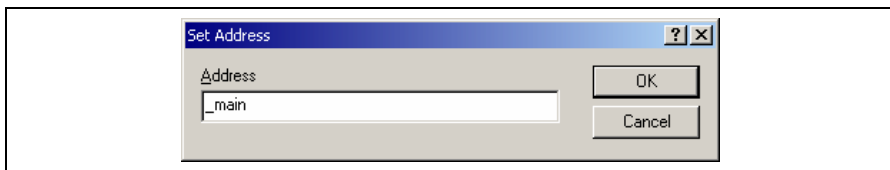

Figure 5.10 [Set Address] Dialog Box

Enter the address in the [Address] edit box and either click on the [OK] button or press the Enter key. A label name can also be specified as the address. The [Disassembly] window will be updated to show the code at the new address. When an overloaded function or a class name is entered, the [Select Function] dialog box opens for you to select a function. For details, refer to section 5.13.3, Supporting Duplicate Labels.

5.2.6 Viewing the Current Program Counter Address

Wherever you can enter an address or value into the HEW, you can also enter an expression. If you enter a register name prefixed by the hash character, the contents of that register will be used as the value in the expression. Therefore, if you enter the expression #pc in the [Set Address] dialog box, the [Source] or [Disassembly] window will display the current PC address. It allows the offset of the current PC to be displayed by entering an expression with the PC register plus an offset, e.g., #PC+0x100.

5.3 Debugging with the Command Line Interface

Use the [Command Line] window to enter text-based commands instead of window menus and commands.

5.3.1 Opening the [Command Line] Window

Choose [View -> Command Line] or click the [Command Line] toolbar button  to open the [Command Line] window.

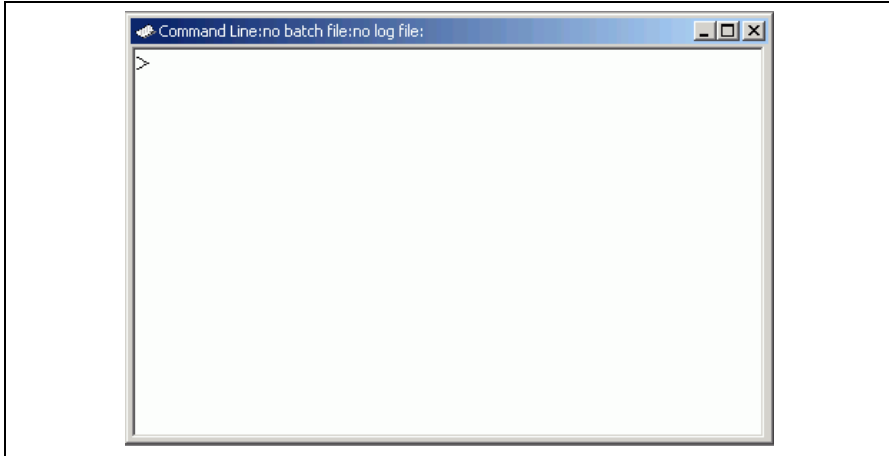

Figure 5.11 [Command Line] Window

This window allows the user to control the debugging platform by sending text-based commands. A series of predefined command lines can be called from a file and the output can be recorded in a file. The command can be executed by pressing the [Enter] key after the command is input at the prompt (<) on the last line. For information on the available commands, refer to appendix H, Command Lines, and the on-line help.

If available, the window title displays the current batch and log file names separated by colons.

Pressing the Ctrl + ↑ or Ctrl + ↓ keys on the last line displays the command line previously executed.

The HEW command and TCL commands can be input in this window.

5.3.2 Specifying a Command File

It is useful to use a command file when a series of predefined command lines need to be executed. Create a command file by a text editor and write necessary command lines. The default extension for command-file names is .hdc.

Choose [Set Batch File...] from the popup menu to open the [Set Batch File] dialog box, in which the name of a command file (*.hdc) can be specified. Clicking the [OK] button displays the specified command file name as the window title. Clicking the [Cancel] button closes the dialog box without changing the setting.



Figure 5.12 [Set Batch File] Dialog Box

5.3.3 Executing a Command File

Click the [Play] button in the [Set Batch File] dialog box or choose [Play] from the popup menu to execute the command file. The [Play] menu is displayed in gray while the file is running and can be used when the command file execution stops and control returns to the user.

5.3.4 Stopping Command Execution

Choose [Stop] from the popup menu to stop command execution. The [Stop] menu item becomes valid during command execution.

5.3.5 Specifying a Log File

Choose [Set Log File...] from the popup menu to open the [Open Log File] dialog box, in which a log file to store the command execution results can be specified.

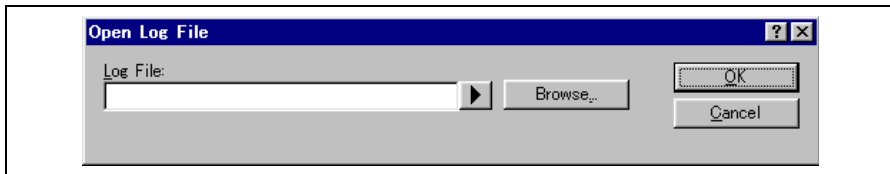

Figure 5.13 [Open Log File] Dialog Box

Enter the name of a log file (*.log). The logging option is automatically set and the name of the file is shown on the window title bar.

Opening a previous log file will ask the user if they wish to append or overwrite the current log.

5.3.6 Starting or Stopping Logging

Choose [Logging] from the popup menu to toggle logging to file on and off. When logging is active, the button becomes effective. Note that the contents of the log file cannot be viewed until logging is completed, or temporarily disabled by clearing the check box. Re-enabling logging will append to the log file.

5.3.7 Entering a Full Path to the File

It is recommended that the full path to a file is specified as a file name in the [Command line] window because the current directory can be moved. However, care must be taken to enter the correct full path to a file when it is entered from the keyboard. To save this trouble, a full path can be easily specified by browsing through files.

Choose [Browse...] from the popup menu to open the [Browse] dialog box. Select a file and click [Open] to paste the full path to the selected file to the cursor location. This option can only be used when the cursor is located on the last line.

5.3.8 Pasting a Placeholder

Select a placeholder from the [Placeholder] submenu in the popup menu to paste the selected placeholder to the cursor location. This function is only available when the cursor is located on the last line.

5.4 Viewing the Registers

If you are debugging at assembly-language level, then you will find it useful to see the contents of the CPU's general registers. You can do this by using the [Register] window.

5.4.1 Opening the [Register] Window

To open the [Register] window, choose [View->CPU->Registers] or click the [Register] toolbar button . The [Register] window opens showing all of the CPU's general registers and the values, displayed in hexadecimal.

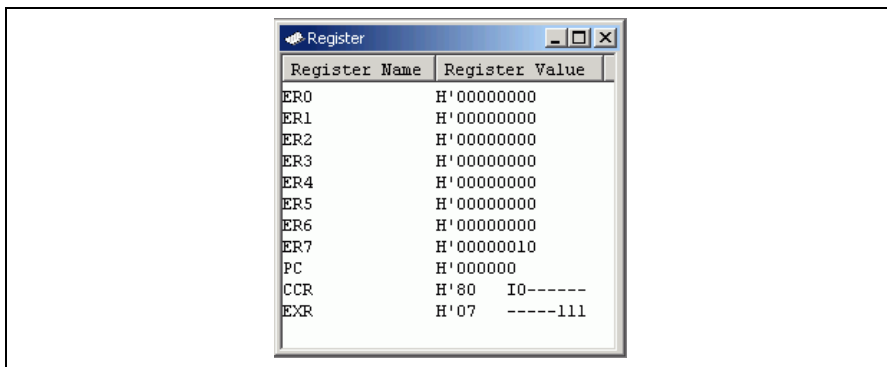

Figure 5.14 [Register] Window

5.4.2 Expanding a Bit Register

If a register is used as a set of flags at the bit level for the control of state, its one-character symbol rather than its state indicate each bit. Double-click on the register's name to display the [Register] dialog box and switch each bit on or off. Checking the box for any bit specifies it as holding a 1, while removing the check specifies it as a 0.

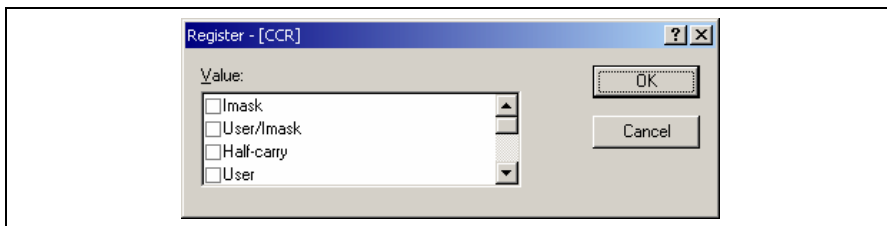

Figure 5.15 Expanding a Bit Register

5.4.3 Choosing a Register to be Displayed

To choose a register to be displayed in the [Register] window, choose [Settings...] from the pop-up menu. This dialog box is shown in figure 5.16.

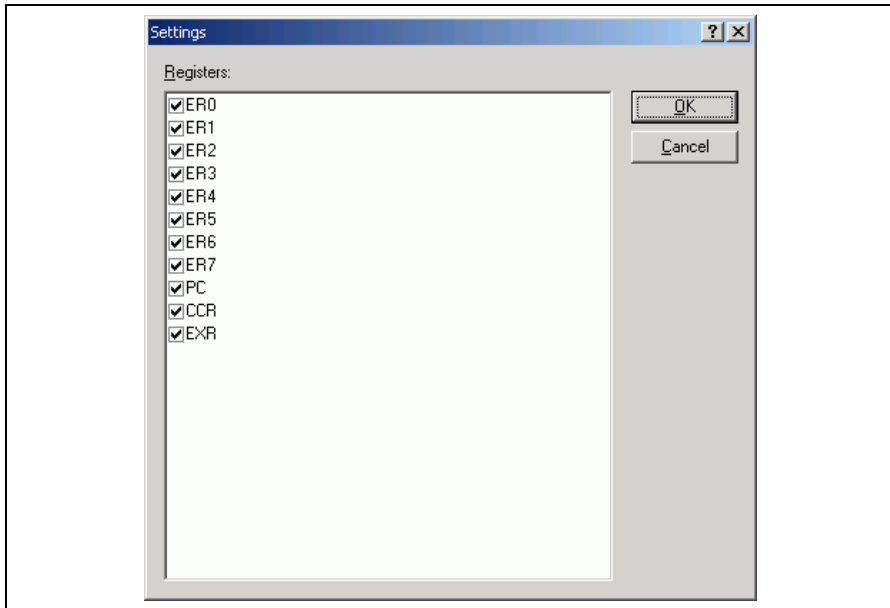

Figure 5.16 [Settings] Dialog Box

5.4.4 Splitting Up the Window Display

To vertically divide the [Register] window display into two, select [Split] from the pop-up menu and move the split-up bar.

5.4.5 Modifying Register Contents

To change a register's content, open the [Register] dialog box in one of the following methods:

- Double-click the register you want to change.
- Select the register you want to change, and choose [Edit...] from the popup menu.

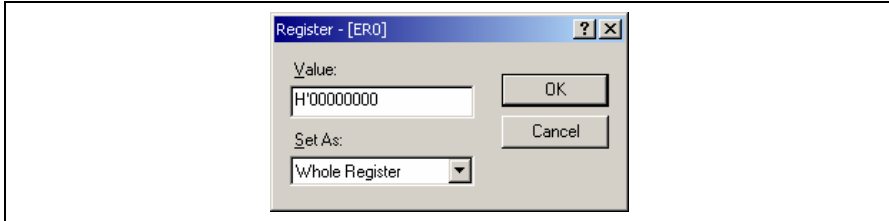

Figure 5.17 [Register] Dialog Box

You can enter a number or C/C++ expression in the [Value] field. You can choose whether to modify the whole register contents, a masked area, floating or flag bits by selecting an option from the combo box (the contents of this list depend on the CPU model and selected register).

When you have entered the new number or expression, click the [OK] button or press the [Enter] key; the dialog box closes and the new value is written into the register.

5.4.6 Using Register Contents

Use the value contained in a CPU register by specifying the register name prefixed by the “#” character, e.g.: #R1, #PC, #R6L, or #ER3 when you are entering a value elsewhere in the HEW, for example when displaying a specified address in the [Disassembly] or [Memory] windows. Available register names depend on the target MCU being emulated.

5.4.7 Saving the Currently Displayed Contents

The contents currently displayed in the window can be saved in a text file. Select [Save to File...] from the popup menu.

5.5 Operating Memory

This section describes how to control memory contents, such as viewing a memory area in different formats, filling and moving a memory block, and loading and verifying a load module file.

5.5.1 Viewing a Memory Area

To look at a memory area, choose [View -> CPU ->Memory...] or click the [View Memory] toolbar button () to open the [Memory] window. This will open the [Format] dialog box shown in figure 5.18.

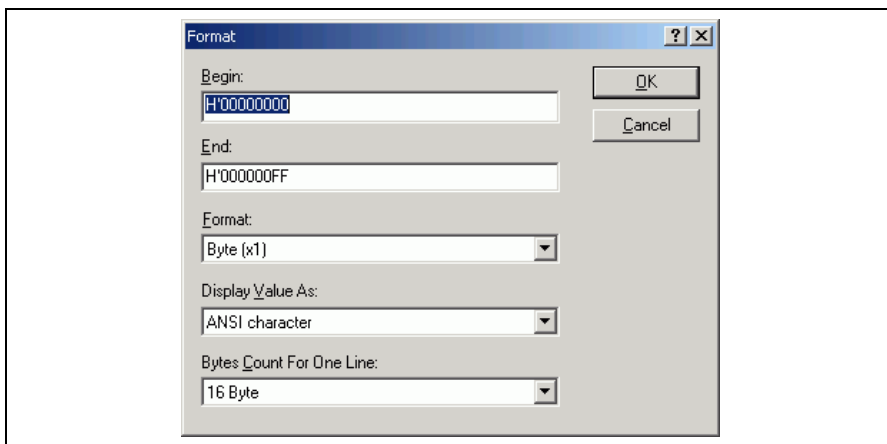

Figure 5.18 [Format] Dialog Box

Enter the range you want to display as an address value or an equivalent symbol in the [Begin] and [End] fields. Select the data size and format for the display from the [Display Value As] and [Format] drop-down lists, respectively. Select the number of bytes displayed in one line from the [Bytes Count For One Line] drop-down list. Click the [OK] button or press the Enter key, and the dialog box closes and the [Memory] window opens. The display can be scrolled within the range of the entered display start and end addresses.

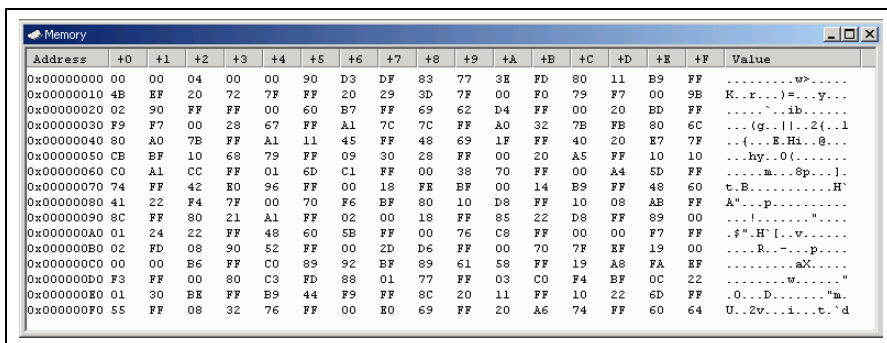

Figure 5.19 [Memory] Window

Note: Each item in the [Data] column is called as the memory unit.

There are three display columns:

[Address]: First address of the memory data displayed on this row

[+n] Memory data read from [Address] and 'n' means the offset value from the first address of the row. Data is read from the debugging platform's physical memory in the access width, and then converted to the display width.

[Value]: Data displayed in an alternative format.

5.5.2 Displaying Data in Different Formats

If you want to change the display format of the [Memory] window, select [Format] from the popup menu. The dialog box shown in figure 5.20 is displayed.

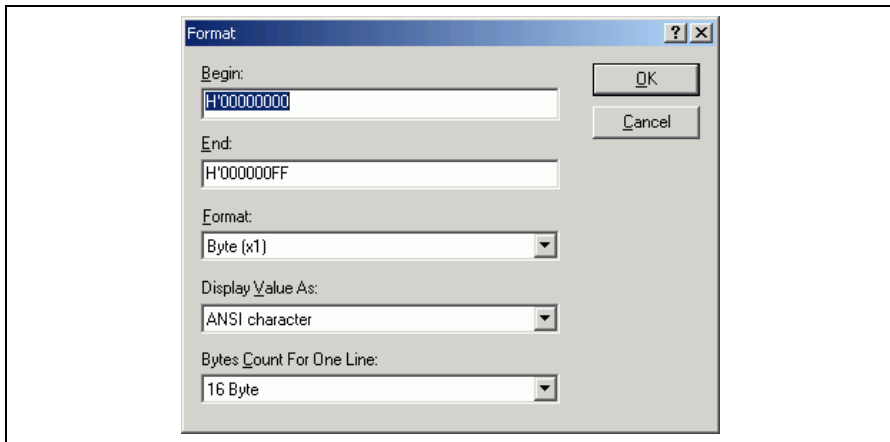

Figure 5.20 [Format] Dialog Box

To display and edit memory in different widths, use the [Display Data As] combo box. For example, choose the [Byte] option and the display will be updated to show the memory area as individual bytes.

The data can be converted into different formats, as shown in the [Value] column. The list of formats depends on the data selection.

To change the number of bytes displayed on one line, use the [Bytes Count For One Line] drop-down list. For example, choose the [8 Byte] option and the display will be updated to show the 8-byte data on one line.

5.5.3 Splitting Up the Window Display

To vertically divide the [Memory] window display into two, select [Split] from the popup menu and move the split-up bar.

5.5.4 Viewing a Different Memory Area

To change the memory area displayed in the [Memory] window, use the scroll bars. To quickly look at a new address, use the [Format] dialog box. This can be opened by choosing [Format] from the popup menu.

Enter the new address value, and click the [OK] button or press the [Enter] key. The dialog box closes and the [Memory] window display is updated with the data at the new address. When an overloaded function or a class name is entered, the [Select Function] dialog box opens for you to select a function.

5.5.5 Modifying the Memory Contents

The memory contents can be modified via the [Edit Memory] dialog box. Move the cursor on the memory unit (according to the [Memory] window display choice) that you wish to change. Either double-click on the memory unit or press the [Enter] key. The dialog box shown in figure 5.21 is displayed.

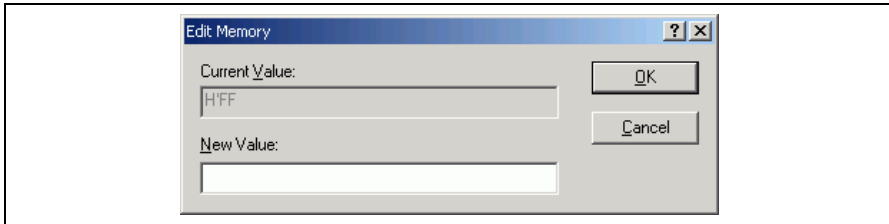

Figure 5.21 [Edit Memory] Dialog Box

A number or C/C++ expression can be entered in the [New Value] field. After you have entered the new number or expression, click the [OK] button or press the [Enter] key. Then the dialog box closes and the new value is written into memory.

The memory contents can also be modified by moving the cursor on the memory unit and entering the new value in hexadecimal through the keyboard.

5.5.6 Selecting a Memory Range

If the memory address range is in the [Memory] window, you can select the range by clicking on the first memory unit (according to the [Memory] window display choice) and dragging the mouse to the last unit. The selected range is highlighted.

5.5.7 Finding a Value in Memory

To find a value in memory, open the [Memory] window and select [Search...] from the popup menu or from the [Memory] drop-down menu. The [Search Memory] dialog box shown in figure 5.22 is displayed.

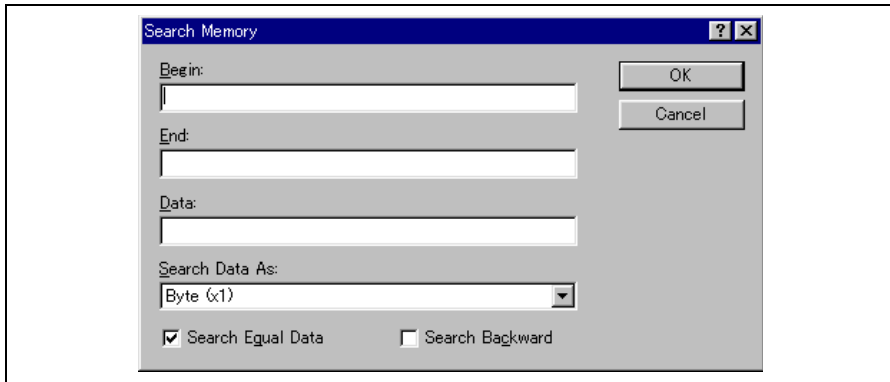

Figure 5.22 [Search Memory] Dialog Box

Enter the start and end addresses of the range in which to search and the data value to search for, and select the search format. If pattern search is selected as the search format, a byte string of up to 256 bytes can be searched for. The end address can also be prefixed by a plus (+); the end address will become the (start address) + (entered value).

Search conditions other than pattern search are data match/mismatch and search direction. Note that only data match and forward direction can be selected with pattern search.

Click the [OK] button or press the Enter key. The dialog box closes and the HEW searches the range for the specified data. If the data is found, it is highlighted.

If the data could not be found, the [Memory] window display remains unchanged and a message box informing that the data could not be found is displayed.

If [Search Next] is selected from the popup menu in the state where data has been found, the search will continue from the next address.

5.5.8 Filling a Memory Area with a Value

A value can be set as the contents of a memory address range using the memory fill function.

To fill a memory range with the same value, select [Fill...] from the popup menu of the [Memory] window or from the [Memory] drop-down menu. The [Fill Memory] dialog box is shown in figure 5.23.

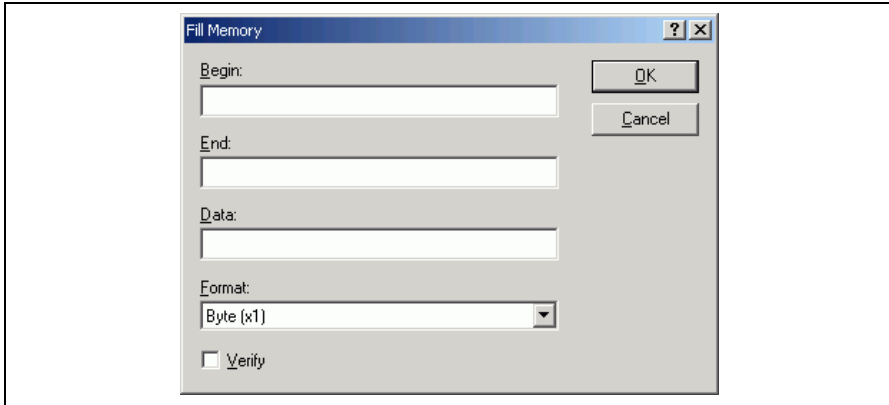

Figure 5.23 [Fill Memory] Dialog Box

If an address range has been selected in the [Memory] window, the specified start and end addresses will be displayed. Select a format from the [Format] combo box and enter the data value in the [Data] field. On clicking the [OK] button or pressing the [Enter] key, the dialog box closes and the new value is written into the memory range.

5.5.9 Copying a Memory Area

You can copy a memory area using the memory copy function. Select [Copy...] from the popup menu of the [Memory] window or from the [Memory] drop-down menu. The [Copy Memory] dialog box is opened (figure 5.24).

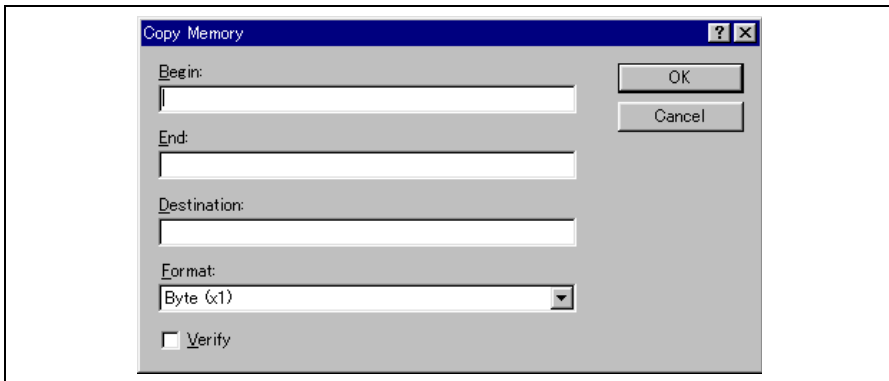

Figure 5.24 [Copy Memory] Dialog Box

The source start address and end address selected in the [Memory] window will be displayed in the [Begin] and [End] fields. Checking the [Verify] check box enables copying while comparing the copy source and copy destination. The copy unit can be selected in the [Format] combo box. Enter the destination start address in the [Destination] field and click the [OK] button or press the [Enter] key. This will close the dialog box and copy the memory block to the new address.

5.5.10 Saving and Verifying a Memory Area

Use the memory-save function to save the memory in a specified address space to a disk file. Open the [Save Memory As] dialog box by choosing [File -> Save memory...].

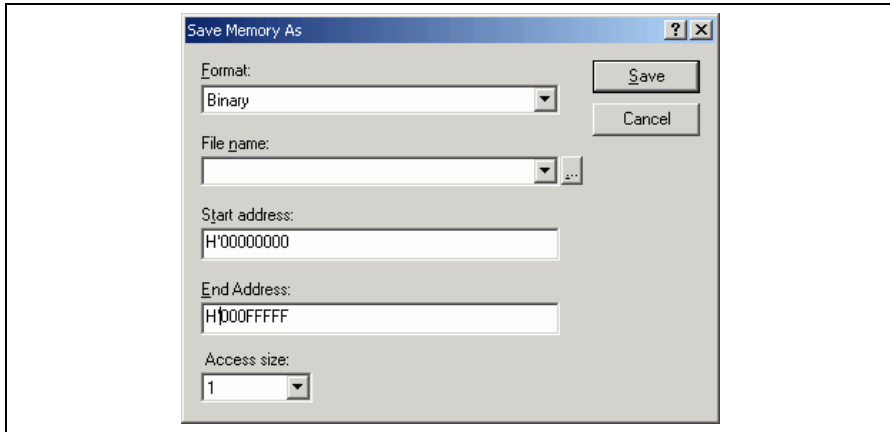

Figure 5.25 [Save Memory As] Dialog Box

Enter the start and end addresses of the memory block that you wish to save, and a name and format for the file. The [File name] combo box contains the previous four file names used for saving memory.

Clicking the [...] button can open the standard [File Save As] dialog box. On clicking the [OK] button or pressing the [Enter] key, the dialog box closes and the memory block will be saved into the disk as a file of the specified format type. The access size for saving data can be selected from the [Access Size] drop-down list.

Memory in the specified address space can be verified using the memory verify function. Open the [Verify Memory] dialog box by choosing [File -> Verify Memory...]. The access size at verification can be selected from the [Access Size] drop-down list.

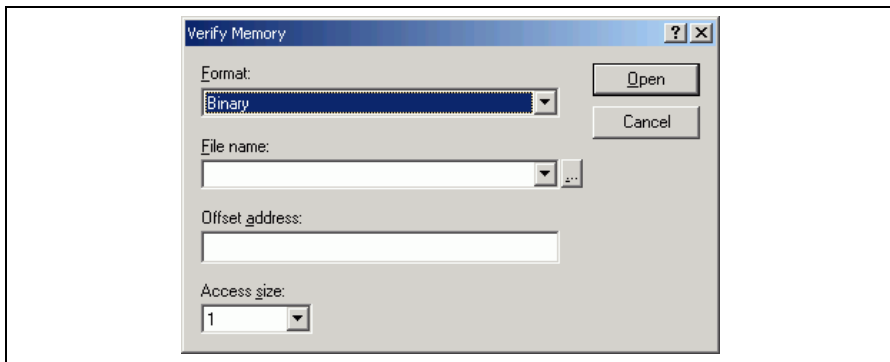

Figure 5.26 [Verify Memory] Dialog Box

5.5.11 Disabling Update of the Window Contents

Automatic update of the [Memory] window contents, which is performed when user program execution stops and in other cases, can be disabled. This is done by checking [Lock Refresh] in the popup menu. The [Memory] window will be grayed.

5.5.12 Updating the Window Contents

The [Memory] window contents can be forcibly updated. This is done by checking [Refresh] in the popup menu.

5.5.13 Comparing the Memory Contents

The contents of two memory blocks can be compared. Open the [Compare Memory] dialog box by selecting [Memory -> Compare...] from the main menu or by selecting [Compare...] from the popup menu of the [Memory] window.

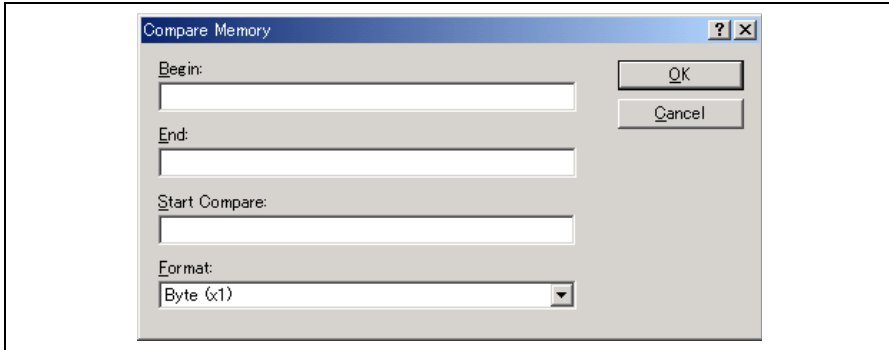

Figure 5.27 [Compare Memory] Dialog Box

Enter the comparison format ([Format]), the start address ([Begin]) and end address ([End]) of the source memory area, and the start address ([Start Compare]) of the destination memory area. If the memory block is already highlighted in the [Memory] window, the start and end addresses will be automatically filled in when the [Compare Memory] dialog box is opened.

If there is a mismatch, the address where it was found is displayed in a message box.

5.5.14 Loading a Memory Area from a File

A file can be loaded to the debugging platform's memory. Select [Load...] from the popup menu of the [Memory] window to open the [Load Program] dialog box.

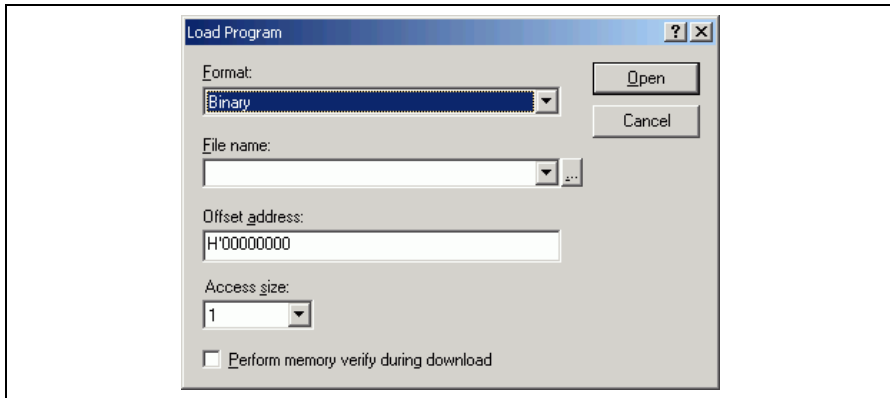

Figure 5.28 [Load Program] Dialog Box

Enter the file format ([Format]) and the file name ([File name]). If the load address value is to be changed, enter the offset value in the offset field ([Offset address]), otherwise enter zero.

5.6 Viewing the I/O Memory

A microcomputer contains on-chip peripheral modules. The exact number and type of peripheral modules differ between devices but the typical modules are a DMA controller, serial communications interface, A/D converter, integrated timer unit, bus state controller, and watchdog timer. Registers that are mapped to the microcomputer's address space controls the on-chip peripheral modules.

The [Memory] window enables you to look at data in continuous memory addresses as byte, word, longword, single-precision floating-point, double-precision floating-point, or ASCII values. However, registers of different sizes are allocated to non-continuous memory addresses in the I/O memory. To handle this memory, the HEW has the [IO] window to facilitate checking and setting up of these kinds of registers.

5.6.1 Opening the [IO] Window

To open the [IO] window, select [View -> CPU -> IO] or click the [View I/O] toolbar button (). Modules that match the on-chip peripheral modules organize the I/O register information. When the [IO] window is first opened, only a list of module names is displayed.

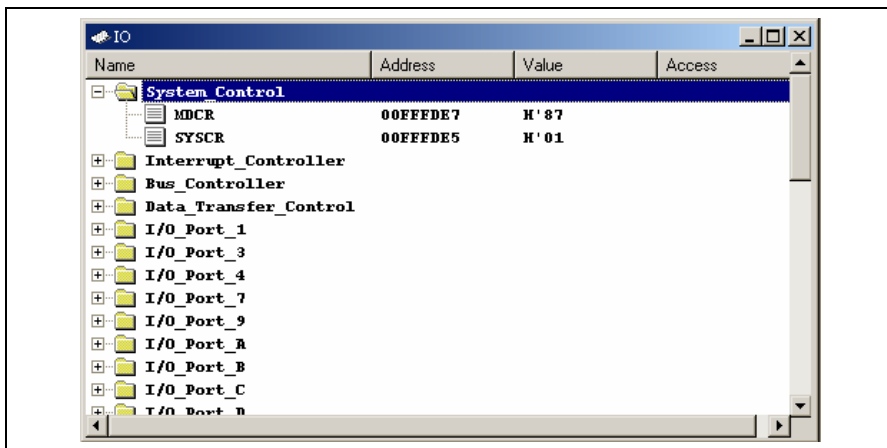

Figure 5.29 [IO] Window

5.6.2 Expanding the I/O Register Display

To display the names, addresses, and values of the I/O registers, click the [+] mark at the left of the module name or select the module name by clicking on it or using the cursor keys and press the [->] key. The module display will expand to show the individual registers of that peripheral module and their names, addresses, and values. Clicking the [-] mark at the left of the expanded module name or pressing the [-<] key will close the I/O register display.

For a display in the bit level, click the [+] mark at the left of the register name or select the register name by clicking on it or using the cursor keys and press the [->] key. The register display will expand to show the names of register bits and values. Clicking the [-] mark at the left of the expanded register name or pressing the [-<] key will close the register bits display.

5.6.3 Manually loading an IO file

To manually load an IO file right click on the [IO] window and select the [Load IO file...] menu item on the IO window pop-up. A standard file browser is invoked. Simply select the file you require to load and click OK. The IO file will be loaded into the window.

5.6.4 Modifying the I/O Register Contents

To edit the value in an I/O register, type hexadecimal values directly into the window. To enter more complex expressions, double-click or press the [Enter] key on the register to open a dialog box to modify the register contents. When you have entered the new number or expression, click the [OK] button or press the [Enter] key; the dialog box closes and the new value is written into the register.

5.6.5 Saving the Currently Displayed Contents

The contents currently displayed in the window can be saved in a text file. Select [Save to File...] from the pop-up menu.

5.7 Viewing the Current Status

Choose [View -> CPU -> Status] or click the [View Status] toolbar button () to open the [Status] window and see the current status of the debugging platform.

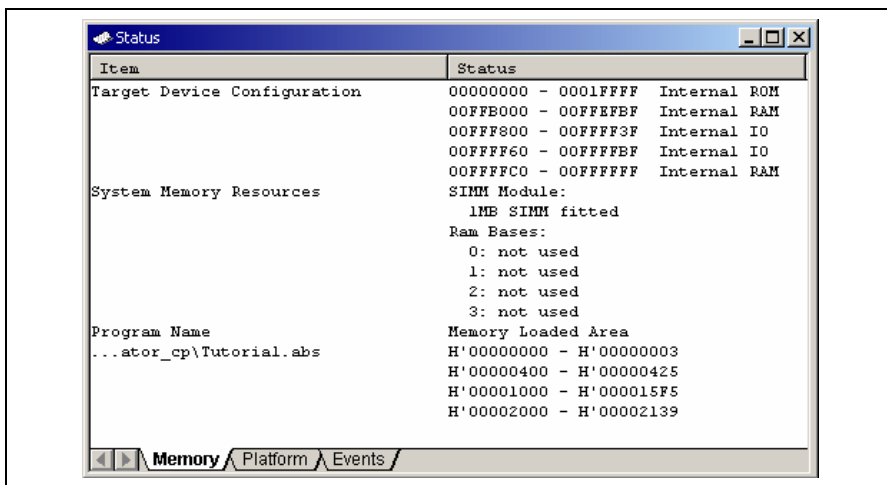

Figure 5.30 [Status] Window

The [Status] window has three sheets:

- [Memory] sheet
Contains information about the current memory status including the memory-mapping resources and the areas used by the currently loaded object file.
- [Platform] sheet
Contains information about the current status of the debugging platform, typically including CPU type and emulation mode; and run status.
- [Events] sheet
Contains information about the current event (breakpoint) status, including resource information.

Note: The items that can be set in this dialog box vary according to the emulator in use. For details, refer to section 8, Software Specifications Specific to This Product, or the online help.

5.8 Reading and Displaying the Emulator Information Regularly

Use the [Extended Monitor] window to know the changing information on the emulator no matter the user program is running or halted.

Note: The Extended Monitor function does not affect the execution of the user program since it monitors the user system or the signal output from the MCU in the emulator by using the emulator's hardware circuit.

5.8.1 Opening the [Extended Monitor] Window

Selecting [View -> CPU -> Extended Monitor] or clicking the [Extended Monitor] toolbar button  displays this window. The interval of updating the display is approximately 100 ms during user program execution or 1,000 ms while breaking, respectively.

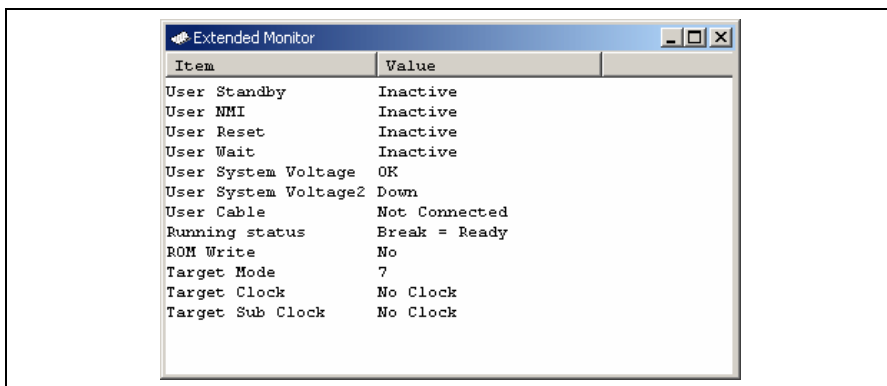

Figure 5.31 [Extended Monitor] Window

5.8.2 Selecting Items to be Displayed

Selecting [Properties...] from the popup menu displays the [Extended Monitor Configuration] dialog box.

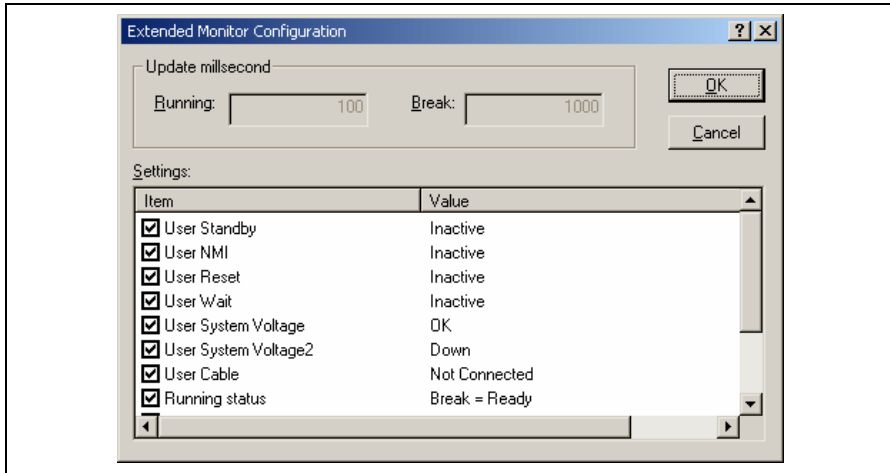

Figure 5.32 [Extended Monitor Configuration] Dialog Box

This dialog box allows the user to set the items to be displayed in the [Extended Monitor] window.

Note: The items that can be set in this dialog box vary according to the emulator in use. For details, refer to section 8, Software Specifications Specific to This Product, or the online help.

5.9 Displaying Memory Contents in Realtime

Use the [Monitor] window to monitor the memory contents during user program execution. In the Monitor function, the realtime operation is retained since the bus monitoring circuit of the emulator sets the read/write signal of the MCU as a trigger and holds the address bus and data bus values to update the displayed contents of the memory.

Up to eight points can be set by using the eight monitoring channels on the bus monitoring circuit. 1 to 256 bytes can be monitored at one point. It is possible that a part or all of monitoring ranges is overlapped.

Note: Monitoring is impossible for an area, such as an internal timer counter, where no internal read/write signal is generated to update a value.

5.9.1 Opening the [Monitor] Window

To open the [Monitor] window, select [View -> CPU -> Monitor -> Monitor Setting...] or click the [Monitor] toolbar button () to display the [Monitor Settings] dialog box.

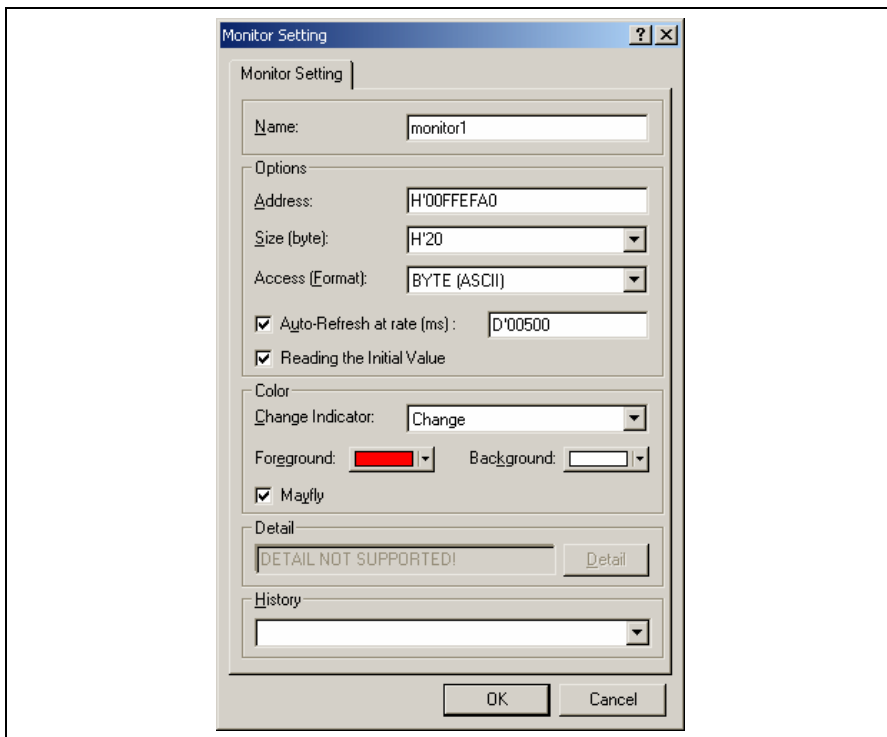

Figure 5.33 [Monitor Setting] Dialog Box

- [Name]: Decides the name of the monitor window.
- [Options]: Sets monitor conditions.
- [Address]: Sets the start address for monitoring.
- [Size]: Sets the range for monitoring.
- [Access]: Sets the access size to be displayed in the monitor window.
- [Auto-Refresh at rate]: Sets the interval for acquisition by monitoring (500 ms at minimum).
- [Reading the Initial Value]: Selects reading of the values in the monitored area when the monitor window is opened.
- [Color]: Sets the method to update monitoring and the attribute of colors.
- [Change Indicator]: Selects how to display the values that have changed during monitoring (available when [Reading the Initial Value] has been selected).
- No change:** No color change.
- Change:** Color is changed according to the [Foreground] and [Background] options.
- Gray:** Those data with values that have not been changed are displayed in gray.
- Appear:** A value is only displayed after changed.
- [Foreground]: Sets the color used for display (available when [Change] has been selected).
- [Background]: Sets the background color (available when [Change] has been selected).
- [Mayfly]: A check in this box selects restoration of the color of those data which have not been updated in a specified interval to the color selected in the [Background] option. The specified interval is the interval for monitor acquisition (available when [Change], [Gray], or [Appear] has been selected).
- [Detail]: Sets the items specific to the emulator. Not used with this emulator.
- [History]: Displays the previous settings.

- Notes: 1. In this emulator, odd addresses cannot be specified as the start addresses for monitoring.
 2. Selection of the foreground or background color may not be available depending on the operating system in use.

After setting, clicking the [OK] button displays the [Monitor] window.

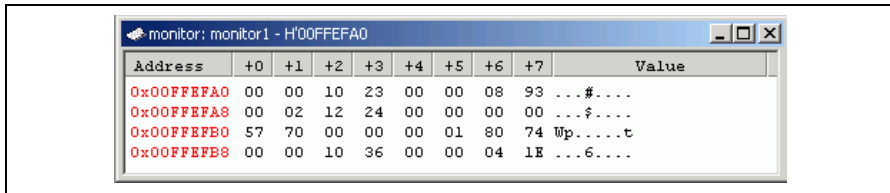

Figure 5.34 [Monitor] Window

During user program execution, the display is updated according to the setting value of the auto-update interval.

Note: Select [Refresh] from the popup menu when data is not displayed correctly after changing the address or content of memory.

5.9.2 Changing the Monitor Settings

Selecting [Monitor Setting...] from the popup menu of the [Monitor] window displays the [Monitor Setting] dialog box, which allows the settings to be changed.

Colors, the size of accesses, and the display format can be easily changed from [Color] or [Access] of the popup menu.

5.9.3 Temporarily Stopping Update of the Monitor

During user program execution, the display of the [Monitor] window is automatically updated according to the auto-update interval. Select [Lock Refresh] from the popup menu of the [Monitor] window to stop the update of display. The characters in the address section are displayed in black, and the update of display is stopped.

Selecting [Lock Refresh] again from the popup menu cancels the stopped state.

5.9.4 Deleting the Monitor Settings

Selecting [Close] from the popup menu of the [Monitor] window to be deleted closes the [Monitor] window and deletes the monitor settings.

5.9.5 Monitoring Variables

Using the [Watch] window refers to the value of any variables.

When the address of the variable registered in the [Watch] window exists within the monitoring range that has been set by the Monitor function, the value of the variable can be updated and displayed.

This function allows checking the content of a variable without affecting the realtime operation.

For the [Watch] window, refer to section 5.14.3, [Watch] Window.

5.9.6 Hiding the [Monitor] Window

When using the Monitor function to monitor the value of a variable from the [Watch] window, hide the [Monitor] window for the effective use of the screen.

The current monitoring information is listed as the submenu when selecting [Display -> CPU -> Monitor]. The list consists of the [Monitor] window name and the address to start monitoring.

When the left of the list is checked, the [Monitor] window is being displayed.

Selecting items of the [Monitor] window you want to hide from the monitor setting list displays no [Monitor] window and removes the check mark at the left of the list.

To display the [Monitor] window again, select the hidden the [Monitor] window.

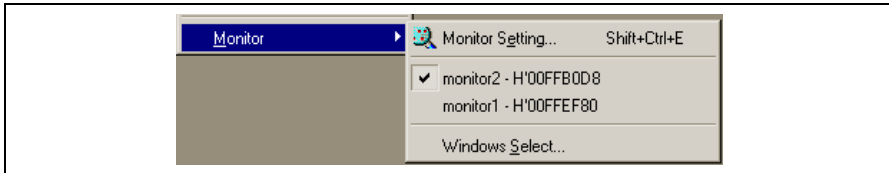

Figure 5.35 Monitor Setting List

5.9.7 Managing the [Monitor] Window

Selecting [Display -> CPU -> Monitor -> Windows Select...] displays the [Windows Select] dialog box. In this window, the current monitoring condition is checked and the new monitoring condition is added, edited, and deleted in succession.

Selecting multiple monitoring conditions enables a temporary stop of update, hiding, and deletion.

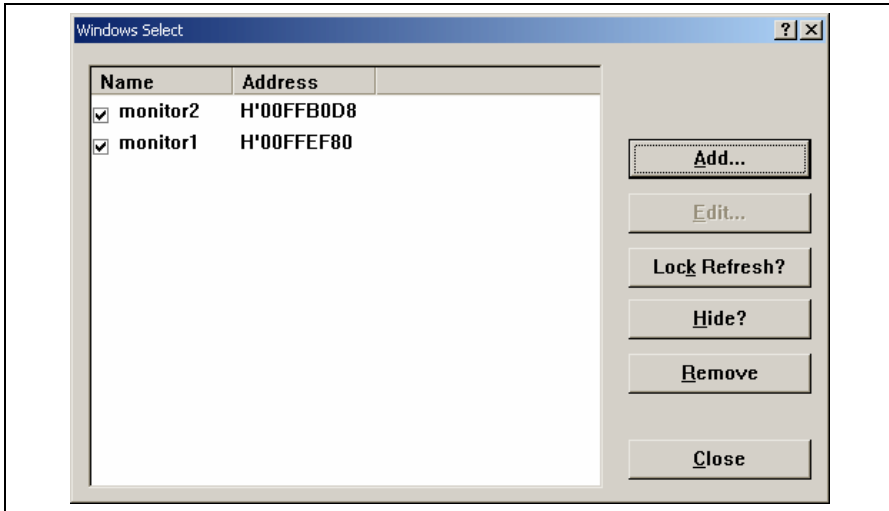

Figure 5.36 Selection in the [Monitor] Window

- [Add]: Adds a new monitoring condition.
- [Edit]: Changes the settings of the selected [Monitor] window (disabled when selecting multiple items).
- [Lock Refresh/Unlock Refresh]: Automatically updates or stops updating the display of the selected [Monitor] window.
- [Hide/UnHide]: Displays or hides the selected [Monitor] window.
- [Remove]: Removes the selected monitoring conditions.
- [Close]: Closes this dialog box.

5.10 Viewing the Labels

When the user program that includes the debugging information is loaded, the labels are registered at that time. It is also possible to add labels. The [Disassembly] window shows the first eight characters of each label instead of the corresponding address or as a part of an instruction operand.

Note: When a label value matches an operand, the corresponding instruction operand is replaced by the label.
If two or more labels have the same value, the one that comes first in alphabetical order is displayed.

When an address or a value can be entered in the dialog box, the labels can also be used.

5.10.1 Listing Labels

Choose [View -> Symbol -> Labels] or click the [View Labels] toolbar button () to list all labels defined in the current debugger session.

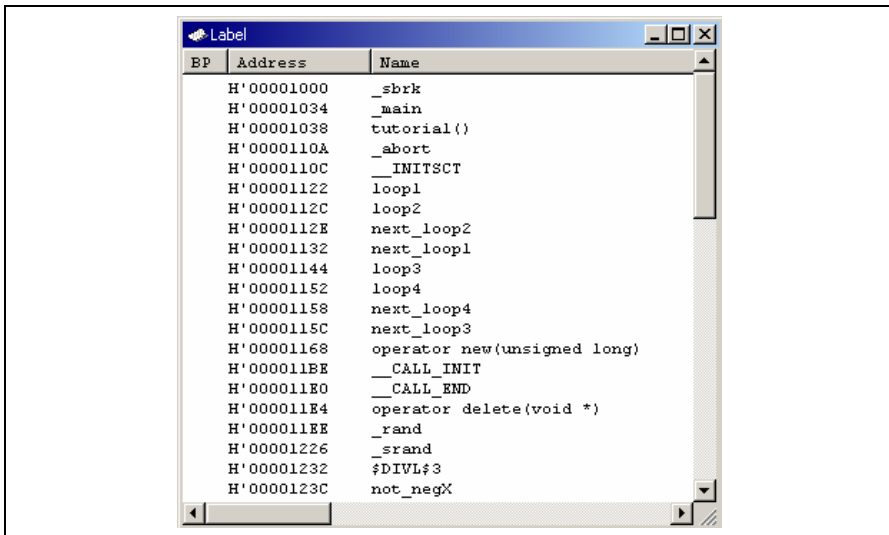

Figure 5.37 [Label] Window

You can view symbols sorted either alphabetically (by ASCII code) or by address value by clicking on the respective column heading.

Double-clicking in the [BP] column can set or clear a software breakpoint at the start of the function.

5.10.2 Adding a Label

Choose [Add...] from the popup menu and open the [Add Label] dialog box to add a label:

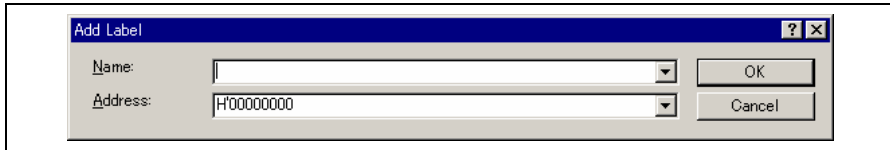

Figure 5.38 [Add Label] Dialog Box

Enter the new label name into the [Name] field and the corresponding value into the [Address] field and press [OK]. The [Add Label] dialog box closes and the label list is updated to show the new label. When an overloaded function or a class name is entered in the [Address] field, the [Select Function] dialog box opens for you to select a function. For details, refer to section 5.13.3, Supporting Duplicate Labels.

5.10.3 Editing a Label

Choose [Edit...] from the popup menu and open the [Edit Label] dialog box to edit a label:

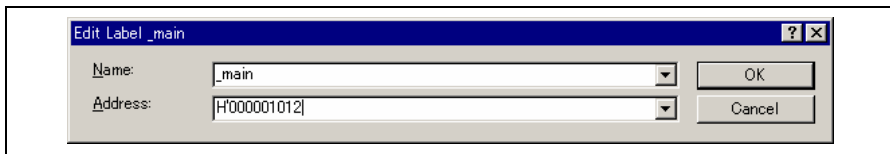

Figure 5.39 [Edit Label] Dialog Box

Edit the label name and value as required and then press [OK] to save the modified version in the label list. The list display is updated to show the new label details. When an overloaded function or a class name is entered in the [Address] field, the [Select Function] dialog box opens for you to select a function. For details, refer to section 5.13.3, Supporting Duplicate Labels.

5.10.4 Deleting a Label

To delete a label, select the label and choose [Delete] from the popup menu. A confirmation message box appears:



Figure 5.40 Message Box for Confirming Label Deletion

If you click [OK], the label is removed from the list and the window display is updated. If the message box is not necessary, check the [Don't ask this question again] check box.

5.10.5 Deleting All Labels

To delete all the labels from the list, choose [Delete All] from the popup menu. A confirmation message box appears:



Figure 5.41 Message Box for Confirming All Label Deletion

If you click [OK], all the labels are removed from the HEW system's symbol table and the list display will be cleared. If the message box is not necessary, check the [Don't ask this question again] check box.

5.10.6 Loading Labels from a File

A symbol file can be loaded and merged into the HEW's current symbol table. Choose [Load...] from the popup menu to open the [Load Symbols] dialog box:

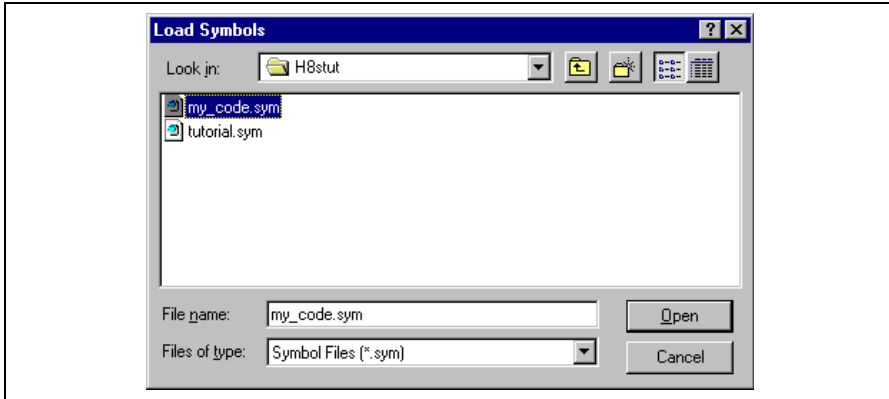

Figure 5.42 [Load Symbols] Dialog Box

The dialog box operates like a standard Windows® [open file] dialog box; select the file and click [Open] to start loading. The standard file extension for symbol files is “.sym”.

5.10.7 Saving Labels into a File

Choose [Save As...] from the popup menu to open the [Save Symbols] dialog box. The [Save Symbols] dialog box operates like a standard Windows® [Save File As] dialog box. Enter the name for the file in the [File name] field and click [Save] to save the HEW's current label list to a symbol file. The standard file extension for symbol files is “.sym”.

See appendix E, Symbol File Format, for the symbol file format.

Once a file is specified by the [Save As...] menu, the current symbol table can be saved in the same symbol file just by choosing [Save] from the popup menu.

5.10.8 Searching for a Label

Choose [Find...] from the popup menu to open the [Find Label] dialog box:

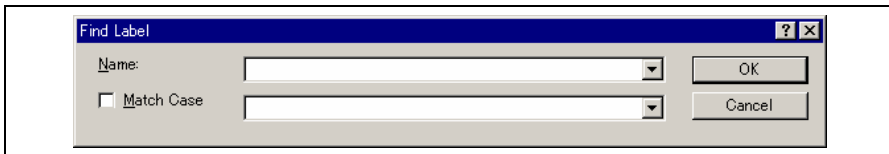

Figure 5.43 [Find Label] Dialog Box

Enter all or part of the label name that you wish to find into the edit box and click [OK] or press the [Enter] key. The HEW searches the label list for a label name containing the text that you entered.

Note: Only the label is stored by 1024 characters of the start, therefore the label name must not overlap mutually in 1024 characters or less. Labels are case sensitive.

5.10.9 Searching for the Next Label

Choose [Find Next] from the popup menu to find the next occurrence of the label containing the text that you entered.

5.10.10 Viewing the Source Corresponding to a Label

Select a label and choose [View Source] from the popup menu to open the [Source] or [Disassembly] window containing the address corresponding to the label.

5.11 Executing Your Program

This section describes how you can execute your program's code. In this section, run your program continuously or step single or multiple instructions at a time.

5.11.1 Running from Reset

To reset your user system and run your program from the reset vector address, choose [Debug->Reset Go], or click the [Go Reset] toolbar button ().

The program will run until it hits a breakpoint or a break condition is met. You can stop the program manually by choosing [Debug->Halt], or by clicking the [Halt] toolbar button ().

Note: The program will start running from whatever address is stored in the Reset Vector location. Therefore it is important to make sure that this location contains the address of your startup code.

5.11.2 Continuing Run

When your program is stopped, the HEW will display a yellow arrow mark in the gutter of the line in the [Source] and [Disassembly] windows that correspond to the CPU's current program counter (PC) address value. This will be the next instruction to be executed if you perform a step or continue running.

To continue running from the current PC address, click the [Go] toolbar button () or choose [Debug->Go].

To continue running from a specified address which is not the stop address, change the PC value in one of the following ways, and click the [Go] toolbar button () or choose [Debug->Go].

- Change the PC value in the [Register] window. Refer to section 5.4.3, Modifying Register Contents.
- Place the text cursor (not the mouse cursor) to a target line in the [Source] or [Disassembly] window, and choose [Set PC Here] from the popup menu.

5.11.3 Running to the Cursor

Sometimes as you are going through your application you may want to run only a small section of code, that would require many single steps to execute. You can do this using the Go To Cursor feature.

☞ How to use the Go To Cursor

1. Make sure that a [Source] or [Disassembly] window is open showing the address at which you wish to stop.
2. Position the text cursor on the address at which you wish to stop by either clicking in the [Address] field or using the cursor keys.
3. Choose [Go To Cursor] from the popup menu.

The debugging platform will run your code from the current PC value until it reaches the address indicated by the cursor's position.

- Notes:
1. If your program never executes the code at this address, the program will not stop. If this happens, code execution can be stopped by pressing the Esc key, choosing [Debug->Halt], or clicking on the [Halt] toolbar button ().
 2. The Go To Cursor feature requires a PC breakpoint - if you have already used all those available, then the feature will not work.

5.11.4 Running from a Specified Address

The [Run Program] dialog box allows the user to run the program from any address. Choose [Debug -> Run...] to open the [Run Program] dialog box.

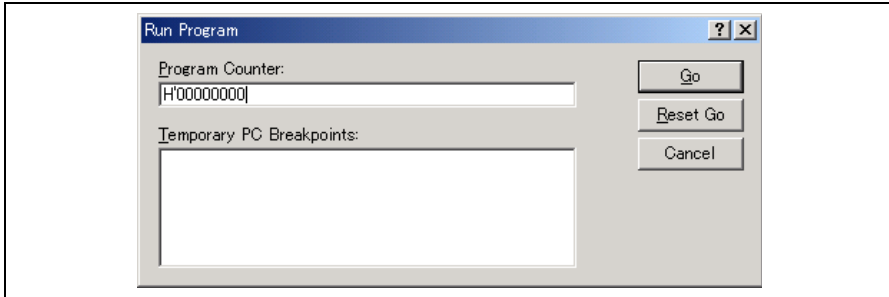

Figure 5.44 [Run Program] Dialog Box

The following execution conditions can be specified in this dialog box:

[Program Counter]: Instruction address to start execution. The initial value is the current PC value.

[Temporary PC Breakpoints]: A temporary PC breakpoint. When execution started by this dialog box stops, this breakpoint is cleared.

Note: The [Temporary PC Breakpoints] feature requires a PC breakpoint - if you have already used all those available then the feature will not work.

Clicking the [Go] button starts execution according to the settings. Clicking the [Reset Go] button starts execution from the reset vector. Clicking the [Cancel] button closes this dialog box without executing instructions.

5.11.5 Single Step

To debug your code it is very useful to be able to step a single line or instruction at a time and examine the effect of that instruction on the system. In the [Source] window, then a step operation will step a single source line. In the [Disassembly] window, a step operation will step a single assembly-language instruction. If the instruction calls another function or subroutine, you have the option to either step into or step over the function. If the instruction does not perform a call, then either option will cause the debugger to execute the instruction and stop at the next instruction.

- **Stepping Into a Function**

If you choose to step into the function the debugger will execute the call and stop at the first line or instruction of the function. To step into the function either click the [Step In] toolbar button () , or choose [Debug->Step In].

- **Stepping Over a Function Call**

If you choose to step over the function the debugger will execute the call and all of the code in the function (and any function calls that that function may make) and stop at the next line or instruction of the calling function. To step over the function either click the [Step Over] toolbar button () , or choose [Debug->Step Over].

- **Stepping Out of a Function**

There are occasions when you may have entered a function, finished stepping through the instructions that you want to examine and would like to return to the calling function without tediously stepping through all the remaining code in the function. Or alternatively you may have stepped into a function by accident, when you meant to step over it and so want to return to the calling function without stepping all the way through the current function. You can do this with the Step Out feature.

To step out of the current function either click the [Step Out] toolbar button () , or choose [Debug->Step Out].

5.11.6 Multiple Steps

You can step several instructions at a time by using the [Step Program] dialog box. The dialog box also provides an automated step with a selectable delay between steps. Open it by choosing [Debug-> Step...].

The [Step Program] dialog box is displayed:

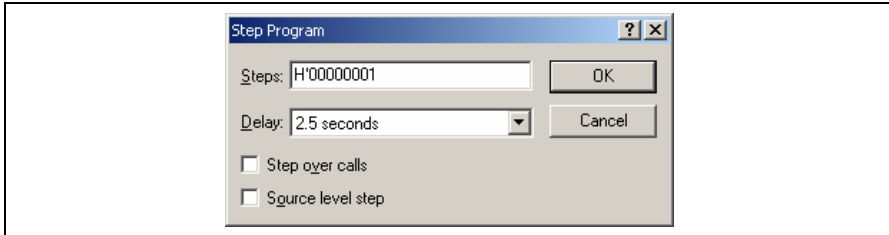



Figure 5.45 [Step Program] Dialog Box

- [Steps]: Number of steps to be executed.
- [Delay (seconds)]: Delay between steps when the program is automatically stepped.
0 to 3 seconds can be selected in 0.5 second units.
- [Step Over Calls]: Selecting this box steps over function calls.
- [Source Level Step]: Selecting this box steps the program at the source level.
- Clicking the [OK] button or pressing the [Enter] key starts step execution.

5.12 Stopping Your Program

This section describes how you can halt execution of your application's code. This section describes how to do this directly by using the [Halt] button and by setting breakpoints at specific locations in your code.

5.12.1 Stopping the Program by the [Halt] Toolbar Button

When your program is running, the [Halt] toolbar button is enabled () (a red STOP sign), and when the program has stopped it is disabled () (the STOP sign is grayed out). Click on the [Halt] toolbar button, or choose [Debug->Halt Program].

When the program has been stopped by [Halt], "User Break" is displayed in the [Debug] sheet of the [Output] window.

5.12.2 Standard Breakpoints (PC Breakpoints)

When you are trying to debug your program you will want to be able to stop the program running when it reaches a specific point or points in your code. You can do this by setting a PC breakpoint on the line or instruction at which to want the execution to stop. The following instructions will show you how to quickly set and clear simple PC breakpoints. If more complex breakpoint operation is required, use the [Event] window, which can be opened by clicking the () button or choosing [View -> Code -> Eventpoints]. For details, refer to section 5.15, Using the Event Points.

- To set a PC breakpoint in the [Source] window
 1. Make sure that the [Disassemble] or a [Source] window is open at the place you want to set a PC breakpoint.
 2. Choose [Toggle Breakpoint] from the popup menu, or press F9, at the line showing the address at which you want the program to stop.
 3. You will see a red circle appear in the gutter to indicate that a PC breakpoint has been set.
 4. The current breakpoint set can be enabled or disabled by using [Enable/Disable Breakpoint] in the popup menu.

Now when you run your program and it reaches the address at which you set the PC breakpoint, execution halts with the message "PC Break" displayed in the [Debug] sheet of the [Output] window, and the [Source] or [Disassembly] window is updated with the PC breakpoint line marked with an arrow in the gutter.

Note: When a break occurs, the program stops just before it is about to execute the line or instruction at which you set a program PC breakpoint. If you choose Go or Step after stopping at the PC breakpoint, then the line marked with an arrow will be the next instruction to be executed.

- To set a PC breakpoint by using the [Breakpoints] dialog box
Selecting [Edit -> Source Breakpoint...] displays the [Breakpoints] dialog box.

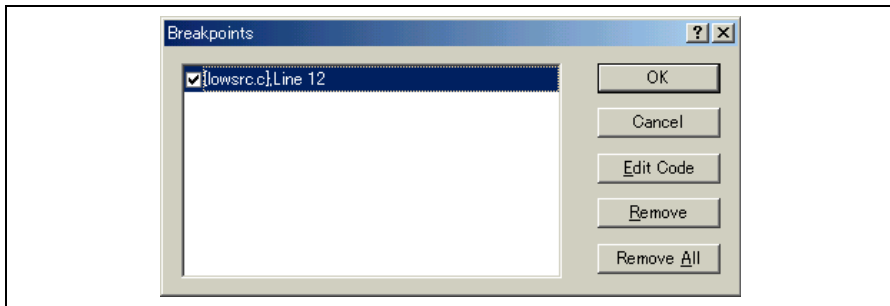

Figure 5.46 [Breakpoints] Dialog Box

The [Breakpoints] dialog box allows the user to view the current breakpoints set. Clicking the [Edit Code] button displays the source where each breakpoint is set. The [Remove] or [Remove All] button deletes one or all breakpoints, respectively. The check box of each breakpoint enables or disables the breakpoint.

- To toggle PC breakpoints
It is possible to toggle the [PC Breakpoints] setting by either double-clicking in the [BP] column of the line where the PC breakpoint is set or placing the cursor on the line and pressing the [F9] key. The setting to be toggled depends on the debugging platform.

5.13 Elf/Dwarf2 Support

The HEW supports the Elf/Dwarf2 object file format for debugging applications written in C/C++ and assembly language for Renesas microcomputers.

Key Features

- Source level debugging
- C/C++ operators
- C/C++ expression (casting, pointers, references, etc.)
- Ambiguous function names
- Overlay memory loading
- Watch - locals, and user defined
- Stack Trace

5.13.1 C/C++ Operators

The C/C++ language operators are available:

`+, -, *, /, &, |, ^, ~, !, >>, <<, %, (,), <, >, <=, >=, ==, !=, &&, ||`

```
Buffer_start + 0x1000
#R1 | B'10001101
((pointer + (2 * increment_size)) & H'FFFF0000) >> D'15
!(flag ^ #ER4)
```

5.13.2 C/C++ Expressions

Expression Examples

<code>Object.value</code>	<code>//Specifies direct reference of a member (C/C++)</code>
<code>p_Object->value</code>	<code>//Specifies indirect reference of a member (C/C++)</code>
<code>Class::value</code>	<code>//Specifies reference of a member with class (C++)</code>
<code>*value</code>	<code>//Specifies a pointer (C/C++)</code>
<code>&value</code>	<code>//Specifies a reference (C/C++)</code>
<code>array[0]</code>	<code>//Specifies an array (C/C++)</code>
<code>Object.*value</code>	<code>//Specifies reference of a member with pointer (C++)</code>
<code>::g_value</code>	<code>//Specifies reference of a global variable (C/C++)</code>
<code>Class::function(short)</code>	<code>//Specifies a member function (C++)</code>
<code>(struct STR) *value</code>	<code>//Specifies cast operation (C/C++)</code>

5.13.3 Supporting Duplicate Labels

In some languages, for example C++ overloaded functions, a label may represent more than one address. When such a label name is entered in a dialog box, the HEW will display the [Select Function] dialog box to display overloaded functions and member functions.

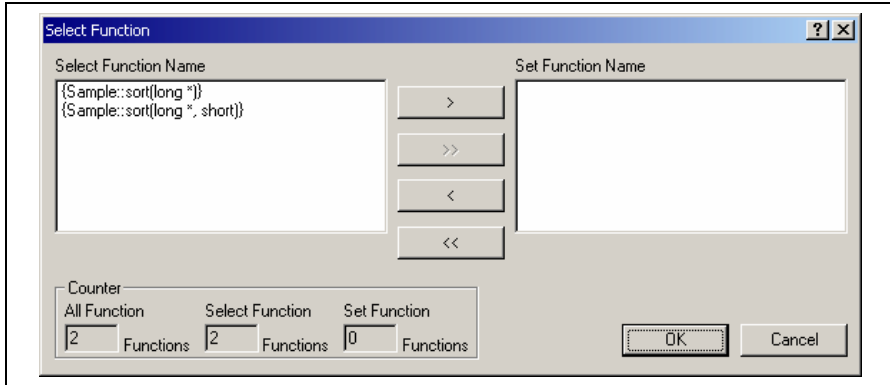

Figure 5.47 [Select Function] Dialog Box

Select overloaded functions or member functions in the [Select Function] dialog box. Generally, one function can be selected at one time; only for setting breakpoints, multiple functions can be selected. This dialog box has three areas.

[Select Function Name]: Displays the same-name functions or member functions and their detailed information.

[Set Function Name]: Displays the function to be set and their detailed information.

[Counter]:

[All Function]	Displays the number of same-name functions or member functions.
[Select Function]	Displays the number of functions displayed in the [Select Function Name] list box.
[Set Function]	Displays the number of functions displayed in the [Set Function Name] list box.

Selecting a Function

Click the function you wish to select in the [Select Function Name] list box, and click the [>] button. You will see the selected function in the [Set Function Name] list box. To select all functions in the [Select Function Name] list box, click the [>>] button.

Deselecting a Function

Click the function you wish to deselect from the [Set Function Name] list box, and click the [<] button. To deselect all functions, click the [<<] button. The deselected function will be moved from [Set Function Name] list box back to the [Select Function Name] list box.

Setting a Function

Click the [OK] button to set the functions displayed in the [Set Function Name] list box. The functions are set and the [Select Function] dialog box closes.

Clicking the [Cancel] button closes the dialog box without setting the functions.

5.13.4 Debugging an Overlay Program

This section explains the settings for using the overlay functions.

Displaying Section Group

When the overlay mode is used, that is, when several section groups are assigned to the same address range, the address ranges and section groups are displayed in the [Overlay] dialog box.

Open the [Overlay] dialog box by choosing [Memory->Configure Overlay].

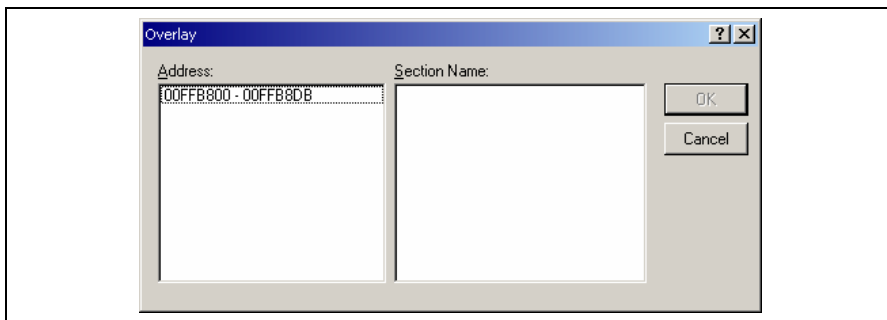

Figure 5.48 [Overlay] Dialog Box (at Opening)

This dialog box has two areas: the [Address] list box and the [Section Name] list box.

The [Address] list box displays the address ranges used in the overlay mode. Click to select one of the address ranges in the [Address] list box.

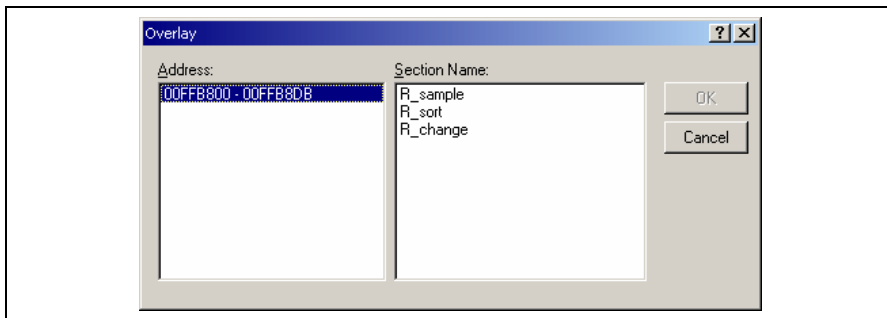

Figure 5.49 [Overlay] Dialog Box (Address Range Selected)

The [Section Name] list box displays the section groups assigned to the selected address range.

➡ Setting section group

When using the overlay function, the highest-priority section group must be selected in the [Overlay] dialog box; otherwise the HEW will operate incorrectly.

First click one of the address ranges displayed in the [Address] list box. The section groups assigned to the selected address range will then be displayed in the [Section Name] list box.

Click to select the section group with the highest-priority among the displayed section groups.

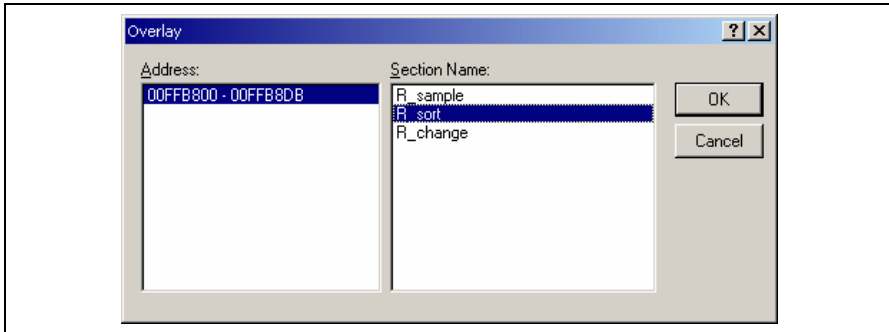

Figure 5.50 [Overlay] Dialog Box (Highest-Priority Section Group Selected)

After selecting a section group, clicking the [OK] button stores the priority setting and closes the dialog box. Clicking the [Cancel] button closes the dialog box without storing the priority setting.

Note: Within the address range used by the overlay function, the debugging information for the section specified in the [Overlay] dialog box is referred to. Therefore, the same section of the currently loaded program must be selected in the [Overlay] dialog box.

5.14 Viewing the Variables

This section describes how you can look at variables in the source program.

5.14.1 Tooltip Watch

The quickest way to look at a variable in your program is to use the Tooltip Watch feature.

➡ To use Tooltip Watch:

Open the [Source] window showing the variable that you want to examine.

Rest the mouse cursor over the variable name that you want to examine - a tooltip will appear near the variable containing basic watch information for that variable.

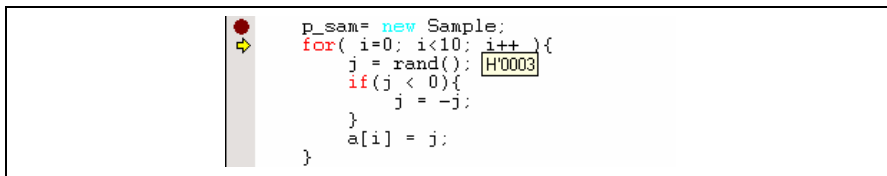

Figure 5.51 Tooltip Watch

5.14.2 Instant Watch

Open the [Source] window showing the variable that you want to examine.

Rest the mouse cursor over the variable name that you want to examine and choose [Instant Watch...] from the popup menu; the [Instant Watch] dialog box will appear and display the variable at the cursor location.

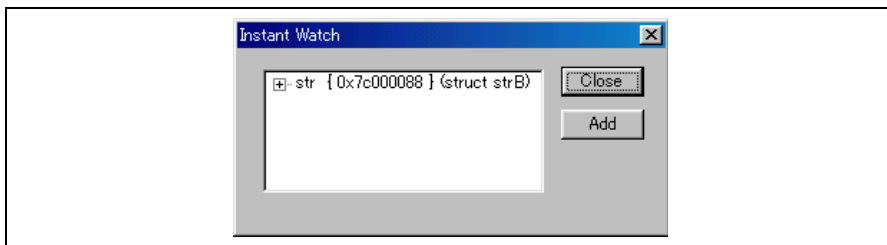



Figure 5.52 [Instant Watch] Dialog Box

“+” shown to the left of the variable name indicates that the information may be expanded by clicking on the variable name, and “-” indicates that the information may be collapsed. Clicking [Add] registers the variable in the [Watch] window. Clicking [Close] closes the window without registering the variable in the [Watch] window.

5.14.3 [Watch] Window

You can view any value in the [Watch] window.

Opening a [Watch] Window

To open a [Watch] window, choose [View->Symbol->Watch] or click on the [Watch] toolbar button () if it is visible. A [Watch] window opens. Initially the contents of the window will be blank.

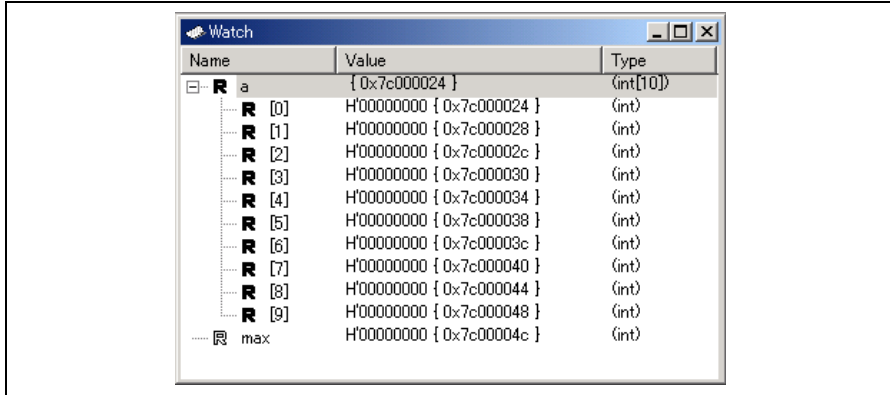

Figure 5.53 [Watch] Window

This window allows the user to view and modify C/C++-source level variables. The contents of this window are displayed only when the debugging information available in the absolute file (*.abs) includes the information on the C/C++ source program. The variable information is not displayed if the source program information is excluded from the debugging information during optimization by the compiler. In addition, the variables that are declared as macro cannot be displayed.

The following items are displayed.

- [Name]: Name of the variable
- [Value]: Value and assigned location.
The assigned location is enclosed by { }.
- [Type]: Type of the variable

The [R] mark shows that the value of the variable can be updated during user program execution.

For updating of the content of the variable that has been registered in the [Watch] window, there are the following three methods:

1. Use the Monitor function without halting the user program

The read/write signal of the MCU is set as a trigger and holds the address bus and data bus values to update the value of the variable.

Note: Although the realtime operation is retained, the size and number points to be monitored are limited. For the Monitor function, refer to section 5.9, Displaying Memory Contents in Realtime.

2. Read the memory content directly from the HEW to update the values without halting the user program since the bus mastership is owned by the emulator

Note: While the emulator reserves the bus mastership, the realtime operation is disabled because the CPU stops operation. This method is only available for accessing the on-chip ROM, on-chip RAM, and emulation memory.

The area used here or this method may not be available depending on the emulator in use. For details, refer to section 8, Software Specifications Specific to This Product, or [Enable read and write on the fly] on the [General] page of the [Configuration Properties] dialog box in the online help.

3. Temporarily stops the user program and reads the memory contents

Note: The realtime operation is disabled because the user program is stopped temporarily. This method is only available for accessing the areas (on-chip I/O, DTCRAM, and user memory) other than those in item 2 mentioned above.

It is possible to recognize the method for updating the value during user program execution according to the color of the [R] mark.

Blue-outline [R]: The variable's address is within the range that has been set for the monitoring function and the data is readable by using the monitoring function.

Blue [R]: An updated value of the data at this location has been read by the monitoring function.

Black-outline [R]: The variable's address is outside the range that has been set for the monitoring function and the data is not readable by using the monitoring function.

Black [R]: A value has been updated by reading the normal data.

- Notes:
1. This function can be set per variable or per element or body for structures of data.
 2. The color of an [R] in the [Name] column changes according to the trace and monitoring settings.
 3. A variable that is allocated to a register cannot be selected for monitoring.

Adding a Watch Item

Use the [Add Watch] dialog box in the [Watch] window to add Watch items to the [Watch] window.

➔ To use Add Watch from a [Watch] window:

Open the [Watch] window.

Choose [Add Watch] from the popup menu.

The [Add Watch] dialog box opens:

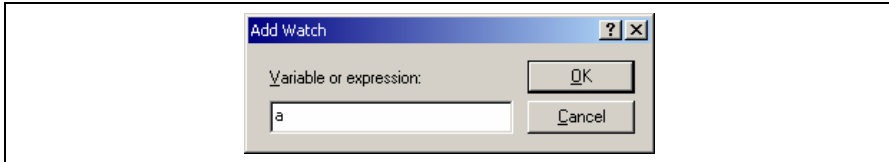

Figure 5.54 [Add Watch] Dialog Box

Enter the name of the variable that you wish to watch and click [OK]. The variable is added to the [Watch] window. A variable can be dragged from the [Source] window and dropped into the [Watch] window.

Note: If the variable that you have added is a local variable that is not currently in scope, the HEW will add it to the [Watch] window but its value will be 'Not available now'.

Expanding a Watch Item

If a watch item is a pointer, array, or structure, then you will see a plus sign (+) expansion indicator to left of its name, this means that you can expand the watch item. To expand a watch item, double click on it. The item expands to show the elements (in the case of structures and arrays) or data value (in the case of pointers) indented by one tab stop, and the plus sign changes to a minus sign (-). If the elements of the watch item also contain pointers, structures, or arrays then they will also have expansion indicators next to them.

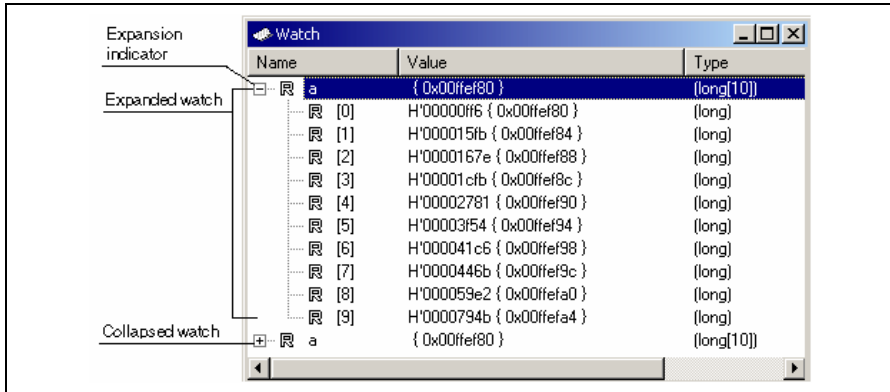

Figure 5.55 Expanding a Watch Item

To collapse an expanded watch item, double click on the item again. The item's elements will collapse back to the single item and the minus sign changes back to a plus sign.

The watch item can be expanded for the number of levels when a numerical key from 1 to 9 is pressed while a watch item is selected.

Editing a Watch Item's Value

You may wish to change the value of a watch variable, e.g. for testing purposes or if the value is incorrect due to a bug in your program. To change a watch item's value use the Edit Value function.

➔ Editing a watch item's value:

Enter a value directly in the window.

In another way, select the item to edit by clicking on it, you will see a flashing cursor on the item.

Choose [Edit Value] from the popup menu.

The [Edit Value] dialog box opens:

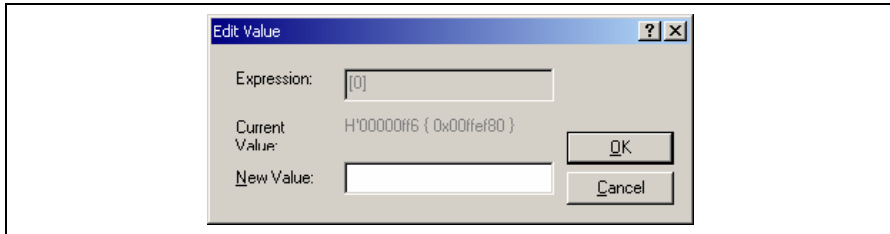

Figure 5.56 [Edit Value] Dialog Box

Enter the new value or expression in the [New Value] field and click [OK]. The [Watch] window is updated to show the new value.

Deleting a Watch Item

To delete a watch item, select it and choose [Delete] from the popup menu. The item is deleted and the [Watch] window is updated.

To delete all watch items, choose [Delete All] from the popup menu. All items are deleted and the [Watch] window is updated.

Specifying Realtime Update

The R mark shown to the left of each variable indicates whether the variable is updated in real time. When an R mark is displayed in bold face, the value of the corresponding variable will be updated in realtime during user program execution.

A popup menu containing the following options is available in the [Watch] window:

- Auto Update
Marks the selected variable with a bold R and updates the variable in real time.
- Auto Update All
Marks all variables with bold Rs and updates all variables in real time.
- Delete Auto Update
Marks the selected variable with an outlined R and cancels realtime update.
- Delete Auto Update All
Marks all variables with outlined Rs and cancels realtime update.

Modifying the Radix

The radix for the selected variable display can be modified by choosing [Radix] from the popup menu.

Saving the [Watch] Window Contents in a File

To save the contents of the [Watch] window, choose [Save As...] from the popup menu; the Save As dialog box opens. It allows the user to specify the name of a file and to save the contents of the [Watch] window in the file. If the [Append] check box is selected, the window contents are appended to the existing file, and if it is not selected, the existing file is overwritten.

Opening a [Memory] Window

The contents of the memory area to which the selected variable is assigned can be displayed in the [Memory] window. Choose [Go To Memory...] from the popup menu; the [Set Address] dialog box opens, showing the information (start address, end address, and size) of the selected variable as default. Clicking [OK] opens the [Memory] window.

5.14.4 [Locals] Window

The local variables and their values can be displayed in the [Locals] window.

Opening the [Locals] Window

To open the [Locals] window, choose [View->Symbol->Locals] or click the [Locals] toolbar button ().

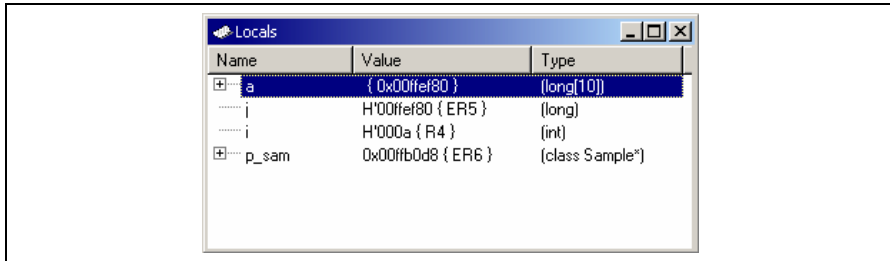

Figure 5.57 [Locals] Window

If a local variable is not initialized when defined, then the value of the local variable will be incorrect until another value is assigned to the local variable.

The local variable values and the radix for local variable display can be modified in the same manner as in the [Watch] window.

5.15 Using the Event Points

The emulator has the event point function that performs breaking, tracing, and execution time measurement by specifying higher-level conditions along with the PC breakpoints standard for the HEW.

5.15.1 PC Breakpoints

When the instruction of the specified address is fetched, the user program is stopped. Up to 256 points can be set.

Note that, however, only one PC breakpoint can be set in the ROM area of the user system. This particular breakpoint is called the on-chip breakpoint, which stops the user program after executing the instruction of the specified address.

When it is necessary to set two or more PC breakpoints to the external ROM area of the user system, allocate this area to the emulation memory, copy the code, and then set the PC breakpoints.

5.15.2 Event Points

Event points can be used for higher-level conditions such as the data condition as well as specification of the single address. Up to 12 event points can be set by using event channels and range channels in the event detection system.

When the condition is satisfied, event points are also used as the start/end conditions for execution time measurement or trace acquisition in addition to halting the user program. Several event points can be used to set more complex conditions.

Note: Event points acquire the data, test conditions, and execute an action (such as halting the user program) by the hardware circuit of the emulator. Therefore, a delay of several cycles will occur from the satisfaction of the condition to the execution of an action.

5.15.3 Event Detection System

In addition to the 4 range channels, the emulator also has 8 event channels. The event channels have more functions (such as sequencing or counting) than the range channels.

Event Channels (Ch1 to Ch8):

The emulator has 8 event channels. The event channel can be defined as a combination of one or more of the followings:

- An address or an address range
- Outside of an address range
- A read, a write, or either
- Data with a mask specification
- Bus state
- Area
- The value of four external probe signals
- The number of times the event has occurred
- The number of delay cycles after the event has occurred

A maximum of eight points can be used as a combination in a sequence. The emulator is activated or halted by an occurrence of the previous event in each sequence.

Range Channels (Ch9 to Ch12):

The emulator has 4 range channels. The range channel can be defined as a combination of one or more of the followings:

- An address or an address range
- Outside of an address range
- A read, a write, or either
- Data with a mask specification
- Bus state
- Area
- The value of four external probe signals
- The number of delay cycles after the event has occurred

5.15.4 Signals to Indicate Bus States and Areas

In the event detection system, signals indicating the MCU's bus states and the accessed areas can be specified as the event detection condition.

These signals are output from the MCU on the emulator; the signals to be acquired will vary according to the emulator in use.

The signals to indicate bus states and areas are used to set the [Bus/Area] condition of the event point. They can also be acquired as the trace information.

The bus state signals are also used to set the condition not to acquire the trace ([Suppress] option) and in the Access Count Of Specified Range Measurement mode for measuring the hardware performance ([Access Type] option).

For the trace function, refer to section 5.16, Viewing the Trace Information. For the hardware performance function, refer to section 5.20, Analyzing Performance.

The following tables show examples of signals to indicate the bus states and areas that can be acquired by the emulator.

Table 5.1 Bus State Signals Acquired by the Emulator

Bus State	Trace Display (Status)	Description
CPU Prefetch	PROG	CPU prefetch cycles
CPU Data	DATA	CPU data access cycles
Refresh	REFRESH	Refresh cycles
DMAC	DMAC	DMAC cycles
DTC	DTC	DTC cycles
Other	OTHER	Others

Table 5.2 Area Signals Acquired by the Emulator

Area	Trace Display (Status)	Description
On-chip ROM	ROM	ROM
On-chip RAM	RAM	RAM
On-chip I/O 16bit	I/O-16	16-bit I/O
On-chip I/O 8bit	I/O-8	8-bit I/O
External I/O 16bit	EXT-16	16-bit EXT (external)
External I/O 8bit	EXT-8	8-bit EXT (external)
DTC RAM	RAM/DTC	DTCRAM

Note: The signals to indicate the bus states and areas vary according to the emulator in use. For details, refer to section 8, Software Specifications Specific to This Product, or the online help.

5.15.5 Opening the [Event] Window

Select [View -> Code -> Eventpoints] or click the [Eventpoints] toolbar button  to open the [Event] window.

The [Event] window has the following three sheets:

[Breakpoint] sheet: Displays the settings made for PC breakpoints. It is also possible to set, modify, and cancel PC breakpoints.

[Event] sheet: Displays or sets event points.

[Trigger] sheet: Displays or sets trigger points.

5.15.6 Setting PC Breakpoints

It is possible to display, modify, and add PC breakpoints on the [Breakpoint] sheet.

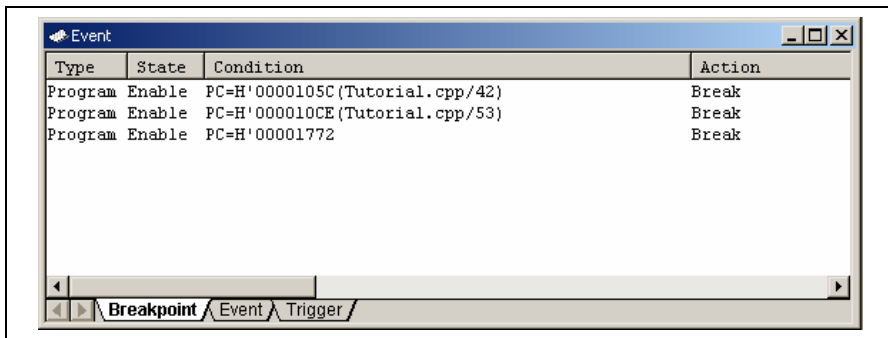

Figure 5.58 [Event] Window ([Breakpoint] Sheet)

Select [Add...] or the PC breakpoint displayed in this window and then select [Edit...] from the popup menu to display the [Breakpoint/Event Properties] dialog box.

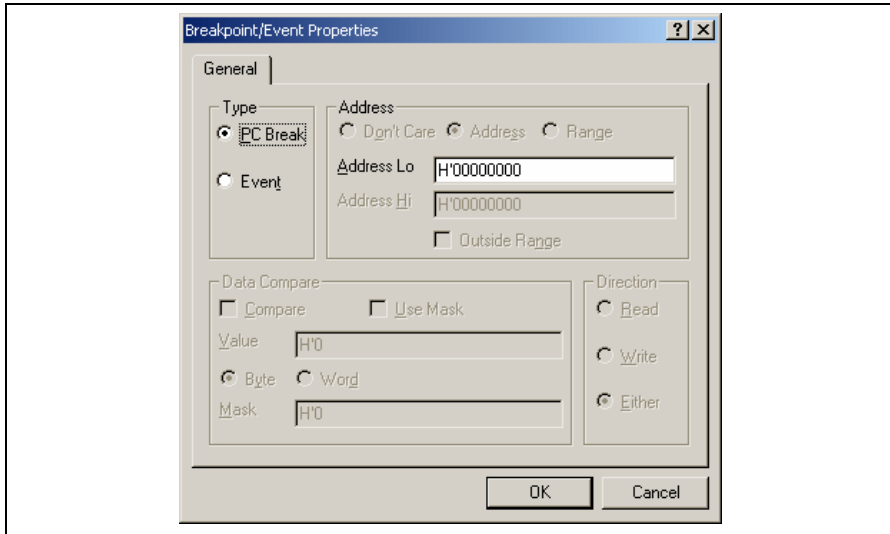

Figure 5.59 [Breakpoint/Event Properties] Dialog Box (Setting a PC Break)

In this dialog box, select the address condition to set PC breakpoints.

[Type]: Select the type of a breakpoint. Note that the [Breakpoint/Event Properties] dialog box is used for setting PC breakpoints and event points. Selecting a particular type of breakpoint enables or disables other pages and parts of the dialog according to the options available to that type of breakpoint.

[PC Break]: Only a single address with a program fetch can be selected. Other options are invalid.

[Event]: Set conditions in detail with other options on this page, or on the [Bus/Area], [Signals], or [Action] page.

[Address]: Set address conditions.

[Address Lo]: Select a single address where a PC breakpoint will be set.

5.15.7 Setting Event Points

On the [Event] sheet, the settings for event points are displayed, modified, and added.

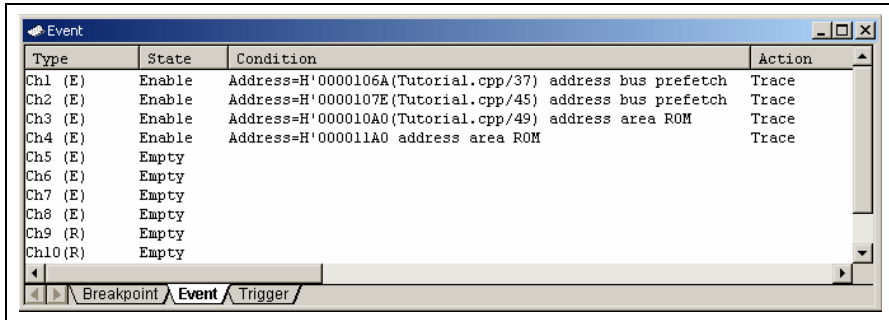

Figure 5.60 [Event] Window ([Event] Sheet)

Select [Add...] or the event point displayed in this window and then select [Edit...] from the popup menu to display the [Breakpoint/Event Properties] dialog box.

The conditions for the event point are set on the [General], [Bus/Area], [Signals], and [Action] pages. The search condition for the event point is set by multiple conditions set on these pages.

- Notes:
1. Channel 8 has the trigger output function. When the condition on channel 8 is satisfied, the low-level signal will be output from the external probe 1 (EXT1) for a bus cycle.
 2. When the event point is used as the condition for acquiring the trace information, select [Trace Acquisition...] from the popup menu. For the trace function, refer to section 5.16, Viewing Trace Information.
 3. If a condition that is unavailable for a range channel is set in editing of the range channels (Ch9 to Ch12), the selected channel is automatically replaced by an unused event channel (Ch1 to Ch8).

Table 5.3 Conditions Unavailable for a Range Channel

Condition	Related Options
Selecting outside the specified address range	[Outside Range] on the [General] page
Selecting the start or end of the execution time measurement	[Start Timer] and [Stop Timer] on the [Action] page
Specifying the count when an event occurs (twice or more)	[Required number of event occurrences] on the [Action] page
Specifying sequencing	[Enable Sequencing] on the [Action] page

(1) [General] page

The address and data conditions are set.

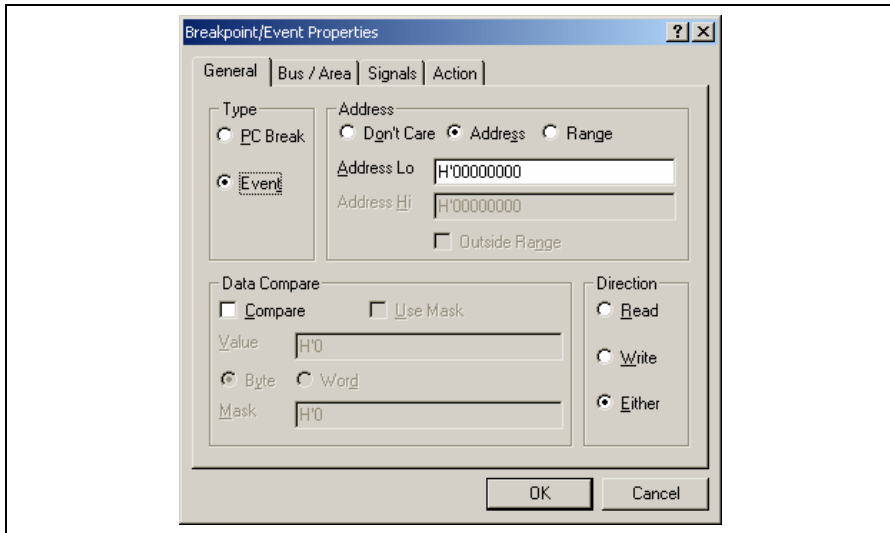

Figure 5.61 [Breakpoint/Event Properties] Dialog Box ([General] Page)

[Type]: Select the type of a breakpoint. Note that the [Breakpoint/Event Properties] dialog box is used for setting PC breakpoints and event points. Selecting a particular type of breakpoint enables or disables other pages and parts of the dialog according to the options available to that type of breakpoint.

[PC Break]: Only a single address with a program fetch can be selected. Other options are invalid.

[Event]: Set conditions in detail with other options on this page, or on the [Bus/Area], [Signals], or [Action] page.

[Address]: Sets the address condition.

[Don't care]: Sets no address condition.

[Address]: Allows a single address to be selected.

[Range]: Allows an address range to be selected.

[Address Lo]: Set a single address or the start of an address range (available when [Address] or [Range] has been selected).

[Address Hi]: Set the end of an address range (available when [Range] has been selected).

[Outside Range]: Used to negate the range (i.e., the event will occur when the address is outside the range). This is available when [Address] or [Range] has been selected.

[Data Compare]: Sets the data condition.

- [Compare]: Checking this box compares data.
- [Use Mask]: Sets a mask condition (available when [Compare] has been selected).
- [Value]: Specifies the data bus value as numerics. The size of data for access can also be selected (available when [Compare] has been selected).
- [Byte]: Sets access in bytes as the condition (available when [Compare] has been selected).
- [Word]: Sets access in words as the condition (available when [Compare] has been selected).
- [Mask]: Sets a value to be masked. This value will be ANDed with the value of the data bus and data condition. The result will be used to compare data (available when [Use Mask] has been selected).
- [Direction]: Selects a condition with read or write cycles.
- [Read]: Sets read cycles as the condition.
- [Write]: Sets write cycles as the condition.
- [Either]: Sets either read or write cycles as the condition.

(2) [Bus/Area] page

Use this page to set the bus status and the memory area being accessed.

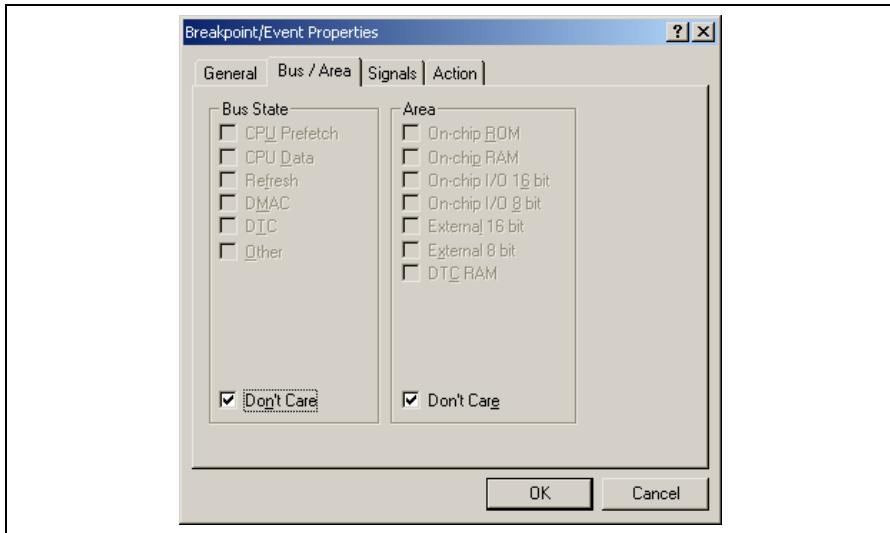

Figure 5.62 [Breakpoint/Event Properties] Dialog Box ([Bus/Area] Page)

[Bus State]: Sets the bus status as the condition. When the [Don't care] check box is checked, the event will be satisfied with any bus status.

[Area]: Specifies the area for searching. When the [Don't care] check box is checked, the event will be satisfied in any area.

Note: Items set for the bus state and memory access area vary according to the emulator in use. For details, refer to section 5.15.4, Signals to Indicate Bus States and Areas.

(3) [Signals] page

Use this page to set external signals.

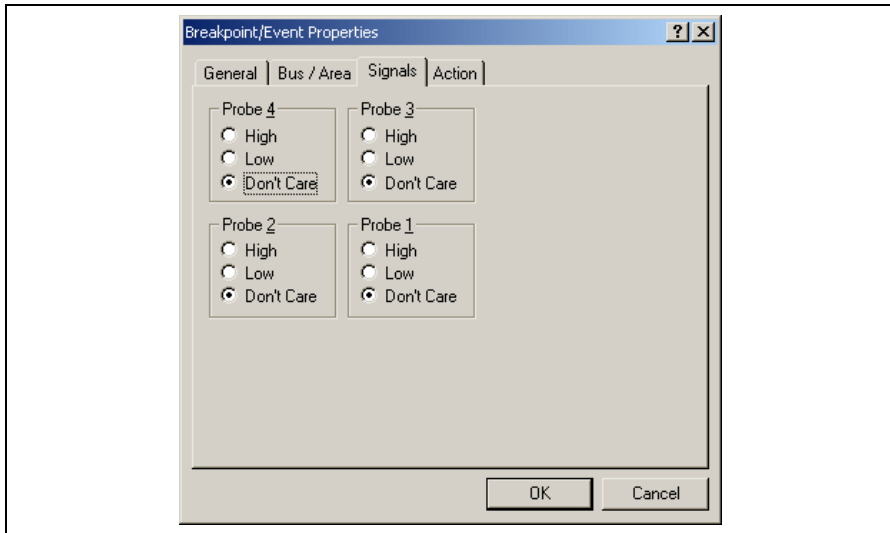

Figure 5.63 [Breakpoint/Event Properties] Dialog Box ([Signals] Page)

- [Probe4]: Detects the status of the input probe signal 4
 - [High]: Detects the high level of the input probe signal
 - [Low]: Detects the low level of the input probe signal
 - [Don't care]: The status of the input probe signal is not detected
- [Probe3]: Detects the status of the input probe signal 3
 - [High]: Detects the high level of the input probe signal
 - [Low]: Detects the low level of the input probe signal
 - [Don't care]: The status of the input probe signal is not detected
- [Probe2]: Detects the status of the input probe signal 2
 - [High]: Detects the high level of the input probe signal
 - [Low]: Detects the low level of the input probe signal
 - [Don't care]: The status of the input probe signal is not detected

- [Probe1]: Detects the status of the input probe signal 1
- [High]: Detects the high level of the input probe signal
- [Low]: Detects the low level of the input probe signal
- [Don't care]: The status of the input probe signal is not detected

(4) [Action] page

Use this page to decide what action the emulator takes when the defined event occurs.

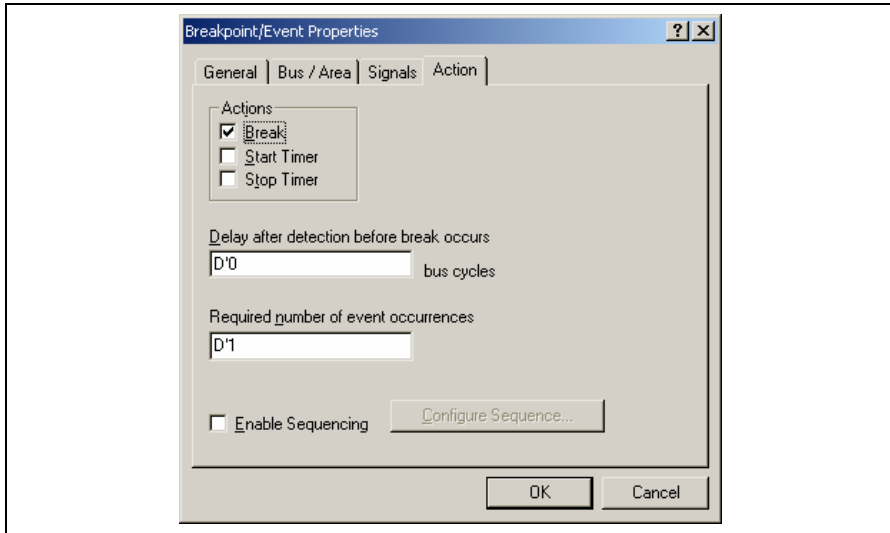

Figure 5.64 [Breakpoint/Event Properties] Dialog Box ([Action] Page)

- [Action]: Selects an action that occurs when the event is satisfied. This cannot be used for an event point being used as the trace acquisition condition.
- [Break]: Causes a break (stop) in the user program when the event occurs. This is the default action.
- [Start Timer]: Starts the run timer (the run timer value is displayed in the [Status] window).
- [Stop Timer]: Stops the run timer (the run timer value is displayed in the [Status] window).

[Delay after detection before break occurs]: Sets a 16-bit delay (in bus cycles) after the event has occurred before the action is taken. The delay is only applicable to break events and there is only one delay counter in hardware, therefore only one breakpoint can have a non-zero delay. The range of values is D'0 to D'65,535 (only available when [Break] has been selected). This cannot be used for an event point being used as the trace acquisition condition.

[Required number of event occurrences]: Allows a 16-bit pass count to be set. The event must occur the specified number of times before the action is taken. The range of values is D'0 to D'65,535.

- [Enable Sequencing]: Allows the event to take part in a sequence of events (setting this requires the event to use an event detector).
- [Configure Sequence...]: Displays the [Event Sequencing] dialog box to allow the event sequencing to be configured (only available when [Enable Sequencing] has been selected).

(5) [Event Sequencing] dialog box

This dialog box allows the user to define which events are triggered by other events. If this dialog box is accessed (directly or indirectly) from [Trace Acquisition...], only those events assigned to the trace subsystem are displayed. If accessed from the [Eventpoint] window, only the breakpoint or timer events are shown.

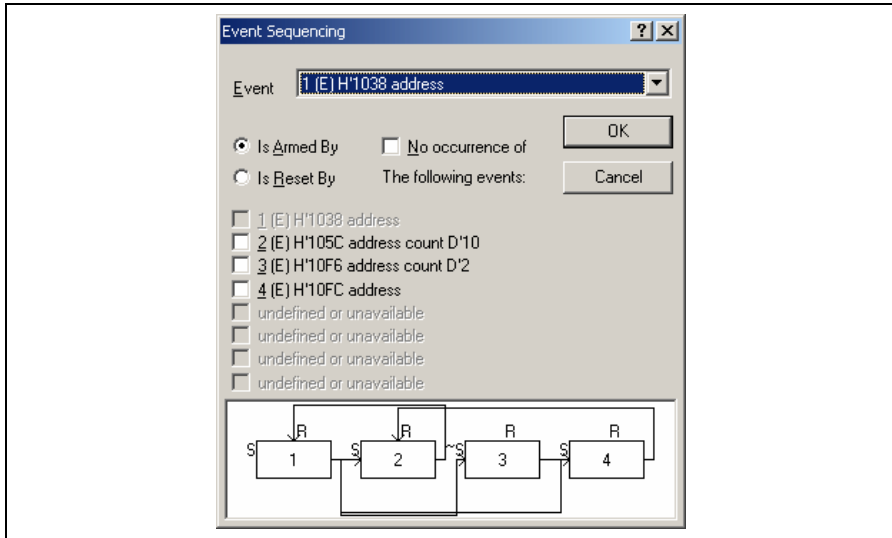

Figure 5.65 [Event Sequencing] Dialog Box

- [Event]: Selects an event point to be set.
- [Is Armed By]: Arms the selected event.
- [Is Reset By]: Resets the selected event.
- [No occurrence of]: Arms an event when the set of events being selected does not occur (only available when [Is Armed By] has been selected).

The test of conditions on event points is started with the execution of the user program. The conditions on event points have not been satisfied immediately after the execution of the user program is started.

Satisfaction of the condition on an event point allows a transition of the state to that where the condition is satisfied.

The state where the condition is satisfied is retained until the user program is stopped or the event point is reset.

When the condition on the event point is satisfied, no action will be taken even if the condition is satisfied again. If you want the action to be taken again, reset the event point so that the state transits to that where no condition is satisfied.

When the user program is stopped, the states of all the event points transit to that where no condition is satisfied.

When an event point must be in the state where its condition is satisfied or not (when [No occurrence of] is selected) as the satisfaction condition of another event point, this event point is called the arm event.

An event point can reset the tested states of conditions of other event points or itself by satisfying the condition. This event point is called a reset event.

A reset event resets event points regardless of their states where the condition is satisfied or not (e.g., resetting the pass count).

Select an event point from the [Event] combo box. To set an arm event on the selected event point, select [Is Armed By] and check the box corresponding to each event. The [No occurrence of] check box is used to set a condition that the arm event is in the state where its condition is not satisfied.

To set a reset event on the selected event point, select [Is Reset By] and check the box corresponding to each event.

At the bottom of the screen is a diagram showing the current sequencing of the events (figure 5.64). The S input sets (arms) an event and the R input resets it. The legend ~S indicates the event is set (armed) by the non-occurrence of the input events.

Figure 5.64 is an example that Ch1 is the arm event for Ch2, Ch3, and Ch4. Ch3 is the arm event for Ch4. Ch2 and Ch4 are the reset events for Ch1 and Ch2, respectively.

To satisfy the condition of the event point having an arm event, the arm event must be in the state where the condition is satisfied or not (when [No occurrence of] is selected). When multiple arm events exist on one event point, one of the arm events must be in the state where the condition is satisfied or not (when [No occurrence of] selected) to satisfy the condition of the event point.

As the condition of the arm event on one event point, either of the states where the condition is satisfied or not should be set.

To reset an event point with a reset event, the condition of the reset event must be satisfied. While the condition of the reset point is satisfied, no event point is reset even if the condition of the reset event is satisfied again.

When multiple reset events exist on one event point, the event point is reset when the condition of one of reset events is satisfied.

5.15.8 Setting Trigger Points

The trigger point is an event to output a trigger when the specified address has been accessed. Up to four trigger points can be set by using the trigger outputs (four channels) on the bus monitoring circuit of the emulator.

The settings of the trigger point are displayed and modified on the [Trigger] sheet.

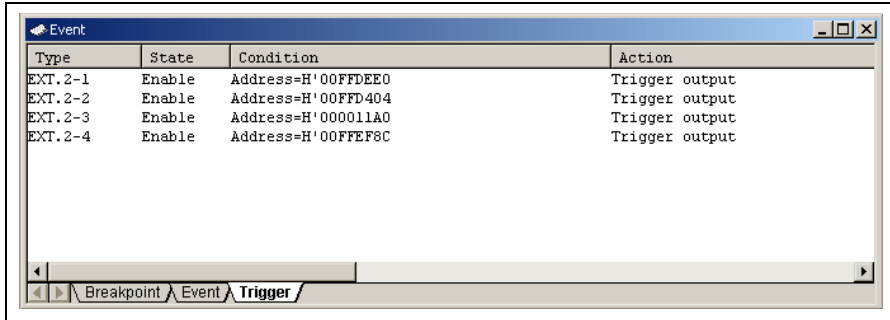

Figure 5.66 [Event] Window ([Trigger] Sheet)

Selecting [Add...] or the event point and [Edit...] from the popup menu in this window displays the [Set Address For Trigger] dialog box.

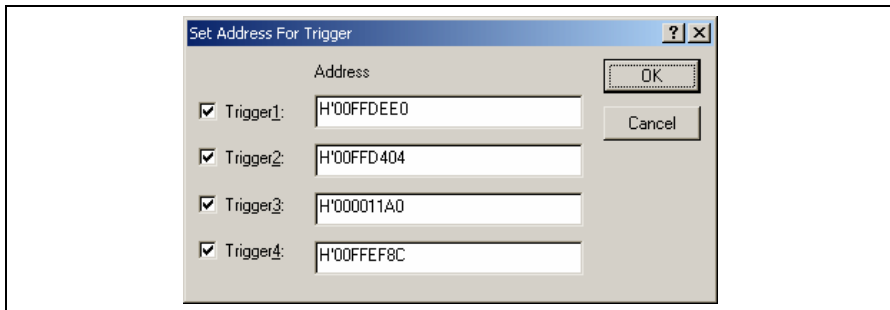

Figure 5.67 [Set Address For Trigger] Dialog Box

This dialog box allows the user to specify the address to be accessed as the trigger output condition during the user program execution. Enable or disable the trigger output point by checking the check box on the left in the screen.

[Trigger1]: Enables the output of trigger channel 1.

[Trigger2]: Enables the output of trigger channel 2.

[Trigger3]: Enables the output of trigger channel 3.

[Trigger4]: Enables the output of trigger channel 4.

[Address]: Sets the address condition of the channel.

- Notes:
1. When the condition set for the trigger output (1 to 4) is satisfied, the high-level signal will be output from the corresponding pin (1 to 4) of the external probe 2 (EXT2) during reading or writing.
 2. Some emulators may not support the trigger point. For details, refer to section 8, Software Specifications Specific to This Product, or the online help.

5.15.9 Editing Event Points

Handlings for settings other than PC breakpoints, event points, and trigger points are common. The following describes examples of such handling.

5.15.10 Modifying Event Points

Select an event point to be modified, and choose [Edit...] from the popup menu to open the dialog box that corresponds the event, which allows the user to modify the event conditions. The [Edit...] menu is only available when one event point is selected.

5.15.11 Enabling an Event Point

Select an event point and choose [Enable] from the popup menu to enable the selected event point.

5.15.12 Disabling an Event Point

Select an event point and choose [Disable] from the popup menu to disable the selected event point. When an event point is disabled, the event point will remain in the list, but an event will not occur when the specified conditions have been satisfied.

5.15.13 Deleting an Event Point

Select an event point and choose [Delete] from the popup menu to remove the selected event point. To retain the event point but not have it cause an event when its conditions are met, use the [Disable] option (see section 5.15.12, Disabling an Event Point).

Note: No trigger point can be deleted. Use the [Disable] option to clear the settings.

5.15.14 Deleting All Event Points

Choose [Delete All] from the popup menu to remove all event points.

Note: No trigger point can be deleted. If [Delete All] is selected, the settings of all channels become disabled.

5.15.15 Viewing the Source Line for an Event Point

Select an event point and choose [Go to Source] from the popup menu to open the [Source] or [Disassembly] window at address of event point. The [Go to Source] menu is only available when one event point that has the corresponding source file is selected.

5.16 Viewing the Trace Information

The emulator acquires the results of each instruction execution into the trace buffer as trace information and displays it in the [Trace] window. The conditions for the trace information acquisition can be specified in the [Trace Acquisition] dialog box.

Since trace information in bus-cycles is acquired by the hardware circuit and stored in the trace buffer, the realtime operation is retained. The [Trace] window displays the content of the trace buffer, which records up to 32,768 bus cycles from the last program run and is always updated.

5.16.1 Opening the [Trace] Window

To open the [Trace] window, choose [View -> Code -> Trace] or click the [Trace] toolbar button ().

5.16.2 Acquiring Trace Information

When the emulator does not set the acquisition condition of the trace information, all bus cycles are acquired by default without any condition (free trace mode).

In the free trace mode, trace acquisition is started with the execution of the user program and stopped by halting the user program. The acquired trace information is displayed in the [Trace] window.

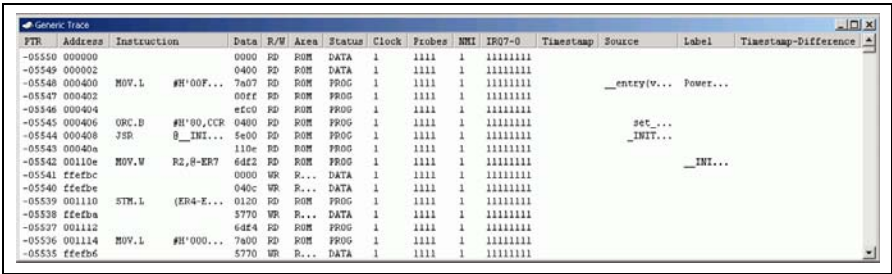

PTR	Address	Instruction	Data	R/W	Area	Status	Clock	Probes	NMI	IRQ7-0	Timestamp	Source	Label	Timestamp-Difference
-05550	000000		0000	RD	ROM	DATA	1	1111	1	11111111				
-05549	000002		0400	RD	ROM	DATA	1	1111	1	11111111				
-05548	000400	MOV.L	#H'00F...	7a07	RD	ROM	PROG	1	1111	1	11111111		_entry(w...	Power...
-05547	000402		00ff	RD	ROM	PROG	1	1111	1	11111111				
-05546	000404		efcc	RD	ROM	PROG	1	1111	1	11111111				
-05545	000406	OPC.B	#H'00,CCR	0480	RD	ROM	PROG	1	1111	1	11111111		set...	
-05544	000408	JSR	8_INIT...	5e00	RD	ROM	PROG	1	1111	1	11111111		_INIT...	
-05543	00040a		110e	RD	ROM	PROG	1	1111	1	11111111				
-05542	00110e	MOV.W	R2,8-ER7	64e2	RD	ROM	PROG	1	1111	1	11111111		_INIT...	
-05541	efefbc		0000	WR	R...	DATA	1	1111	1	11111111				
-05540	efefbe		040c	WR	R...	DATA	1	1111	1	11111111				
-05539	001110	STM.L	(ER4-E...	0120	RD	ROM	PROG	1	1111	1	11111111			
-05538	efefba		3770	WR	R...	DATA	1	1111	1	11111111				
-05537	001112		64e4	RD	ROM	PROG	1	1111	1	11111111				
-05536	001114	MOV.L	#H'000...	7900	RD	ROM	PROG	1	1111	1	11111111			
-05535	efefbe		5770	WR	R...	DATA	1	1111	1	11111111				

Figure 5.68 [Trace] Window

This window displays the following trace information items:

- [PTR]: Cycle number in the trace buffer. When the most recent record is record 0, earlier record numbers go backwards (-1, -2, ...). If a delay count has been set, the cycle number where the trace stop condition has been satisfied is record 0. For the cycle (during delay) executed until the trace has stopped, earlier record numbers go forward (+1, +2, ...) the most recent record.
- [Address]: Address (6-digit hexadecimal)
- [Instruction]: Disassembled code of the executed instruction
- [Data]: Data bus value, displayed as 2-digit or 4-digit hexadecimal
- [R/W]: Whether access was read (RD) or write (WR)
- [Area]: Memory area being accessed; ROM, RAM, 8- or 16-bit I/O, 8- or 16-bit EXT (external), or DTC RAM (not available when a time stamp is acquired)
- [Status]: Bus status during this cycle; DTC operation, PROG (prefetch), Data (CPU data access cycle), Refresh (refresh cycle), or DMAC (DMAC cycle) (not available when a time stamp is acquired)

- [Clock]: Number of clock cycles in bus cycle as 1 to 8. To indicate more clock cycles, "OVR" is displayed (not available when a time stamp is acquired).
- [Probes]: A 4-bit binary number showing the four probe pins in the order of Probe 4, Probe 3, Probe 2, and Probe 1 from the left (not available when a time stamp is acquired).
- [NMI]: Status of the NMI input (not available when a time stamp is acquired)
- [IRQ7-0]: Status of eight IRQ inputs (not available when a time stamp is acquired)
- [Timestamp]: Time stamp of the record. Time stamps start from zero each time the user program is executed. The timer resolution depends on the time stamp clock rate selected in the trace acquisition (only available when a time stamp is acquired).
- [Source]: Source program
- [Label]: Label information that corresponds to the address (if defined)
- Note: Items other than [PTR], [Address], [Instruction], [Data], [R/W], [Area], [Status], [Probes], [Timestamp], [Source], and [Label] vary according to the emulator in use. For details, refer to section 8, Software Specifications Specific to This Product, or the online help.

It is possible to hide any column not necessary in the [Trace] window. Selecting a column you want to hide from the popup menu displayed by clicking the right-hand mouse button on the header column hides that column. To display the hidden column, select the column from the said popup menu again.

5.16.3 Specifying Trace Acquisition Conditions

The capacity of the trace buffer is limited. When the buffer becomes full, the oldest trace information is overwritten. Setting the trace acquisition condition allows acquisition of useful trace information and effective use of the trace buffer. The condition is enabled by the event point to control starting, stopping, and ending the trace acquisition. For event points, refer to section 5.15, Using the Event Points.

The trace acquisition condition is set in the [Trace Acquisition] dialog box that is displayed by selecting [Acquisition...] from the popup menu.

The [Trace Acquisition] dialog box has the following pages:

Table 5.4 [Trace Acquisition] Dialog Box Pages

Page	Item
[General]	Sets trace acquisition conditions.
[Stop]	Sets trace stop conditions (without a delay).
[Delayed Stop]	Sets trace stop conditions (with a delay).
[1] to [4]	Sets the range trace (only available when the free trace mode is disabled).

(1) [General] page

Sets trace acquisition conditions.

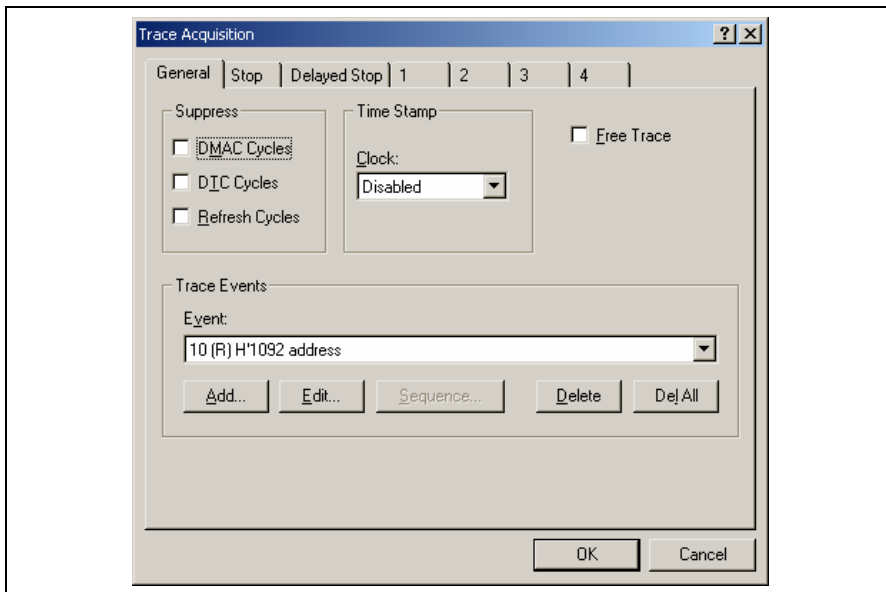

Figure 5.69 [Trace Acquisition] Dialog Box ([General] Page)

- [Suppress]: Acquires no trace information of the specified types of bus cycle.
- [Time Stamp]: Sets a condition for time stamping.
- [Clock]: Select either from Disabled, 125 ns, 250 ns, 500 ns, 1 us, 2 us, 4 us, 8 us, 16 us, or 100 us as the resolution for time stamping. A time stamp has a 32-bit counter. At 125 ns the maximum time that can be measured is about 9 minutes, and at 100 μ s the maximum time is about 5 days.
When the counter overflows, its content will be cleared to continue counting. No time stamp information will be acquired when Disabled is selected.
- [Free Trace]: Checking this box enables the free trace mode.
- When the free trace mode is enabled: Starts acquiring the data immediately after program execution has been started. Only the trace halt condition is available. The range trace is unavailable and four range-trace pages (1 to 4) become disabled.
- When the free trace mode is disabled: Sets the start and halt conditions of trace acquisition.
- [Trace Events]: Sets event points to be used as trace acquisition conditions.
- [Event]: Lists the event points to be used as trace acquisition conditions.
- [Add...]: Adds a new event point.
- [Edit...]: Changes the setting for the selected event point.
- [Sequence...]: Configures an event sequence for the event point being used as a trace acquisition condition. To set up the sequence, an event must have been set.
- [Delete]: Deletes the selected event point.
- [Del All]: Deletes all event points.

- Notes:
1. The bus cycles that can be specified by the [Suppress] option vary according to the emulator in use. For details, refer to section 5.15.4, Signals to Indicate Bus States and Areas.
 2. The trace buffer is used for the time stamp information and some of the trace information. Therefore, when the time stamp is acquired, it is impossible to acquire the trace information other than PTR, Address, Instruction, Data, R/W, Source, Label, and Timestamp.
 3. If an event that is used for the range trace or trace stop function is deleted, that function becomes disabled.

(2) [Stop] page

Sets trace stop conditions. It is possible to set trace stop conditions with and without delay, with both allowed simultaneously.

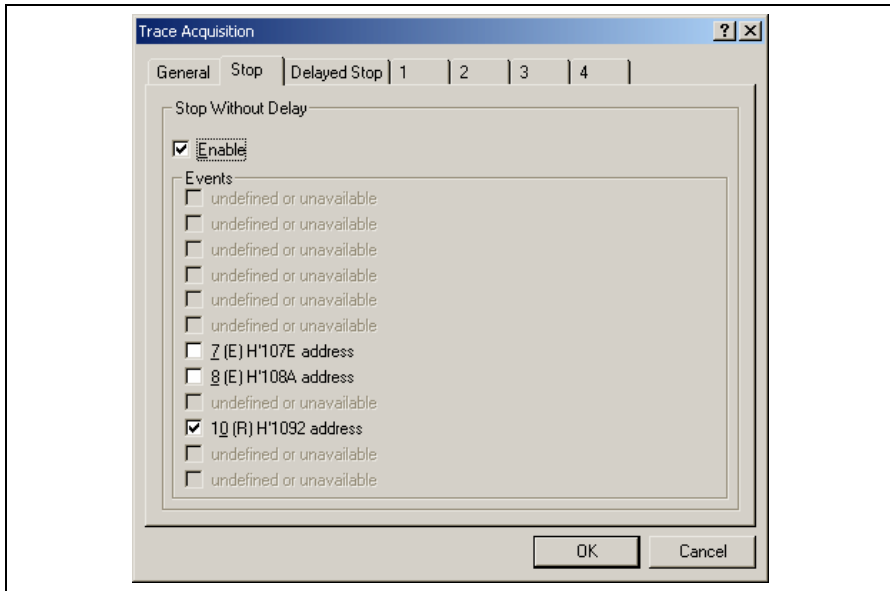

Figure 5.70 [Trace Acquisition] Dialog Box ([Stop] Page)

[Stop Without Delay]: Defines a trace stop condition.

[Enable]: Checking this box enables a trace stop.

[Events]: Lists the event points where trace acquisition conditions have been set. If the box that corresponds to an event point is checked, trace acquisition will be stopped when that event is satisfied (only available when [Enable] has been selected).

(3) [Delayed Stop] page

Sets trace stop conditions. It is possible to set trace stop conditions with and without delay, with both allowed simultaneously.

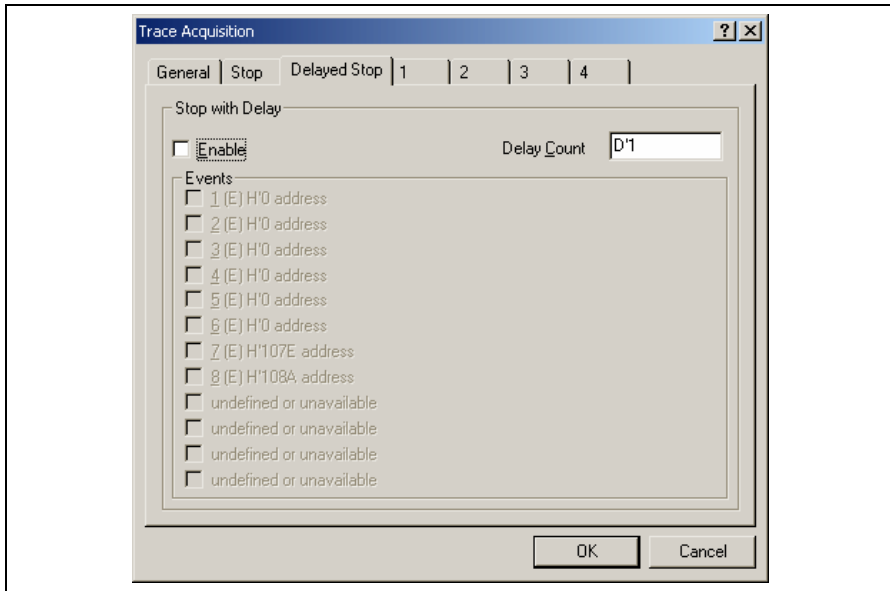

Figure 5.71 [Trace Acquisition] Dialog Box ([Delayed Stop] Page)

- [Stop With Delay]: Defines a trace stop condition.
- [Enable]: Checking this box enables a trace stop.
- [Delay Count]: Sets the delay count (in bus cycles, range 1 to 65535). This function allows you to acquire a number of trace records after any of the specified events occur.
- [Events]: Lists the event points where trace acquisition conditions have been set. If the box that corresponds to an event point is checked, trace acquisition will be stopped when that event is satisfied (only available when [Enable] has been selected).

(4) [1] to [4] pages

Sets a range trace. This is only available when the free trace mode is disabled. Select either of the following four modes: [Disabled], [Point to Point], [Range], and [Event].

- Disabled

Disables a range trace.

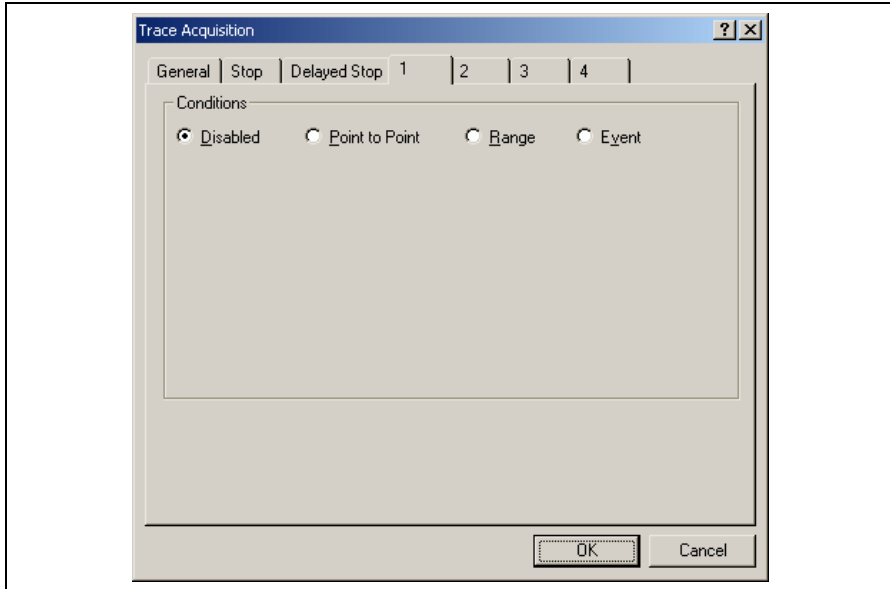

Figure 5.72 Range Trace Setting (Disabled)

- Point to Point

Acquires trace information in the specified range.

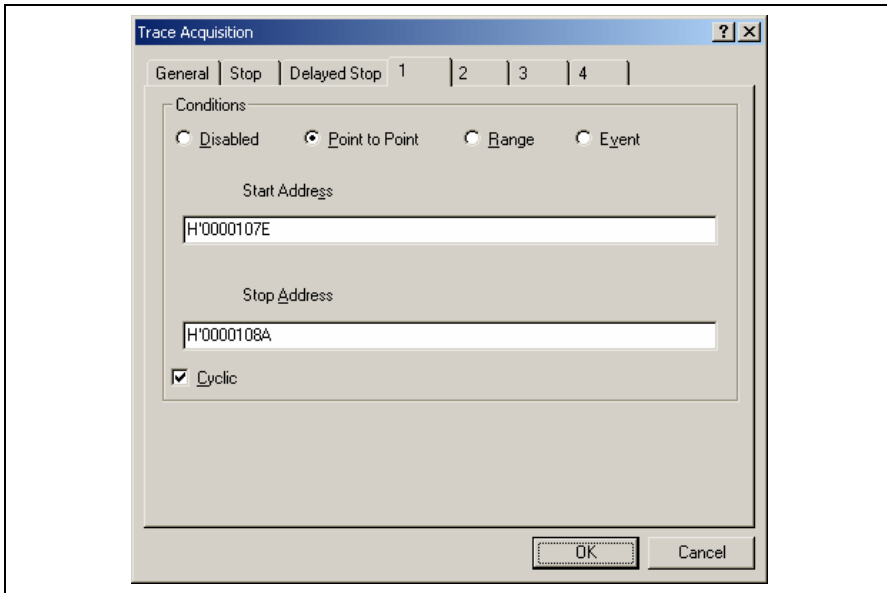

Figure 5.73 Range Trace Setting (Point to Point)

[Start Address]: Address where trace acquisition starts

[Stop Address]: Address where trace acquisition stops

[Cyclic]: When this box is checked, the event sequencing is configured so that the events reset themselves which causes tracing to be restarted when the start event occurs after the stop event.

Sets the event points that are required to start or stop trace acquisition when the start or end address is accessed, respectively.

Point to Point mode is an easy method to set up the event mode. The event to start or stop trace acquisition is an access to a single address.

Select [Cyclic] to continue acquisition of the trace information only in the specified address range.

Note: This function automatically configures a sequence of event points. Note, however, that an unexpected result may arise. In such cases, modify the setting of the sequence in the [Event Sequencing] dialog box.

- Range

Only acquires the trace information that satisfies the specified condition.

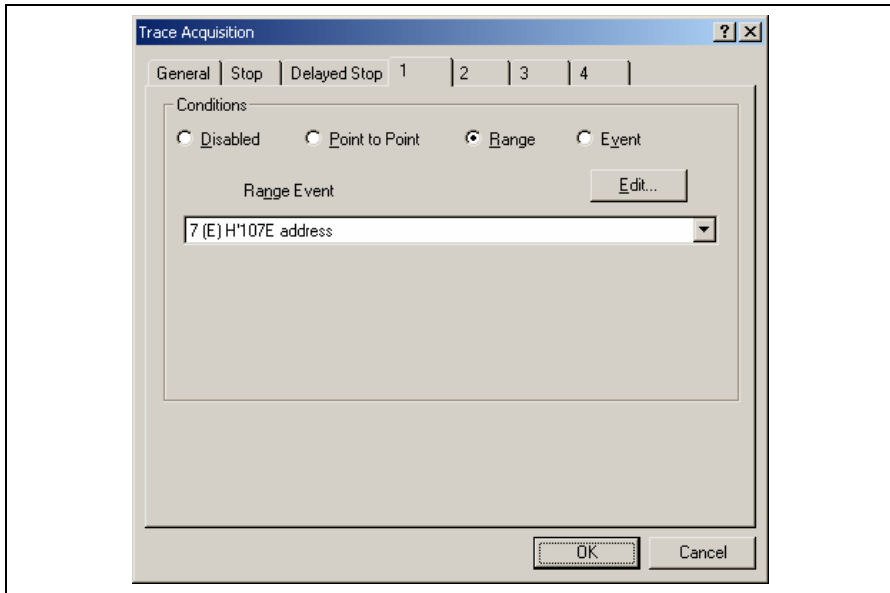

Figure 5.74 Range Trace Setting (Range)

[Range Event]: Selects an event point for which a trace acquisition condition has been set.

[Edit...]: Changes the setting for the selected event point.

Only acquires trace information from all bus cycles that matches the condition set in the selected event. This mode uses one event channel or range channel.

- Event

Acquires trace information, controlling the start and end of trace acquisition with the specified condition.

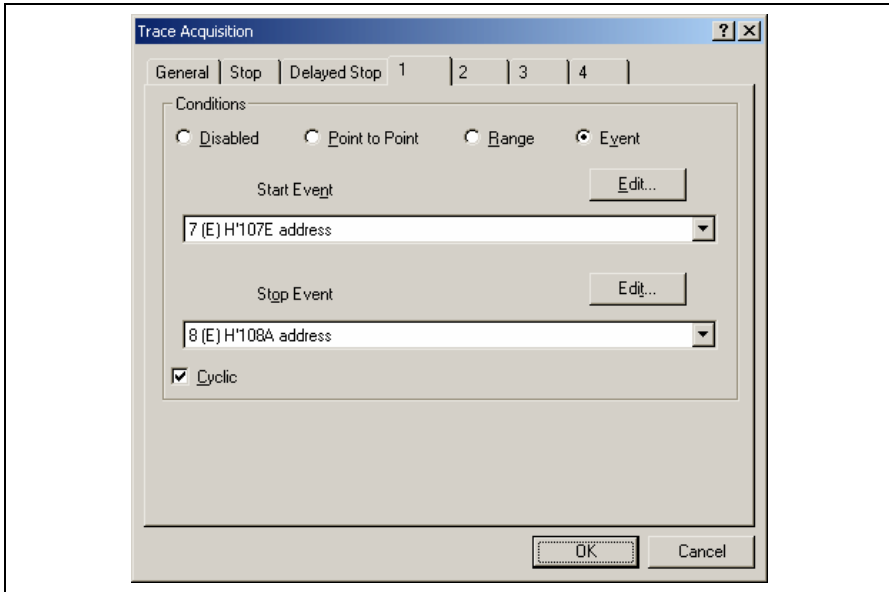

Figure 5.75 Range Trace Setting (Event)

[Start Event]: Selects the event point for which the condition to start trace acquisition has been set.

[Stop Event]: Selects the event point for which the condition to stop trace acquisition has been set.

[Edit...]: Changes the setting for the selected event point.

[Cyclic]: When this box is checked, the event sequencing is configured so that the events reset themselves which causes tracing to be restarted when the start event occurs after the stop event.

Starts and stops trace acquisition when the conditions for starting and ending are satisfied, respectively. Selecting [Cyclic] allows a continuous acquisition of trace information that can be acquired with the specified condition.

5.16.4 Searching for a Trace Record

Use the [Trace Find] dialog box to search for a trace record. To open this dialog box, choose [Find...] from the popup menu.

The [Trace Find] dialog box has the following options:

Table 5.5 [Trace Find] Dialog Box Pages

Page	Description
[General]	Sets the range for searching.
[Address]	Sets an address condition.
[Data]	Sets a data condition.
[R/W]	Selects the type of access cycles.
[Area]	Selects the area being accessed (not available when a time stamp is acquired).
[Status]	Selects the status of a bus (not available when a time stamp is acquired).
[Probes]	Selects the status of four probe signals (not available when a time stamp is acquired).
[IRQ7-0]	Selects the status of eight probe input signals (not available when a time stamp is acquired).
[Timestamp]	Specify the time stamp value for bus cycles (only available when a time stamp is acquired).

Note: Items other than [General], [Address], [Data], [R/W], [Area], [Status], [Probes], and [Timestamp] vary according to the emulator in use. For details, refer to section 8, Software Specifications Specific to This Product or the online help.

Clicking the [OK] button after setting conditions in those pages stores the settings and starts searching. Clicking the [Cancel] button closes this dialog box without setting of conditions.

When a trace record that matches the search conditions is found, the line for the trace record will be highlighted. When no matching trace record is found, a message dialog box will appear.

Only the trace information that satisfies all the conditions set in above pages will be searched.

If a find operation is successful, selecting [Find Next] from the popup menu will move to the next found item.

(1) [General] page

Set the range for searching.

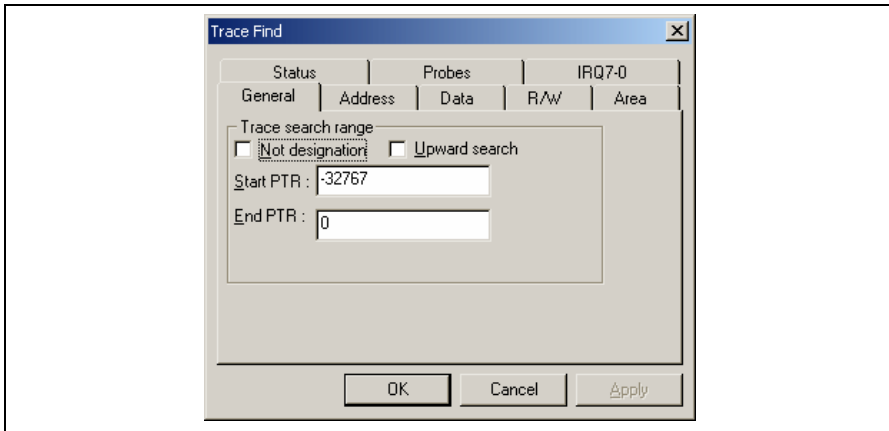

Figure 5.76 [Trace Find] Dialog Box ([General] Page)

[Trace search range]: Sets the range for searching.

[Not designation]: Searches for information that does not match the conditions set in other pages when this box is checked.

[Upward search]: Searches upwards when this box is checked.

[Start PTR]: Enters a PTR value to start a search.

[End PTR]: Enters a PTR value to end a search.

Note: Along with setting the range for searching, PTR values to start and end searching can be set in the [Start PTR] and [End PTR] options, respectively.

(2) [Address] page

Set an address condition.

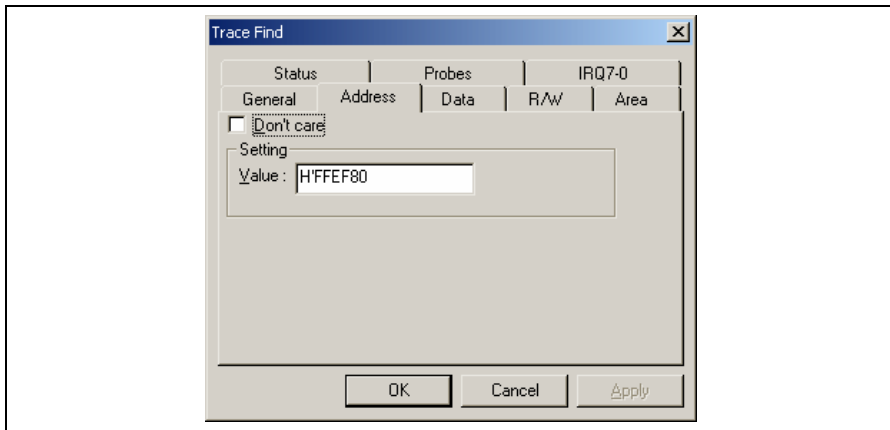

Figure 5.77 [Trace Find] Dialog Box ([Address] Page)

[Don't care]: Detects no address when this box is checked.

[Setting]: Detects the specified address.

[Value]: Enter the address value (not available when [Don't care] has been checked).

(3) [Data] page
Set a data condition.

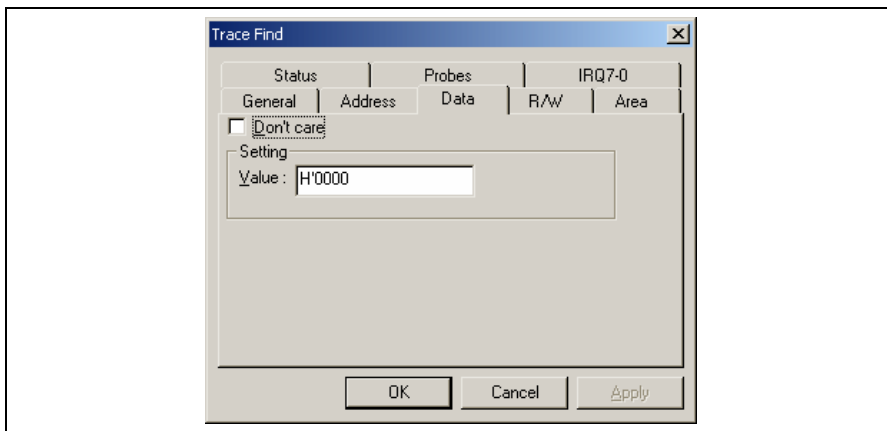

Figure 5.78 [Trace Find] Dialog Box ([Data] Page)

[Don't care]: Detects no data when this box is checked.

[Setting]: Detects the specified data.

[Value]: Enter the data value (not available when [Don't care] has been checked).

(4) [R/W] page

Select the type of access cycles.

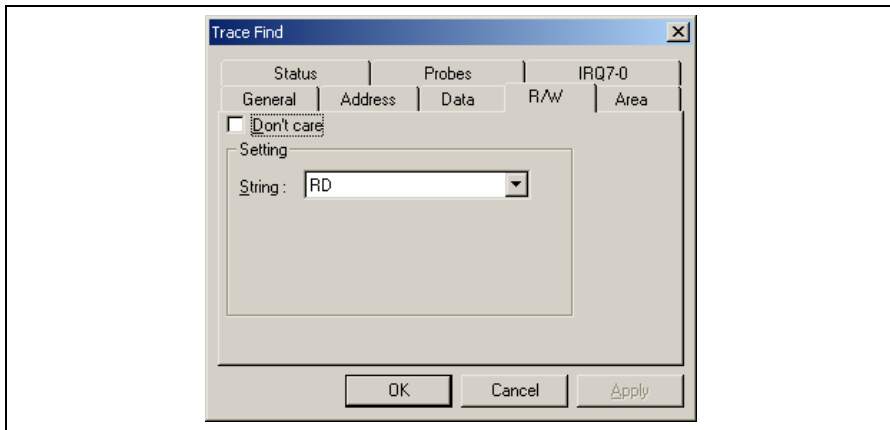

Figure 5.79 [Trace Find] Dialog Box ([R/W] Page)

[Don't care]: Detects no read/write condition when this box is checked.

[Setting]: Detects the specified read/write condition.

[String]: Select a read/write condition (not available when [Don't care] has been checked).

RD: Read cycle

WR: Write cycle

(5) [Area] page

Select the area being accessed. The selection is not available when a time stamp is acquired.

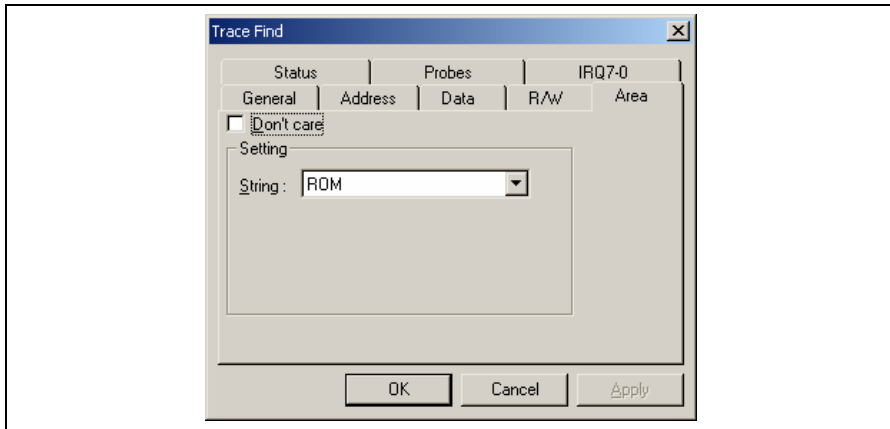

Figure 5.80 [Trace Find] Dialog Box ([Area] Page)

[Don't care]: Detects no area condition when this box is checked.

[Setting]: Detects the specified area condition.

[String]: Select an area condition (not available when [Don't care] has been checked).

Note: Available areas vary according to the emulator in use. For details, refer to section 5.15.4, Signals to Indicate Bus States and Areas.

(6) [Status] page

Select the status of a bus. The selection is not available when a time stamp is acquired.

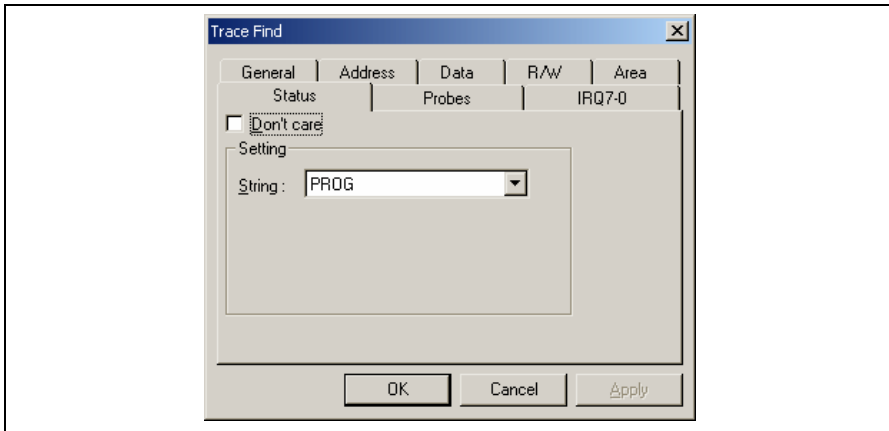

Figure 5.81 [Trace Find] Dialog Box ([Status] Page)

[Don't care]: Detects no bus condition when this box is checked.

[Setting]: Detects the specified bus condition.

[String]: Select a bus condition (not available when [Don't care] has been checked).

Note: Available bus conditions vary according to the emulator in use. For details, refer to section 5.15.4, Signals to Indicate Bus States and Areas.

(7) [Probes] page

Select the status of four probe signals. The selection is not available when a time stamp is acquired.

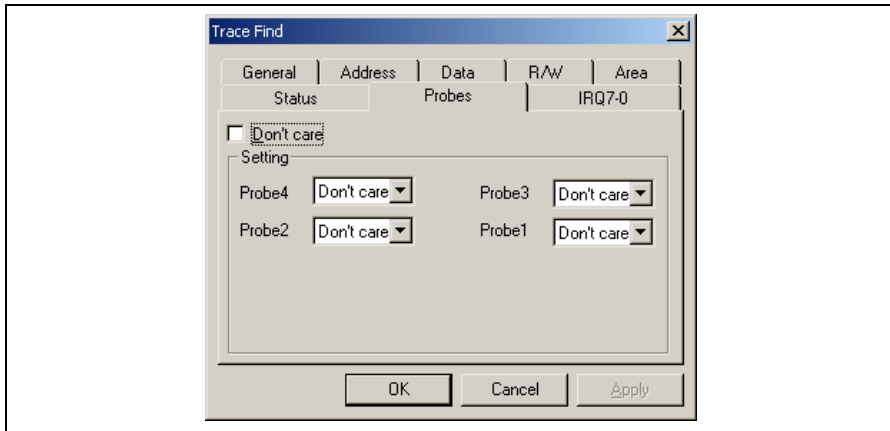

Figure 5.82 [Trace Find] Dialog Box ([Probes] Page)

[Don't care]: Detects no probe signal condition when this box is checked.

[Setting]: Detects the specified probe signal condition.

[Probe4] to [Probe1]: Select probe conditions (not available when [Don't care] has been checked).

Don't care: Detects no selected probe condition.

High: The status of the probe signal is high.

Low: The status of the probe signal is low.

(8) [IRQ7-0] page

Select the status of IRQ signals. The selection is not available when a time stamp is acquired.

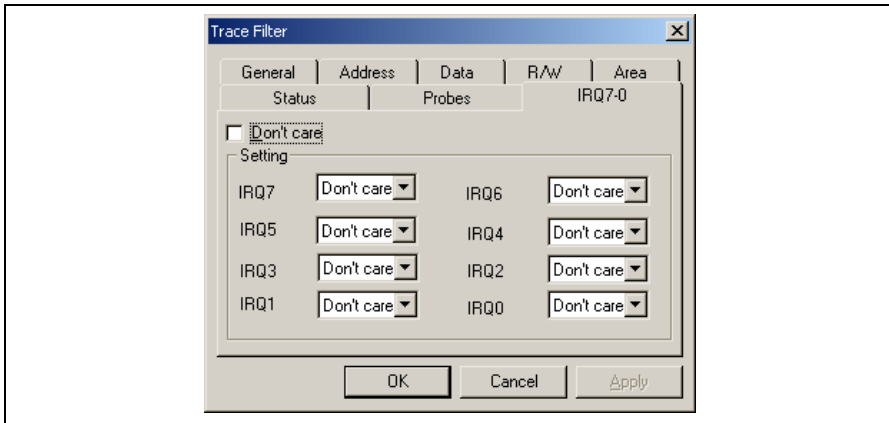

Figure 5.83 [Trace Find] Dialog Box ([IRQ7-0] Page)

[Don't care]: Detects no IRQ input condition when this box is checked.

[Setting]: Detects the specified IRQ input condition.

[IRQ7] to [IRQ0]: Select IRQ input conditions (not available when [Don't care] has been checked).

Don't care: Detects no selected IRQ input condition.

High: The status of the IRQ input is high.

Low: The status of the IRQ input is low.

(9) [Timestamp] page

Specify the time stamp value for bus cycles. The specification is not available when a time stamp is acquired.

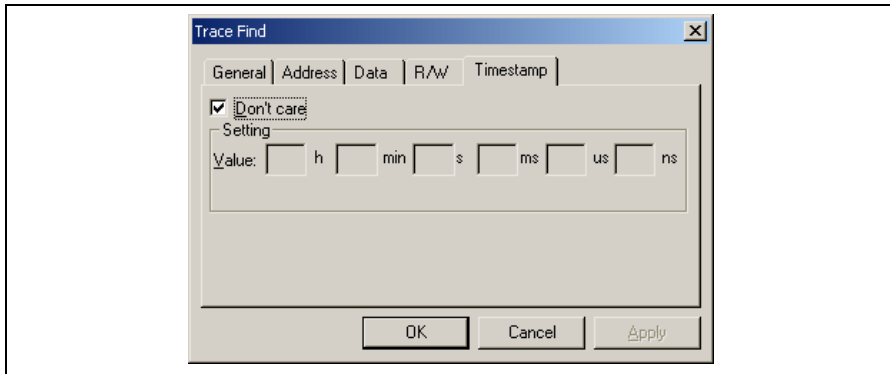

Figure 5.84 [Trace Find] Dialog Box ([Timestamp] Page)

[Don't care]: Detects no time stamp value when this box is checked.

[Setting]: Detects the specified time stamp value.

[Value]: Enter the time stamp value.

The format is as follows:

hour: h, minute: min, second: s, millisecond: ms, microsecond: us, nanosecond: ns

(Not available when [Don't care] has been checked.)

5.16.5 Clearing the Trace Information

Select [Clear] from the popup menu to empty the trace buffer that stores the trace information. If several [Trace] windows are open, all [Trace] windows will be cleared as they all access the same buffer.

5.16.6 Saving the Trace Information in a File

Select [Save...] from the popup menu to open the [Save As] file dialog box, which allows the user to save the information displayed in the [Trace] window as a text file. A range can be specified based on the [PTR] number (saving the complete buffer may take several minutes). Note that this file cannot be reloaded into the [Trace] window.

Note: In filtering of trace information, the range to be saved cannot be selected. All the trace information displayed in the [Trace] window after filtering will be saved. Select a filtering range on the [General] page in the [Trace Filter] dialog box if you want to save the selected range. For details on the filtering function, refer to section 5.16.12, Extracting Records from the Acquired Information.

5.16.7 Viewing the [Source] Window

The [Source] window corresponding to the selected trace record can be displayed in the following two ways:

- Select a trace record and choose [View Source] from the popup menu.
- Double-click a trace record

The [Source] or [Disassembly] window opens and the selected line is marked with a cursor.

5.16.8 Trimming the Source

Choose [Trim Source] from the popup menu to remove the white space from the left side of the source.

When the white space is removed, a check mark is shown to the left of the [Trim Source] menu. To restore the white space, choose [Trim Source] while the check mark is shown.

5.16.9 Acquiring a Snapshot of the Trace Information

A snapshot can be acquired when you need to check the trace information during execution of the user program. This is useful for checking time stamping or probe input signals. To acquire a snapshot of trace information, select [Snapshot] from the popup menu. Trace acquisition is temporarily stopped to display a record of the latest trace information, and then restarted. A snapshot of trace information is only acquired during execution of the user program.

5.16.10 Temporarily Stopping Trace Acquisition

To temporarily stop trace acquisition during execution of the user program, select [Halt] from the popup menu. This stops trace acquisition and updates the trace display. Use this method to check the trace information without stopping execution of the user program.

5.16.11 Restarting Trace Acquisition

To restart trace acquisition being stopped during execution of the user program, select [Restart] from the popup menu.

5.16.12 Extracting Records from the Acquired Information

Use the filtering function to extract the records you need from the acquired trace information. The filtering function allows the trace information acquired by hardware to be filtered by software. Unlike the settings made in the [Trace Acquisition] dialog box for acquiring trace information by conditions, changing the settings for filtering several times to filter the acquired trace information allows easy extraction of necessary information, which is useful for analysis of data. The content of the trace buffer will not be changed even when the filtering function is used. Acquiring useful information as much as possible by the [Trace Acquisition] settings improves the efficiency in analysis of data because the capacity of the trace buffer is limited.

Use the filtering function in the [Trace Filter] dialog box. To open the [Trace Filter] dialog box, select [Filter...] from the popup menu.

The [Trace Filter] dialog box has the following pages:

Table 5.6 [Trace Filter] Dialog Box Pages

Page	Description
[General]	Selects the range for filtering.
[Address]	Sets address conditions.
[Data]	Sets data conditions.
[R/W]	Selects the type of access cycles.
[Area]	Selects the area being accessed (not available when a time stamp is acquired).
[Status]	Sets the status of a bus (not available when a time stamp is acquired).
[Probes]	Selects the states of four probe signals (not available when a time stamp is acquired).
[IRQ7-0]	Selects the states of eight IRQ input signals (not available when a time stamp is acquired).
[Timestamp]	Specifies the time stamp value for bus cycles (only available when a time stamp is acquired).

Note: Items other than [General], [Address], [Data], [R/W], [Area], [Status], [Probes], and [Timestamp] vary according to the emulator in use. For details, refer to section 8, Software Specifications Specific to This Product or the online help.

Set filtering conditions and then press the [OK] button. This starts filtering according to the conditions. Clicking the [Cancel] button closes the [Trace Filter] dialog box, which holds the settings at the time when the dialog box was opened.

In filtering, only the trace information that satisfies one or more filtering conditions set in the above pages will be displayed in the [Trace] window.

Filtering conditions can be changed several times to analyze data because the content of the trace buffer is not changed by filtering.

(1) [General] page

Set the range for filtering.

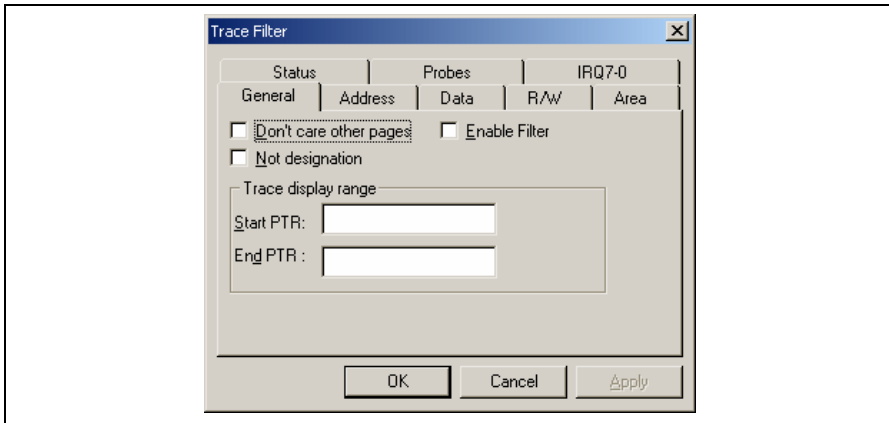

Figure 5.85 [Trace Filter] Dialog Box ([General] Page)

[Don't care other pages]: Only selects the cycle number when this box is checked. Other options become invalid.

[Enable Filter]: Enables the filter when this box is checked.

[No]: Filters information that does not match the conditions set in those pages when this box is checked.

[Trace display range]: Sets the range for filtering.

[Start PTR]: Enters a PTR value to start filtering.

[End PTR]: Enters a PTR value to end filtering.

Note: Along with setting the range for filtering, PTR values to start and end filtering can be set in the [Start PTR] and [End PTR] options, respectively.

(2) [Address] page
Set address conditions.

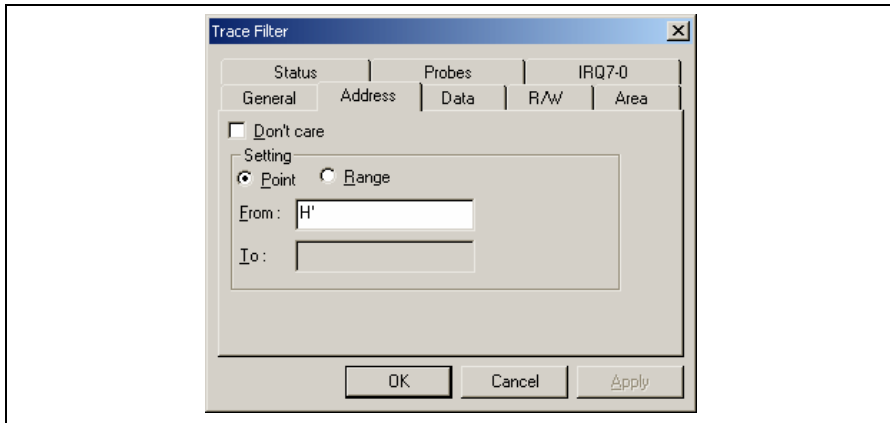

Figure 5.86 [Trace Filter] Dialog Box ([Address] Page)

[Don't care]: Detects no address when this box is checked.

[Setting]: Detects the specified address.

[Point]: Specifies a single address (not available when [Don't care] has been checked).

[Range]: Specifies an address range (not available when [Don't care] has been checked).

[From]: Enter a single address or the start of the address range (not available when [Don't care] has been checked).

[To]: Enter a single address or the end of the address range (only available when [Range] has been selected).

Note: Along with setting the address range, the start and end of the address range can be set in the [From] and [To] options, respectively.

(3) [Data] page
Set a data condition.

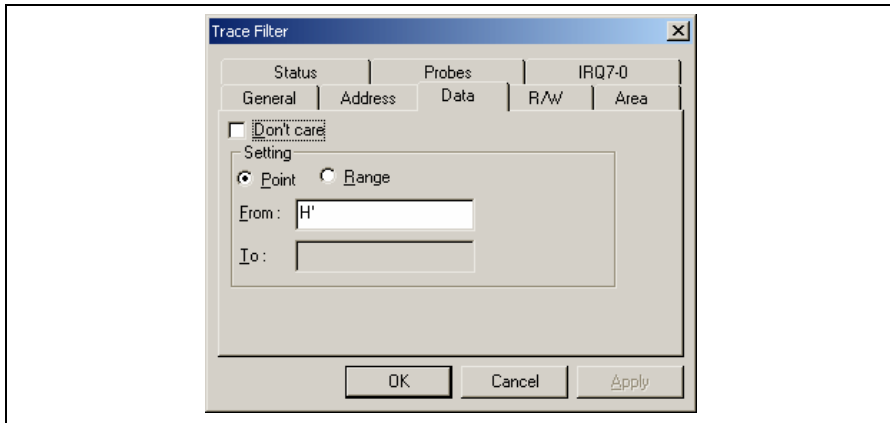

Figure 5.87 [Trace Filter] Dialog Box ([Data] Page)

[Don't care]: Detects no data when this box is checked.

[Setting]: Detects the specified data.

[Point]: Specifies single data (not available when [Don't care] has been checked).

[Range]: Specifies a data range (not available when [Don't care] has been checked).

[From]: Enter single data or the minimum value of the data range (not available when [Don't care] has been checked).

[To]: Enter the maximum value of the data range (only available when [Range] has been selected).

Note: Along with setting the data range, the minimum and maximum values can be set in the [From] and [To] options, respectively.

(4) [R/W] page

Select the type of access cycles.

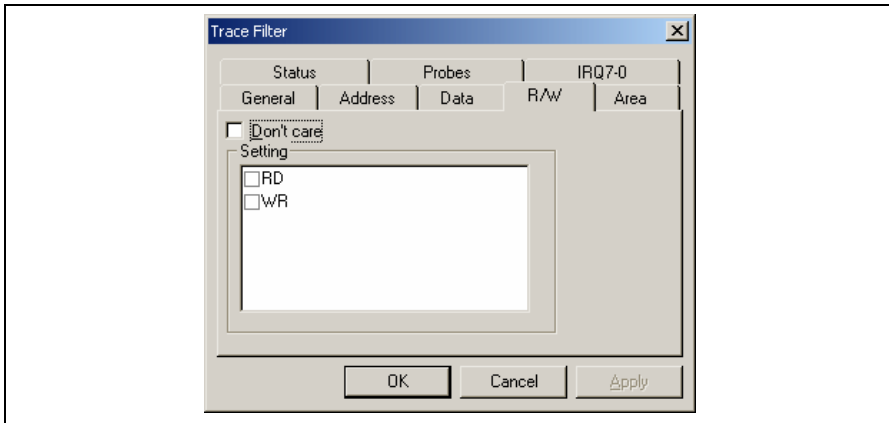

Figure 5.88 [Trace Filter] Dialog Box ([R/W] Page)

[Don't care]: Detects no read/write condition when this box is checked.

[Setting]: Detects the specified read/write condition.

RD: Detects read cycles when this box is checked (not available when [Don't care] has been checked).

WR: Detects write cycles when this box is checked (not available when [Don't care] has been checked).

(5) [Area] page

Select the area being accessed. The selection is not available when a time stamp is acquired.

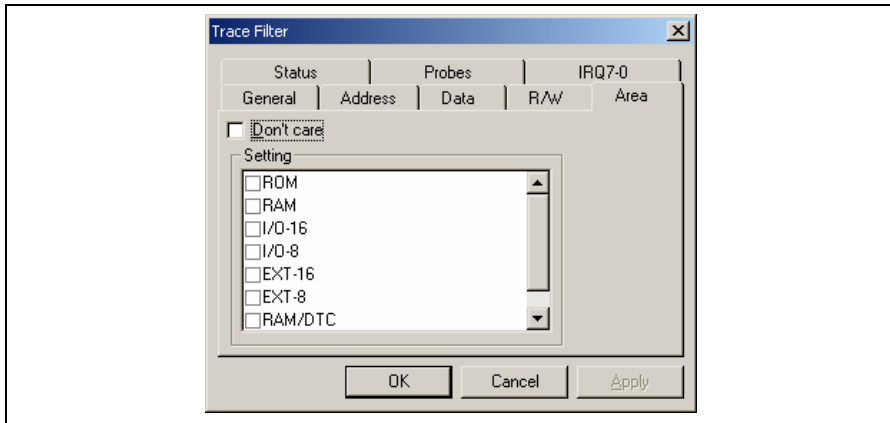

Figure 5.89 [Trace Filter] Dialog Box ([Area] Page)

[Don't care]: Detects no area condition when this box is checked.

[Setting]: Detects the specified area condition (not available when [Don't care] has been checked).

Note: Available area conditions vary according to the emulator in use. For details, refer to section 5.15.4, Signals to Indicate Bus States and Areas.

(6) [Status] page

Select the status of a bus. The selection is not available when a time stamp is acquired.

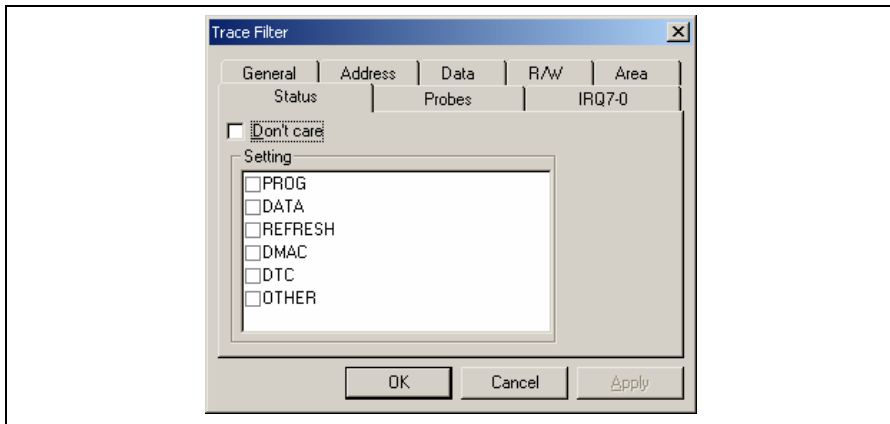

Figure 5.90 [Trace Filter] Dialog Box ([Status] Page)

[Don't care]: Detects no bus condition when this box is checked.

[Setting]: Detects the specified bus condition (not available when [Don't care] has been checked).

Note: Available bus conditions vary according to the emulator in use. For details, refer to section 5.15.4, Signals to Indicate Bus States and Areas.

(7) [Probes] page

Select the status of four probe signals. The selection is not available when a time stamp is acquired.

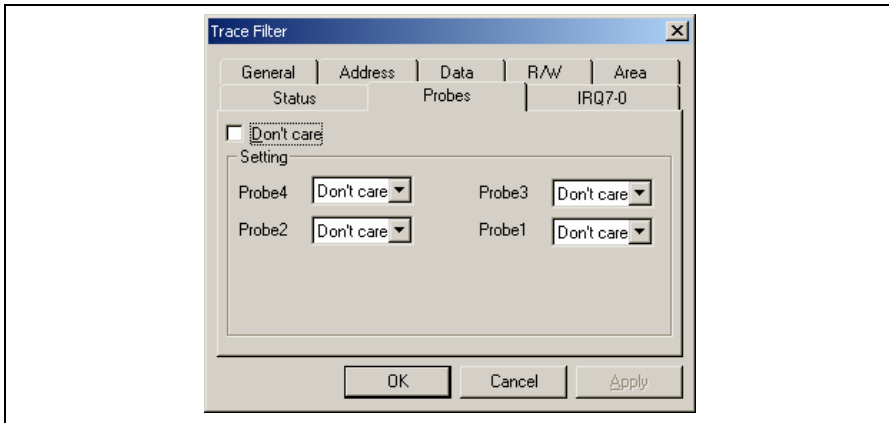

Figure 5.91 [Trace Filter] Dialog Box ([Probes] Page)

[Don't care]: Detects no probe signal condition when this box is checked.

[Setting]: Detects the specified probe signal condition.

[Probe4] to [Probe1]: Select probe conditions (not available when [Don't care] has been checked).

Don't care: Detects no selected probe condition.

High: The status of the probe signal is high.

Low: The status of the probe signal is low.

(8) [IRQ7-0] page

Select the status of IRQ signals. The selection is not available when a time stamp is acquired.

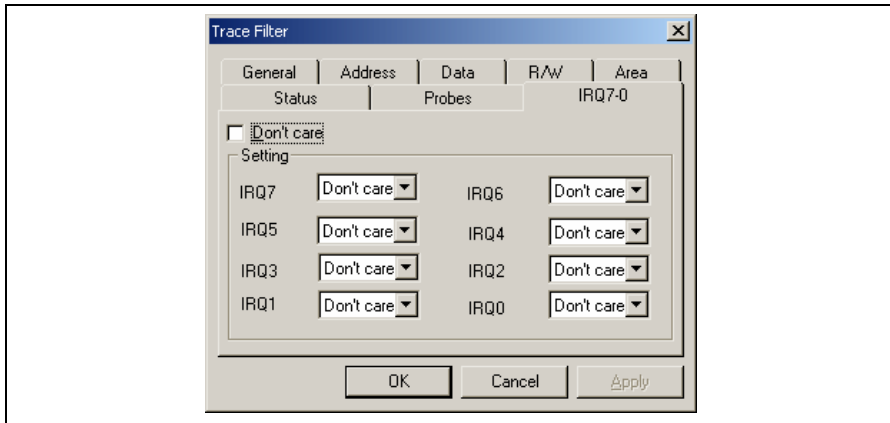

Figure 5.92 [Trace Filter] Dialog Box ([IRQ7-0] Page)

[Don't care]: Detects no IRQ input condition when this box is checked.

[Setting]: Detects the specified IRQ input condition.

[IRQ7] to [IRQ0]: Select IRQ input conditions (not available when [Don't care] has been checked).

Don't care: Detects no selected IRQ input condition.

High: The status of the IRQ input is high.

Low: The status of the IRQ input is low.

(9) [Timestamp] page

Specify the time stamp value for bus cycles. The specification is not available when a time stamp is acquired.

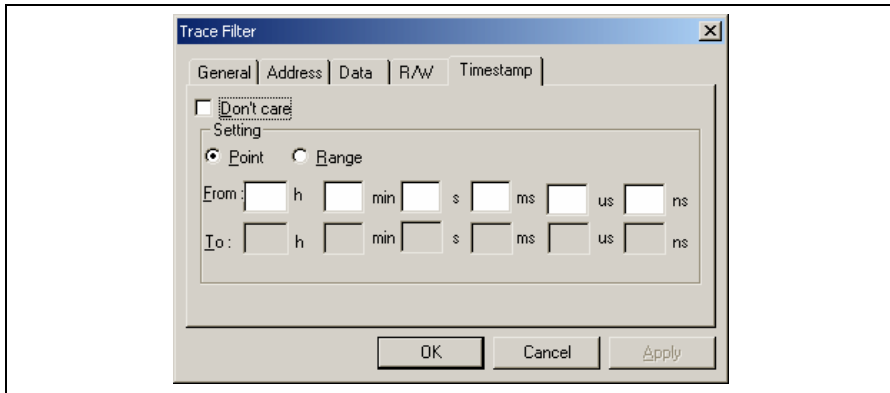

Figure 5.93 [Trace Filter] Dialog Box ([Timestamp] Page)

[Don't care]: Detects no time stamp value when this box is checked.

[Setting]: Detects the specified time stamp value.

[Point]: Specifies a single time stamp (not available when [Don't care] has been checked).

[Range]: Specifies a time stamp range (not available when [Don't care] has been checked).

[From]: Enter a single time stamp value or the minimum value of the time stamp range.
The format is as follows:
hour: h, minute: min, second: s, millisecond: ms, microsecond: us, nanosecond: ns
(Not available when [Don't care] has been checked.)

[To]: Enter the maximum value of the time stamp range.
The format is as follows:
hour: h, minute: min, second: s, millisecond: ms, microsecond: us, nanosecond: ns
(Only available when [Range] has been selected.)

Note: Along with setting the time stamp range, the minimum and maximum time stamp values can be set in the [From] and [To] options, respectively.

5.16.13 Calculating the Difference in Time Stamping

Select [Timestamp Difference...] from the popup menu to calculate the time difference between the two points selected by the result of tracing in acquisition of time stamp information.

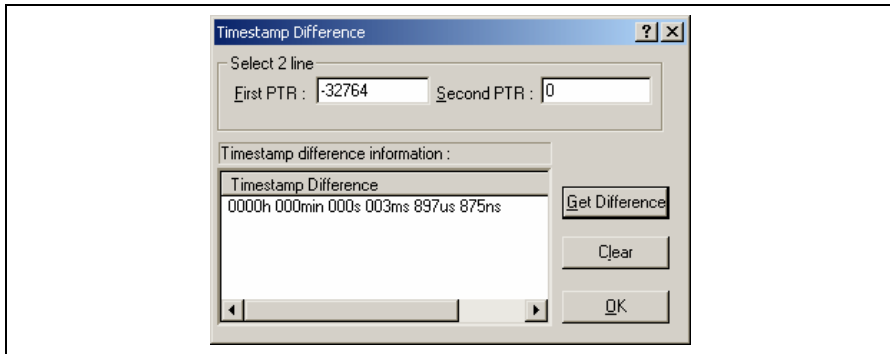

Figure 5.94 [Timestamp Difference] Dialog Box

- [Select 2 line]: Select trace records to calculate the time stamp difference.
- [First PTR]: Specifies the first pointer to measure the difference. The pointer of the line selected on the Trace window is displayed by default.
- [Second PTR]: Specifies the second pointer to measure the difference.
- [Timestamp Difference]: Displays the results of calculation.
- [Get Difference]: Calculates the difference between the specified two points and display its result in the [Timestamp Difference] list.
- [Clear]: Clears all the results in the [Timestamp Difference] list.
- [OK]: Closes the dialog box. All the results in the [Timestamp Difference] list are cleared.

5.16.14 Analyzing Statistical Information

Choose [Statistic] from the popup menu to open the [Statistic] dialog box and analyze statistical information under the specified conditions.

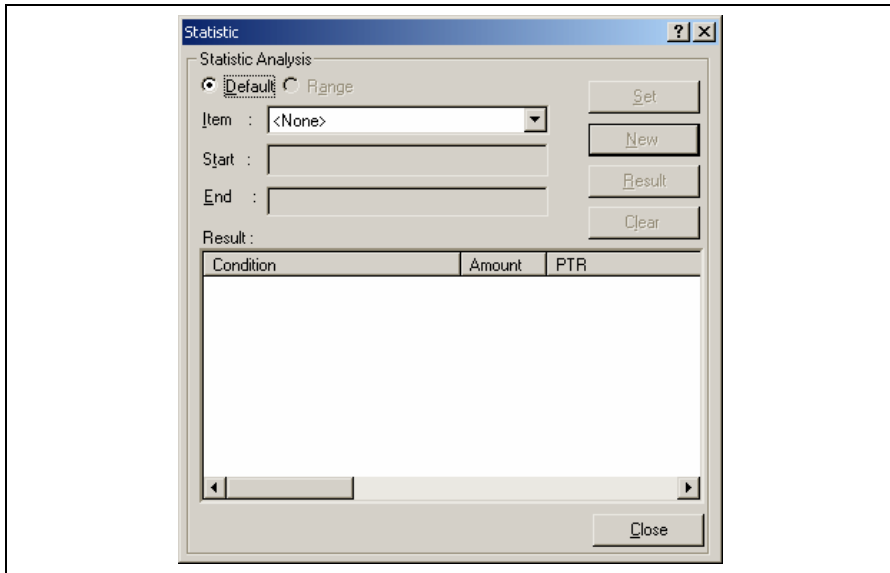

Figure 5.95 [Statistic] Dialog Box

- [Statistic Analysis]: Setting required for analysis of statistical information.
- [Default]: Sets a single input value or character string.
- [Range]: Sets the input value or character string as a range.
- [Item]: Sets the item for analysis.
- [Start]: Sets the input value or character string. To set a range, the start value must be specified here.
- [End]: Specify the end value if a range has been set (only available when [Range] has been selected).
- [Set]: Adds a new condition to the current one.
- [New]: Creates a new condition.
- [Result]: Obtains the result of statistical information analysis.
- [Clear]: Clears all conditions and results of statistical information analysis.
- [Close]: Closes this dialog box. All the results displayed in the [Result] list will be cleared.

This dialog box allows the user to analyze statistical information concerning the trace information. Set the target of analysis in [Item] and the input value or character string by [Start] and [End]. Click the [Result] button after setting a condition by pressing the [New] or [Add] button to analyze the statistical information and display its result in the [Result] list.

Note: In this emulator, only [PTR] can be set as a range. Each of other items must be specified as a character string. In analysis of statistical information, character strings are compared with those displayed in the [Trace] window. Only those that completely match are counted. Note, however, that this test is not case sensitive. The number of blanks will not be cared either.

5.16.15 Extracting Function Calls from the Acquired Trace Information

To extract function calls from the acquired trace information, select [Function Call...] from the popup menu. The [Function Call Display] dialog box will be displayed.

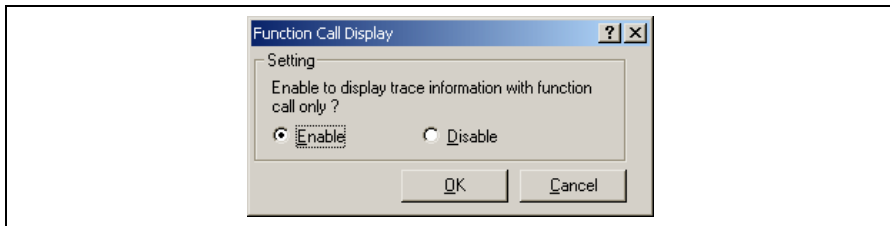

Figure 5.96 [Function Call Display] Dialog Box

[Setting]: Selects whether or not to extract function calls.

[Enable]: Extracts function calls.

[Disable]: Does not extract function calls.

When [Enable] is selected, only the cycles that include function calls are extracted for display from the acquired trace information. The content of the trace buffer is not changed by extraction of function calls. Using this function for the result of the free trace or the trace information that includes function calls allows the user to know the order of function calls.

5.17 Viewing the Function Call History

The [Stack Trace] window shows the function call history.

5.17.1 Opening the [Stack Trace] Window

To open the [Stack Trace] window, choose [View -> Code -> Stack Trace] or click the [Stack Trace] toolbar button ().

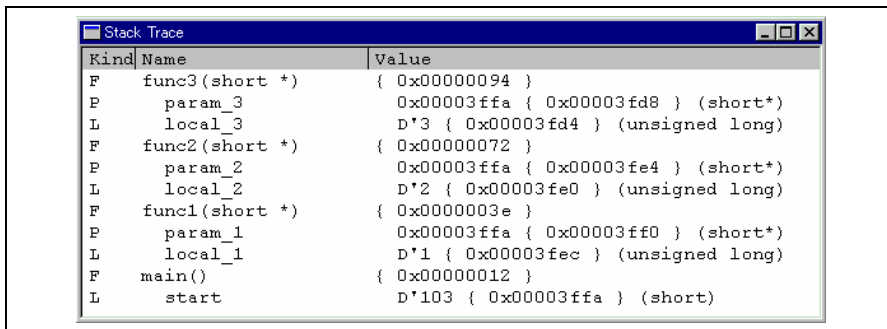

Figure 5.97 [Stack Trace] Window

The following items are displayed.

[Kind]: Indicates the type of the symbol.

F: Function
P: Function parameter
L: Local variable

[Name]: Indicates the symbol name.

[Value]: Indicates the value, address, and type of the symbol.

5.17.2 Viewing the Source Program

Select a function and choose [Go to Source] from the popup menu to display, in the [Source] window, the source program corresponding to the selected function.

5.17.3 Specifying the View

Choose [View Setting...] from the popup menu to open the [Stack Trace Setting] dialog box, which allows the user to specify the [Stack Trace] window settings.

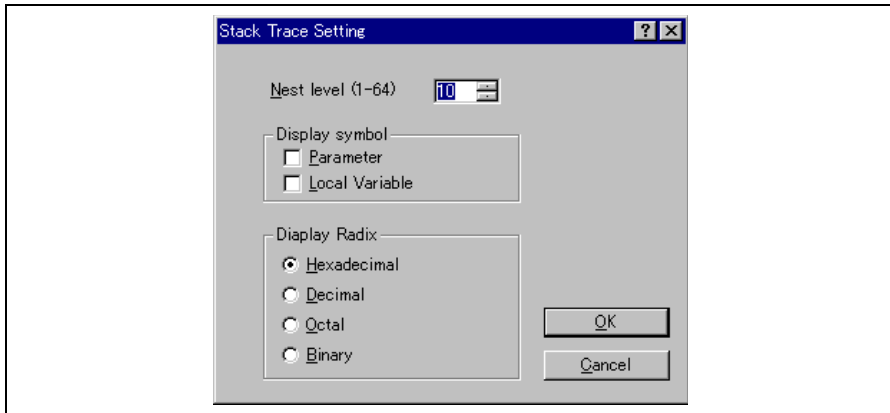

Figure 5.98 [Stack Trace Setting] Dialog Box

[Nest level]: Specifies the level of function call nesting to be displayed in the [Stack Trace] window.

[Display symbol]: Specifies the symbol types to be displayed in addition to functions.

[Display Radix]: Specifies the radix for displays in the [Stack Trace] window.

5.18 Displaying Memory Contents as an Image

The memory contents can be displayed as an image in the [Image] window.

5.18.1 Opening the [Image] Window

Choose [View -> Graphic -> Image...] or click the [Image] toolbar button () to open the [Image Properties] dialog box shown in figure 5.99.

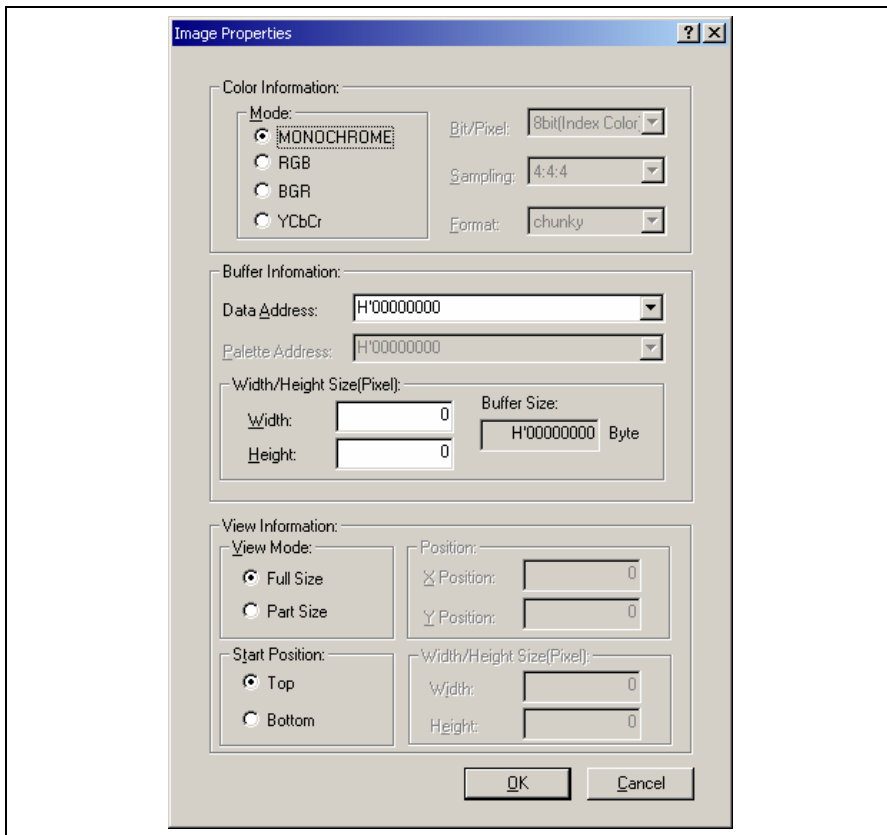

Figure 5.99 [Image Properties] Dialog Box

The [Image Properties] dialog box is used to specify the display method of the [Image] window.

The following items are to be specified:

- [Color Information]: Specifies the color information of the image to be displayed.
- [Mode]: Specifies the format.
[MONOCHROME]: Black and white.
[RGB]: R (red), G (green), and B (blue)
[BGR]: B (blue), G (green), and R (red)
[YCbCr]: Y (luminance), Cb (color difference for blue), and Cr (color difference for red)
- [Bit/Pixel]: Specifies bits/pixel (valid when RGB or BGR is selected).
- [Sampling]: Specifies the format of sampling (valid when YCbCr is selected).
- [Format]: Specifies chunky/planar (valid when YCbCr is selected).
- [Buffer Information]: Specifies the area to store data, size, and the address of the palette.
- [Data Address]: Specifies the first address in memory of the area for display as image data (in hexadecimal notation).
- [Palette Address]: Specifies the first address in memory of the color-palette data (in hexadecimal notation; valid when "8Bit" has been selected for RGB or BGR).
- [Width/Height Size]: Specifies the width and height of the image.
[Width (Pixel)]: Specifies the width of the image (unless a prefix is included, values are treated as decimal numbers).
[Height (Pixel)]: Specifies the height of the image (unless a prefix is included, values are treated as decimal numbers).
[Buffer Size]: Displays the size of the buffer required for image display as obtained from the width and height (in hexadecimal notation).
- [View Information]: Specifies the location, size, and data start location of the part to be displayed among the entire image.
- [View Mode]: Specifies whether display is on all or part of the screen.
[Full Size]: The image is displayed on the whole screen.
[Part Size]: The image is displayed on part of the screen.
- [Start Position]:
[Top]: Display of data starts at the upper-left position.
[Bottom]: Display of data starts at the lower-left position.

- [Position]: Specifies the position on the screen from which image display is to start (valid when [Part Size] is selected).
- [X Position]: Specifies the X-coordinate of the start position (unless a prefix is included, values are treated as decimal numbers).
 - [Y Position]: Specifies the Y-coordinate of the start location (unless a prefix is included, values are treated as decimal numbers).
- [Width/Height Size]: Specifies the height and width of an image to be displayed on part of the screen.
- [Width (Pixel)]: Specifies the width of the display (unless a prefix is included, values are treated as decimal numbers).
 - [Height (Pixel)]: Specifies the height of the display (unless a prefix is included, values are treated as decimal numbers).

After the settings have been made in the [Image Properties] dialog box, clicking the [OK] button opens the [Image] window.

Even after the [Image] window is displayed, the display contents can be modified by opening this dialog box by choosing [Properties...] from the popup menu.



Figure 5.100 [Image] Window

The memory content is displayed as an image.

5.18.2 Automatically Updating the Window Contents

Checking [Auto Refresh] in the popup menu will allow the window contents to be automatically updated when user program execution stops.

5.18.3 Updating the Window Contents

Selecting [Refresh Now] from the popup menu immediately updates the window contents.

5.18.4 Displaying the Pixel Information

Double-clicking within the window displays information on the pixel on which the mouse pointer is located in the [Pixel Information] dialog box.

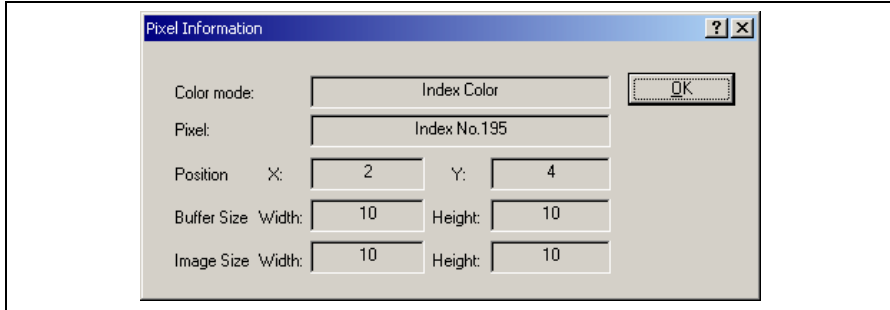

Figure 5.101 [Pixel Information] Dialog Box

This dialog box displays pixel information on the cursor location.

[Color Mode]: Displays the format of the image.

[Pixel]: Displays color information on the pixel under the cursor (in decimal notation).

[Position]: Displays the cursor location in X and Y axis. (Displayed in decimal)

[X]: X coordinate of the cursor..

[Y]: Y coordinate of the cursor.

[Buffer Size]: Displays the buffer size in decimal notation.

[Width]: Width of the buffer.

[Height]: Height of the buffer.

[Image Size]: the width and height of the display in decimal notation.)

[Width]: Width of the display.

[Height]: Height of the display.

5.19 Displaying Memory Contents as Waveforms

Memory contents can be displayed as waveforms in the [Waveform View] window.

5.19.1 Opening the Waveform View Window

Choose [View -> Graphic -> Waveform...] or click the [Waveform] toolbar button  to open the [Waveform Properties] dialog box shown in figure 5.102.

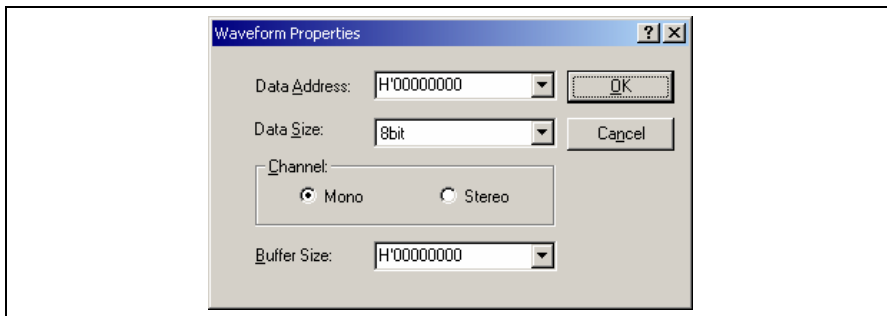

Figure 5.102 [Waveform Properties] Dialog Box

Specifies the waveform format. The following items can be specified.

[Data Address]: Specifies the start address of data in memory (displayed in hexadecimal).

[Data Size]: Selects 8Bit or 16Bit.

[Channel]: Selects Mono or Stereo.

[Buffer Size]: Specifies the buffer size of data (displayed in hexadecimal).

After the settings have been made in the [Waveform Properties] dialog box, clicking the [OK] button opens the [Waveform View] window.

Even after the [Waveform View] window is displayed, the display contents can be modified by opening this dialog box by choosing [Properties...] from the popup menu.

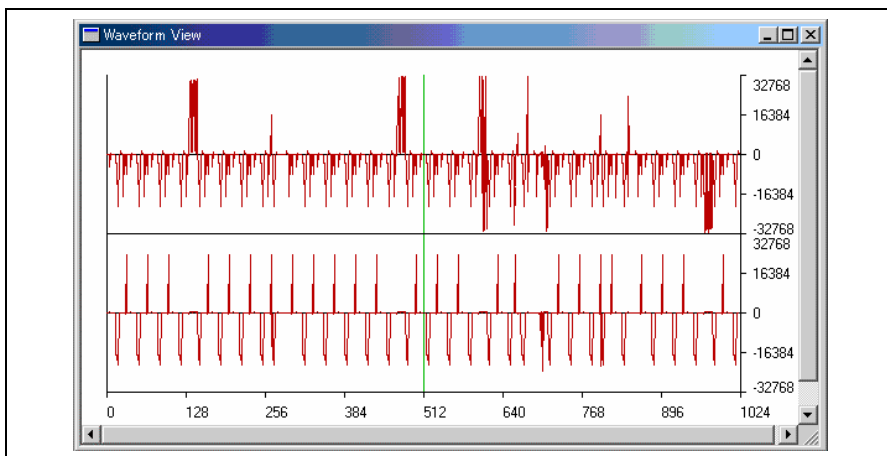

Figure 5.103 [Waveform View] Window

Displays the memory contents as waveforms. The X axis shows the number of sampling data and the Y axis shows the sampling value.

5.19.2 Automatically Updating the Window Contents

Checking [Auto Refresh] in the popup menu will allow the window contents to be automatically updated when user program execution stops.

5.19.3 Updating the Window Contents

Selecting [Refresh Now] from the popup menu immediately updates the window contents.

5.19.4 Zoom-In Display

Selecting [Zoom In] from the popup menu displays the waveforms with the horizontal axis enlarged.

5.19.5 Zoom-Out Display

Selecting [Zoom Out] from the popup menu displays the waveforms with the horizontal axis reduced.

5.19.6 Resetting the Zoom Display

Selecting [Reset Zoom] from the popup menu displays the waveforms in its original size.

5.19.7 Setting the Zoom Magnification

In the [Zoom Magnification] submenu of the popup menu, the zoom magnification can be selected from 2, 4, or 8.

5.19.8 Setting the Horizontal Scale

In the [XScale] submenu of the popup menu, the size of the X axis can be selected from 128, 256, or 512 pixels.

5.19.9 Non-Display of Cursor

Selecting [Clear Cursor] from the popup menu hides the cursor display.

5.19.10 Displaying the Sampling Information

Selecting [Sample Information...] from the popup menu displays the [Sample Information] dialog box.

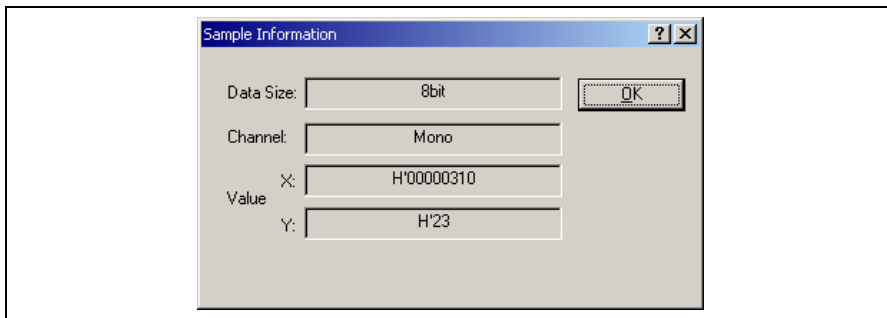

Figure 5.104 [Sample Information] Dialog Box

Displays the sampling information of the cursor location in the [Waveform View] window. The following information is displayed.

[Data Size]: Displays 8bit or 16bit.

[Channel]: Displays the data channel.

[Value]: [X] Displays the X axis of cursor location.

[Y] Displays the Y axis of cursor location (displays Y axes for both the upper and lower plots when Stereo is selected).

5.20 Analyzing Performance

Use the performance analysis function to measure the rate of execution time. The performance analysis function does not affect the realtime operation because it measures the rate of execution time in the specified range by using the circuit for measurement of hardware performance included in the emulator.

Select either of the following five modes according to the purpose of measurement.

Table 5.7 Available Measurement Modes

Mode	Description	Purpose
Time Of Specified Range Measurement	Measures the execution time and execution count in the specified range.	Measurement of time taken for processing of functions except for that required for child functions called from the functions.
Start Point To End Point Measurement	Measures the execution time and execution count between the specified addresses.	Measurement of time taken for processing of functions.
Start Range To End Range Measurement	Measures the execution time from a specified range to another specified range.	Measurement of execution time spent from calling of any of sequential subroutines to calling of any of another sequential subroutines in a program that includes subroutines in sequence, such as an assembly program.
Access Count Of Specified Range Measurement	Measures the number of times a specified range is accessed from another specified range.	Measurement of the number of times a global variable is accessed from a specific function.
Called Count Of Specified Range Measurement	Measures the number of times a specified range has called another specified range.	Measurement of the number of times a function is called from a specific function.

Use eight performance channels installed on the circuit for measurement of hardware performance in the emulator for setting of conditions for measurement. Up to eight points can be set.

Note, however, that up to four points can be set in Start Range To End Range Measurement, Access Count Of Specified Range Measurement, or Called Count Of Specified Range Measurement because two sequential points are used for setting a condition in these modes.

Table 5.8 Mode Settings for Measurement

Page	Point							
	1	2	3	4	5	6	7	8
Time Of Specified Range Measurement	0	0	0	0	0	0	0	0
Start Point To End Point Measurement	0	0	0	0	0	0	0	0
Start Range To End Range Measurement	0	—	0	—	0	—	0	—
Access Count Of Specified Range Measurement	0	—	0	—	0	—	0	—
Called Count Of Specified Range Measurement	0	—	0	—	0	—	0	—

Note: 0: Available
 —: Not available

Note: Only one point is used in Time Of Specified Range Measurement and Start Point To End Point Measurement, while two sequential points are used in Start Range To End Range Measurement, Access Count Of Specified Range Measurement, and Called Count Of Specified Range Measurement. The conditions that have been set will be canceled when switching these modes of different types.

5.20.1 Opening the [Performance Analysis] Window

Choose [View -> Performance -> Performance Analysis] or click the [PA] toolbar button  to open the [Select Performance Analysis Type] dialog box.

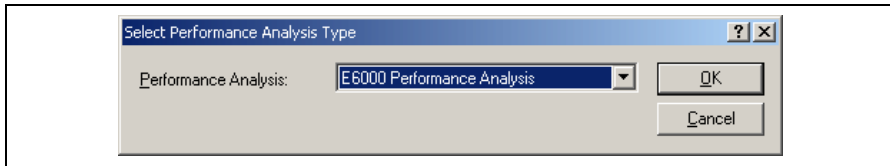
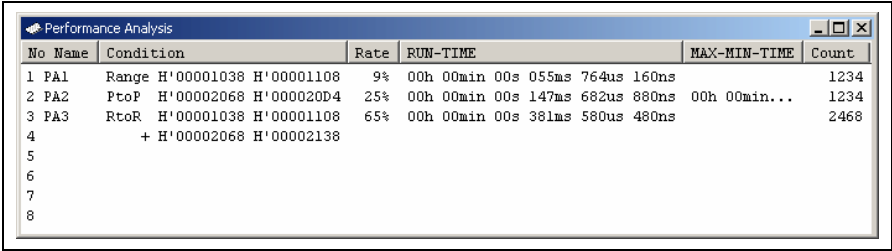

Figure 5.105 [Select Performance Analysis Type] Window

Select [E6000 Performance Analysis] and then click the [OK] button to open the [Performance Analysis] window.



No	Name	Condition	Rate	RUN-TIME	MAX-MIN-TIME	Count
1	PA1	Range H'00001038 H'00001108	9%	00h 00min 00s 055ms 764us 160ns		1234
2	PA2	PtoP H'00002068 H'000020D4	25%	00h 00min 00s 147ms 682us 880ns	00h 00min...	1234
3	PA3	RtoR H'00001038 H'00001108	65%	00h 00min 00s 381ms 580us 480ns		2468
4		+ H'00002068 H'00002138				
5						
6						
7						
8						

Figure 5.106 [Performance Analysis] Window

This window displays the rate of execution time in the area selected by the user during the last program run in percentages, histogram, or numerical values.

It is possible to hide any column not necessary in the [Performance Analysis] window. Selecting a column you want to hide from the popup menu displayed by clicking the right-hand mouse button on the header column hides that column. To display the hidden column, select the column from the said popup menu again.

5.20.2 Setting Conditions for Measurement

Conditions for measurement can be displayed and changed in the [Performance Analysis] window. Select a point where a condition is to be set, and then select [Set...] from the popup menu to display the [Performance Analysis Properties] dialog box.

Select either from the following five modes as the condition by the [Measurement Method] option:

Table 5.9 Conditions for Measurement (Measurement Method)

[Measurement Method] Option
Time Of Specified Range Measurement
Start Point To End Point Measurement
Start Range To End Range Measurement
Access Count Of Specified Range Measurement
Called Count Of Specified Range Measurement

Set a condition for measurement according to the mode being selected. The parameters to be set depend on the modes.

The [Performance Analysis] window has a support function to enter the address range of a function automatically if the name of the function is entered to set an address range. Entering a function name in the [Input Function Range] dialog box displayed by clicking the [...] button on the [Performance Analysis Properties] dialog box automatically enters the address range of the function.

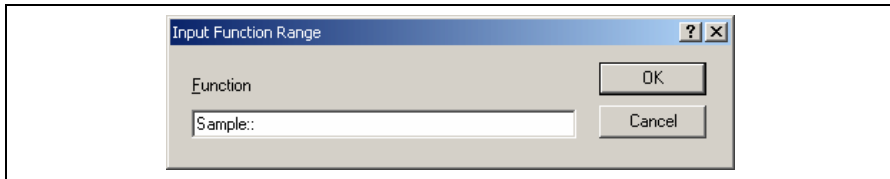

Figure 5.107 [Input Function Range] Window

- Notes:
1. Entering the name of an overload function or a class opens the [Select Function] dialog box. Select a function in this dialog box. For details on the dialog box, refer to section 5.13.3, Supporting Duplicate Labels.
 2. The addresses figured out are just for reference. In some cases, the end address of a function may be different. Check the last instruction of the function in the [Disassembly] window to correct the value set in [End Address] so that it will be the address of the last instruction (in general, the last instruction of a function is a RTS instruction). A label name or an expression can be entered instead of an address value in boxes where an address should be entered.

(1) Time Of Specified Range Measurement

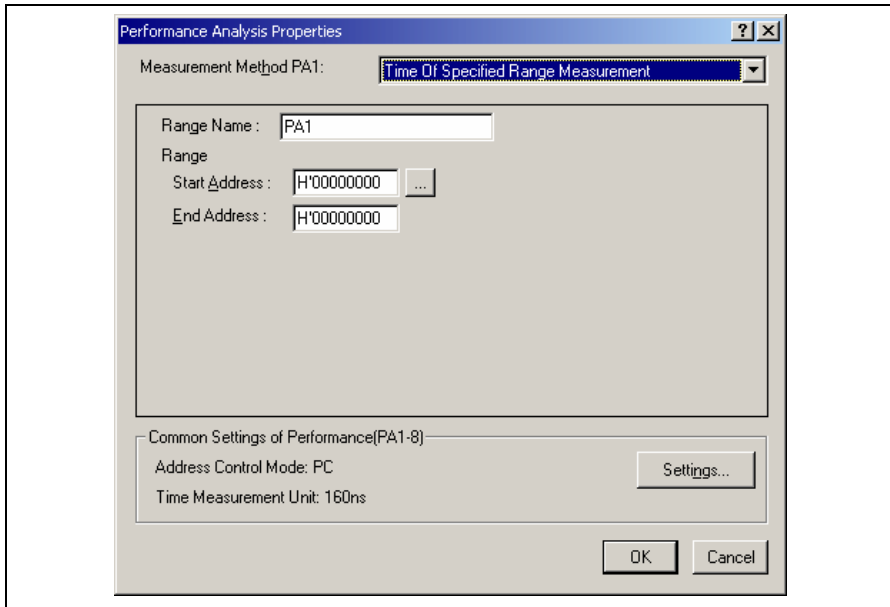

Figure 5.108 Time Of Specified Range Settings

- [Range Name]: The name of the range to be measured
- [Range]: The range for the Time Of Specified Range Measurement
- [Start Address]: Address to start measurement
- [End Address]: Address to end measurement

Measures the execution time and the execution count in the range between the start address and end address. Starts measurement with a detected program prefetch in the range specified between the start and end addresses, and then stops with a detected program prefetch out of the specified range. Measurement can be restarted with a detected program prefetch in the specified range. The execution count is incremented every time the program is prefetched at the end address of the specified range. The execution time measured does not include the time spent while being called from the specified range.

(2) Start Point To End Point Measurement

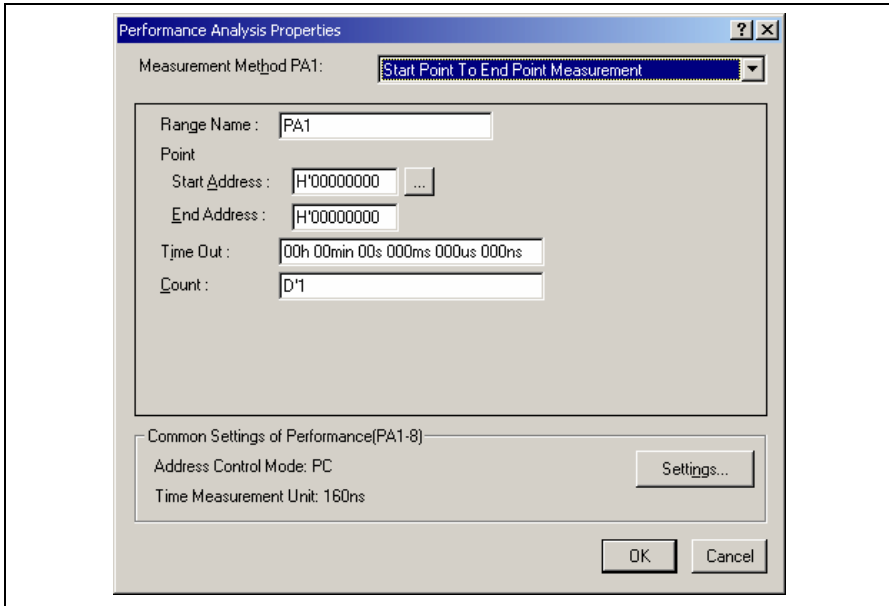

Figure 5.109 Start Point To End Point Measurement Settings

[Range Name]: The name of the range to be measured

[Point]: The range for the Start Point To End Point Measurement

[Start Address]: Address to start measurement

[End Address]: Address to end measurement

[Time Out]: The timeout value to finish measurement. When the minimum time for measurement is 160 ns, 40 ns, or 20 ns, enter the value as follows.
Example: 1h 2min 3s 123ms 456us 789ns

If the CPU operating mode is target, enter a hexadecimal number in 10 digits.
Example: 123456789A

A break occurs every time a value measured in the specified range exceeds the timeout value (not the total time). This is only available for channel 1.

[Count]: The count-up value used in measurement of the execution count. A break occurs every time the execution count exceeds the count-up value. This is only available for channel 1.

Measures the execution time and the execution count in the range between start address and end address. Starts measurement with a detected program prefetch at the start address, and then stops with a detected program prefetch at the end address. The execution count is incremented every time the program is prefetched at the end address of the specified range. The execution time measured includes the time spent while being called from the specified range. When either from one to four points is selected, the maximum and minimum time in the specified range can be measured.

- Notes:
1. When [Time Out] is selected in the Start Point To End Point Measurement mode, the execution time will not be measured correctly.
 2. When [Time Out] and [Count] are selected, satisfaction of either of these options stops execution of the user program (performance break).
 3. Only channel 1 can be used for [Time Out] and [Count]. Use other channels if you do not want to select [Time Out] or [Count] in the Start Point To End Point Measurement mode.

(3) Start Range To End Range Measurement

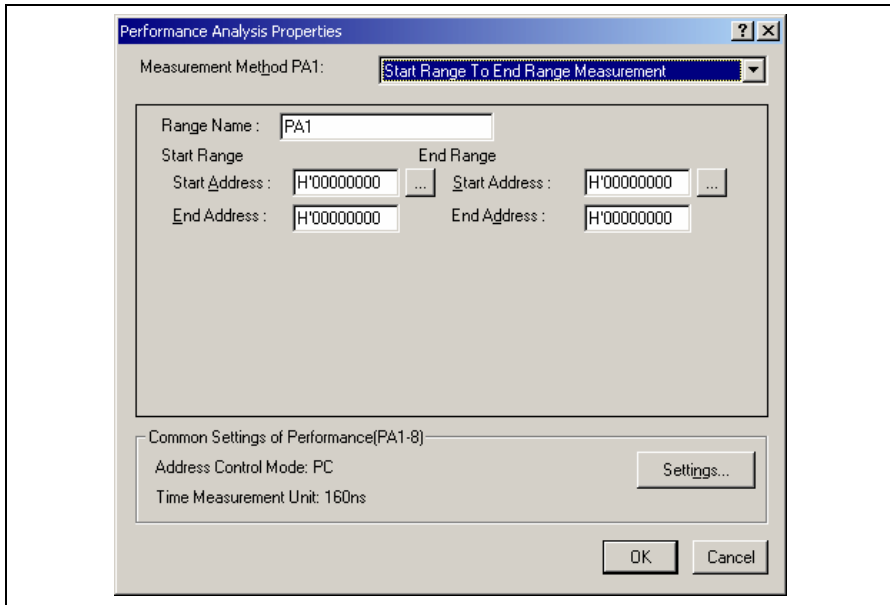

Figure 5.110 Start Range To End Range Measurement Settings

[Range Name]: The name of the range to be measured

[Start Range]: The start range for the Start Range To End Range Measurement

[Start Address]: Start address

[End Address]: End address

[End Range]: The end range for the Start Range To End Range Measurement

[Start Address]: Start address

[End Address]: End address

Starts measurement with a detected prefetch cycle in the specified start address range, and then stops with a detected prefetch cycle in the specified end address range. The execution count is incremented every time the program passes the end address range.

(4) Access Count Of Specified Range Measurement

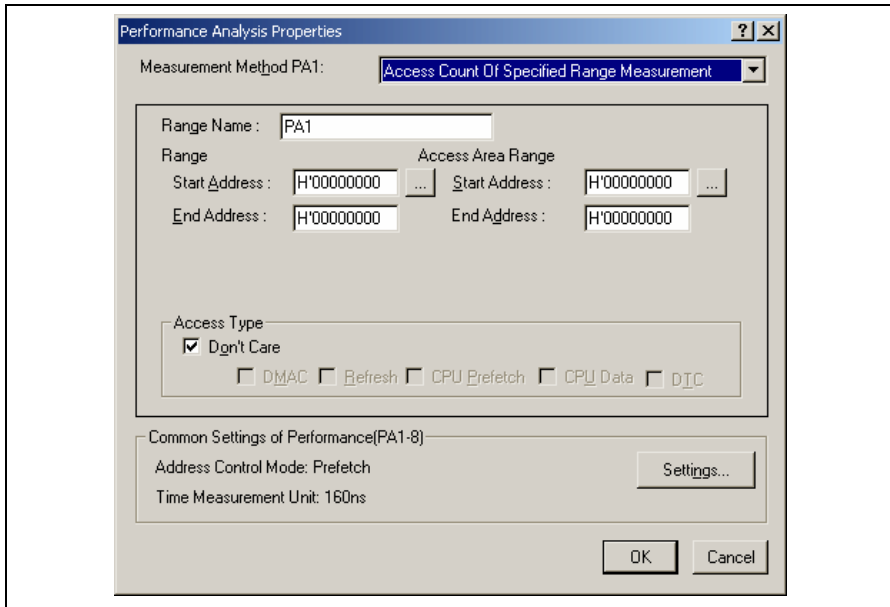

Figure 5.111 Access Count Of Specified Range Measurement Settings

[Range Name]: The name of the range to be measured

[Range]: The range for the Access Count Of Specified Range Measurement

[Start Address]: Start address

[End Address]: End address

[Access Area Range]: The access range for the Access Count Of Specified Range Measurement

[Start Address]: Start address

[End Address]: End address

[Access Type]: The bus cycle on the access range to be measured

Measures the number of times the range specified as the access range is accessed from the range specified by the start and end addresses. The execution count in the range is measured with Time Of Specified Range Measurement mode.

Note: Available bus cycle conditions vary according to the emulator in use. For details, refer to section 5.15.4, Signals to Indicate Bus States and Areas.

(5) Called Count Of Specified Range Measurement

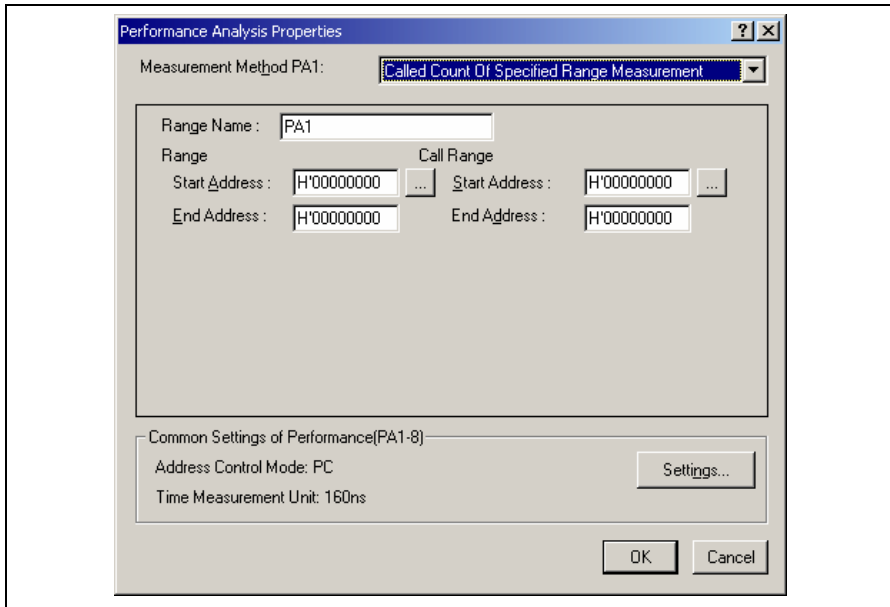

Figure 5.112 Called Count Of Specified Range Measurement Settings

[Range Name]: The name of the range to be measured

[Range]: The range for the Called Count Of Specified Range Measurement

[Start Address]: Start address

[End Address]: End address

[Call Range]: The range for the Called Count Of Specified Range Measurement. As the call range, specify the start and end addresses of the selected subroutine.

[Start Address]: Start address

[End Address]: End address

Measures the number of times the range specified as the call range is called from the range specified by the start and end addresses. The execution time in the specified range can be measured with Time Of Specified Range Measurement mode. As the call range, specify the start and end addresses of the selected subroutine.

5.20.3 Selecting the Address Detection Mode and Resolution

In measurement of hardware performance, there are two types of address detection modes: prefetch address detection mode and PC address detection mode. Select the appropriate address detection mode according to the measurement mode in use. The resolution can also be selected here.

To select an address detection mode and resolution, click the [Settings...] button on the [Performance Analysis Properties] dialog box. The [Common Settings of Performance(PA1-8)] dialog box will be displayed.

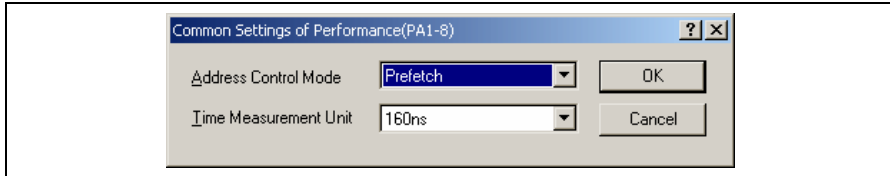

Figure 5.113 [Common Settings of Performance(PA1-8)] Dialog Box

- [Address Control Mode]: Select the method to detect addresses for the rate of execution time.
- PC: PC address detection mode
 - Prefetch: Prefetch address detection mode
- [Time Measurement Unit]: Select the timer resolution to be used for measurement from 160ns, 40ns, 20ns, or Target. The timer for execution time measurement has a 40-bit counter. At 20 ns the maximum time that can be measured is about six hours, and at 160 μ s the maximum time is about two days. When the counter overflows, "Timer Overflow" is displayed as the result of measurement. When Target is selected, the counter is incremented by an input clock. The result of measurement is displayed as 10 digits in hexadecimal.

Select the prefetch address detection mode in Access Count Of Specified Range Measurement, and PC address detection mode in other measurement modes. Otherwise, the result of the measurement will be incorrect.

5.20.4 Starting Performance Data Acquisition

Executing the user program clears the result of previous measurement and automatically starts measuring the rate of execution time according to the conditions that have been set. Stopping the user program displays the result of measurement in the [Performance Analysis] window.

5.20.5 Deleting a Measurement Condition

Select [Reset] from the popup menu with a measurement condition selected to delete the condition.

5.20.6 Deleting All Measurement Conditions

Choose [Reset All] from the popup menu to delete all the conditions that have been set.

5.21 Acquiring Code Coverage

The E6000H emulator acquires code coverage information (C1 coverage) from the address range within the on-chip ROM/RAM/EEPROM area specified by the user and displays the results.

5.21.1 Opening the [Code Coverage] Window

Select [View -> Code -> Code Coverage...] or click the [Code Coverage] toolbar button (). The following dialog box opens when the coverage function is used for the first time after initiation of the emulator.

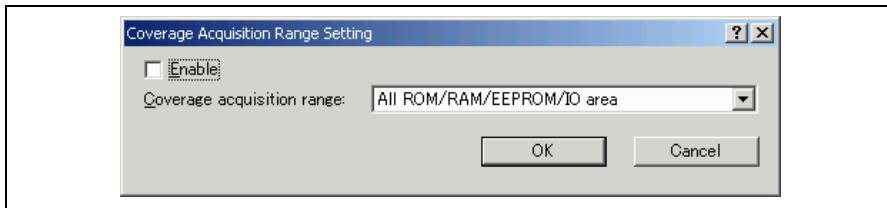

Figure 5.117 [Coverage Acquisition Range Setting] Dialog Box

- | | |
|-------------------------|--|
| [Enable]: | Checking this box allows acquisition of both code coverage information. |
| [Coverage acquisition]: | The E6000H emulator acquires coverage information from the on-chip ROM, on-chip RAM, and on-chip EEPROM areas. |
| [OK]: | Closes this dialog box by storing the settings made. |
| [Cancel]: | Closes this dialog box without storing the settings made. |

This dialog box will only be displayed once after initiation of the emulator. To open this dialog box, select [Hardware Settings...] from the popup menu of the [Code Coverage] window. When the [Coverage Acquisition Range Setting] dialog box is closed, the [Open Coverage] dialog box appears.

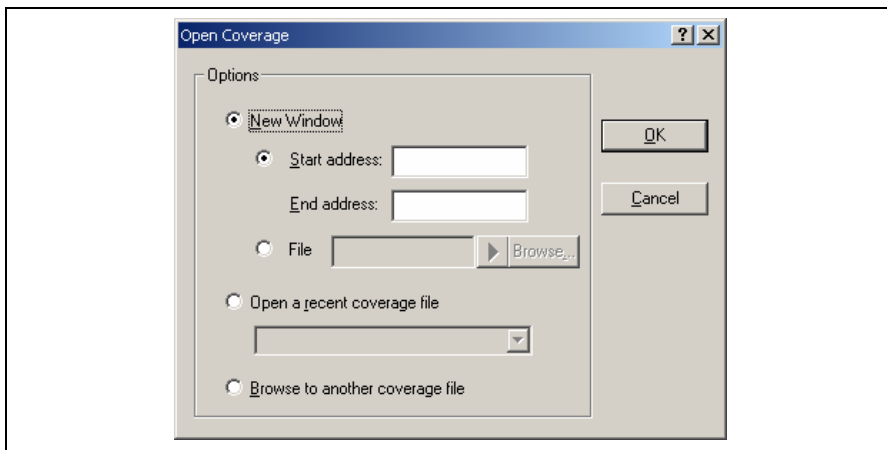

Figure 5.118 [Open Coverage] Dialog Box

In this dialog box, specify a range to be shown in the [Code Coverage] window.

- | | |
|---------------|---------------------------------|
| [New Window]: | Specifies a new coverage range. |
|---------------|---------------------------------|

[Start address]: Enter the start address of coverage information to be displayed (in hexadecimal when the prefix is omitted).

[End address]: Enter the end address of coverage information to be displayed (in hexadecimal when the prefix is omitted).

[File]: Specifies a source file that has “.C” or “.CPP” as its file type name from the current project. This allows a function included in the specified file to be set as the coverage range. “.C” will automatically be specified if the file type name is omitted. Files with a type name other than “.C” or “.CPP” cannot be specified here. A placeholder or the [Browse...] button can be used.

[Open a recent coverage file]: Lists up to four files that were saved most recently. Select one from the list.

[Browse to another coverage file]: Allows specification of a file not included in the list.

Clicking the [OK] button in this dialog box opens the [Code Coverage] window. The display format differs depending on which the user has specified; an address range or a source file.

[Code Coverage] Window (Specifying an Address)

Range	Statistic	Executed	Pass	Address	Assembler	Source
H'00001000- H'000010ff	-	0	-	00001000	JSR @sp regv43:24	char *sbk(size t size) /* Assigned
		0	-	00001004	MOV.L @ bkr:24,ER6	if(bkr+size>heap area.heap+HEAPSIZE) /*
		0	-	0000100c	MOV.L ER6,ER1	
		0	-	0000100e	ADD.L ER0,ER1	
		0	-	00001010	MOV.L #'00FFCE00,ER2	
		0	-	00001016	CMP.L ER2,ER1	
		0	-	00001018	BLS @H'1020:8	
		0	-	0000101a	SUB.L ER0,ER0	return (char *)-1 ;
		0	-	0000101c	DEC.L #1,ER0	
		0	-	0000101e	BRA @H'102E:8	
		0	-	00001020	MOV.L ER6,ER1	p=bkr ; /* Area assignm
		0	-	00001022	ADD.L ER0,ER6	bkr += size ; /* End address
		0	-	00001024	MOV.L ER6,@ bkr:24	
		0	-	0000102c	MOV.L ER1,ER0	return p ;
		0	-	0000102e	JMP @spreg1d243:24	}
		0	-	00001032	ESR @tutorial():8	tutorial();
		0	-	00001034	BRA @ main:8	while (1){
		0	-	00001036	JSR @sp regv43:24	void tutorial(void)
		0	-	0000103a	SUB.W #'0028,R7	
		0	-	0000103e	MOV.L ER7,ER3	{

Figure 5.119 [Code Coverage] Window (Specifying an Address)

The [Code Coverage] window is divided into two by the splitter.

- **Left-hand window**

Displays the coverage range and statistical information of the coverage. The items are displayed as follows:

[Range]: Address range

[Statistic]: C0 coverage value (in percentage)

The percentage will be displayed in the [Statistic] column by selecting [Percentage] from the popup menu on the left-hand window.

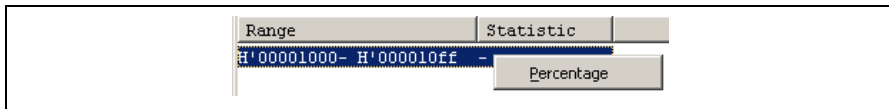

Figure 5.120 Percentage Shown in the [Code Coverage] Window

- **Right-hand window**

Displays coverage information at the C/C++ or assembly-language level. The items are displayed as follows:

[Executed]: 1 (the instruction was executed) or 0 (the instruction was not executed)

[Pass]: Condition for execution of a conditional branch instruction.
 T: The condition was satisfied.
 F: The condition was not satisfied.
 T/F: The condition was satisfied in one case and not satisfied in another.

[Address]: Instruction address

[Assembler]: Disassembled program

[Source]: C/C++ or assembly source program

[Code Coverage] Window (Specifying a Source File)

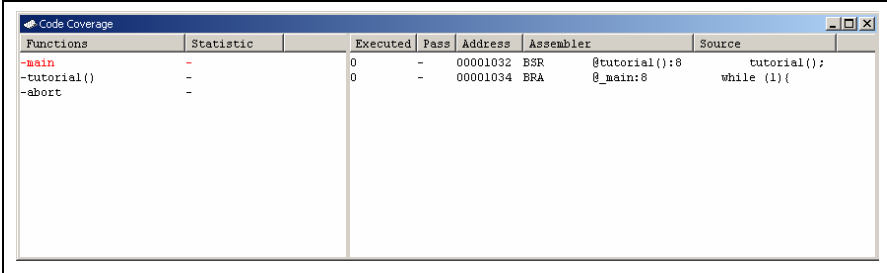

Functions	Statistic	Executed	Pass	Address	Assembler	Source
-main	-	0	-	00001032	BSR	@tutorial():8 tutorial();
-tutorial()	-	0	-	00001034	BR	@_main:8 while (1){
-abort	-					

Figure 5.121 [Code Coverage] Window (Specifying a Source File)

This window is divided into two by the splitter.

- **Left-hand window**

Displays the coverage range and statistical information of the coverage. The items are displayed as follows:

[Functions]: Function to be selected for coverage

[Statistic]: C0 coverage value (in percentage)

The percentage will be displayed in the [Statistic] column by selecting [Percentage] from the popup menu in the left-hand window. Clicking the column tab allows the function names or C0 coverage values to be listed in descending or ascending order.

- **Right-hand window**

Displays coverage information of the function selected by double-clicking on the left-hand window at the C/C++ or assembly-language level. The items are displayed as follows:

[Executed]: 1 (the instruction was executed) or 0 (the instruction was not executed)

[Pass]: Condition for execution of a conditional branch instruction.
T: The condition was satisfied.
F: The condition was not satisfied.
T/F: The condition was satisfied in one case and not satisfied in another.

[Address]: Instruction address

[Assembler]: Disassembled program

[Source]: C/C++ or assembly source program

5.21.2 Displaying a Source File

Selecting [Display a Source File] from the popup menu opens the [Editor] window, which displays the source file for the address at the cursor location on the [Code Coverage] window.

5.21.3 Changing the Address to be Displayed

Selecting [Go To Address...] from the popup menu opens the [Go To Address] dialog box, which allows the user to change the address to be displayed in the [Code Coverage] window.

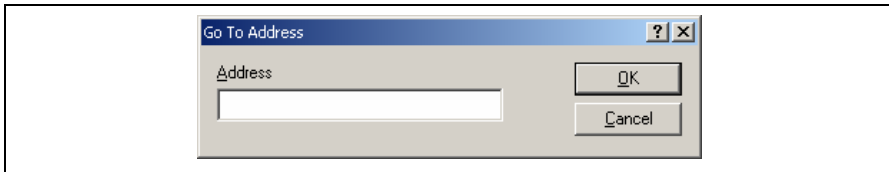

Figure 5.122 [Go To Address] Dialog Box

5.21.4 Changing the Coverage Range to be Displayed

- **When the coverage range for display has been specified by address**

Selecting [Set Range...] from the popup menu opens the [Coverage Display Range] dialog box, which allows the user to change the condition for acquisition of information on executed instructions.

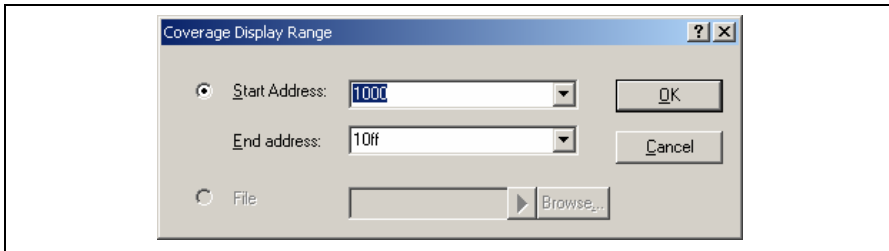

Figure 5.123 [Coverage Display Range] Dialog Box

The following items can be specified.

[Start Address]: Start address (in hexadecimal when the prefix is omitted)

[End Address]: End address (in hexadecimal when the prefix is omitted)

Clicking the [OK] button changes the coverage range to be displayed.

- **When the coverage range for display has been specified by a source file**

Selecting [Set Range...] from the popup menu opens the [Coverage Display Range] dialog box, which allows the user to change the condition for acquisition of information on executed instructions.

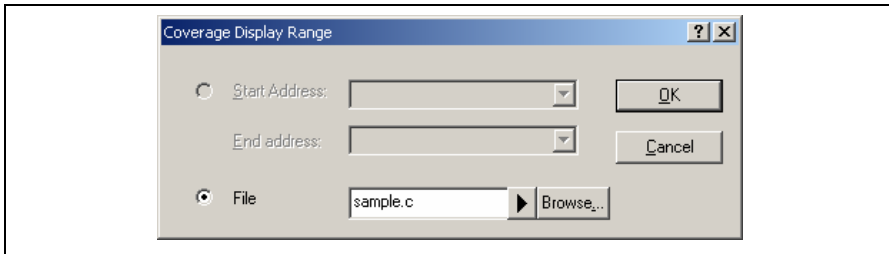

Figure 5.124 [Coverage Display Range] Dialog Box (Specifying a Source File)

The following item can be specified.

[File]: Specifies a source file that has “.C” or “.CPP” as its file type name from the current project. This allows a function included in the specified file to be set as the coverage range. “.C” will be provided if the file type name is omitted. Files with a type name other than “.C” or “.CPP” cannot be specified here. A placeholder or the [Browse...] button can be used.

Clicking the [OK] button changes the coverage range to be displayed.

5.21.5 Clearing the Coverage Information

- **Clearing the coverage information of the specified range**

Selecting [Clear Coverage Range...] from the popup menu opens the [Clear Coverage Range] dialog box.

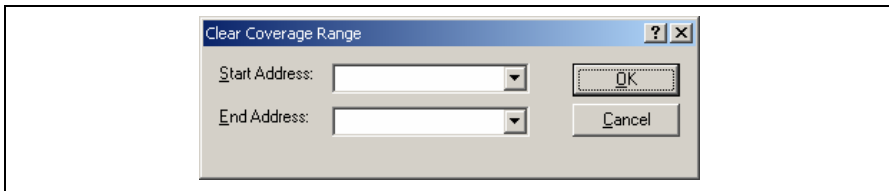

Figure 5.125 [Clear Coverage Range] Dialog Box

Enter the start and end addresses of the range to be cleared. Clicking the [OK] button clears the coverage information of the selected range.

- **Clearing all the coverage information**

Selecting [Clear the Entire Coverage] from the popup menu clears all the coverage information.

5.21.6 Saving the Coverage Information to a File

Selecting [Save Data...] from the popup menu opens the [Save Coverage Data] dialog box.

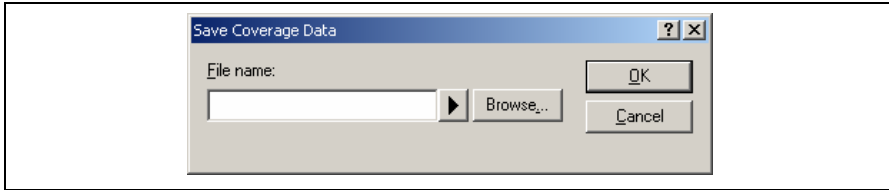

Figure 5.126 [Save Coverage Data] Dialog Box

Specify the location of the coverage information file to be saved and its name. A placeholder or the [Browse...] button can be used. If the file extension is omitted, “.COV” will automatically be added as the file extension. An error message will appear if a file extension other than “.COV” or “.TXT” is entered.

5.21.7 Loading Coverage Information from a File

Selecting [Load Data...] from the popup menu opens the [Load Data] dialog box.

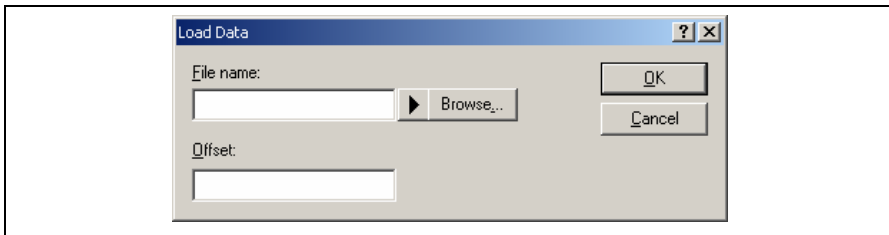

Figure 5.127 [Load Data] Dialog Box

Specify the location of the coverage information file to be loaded. A placeholder or the [Browse...] button can be used. The only file extension available is “.COV”. An error message will appear if any other file extension is entered.

Note: If the coverage range has been specified by a source file, the saved “.COV” file cannot be loaded.

5.21.8 Updating Coverage Information

Selecting [Refresh] from the popup menu updates the content of the [Code Coverage] window.

5.21.9 Preventing Update of Coverage Information

Selecting [Lock Refresh] from the popup menu prevents update of the [Code Coverage] window while the user program execution is stopped. This also prevents access to the emulator for acquisition of coverage information.

5.21.10 [Confirmation Request] Dialog Box

- **Clearing code coverage information or closing the [Code Coverage] window**

A confirmation dialog box appears before clearing code coverage information or closing the [Code Coverage] window.

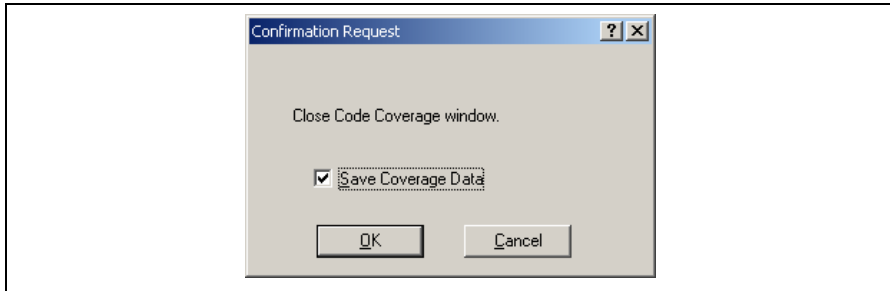

Figure 5.128 [Confirmation Request] Dialog Box

When [Save Coverage Data] is checked, the coverage data can be saved into a file before clearing. Clicking the [OK] button clears the coverage information.

- **When [File -> Save Session] has been selected**

When one or more [Code Coverage] windows are open, the number of [Save Code Coverage] dialog boxes to be opened is the same as that of the [Code Coverage] window(s). The data of the windows can be saved separately or together.

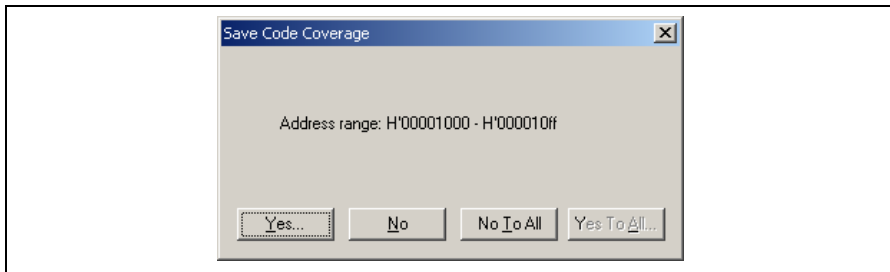

Figure 5.129 [Save Code Coverage] Dialog Box

Clicking [No To All] closes this dialog box without saving any coverage information. Clicking [Yes To All] saves data of all the [Code Coverage] windows into one file.

5.21.11 Displaying Code Coverage Information in the [Editor] Window

Highlighting the debugger column that corresponds to a source line where an instruction has been executed allows the coverage information to also be displayed in the [Editor] window. If the user changes any setting regarding the coverage information in the [Code Coverage] window, the content of the corresponding debugger column will also be updated.

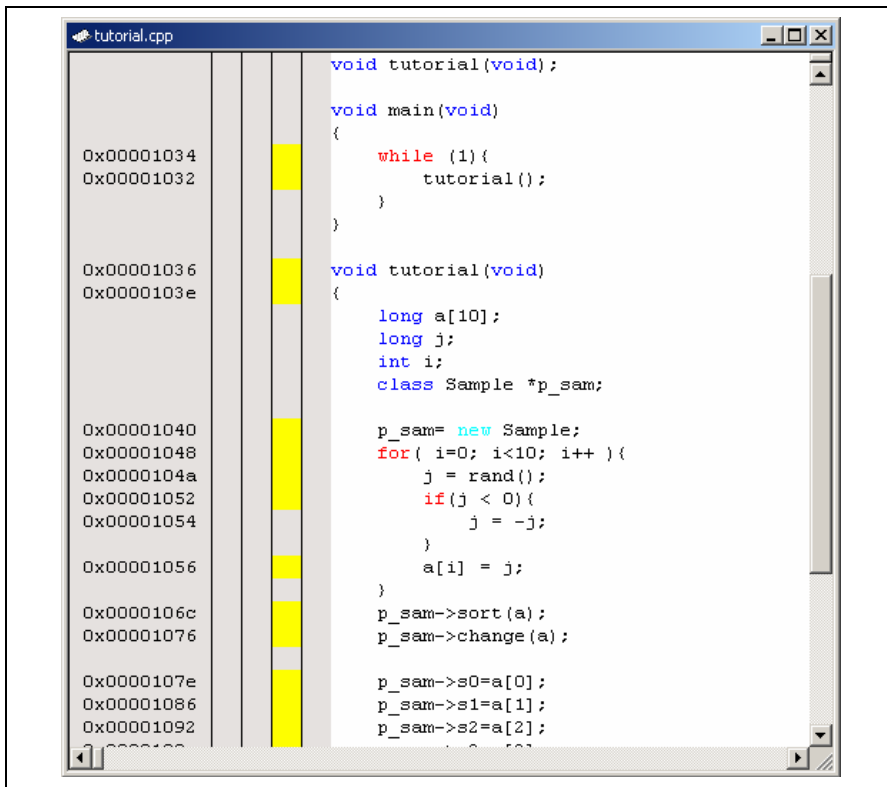

Figure 5.130 Debugger Column (Coverage)

Section 6 Tutorial

6.1 Introduction

The following describes the main functions of the emulator by using a tutorial program.

The tutorial program is based on the C++ program that sorts ten random data items in ascending or descending order. The tutorial program performs the following actions:

- The `main` function repeatedly calls the `tutorial` function to repeat sorting.
- The `tutorial` function generates random data to be sorted and calls the `sort` and `tutorial` functions in order.
- The `sort` function enters the array where the random data generated by the `tutorial` function are stored, and sorts them in ascending order.
- The `change` function then sorts the array, which was sorted in ascending order by the `sort` function, in descending order.

The file `tutorial.cpp` contains source code for the tutorial program. The file `Tutorial.abs` is a compiled load module in the Dwarf2 format.

- Notes:
1. After recompilation, the addresses may differ from those given in this section.
 2. This section describes general usage examples for the emulator. For the specifications of particular products, refer to section 8, Software Specifications Specific to This Product, or the online help.
 3. The operation address of `Tutorial.abs` attached to each product differs according to products. Replace the address used in this section with the relevant address in each product after checking that it is placed on the corresponding line of the source program.
 4. In this tutorial, the H8S/2633 E6000 emulator is taken as an example. File paths or the appearance of figures differs according to products.

6.2 Running the HEW

Open a workspace by following the procedure listed in section 4.2.3, Selecting an Existing Workspace.

Select the following directory:

HEW installation destination directory\Tools\Renesas\DebugComp\Platform\E6000\2633\Tutorial

Note: The file path differs depending on the product. Refer to section 8.2.1, Environment for Execution of the Tutorial Program.

Then select the file indicated below.

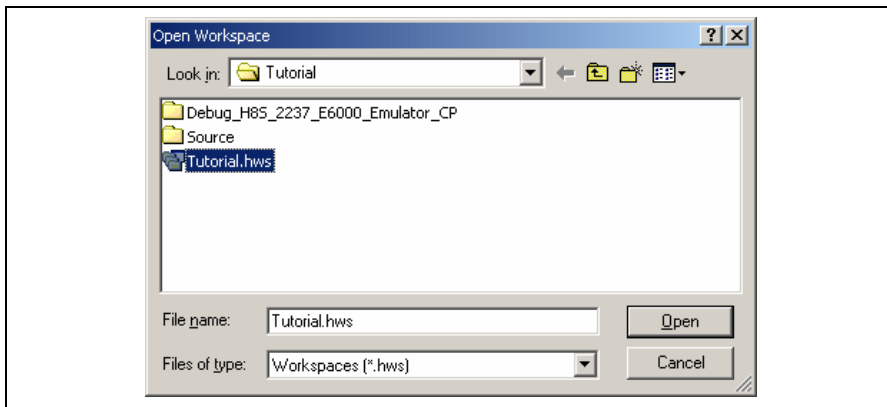

Figure 6.1 [Open Workspace] Dialog Box

Opening this workspace automatically connects the emulator.

6.3 Downloading the Tutorial Program

6.3.1 Downloading the Tutorial Program

Download the object program to be debugged.

- Select [Download module] from [Tutorial.abs] of [Download modules].

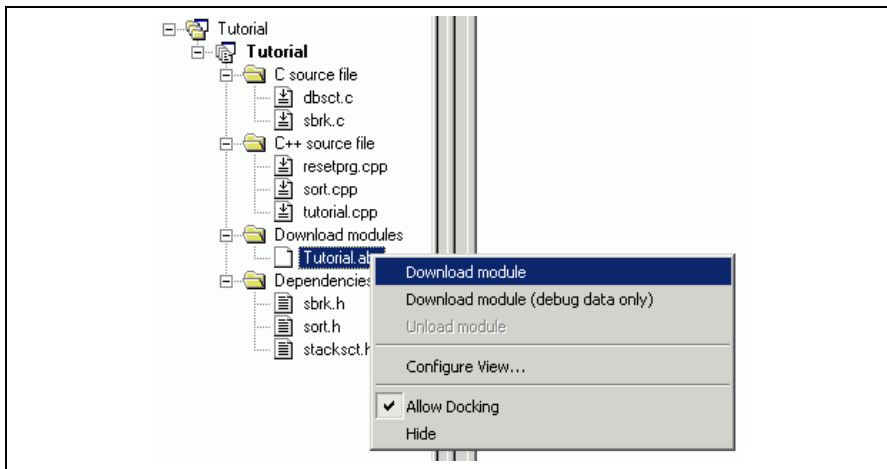

Figure 6.2 Downloading the Tutorial Program

6.3.2 Displaying the Source Program

The HEW allows the user to debug a user program at the source level.

- Double-click [Tutorial.cpp] under [C++ source file].

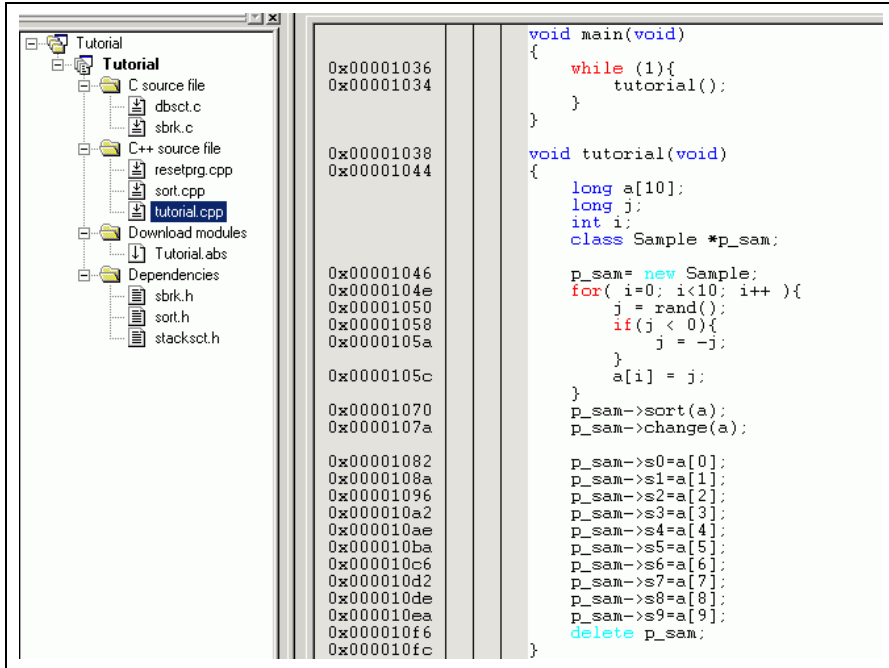

Figure 6.3 [Source] Window (Displaying the Source Program)

- Select a font and size that are legible if necessary. For details, refer to section 4, Using the Editor in the HEW part.

Initially the [Source] window shows the start of the user program, but the user can use the scroll bar to scroll through the user program and look at the other statements.

6.4 Setting a PC Breakpoint

A PC breakpoint is a simple debugging function.

The [Source] window provides a very simple way of setting a PC breakpoint at any point in a program. For example, to set a PC breakpoint at the `sort` function call:

- Select by double-clicking the [Editor] column on the line containing the `sort` function call.

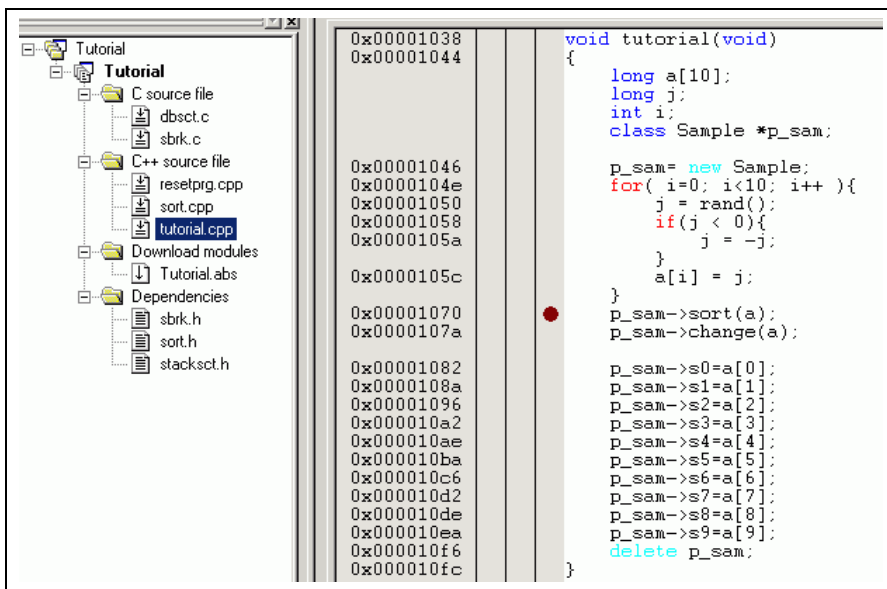

Figure 6.4 [Source] Window (Setting a PC Breakpoint)

The symbol • will appear on the line containing the `sort` function. This shows that a PC breakpoint has been set.

6.5 Setting Registers

Set a value of the program counter before executing the program.

- Select [Registers] from the [CPU] submenu of the [View] menu. The [Register] window is displayed.

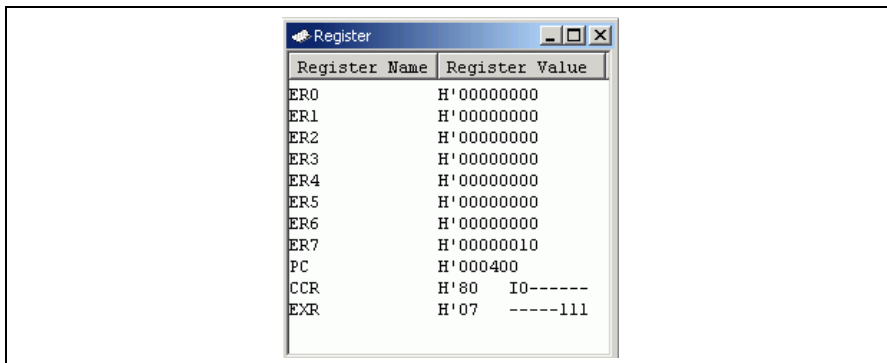

Figure 6.5 [Register] Window

- To change the value of the program counter (PC), double-click the value area in the [Register] window with the mouse. The following dialog box is then displayed, and the value can be changed. Set the program counter to H'0000400 in this tutorial program, and click the [OK] button.

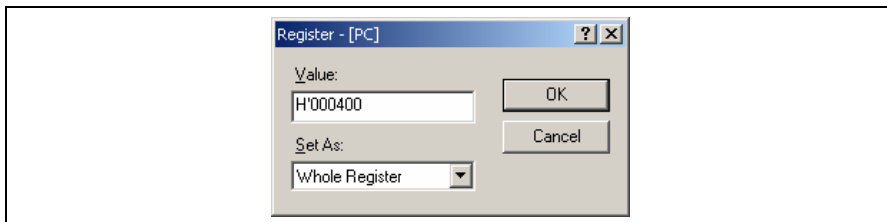

Figure 6.6 [Register] Dialog Box (PC)

6.6 Executing the Program

Execute the program as described in the following:

- To execute the program, select [Go] from the [Debug] menu, or click the [Go] button on the toolbar.

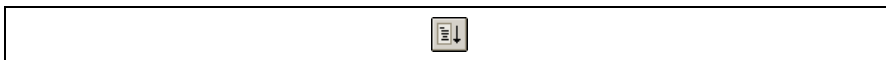

Figure 6.7 [Go] Button

While the program is executing, the current address bus value and the operating state of the MCU are displayed on the status bar.

The program will be executed up to the breakpoint that has been set, and an arrow will appear on the [Editor] column in the [Source] window to show the position that the program has halted, with the message [Break = PC Break] in the status bar.

Note: When the source file is displayed after a break, a path of the source file may be inquired. The location of the source file is as follows:

```
HEW installation destination directory\Tools\Renesas\DebugComp\Platform
\E6000\2633\Tutorial\source
```

The file path differs according to products. If necessary, replace \2633 with another name.

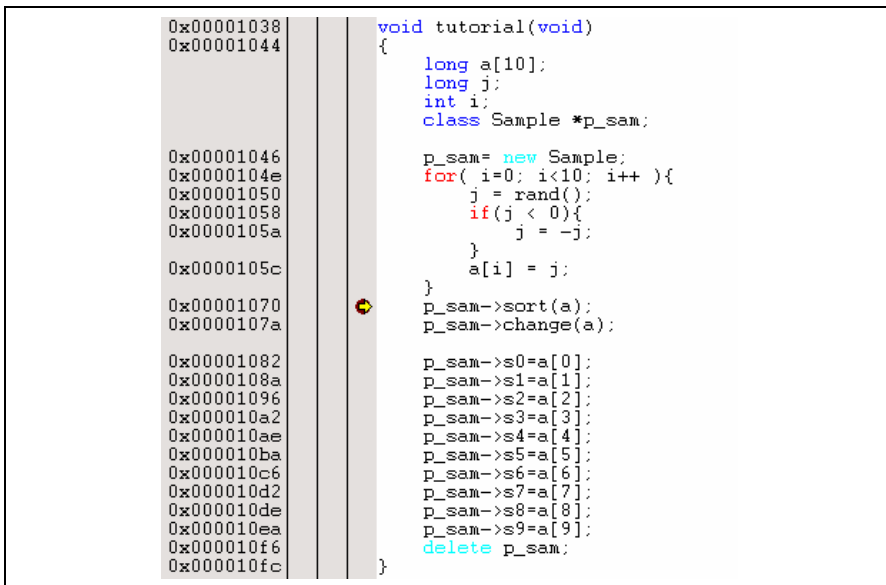

Figure 6.8 [Source] Window (Break Status)

The user can see the cause of the break that occurred last time in the [Status] window.

- Select [Status] from the [CPU] submenu of the [View] menu. After the [Status] window is displayed, open the [Platform] sheet, and check the Status of Cause of last break.

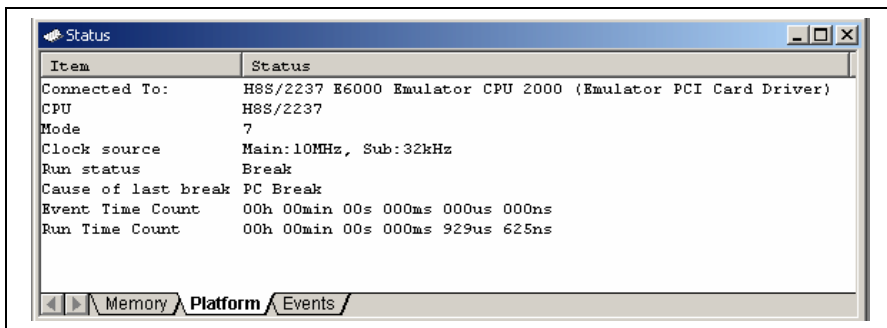

Figure 6.9 [Status] Window

Note: The items that can be displayed in this window differ depending on the product. For the items that can be displayed, refer to section 8, Software Specifications Specific to This Product, or the online help.

6.7 Reviewing Breakpoints

The user can see all the breakpoints set in the program in the [Event] window.

- Select [Eventpoints] from the [Code] submenu of the [View] menu. The [Event] window is displayed. Select the [Breakpoint] sheet.

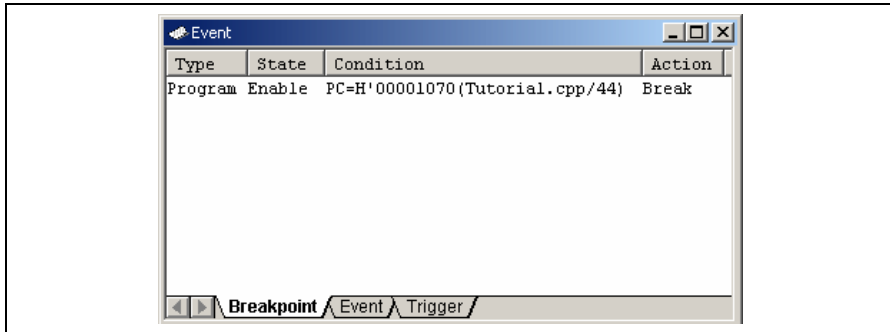

Figure 6.10 [Event] Window

The popup menu, opened by clicking the [Event] window with the right-hand mouse button, allows the user to set or change breakpoints, define new breakpoints, and delete, enable, or disable breakpoints.

6.8 Referring to Symbols

The [Label] window can be used to display the information on symbols in modules.

Select [Label] from the [Symbol] submenu of the [View] menu. The [Label] window is displayed so that the user can refer to the addresses of symbols in modules.

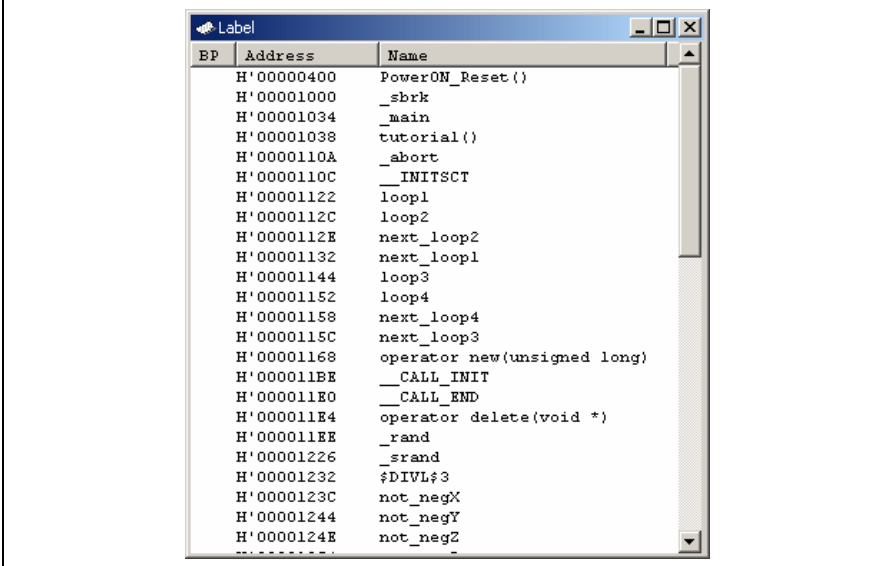

The screenshot shows a window titled "Label" with a table of symbols. The table has three columns: "BP", "Address", and "Name". The symbols listed include various functions and variables such as PowerON_Reset(), _sbrk, _main, tutorial(), _abort, __INIT\$CT, loop1, loop2, next_loop2, next_loop1, loop3, loop4, next_loop4, next_loop3, operator new(unsigned long), __CALL_INIT, __CALL_END, operator delete(void *), _rand, _srand, \$DIVL\$3, not_negX, not_negY, and not_negZ.

BP	Address	Name
	H'00000400	PowerON_Reset()
	H'00001000	_sbrk
	H'00001034	_main
	H'00001038	tutorial()
	H'0000110A	_abort
	H'0000110C	__INIT\$CT
	H'00001122	loop1
	H'0000112C	loop2
	H'0000112E	next_loop2
	H'00001132	next_loop1
	H'00001144	loop3
	H'00001152	loop4
	H'00001158	next_loop4
	H'0000115C	next_loop3
	H'00001168	operator new(unsigned long)
	H'000011BE	__CALL_INIT
	H'000011E0	__CALL_END
	H'000011E4	operator delete(void *)
	H'000011EE	_rand
	H'00001226	_srand
	H'00001232	\$DIVL\$3
	H'0000123C	not_negX
	H'00001244	not_negY
	H'0000124E	not_negZ
	-

Figure 6.11 [Label] Window

6.9 Viewing Memory

When the label name is specified, the user can view the memory contents that the label has been registered in the [Memory] window. For example, to view the memory contents corresponding to `_main` in byte size:

- Select [Memory ...] from the [CPU] submenu of the [View] menu to enter `_main` in the [Start address] edit box and `+ff` in the [End address] edit box, respectively, and to select `Byte` in the [Format] combo box.

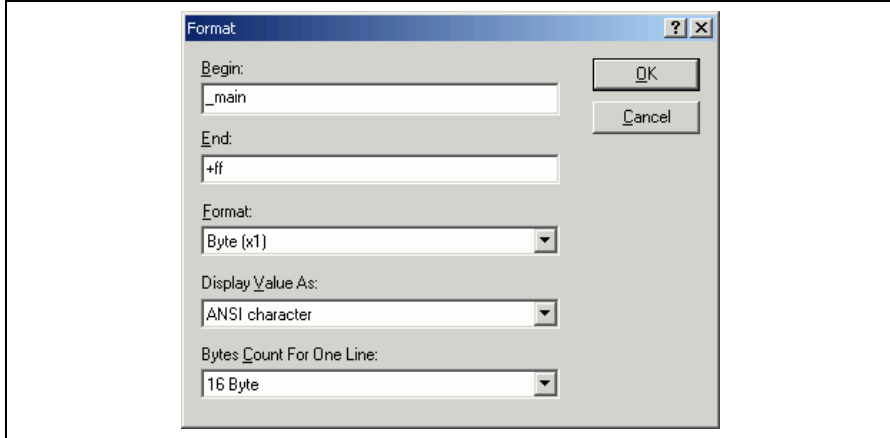

Figure 6.12 [Set Address] Dialog Box

- Click the [OK] button. The [Memory] window showing the selected area of memory is displayed.

Address	+0	+1	+2	+3	+4	+5	+6	+7	+8	+9	+A	+B	+C	+D	+E	+F	Value
0x00001034	55	02	40	FC	01	00	6D	F3	01	20	6D	F4	79	37	00	28	U.g...m...y?.(
0x00001044	0F	F3	1A	80	5E	00	20	00	0F	86	19	44	5E	00	11	F0	...^...D^...
0x00001054	17	F0	0F	85	4C	02	17	B5	17	F4	0F	C0	10	70	0A	B0	...L...p...
0x00001064	01	00	69	85	0E	54	79	24	00	0A	4D	E0	0F	B5	0F	D1	...i...Tys...M...
0x00001074	0F	E0	5E	00	20	68	0F	D1	0F	E0	5E	00	20	D6	01	00	...h...oP...
0x00001084	69	50	01	00	69	E0	01	00	6F	50	00	04	01	00	6F	E0	iP...i...oP...
0x00001094	00	04	01	00	6F	50	00	08	01	00	6F	E0	00	08	01	00	oP...oP...
0x000010A4	6F	50	00	0C	01	00	6F	E0	00	0C	01	00	6F	50	00	10	oP...oP...
0x000010B4	01	00	6F	E0	00	10	01	00	6F	50	00	14	01	00	6F	E0	oP...oP...
0x000010C4	00	14	01	00	6F	50	00	18	01	00	6F	E0	00	18	01	00	oP...oP...
0x000010D4	6F	50	00	1C	01	00	6F	E0	00	1C	01	00	6F	50	00	20	oP...oP...
0x000010E4	01	00	6F	E0	00	20	01	00	6F	55	00	24	01	00	6F	E5	oP...oU...\$...
0x000010F4	00	24	0F	E0	5E	00	11	E6	79	17	00	28	01	20	6D	76	...\$...y...(.mv
0x00001104	01	00	6D	73	54	70	54	70	54	70	6D	F2	01	20	6D	F4	...msTpTp...m...
0x00001114	7A	00	00	00	15	D4	7A	01	00	00	15	DC	FA	00	40	10	z...z...z...@...
0x00001124	01	00	6D	04	01	00	6D	05	40	02	6C	DA	1F	D4	45	FA	...m...@...l...E...

Figure 6.13 [Memory] Window

6.10 Watching Variables

As the user steps through a program, it is possible to watch that the values of variables used in the user program are changed. For example, set a watch on the long-type array `a` declared at the beginning of the program, by using the following procedure:

- Click the left of displayed array `a` in the [Source] window to position the cursor.
- Select [Instant Watch...] with the right-hand mouse button.

The following dialog box will be displayed.

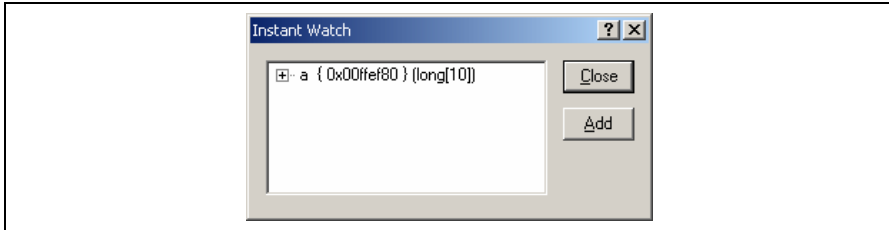

Figure 6.14 [Instant Watch] Dialog Box

- Click the [Add] button to add a variable to the [Watch] window.

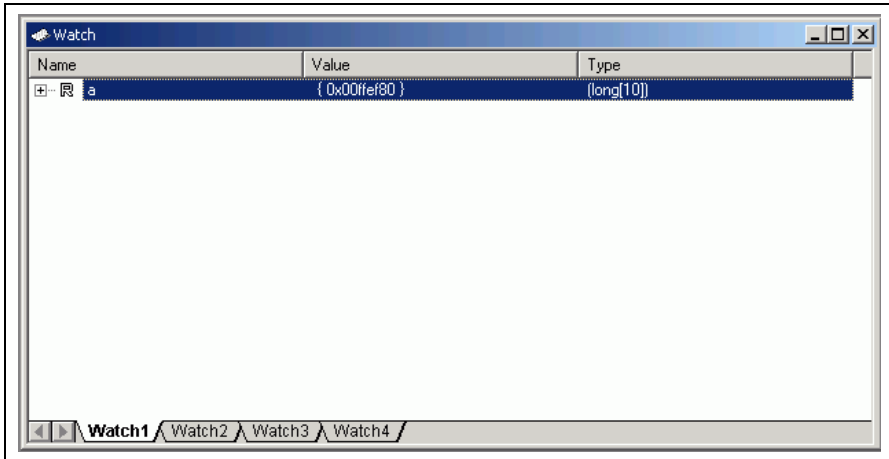

Figure 6.15 [Watch] Window (Displaying the Array)

The user can also add a variable to the [Watch] window by specifying its name.

- Click the [Watch] window with the right-hand mouse button and select [Add Watch...] from the popup menu.

The following dialog box will be displayed.

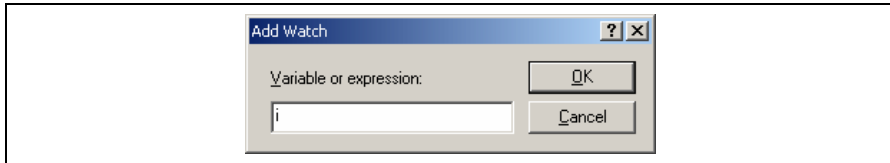

Figure 6.16 [Add Watch] Dialog Box

- Input variable `i` to [Variable or expression] edit box and click the [OK] button.

The [Watch] window will now also show the int-type variable `i`.

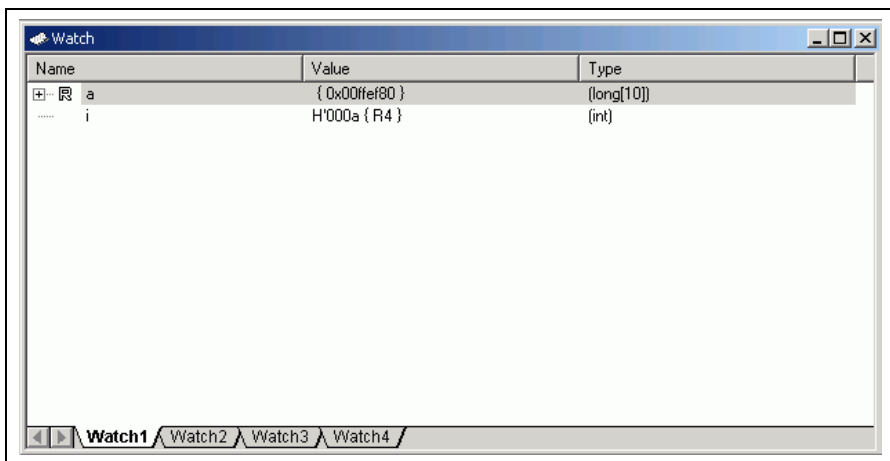

Figure 6.17 [Watch] Window (Displaying the Variable)

The user can click mark '+' at the left side of array a in the [Watch] window to watch all the elements.

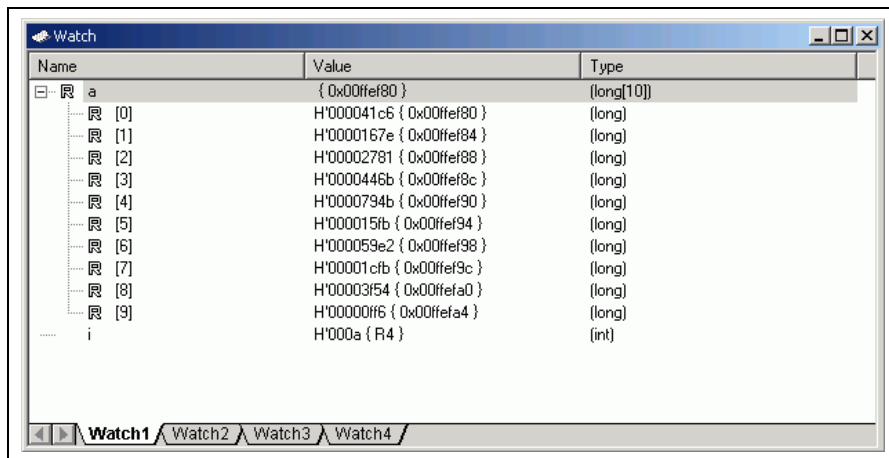

Figure 6.18 [Watch] Window (Displaying Array Elements)

6.11 Displaying Local Variables

The user can display local variables in a function using the [Locals] window. For example, we will examine the local variables in the `tutorial` function, which declares four local variables: `a`, `j`, `i`, and `p_sam`.

- Select [Locals] from the [Symbol] submenu of the [View] menu. The [Locals] window is displayed.

The [Locals] window shows the local variables in the function currently pointed to by the program counter, along with their values. Note, however, that the [Locals] window is initially empty because local variables are yet to be declared.

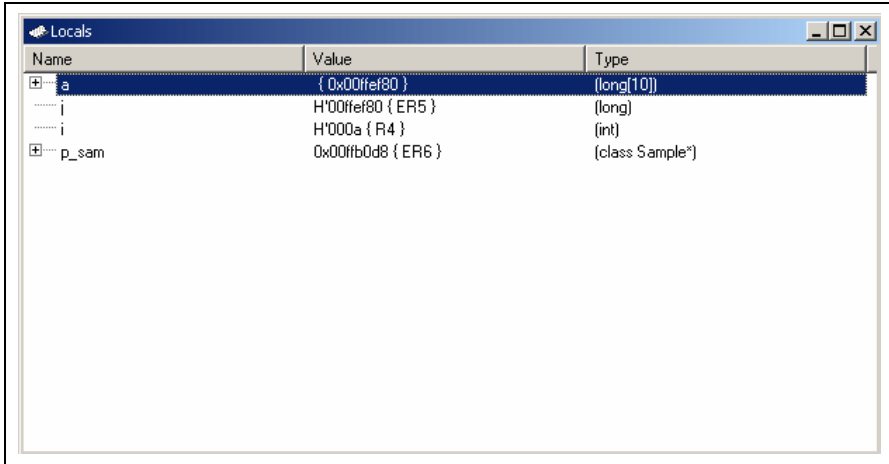

Figure 6.19 [Locals] Window

- Click mark '+' at the left side of array `a` in the [Locals] window to display the elements.
- Refer to the elements of array `a` before and after the execution of the `sort` function, and confirm that random data is sorted in descending order.

6.12 Stepping Through a Program

The HEW provides a range of step menu commands that allow efficient program debugging.

Table 6.1 Step Option

Menu Command	Description
Step In	Executes each statement, including statements within functions.
Step Over	Executes a function call in a single step.
Step Out	Steps out of a function, and stops at the statement following the statement in the program that called the function.
Step...	Steps the specified times repeatedly at a specified rate.

6.12.1 Executing the [Step In] Command

The [Step In] command steps into the called function and stops at the first statement of the called function.

- To step through the `sort` function, select [Step In] from the [Debug] menu, or click the [Step In] button in the toolbar.

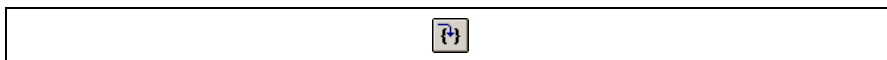

Figure 6.20 [Step In] Button

0x00002000	Sample::Sample()
0x00002006	{
0x0000201c	s0=0;
0x00002026	s1=0;
0x0000202c	s2=0;
0x00002032	s3=0;
0x00002038	s4=0;
0x0000203e	s5=0;
0x00002044	s6=0;
0x0000204a	s7=0;
0x00002050	s8=0;
0x00002056	s9=0;
0x00002060	}
0x00002068	void Sample::sort(long *a)
0x00002070	{
	long t;
	int i, j, k, gap;
0x00002072	gap = 5;
0x00002076	while(gap > 0){
0x00002078	for(k=0; k<gap; k++){
0x0000207c	for(i=k+gap; i<10; i=i+gap){
0x00002080	for(j=i-gap; j>=k; j=j-gap){
0x00002084	if(a[j]>a[j+gap]){
	t = a[j];
	a[j] = a[j+gap];
0x000020a4	a[j+gap] = t;
0x000020a8	}
	else
	break;
	}
	}
	}
	gap = gap/2;
0x000020c0	}
0x000020cc	}

Figure 6.21 [Source] Window (Step In)

- The highlighted line moves to the first statement of the sort function in the [Source] window.

6.12.2 Executing the [Step Out] Command

The [Step Out] command steps out of the called function and stops at the next statement of the calling statement in the main function.

- To step out of the `sort` function, select [Step Out] from the [Debug] menu, or click the [Step Out] button in the toolbar.



Figure 6.22 [Step Out] Button

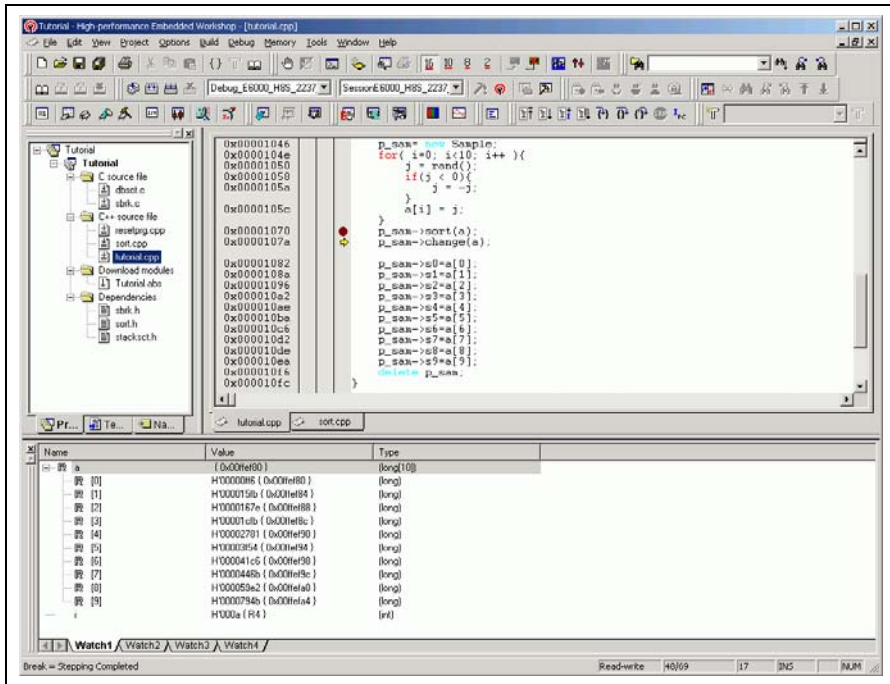

Figure 6.23 [HEW] Window (Step Out)

The data of variable `a` displayed in the [Watch] window is sorted in ascending order.

6.12.3 Executing the [Step Over] Command

The [Step Over] executes a function call as a single step and stops at the next statement of the main program.

- To step through all statements in the change function at a single step, select [Step Over] from the [Debug] menu, or click the [Step Over] button in the toolbar.

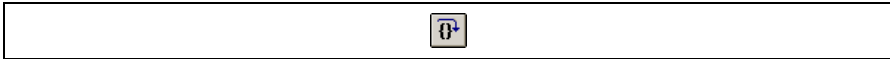

Figure 6.24 [Step Over] Button

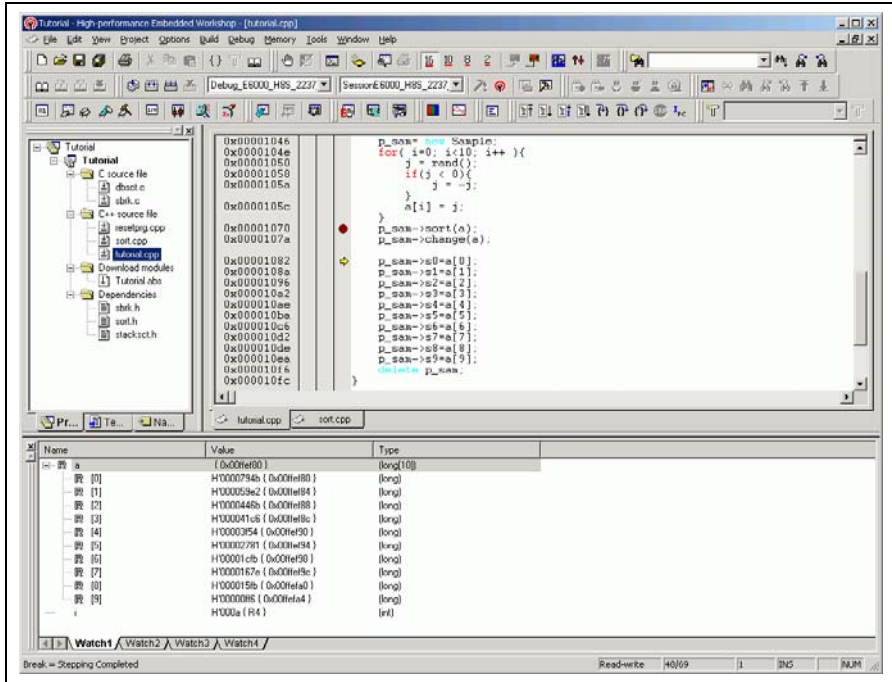

Figure 6.25 [HEW] Window (Step Over)

6.13 Forced Breaking of Program Executions

The HEW can force a break in the execution of a program.

- Cancel all the breaks.
- To execute the remaining sections of the tutorial function, select [Go] from the [Debug] menu or the [Go] button on the toolbar.

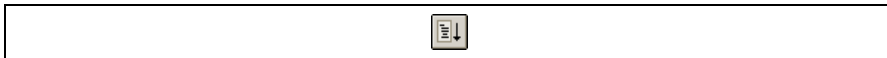

Figure 6.26 [Go] Button

- The program goes into an endless loop. To force a break in execution, select [Halt] from the [Debug] menu or the [Halt] button on the toolbar.



Figure 6.27 [Halt] Button

6.14 Resetting the MCU

Resetting the MCU initializes the internal I/O registers and makes the program counter jump to the address set in the reset vector.

To reset the MCU, select [Reset CPU] from the [Debug] menu or the [Reset CPU] button on the toolbar.

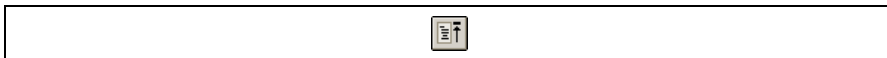

Figure 6.28 [Reset CPU] Button

To execute the program from the reset vector, select [Reset Go] from the [Debug] menu or the [Reset Go] button on the toolbar.

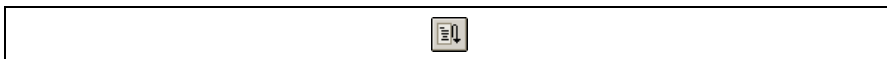

Figure 6.29 [Reset Go] Button

Note: This tutorial program is executable from the reset vector.

6.15 Break Function

The emulator's break functions are of two types: PC breaks and breaks at event points. PC breakpoints and event points are set in the HEW's [Event] window.

An overview and setting of the break function are described below.

6.15.1 PC Break Function

The emulator can set up to 256 PC breakpoints.

- Select [Eventpoints] from the [Code] submenu of the [View] menu. The [Event] window is displayed.
- Select the [Breakpoint] sheet.

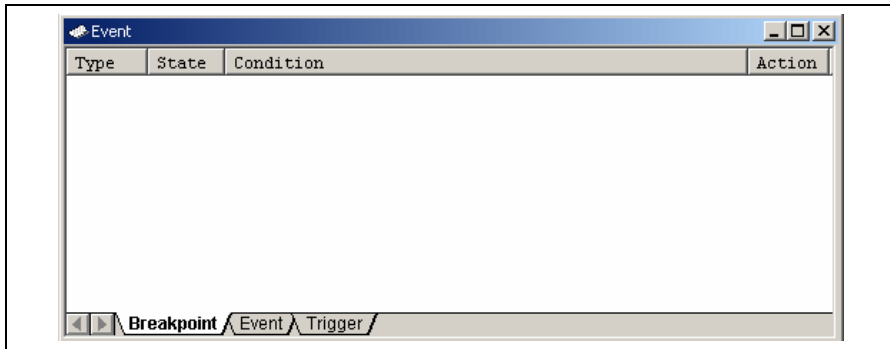

Figure 6.30 [Event] Window (Before Setting a PC Breakpoint)

- Click the [Event] window with the right-hand mouse button and select [Add...] from the popup menu.
- The [Breakpoint/Event Properties] dialog box is displayed.

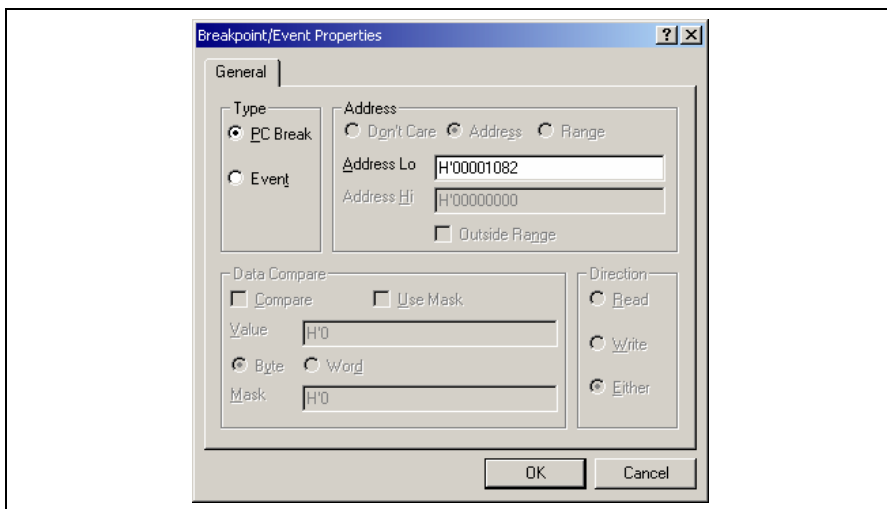

Figure 6.31 [Breakpoint/Event Properties] Dialog Box

- Check the [PC Break] radio button in the [Type] group box.
- Use the [Source] window to refer to the address on the line that has 'p_sam->s0=a[0];' within the tutorial function and enter this address in the [Address Lo] edit box of the [Address] group box. In this example, enter *H'00001082*.

Note: This dialog box differs according to the product. For the items of each product, refer to section 8, Software Specifications Specific to This Product, or the online help.

- Click the [OK] button.

The PC breakpoint that has been set is displayed in the [Event] window.

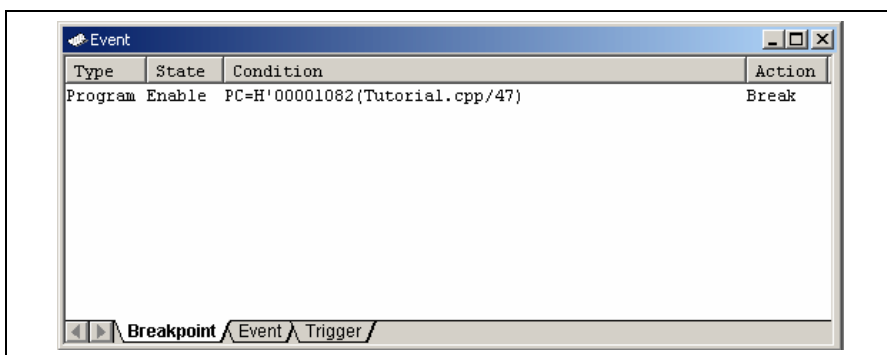

Figure 6.32 [Event] Window (PC Breakpoint Setting)

Note: The items that can be displayed in this window differ depending on the product. For the items that can be displayed, refer to section 8, Software Specifications Specific to This Product, or the online help.

- Close the [Event] window.
- To stop the tutorial program at the breakpoint, select [Reset Go] from the [Debug] menu.

The program runs until it stops at the breakpoint that has been set.

```

0x00001038 | void tutorial(void)
0x00001044 | {
           |     long a[10];
           |     long j;
           |     int i;
           |     class Sample *p_sam;
           |
0x00001046 |         p_sam= new Sample;
0x0000104e |         for( i=0; i<10; i++ ){
0x00001050 |             j = rand();
0x00001058 |             if(j < 0){
0x0000105a |                 j = -j;
           |             }
0x0000105c |             a[i] = j;
           |         }
0x00001070 |         p_sam->sort(a);
0x0000107a |         p_sam->change(a);
           |
0x00001082 |         p_sam->s0=a[0];
0x0000108a |         p_sam->s1=a[1];
0x00001096 |         p_sam->s2=a[2];
0x000010a2 |         p_sam->s3=a[3];
0x000010ae |         p_sam->s4=a[4];
0x000010ba |         p_sam->s5=a[5];
0x000010c6 |         p_sam->s6=a[6];
0x000010d2 |         p_sam->s7=a[7];
0x000010de |         p_sam->s8=a[8];
0x000010ea |         p_sam->s9=a[9];
0x000010f6 |         delete p_sam;
0x000010fc |     }

```

Figure 6.33 [Source] Window at Execution Stop (PC Break)

The [Status] window displays the following contents:

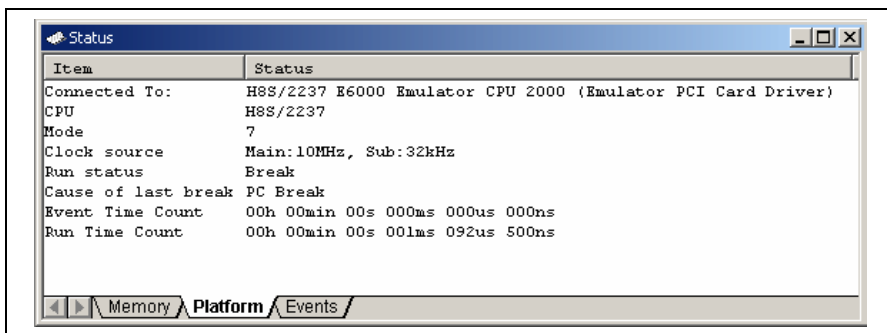

Figure 6.34 Displayed Contents of the [Status] Window (PC Break)

Note: The items that can be displayed in this window differ depending on the product. For the items that can be displayed, refer to section 8, Software Specifications Specific to This Product, or the online help.

6.15.2 Breaking Execution at Event Points

Setting up of an event point on event channel 1 (Ch1) such that a break is triggered when the event point's conditions have been satisfied five times is explained as an example of the use of event points.

- Select [Eventpoints] from the [Code] submenu of the [View] menu. The [Event] window is displayed.
- The breakpoint that has been previously set must be deleted. Click the [Breakpoints] window with the right-hand mouse button and select [Delete All] from the popup menu to delete all the breakpoints that have been set.
- Click the [Event] tab.

Up to 12 event points (eight event channels and four range channels) can be set up as independent conditions. In this example, we are setting the condition for event channel 1.

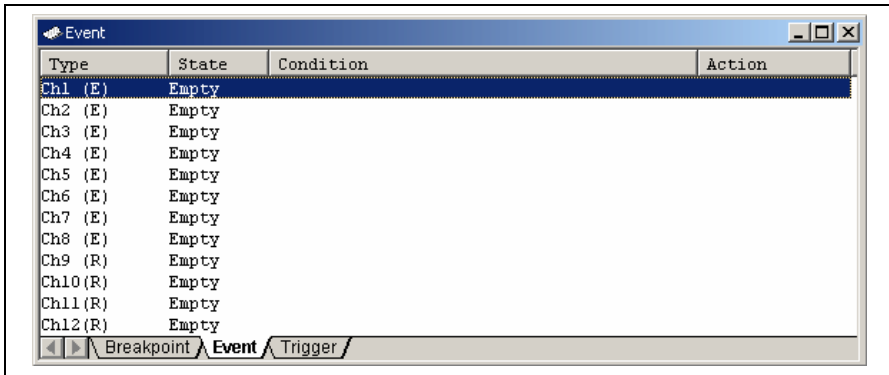

Figure 6.35 [Event] Window (Event Channel 1 [Ch1])

- Select the line for Ch1 in the [Event] window. Double-click on this line that is highlighted.
- The [Breakpoint/Event Properties] dialog box is displayed.
- Make the following settings in the boxes on the [General] page:
 - Select the [Event] radio button in the [Type] group box.
 - Select the [Address] radio button in the [Address] group box. Then use the [Source] window to refer to the address on the line that has 'a[i]=j;' within the tutorial function and enter this address in the [Address Lo] edit box. In this example, enter `H'0000105c`.
- Enter `D'5` as the number of times the event condition is to be satisfied in the [Required number of event occurrences] edit box on the [Action] page.

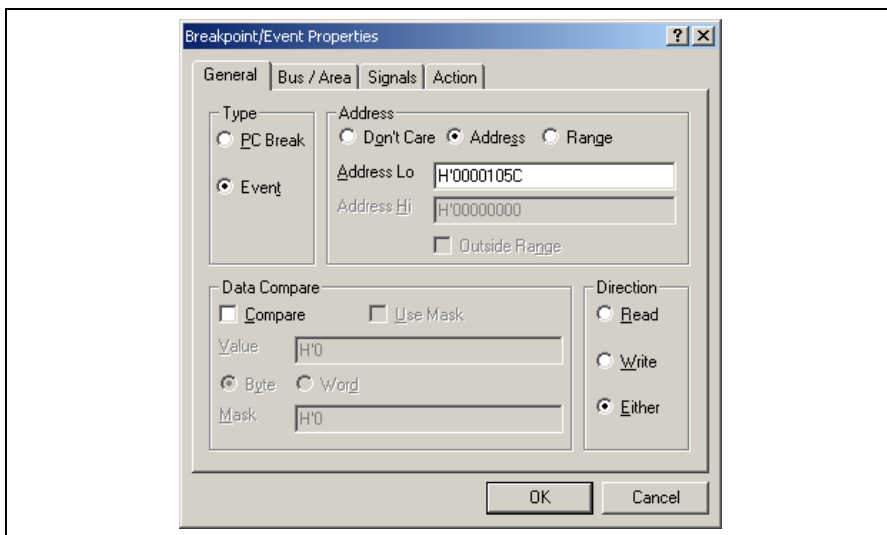

Figure 6.36 [General] Page ([Breakpoint/Event Properties] Dialog Box)

- Click the [OK] button. The [Event] window is displayed, as shown below.

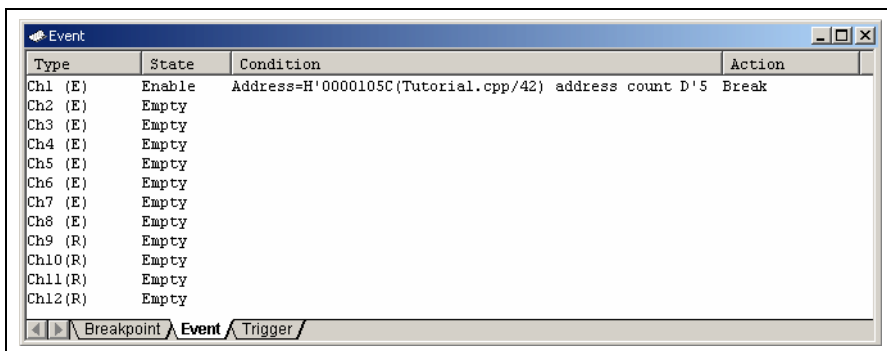

Figure 6.37 [Event] Window (Setting Completed)

Note: The items that can be displayed in this window differ depending on the product. For the items that can be displayed, refer to section 8, Software Specifications Specific to This Product, or the online help.

Select [Reset Go] from the [Debug] menu to stop the tutorial program at breakpoints.

The program runs then stops at the condition specified under Ch1.

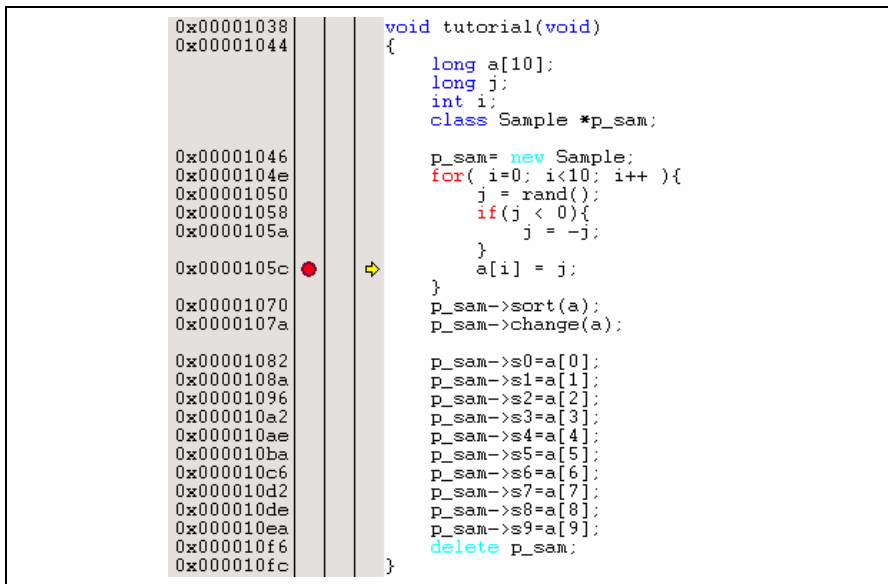

Figure 6.38 [Source] Window at Execution Stop

The [Status] window displays the following contents.

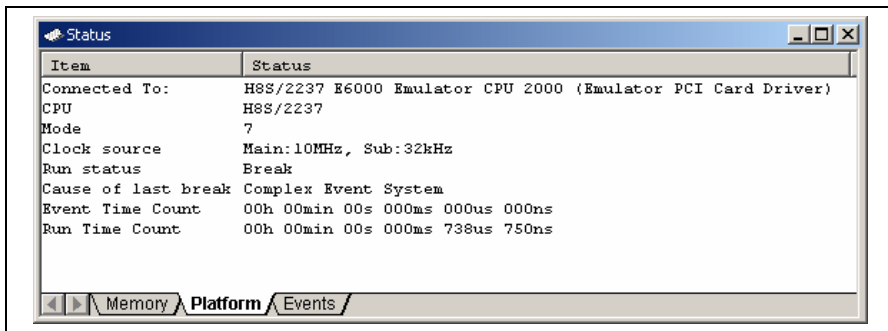

Figure 6.39 Displayed Contents of the [Status] Window

Refer to the [Watch] window for the value of variable *i*. The value is 4, indicating that the break occurred after the condition had been satisfied five times.

Note: The items that can be displayed in this window differ depending on the product. For the items that can be displayed, refer to section 8, Software Specifications Specific to This Product, or the online help.

Remove the event point. Clicking the right-hand mouse button on the [Event] window displays a popup menu. Select [Remove All] from this menu to remove all event points.

6.16 Trace Functions

The trace functions of the emulator use the realtime trace buffer, which is able to store the information on up to 32,768 bus cycles. The content of this buffer, which is constantly updated during execution, is displayed in the [Trace] window.

Select [Trace] from the [Code] submenu of the [View] menu to display the [Trace] window.

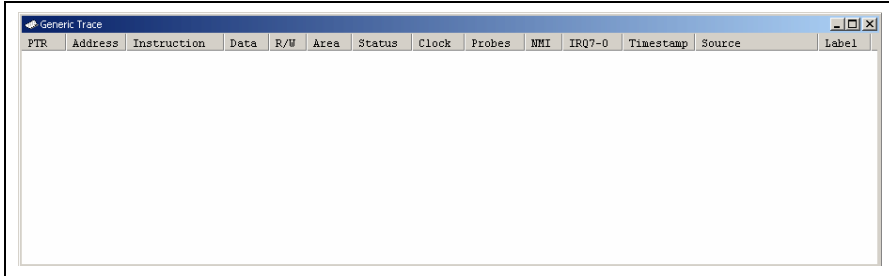

Figure 6.40 [Trace] Window

When trace information is displayed in the [Trace] window, clicking the right-hand mouse button on the [Trace] window displays a popup menu. Select [Clear] from this menu to clear the trace information.

The following sections give an overview of the trace functions and methods for setting them.

6.16.1 Displaying a Trace (when Time Stamping is not Available)

The method used to specify an address as an event condition for the tracing of read/write cycles and display the trace is described below.

- (1) Clicking the right-hand mouse button on the [Trace] window displays a popup menu. Select [Acquisition...] from this menu to display the [Trace Acquisition] dialog box.

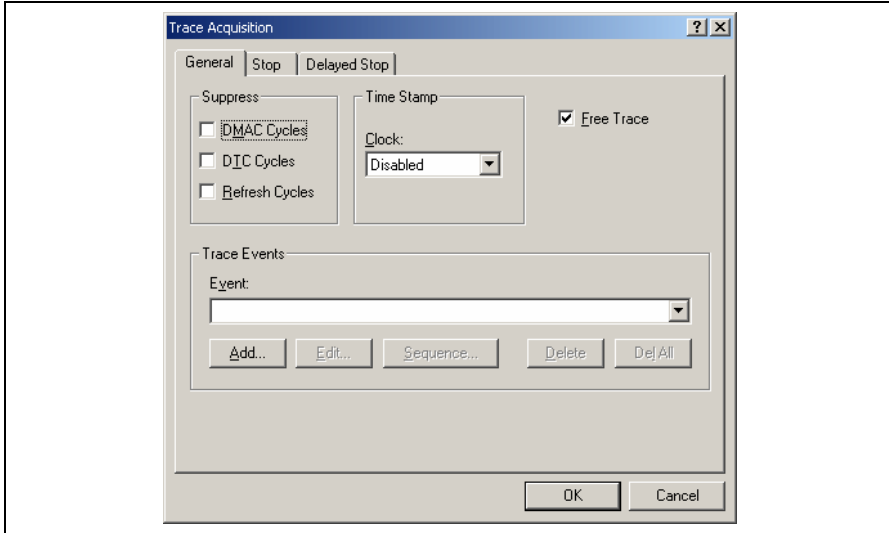

Figure 6.41 [Trace Acquisition] Dialog Box

- (2) Register an address as an event condition for trace acquisition. Click the [Add...] button in the [Trace Events] group box on the [General] page to display the [Breakpoint/Event Properties] dialog box.

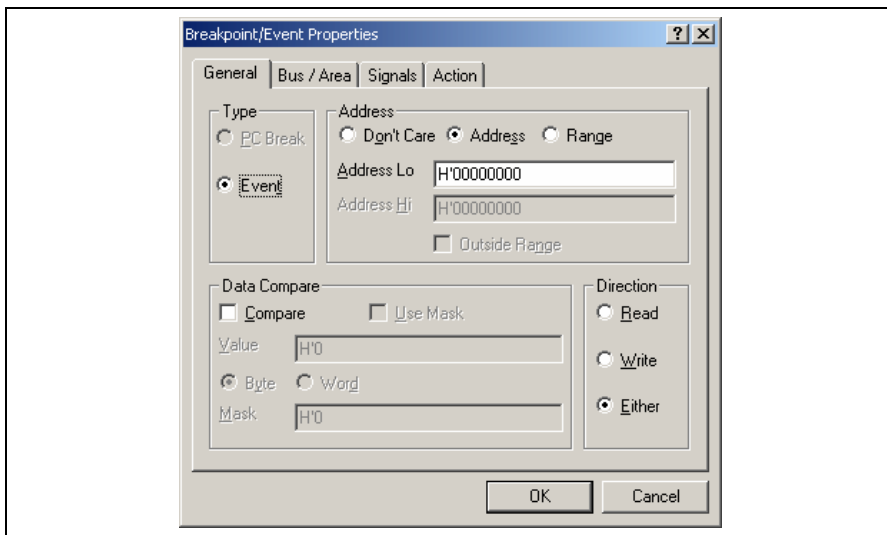

Figure 6.42 [Breakpoint/Event Properties] Dialog Box

- (3) Use the [Source] window to refer to the address on the line that has 'a[i]=j;' within the tutorial function and enter this address in the [Address Lo] edit box of the [Address] group box on the [General] page of the [Breakpoint/Event Properties] dialog box. In this example, enter `H'0000105C`. This address has thus been set. Click the [OK] button to close the [Breakpoint/Event Properties] dialog box.

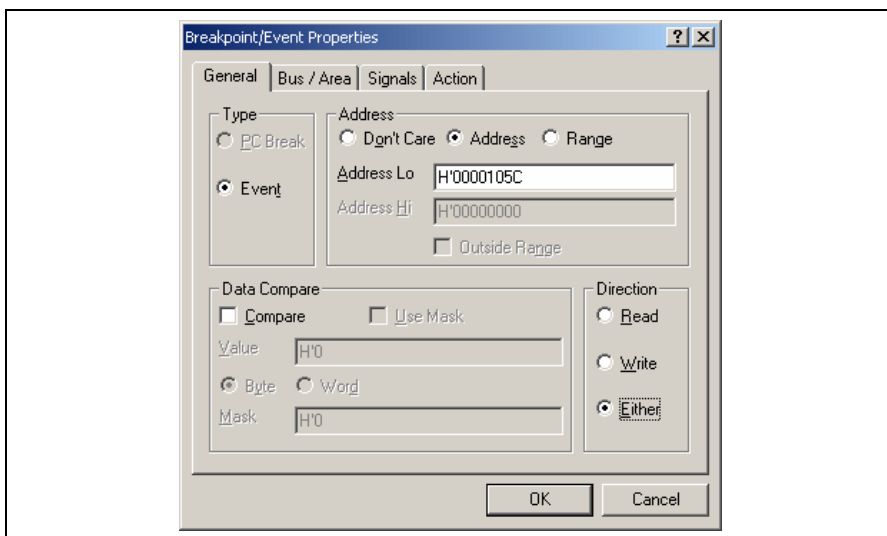

Figure 6.43 [Breakpoint/Event Properties] Dialog Box (after Setting an Event)

- (4) The event that has been set is now displayed in the [Event] combo box of the [Trace Events] group box on the [General] page of the [Trace Acquisition] dialog box.

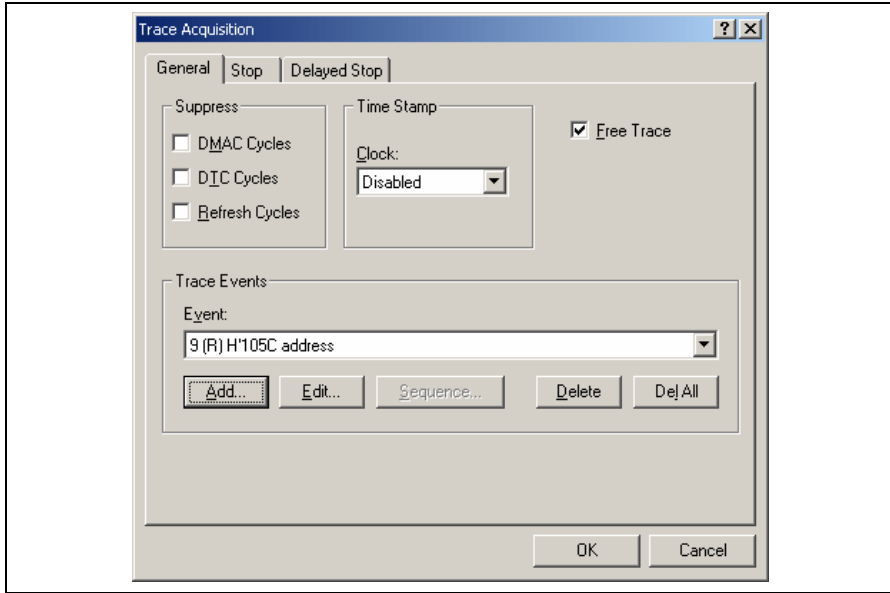

Figure 6.44 [Trace Acquisition] Dialog Box (Adding an Event)

- (5) To enable the event condition that has been set, uncheck the [Free Trace] check box on the [General] page. This will add pages [1] to [4] to the [Trace Acquisition] dialog box.

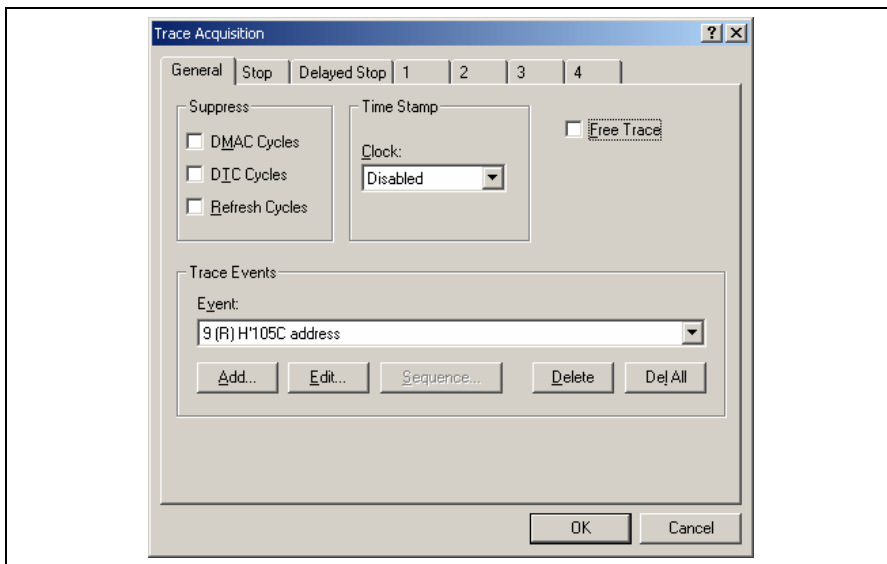

Figure 6.45 [Trace Acquisition] Dialog Box (Pages Added)

(6) Select page [1] and click the [Range] radio button in the [Conditions] group box. This will display the [Range Event] combo box and the [Edit...] button.

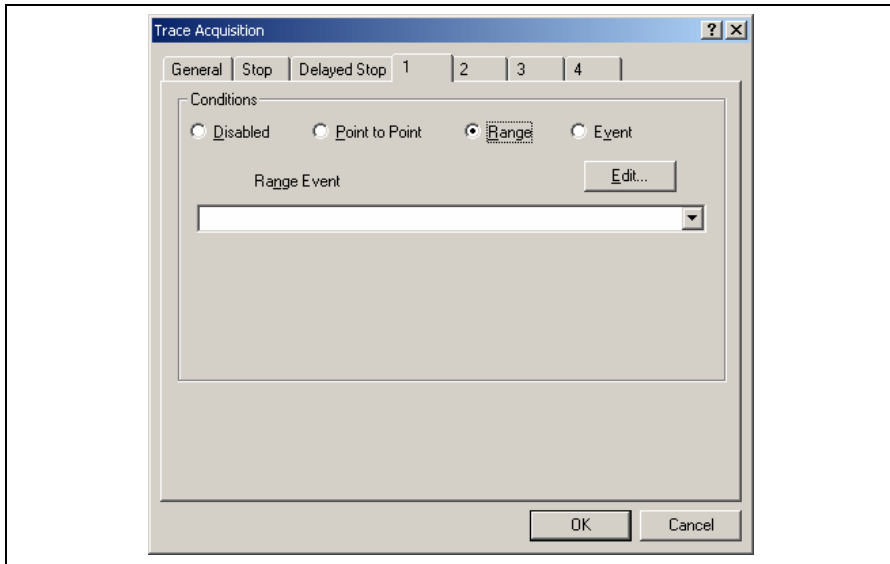

Figure 6.46 [Trace Acquisition] Dialog Box (Displaying Page [1])

- (7) Select the event you have registered from the [Range Event] combo box. The event is now enabled. Click the [OK] button to complete the trace setting.

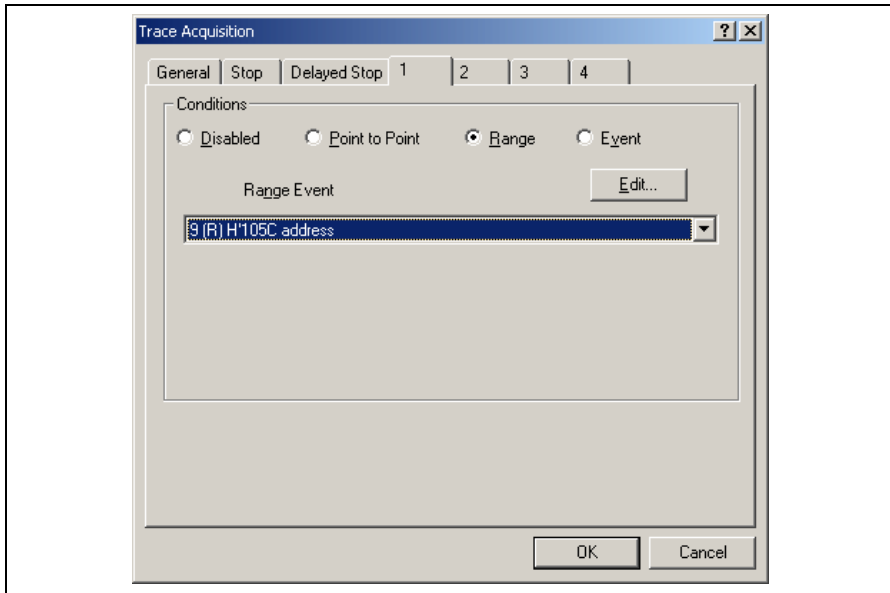

Figure 6.47 [Trace Acquisition] Dialog Box (Setting Completed)

- (8) Make the setting such that the break occurs after the instruction at the address on the line that has 'a[i]=j;' within the tutorial function (H'000105C in this example) has been executed five times (for details on this, refer to section 6.15.2, Breaking Execution at Event Points).
- (9) Select [Reset Go] from the [Debug] menu. Processing stops when the break condition is satisfied, and the [Trace] window then displays the following content.

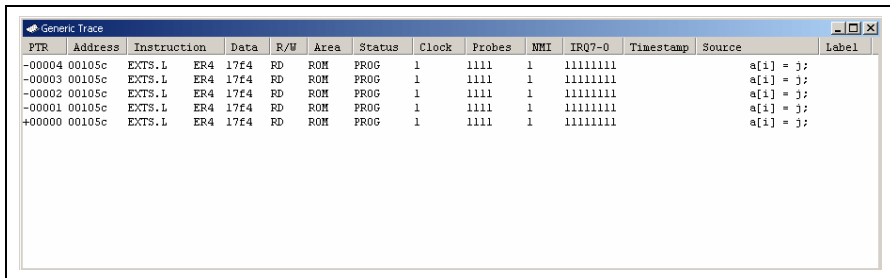

Figure 6.48 [Trace] Window (Displaying the Result)

If you have trouble viewing a column, drag the header (vertical) bars below the title bar to adjust the width of the column.

- (10) Remove the event points that have been set and clear the trace information. Click the right-hand mouse button on the [Event] window to display a popup menu. Select [Delete All] from this menu to remove all of the event points that have been set. Click the right-hand mouse button on the [Trace] window to display a further popup menu. Select [Clear] from this menu to clear the trace information.

6.16.2 Displaying a Trace (when Time Stamping is Available)

The following procedure is for obtaining and displaying, with time stamps, trace information on cycles of writing to memory locations in the specified address range.

- (1) Clicking the right-hand mouse button on the [Trace] window displays a popup menu. Select [Acquisition...] from this menu to display the [Trace Acquisition] dialog box (see figure 6.41, [Trace Acquisition] dialog box).
- (2) Register the address range for trace acquisition as an event condition. Click the [Add...] button in the [Trace Events] group box on the [General] page to display the [Breakpoint/Event Properties] dialog box (see figure 6.42, [Breakpoint/Event Properties] dialog box).
- (3) Click the [Range] radio button in the [Address] group box on the [General] page of the [Breakpoint/Event Properties] dialog box. Use the [Locals] window to refer to the address on the line where variable a, which is defined within the tutorial function, is allocated (**H'00FFEF80** in this example) and enter this address in the [Address Lo] edit box. Then enter an address, which is H'27 added to that entered in the [Address Lo] edit box (**H'00FFFA7** in this example), in the [Address Hi] edit box. This procedure sets the memory range for variable a of the tutorial function.
- (4) Click the [Write] radio button in the [Direction] group box to set a write cycle for the specified range. This completes the setting of a memory range. Click the [OK] button to close the [Breakpoint/Event Properties] dialog box.

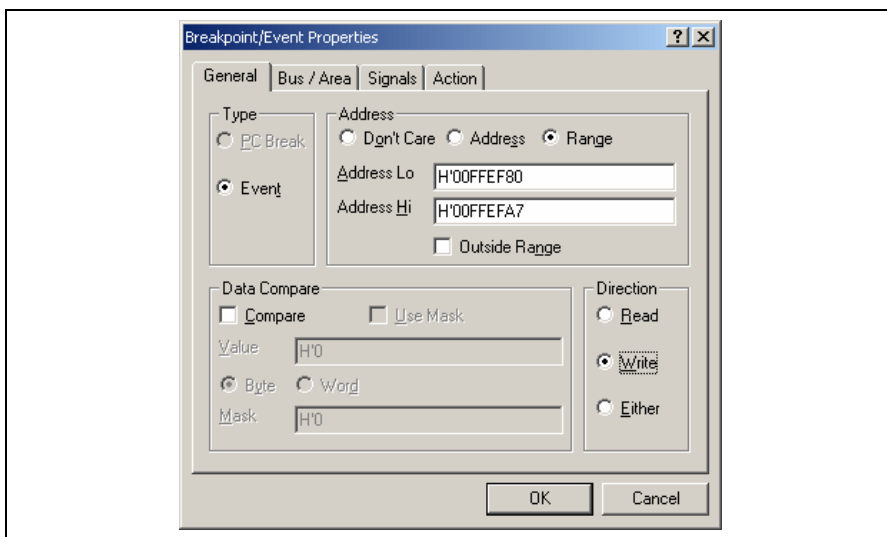

Figure 6.49 [Breakpoint/Event Properties] Dialog Box (after Setting an Event)

- (5) The event that has been set in the [Event] combo box of the [Trace Events] group box on the [General] page of the [Trace Acquisition] dialog box is displayed.

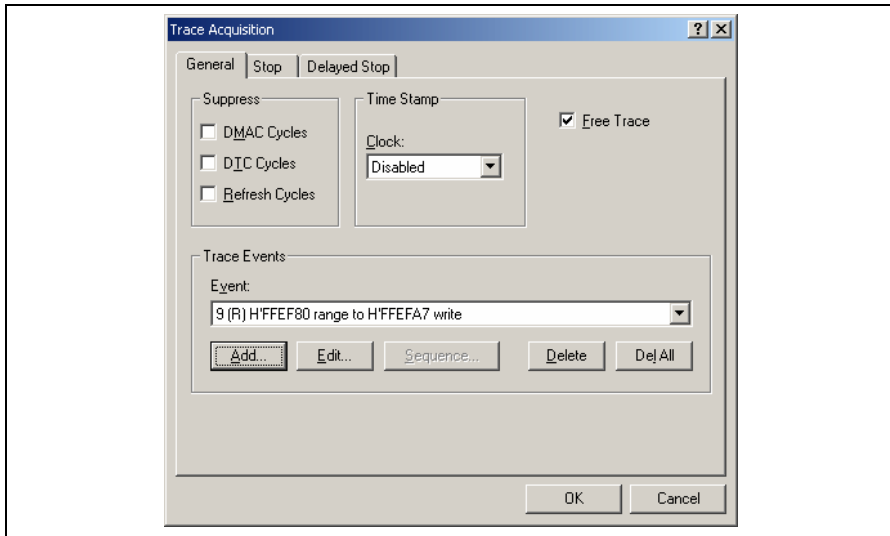

Figure 6.50 [Trace Acquisition] Dialog Box (Adding an Event)

- (6) To enable time stamping, select 125ns from the [Clock] combo box of the [Time Stamp] group box.

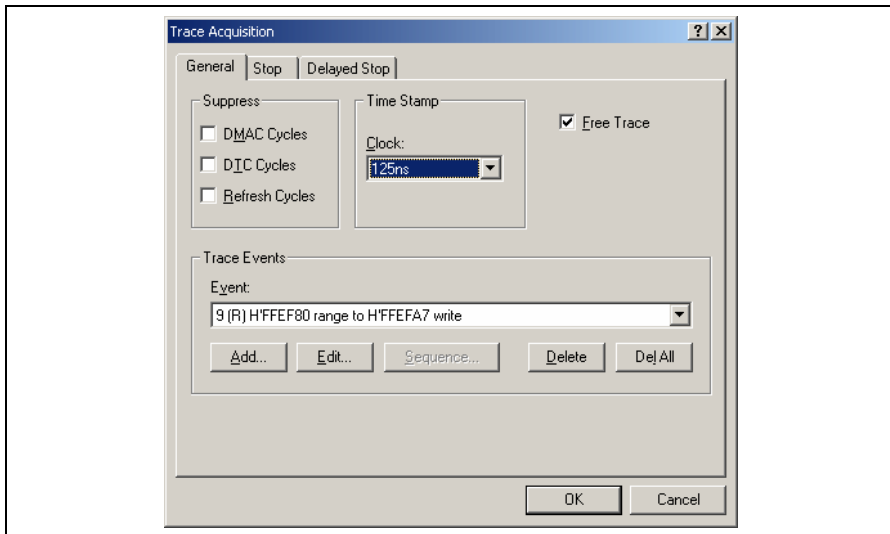

Figure 6.51 [Trace Acquisition] Dialog Box (Time Stamping is Available)

- (7) To enable the event condition that has been set, uncheck the [Free Trace] check box on the [General] page. This will add pages [1] to [4] (see figure 6.45, [Trace Acquisition] dialog box).
- (8) Select page [1] and click the [Range] radio button in the [Conditions] group box. This will display the [Range Event] combo box and the [Edit...] button (see figure 6.46, [Trace Acquisition] dialog box).
- (9) Click the [Range Event] combo box to select the event you have registered. The event is now enabled. Click the [OK] button to complete the trace setting.

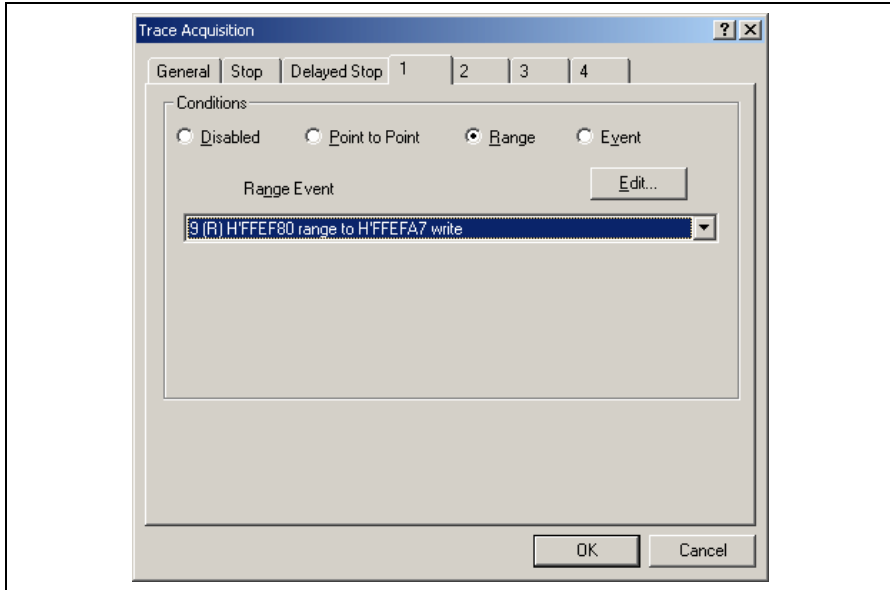

Figure 6.52 [Trace Acquisition] Dialog Box (Setting Completed)

- (10) Make the setting such that the break occurs after the instruction at the address on the line that has 'p_sam->s0=a[0];' within the tutorial function (0x0001082 in this example) (for details on this, refer to section 6.15.1, PC Break Function).
- (11) Select [Reset Go] from the [Debug] menu. Processing stops when the break condition is satisfied, and the [Trace] window then displays the following content.

PTR	Address	Instruction	Data	R/W	Area	Status	Clock	Probes	NMI	IRQ7-0	Timestamp
-00087	ffef80		0000	WR							0000h000ain000s000ms738us875ns
-00086	ffef82		41c6	WR							0000h000ain000s000ms739us000ns
-00085	ffef84		0000	WR							0000h000ain000s000ms759us375ns
-00084	ffef86		167e	WR							0000h000ain000s000ms759us500ns
-00083	ffef88		0000	WR							0000h000ain000s000ms779us875ns
-00082	ffef8a		2781	WR							0000h000ain000s000ms780us000ns
-00081	ffef8c		0000	WR							0000h000ain000s000ms800us375ns
-00080	ffef8e		446b	WR							0000h000ain000s000ms800us500ns
-00079	ffef90		0000	WR							0000h000ain000s000ms820us875ns
-00078	ffef92		794b	WR							0000h000ain000s000ms821us000ns
-00077	ffef94		0000	WR							0000h000ain000s000ms841us375ns
-00076	ffef96		15Eb	WR							0000h000ain000s000ms841us375ns
-00075	ffef98		0000	WR							0000h000ain000s000ms861us875ns
-00074	ffef9a		59e2	WR							0000h000ain000s000ms861us875ns

Figure 6.53 [Trace] Window (Displaying the Result)

If you have trouble viewing a column, drag the header (vertical) bars below the title bar to adjust the width of the column.

- (12) Remove the event points that have been set and clear the trace information. Clicking the right-hand mouse button on the [Breakpoints] window displays a popup menu. Select [Delete All] from this menu to remove all the event points that have been set. Clicking the right-hand mouse button on the [Trace] window displays a further popup menu. Select [Clear] from this menu to clear the trace information. To disable time stamping, select Disabled in the [Clock] combo box of the [Time Stamp] group box on the [General] page of the [Trace Acquisition] dialog box.

6.16.3 Statistics

The number of times the on-chip RAM has been written to can be included in the acquired trace information.

- (1) Make the setting such that a break occurs at the address on the line that has 'p_sam->s0=a[0];' within the tutorial function (**H'00001082** in this example) (for details on this, refer to section 6.15.1, PC Break Function).
- (2) Select [Reset Go] from the [Debug] menu. Processing stops when the break condition is satisfied, and the [Trace] window then displays trace information.
- (3) Select [Statistic...] from the popup menu that is displayed when you click the right-hand mouse button on the [Trace] window. A message box appears, indicating that the trace data is being loaded, and the [Statistic] dialog box will be displayed.

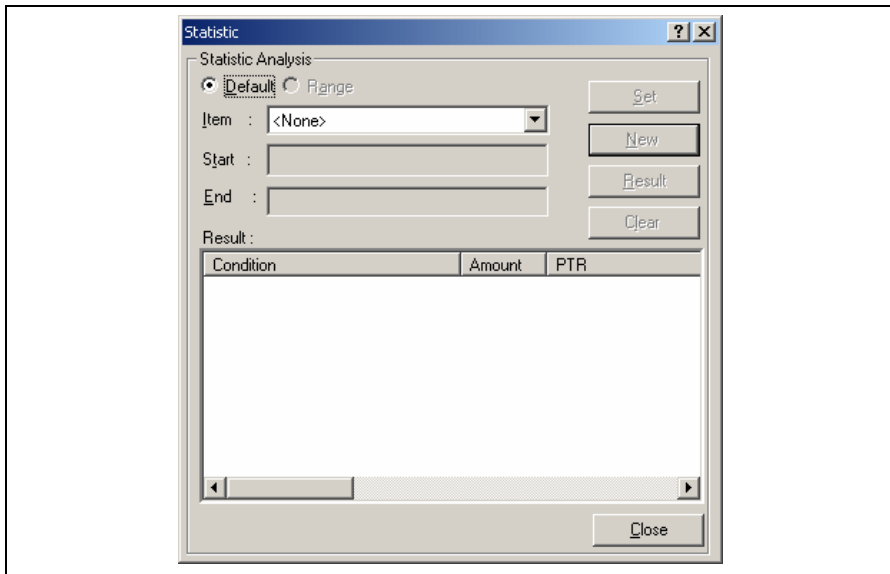

Figure 6.54 [Statistic] Dialog Box

- (4) Select R/W in the [Item] combo box and enter WR in the [Start] edit box. After that, click the [New] button. “R/W=WR” is now displayed in the [Condition] column of the [Result] list box.

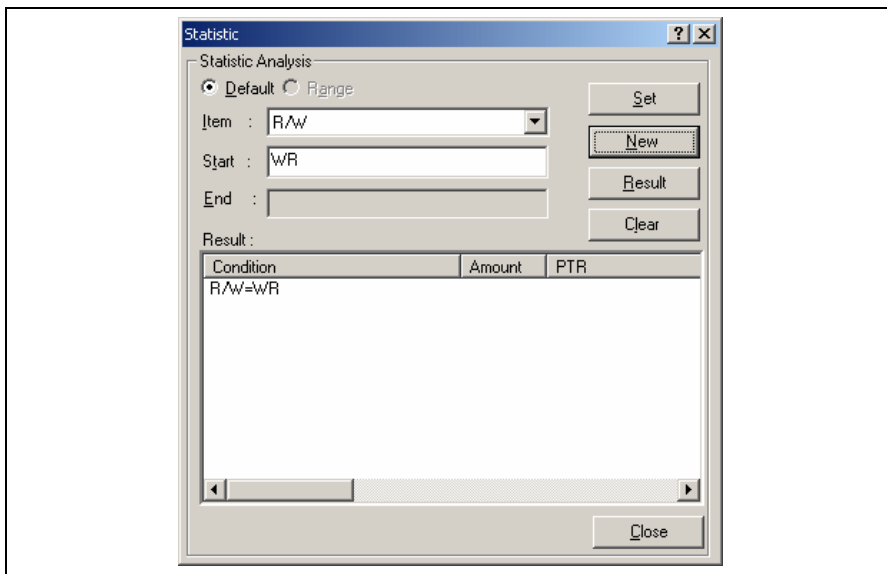

Figure 6.55 [Statistic] Dialog Box (New Condition)

- (5) Then, select Area from the [Item] combo box and enter RAM in the [Start] edit box. After that, click the [Add] button; the new condition is now added to the “R/W=WR” display in the [Condition] column of the [Result] list box, so that it now shows “R/W=WR & Area=RAM”. This completes setting of the condition.

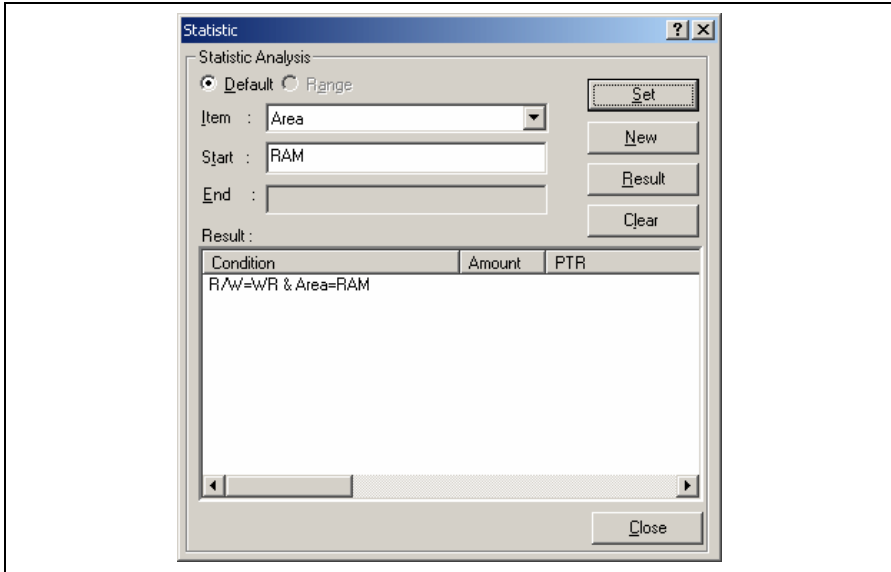

Figure 6.56 [Statistic] Dialog Box (Condition Added)

- (6) To start statistical analysis of the specified condition, press the [Result] button. The number of write operations that satisfy the condition and the PTR values will be displayed.

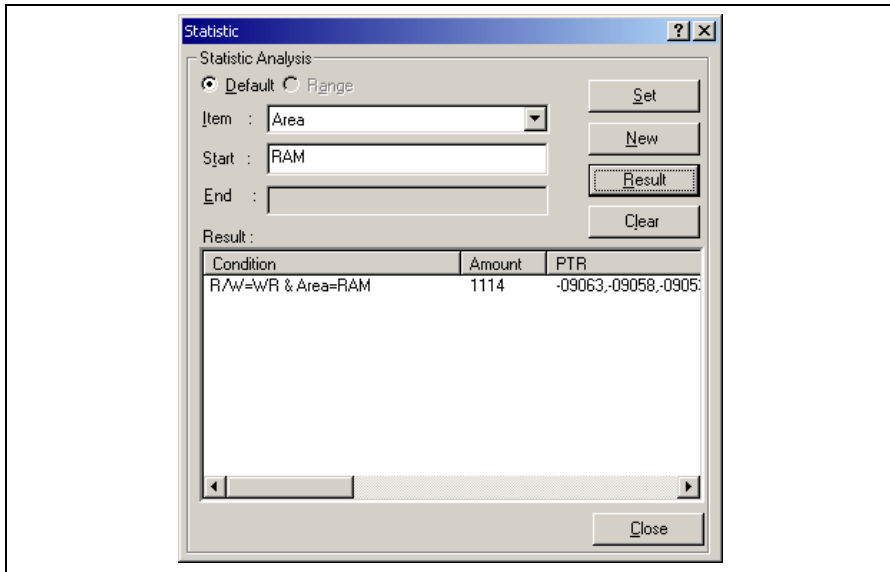

Figure 6.57 [Statistic] Dialog Box (Result of Analysis)

- (7) Click the [Close] button to close the [Statistic] dialog box.
- (8) Remove the event points that have been set and clear the trace information. Clicking the right-hand mouse button on the [Event] window displays a popup menu. Select [Delete All] from this menu to remove all the event points that have been set. Clicking the right-hand mouse button on the [Trace] window displays a further popup menu. Select [Clear] from this menu to clear the trace information.

6.16.4 Function Calls

This mechanism is used to only collect trace information on the function calls.

- (1) Make the setting such that a break occurs at the address on the line that has 'p_sam->s0=a[0];' within the tutorial function (**H'00001082** in this example) (for details on this, refer to section 6.15.1, PC Break Function).
- (2) Select [Reset Go] from the [Debug] menu. Processing stops when the break condition is satisfied, and the [Trace] window then displays trace information.
- (3) Select [Function Call...] from the popup menu displayed by clicking the right-hand mouse button on the [Trace] window. The [Function Call Display] dialog box will be displayed.

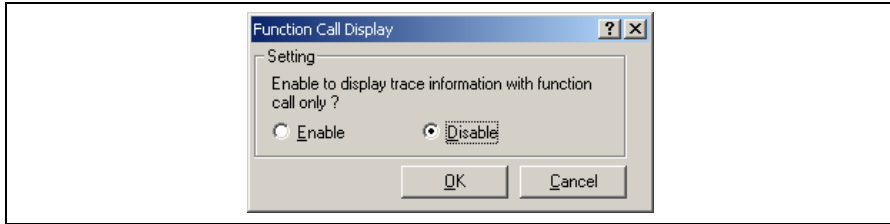

Figure 6.58 [Function Call Display] Dialog Box

- (4) Click the [Enable] radio button and then the [OK] button. Only the information on function calls is now displayed in the [Trace] window (the [Label] column's right-side boundary has been moved to the left in the [Trace] window to show the function calls).

Label	PTR	Add...	Instruction	Data	R/W	Area	Status	Clock	Probes	NMI	IRQ7-0	
PowerON_Reset()	-09108	000400	MOV.L	#H'00FFFC0,ER7	7a07	RD	ROM	PROG	1	1111	1	11111111
_main	-03582	001034	BSR	@tutorial():8	5502	RD	ROM	PROG	1	1111	1	11111111
tutorial()	-03578	001038	MOV.L	ER3,0-ER7	0100	RD	ROM	PROG	1	1111	1	11111111
Sample::Sample()	-03558	002000	MOV.L	ER2,0-ER7	0100	RD	ROM	PROG	1	1111	1	11111111
_sbrk	-03369	001000	STM.L	(ER2-ER3),0-SP	0110	RD	ROM	PROG	1	1111	1	11111111
Sample::sort(long *)	-01667	002068	STM.L	(ER2-ER3),0-SP	0110	RD	ROM	PROG	1	1111	1	11111111
Sample::change(long *)	-00469	002046	MOV.L	ER3,0-ER7	0100	RD	ROM	PROG	1	1111	1	11111111

Figure 6.59 [Trace] Window (Function Calls)

- (5) To return the display in the [Trace] window to its previous state, follow the procedure in (3) to display the [Function Call Display] dialog box. Click the [Disable] button and then the [OK] button.
- (6) Remove the event points that have been set and clear the trace information. Clicking the right-hand mouse button on the [Breakpoints] window displays a popup menu. Select [Delete All] from this menu to remove all the event points that have been set. Clicking the right-hand mouse button on the [Trace] window displays a further popup menu. Select [Clear] from this menu to clear the trace information.

6.17 Stack Trace Function

The emulator uses the information on the stack to display the function call history.

- Notes:
1. This function can be used only when the load module that has the Dwarf2-type debugging information is loaded. Such load module is supported in H8S, H8/300 C/C++ compiler V4.0 or later.
 2. For details on the stack trace function, refer to the online help.

- Double-click the [Editor] column in the `sort` function and set a PC breakpoint.

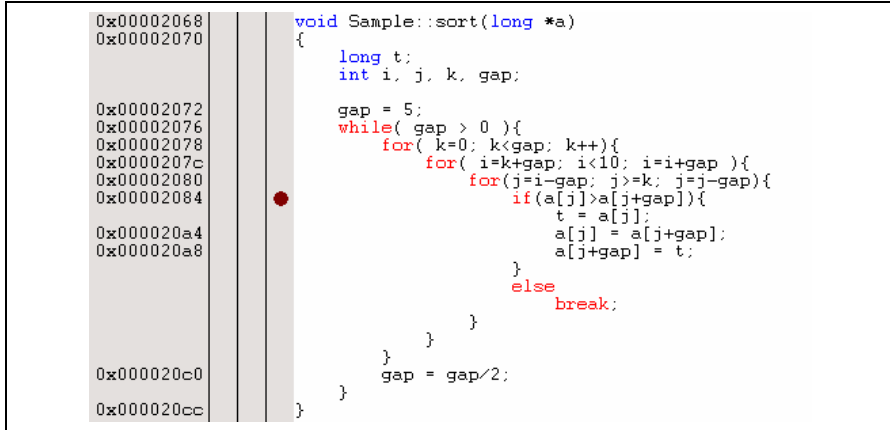

Figure 6.60 [Source] Window (PC Breakpoint Setting)

- Select [Reset Go] from the [Debug] menu.
- After the break in program execution, select [Stack Trace] from the [Code] submenu of the [View] menu to open the [Stack Trace] window.

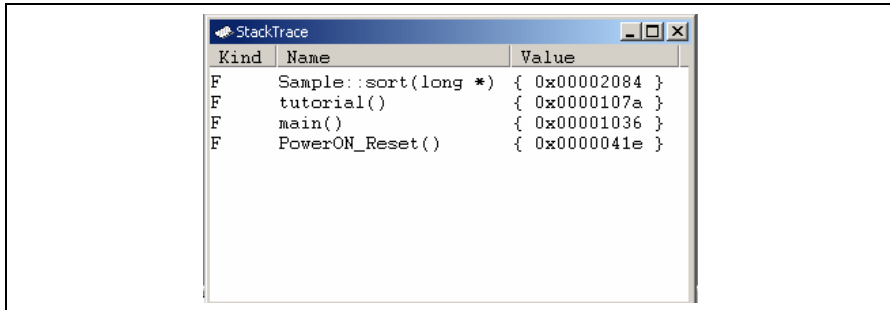

Figure 6.61 [Stack Trace] Window

Figure 6.61 shows that the position of the program counter is currently at the selected line of the `sort` () function, and that the `sort` () function is called from the `tutorial` () function.

To remove the PC breakpoint, double-click the [Editor] column in the `sort` function again.

6.18 Performance Measurement Function

Performance measurement by the emulator is in the following modes:

- Time Of Specified Range Measurement
- Start Point To End Point Measurement
- Start Range To End Range Measurement
- Access Count Of Specified Range Measurement
- Called Count Of Specified Range Measurement

In this tutorial, we describe the Time Of Specified Range Measurement.

6.18.1 Time Of Specified Range Measurement

(1) Select [Performance Analysis] from the [Performance] submenu of the [View] menu to display the [Select Performance Analysis Type] dialog box.

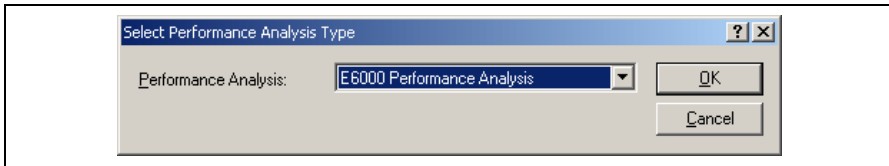

Figure 6.62 [Select Performance Analysis Type] Dialog Box

(2) Select "E6000 Performance Analysis" from the [Performance Analysis] combo box in the [Select Performance Analysis Type] dialog box and click the [OK] button. The [Performance Analysis] window will be displayed.

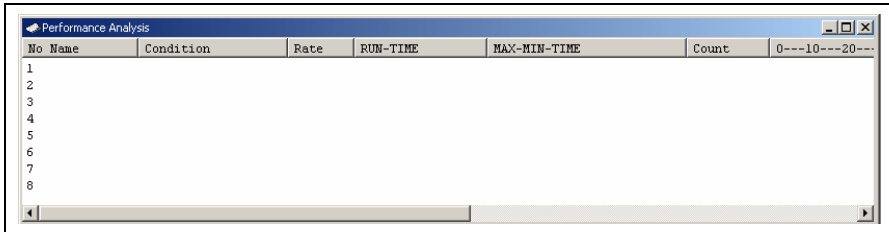

Figure 6.63 [Performance Analysis] Window

- (3) Select the line of the [Performance Analysis] window that has 1 in its [No] column and click the right-hand mouse button to display a popup menu. Select [Set...] from this popup menu to display the [Performance Analysis Properties] dialog box.

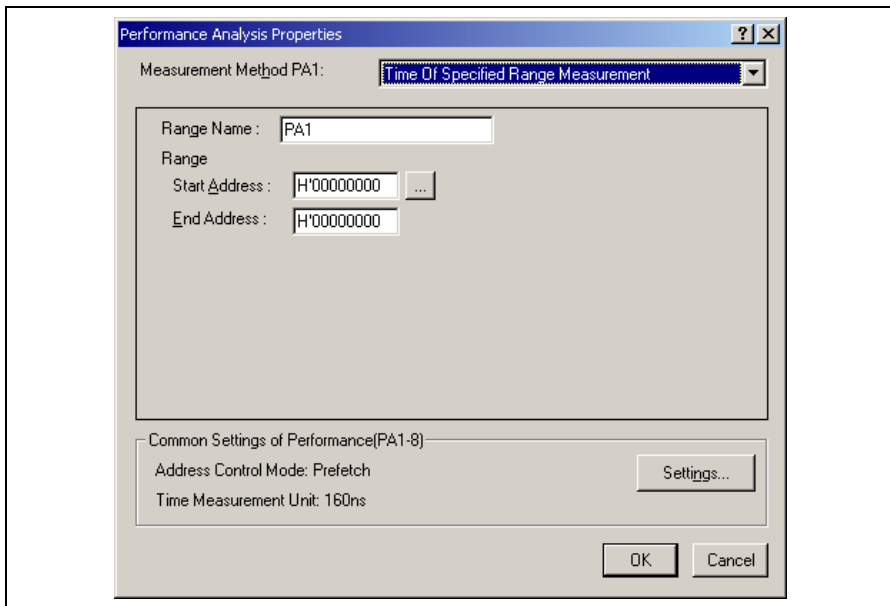

Figure 6.64 [Performance Analysis Properties] Dialog Box

- (4) Select Time Of Specified Range Measurement from the [Measurement Method PA1] combo box.
(5) The parameter settings are as follows.

- Enter "sort" in the [Range Name] edit box.
- Click the [...] button to the right of the [Start Address] edit box to display the [Input Function Range] dialog box. Enter the function name "sort" in the [Function] edit box of this dialog box and then click the [OK] button. The corresponding addresses for the function "sort" will now be set in the [Start Address] and [End Address] edit boxes.



Figure 6.65 [Input Function Range] Dialog Box

Note: The addresses figured out in the [Input Function Range] dialog box are just for reference. In some cases, the end address of a function may be different. Check the last instruction of the function in the [Disassembly] window to correct the value set in [End Address] so that it will be the address of the last instruction (in general, the last instruction of a function is a RTS instruction). A label name or an expression can be entered instead of an address value in boxes where an address should be entered.

- Click the [Settings...] button in the [Common Settings of Performance(PA1-8)] group box to display the [Common Settings of Performance(PA1-8)] dialog box. Select [PC] from the [Address Control Mode] combo box and then click the [OK] button. PC is now displayed in the [Address Control Mode] text field of the [Common Setting of Performance(PA1-8)] dialog box.

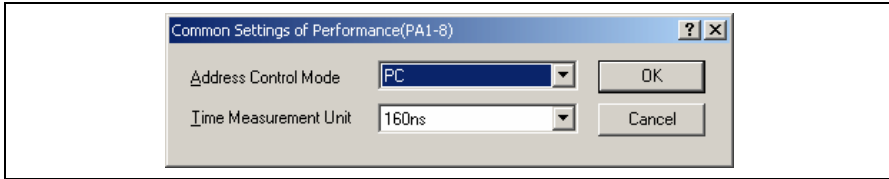

Figure 6.66 [Common Setting of Performance(PA1-8)] Dialog Box

- Click the [OK] button to display the content that has been set for line 1 of the [No] column in the [Performance Analysis] window. This completes the settings for a Time Of Specified Range Measurement.

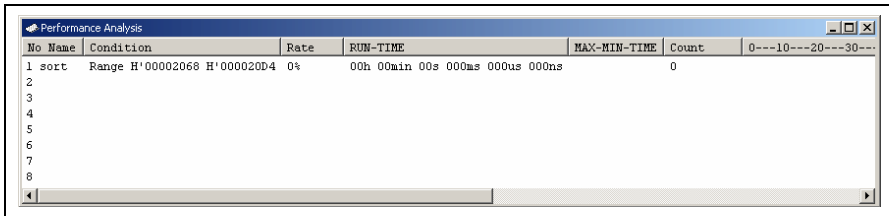

Figure 6.67 [Performance Analysis] Dialog Box (Setting Completed)

- Set an event point at the address on the line that has 'p_sam->change(a);' within the tutorial function (H'0000107 in this example) so that a break occurs when the specified sort function has been executed three times (refer to section 6.15.2, Breaking Execution at Event Points).
- Select [Reset Go] from the [Debug] menu. Processing stops when the break condition is satisfied, and the [Performance Analysis] window then displays the information shown below. The value shown in the [Count] column is 3, which indicates that the sort function has been executed three times and the execution time.

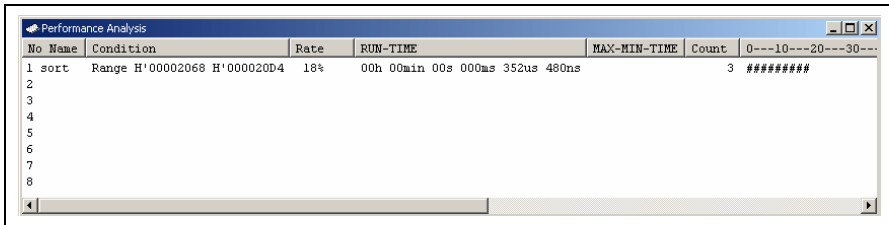

Figure 6.68 [Performance Analysis] Dialog Box (Displaying the Result)

- Delete the setting for performance analysis and remove the event point. Click the right-hand mouse button on the [Performance Analysis] window to display a popup menu. Select [Reset All] from this popup menu to delete all of the settings. Clicking the right-hand mouse button on the [Event] window also displays a popup menu. Select [Delete All] from this popup menu to remove all the event points that have been set.

6.19 Monitor Function

The emulator allows monitoring of the content of specified addresses in memory during execution of the user program. In this example, we monitor the content of the address range where variable `a` of the `tutorial` function is stored.

- (1) Select the [CPU] submenu from the [View] menu. Then selecting [Monitor Setting...] from the [Monitor] submenu displays the [Monitor Setting] dialog box.

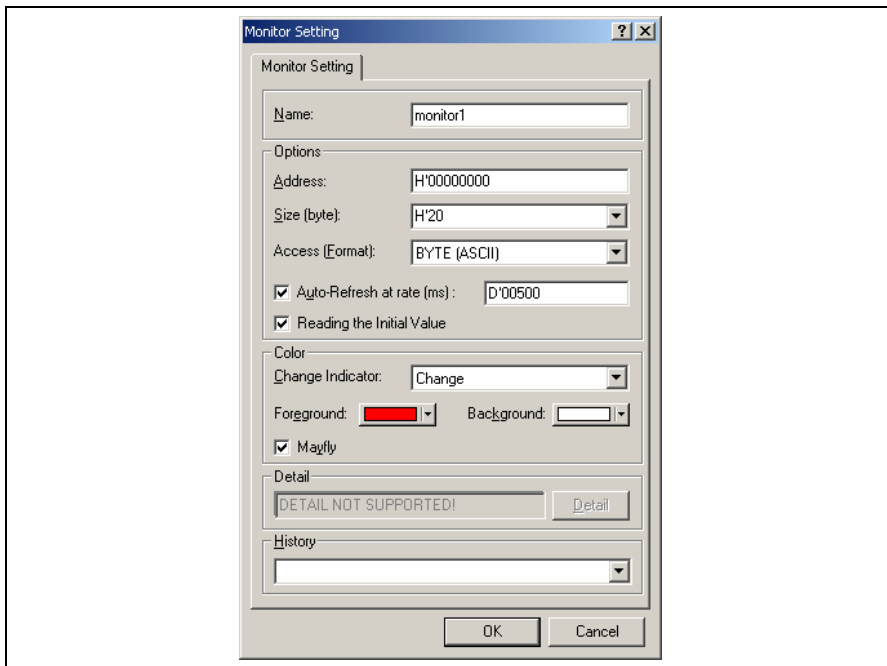

Figure 6.69 [Monitor Setting] Dialog Box

(2) Set the items in the [Monitor Setting] dialog box as follows:

- Enter monitor1 in the [Name] edit box.
- Set the parameters in the [Options] group box as follows:
 - (a) Use the [Locals] window to refer to the address on the line where variable a, which is defined within the tutorial function, is allocated and enter this address in the [Address] edit box. In this example, enter `H'00FFEF80`.
 - (b) Enter `H'50` in the [Size] edit box.
 - (c) Select BYTE (HEX) from the [Access] combo box.
 - (d) Check the [Auto-refresh at rate] check box and enter `D'00500`.
 - (e) Check the [Reading the Initial Value] check box.
- Set the parameters in the [Color] group box as follows:
 - (a) Select Change from the [Change Indicator] combo box.
 - (b) Select red and white in the [Foreground] and [Background] combo boxes, respectively.
 - (c) Check the [Mayfly] check box.

Note: Depending on the operating system in use, the foreground and background colors may not be selectable.

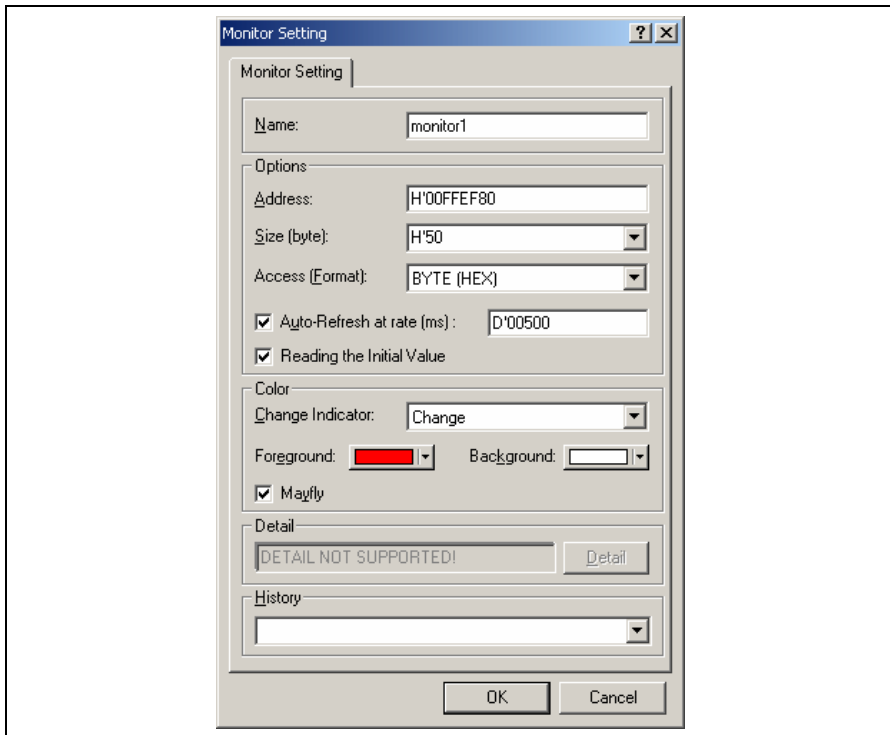
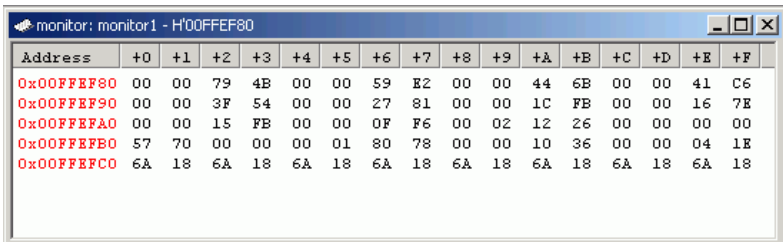

Figure 6.70 [Monitor Setting] Dialog Box (Setting Completed)

(3) Click the [OK] button to open the [Monitor] window.



The screenshot shows a window titled "monitor: monitor1 - H'00FFEF80". The window contains a table with 17 columns representing memory addresses from +0 to +F. The data is as follows:

Address	+0	+1	+2	+3	+4	+5	+6	+7	+8	+9	+A	+B	+C	+D	+E	+F
0x00FFEF80	00	00	79	4B	00	00	59	E2	00	00	44	6B	00	00	41	C6
0x00FFEF90	00	00	3F	54	00	00	27	81	00	00	1C	FB	00	00	16	7E
0x00FFEF A0	00	00	15	FE	00	00	0F	F6	00	02	12	26	00	00	00	00
0x00FFEF B0	57	70	00	00	00	01	80	78	00	00	10	36	00	00	04	1E
0x00FFEF C0	6A	18	6A	18	6A	18	6A	18	6A	18	6A	18	6A	18	6A	18

Figure 6.71 [Monitor] Window

- (4) Select [Reset Go] from the [Debug] menu. When the content of the address range changes with execution, the updated values are red (i.e. the color that was selected in the [Foreground] and [Background] combo boxes). Values will be displayed in black if they have not been updated or a certain period of time has elapsed since the last update.

Address	+0	+1	+2	+3	+4	+5	+6	+7	+8	+9	+A	+B	+C	+D	+E	+F
0x00FFEF80	00	00	02	8B	00	00	18	05	00	00	2D	69	00	00	36	73
0x00FFEF90	00	00	3A	E9	00	00	3B	D3	00	00	41	FC	00	00	5B	E9
0x00FFFEA0	00	00	64	02	00	00	6F	4A	00	02	12	24	00	00	AA	AA
0x00FFEFB0	57	70	00	00	00	01	80	74	00	00	10	36	00	00	04	1E
0x00FFFC0	6A	18	6A	18	6A	18	6A	18	6A	18	6A	18	6A	18	6A	18

Figure 6.72 [Monitor] Window (during Execution)

- (5) After you have finished checking the states in the [Monitor] window, select [Halt Program] from the [Debug] menu to halt the program's execution.

6.20 What Next?

This tutorial has described the major features of the emulator and the use of the HEW.

Sophisticated debugging can be carried out by using the emulation functions that the emulator offers. This provides for effective investigation of hardware and software problems by accurately isolating and identifying the conditions under which such problems arise.

Section 7 Hardware Specifications Specific to This Product

This section describes the hardware specifications on the H8/3160 E6000 emulator.

7.1 H8/3160 E6000 Emulator Specifications

The H8/3160 E6000 emulator supports the system development using the following microcomputer:

- H8/3112
- H8/3113
- H8/3150 group
- H8/3160 group
- AE-3 group

7.1.1 Supported MCU and User System Interface Cable

See the development support tool catalog for the MCU type names and packages supported by the E6000 emulator and for the combination of the E6000 user system interface cables and optional boards.

7.1.2 Operating Voltage and Frequency Specifications

Table 7.1 shows the MCU operating voltage and frequency specifications supported by the E6000 emulator. If the emulator is used in an environment that exceeds the operating voltage range and operating frequency range guaranteed for the MCU operation, normal emulator operation is not guaranteed.

Table 7.1 Operating Voltage and Frequency Specifications

MCU Type	Operating Voltage (V)	Operating Frequency (ϕ) (MHz)
H8/3112	4.5-5.5	0.5-5
	2.7-3.3	0.5-2.5
H8/3113	4.5-5.5	0.5-5
	2.7-3.3	0.5-4
H8/3150 group	4.5-5.5	0.5-5
	2.7-3.3	0.5-4
H8/3160 group	4.5-5.5	0.5-5
	2.7-3.3	0.5-4
AE-3 group	4.5-5.5	0.5-5
	2.7-3.3	0.5-4

NOTE

For details on the operating voltage and frequency specifications, refer to the MCU's hardware manual.

7.2 User System Interface

For the following user system interface signals, control circuits are connected between the user system and the MCU in the emulator:

- RESET
- CLK
- I/O-1/IRQ and I/O-2/IRQ

7.2.1 Signal Protection on the Emulator

All user system interface signals are over/reverse voltage protected by use of diode arrays and have pull-up resistors. The emulator monitors the V_{cc} pin to detect presence of powered user system hardware.

7.2.2 User System Interface Circuits

The interface circuit between the MCU in the emulator and the user system has a signal delay of about 3 ns due to the user system interface cable and it includes pull-up resistors. Therefore, high-impedance signals will be pulled up to the high level. When connecting the emulator to a user system, adjust the user system hardware to compensate for propagation delays.

V_{cc} :

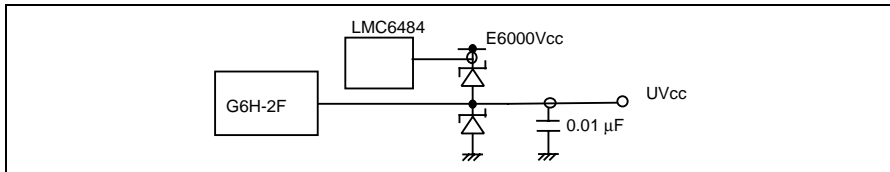

Figure 7.1 User System Interface Signal Circuit

CLK:

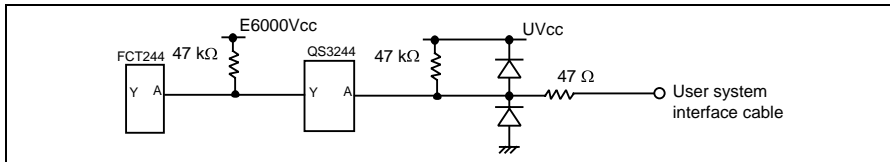

Figure 7.2 User System Interface Circuit for CLK

RESET:

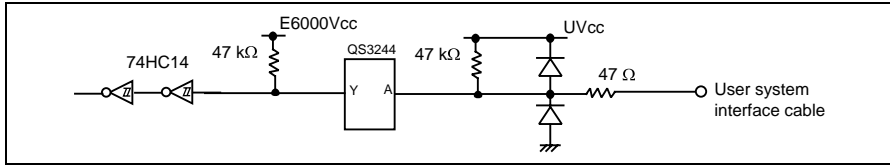

Figure 7.3 User System Interface Circuit for RESET

I/O-1/IRQ and I/O-2/IRQ:

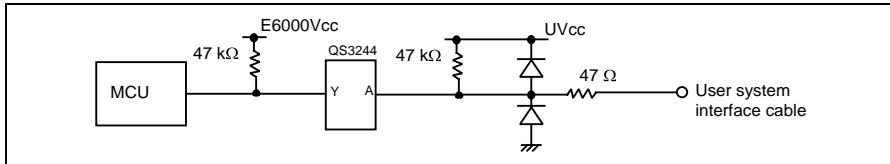

Figure 7.4 User System Interface Circuit for I/O-1/IRQ and I/O-2/IRQ

7.3 Differences between MCU and Emulator

7.3.1 Registers

When the emulator is initialized or the system is reset, there are some differences in the initial values in some of the general registers between the MCU and the emulator as shown in table 7.2.

Table 7.2 Initial Value Differences between MCU and E6000 Emulator

Status	Register	MCU	E6000 Emulator
Power-on	PC	Reset vector value	Reset vector value
	R0 to R6	Undefined	H'00000000
	R7 (SP)	Undefined	H'00000010
	CCR	The I mask is set to 1 and the other bits are undefined	The I mask is set to 1 and the other bits are undefined
Reset command	PC	Reset vector value	Reset vector value
	R0 to R6	Undefined	Undefined
	R7 (SP)	Undefined	H'00000010
	CCR	The I mask is set to 1 and the other bits are undefined	The I mask is set to 1 and the other bits are undefined

Please refer to section 7.2.2, User System Interface Circuits, for details of the protection circuit used on the I/O ports of the emulator.

Table 7.3 Differences of Register Access between MCU and Emulator

Item	MCU	E6000 Emulator
Word access to the byte size registers	See the MCU's hardware manual.	When registers for byte size IO are accessed in word units, the access is not guaranteed and its result is different from that of the MCU.
CPUCS0 bit of SYSCR register	See the MCU's hardware manual.	H8/3160: The CPUCS0 bit can be written to only once after the user program is executed by the GO RESET command or a user reset is input.

7.3.2 EEPROM

Table 7.4 EEPROM Differences between MCU and Emulator

Item	H8/3112	H8/3113 and H8/3150 Group	H8/3160 Group	E6000 Emulator
Programming time	15 ms (max.)	10 ms (max.)	4ms (max.)	Always the maximum time of the MCU.
Overwrite time	15 ms (max.)	5 ms (max.)	2 ms (max.)	Always the maximum time of the MCU.
Erase time	15 ms (max.)	5 ms (max.)	2 ms (max.)	Always the maximum time of the MCU.
Setting the registers	MCU limits the setting as follows. Source address (R5): RAM Destination address (R6): EEPROM Byte count (R4L): Up to page size If the setting is wrong, the result of EEPMOV is not guaranteed.			If the setting is wrong, the result of EEPMOV is not guaranteed and the result is different from that of the MCU. When ROM is specified as the destination, the contents of the ROM will be changed.

7.3.3 WDT

Table 7.5 WDT Differences between MCU and Emulator

Item	H8/3113 and H8/3150 Group MCU	E6000 Emulator
EWE interrupt	The interrupt processing starts after instruction 2) is executed, in the following example: 1) MOV.B ROH,@TCR 2) MOV.B ROL,@ECR 3) EEPMOV	If a break is set or single-step execution is performed for the example instructions on the left, the EWE interrupt timing in the emulator differs from that in the MCU. If a UDF interrupt occurs after instruction 1), the EWE interrupt also occurs after instruction 1).
UDF interrupt	No UDF interrupt processing is performed between the RTE instruction at the end of the EWE interrupt processing and the instruction following the RTE instruction.	If a break is specified or single-step execution is performed for the RTE instruction described on the left, a UDF interrupt will occur.
TCWA register	See the MCU's hardware manual.	In the emulator, the TCWA function does not work in cases below (reloading of the TCNT register is not available); H8/3158:TCWA=H'8E-H'BE H8/3164:TCWA=H'6E

7.3.4 Security

Table 7.6 Security Differences between MCU and Emulator

Item	MCU	E6000 Emulator
HVD	The MCU is reset if high voltage is detected.	The high-voltage detecting function is not supported.

Section 8 Software Specifications Specific to This Product

This section describes the software specifications of the H8/3160 E6000 emulator.

8.1 Software Specifications of the H8/3160 E6000 Emulator

Information specific to this emulator is given below.

8.1.1 Target Hardware

This emulator software conforms to the H8/3160 E6000 emulator (HS3160EPI60H).

8.1.2 Selectable Platforms

The debugging platforms selectable in this emulator are listed below. The MCUs that can be emulated differ depending on the debugging platform selected.

Table 8.1 Selectable Target Platforms

Debugging Platform	Remark
H8/3150 E6000 Emulator CPU 300	For emulation of the H8/3152, H8/3153, H8/3155, H8/3156, H8/3112, H8/3113, and H8/3158 that have the H8/300 CPU as the core.
H8/3160 E6000 Emulator CPU 300	For emulation of the H8/3161 and H8/3166 that have the H8/300 CPU as the core.
AE-3 E6000 Emulator CPU 300	For emulation of the AE340 and AE330 that have the H8/300 CPU as the core.

8.1.3 [Configuration Properties] Dialog Box ([General] Page)

Items that can be set in this dialog box are listed below.

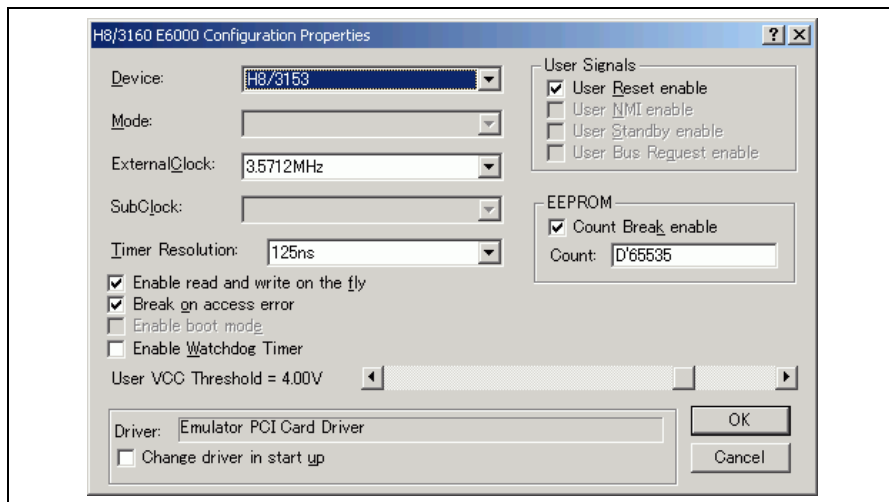

Figure 8.1 [Configuration Properties] Dialog Box ([General] Page)

[General] page

[Device]	Selects the MCU to be emulated. To use an MCU not included in the list, select [Custom] to specify the functions required for this MCU. See the hardware manual for details.
[External Clock]	Selects the speed of the MCU's clock.
[Timer Resolution]	<p>Selects the resolution of the timer for use in execution time measurement. The value 20 ns, 125 ns, 250 ns, 500 ns, 1 us, 2 us, 4 us, 8 us, or 16 us can be selected.</p> <p>The timer for execution time measurement has a 40-bit counter.</p> <p>At 20 ns the maximum time that can be measured is about six hours, and at 16 μs the maximum time is about 200 days.</p> <p>When the counter overflows, the maximum time possible for measurement will be displayed with prompt ">" that indicates that the counter has overflowed.</p>
[Enable read and write on the fly]	<p>When this box is checked, it is possible to access the target system memory while the user program is running. Do not check this box if you require realtime emulation.</p> <p>Note:</p> <p>When the content of the memory is modified during the user program execution (e.g. modification in the [Memory] window or by the MEMORY_EDIT command), HEW reads the content to update the value. HEW also reads the memory content when the content has been updated by operations such as selecting [Memory -> Refresh]. In this case, the content of memory is read and then updated in each of the windows.</p> <p>To prevent unnecessary reading of the memory content, close the window displaying the memory content (such as the [Memory] or [Disassembly] window) or make the settings so that the content will not be updated.</p> <p>The [Monitor] window, or the [Watch] window that satisfies the conditions listed below displays the memory content. Note that, however, opening these windows does not prevent realtime operation because the method of updating the memory content in these windows is different.</p> <p>Conditions:</p> <ol style="list-style-type: none">1. Registered symbols are only allocated to general-purpose registers.2. Registered symbols are only allocated to the monitor range set by the [Monitor] function (the mark R is colored in blue).3. Registered symbols are comprised of those with the conditions 1 and 2 listed above.

[General] page (cont)

[Break on access error]	When this box is checked, a break occurs (the user program stops) if your program accesses an access-prohibited area or writes to a write-protected area. Note: Whether this box is checked or not, the contents of the ROM will be changed if the ROM is specified as the destination of an EEPMOV instruction.
[Enable Watchdog Timer]	When this box is checked, the watchdog timer is enabled.
[User VCC Threshold]	Sets the voltage level for the user system. [Down] will be displayed in [User System Voltage] of the [Extended Monitor] window when the actual user VCC of the target system is lower than the specified value.
[EEPROM]	When [Count Break Enable] in this group box is checked, a break occurs when the execution count of EEPMOV instructions matches the value of [Count]. The execution count of EEPMOV instructions is displayed in [EEPMOV Count] of the [Extended Monitor] window and cleared every time the Go command is executed.
[Driver]	Displays the E6000 driver that is currently installed.
[Change driver in start up]	When this box is checked, selection of a driver will be available next time the emulator is connected.

The MCUs selectable by the [Device] option and options that depend on the MCU are listed below. To emulate an MCU with a description in the Expansion Hardware column, connect the correct expansion hardware.

Table 8.2 Environment for the H8/3150 E6000 Emulator CPU 300 Debugging Platform

[Device] Option	[External Clock] Option	Expansion Hardware
H8/3152	9.8304 MHz	None
H8/3153	7.1424 MHz	
H8/3155	4.9152 MHz	
H8/3156	3.5712 MHz	
H8/3112	Target	
H8/3113		

Note: Target in [External Clock] is only available when the target system is connected.

Table 8.3 Environment for the H8/3160 E6000 Emulator CPU 300 Debugging Platform

[Device] Option	[External Clock] Option	Expansion Hardware
H8/3161	9.8304 MHz	None
H8/3166	7.1424 MHz	
	4.9152 MHz	
	3.5712 MHz	
	Target	

Note: Target in [External Clock] is only available when the target system is connected.

Table 8.5 Environment for the AE-3 E6000 Emulator CPU 300 Debugging Platform

[Device] Option	[External Clock] Option	Expansion Hardware
AE340	9.8304 MHz	None
AE330	7.1424 MHz	
	4.9152 MHz	
	3.5712 MHz	
	Target	

Note: Target in [External Clock] is only available when the target system is connected.

8.1.4 Memory Mapping Function

This function allows reserved (access-prohibited) areas to be specified in one-byte units. Each memory block can be set in memory on the user system and the access can be specified as read-write, read-only, or access-prohibited in each case. It is not possible to change the attributes of the internal ROM, internal RAM, and internal I/O, which are the memory areas in the MCU. Only the attribute of the EEPROM can be changed.

8.1.5 [Status] Window

Selecting [View -> CPU -> Status] or clicking the [Status Display] toolbar button displays the [Status] window. The [Status] window has three sheets. This emulator displays the following items.

(1) [Memory] Sheet

Selecting the [Memory] tab on the [Status] window displays this sheet.

Table 8.6 [Memory] Sheet Items

[Item] Column	[Status] Column
Target Device Configuration	Displays memory mapping.
System Memory Resources	Displays the memory resource of the emulator hardware.
Program Name	Displays the program file name.

(2) [Platform] Sheet

Selecting the [Platform] tab on the [Status] window displays this sheet.

Table 8.7 [Platform] Sheet Items

[Item] Column	[Status] Column
Connected To:	Displays emulator name (driver used).
CPU	Displays the target MCU name.
Mode	Displays the selected mode.
Clock source	Displays the selected clock.
Run status	Displays the execution status. Break: The user program breaks Running: The user program is running
Cause of last break	Displays the cause of the emulator stopped at a break. Ready: User program not executed (immediately after starting the HEW) User Break: Break by the user PC Break: Break by program breakpoint On Chip Break B: Break by hardware PC Break Complex Event System: Break by complex event system Stepping Completed: Break by stepping completed Stepping Aborted: Break by stepping aborted EEMOV Instruction Count Break: Break by executing the specified number of EEMOV instructions Stack In I/O Area: Break by a stack in the I/O area Performance Break: Break by Performance Analysis ROM Write Access Break: Break by writing to ROM Write-protect Access Break: Break by writing to a read-only memory Unused Area Access Break: Break by accessing to an access-prohibited memory Invalid breakpoint: Break by a break instruction without PC Break
Event Time Count	Displays the measured result of the timer between events.
Run Time Count	Displays the total execution time of the program.
EEMOV Count	Displays the execution count of EEMOV instructions.
User System Voltage	Displays whether or not the user VCC is equal to or exceeds the value set in [User VCC Threshold] on the [General] page of the [Configuration Properties] dialog box.

(3) [Events] Sheet

Selecting the [Events] tab on the [Status] window displays this sheet.

Table 8.8 [Events] Sheet Item

[Item] Column	[Status] Column
Resources	Displays the resource information and the information on events such as the breakpoint.

8.1.6 Extended Monitor Function

Selecting [View -> CPU -> Extended Monitor] or clicking the [Extended Monitor] toolbar button displays the [Extended Monitor] window. This emulator displays the following items.

Table 8.9 [Extended Monitor] Window Items

[Item] Column	[Value] Column
User Reset	Displays the status of the reset pin.
User System Voltage	Displays whether or not the user VCC is equal to or exceeds the value set in [User VCC Threshold] on the [General] page of the [Configuration Properties] dialog box.
User Cable	Displays whether the user cable is connected or not.
Running status	Displays the address bus value in the MCU and the status of the CPU while the user program is running, and the cause of a break while the user program is halted. Break = <Cause of break> : Displays the cause of a break. Address = <Address bus value> : Displays the address bus value during the user program execution. Status = <Status of the CPU> : Displays the status of the CPU. CPU Prefetch : CPU instruction prefetch cycles CPU : CPU data access cycles SLEEP1 : Sleep mode 1 SLEEP2 : Sleep mode 2
LVD, HVD, LFD or HFD	Displays the status of the pin LVD, HVD, LFD, or HFD.

Note: In this emulator, the update interval of the [Extended Monitor] window cannot be selected or changed.

8.1.7 Signals to Indicate Bus States and Areas

The following tables show examples of signals to indicate the bus states and areas that can be acquired by the emulator.

Table 8.10 Bus State Signals Acquired by the Emulator

Bus State	Trace Display (Status)	Description
CPU Prefetch	CPU_PREFETCH	CPU prefetch cycles
CPU Data	CPU	CPU data access cycles
Other	OTHER	Others

Table 8.11 Area Signals Acquired by the Emulator

Area	Trace Display (Area)	Description
On-chip ROM	IN-ROM	Internal ROM
On-chip RAM	IN-RAM	Internal RAM
On-chip I/O	I/O-16	I/O
On-chip EEPROM	EEPROM	EEPROM

Note: The signals to indicate bus states and areas are used to set the [Bus/Area] condition of the event point. They can also be acquired as the trace information. The bus state signals are also used to set the condition not to acquire the trace ([Suppress] option) and in the Access Count Of Specified Range Measurement mode for measuring the hardware performance ([Access Type] option).

8.1.8 Monitoring Function

This emulator does not incorporate the bus monitoring circuit. To use the monitoring function, the bus monitor board (HS6000EBR01H) is required.

8.1.9 Trigger Points

This emulator does not incorporate the bus monitoring circuit. Connecting the bus monitor board (HS6000EBR01H) allows use of trigger points that can be set on the [Trigger] sheet in the [Event] window.

8.1.10 Trace Information

Selecting [View -> Code -> Trace] or clicking the [Trace] toolbar button displays the [Trace] window. Trace information that can be acquired by the emulator and trace information items to be displayed are as listed below.

[PTR]	Cycle number in the trace buffer. When the most recent record is record 0, earlier record numbers go backwards (-1, -2, ...). If a delay count has been set, the cycle number where the trace stop condition has been satisfied is record 0. For the cycle (during delay) executed until the trace has stopped, earlier record numbers go forward (+1, +2, ...) the most recent record.
[Address]	Address (6-digit hexadecimal)
[Instruction]	Disassembled code of the executed instruction
[Data]	Data bus value, displayed as 2-digit or 4-digit hexadecimal
[R/W]	Whether access was read (RD) or write (WR)
[Area]	Memory area being accessed; IN-ROM, IN-RAM, I/O, or EEPROM (not available when a time stamp is acquired)
[Status]	Bus status during this cycle; CPU_PREFETCH (prefetch) or CPU (CPU data access cycle) (not available when a time stamp is acquired)
[Clock]	Number of clock cycles in bus cycle as 1 to 8. To indicate more clock cycles, "OVR" is displayed (not available when a time stamp is acquired).
[Probes]	A 4-bit binary number showing the four probe pins in the order of Probe 4, Probe 3, Probe 2, and Probe 1 from the left (not available when a time stamp is acquired).
[IRQ2-1]	Status of IRQ input signals (not available when a time stamp is acquired)
[Timestamp]	Time stamp of the record. Time stamps start from zero each time the user program is executed. The timer resolution depends on the time stamp clock rate selected in the trace acquisition (only available when a time stamp is acquired).
[Source]	Source program
[Label]	Label information for the address (if defined)
[Timestamp-Difference]	Difference from the timestamp value shown on the previous line (only available when a time stamp is acquired)

8.1.11 Searching for a Trace Record

While using the emulator, the [Trace Find] dialog box has the following pages:

Table 8.12 [Trace Find] Dialog Box Pages

Page	Description
[General]	Sets the range for searching.
[Address]	Sets an address condition.
[Data]	Sets a data condition.
[R/W]	Selects the type of access cycles.
[Area]	Selects the area being accessed (not available when a time stamp is acquired).
[Status]	Selects the status of a bus (not available when a time stamp is acquired).
[Probes]	Selects the status of four probe signals (not available when a time stamp is acquired).
[IRQ2-1]	Selects the status of IRQ input signals (not available when a time stamp is acquired).
[Timestamp]	Specify the time stamp value for bus cycles (only available when a time stamp is acquired).

The [IRQ2-1] page is specific to this emulator. The description is given below.

- [IRQ2-1] page

Select the status of IRQ signals. The selection is not available when a time stamp is acquired.

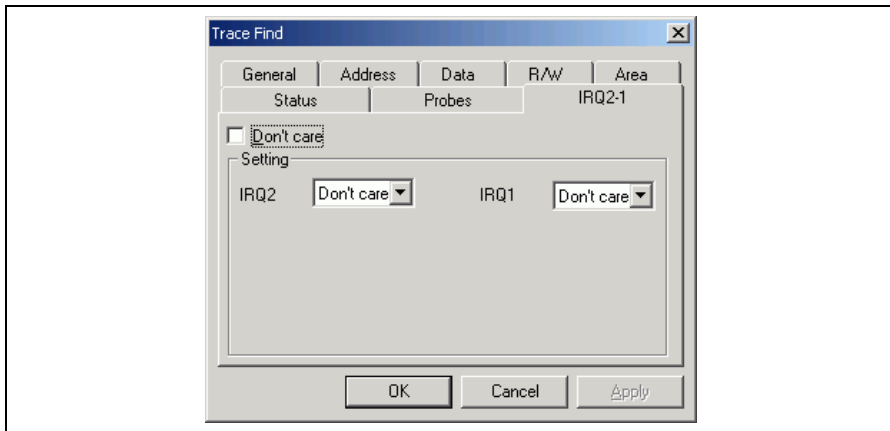

Figure 8.2 [Trace Find] Dialog Box ([IRQ2-1] Page)

[Don't care]: Detects no IRQ input condition when this box is checked.

[Setting]: Detects the specified IRQ input condition.

[IRQ2] and [IRQ1]: Select IRQ input conditions (not available if [Don't care] is selected)

Don't care: Detects no selected IRQ input condition.

High: The status of the IRQ input is high.

Low: The status of the IRQ input is low.

8.1.12 Trace Filtering Function

While using the emulator, the [Trace Filter] dialog box has the following pages:

Table 8.13 [Trace Filter] Dialog Box Pages

Page	Description
[General]	Selects the range for filtering.
[Address]	Sets address conditions.
[Data]	Sets data conditions.
[R/W]	Selects the type of access cycles.
[Area]	Selects the area being accessed (not available when a time stamp is not acquired).
[Status]	Sets the status of a bus (not available when a time stamp is not acquired).
[Probes]	Selects the states of four probe signals (not available when a time stamp is not acquired).
[IRQ2-1]	Selects the states of IRQ input signals (not available when a time stamp is not acquired).
[Timestamp]	Specifies the time stamp value for bus cycles (only available when a time stamp is acquired).

The [IRQ2-1] page is specific to this emulator. The description is given below.

- [IRQ2-1] page

Select the status of IRQ signals. The selection is not available when a time stamp is acquired.

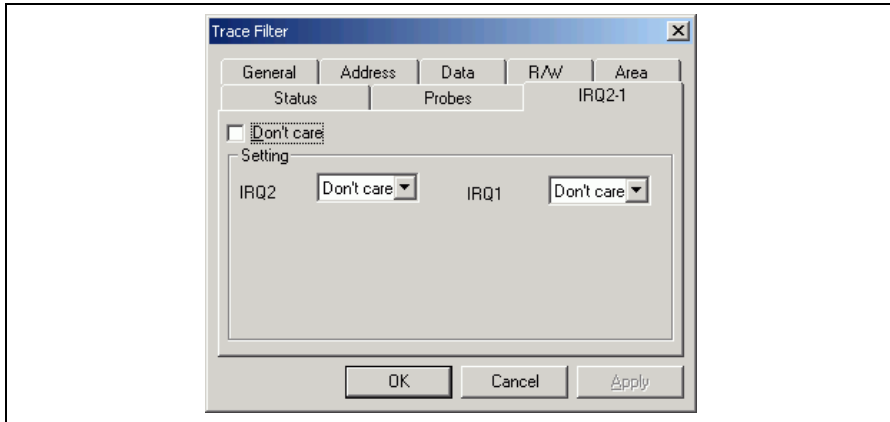

Figure 8.3 [Trace Filter] Dialog Box ([IRQ2-1] Page)

[Don't care]: Detects no IRQ input condition when this box is checked.

[Setting]: Detects the specified IRQ input condition.

[IRQ2] and [IRQ1]: Select IRQ input conditions (not available if [Don't care] is selected)

Don't care: Detects no selected IRQ input condition.

High: The status of the IRQ input is high.

Low: The status of the IRQ input is low.

8.2 Note on Usage of the H8/3160 E6000 Emulator

There is the following note on usage of the emulator.

8.2.1 Environment for Execution of the Tutorial Program

To execute the tutorial program, specify "Tutorial.hws" stored in the following directory:
HEW installation destination directory\Tools\Renesas\DebugComp\Platform\E6000\3160\Tutorial

Appendix A Troubleshooting

- ? *I have clicked the “Stop Build” button or selected [Build->Stop Build] to abort a build but the build process has not stopped.*

The HEW will stop the build after it has built the current file (or executed the current single phase). If the builder does not respond after a longer period of time you can select [**Build->Terminate Current Tool**] which will attempt to forcibly terminate the current process. Do NOT assume that any output from the tool you terminated is valid. It is recommended that you delete any output files produced and ensure that the phase is executed again.

- ? *I have a text file in the editor but it does not show any syntax coloring.*

Ensure that you have named the file (i.e. saved it) and that the “Enable syntax coloring” check box is set on the “Editor” tab of the “Tools Options” dialog, which is launched via [**Tools->Options...**]. HEW checks a file group to which the file’s extension belongs and decides whether the file is colored. To view the current defined extensions and their file groups, use the “File Extensions” dialog which is launched via [**Project->File Extensions...**]. To view coloring information, use the “Format” tab of the “Tools Options” dialog, which is launched via [**Tools->Options...**]. (See the “Syntax Coloring” section in chapter 4, “Using the Editor” for details.)

- ? *I want to change the settings of a tool but the [Tools->Administration...] menu option cannot be selected.*

[**Tools->Administration...**] cannot be selected while a workspace is open. To enter the “Tool Administration” dialog first close the current workspace.

- ? *I did not edit any of the project files. But some of files were built again when I selected [Build->Build].*

A file is built again if any of the following conditions holds:

1. The options for the current file have been modified since the last build.
2. If any of the output files are missing.
3. Any of the source files have a newer date than the phase’s output files.
4. Any of the dependent files have a newer date than the phase’s output files.
5. In a user-defined custom build phase, the “Don’t check for input file(s) existence before executing” check box is checked. To see the status of this check box, select [**Options->Build Phases...**], select the phase in the “Build Phase Order” list in the “Build Order” tab, and click the “Modify...” button. Then you will see the “Don’t check for input file(s) existence before executing” check box on the “Command” tab.
6. A subcommand file is selected in Optimizing Linkage Editor.

- ? *I want to exclude a file in a project from build temporarily.*

Push the right button of your mouse on the file in the “Projects” tab of the “Workspace” window, and select [**Exclude Build <file>**], where <file> is the selected file. Then the file is excluded from build. To include the file in build again, push the right button of your mouse on the file, and select [**Include Build <file>**].

- ? *I opened a workspace from my PC, and one of my colleagues opened the same workspace simultaneously from another PC. I changed the settings of the workspace and saved it. He or she saved the workspace after me. I opened the workspace again and found that the settings of the workspace differed from what I had set before.*

The settings saved last are enforced. Once HEW opens a workspace, it is updated inside the memory. HEW does not save the settings into a file until a user saves the workspace intentionally.

? *I want HEW to automatically specify default options to a file, which is newly added to a project.*

You can specify default options to a phase if the phase is a multiple build phase. Select a phase from the [Options] menu. If the phase is a multiple build phase, a file list is displayed on the left-hand side of the options dialog (figure A.1). In the file list, open a folder of a file group to which you want to specify your default options. You will find a “Default Options” icon in the folder. Select the icon, specify options on the right-hand side of the options dialog, and click “OK”. The options specified here will be given to any new file of that file group when it is first added to the project.

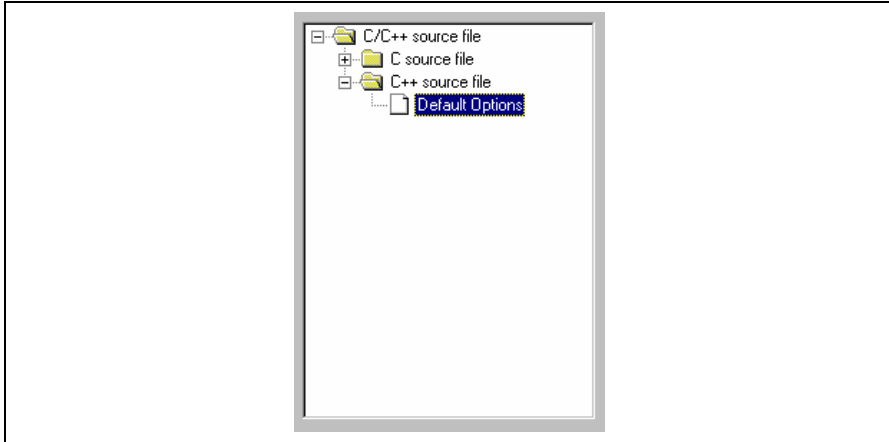

Figure A.1: Options Dialog File List

? *I selected [Build->Build All], but the dependencies in the “Projects” tab of the “Workspace” window is not updated while selecting [Build->Build] updates the dependencies.*

[Build->Build All] does not update the dependencies in the “Projects” tab of the “Workspace” window. To update the dependencies, select [Build->Update All Dependencies].

Appendix B Regular Expressions

The High-performance Embedded Workshop editor allows you to include special characters in search strings when performing a find or replace operation. These characters are listed in table B.1 and are detailed in the following pages.

Table B.1: Regular Expression Characters

Character	Meaning
+	Matches one or more occurrences of the preceding item, except in a bracket expression. For example, <code>a+</code> matches <code>a</code> , <code>aa</code> , <code>aaa</code> , and so on.
*	Matches zero or more occurrences of the preceding item, except in a bracket expression. For example, <code>a*</code> matches the empty string, <code>a</code> , <code>aa</code> , and so on.
?	Matches zero or one occurrence(s) of the preceding item, except in a bracket expression. For example, <code>a?</code> matches the empty string and <code>a</code> .
{ and }	Specify a cardinality range, formed as follows: <code>{m,n}</code> . This construct matches between <code>m</code> and <code>n</code> occurrences of the preceding item. For example, <code>a{2,3}</code> matches <code>aa</code> and <code>aaa</code> . This construct can also be formed using <code>{m,}</code> and <code>{m}</code> . The first matches <code>m</code> or more occurrences of the preceding item. For example, <code>a{2,}</code> matches <code>aa</code> , <code>aaa</code> , <code>aaaa</code> , and so on. The second matches exactly <code>m</code> occurrences of the preceding item. For example, <code>a{2}</code> matches <code>aa</code> .
[and]	Create a <i>bracket expression</i> . Bracket expressions create a set of items, any of which may be matched. For example, <code>[abc]</code> matches <code>a</code> , <code>b</code> , or <code>c</code> . Within a bracket expression all regular expression special characters are treated as normal, non-special characters, except: - specifies a range of character values, based on their bit pattern. For example, <code>[A-Za-z]</code> matches all uppercase and lowercase English characters. To indicate - as a character in the bracket expression, it must be the first or last character in the set; for example, <code>[-a-z]</code> or <code>[A-Z-]</code> . ^ is special only when placed in the first character position within the bracket set. Using ^ in the first position complements the set of items to be matched. For example, <code>[^a-z]</code> matches all characters except for lowercase English letters. Finally, in order to include a <code>]</code> as a character in the bracket set, you must include it as the first character in the set, as in <code>[]abc]</code> or <code>[^]abc]</code> .
(and)	Group regular expression items into subexpressions, which are treated as a single unit. For example, whereas <code>ab*</code> matches <code>a</code> , <code>ab</code> , <code>abb</code> , and so on, <code>(ab)*</code> matches the empty string, <code>ab</code> , <code>abab</code> , and so on. <code>(</code> and <code>)</code> are not treated as special characters inside a bracket expression.
\	Escapes a regular expression character, causing it to be treated as a regular character. For example, whereas <code>(ab)</code> indicates a subexpression consisting of <code>ab</code> , <code>\(ab\)</code> denotes the sequence of characters <code>(</code> , <code>a</code> , <code>b</code> , and <code>)</code> . Note: To specify the <code>\</code> character in C++ source code, you must specify <code>\\</code> , as the C++ compiler treats the <code>\</code> character as special, denoting the beginning of an escape sequence embedded in the C++ source code. In data files, or text controls in dialog boxes, however, the double backslash is not necessary.
^	Indicates that a regular expression or subexpression is anchored at the beginning of the input string. For example, <code>^ab</code> matches <code>ab</code> and <code>abc</code> , but not <code>cab</code> . Recall that <code>^</code> is treated differently in bracket expressions.

Table B.1: Regular Expression Characters (cont)

Character	Meaning
\$	Indicates that a regular expression or subexpression is anchored at the end of the input string. For example, ab\$ matches ab and cab, but not abc.
	Denotes alternation, or the creation of a set of equally valid, alternate expressions or subexpressions, each of which can be matched. For example, ab cd matches ab or cd.
.	Matches any code unit, except for those which indicate the logical end of a line.

Appendix C Placeholders

This appendix describes how to use the placeholders, a feature provided by several of the HEW components.

C.1 What is a Placeholder?

A placeholder is a special string, inserted into text, which is replaced at some subsequent time for the actual value. For example, one of the HEW placeholders is \$(FULLFILE) which represents a file with a full path. Suppose that you have an editor in `c:\myedit\myeditor.exe`, which can take the file to edit as a parameter. When invoking the editor the following shortcut could be made, e.g.:

```
c:\myedit\myeditor.exe c:\files\file1.c
```

if you wanted to open FILE1.C from the directory `c:\files`. However, what happens if you want the HEW to open any file through this editor? The problem is that the command above is specific to "`c:\files\file1.c`". What we want to be able to do is to tell the HEW to use the editor specified but to open the file that I have chosen at that time. To do this, you can replace the specific name of the file for a general placeholder, i.e.:

```
c:\myedit\myeditor.exe $(FULLFILE)
```

Now whenever the HEW launches the editor with a file, it knows that it has to replace \$(FULLFILE) with the file you have selected.

C.2 Inserting a Placeholder

Placeholders can only be entered into three specific edit fields within the HEW (figures C.1, C.2 and C.3). There are four ways a placeholder can be entered:

In the first example, place the insertion cursor at the point you would like to insert the placeholder and then select the required placeholder from the popup menu to the right of the edit field.

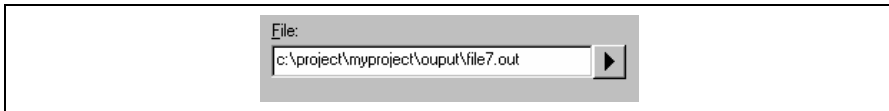

Figure C.1 Placeholder Popup Menu

In the second example, select the required placeholder other than [Custom directory] from the combo box and specify a sub-directory relative to the directory shown by the placeholder. If you select [Custom directory], specify an absolute directory path in the [Sub-Directory] field.

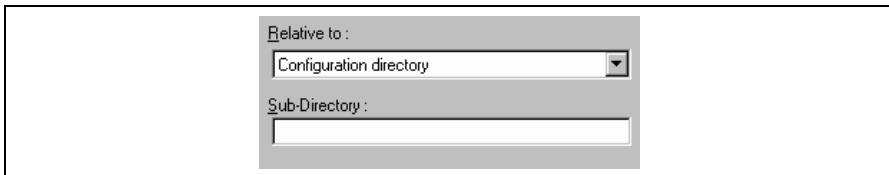

Figure C.2 Placeholder Combo Box and Sub-Directory Field

Note: The [Sub-Directory] field may be written as the [File path] field.

In the third example, place the insertion cursor at the point you would like to insert the placeholder, select the required placeholder from the combo box and then click the [Insert] button.



Figure C.3 Placeholder Combo Box

In the fourth example, type the placeholder into the field directly. Ensure that you type the placeholder name in uppercase and that it is preceded by \$(and followed by), i.e.

This is correct:

\$(FILEDIR)

These are incorrect:

\$(Filedir)

\$(FILEDIR)

\$FILEDIR

C.3 Available Placeholders

Table C.1 lists the placeholders and their meanings.

Table C.1 Placeholders

Placeholder	Meaning
\$(FULLFILE)	Filename (including full path)
\$(FILEDIR)	File directory
\$(FILENAME)	Filename (excluding path and including extension)
\$(FILELEAF)	Filename (excluding path and extension)
\$(EXTENSION)	File extension
\$(WORKSPDIR)	Workspace directory
\$(WORKSPNAME)	Workspace name
\$(PROJDIR)	Project directory
\$(PROJECTNAME)	Project name
\$(CONFIGDIR)	Configuration directory
\$(CONFIGNAME)	Configuration name
\$(HEWDIR)	HEW installation directory
\$(TCINSTALL)	Toolchain install directory (on option dialog)
\$(TOOLDIR)	Tool installation directory (Tools Administration)
\$(TEMPDIR)	Temp directory
\$(WINDIR)	Windows® directory
\$(WINSYSDIR)	Windows® system directory
\$(EXEDIR)	Command directory
\$(USERNAME)	User login (Version control)
\$(PASSWORD)	User password (Version control)
\$(VCDIR)	"Virtual" version control directory
\$(COMMENT)	Comment (Version control)
\$(LINE)	Line number of an error/warning

For example, the placeholders will be expanded as shown in table C.2.

Table C.2 Placeholder Expansions (Example)

Placeholder	Expanded placeholder (example)
\$(FULLFILE)	c:\hew\workspace\project\file.src
\$(FILEDIR)	c:\hew\workspace\project
\$(FILENAME)	file.src
\$(FILELEAF)	file
\$(EXTENSION)	src
\$(WORKSPDIR)	c:\hew\workspace
\$(WORKSPNAME)	workspace
\$(PROJDIR)	c:\hew\workspace\project
\$(PROJECTNAME)	project
\$(CONFIGDIR)	c:\hew\workspace\project\debug
\$(CONFIGNAME)	debug
\$(HEWDIR)	c:\hew
\$(TCINSTALL)	c:\hew\toolchains\hitachi\sh\511
\$(TOOLDIR)	c:\hew\toolchains\hitachi\sh\511
\$(TEMPDIR)	c:\Temp
\$(WINDIR)	c:\Windows
\$(WINSYSDIR)	c:\Windows\System
\$(EXEDIR)	v:\vc\win32
\$(USERNAME)	JHARK
\$(PASSWORD)	214436
\$(VCDIR)	"c:\project" is mapped to "x:\vc\project"
\$(COMMENT)	"Please Enter Comment" dialog is invoked
\$(LINE)	12

In table C.2, we are assuming that

- a file path is "c:\hew\workspace\project\file.src".
- a workspace named "workspace" is located at "c:\hew\workspace".
- a project named "project" is located at "c:\hew\workspace\project".
- a configuration named "debug" has a configuration directory located at "c:\hew\workspace\project\debug".
- HEW.EXE is installed in "c:\hew".
- a *.HRF file of a toolchain (i.e. compiler, assembler, linker) is located at "c:\hew\toolchain\hitachi\sh\511". This is referred to as \$(TCINSTALL) on the option setting dialogs of the [Options] menu and as \$(TOOLDIR) on the "Tools Administration" dialog.
- the Windows® operating system is installed in "c:\Windows" and the Windows® system directory is "c:\Windows\System".
- a version control executable path is "v:\vc\win32\ss.exe", a user name and its password to login the version control system are "JHARK" and "214436" respectively, \$(COMMENT) is specified in a command line to the version control executable, and "c:\project" is mapped to "x:\vc\project" on the "Projects" tab of the "Version Control Setup" dialog, which is invoked via [Tools->Version Control->Configure...].
- an error of compiler or assembler occurred at line 12.

Note: Not all of the placeholders are relevant in every field. For example, the \$(LINE) placeholder has no meaning when specifying a dependent files location. \$(USERNAME), \$(PASSWORD), \$(VCDIR), and \$(COMMENT) placeholders are acceptable only in version control. If you enter a placeholder into an edit field where it is not acceptable you might be informed.

C.4 Placeholder Tips

Placeholders are there to allow you to create flexible paths to the various files used by the system.

- If there is a placeholder popup menu (▾) next to an edit field into which you are about to enter a path or file, you should consider how you can use a placeholder to make that path or file definition flexible.
- If you use several configurations, then the \$(CONFIGDIR) placeholder is very useful to ensure that files can be written to and from the current configuration's directory.
- Wherever possible, use a placeholder. They can always be removed or added later so don't be afraid to experiment.

Appendix D I/O File Format

HEW formats the [IO] window based on information it finds in an I/O Register definition file. When you select a debugging platform, HEW will look for a “<device>.IO” file corresponding to the selected device and load it if it exists. This file is a formatted text file that describes the I/O modules and the address and size of their registers. You can edit this file, with a text editor, to add support for memory mapped registers or peripherals you may have specific to your application (e.g. registers in an ASIC device mapped into the microcomputer’s address space).

The following describes two formats of the “<device>.IO” file that supports or not the bit field.

D.1 File format (Bit Field Not Supported)

Each module name must be defined in the [Modules] definition section and the numbering of each module must be sequential. Each module corresponds to a register definition section and within the section each entry defines an I/O register.

The [BaseAddress] definition is for devices where the location of I/O registers moves in the address space depending on the CPU mode. In this case, the [BaseAddress] value is the base address of the I/O registers in one specific mode and the addresses used in the register definitions are the address locations of the registers in the same mode. When the I/O register file is actually used, the [BaseAddress] value is subtracted from the defined register address and the resultant offset added to the relevant base address for the selected mode.

The [Register] definition entry is entered in the format <name> = <address> [<size> [<absolute>]].

1. <name> register name to be displayed.
2. <address> address of the register.
3. <size> which may be B, W or L for byte, word, or longword (default is byte).
4. <absolute> which can be set to A if the register is at an absolute address. This is only relevant if the I/O area address range moves about on the CPU in different modes. In this case, if a register is defined as absolute the base address offset calculation is not performed and the specified address is used directly.

Comment lines are allowed and must start with a “;” character.

An example is shown below.

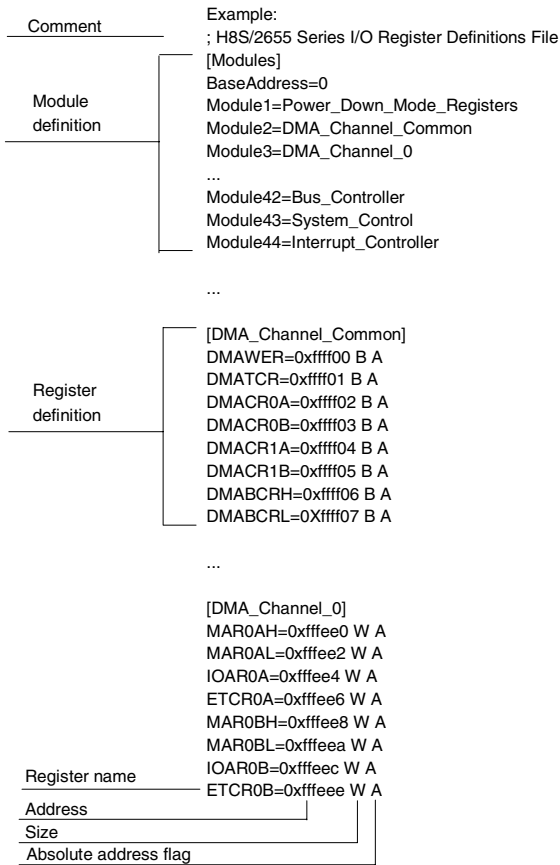

D.2 File format (Bit Field Supported)

Each module name must be defined in the [Modules] definition section and the numbering of each module must be sequential. Each module corresponds to a register definition section and within the section each entry defines an I/O register.

The user must define "FileVersion=2" at the start of the section. It means that this I/O register file is described with the version that supports the bit field.

The [BaseAddress] definition is for devices where the location of I/O registers moves in the address space depending on the CPU mode. In this case, the [BaseAddress] value is the base address of the I/O registers in one specific mode and the addresses used in the register definitions are the address locations of the registers in the same mode. When the I/O register file is actually used, the [BaseAddress] value is subtracted from the defined register address and the resultant offset added to the relevant base address for the selected mode.

Each module has a section that defines the registers forming it along with an optional dependency. The dependency is checked to see if the module is enabled or not. Each register name must be defined in the section and the numbering of each register must be sequential. The dependency is entered in the section as dep=<reg> <bit> <value>.

1. <reg> is the register id of the dependency.
2. <bit> is the bit position within the register.
3. <value> is the value that the bit must be for the module to be enabled.

The [Register] definition entry is entered in the format id=<name> <address> [<size> [<absolute>[<format>[<bitfields>]]]].

1. <name> register name to be displayed.
2. <address> address of the register.
3. <size> which may be B, W or L for byte, word, or longword (default is byte).
4. <absolute> which can be set to A if the register is at an absolute address. This is only relevant if the I/O area address range moves about on the CPU in different modes. In this case, if a register is defined as absolute the base address offset calculation is not performed and the specified address is used directly.
5. <format> format for register output. Valid values are H for Hexadecimal, D for decimal, and B for binary.
6. <bitfields> section defining the bits within the register.

Bitfield sections define the bits within a register each entry is of the type bit<no>=<name>.

1. <no> is the bit number.
2. <name> is a symbolic name of the bit.

Comment lines are allowed and must start with a ";" character.

An example is shown below.

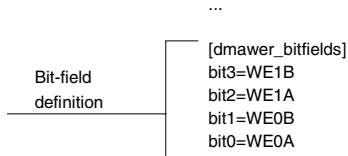
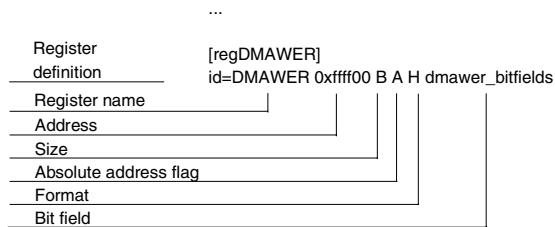
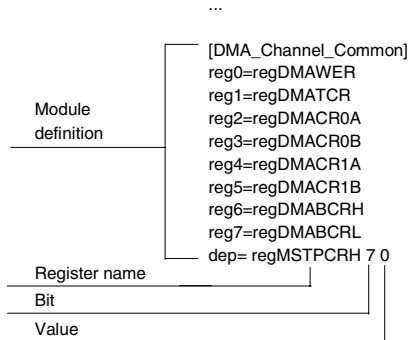
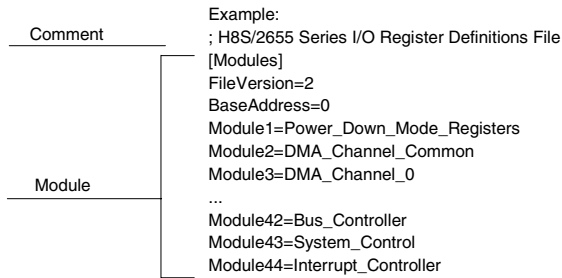

Appendix E Symbol File Format

To decode the symbol file correctly, the file must be formatted as a Pentica-B file:

1. The file must be a plain ASCII text file.
2. The file must start with the word "BEGIN".
3. Each symbol must be on a separate line with the value first, in hexadecimal terminated by an "H", followed by a space then the symbol text.
4. The file must end with the word "END".

Example:

```
BEGIN
11FAH Symbol_name_1
11FCH Symbol_name_2
11FEH Symbol_name_3
1200H Symbol_name_4
END
```

Appendix F HMAKE User Guide

F.1 Command line

The following section describes the command line that should be used to execute the hmake program on a file using none or more of the available options.

F.1.1 Basic structure

The command line must be of the following syntax:

```
hmake <make file you wish to execute> <parameter list>
```

If a file is specified without an extension then “.mak” will be appended to it. The parameter list may include none or more of the parameters listed in the following section. The parameters list may appear before the make file name if you wish. Each parameter must be separated by at least one white space character. Parameters are not case sensitive. If no parameters are given and no file is given then help information will be displayed.

F.1.2 Exit codes

If there are any syntax errors in the make file being executed or if any process executed whilst running the make file returns an invalid error code then hmake will exit with code 1. Otherwise hmake will exit with code 0 (See below for file syntax and how to specify exit code conditions).

F.1.3 Parameters

The following table shows the available parameters and their function:

Table F.1: hmake’s parameters and functions

Parameter	Function
/A	Execute all commands regardless of input/output file status. Equivalent to a Build All.
/N	Use status of input/output files to calculate what commands need to be executed (as normal) and then display the commands but do not execute them.
/?	Display help info.

F.2 File syntax

There are four basic types of statement used in a hmake file, the variable declaration the description block, the comment and the message command. These can be combined in any order to produce a hmake file but a variable must be declared in a variable declaration before it is used in a description block or other variable declaration. The first “all” statement used in nmake files is not required in a hmake file. Commands are executed in order, as they appear in the make file.

Note: the “→” character is used to show were a tab character must be used in order to keep the make file syntactically correct.

F.2.1 Variable declarations

A variable declaration declares a variable which can then be used in any statement throughout the rest of the hmake file. A declaration has the following syntax:

```
<variable name> = <value>
```

Any number of white space characters are allowed between the variable name and the ‘=’ sign and the value and the ‘=’ sign. The value may be split over several lines using a ‘\’ character. If the value contains ‘\’ characters within the main text then these are taken literally. Only ‘\’ characters followed by a new line are considered to indicate a value wrapping over more than one line.

There follows some examples of valid variable declarations:

```
EXECUTABLE = c:\dir\prog.exe
OUTPUT = c:\dir2\file1.out
INPUT = c:\dir2\file1.c
DEPEND = c:\dir2\file2.h \
        c:\dir2\file3.h \
        c:\dir2\file4.h
```

In order to use a variable later in the hmake file write the variable name with “\$(” added to the front and “)” added to the back. The variable name (along with the “\$()” characters) will be substituted with the variables value. For examples of this see later under description blocks. Only alphanumeric characters and underscore characters are allowed in variable names. It is possible to use a variable inside the declaration of a different variable but all variables must be declared before they are used.

F.3 Description blocks

F.3.1 Basic outline

A description block specifies one or more targets, zero or more dependants and a list of commands which should be executed if the newest dependent is newer than the newest target. If none of the targets exist and/or none of the dependants exist then the commands will always be executed. It is not necessary to specify any dependants if you wish the commands to always be executed. A description block has the following syntax:

```
<target1> <target2> ... : <dependant1> <dependant2> ...  
→ <command1>  
→ <command2>  
→ ...  
→ <commandn>
```

Any number of white space characters are allowed between the last target and the ':' character and the first dependant and the ':' character. No white space is allowed before the first target. Each target and each dependant must be separated by at least one white space character. A tab character must be present at the start of a line containing a command. Variables may be used in a description block using the syntax specified above under variable declarations.

There follows some examples of valid description blocks (one of which uses the variable specified above under variable declarations):

```
c:\dir1\file1.obj : c:\dir1\file1.c c:\dir1\file1.h  
→ gcc c:\dir1\file1.c  
$(OUTPUT) : $(INPUT) $(DEPEND)  
→ $(EXECUTABLE) $(INPUT)
```

F.3.2 Special commands

There are two special commands which can be used in a description block. The "cd" command changes the current directory and the "set" command sets an environment variable which will then be in use for the duration of the make file execution. Both are used in the same way as the DOS equivalents.

There follows some examples of valid description blocks which use these commands:

```
CHANGEDIR :  
→ cd c:\dir1\dir2  
SETENV:  
→ set VAR1=value1  
→ set VAR2=value2  
→ set VAR3=value3
```

It does not matter that CHANGEDIR and SETENV are not file names. They will be treated as files that do not exist and so the commands will always be executed.

F.3.3 Sub command files

If you wish hmake to generate a sub command file for you then the command part of the description block should be specified as follows (this replaces <commandn> above):

```
→ <command start> <<
→ <sub command1>,
→ <sub command2>,
→ ...
→ <sub commandn>
<<<command end>
```

This will generate a sub command file, in the windows temporary directory, which will contain the lines <sub command1>, <sub command2> etc. This command file will be deleted once the make process has completed. The name of the command file will be substituted for all the text between the two "<<"s. You do not have to worry about the name of the sub command file. This is generated by hmake.

For example:

```
c:\dir1\file1.obj : c:\dir1\file1.c c:\dir1\file1.h
→ gcc @"<<
→ -c -o c:\dir1\file1.obj c:\dir1\file1.c
<<<"
```

If the sub command file generated has the name "c:\temp\hmk111.cmd" then the following would be executed by hmake (assuming c:\dir1\file1.obj is out of date):

```
gcc @"c:\temp\hmk111.cmd"
```

The command file (c:\temp\hmk111.cmd) would contain:

```
-c -o c:\dir1\file1.obj c:\dir1\file1.c
```

It is possible to include more than one command in the description block and to use combinations of the standard, and sub command file commands.

F.4 Comments

A '#' character signifies a comment. When this character appears as the first character on a line the rest of the line (up until the next new line character) is ignored. There follows examples of valid comments:

```
# My hmake file
# Variable declaration
OUTPUT= c:\dir1\file1.obj
# Descriptor
$(OUTPUT) : c:\dir1\file1.c c:\dir1\file1.h
→ set VAR1=value1
→ gcc c:\dir1\file1.c
```

A comment must occupy its own line in the hmake file. It is not possible to put comments on the end of other statements.

F.5 Message commands

The message command is used to output a line of text to standard out whilst a make file is executing. These text lines will be output in the order they appear in the make file, in amongst output from any executables being executed as appropriate. No buffering of output text will take place. A message command has the following syntax:

```
!MESSAGE <text to output>
```

A new line character is assumed to come after the last character in <text to output>. Any white space between !MESSAGE and <text to output> will be ignored. There follows an example of a valid message command:

```
!MESSAGE Executing C Compiler
```

Appendix G Menus

Table G.1 shows GUI menus.

Table G.1 GUI Menus



















Menu	Option	Shortcut	Toolbar Button	Remarks	
View	Disassembly	Ctrl + D		Opens the [Disassembly] window.	
	Command Line	Ctrl + L		Opens the [Command Line] window.	
	TCL toolkit	Shift + Ctrl + L		Opens the [Console] window.	
	Workspace	Alt + K		Opens the [Workspace] window.	
	Output	Alt + U		Opens the [Output] window.	
	Difference				Opens the [Difference] window.
CPU	Registers	Ctrl + R		Opens the [Registers] window.	
	Memory...	Ctrl + M		Opens the [Memory] window.	
	IO	Ctrl + I		Opens the [IO] window.	
	Status	Ctrl + U		Opens the [Status] window.	
	Extended Monitor				Opens the [Extended Monitor] window.
	Monitor	Monitor Setting...	Shift + Ctrl + E		Opens the [Monitor] window.
	Windows Select...			Opens the [Windows Select] dialog box to list, add, or edit the [Monitor] window.	
Symbol	Labels	Shift + Ctrl + A		Opens the [Labels] window.	
	Watch	Ctrl + W		Opens the [Watch] window.	
	Locals	Shift + Ctrl + W		Opens the [Locals] window.	
Code	Eventpoints	Ctrl + E		Opens the [Eventpoints] window.	
	Code Coverage...	Shift + Ctrl + H		Opens the [Code Coverage] window.	
	Trace	Ctrl + T		Opens the [Trace] window.	
	Stack Trace	Ctrl + K		Opens the [Stack Trace] window.	

Table G.1 GUI Menus (cont)









Menu	Option	Shortcut	Toolbar Button	Remarks	
View (cont)	Graphic	Image...	Shift + Ctrl + G		Opens the [Image] window.
		Waveform...	Shift + Ctrl + V		Opens the [Waveform] window.
	Performance	Performance Analysis	Shift + Ctrl + P		Opens the [Performance Analysis] window.
Options		Debug Sessions...			Opens the [Debug Sessions] dialog box to list, add, or remove the debug session.
		Debug Settings...			Opens the [Debug Settings] dialog box to set the debugging conditions or download modules.
Radix		Hexadecimal			Uses a hexadecimal for displaying a radix in which the numerical values will be displayed and entered by default.
		Decimal			Uses a decimal for displaying a radix in which the numerical values will be displayed and entered by default.
		Octal			Uses an octal for displaying a radix in which the numerical values will be displayed and entered by default.
		Binary			Uses a binary for displaying a radix in which the numerical values will be displayed and entered by default.
Emulator		System...			Opens the [Configuration] dialog box allowing the user to modify the debugging platform settings.
		Memory Resource...			Opens the [Memory Mapping] dialog box allowing the user to view and edit the debugging platform's current memory map.

Table G.1 GUI Menus (cont)

















Menu	Option	Shortcut	Toolbar Button	Remarks
Debug	Reset CPU			Resets the target hardware and sets the PC to the reset vector address.
	Go	F5		Starts executing the user program at the current PC.
	Reset Go	Shift + F5		Resets the target hardware and executes the user program from the reset vector address.
	Go To Cursor			Starts executing the user program at the current PC until the PC reaches the address indicated by the current text cursor position.
	Set PC To Cursor			Sets the PC to the address at the row of the text cursor.
	Run...			Launches the [Run Program] dialog box allowing the user to enter the PC or PC breakpoint during executing the user program.
	Display PC	Shift + Ctrl + Y		Opens the Editor or Disassembly window at the address of the PC.
	Step In	F11		Executes a block of user program before breaking.
	Step Over	F10		Executes a block of user program before breaking. If a subroutine call is reached, then the subroutine will not be entered.
	Step Out	Shift + F11		Executes the user program to reach the end of the current function.
	Step...			Launches the [Step Program] dialog box allowing the user to modify the settings for stepping.
Step Mode	Auto			Steps only one source line when the [Source] window is active. When the [Disassembly] window is active, stepping is executed in a unit of assembly instructions.
	Assembly			Executes stepping in a unit of assembly instructions.
	Source			Steps only one source line.

Table G.1 GUI Menus (cont)

Menu	Option	Shortcut	Toolbar Button	Remarks
Debug (cont)	Halt Program	Esc		Stops the execution of the user program.
	Connect			Connects the debugging platform.
	Initialize			Disconnects the debugging platform and connects it again.
	Disconnect			Disconnects the debugging platform.
	Download Modules			Downloads the object program.
	Unload Modules			Unloads the object program.
Memory	Search...			Searches for the specified value from the specified memory area.
	Copy...			Copies the specified memory area to the specified address.
	Compare...			Compares the specified two memory areas.
	Fill...			Fills the specified value in the specified memory area.
	Test...			Tests the specified memory area.
	Refresh			Forces a manual update of the contents of all the [Memory] windows open.
	Configure Overlay...			

Appendix H Command Lines

Table H.1 lists the HEW commands.

Table H.1 HEW Commands

No.	Command Name	Abbreviation	Function
1	!	-	Comment
2	ADD_FILE	AF	Adds a file to the current project
3	ANALYSIS	AN	Enables or disables performance analysis
4	ANALYSIS_RANGE	AR	Sets or displays a performance analysis range
5	ANALYSIS_RANGE_DELETE	AD	Deletes a performance analysis range
6	AUTO_COMPLETE	AC	Enables or disables command complement function
7	ASSEMBLE	AS	Assembles instructions into memory
8	ASSERT	-	Checks if an expression is true or false
9	BREAKPOINT	BP	Sets a breakpoint at an instruction address
10	BREAKPOINT_CLEAR	BC	Deletes breakpoints
11	BREAKPOINT_DISPLAY	BD	Displays a list of breakpoints
12	BREAKPOINT_ENABLE	BE	Enables or disables a breakpoint
13	BREAKPOINT_SEQUENCE	BS	Sets sequential breakpoints
14	BUILD	BU	Starts a build operation on the current project
15	BUILD_ALL	BL	Starts a build all operation on the current project
16	CHANGE_CONFIGURATION	CC	Sets the current configuration
17	CHANGE_PROJECT	CP	Sets the current project
18	CHANGE_SESSION	CS	Changes the session of the current project
19	CLOCK	CK	Set the CPU clock rate in the emulator
20	CONFIGURE_PLATFORM	CPF	Sets the debugging environment for the emulator
21	COVERAGE_CLEAR	CVC	Resets code coverage measurement
22	COVERAGE_ENABLE	CVE	Enables or disables code coverage or data coverage information
23	COVERAGE_DISPLAY	CVD	Displays code coverage information
24	COVERAGE_LOAD	CVL	Loads code coverage information
25	COVERAGE_RANGE	CVR	Sets range of code coverage
26	COVERAGE_SAVE	CVS	Saves code coverage information
27	DEFAULT_OBJECT_FORMAT	DO	Sets the default object (program) format
28	DEVICE_TYPE	DE	Selects a device type to emulate
29	DISASSEMBLE	DA	Disassembles memory contents
30	EEPROM_DISPLAY	EP	Displays protected area of EEPROM
31	EEPROM_MAP	EM	Sets the protect bit of EEPROM
32	ERASE	ER	Clears the [Command Line] window
33	EVALUATE	EV	Evaluates an expression

Table H.1 HEW Commands (cont)

No.	Command Name	Abbreviation	Function
34	EXMONITOR_DISPLAY	EXMD	Displays the content of the expansion monitor
35	EXMONITOR_SET	EXMS	Selects whether or not to display the items in the expansion monitor
36	EXMONITOR_SETRATE	EXMSR	Sets the time to update the expansion monitor during emulation or a break
37	FILE_LOAD	FL	Loads an object (program) file
38	FILE_SAVE	FS	Saves memory to a file
39	FILE_UNLOAD	FU	Unloads a file
40	FILE_VERIFY	FV	Verifies file contents against memory
41	GENERATE_MAKE_FILE	GM	Creates a makefile to be built outside the HEW
42	GO	GO	Executes user program
43	GO_RESET	GR	Executes user program from reset vector
44	GO_TILL	GT	Executes user program until temporary breakpoint
45	HALT	HA	Halts the user program
46	HELP	HE	Displays the syntax of a command
47	INITIALIZE	IN	Initializes the debugging platform
48	LOG	LO	Controls command output logging
49	MAP_DISPLAY	MA	Displays memory mapping
50	MAP_SET	MS	Sets memory mapping
51	MEMORY_COMPARE	MC	Compares memory contents
52	MEMORY_DISPLAY	MD	Displays memory contents
53	MEMORY_EDIT	ME	Modifies memory contents
54	MEMORY_FILL	MF	Modifies the content of a memory area by specifying data
55	MEMORY_FIND	MI	Searches for data within the memory range
56	MEMORY_MOVE	MV	Moves a block of memory
57	MEMORY_TEST	MT	Tests a block of memory
58	MODE	MO	Sets or displays the CPU mode
59	MODULES	MU	Sets up or displays the on-chip peripheral functions
60	MONITOR_CLEAR	MOC	Deletes a monitor point
61	MONITOR_DISPLAY	MOD	Displays the content of the monitor
62	MONITOR_REFRESH	MOR	Controls an automatic update of the content of the monitor
63	MONITOR_SET	MOS	Sets or displays a monitor point
64	OPEN_WORKSPACE	OW	Opens a workspace
65	QUIT	QU	Exits HEW
66	RADIX	RA	Sets default input radix
67	REFRESH	RF	Updates windows related to memory
68	REGISTER_DISPLAY	RD	Displays CPU register values
69	REGISTER_SET	RS	Sets CPU register contents

Table H.1 HEW Commands (cont)

No.	Command Name	Abbreviation	Function
70	RESET	RE	Resets CPU
71	REMOVE_FILE	REM	Deletes the specified file from the current project
72	SLEEP	-	Delays command execution
73	SAVE_SESSION	SE	Saves the session of the current project
74	STEP	ST	Steps program (by instructions or source lines)
75	STEP_MODE	SM	Sets the step mode
76	STEP_OUT	SP	Steps out of the current function
77	STEP_OVER	SO	Steps program, not stepping into functions
78	STEP_RATE	SR	Sets or displays rate of stepping
79	SUBMIT	SU	Executes a command file
80	SYMBOL_ADD	SA	Defines a symbol
81	SYMBOL_CLEAR	SC	Deletes a symbol
82	SYMBOL_LOAD	SL	Loads a symbol information file
83	SYMBOL_SAVE	SS	Saves a symbol information file
84	SYMBOL_VIEW	SV	Displays symbols
85	TCL	-	Enables or disables the TCL
86	TIMER	TI	Sets or displays the timer resolution
87	TOOL_INFORMATION	TO	The information on the tool registered is outputted by the file
88	TRACE	TR	Displays trace information
89	TRACE_ACQUISITION	TA	Sets or displays trace acquisition parameters
90	TRACE_BINARY_COMPARE	TBC	Compares a trace binary file with the current trace information
91	TRACE_BINARY_SAVE	TBV	Outputs trace information into a binary file
92	TRACE_FILTER	TF	Filter the trace information
93	TRACE_STATISTIC	TST	Analyzes statistic information
94	TRIGGER_CLEAR	TGC	Deletes the trigger output condition for EXT.2
95	TRIGGER_DISPLAY	TGD	Displays the trigger output condition for EXT.2
96	TRIGGER_SET	TGS	Sets the trigger output condition for EXT.2
97	UPDATE_ALL_DEPENDENCIES	UD	Updates the dependencies for the current project
98	USER_SIGNALS	US	Enables or disables the user signal information

For the syntax of each command, refer to the online help.

Appendix I Diagnostic Test Procedure

This section describes the diagnostic test procedure using the E6000 test program.

I.1 System Set-Up for Test Program Execution

To execute the test program, use the following hardware; do not connect the user system interface cable and user system.

- E6000 emulator (HS3160EPI60H)
 - Host computer
 - The E6000 PC interface board (Select one interface board or card from the following depending on the PC interface specifications.):
 - ISA bus interface board (HS6000EII01H)
1. Install the E6000 PC interface board in the host computer and connect the supplied PC interface cable to the board.
 2. Connect the PC interface cable to the emulator.
 3. Connect the supplied AC adapter to the emulator.
 4. Initiate the host computer to make it enter DOS prompt command input wait state.
 5. Turn on the emulator power switch.

I.2 Diagnostic Test Procedure Using Test Program

Insert the CD-R (HS3160EPI60SR supplied with the emulator) into the CD-ROM drive of the host computer, move the current directory to <Drive>\Diag with a command prompt, and enter one of the following commands according to the PC interface board used to initiate the test program:

```
> TM3160 (RET)
```

The HEW must be installed before the test program is executed.

Be sure to initiate the test program from <Drive>\Diag. Do not initiate it from a directory other than <Drive>\Diag, such as > <Drive>\Diag\TM3160 (RET). If the test program is initiated when the current directory is not <Drive>\Diag, the test program will not operate correctly.

When -S is added to the command line such as >TM3160 -S (RET), steps 1 to 21 will be repeatedly executed. To stop the execution, enter Q.

- Notes:
1. <Drive> is a drive name for the CD-ROM drive.
 2. Do not remove the CD-R from the CD-ROM drive during test program execution.

The following messages are displayed during test. This test consists of steps 1 to 21.

Message	Description
E6000 H8/3160 EMULATION BOARD Tests Vx.x	Test program start message. Vx.x shows the version number.
Searching for interface cardOK, card at H'd0000000	Shows that the PC interface board is correctly installed in the host computer and displays the address assigned to the board. The displayed address depends on the settings.
Checking emulator is connectedOK	Shows that the E6000 emulator is correctly connected to the host computer.
Emulator Board Information: Main Board ID H' 1	Shows the ID number of the lower board of the E6000 emulator (always 1).
Emulation Board ID H' c	Shows the ID number of the upper board of the E6000 emulator (always c).
Revision H' x	Shows the revision number of the upper board of the E6000 emulator.
SIMM No SIMM module inserted	Shows the size of the emulation memory installed in the E6000 emulator.
Downloading firmware	Loading the test program.
01) Testing Register :	Shows the check results for the registers in the E6000 emulator (normal completion).
Emulation Board IDH'c	
BOC control registerOK	
MODER registerOK	
EEMAX registerOK	
CES GA registerOK	
02) Testing Dual-Port RAM :	Shows the results of decoding test and marching test for the dual-port RAM in the E6000 emulator (normal completion).
Decode TestOK	
Marching TestOK	

03) Testing Firmware RAM :		Shows the results of
Decode Test. page range H'700 - H'70f	OK	decoding test for the
		firmware RAM in the E6000
		(normal completion).
Marching Test. page range H'700 - H'70f	OK	Shows the results of
		marching test for the
		firmware RAM in the E6000
		(normal completion).
04) Testing Trace RAM :		Shows the results of
Decode Test. page range H'000 - H'04f	OK	decoding test for the trace
		RAM in the E6000 (normal
		completion).
Marching Test. page range H'000 - H'04f	OK	Shows the results of
		marching test for the trace
		RAM in the E6000 (normal
		completion).
05) Testing Mapping RAM :		Shows the results of
Decode Test. page range H'200 - H'21f	OK	decoding test for the
		mapping RAM in the E6000
		(normal completion).
Marching Test. page range H'200 - H'21f	OK	Shows the results of
		marching test for the
		mapping RAM in the E6000
		(normal completion).
06) Testing Coverage RAM :		Shows the results of decoding
Decode Test. Page range H'400 - H'41f ...	OK	test for the coverage RAM in
		the E6000 emulator (normal
		completion).
07) Testing PERF GA :		Shows the check results for
PERF GA register	OK	execution time measurment
		controlling circuits in the
		E6000 emulator (normal
		completion).
08) Testing Emulation RAM :		Shows the results of
Normal Window:Decode Test	OK	decoding and marching test
		for the emulation RAM in the
Normal Window:Marching Test	OK	E6000 emulator (normal
		completion).
09) Testing STEP Operation :		Shows the check results for
Step Operation	OK	the step execution
		controlling circuits in the
		E6000 emulator (normal
		completion).
10) Testing Key Break :		Shows the check results for
Key Break	OK	the forced break controlling
		circuits in the E6000
		emulator (normal completion).

- | | |
|---|--|
| <p>11) Testing Emulation RAM Hardware Break :</p> <p>GRD BreakOK</p> <p>WPT BreakOK</p> | <p>Shows the check results for the illegal access break controlling circuits in the E6000 emulator (normal completion).</p> |
| <p>12) Testing Internal ROM :</p> <p>Write-Protect Test.....OK</p> <p>ROM Bank0 Test</p> <p>Normal Window:Decode TestOK</p> <p>Normal Window:Marching TestOK</p> <p>ROM Bank1 Test</p> <p>Normal Window:Decode TestOK</p> <p>Normal Window:Marching TestOK</p> <p>ROM Bank alternation TestOK</p> <p>ROM Bank function Test.....OK</p> <p>Register TestOK</p> | <p>Shows the check results for internal ROM controlling circuits in the E6000 emulator (normal completion).</p> |
| <p>13) Testing EEPROM :</p> <p>A) EEPROM TEST 1OK</p> <p>B) EEPROM TEST 2OK</p> <p>C) EEPROM TEST 3OK</p> <p>D) EEPROM DELETE TESTOK</p> <p>E) RESERVED</p> <p>F) EEPROM PROTECT TESTOK</p> <p>G) EEMAX TEST 1OK</p> <p>H) EEMAX TEST 2OK</p> <p>I) EEMOV ON EEPROM TESTOK</p> <p>J) EEPMOV TIME MEASUREMENT TEST.....OK</p> | <p>Shows the check results for writing to EEPROM / delete and time , EEMAX Break write-protect controlling circuits in the E6000 emulator (normal completion).</p> |
| <p>14) Testing Mapping :</p> <p>A) ACCESS ERROR TESTOK</p> <p>B) WRITE PROTECT ERROR TESTOK</p> <p>C) ROM WRITE PROTECT ERROR TESTOK</p> | <p>Shows the results of decoding test for the mapping RAM in the E6000 emulator (normal completion).</p> |
| <p>15) Testing Trace :</p> <p>Free Trace TestOK</p> <p>Range Trace TestOK</p> <p>Point to Point Trace TestOK</p> <p>Start and Stop Event Trace TestOK</p> | <p>Shows the check results for the trace controlling circuits in the E6000 emulator (normal completion).</p> |
| <p>16) Testing Hardware Break :</p> <p>A)Break Point IntialisedOK</p> <p>B)Event Detectors CES channel 1-12OK</p> <p>C)CES Event Sequencing TestOK</p> <p>D)Range Break Point TestOK</p> <p>E)Range Break Point Test for DATAOK</p> <p>F)Compare break either TestOK</p> | <p>Shows the check results for hardware break controlling circuits in the E6000 emulator (normal completion).</p> |
| <p>17) Testing PC_CVR :</p> <p>A)ALL Coverage TestOK</p> <p>B)Area Coverage Test 1OK</p> <p>C)Area Coverage Test 2OK</p> | <p>Shows the check results for hardware break controlling circuits in the E6000 emulator (normal completion).</p> |
| <p>18) Testing PERM_GA :</p> <p>A)Time Measure TestOK</p> <p>B)PERM_POINT TO POINT Time Measure TestOK</p> <p>C)PERM_SUBROUTINE Time Measure TestOK</p> <p>D)PERM Time Out Bit Test</p> <p>Time Out Test 1.....OK</p> <p>Time Out Test 2.....OK</p> | <p>Shows the check results for execution time measurment controlling circuits in the E6000 emulator (normal completion).</p> |

- | | |
|--|--|
| <p>19) Testing Double Stack,I/O Stack :</p> <p>A) Double Stack TestOK</p> <p>B) I/O Stack Test 1OK</p> <p>C) I/O Stack Test 2OK</p> <p>D) I/O Stack Test 3OK</p> <p>20) Testing Emulation RAM Time Measurement:</p> <p>Testing Internal Clock = 9.8304MHzOK</p> <p>Testing Internal Clock = 7.1424MHzOK</p> <p>Testing Internal Clock = 4.9152MHzOK</p> <p>Testing Internal Clock = 3.5712MHzOK</p> <p>21) Testing Emulation Monitor :</p> <p>A) A15 to A0 (MONIT00, MONIT1E, MONIT1O)OK</p> <p>B) INST bit (MONIT20:D1).....OK</p> <p>C) ASE STATUS BIT (MONIT2E:D7-D4)OK</p> <p>D) HLT BIT (MONIT20:D6).....OK</p> <p>E) CNM BIT (MONIT2E:D1).....OK</p> <p>F) ASE BRKACK BIT (MONIT20:D0).....OK</p> <p>G) EVAGDD BIT (MONIT20:D5).....OK</p> | <p>Shows the check results for Double Stack,I/O Stack controlling circuits in the E6000 emulator (normal completion).</p> <p>Shows the check results for execution time measurement circuits in the E6000 emulator (normal completion).</p> <p>Shows the check results for monitor controlling circuits in the E6000 emulator (normal completion).</p> |
|--|--|

**Renesas Microcomputer Development Environment System
User's Manual
H8/3160 E6000 Emulator**

Publication Date: Rev.1.00, October 21, 2005
Published by: Sales Strategic Planning Div.
Renesas Technology Corp.
Edited by: Customer Support Department
Global Strategic Communication Div.
Renesas Solutions Corp.

Renesas Technology Corp. Sales Strategic Planning Div. Nippon Bldg., 2-6-2, Ohte-machi, Chiyoda-ku, Tokyo 100-0004, Japan



RENESAS SALES OFFICES

<http://www.renesas.com>

Refer to "<http://www.renesas.com/en/network>" for the latest and detailed information.

Renesas Technology America, Inc.
450 Holger Way, San Jose, CA 95134-1368, U.S.A
Tel: <1> (408) 382-7500, Fax: <1> (408) 382-7501

Renesas Technology Europe Limited
Dukes Meadow, Millboard Road, Bourne End, Buckinghamshire, SL8 5FH, United Kingdom
Tel: <44> (1628) 585-100, Fax: <44> (1628) 585-900

Renesas Technology (Shanghai) Co., Ltd.
Unit2607 Ruijing Building, No.205 Maoming Road (S), Shanghai 200020, China
Tel: <86> (21) 6472-1001, Fax: <86> (21) 6415-2952

Renesas Technology Hong Kong Ltd.
7th Floor, North Tower, World Finance Centre, Harbour City, 1 Canton Road, Tsimshatsui, Kowloon, Hong Kong
Tel: <852> 2265-6688, Fax: <852> 2730-6071

Renesas Technology Taiwan Co., Ltd.
10th Floor, No.99, Fushing North Road, Taipei, Taiwan
Tel: <886> (2) 2715-2888, Fax: <886> (2) 2713-2999

Renesas Technology Singapore Pte. Ltd.
1 Harbour Front Avenue, #06-10, Keppel Bay Tower, Singapore 098632
Tel: <65> 6213-0200, Fax: <65> 6278-8001

Renesas Technology Korea Co., Ltd.
Kukje Center Bldg, 18th Fl., 191, 2-ka, Hangang-ro, Yongsan-ku, Seoul 140-702, Korea
Tel: <82> 2-796-3115, Fax: <82> 2-796-2145

Renesas Technology Malaysia Sdn. Bhd.
Unit 906, Block B, Menara Amcorp, Amcorp Trade Centre, No.18, Jalan Persiaran Barat, 46050 Petaling Jaya, Selangor Darul Ehsan, Malaysia
Tel: <603> 7955-9390, Fax: <603> 7955-9510



H8/3160 E6000 Emulator User's Manual



Renesas Electronics Corporation

1753, Shimonumabe, Nakahara-ku, Kawasaki-shi, Kanagawa 211-8668 Japan

REJ10B0217-0100