

To our customers,

Old Company Name in Catalogs and Other Documents

On April 1st, 2010, NEC Electronics Corporation merged with Renesas Technology Corporation, and Renesas Electronics Corporation took over all the business of both companies. Therefore, although the old company name remains in this document, it is a valid Renesas Electronics document. We appreciate your understanding.

Renesas Electronics website: <http://www.renesas.com>

April 1st, 2010
Renesas Electronics Corporation

Issued by: Renesas Electronics Corporation (<http://www.renesas.com>)

Send any inquiries to <http://www.renesas.com/inquiry>.

Notice

1. All information included in this document is current as of the date this document is issued. Such information, however, is subject to change without any prior notice. Before purchasing or using any Renesas Electronics products listed herein, please confirm the latest product information with a Renesas Electronics sales office. Also, please pay regular and careful attention to additional and different information to be disclosed by Renesas Electronics such as that disclosed through our website.
2. Renesas Electronics does not assume any liability for infringement of patents, copyrights, or other intellectual property rights of third parties by or arising from the use of Renesas Electronics products or technical information described in this document. No license, express, implied or otherwise, is granted hereby under any patents, copyrights or other intellectual property rights of Renesas Electronics or others.
3. You should not alter, modify, copy, or otherwise misappropriate any Renesas Electronics product, whether in whole or in part.
4. Descriptions of circuits, software and other related information in this document are provided only to illustrate the operation of semiconductor products and application examples. You are fully responsible for the incorporation of these circuits, software, and information in the design of your equipment. Renesas Electronics assumes no responsibility for any losses incurred by you or third parties arising from the use of these circuits, software, or information.
5. When exporting the products or technology described in this document, you should comply with the applicable export control laws and regulations and follow the procedures required by such laws and regulations. You should not use Renesas Electronics products or the technology described in this document for any purpose relating to military applications or use by the military, including but not limited to the development of weapons of mass destruction. Renesas Electronics products and technology may not be used for or incorporated into any products or systems whose manufacture, use, or sale is prohibited under any applicable domestic or foreign laws or regulations.
6. Renesas Electronics has used reasonable care in preparing the information included in this document, but Renesas Electronics does not warrant that such information is error free. Renesas Electronics assumes no liability whatsoever for any damages incurred by you resulting from errors in or omissions from the information included herein.
7. Renesas Electronics products are classified according to the following three quality grades: “Standard”, “High Quality”, and “Specific”. The recommended applications for each Renesas Electronics product depends on the product’s quality grade, as indicated below. You must check the quality grade of each Renesas Electronics product before using it in a particular application. You may not use any Renesas Electronics product for any application categorized as “Specific” without the prior written consent of Renesas Electronics. Further, you may not use any Renesas Electronics product for any application for which it is not intended without the prior written consent of Renesas Electronics. Renesas Electronics shall not be in any way liable for any damages or losses incurred by you or third parties arising from the use of any Renesas Electronics product for an application categorized as “Specific” or for which the product is not intended where you have failed to obtain the prior written consent of Renesas Electronics. The quality grade of each Renesas Electronics product is “Standard” unless otherwise expressly specified in a Renesas Electronics data sheets or data books, etc.
 - “Standard”: Computers; office equipment; communications equipment; test and measurement equipment; audio and visual equipment; home electronic appliances; machine tools; personal electronic equipment; and industrial robots.
 - “High Quality”: Transportation equipment (automobiles, trains, ships, etc.); traffic control systems; anti-disaster systems; anti-crime systems; safety equipment; and medical equipment not specifically designed for life support.
 - “Specific”: Aircraft; aerospace equipment; submersible repeaters; nuclear reactor control systems; medical equipment or systems for life support (e.g. artificial life support devices or systems), surgical implantations, or healthcare intervention (e.g. excision, etc.), and any other applications or purposes that pose a direct threat to human life.
8. You should use the Renesas Electronics products described in this document within the range specified by Renesas Electronics, especially with respect to the maximum rating, operating supply voltage range, movement power voltage range, heat radiation characteristics, installation and other product characteristics. Renesas Electronics shall have no liability for malfunctions or damages arising out of the use of Renesas Electronics products beyond such specified ranges.
9. Although Renesas Electronics endeavors to improve the quality and reliability of its products, semiconductor products have specific characteristics such as the occurrence of failure at a certain rate and malfunctions under certain use conditions. Further, Renesas Electronics products are not subject to radiation resistance design. Please be sure to implement safety measures to guard them against the possibility of physical injury, and injury or damage caused by fire in the event of the failure of a Renesas Electronics product, such as safety design for hardware and software including but not limited to redundancy, fire control and malfunction prevention, appropriate treatment for aging degradation or any other appropriate measures. Because the evaluation of microcomputer software alone is very difficult, please evaluate the safety of the final products or system manufactured by you.
10. Please contact a Renesas Electronics sales office for details as to environmental matters such as the environmental compatibility of each Renesas Electronics product. Please use Renesas Electronics products in compliance with all applicable laws and regulations that regulate the inclusion or use of controlled substances, including without limitation, the EU RoHS Directive. Renesas Electronics assumes no liability for damages or losses occurring as a result of your noncompliance with applicable laws and regulations.
11. This document may not be reproduced or duplicated, in any form, in whole or in part, without prior written consent of Renesas Electronics.
12. Please contact a Renesas Electronics sales office if you have any questions regarding the information contained in this document or Renesas Electronics products, or if you have any other inquiries.

(Note 1) “Renesas Electronics” as used in this document means Renesas Electronics Corporation and also includes its majority-owned subsidiaries.

(Note 2) “Renesas Electronics product(s)” means any product developed or manufactured by or for Renesas Electronics.

User's Manual

F_Line – Drive it!

Demonstration Kit for the F_Line Family

- The information in this document is current as of 18.01.2005. The information is subject to change without notice. For actual design-in, refer to the latest publications of NEC Electronics data sheets or data books, etc., for the most up-to-date specifications of NEC Electronics products. Not all products and/or types are available in every country. Please check with an NEC sales representative for availability and additional information.
- No part of this document may be copied or reproduced in any form or by any means without prior written consent of NEC Electronics. NEC Electronics assumes no responsibility for any errors that may appear in this document.
- NEC Electronics does not assume any liability for infringement of patents, copyrights or other intellectual property rights of third parties by or arising from the use of NEC Electronics products listed in this document or any other liability arising from the use of such NEC Electronics products. No license, express, implied or otherwise, is granted under any patents, copyrights or other intellectual property rights of NEC Electronics or others.
- Descriptions of circuits, software and other related information in this document are provided for illustrative purposes in semiconductor product operation and application examples. The incorporation of these circuits, software and information in the design of customer's equipment shall be done under the full responsibility of customer. NEC Electronics no responsibility for any losses incurred by customers or third parties arising from the use of these circuits, software and information.
- While NEC Electronics endeavors to enhance the quality, reliability and safety of NEC Electronics products, customers agree and acknowledge that the possibility of defects thereof cannot be eliminated entirely. To minimize risks of damage to property or injury (including death) to persons arising from defects in NEC Electronics products, customers must incorporate sufficient safety measures in their design, such as redundancy, fire-containment and anti-failure features.
- NEC Electronics products are classified into the following three quality grades: "Standard", "Special" and "Specific".

The "Specific" quality grade applies only to NEC Electronics products developed based on a customer-designated "quality assurance program" for a specific application. The recommended applications of NEC Electronics product depend on its quality grade, as indicated below. Customers must check the quality grade of each NEC Electronics product before using it in a particular application.

- "Standard": Computers, office equipment, communications equipment, test and measurement equipment, audio and visual equipment, home electronic appliances, machine tools, personal electronic equipment and industrial robots.
- "Special": Transportation equipment (automobiles, trains, ships, etc.), traffic control systems, anti-disaster systems, anti-crime systems, safety equipment and medical equipment (not specifically designed for life support).
- "Specific": Aircraft, aerospace equipment, submersible repeaters, nuclear reactor control systems, life support systems and medical equipment for life support, etc.

The quality grade of NEC Electronics products is "Standard" unless otherwise expressly specified in NEC Electronics data sheets or data books, etc. If customers wish to use NEC Electronics products in applications not intended by NEC Electronics, they must contact NEC Electronics sales representative in advance to determine NEC Electronics 's willingness to support a given application.

- Notes: 1. " NEC Electronics" as used in this statement means NEC Electronics Corporation and also includes its majority-owned subsidiaries.
 2. " NEC Electronics products" means any product developed or manufactured by or for NEC Electronics (as defined above).



F_Line - Drive it! complies with the EMC protection requirements

CAUTION

This equipment should be handled like a CMOS semiconductor device. The user must take all precautions to avoid build-up of static electricity while working with this equipment. All test and measurement tool including the workbench must be grounded. The user/operator must be grounded using the wrist strap. The connectors and/or device pins should not be touched with bare hands.

EEDT-ST-004-10

Revision History

Date	Revision	Chapter	Description
30.01.04	V1.00	---	First release
18.01.05	V1.01	---	Update

Table of Contents

1. Introduction	8
1.1 Main features of <i>F_Line – Drive it!</i>	8
1.2 System requirements	9
1.3 Package contents	9
2. <i>F_Line - Drive it!</i> system configuration.....	10
2.1 <i>F_Line - Drive it!</i>	10
2.2 Host computer.....	10
2.3 Battery power supply.....	10
3. <i>F_Line - Drive it!</i> Baseboard components.....	11
3.1 Start button SW1	11
3.2 User button SW2	11
3.3 User button SW3	11
3.4 LIN Plug JP1	11
3.5 Jumper JP2.....	11
3.6 RS232 serial interface connector CN3.....	12
3.7 High Speed CAN connector CN5.....	12
3.8 Connector CN1 and CN2.....	12
3.9 Connector CN4	12
3.10 External Potentiometer R14	12
3.11 AD converter reference voltage input	13
3.12 Supply voltage monitor.....	13
3.13 External LED1 – LED9	13
4. <i>F_Line - Drive it!</i> CPU module components	14
4.1 External connector CN3,CN4, CN5, and CN6.....	14
4.2 N-Wire On-Chip Debug Unit.....	15
5. <i>F_Line - Drive it!</i> installation and operation	16
5.1 Getting started.....	16
5.1.1 CD-ROM contents	16
5.1.2 Hardware installation	16
5.1.3 Software installation	16
5.1.3.1 IAR Systems Embedded Workbench for V850 installation	17
5.1.3.2 Communication interface installation	17
5.1.3.3 Sample program installation	17
5.1.3.4 FPL FLASH programmer software installation	17
5.2 Download monitor resources	17

6. F_Line - Drive it! communication interface	18
6.1 Settings menu	18
6.1.1 Ports.....	19
6.1.2 Connect.....	19
6.2 File menu	19
6.2.1 Download	20
6.2.2 Exit.....	20
6.3 Help menu.....	20
6.3.1 About menu.....	21
6.4 Questions and Messages.....	21
6.4.1 Questions to confirm a selected action	21
6.4.2 Informational Messages.....	21
6.4.3 Fatal Error Messages.....	21
6.4.4 RS232 Connection Error Messages	22
6.4.5 Download and File Handling Error Messages.....	22
6.4.6 NECCOM.DLL Error Messages.....	22
7. Sample programs	23
7.1 General Introduction	23
7.2 Common description of all sample programs	25
7.3 Electronic dice.....	26
7.4 Lightshow.....	27
7.5 Reaction time measurement	28
7.6 Entrance code checker	30
7.7 Count down timer.....	32
7.8 Melody maker	34
7.9 CAN Example.....	35
8. Connectors and Cables	36
8.1 Serial host connector.....	36
9. Schematics	37

List of Figures

Figure 1: *F_Line - Drive it!* system configuration 10
 Figure 2: *F_Line - Drive it!* baseboard jumpers, connectors, switches and LEDs 11
 Figure 3: *F_Line - Drive it!* CPU module components 14
 Figure 4: *N-Wire Connection Circuit Example* 15
 Figure 5: Driveit_GUI startup screen 18
 Figure 6: Settings menu 18
 Figure 7: Communication Settings dialogue..... 19
 Figure 8: Well-established communication message for *F_Line* CPU module..... 19
 Figure 9: File menu 19
 Figure 10: Select download file dialogue 20
 Figure 11: Help menu..... 20
 Figure 12: About box 21
 Figure 13: IAR Systems Embedded Workbench V850 24
 Figure 14: IAR System V850 C-Spy Simulator..... 24
 Figure 15: Target cable 2 36
 Figure 16: Serial host connector 36
 Figure 17: *F_Line - Drive it!* baseboard schematics..... 37

List of Tables

Table 1: CN3 connection to RS232..... 12
 Table 2: LED1 – LED9 connection..... 13
 Table 3: Signal pins for On-Chip Debug Unit 15
 Table 4: *F_Line - Drive it!* CD-ROM directory structure 16
 Table 5: Shadow interrupt vector table 17
 Table 6: User confirmation messages..... 21
 Table 7: User confirmation messages..... 21
 Table 8: Fatal error messages 21
 Table 9: RS232 connection error messages 22
 Table 10: Download an file handling error messages 22
 Table 11: NECCOM.DLL error message 22
 Table 12: Example directory structure 23

1. Introduction

F_Line – Drive it! is a battery powered demonstration kit for the NEC's microcontroller family. It supports download and real time execution of small application programs up to 4 KBytes of program code for the V850 CPU module. The board is prepared to be connected to user hardware parts such as digital I/O or analogue signals.

1.1 Main features of *F_Line – Drive it!*

- Easy to use device demonstration capabilities
F_Line - Drive it! contains elements to easily demonstrate simple I/O-functions, i.e. push buttons, LED output, AD reference voltage, I/O lines, RS232, LIN and CAN serial interfaces.
- Battery powered
F_Line - Drive it! is battery powered for portability reasons.
- Serial communication interface program
A Windows based download GUI allows to select and download application programs to *F_Line - Drive it!* for evaluation purposes.
- Analogue to digital signal conversion is supported
- Various input / output signals available, such as
 - All I/O ports
 - Timer input / output signals
 - Two or three wire serial I/O
 - RS232 signals including RTS / CTS
 - LIN bus support with transceiver TJA 1020
 - High Speed CAN bus interface with transceiver TJA 1040
 - 8 analogue input lines
 - 9 I/O ports connected to LED
 - 2 push buttons prepared for external interrupt generation
- Embedded Workbench for V850 and C-Spy Simulator / Debugger are included. These packages are restricted in such that maximum program code size is limited to 4 KB of program code.
- Full documentation is included for the NEC V850ES/FE2, NEC V850ES/FJ2, IAR Systems Embedded Workbenches, IAR Systems C-Spy and NEC FPL FLASH programmer software.

<p><i>F_Line - Drive it!</i> is not intended for code development. NEC does not allow and does not support in any way any attempt to use <i>F_Line - Drive it!</i> in a commercial or technical product.</p>

1.2 System requirements

HOST PC	<p>A PC supporting Windows 95, Windows 98, Windows NT, Windows 2000 or Windows XP is required for the IAR Systems Workbench.</p> <p>Pentium 166 MHz (at least), 64 MB of RAM, 256-color display (1024 * 768), mouse, CD-ROM drive and 40 Mbytes of free hard disk space are required to install the tool packages.</p> <p>Above listed requirements are valid if the IAR Systems Embedded Workbench shall be installed. The communication interface program does not need to be installed to the local hard disk. It can be started from the CDROM.</p>
Host interface	<p>Serial (RS232C) interface capable to handle communication at 9600 baud.</p>

1.3 Package contents

Please verify that you have received all parts listed in the package contents list, document "README.pdf" in the documentation directory of the CD of your *F_Line - Drive it!* package. If any part is missing or seems to be damaged, please contact the dealer from whom you received your *F_Line - Drive it!*.

Note: Updates to this User Manual, additional documentation and/or utilities for *F_Line - Drive it!*, if available, may be downloaded from the NEC WEB page(s) at <http://www.ee.nec.de/updates>.

2. F_Line - Drive it! system configuration

The *F_Line - Drive it!* system configuration is given in the diagram below.

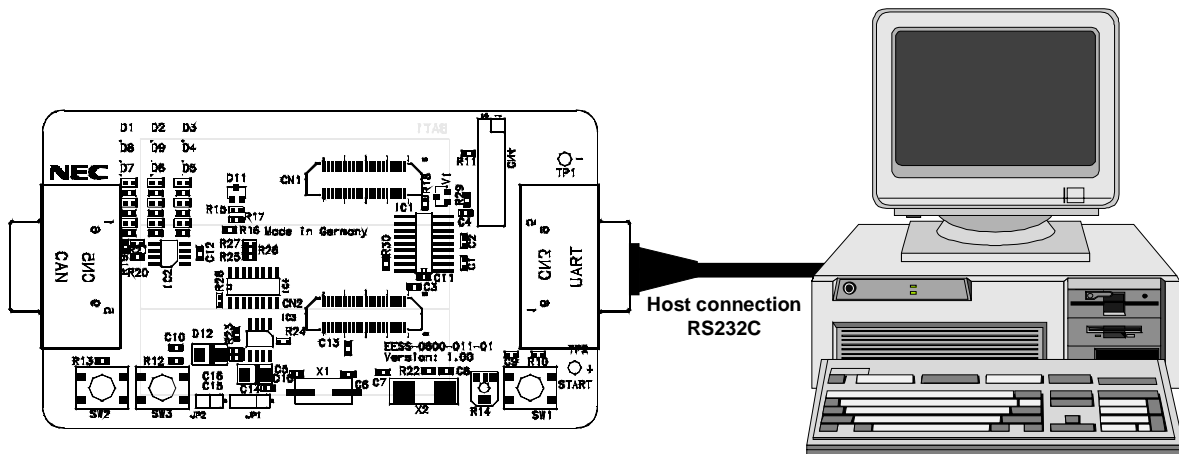

Figure 1: *F_Line - Drive it!* system configuration

2.1 F_Line - Drive it!

F_Line - Drive it! is a demonstration kit for the NEC *F_Line* family devices. Two CPU modules are included that represent the smallest and largest device of the *F_Line* with V850ES core. The demonstration kit is equipped with a serial interface and a small monitor program to accept download program files for program execution. For optimized support a CAN and LIN interface is equipped on the board.

The *F_Line - Drive it!* board is connected to the host system via RS232C serial interface cable. The host system may be used to download and start application programs on *F_Line - Drive it!* platform. *F_Line - Drive it!* uses for both CPU modules a 5.0 MHz crystal so that programs can run on the internal PLL frequency of up to 20MHz. Sub-clock is provided with 32.768 kHz.

2.2 Host computer

The RS232C host interface enables communication to the *F_Line - Drive it!*. RS232C data transfer speed must be set to 9600 bps.

For a detailed specification of the host interface please refer to the chapter "Connectors and Cables" of this document.

2.3 Battery power supply

The *F_Line - Drive it!* is equipped with three batteries of AA type.

Before using *F_Line - Drive it!* please remove the isolation strip inserted between the battery and the battery holder.

Please note that a battery voltage below 3V may cause malfunction of the serial interface driver.

Note: The built-in monitor program switches *F_Line - Drive it!* to a power saving STOP mode in case serial communication is not established within ten minutes after power on. Press the START button to switch *F_Line - Drive it!* back to operation mode.

3. F_Line - Drive it! Baseboard components

The F_Line - Drive it! baseboard is equipped with push buttons, LEDs and with several connectors in order to be connected to host computers, Flash-programmer, LIN and High Speed CAN busses.

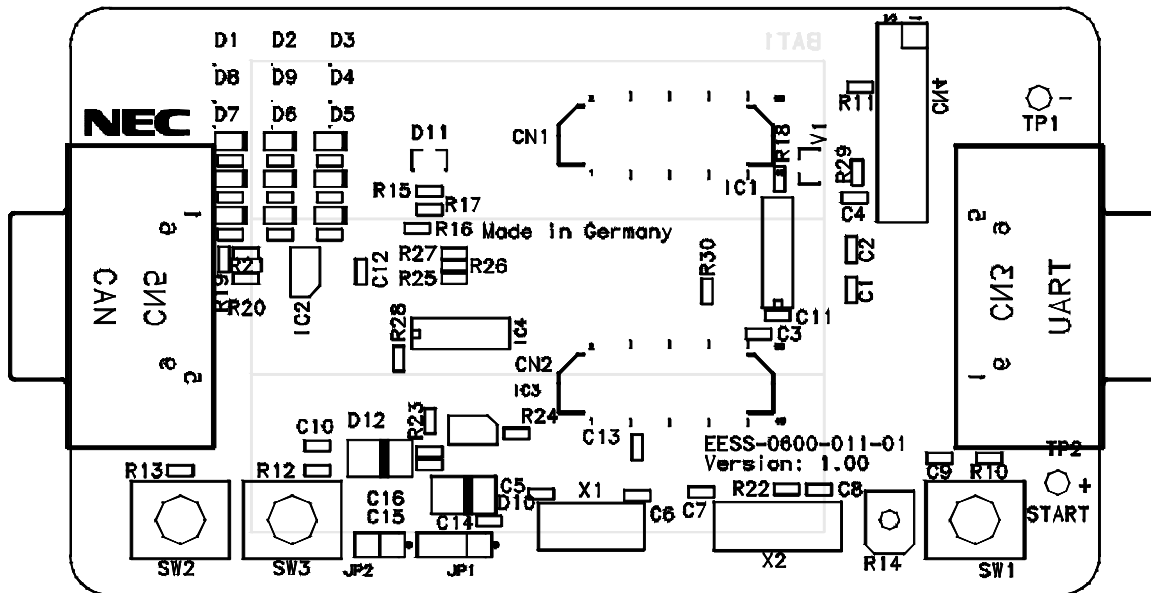

Figure 2: F_Line - Drive it! baseboard jumpers, connectors, switches and LEDs

Some of the F_Line - Drive it! components are free for user application hardware and software. Please read the user's manual of the V850ES/Fx2-device carefully to get information about the electrical specification of the available I/O ports before you connect any external signal to the F_Line - Drive it! board!

3.1 Start button SW1

SW1 is a reset button. It activates the power on reset. It is connected to the reset input of the CPU module.

3.2 User button SW2

SW2 is a push button connecting VCC to external interrupt input INTP1 of port P04 of the CPU module. The port may be programmed to generate interrupt INTP1. The necessary initialisation for this purpose is described in the user's manual of the V850ES/Fx2-device. The port is connected to a 1.2K pull down resistor.

3.3 User button SW3

SW3 is a push button connecting VCC to external interrupt input INTP3 of the CPU module. This is port P06 of the V850ES CPU module. The port may be programmed to generate interrupt INTP3. The necessary initialisation for this purpose is described in the user's manual of the V850ES/Fx2-device. The port is connected to a 1.2K pull down resistor.

3.4 LIN Plug JP1

JP1 is a 3 pin connector for the LIN bus, connected to the transceiver TJA1020.

JP1	PIN	Description
1	BAT	Reference voltage for the LIN bus level
2	LIN	LIN bus line
3	GND	Ground

The LIN transmitter can be switched off by output a low level to the port P00

3.5 Jumper JP2

JP2 is a mode selector that enables to program application programs via FPL FLASH programmer GUI into the CPU internal flash memory of the connected CPU module. It will take effect only after RESET release provoked e.g. by pressing SW1.

Closing the jumper JP2 will enable the programming interface and connect the RS232 serial interface at the 9pin female Sub-D connector CN3 via a multiplexer to the UARTA0 of the V850/Fx2 CPU module. A user program is not able to run with closed jumper JP2 and the LIN bus should not be connected in this mode, because the LIN and the FPL FLASH programmer use same UARTA0, so that they effect each other.

The FPL FLASH programmer software a separate product from NEC and is included in this package.

3.6 RS232 serial interface connector CN3

RS232 interface lines on the 9pin female Sub-D connector CN3 are connected via a driver MAX3222 and a multiplexer to the V850ES/Fx2-device. For the monitor program the control lines RTS and CTS are connected as well.

CN3	JP2 = open (monitor)	JP2 = closed (FPL FLASH programmer)	RS232
1	--	--	NC
2	RXDA1	RXDA0	RxD
3	TXDA1	TXDA0	TxD
4	--	--	NC
5	--	--	Ground
6	--	--	NC
7	P97	P97	CTS
8	P96	Logic 1	RTS
9	--	--	NC

Table 1: CN3 connection to RS232

For program download serial communication speed is fixed to 9600 baud. Data format is 8 data bits, 1 stop bit, no parity.

If the serial interface is used from a downloaded application program, any other communication speed or data format may be used according to the V850ES/Fx2 capabilities. Please refer to the user's manuals for details.

Note:

P99 output signal may be used to shut down the MAX3222 serial line driver. It is recommended to shut down the MAX3222 driver if the serial interface is not used. This will extend the battery life time.

A low signal output at P99 will shut down the MAX3222. A high signal will wake up MAX3222. P98 at V850ES/Fx2 output signal must be set to low signal to enable MAX3222.

3.7 High Speed CAN connector CN5

CN5 is a D-SUB 9 connector for High Speed CAN with CiA standard pin assignment. The used transceiver is the TJA1040 with bus termination. The transceiver is connected to the CAN0 of the V850/Fx2, whereby the standby mode control is selected by port P35.

3.8 Connector CN1 and CN2

CN1 and CN2 are connectors for the CPU module.

3.9 Connector CN4

CN4 connector allows connecting the PG-FP4 flash programmer to F_Line - Drive *it!* in order to program application programs into the CPU internal flash memory of the connected CPU module. Programming via PG-FP4 flash programmer is more powerful than programming via the FPL FLASH programming GUI. Reprogramming the CPU modules will irretrievably overwrite the monitor program. PG-FP4 is a separate product from NEC and it is not included in this package.

3.10 External Potentiometer R14

A 10K potentiometer R1 is connected between P915 of V850ES/Fx2 and ground. The potentiometer arm is connected to ANI2 analogue input.

3.11 AD converter reference voltage input

A 1.235V reference voltage is connected to ANI0 input. The reference voltage must be enabled by port P913 of V850ES/Fx2.

3.12 Supply voltage monitor

For reference purposes $V_{CC} / 2$ is connected to ANI3 input. The supply voltage monitor must be enabled by port P914 of V850ES/Fx2.

3.13 External LED1 – LED9

LED9 to LED1 are LED connected to PDL of the V850/Fx2. LED9 is an LED connected to PCM0 of the V850/Fx2.

Port	Segment	Display	Port	Segment	Display
PDL0 V850ES/Fx2	LED1		PDL4 V850ES/Fx2	LED5	
PDL1 V850ES/Fx2	LED2		PDL5 V850ES/Fx2	LED6	
PDL2 V850ES/Fx2	LED3		PDL6 V850ES/Fx2	LED7	
PDL3 V850ES/Fx2	LED4		PDL7 V850ES/Fx2	LED8	
			PCM0 V850ES/Fx2	LED9	

Table 2: LED1 – LED9 connection

A low signal output at each port switches the corresponding LED on.

4. F_Line - Drive it! CPU module components

Both F_Line - Drive it! CPU modules are equipped with 4 connectors in order to be connected to user defined hardware. One module is the V850ES/FE2 CPU in a 64 pin package and the other is the V850ES/FJ2 CPU in a 144 pin package.

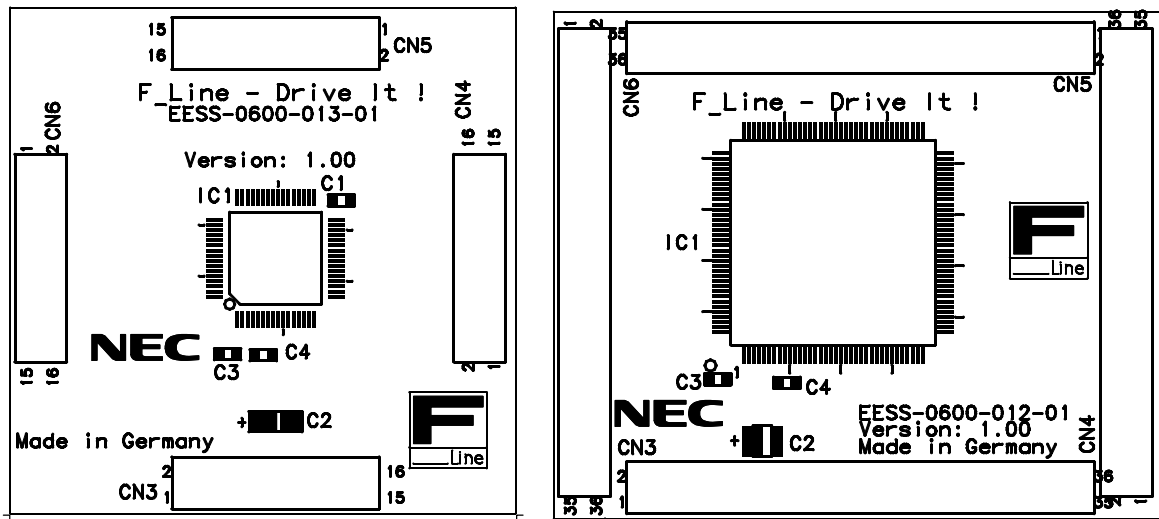

Figure 3: F_Line - Drive it! CPU module components

4.1 External connector CN3, CN4, CN5, and CN6

CN3, CN4, CN5, and CN6 are connectors for external user hardware. The pinning equals the pinning of the related device. Therefore each of the connectors CN3 to CN5 can be assembled with a 16 pin plug with a 2.54 mm pitch for the V850ES/FE2 and a 36 pin plug for the V850/FJ2 respectively. Please read the user's manual of the V850ES/Fx2-device carefully to get information about the electrical specification of the available I/O ports and check the connected signal on the base board before you connect any external signal to the F_Line - Drive it! board!

4.2 N-Wire On-Chip Debug Unit

The V850ES/FE2 and V850ES/FJ2 include an on-chip debug unit. By connecting an N-Wire emulator, on-chip debugging can be executed with the V850ES/Fx2. The interface signal pins that must be connected are located on the CN4 and CN5 connector of the V850ES/FE2 and on CN4 and CN5 of V850ES/FJ2 respectively. The interface signal pins are

Name	I/O	Function	FE2 pin	FJ2 pin
DCK	in	Clock input	34	41
DMS	in	Mode select input	35	42
DDI	in	Data input	30	39
DDO	out	Data output	31	40
DRST	in	On-chip debug unit reset input	17	20
FLMD0	in	Flash Programming Mode Setting	3	8
RESET	in	RESET	9	14

Table 3: Signal pins for On-Chip Debug Unit

(in and out indicates the direction when seen from the target device).

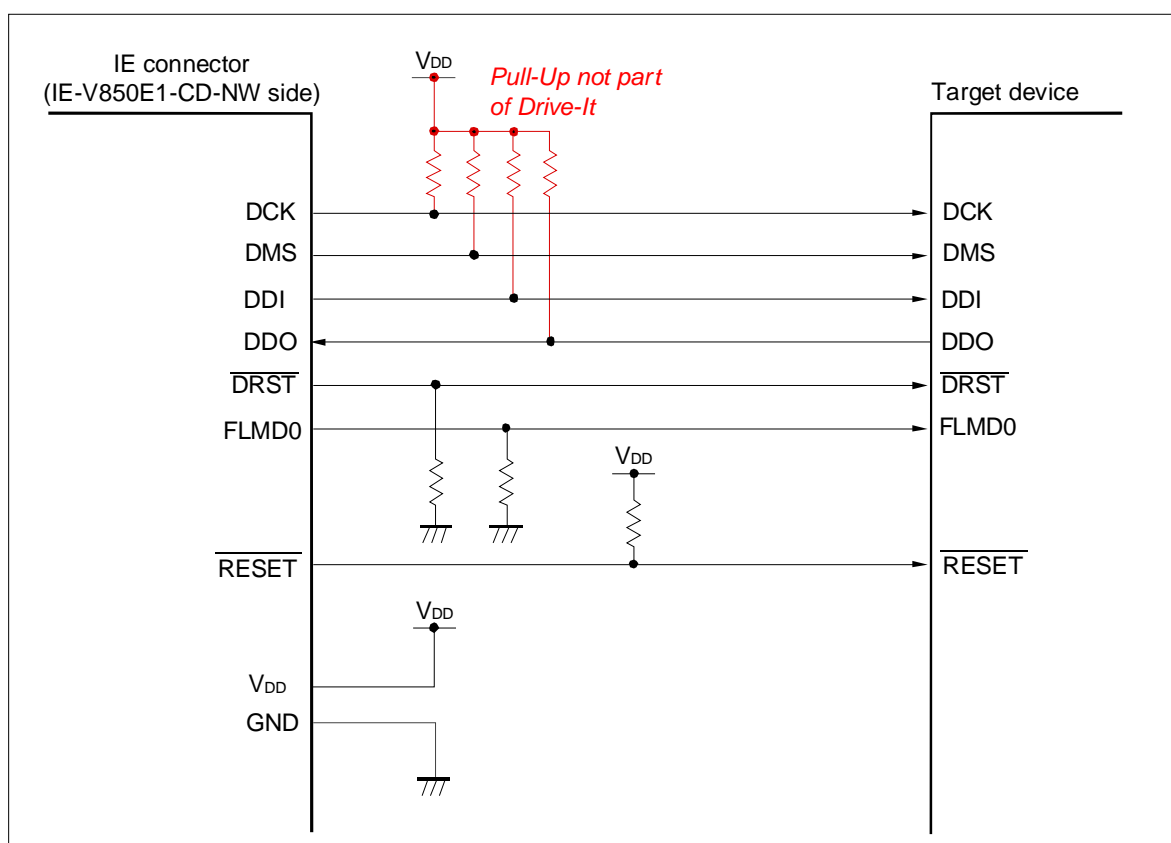

Figure 4: N-Wire Connection Circuit Example

For debugging please connect this signal pins to the connector of the N-Wire emulator. Refer to the user's manual of the emulator or to the user's manual of the V850ES/Fx2-device for more details. The CPU can be started in the debug mode immediately after reset of the CPU is released.

5. F_Line - Drive it! installation and operation

5.1 Getting started

F_Line - Drive it! is equipped with a simple download monitor that allows communication with a PC host system via RS232 serial interface line. Before you can run and download a program, hardware and software must be installed properly.

5.1.1 CD-ROM contents

The CD-ROM shows following directory structure:

	<table border="1"> <tr><td>CD-ROM ROOT</td></tr> <tr><td>Acrobat Reader</td></tr> <tr><td>IAR Embedded Workbench V850</td></tr> <tr><td>F_Line - Drive it!</td></tr> <tr><td>- Documentation</td></tr> <tr><td>- Download Monitor</td></tr> <tr><td>- Sample programs for ...</td></tr> <tr><td>... CAN communication</td></tr> <tr><td>... count down timer</td></tr> <tr><td>... electronic dice</td></tr> <tr><td>... entrance code checker</td></tr> <tr><td>... lightshow</td></tr> <tr><td>... melody maker</td></tr> <tr><td>... reaction time measurement</td></tr> <tr><td>FPL FLASH programmer software</td></tr> <tr><td>- Drivers for USB</td></tr> <tr><td>- FPL setup directory</td></tr> <tr><td>- PRM Parameter files</td></tr> </table>	CD-ROM ROOT	Acrobat Reader	IAR Embedded Workbench V850	F_Line - Drive it!	- Documentation	- Download Monitor	- Sample programs for CAN communication	... count down timer	... electronic dice	... entrance code checker	... lightshow	... melody maker	... reaction time measurement	FPL FLASH programmer software	- Drivers for USB	- FPL setup directory	- PRM Parameter files
CD-ROM ROOT																			
Acrobat Reader																			
IAR Embedded Workbench V850																			
F_Line - Drive it!																			
- Documentation																			
- Download Monitor																			
- Sample programs for ...																			
... CAN communication																			
... count down timer																			
... electronic dice																			
... entrance code checker																			
... lightshow																			
... melody maker																			
... reaction time measurement																			
FPL FLASH programmer software																			
- Drivers for USB																			
- FPL setup directory																			
- PRM Parameter files																			

Table 4: F_Line - Drive it! CD-ROM directory structure

5.1.2 Hardware installation

After unpacking *F_Line - Drive it!* please remove the battery isolation strip inserted between the battery and the power connection on the back side of *F_Line - Drive it!*.

After pressing the START button LED1 to LED8 will flash one after the other. If you press one of the buttons SW2 or SW3 the flashing speed will increase.

LED flashing indicates that *F_Line - Drive it!* is ready to be connected to a host computer.

Connect *F_Line - Drive it!* to your host computer using the provided serial interface cable. The communication speed is fixed to 9600 bps.

5.1.3 Software installation

The *F_Line - Drive it!* package comes with the several software demo packages:

- IAR Systems Embedded Workbench for V850, including C compiler, assembler, linker, librarian and C-SPY Simulator.
- Communication interface for program download
- Sample programs
- FPL FLASH programmer software for flash programming of the NEC V850ES/F_Line

The IAR Systems Embedded Workbench and FPL FLASH programmer must be installed on your PC. For detailed installation hints, refer to the documentation of the corresponding products.

The communication interface can be started from the CDROM without installation. Also sample programs can be downloaded and executed directly form the CDROM. Only if you intend to modify some of the sample programs it is necessary to copy them to your local hard disk.

5.1.3.1 IAR Systems Embedded Workbench for V850 installation

To install the IAR Systems Embedded Workbench for V850, select the SETUP program in the directory \EWV850-KS16-230A\EWV850\ of the CDROM. The setup dialogues will guide you through the installation process.

5.1.3.2 Communication interface installation

The communication interface program is available in the \F_Line-Drive it!\ directory of the CDROM. It does not require any installation. It can be started directly from the CDROM or it can be copied into any directory of your local hard disk. Please make sure that you copy both files, Driveit_GUI.exe and neccom.dll.

5.1.3.3 Sample program installation

The sample programs do not require any installation for download. If the sample programs shall be modified it is required to copy them into any directory of your local hard disk. A file copy using the Windows explorer is the recommended procedure.

5.1.3.4 FPL FLASH programmer software installation

The FPL FLASH programmer software must be installed. You may start the installation program from the auto-start program or by running the SETUP.EXE program available in the \FPL directory of the CDROM.

5.2 Download monitor resources

The ROM monitor program is contained in the internal flash area of the micro controller of the *F_Line - Drive it!*. It uses some resources for its own purposes. As soon as an application program starts execution, resources are returned to the system and all of them are available for user application programs. Despite of that, some features of the V850ES/F_Line micro controllers are not available to the user.

Resources not available to the user:

- The user application program cannot use the RESET vector.
- The internal expansion RAM cannot be used for data storage because the user application program will be downloaded into this memory area.

The user application program can use all interrupt functions (except RESET). The download monitor will redirect any interrupt to a shadow interrupt vector table. Depending on the used CPU module this shadow interrupt vector is starting according to the following table. The user must make sure that the interrupt vector table has been located from that address onwards for *F_Line - Drive it!*. For detailed explanation, please refer to the sample program descriptions.

CPU module	Start address
V850ES/F_Line	0x03FFD800

Table 5: Shadow interrupt vector table

6. F_Line - Drive it! communication interface

Driveit_GUI.exe is the communication interface for program download. It downloads user application programs to *F_Line - Drive it!* and starts them automatically.

Driveit_GUI.exe can be executed in Windows 9x, Windows NT, Windows 2000, Windows ME and Windows XP environment.

When Driveit_GUI starts, following screen will appear:



Figure 5: Driveit_GUI startup screen

Several actions may be initiated by menu selections from this communication interface.

6.1 Settings menu

The Settings menu allows selecting the communication port and establishing communication to the *F_Line - Drive it!* hardware.



Figure 6: Settings menu

6.1.1 Ports

When activating the Ports menu, a communication setting dialogue opens.

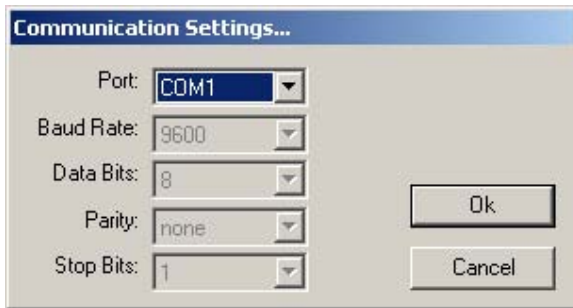

Figure 7: Communication Settings dialogue

In this dialogue, only the communication port can be selected. Other parameters are fixed.

6.1.2 Connect

When the Connect menu item is activated, communication to the *F_Line - Drive it!* will be established. Make sure that the *F_Line - Drive it!* is connected to the correct port of your PC before you activate this menu. On successful communication link, the main window will display a message depending on the used CPU module in its headline:

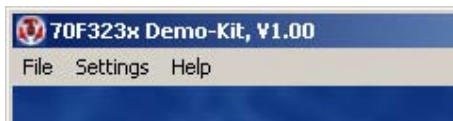

Figure 8: Well-established communication message for F_Line CPU module

On the *F_Line - Drive it!* the LED2, LED4, LED6 and LED8 will be switched on to indicate the connection status. In case an error occurs, an error message will be displayed. For details about the error messages please have a look at chapter 6.4.

6.2 File menu

The File menu allows selecting program files for download.



Figure 9: File menu

6.2.1 Download

When the Download menu is activated, a file open dialogue allows to select a HEX file for downloading to the *F_Line - Drive it!*

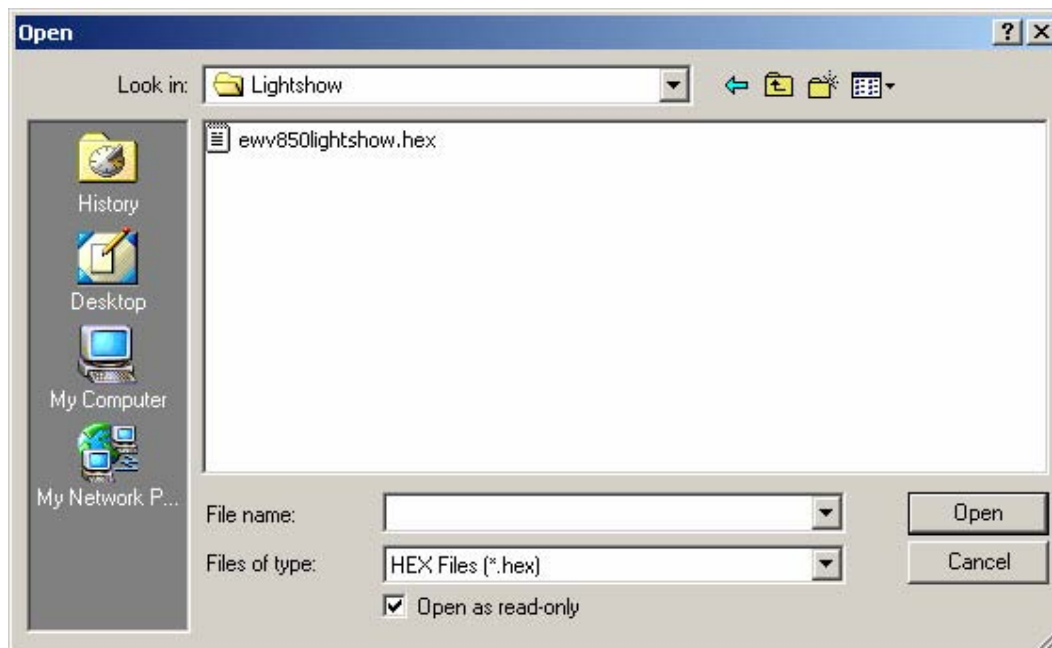

Figure 10: Select download file dialogue

Select the download file and activate OK. The selected file will be downloaded to *F_Line - Drive it!*. The *F_Line - Drive it!* will indicate the download activity by some flashing LED.

When the download is completed, a message box will indicate that the application program will start automatically. Please note that after program download the *F_Line - Drive it!* is disconnected automatically. Since the downloaded application program may use UART and other resources, communication interface program cannot communicate to *F_Line - Drive it!* any more. Therefore you have to d re-connect before downloading a new application. On the *F_Line - Drive it!* you have to press the reset-button SW1 to leave the application before re-connecting.

6.2.2 Exit

The Exit menu will leave the communication interface program.

6.3 Help menu

The Help menu allows selecting an About box. On-line help is not yet provided with this communication interface program.



Figure 11: Help menu

6.3.1 About menu

The About box shows the version number of the Driveit_GUI.exe communication interface program.

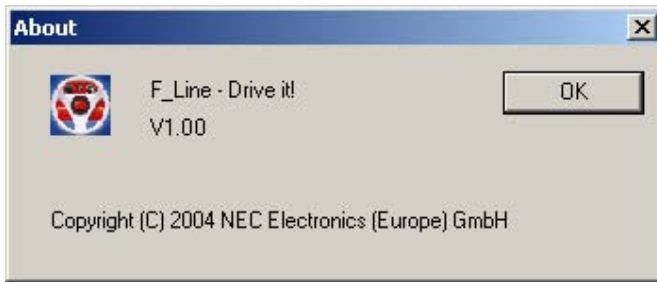

Figure 12: About box

6.4 Questions and Messages

During operation the following message boxes may occur informing the user or forcing a confirmation.

6.4.1 Questions to confirm a selected action

The user must confirm the following actions:

Selected action	Question	Possibilities
Exit while connected	Do you really want to disconnect and exit?	Yes / No
Exit while disconnected	Do you really want to exit?	Yes / No

Table 6: User confirmation messages

6.4.2 Informational Messages

The following messages inform the user about the current action or a currently restriction of the selected action:

Messages
Program downloading and executing...
Parameters cannot be changed while being connected to the target board!!
The target board has been disconnected. Press RESET button before re-connecting!

Table 7: User confirmation messages

6.4.3 Fatal Error Messages

If one of the following fatal errors occur, an error message is displayed and after the confirmation the program aborts:

Number	Message	Reason
E100	Error while loading neccom.dll. Application will be closed!	Tasteit_GUI could not find or load NECCOM.DLL.
E101	No RS232 communication interface detected. Application will be closed!	No valid RS232 communication port found on current PC.

Table 8: Fatal error messages

6.4.4 RS232 Connection Error Messages

Number	Message	Reason
E200	The target board does not answer! Press RESET button and try again!	There is no response coming from F_Line - Drive it! when sending a Connect command. Reasons could be <ul style="list-style-type: none"> no board connected board switched off board in run or connection mode wrong COM connection
E201	The target board returned an unknown or incomplete Board ID!	The information received on a Connect command cannot be evaluated. The data does not identify one of the allowed monitors. Please check board type, RS232 line and connection parameters.

Table 9: RS232 connection error messages

6.4.5 Download and File Handling Error Messages

In case of a download- or file handling error, the download aborts, but the *F_Line - Drive it!* stays in valid connection status. It is possible to select another download file.

Number	Message	Reason
E300	Cannot open download file.	The selected download file cannot be opened for reading. Error comes from OS.
E301	Error reading download file.	The download file cannot be read. Either EOF has been reached or file access problems have occurred. Error comes from OS.
E302	Mixed extended format (S).	The program download file in intel extended hex format contains a mixture of segmented and linear file format and is invalid.
E303	Mixed extended format (L).	The program download file in intel extended hex format contains a mixture of segmented and linear file format and is invalid.
E304	Invalid record in download file.	The program download file contains an invalid record identifier and is invalid.
E305	Incomplete line in download file.	The program download file contains less data than specified in the record header and is invalid.
E306	Address out of range.	The program download file contains address information exceeding the available ROM space in the target device.
E307	Invalid File Format	The program download file is not of intel hex file format.

Table 10: Download an file handling error messages

6.4.6 NECCOM.DLL Error Messages

A problem with the NEC communication DLL is shown by the following messages. No workaround is available.

Number	Message	Reason
E400	Connection failed!	Opening the communication channel failed.
E401	Disconnection failed!	Closing the communication channel failed.
E402	Illegal parameter selection!	Illegal communication parameters selected.

Table 11: NECCOM.DLL error message

7. Sample programs

7.1 General Introduction

Each of the sample programs is located in a single directory, which will be called main-directory of the sample. This main directory of each sample contains the complete project inclusive all output files of the development tools. All sample programs use the same directory structure:









 c-spy	File Folder	output files for C-Spy simulator (only V850/Fx2)
 inc	File Folder	C header files
 settings	File Folder	configuration files Embedded Workbench V850
 source	File Folder	C source files
 V850Modul	File Folder	output files for V850/Fx2 CPU module
 xcl	File Folder	xcl files
 description.txt	1 KB Text Document	example description
 ewv850timer.pew	8 KB IAR IDE Project	project file Embedded Workbench V850 V2.30a

Table 12: Example directory structure

The main directory contains only the project files for the IAR Systems Embedded Workbench V850 and a short description file.

All source files are located in the directory **source** and the **inc** directory contains the header files. Each sample project uses two targets. One target is the simulator (IAR Systems C-Spy) and the other is the demonstration kit hardware (with V850ES/Fx2 CPU module). All targets use the same source files, but they differ in the memory mapping. The different memory mapping is defined in the linker control files (*.xcl) which are located in the directory **xcl**.

The linker control file df3231.xcl define the ROM segments in the address area of the FLASH memory of the real device. This mapping must be used for the simulator. To download the sample program to the demonstration kit all ROM segments are defined in the address area of the internal RAM of the real device. This mapping is defined in the linker control file V850Modul.xcl for the V850/Fx2 CPU module.

All output files of the development tool are generated in the directory **c-spy** and **V850Module**.

To open the IAR Systems Embedded Workbench for a sample program please double-click on the corresponding project file in the main directory of the sample program. Due to a change in the project file format only an Embedded Workbench V850 version v2.30a or later can open the project files for V850ES/Fx2.

If you use an older version, a warning message appears. If you want to use a former Embedded Workbench version you have to create a new project file on your own, using the above description of the files and their location. Figures 20 and 21 on the next page show screenshots the IAR Systems Embedded Workbench.

For details of using Embedded Workbench and C-Spy Simulator please refer to the manuals.

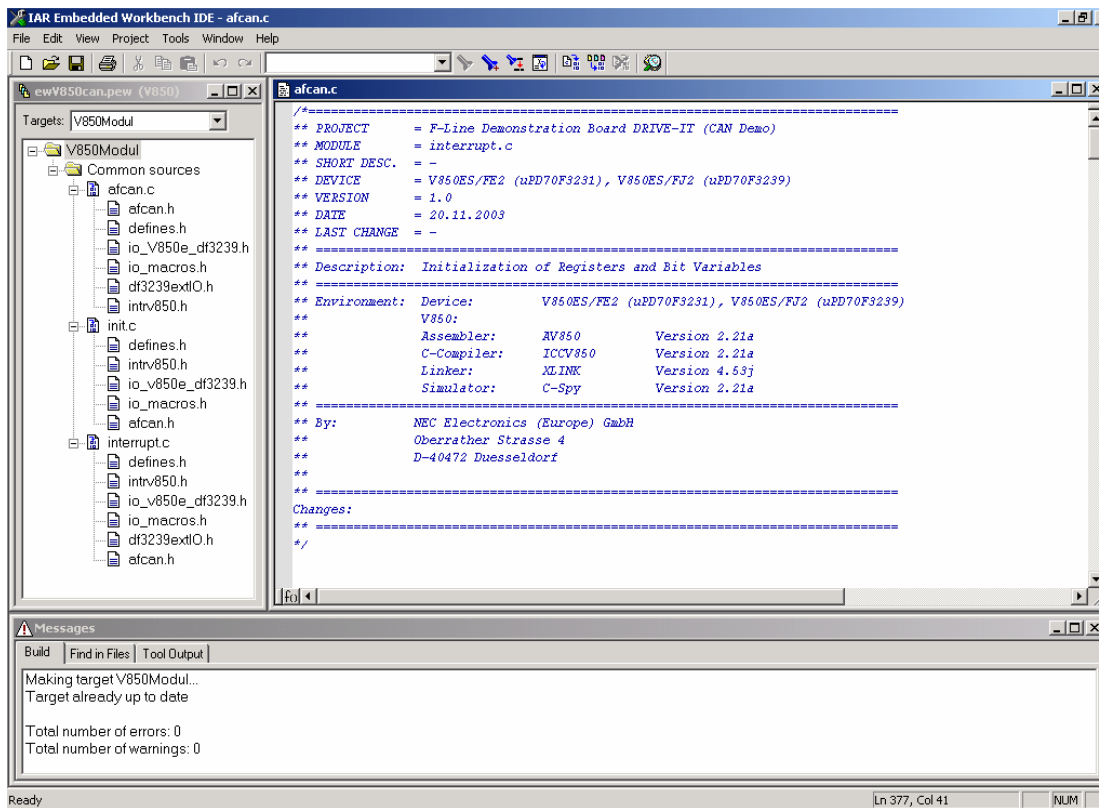

Figure 13: IAR Systems Embedded Workbench V850

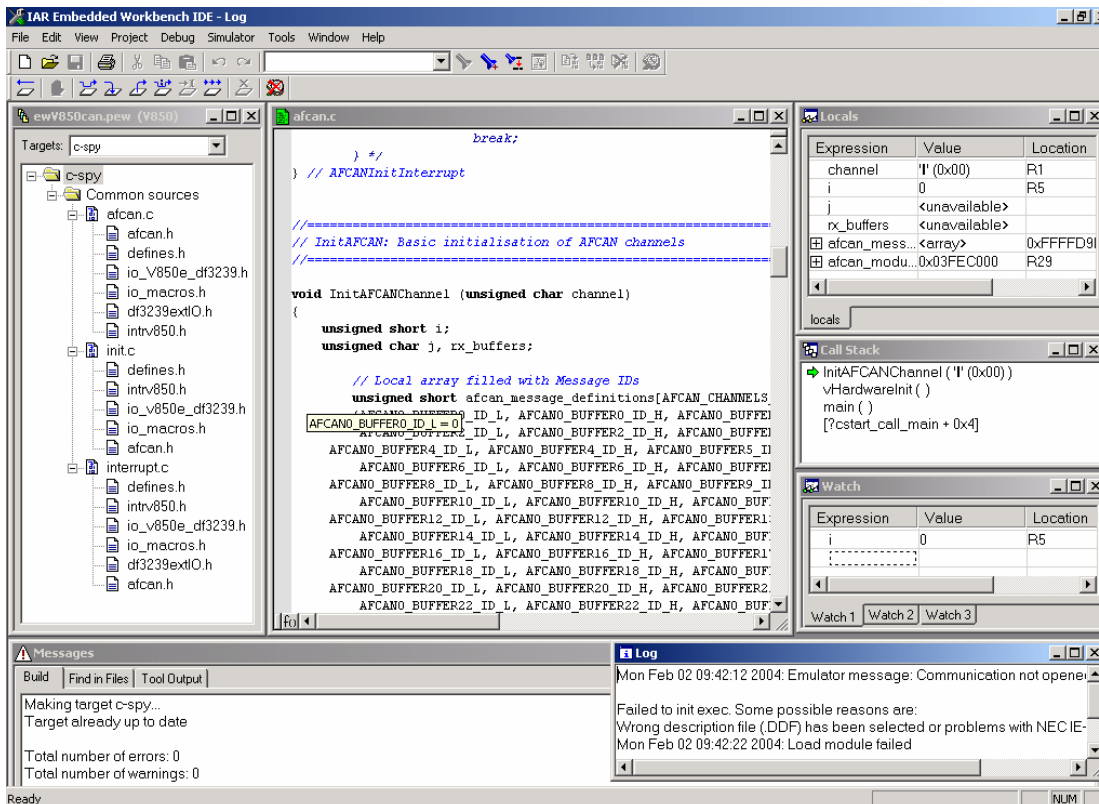

Figure 14: IAR System V850 C-Spy Simulator

7.2 Common description of all sample programs

As the demonstration kit hardware is powered by a battery some power saving features are implemented in all sample programs:

- Usage of a pulsed signal (100Hz) to control the LEDs instead of a static signal. The pulsed LED control is implemented as an interrupt function of Timer P0 (TMP0).
- All hardware components (RS232 driver, reference voltage, potentiometer, etc) are disabled if they aren't used in an application.
Therefore, if you write your own application be aware that the hardware you want to use is enabled.

To signal the program start after the download, all LEDs flash two times in a one-second interval.

Flowchart of the TMP0 interrupt function to generate the pulsed LED control:

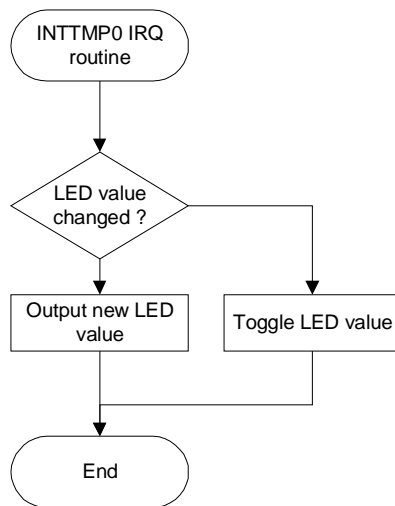

7.3 Electronic dice

This sample program simulates a dice. After the program-start-signal, the program waits for a press of button 3 (SW3). After an animation of a rolling dice a random number between one and six is generated and shown at the LEDs.

The ‘random’ number is generated by a transformation of the timer value of Timer P2 to a number between one and six. Timer P2 is working at 2.5 MHz using a compare value of 80 in the modus ‘clear and start on match between TMP2 and TP2CCR0’. The result is an interrupt repetition time of 31,25 KHz. Timer P1 is working in the same modus to generate a 25ms timebase.

Used Internal Peripherals	Used External Parts	Source Modules	
Timer P0 (TMP0)	LEDs	dice.c	main function
Timer P1 (TMP1)	Button3 (SW3)	init.c	Hardware and Bit initialization
Timer P2 (TMP2)		interrupt.c	interrupt functions

To end the program and return to the download program again please press the START button.

Flowcharts of the main routine and the interrupt functions:

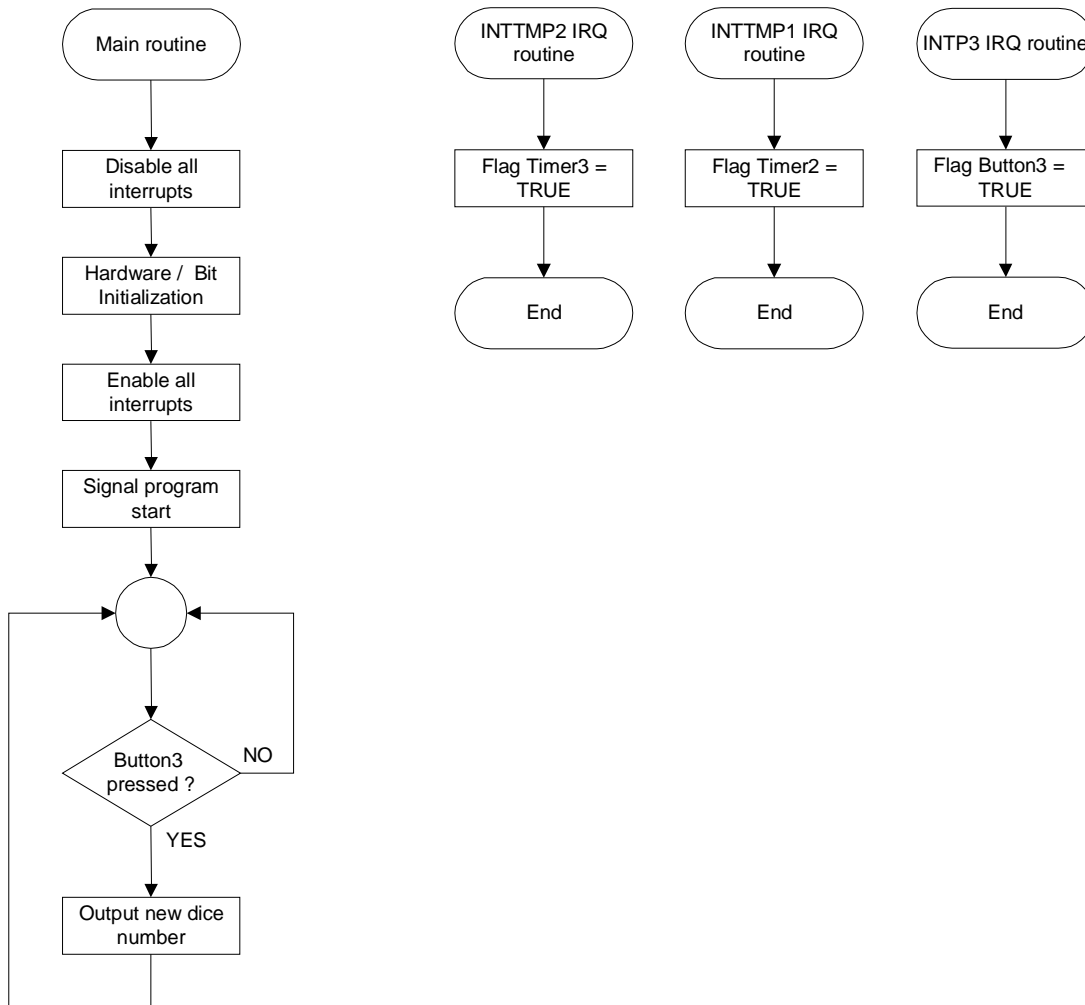

7.4 Lightshow

This sample programs plays one of three predefined lightshows. After the program-start-signal, the program plays the first lightshow. By pressing button3 (SW3) the next show is selected. Button2 (SW2) selects the previous show. Every show is completed before the next show starts.

Timer P1 (TMP1) is working in the modus 'clear and start on match between TMP1 and TP1CCR0'. According to selected operating frequency and the value of the compare register CCR0 Timer P2 generates a 25ms timebase.

Used Internal Peripherals	Used External Parts	Source Modules	
Timer P0 (TMP0)	LEDs	lightshow.c	Main function
Timer P1 (TMP1)	Button2	init.c	Hardware and bit initialization
	Button3	interrupt.c	Interrupt functions
		sequences.c	Lightshow sequence definitions

To end the program and return to the download program again please press the START button.

Flowcharts of the main routine and the interrupt functions:

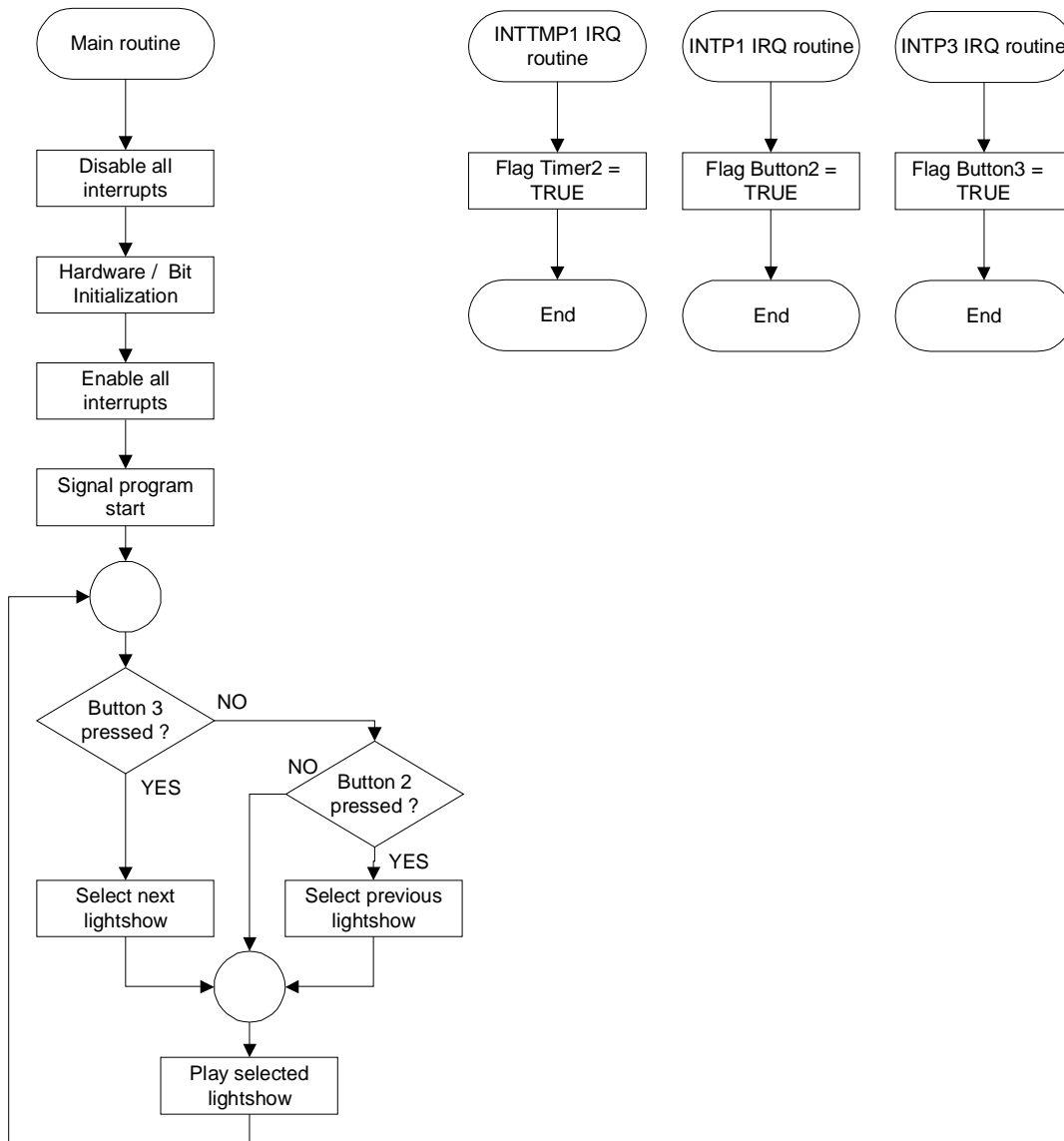

7.5 Reaction time measurement

This sample program demonstrates a reaction time measurement. After a press of button3 (SW3) the application waits for a random time between 0.50 and 3.45 seconds. Then the first LED is switched on and measurement starts. Until the next keystrokes of button3 every 50 ms a new LED is switched on. Pressing button2 (SW2) starts a new measuring cycle.

Timer P3 is working at 2.5 MHz using a compare value of 80 in the modus ‘clear and start on match between TMP2 and TP2CCR0’. The result is an interrupt repetition time of 31.25 kHz. Timer P2 is working in the same modus to generate a 25ms timebase.

Used Internal Peripherals	Used External Parts	Source Modules	
Timer P0 (TMP0)	LEDs	reactime.c	Main function
Timer P1 (TMP1)	Button2	init.c	Hardware and bit initialization
Timer P3 (TMP2)	Button3	interrupt.c	Interrupt functions

To end the program and return to the download program again please press the START button.

Flowcharts of the main routine and the interrupt functions:

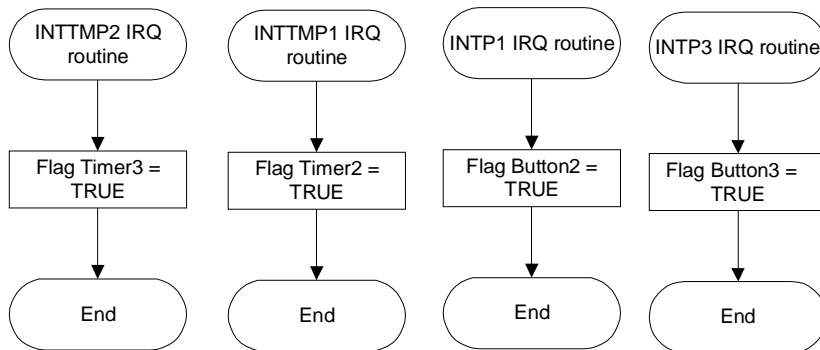

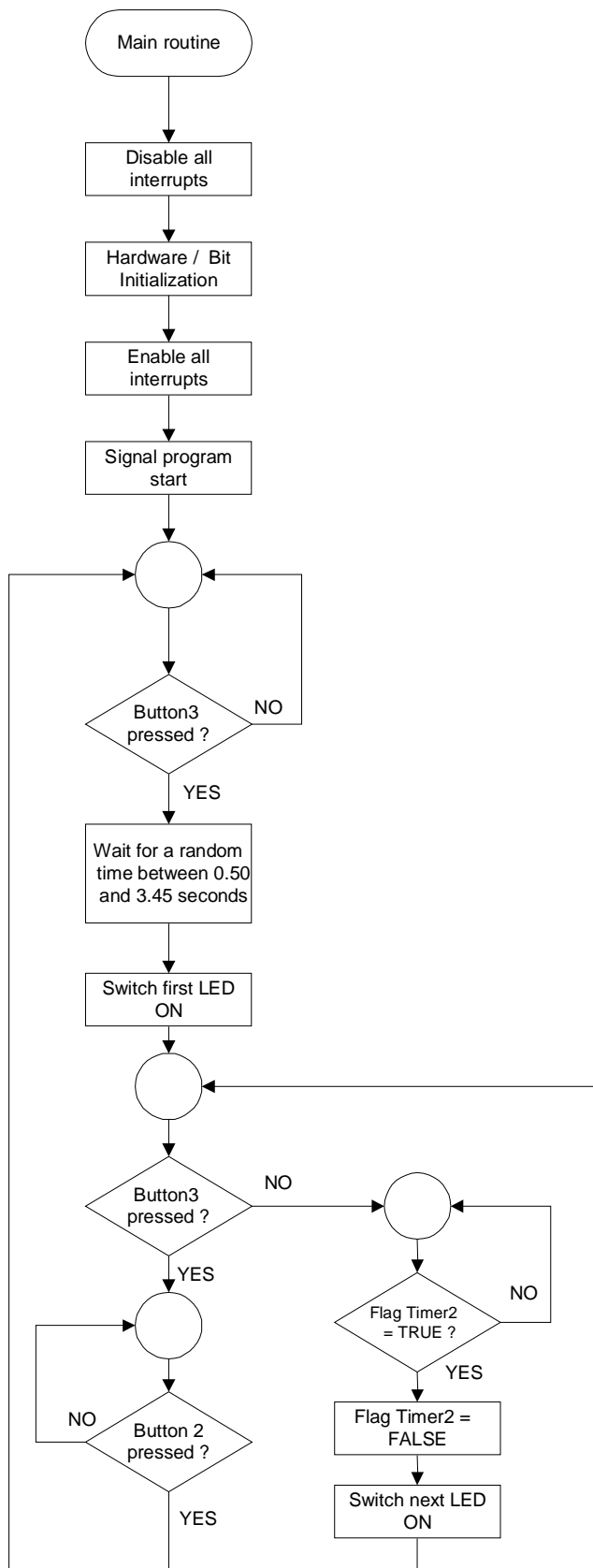

7.6 Entrance code checker

This sample program waits for a sequence of five keystrokes. If the input sequence matches the predefined sequence LED9 and one Port are switched on for 5 seconds. Otherwise, all LED flash five times.

Then the program waits for a new input sequence. The output port is P4.1.

The code sequence is stored in the array ucCode. The sequence is Button 3 (SW3) - Button 3 (SW3) – Button 2 (SW2) - Button 3 (SW3) – Button 2 (SW2). A flash of LED D9 signals an accepted key press.

Timer P1 (TMP1) is working in the modus 'clear and start on match between TMP1 and TP1CCR0'.

According to selected operating frequency and the value of the compare register TP1CCR0 TMP1 generates a 25ms timebase.

Used Internal Peripherals	Used External Parts	Source Modules	
Timer P0 (TMP0)	LEDs	codechk.c	Main function
Timer P1 (TMP1)	Button2 (SW2)	init.c	Hardware and bit initialization
	Button3 (SW3)	interrupt.c	interrupt functions

To end the program and return to the download program again please press the START button.

Flowcharts of the main routine and the interrupt functions:

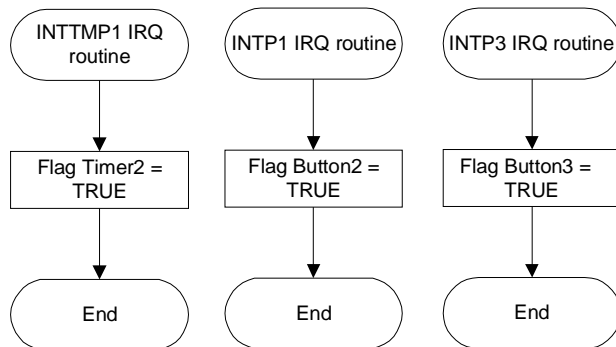

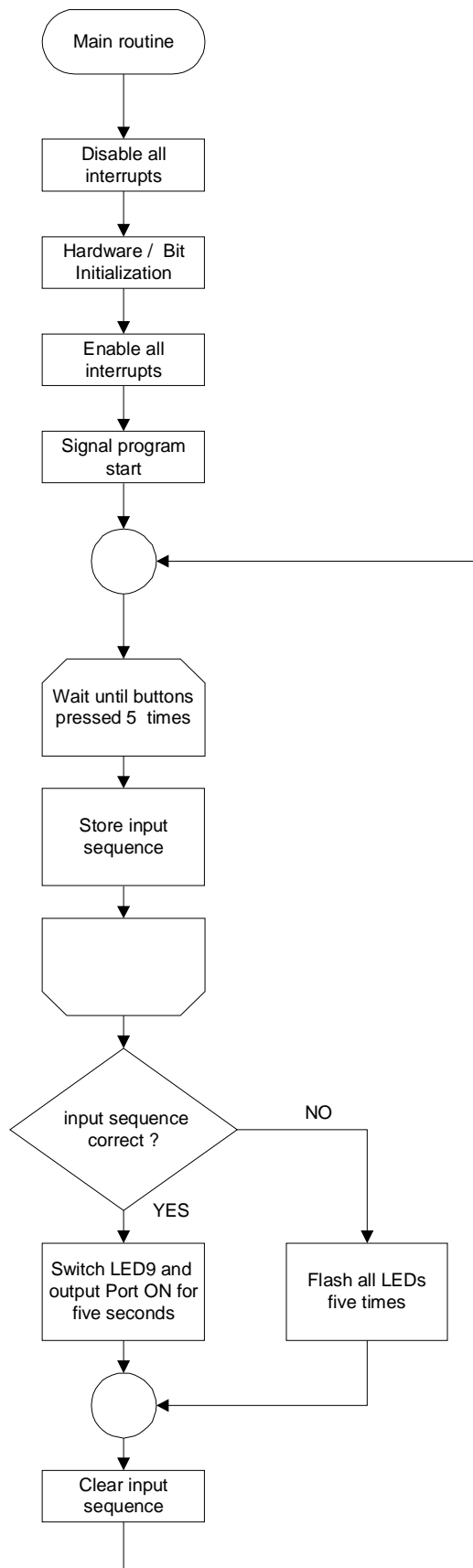

7.7 Count down timer

With this sample programs the board can be used as a count down timer. After the signal for program start the program waits for the input of the timer time, which can be set by button 3 (SW3). Each press increases the time by 60 seconds. The current time is shown by the LEDs in units of minutes. A press of button 2 (SW2) starts the timer, which is shown by a flashing LED D9.

After the selected time is finished, all LEDs flash for 3 minutes or a key press of the user. Then the program goes to stand by modus. A key press during countdown time or stand-by-modus sets the program to input mode again.

Timer P1 is working in the modus 'clear and start on match between Timer P1 (TMP1) and TP1CCR0'. According to selected operating frequency and the value of the compare register TP1CCR0 Timer P1 generates a 25ms timebase.

Used Internal Peripherals	Used External Parts	Source Modules	
Timer P0 (TMP0)	LEDs	timer.c	Main function
Timer P1 (TMP1)	Button 2 (SW2)	init.c	Hardware and bit initialization
	Button 3 (SW3)	interrupt.c	interrupt functions

To end the program and return to the download program again please press the START button.

Flowcharts of the main routine and the interrupt functions:

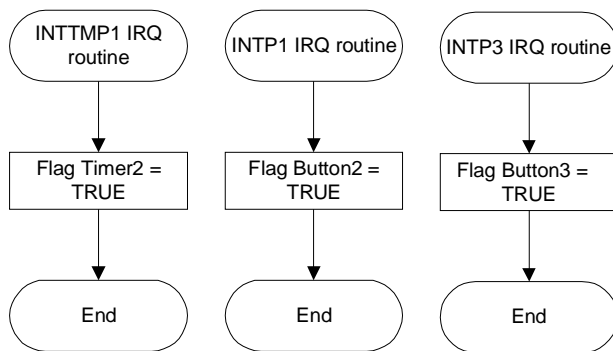

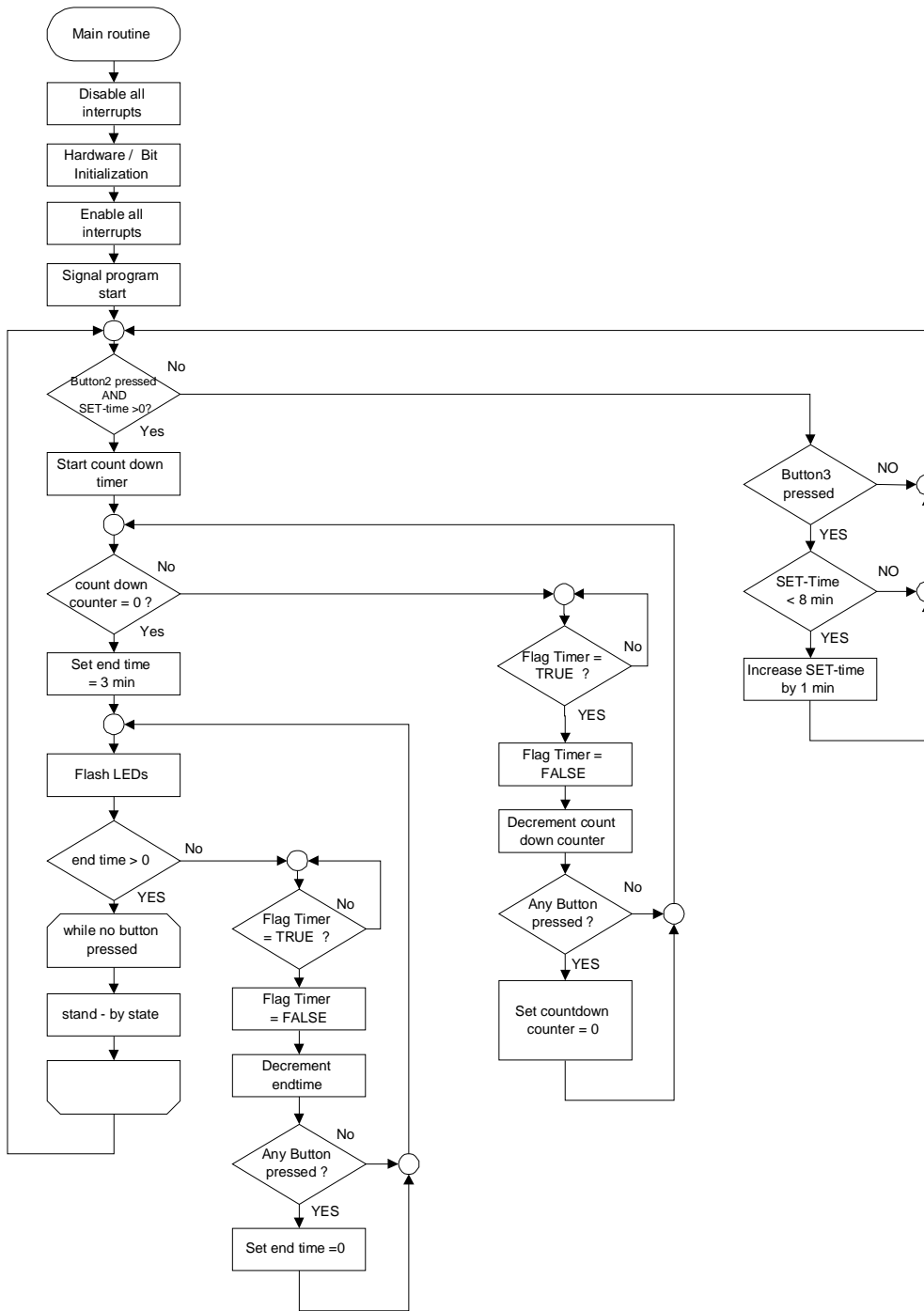

7.8 Melody maker

This sample programs plays one of eight predefined melodies using an external piezo buzzer. By pressing button3 (SW3) the next melody is selected. Button2 (SW2) selects the previous melody. Every melody is completed before the next melody starts.

Note: The external buzzer must not exceed the limit of 10 mA current consumption. It must be connected between the port pin P4.1 and V_{CC}.

Timer P1 (TMP1) is working in the modus 'clear and start on match between Timer P1 (TMP1) and TP1CCR0'. According to selected operating frequency and the value of the compare register CCR0 Timer P1 generates a 27.5ms timebase.

Used Internal Peripherals	Used External Parts	Source Modules	
Timer P0 (TMP0)	LEDs	melody.c	Main function
Timer P1 (TMP1)	Button2	init.c	Hardware and bit initialization
	Button3	interrupt.c	interrupt functions

To end the program and return to the download program again please press the START button.

Flowcharts of the main routine and the interrupt functions

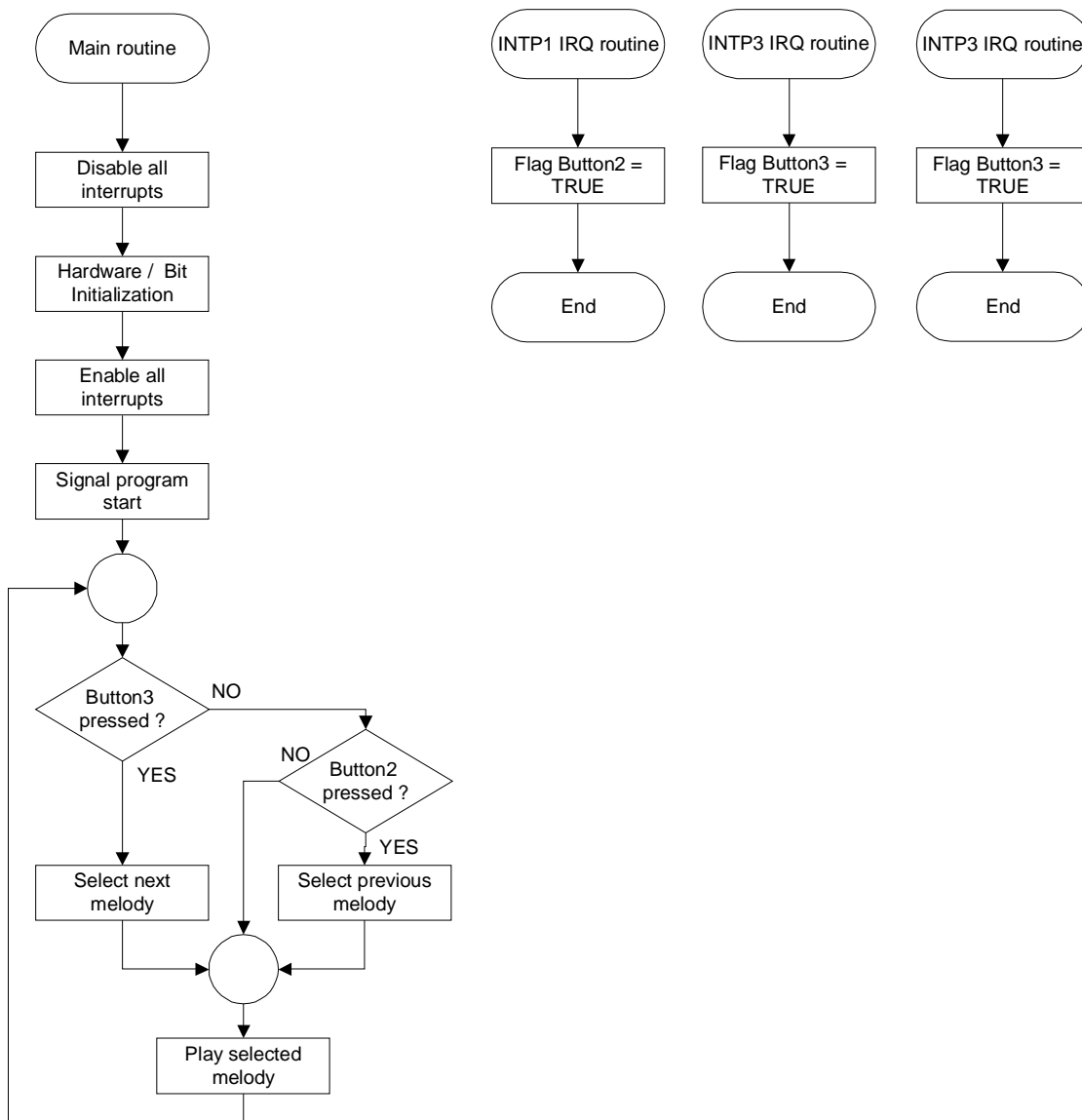

7.9 CAN Example

This sample programs sends a CAN frame and waits for another. It can be used together with another Drive it or together with the CANoe program supplied on the CD. After the program-start-signal, the program waits until Button3 is pressed. By pressing button3 a CAN message is sent. When this message is received by the remote node (e.g CANoe or another Drive it) this node sends a confirmation frame. When this confirmation message has been received by Drive it the LEDs will flash 5 times.

Timer01 is working in the modus 'clear and start on match between TM01 and CR001'. According to selected operating frequency and the value of the compare register CR001 Timer01 generates a 25ms timebase.

Used Internal Peripherals	Used External Parts	Source Modules	
TimerP00	LEDs	afcan.c	Main and afcan functions
AFCAN0	Button3	init.c	Hardware and bit initialization
		interrupt.c	Interrupt functions

To end the program and return to the download program again please press the START button.

Flowcharts of the main routine and the interrupt functions:

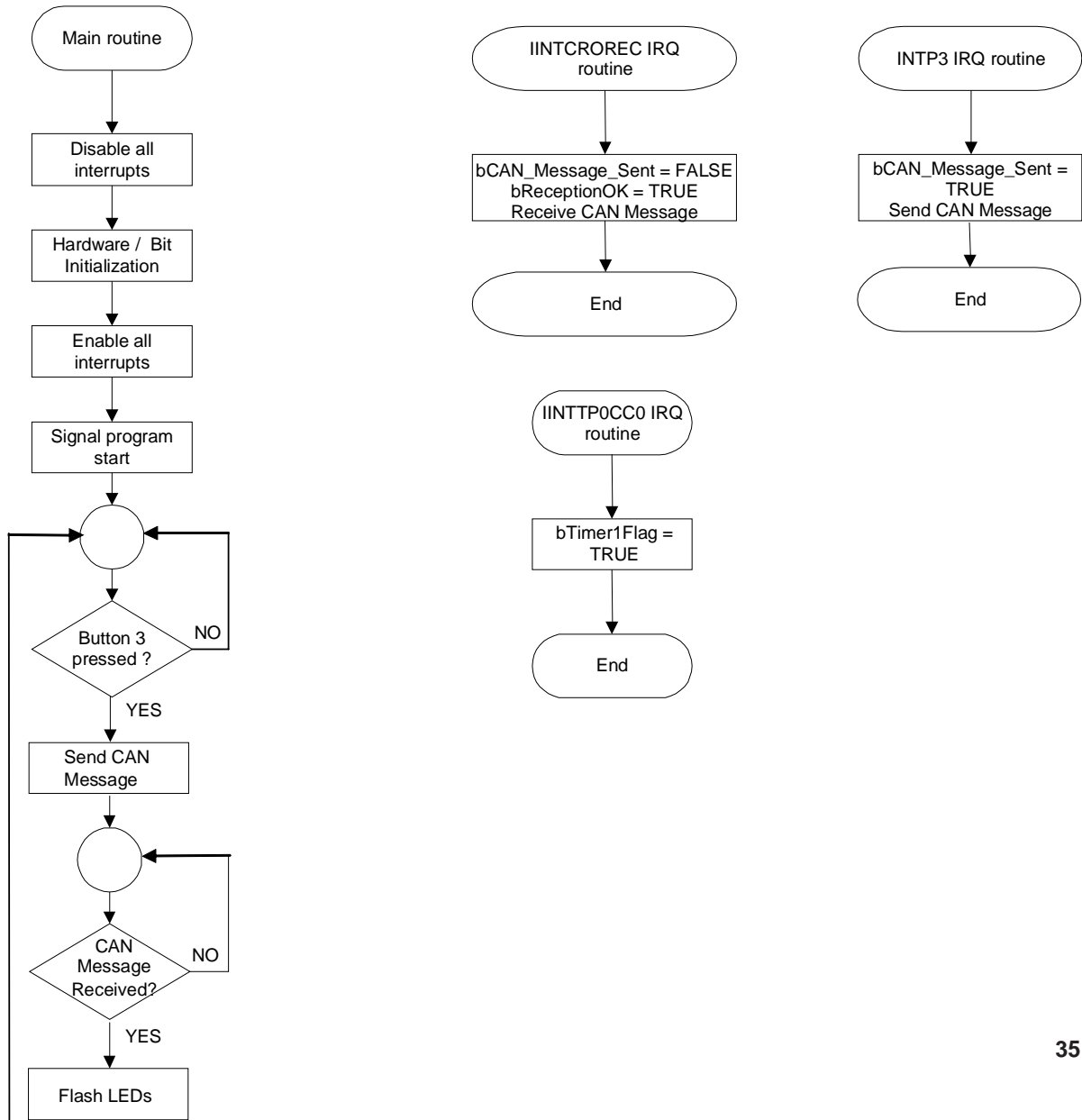

8. Connectors and Cables

8.1 Serial host connector



Figure 15: Target cable 2

Pin	78K0/Fx2	V850ES/Fx2	RS232 Signal on <i>F_Line - Drive it!</i>
1	NC	NC	---
2	RXD6	RXD0	RxD
3	TXD6	TXD0	TxD
4	NC	NC	DTR
5	NC	NC	GND
6	NC	NC	DSR
7	P17	P33	CTS
8	P16	P32	RTS
9	NC	NC	---

Pin	RS232 Signal on PC side
1	DTR
2	RxD
3	TxD
4	DSR
5	GND
6	---
7	CTS
8	RTS
9	---

Figure 16: Serial host connector

9. Schematics

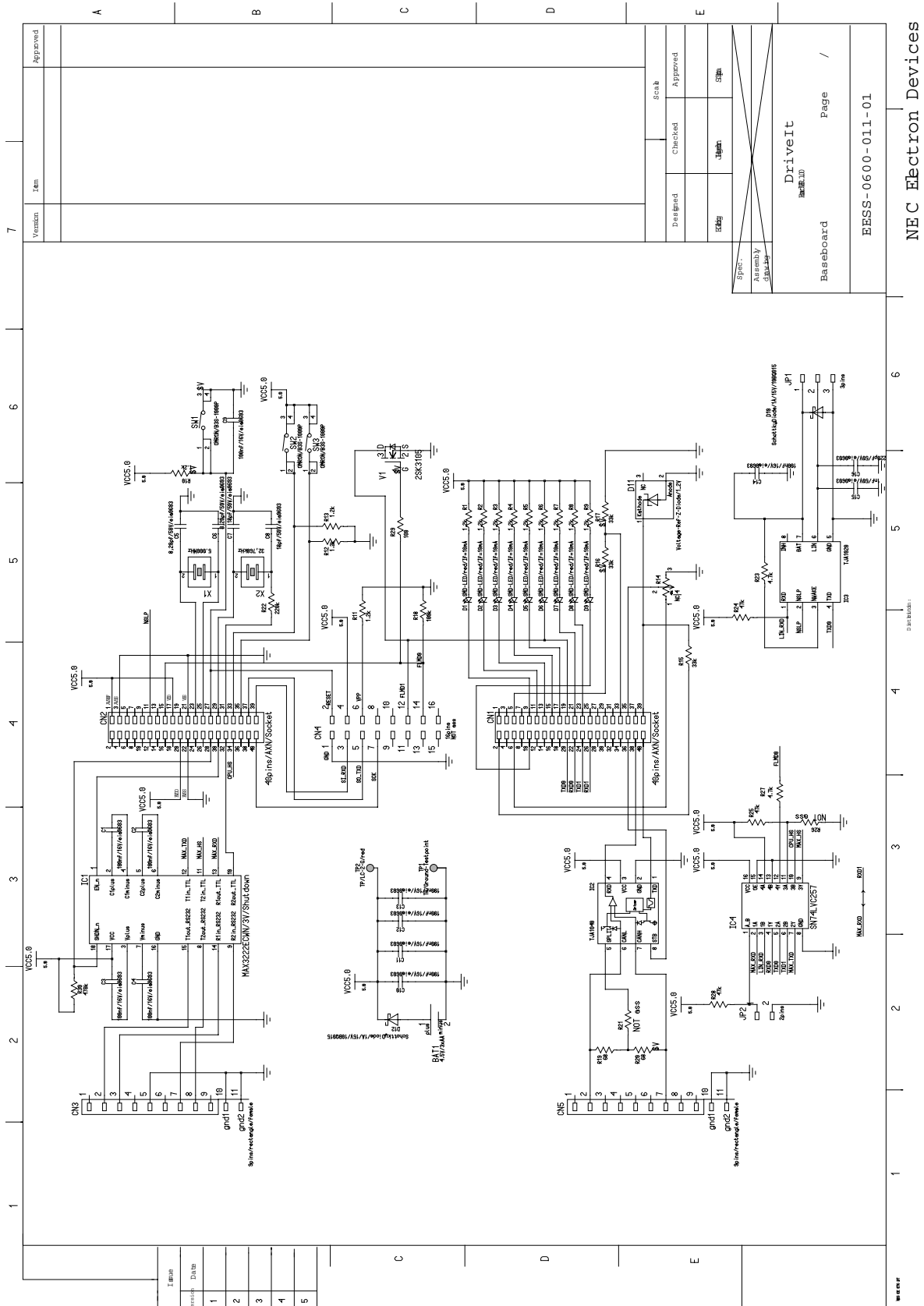

Figure 17: F_Line - Drive it! baseboard schematics

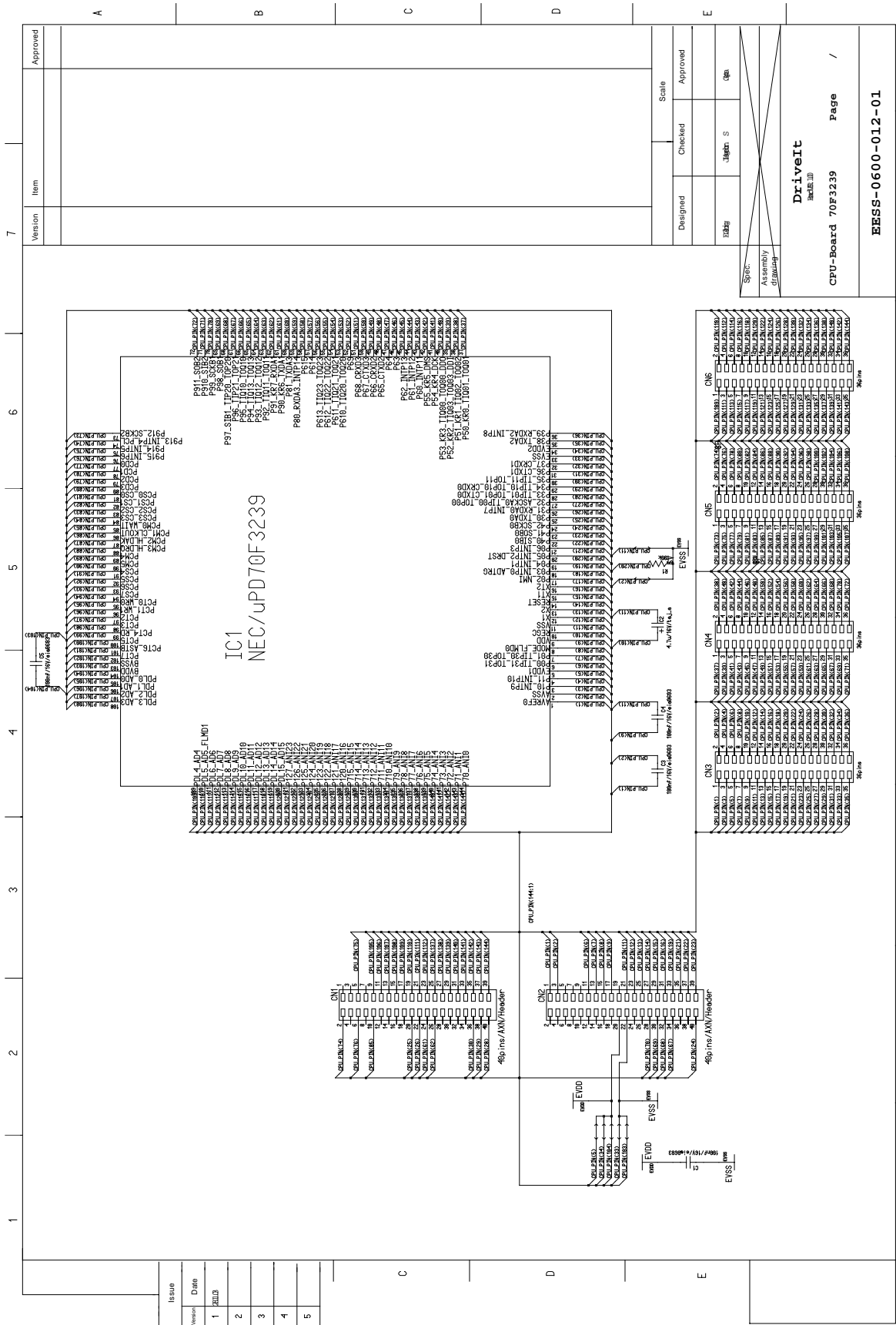

Figure 19: F_Line - Drive it! V850ES/FJ2 CPU module schematics

Version	Item	Approved

Designed	Checked	Scale
		Approved

Rate	Checked	Scale
100%	100%	100%

Rate	Checked	Scale
100%	100%	100%

Rate	Checked	Scale
100%	100%	100%

DriveIt
Rev: 1.0
CPU-Board 70F3239 Page /
ESS-0600-012-01
NEC Electron Devices