

# CubeSuite+ V1.00.00

Integrated Development Environment

User's Manual: 78K0 Design

Target Device

78K0 Microcontroller

All information contained in these materials, including products and product specifications, represents information on the product at the time of publication and is subject to change by Renesas Electronics Corp. without notice. Please review the latest information published by Renesas Electronics Corp. through various means, including the Renesas Electronics Corp. website (<http://www.renesas.com>).

## Notice

1. All information included in this document is current as of the date this document is issued. Such information, however, is subject to change without any prior notice. Before purchasing or using any Renesas Electronics products listed herein, please confirm the latest product information with a Renesas Electronics sales office. Also, please pay regular and careful attention to additional and different information to be disclosed by Renesas Electronics such as that disclosed through our website.
2. Renesas Electronics does not assume any liability for infringement of patents, copyrights, or other intellectual property rights of third parties by or arising from the use of Renesas Electronics products or technical information described in this document. No license, express, implied or otherwise, is granted hereby under any patents, copyrights or other intellectual property rights of Renesas Electronics or others.
3. You should not alter, modify, copy, or otherwise misappropriate any Renesas Electronics product, whether in whole or in part.
4. Descriptions of circuits, software and other related information in this document are provided only to illustrate the operation of semiconductor products and application examples. You are fully responsible for the incorporation of these circuits, software, and information in the design of your equipment. Renesas Electronics assumes no responsibility for any losses incurred by you or third parties arising from the use of these circuits, software, or information.
5. When exporting the products or technology described in this document, you should comply with the applicable export control laws and regulations and follow the procedures required by such laws and regulations. You should not use Renesas Electronics products or the technology described in this document for any purpose relating to military applications or use by the military, including but not limited to the development of weapons of mass destruction. Renesas Electronics products and technology may not be used for or incorporated into any products or systems whose manufacture, use, or sale is prohibited under any applicable domestic or foreign laws or regulations.
6. Renesas Electronics has used reasonable care in preparing the information included in this document, but Renesas Electronics does not warrant that such information is error free. Renesas Electronics assumes no liability whatsoever for any damages incurred by you resulting from errors in or omissions from the information included herein.
7. Renesas Electronics products are classified according to the following three quality grades: “Standard”, “High Quality”, and “Specific”. The recommended applications for each Renesas Electronics product depends on the product’s quality grade, as indicated below. You must check the quality grade of each Renesas Electronics product before using it in a particular application. You may not use any Renesas Electronics product for any application categorized as “Specific” without the prior written consent of Renesas Electronics. Further, you may not use any Renesas Electronics product for any application for which it is not intended without the prior written consent of Renesas Electronics. Renesas Electronics shall not be in any way liable for any damages or losses incurred by you or third parties arising from the use of any Renesas Electronics product for an application categorized as “Specific” or for which the product is not intended where you have failed to obtain the prior written consent of Renesas Electronics. The quality grade of each Renesas Electronics product is “Standard” unless otherwise expressly specified in a Renesas Electronics data sheets or data books, etc.
  - “Standard”: Computers; office equipment; communications equipment; test and measurement equipment; audio and visual equipment; home electronic appliances; machine tools; personal electronic equipment; and industrial robots.
  - “High Quality”: Transportation equipment (automobiles, trains, ships, etc.); traffic control systems; anti-disaster systems; anti-crime systems; safety equipment; and medical equipment not specifically designed for life support.
  - “Specific”: Aircraft; aerospace equipment; submersible repeaters; nuclear reactor control systems; medical equipment or systems for life support (e.g. artificial life support devices or systems), surgical implantations, or healthcare intervention (e.g. excision, etc.), and any other applications or purposes that pose a direct threat to human life.
8. You should use the Renesas Electronics products described in this document within the range specified by Renesas Electronics, especially with respect to the maximum rating, operating supply voltage range, movement power voltage range, heat radiation characteristics, installation and other product characteristics. Renesas Electronics shall have no liability for malfunctions or damages arising out of the use of Renesas Electronics products beyond such specified ranges.
9. Although Renesas Electronics endeavors to improve the quality and reliability of its products, semiconductor products have specific characteristics such as the occurrence of failure at a certain rate and malfunctions under certain use conditions. Further, Renesas Electronics products are not subject to radiation resistance design. Please be sure to implement safety measures to guard them against the possibility of physical injury, and injury or damage caused by fire in the event of the failure of a Renesas Electronics product, such as safety design for hardware and software including but not limited to redundancy, fire control and malfunction prevention, appropriate treatment for aging degradation or any other appropriate measures. Because the evaluation of microcomputer software alone is very difficult, please evaluate the safety of the final products or system manufactured by you.
10. Please contact a Renesas Electronics sales office for details as to environmental matters such as the environmental compatibility of each Renesas Electronics product. Please use Renesas Electronics products in compliance with all applicable laws and regulations that regulate the inclusion or use of controlled substances, including without limitation, the EU RoHS Directive. Renesas Electronics assumes no liability for damages or losses occurring as a result of your noncompliance with applicable laws and regulations.
11. This document may not be reproduced or duplicated, in any form, in whole or in part, without prior written consent of Renesas Electronics.
12. Please contact a Renesas Electronics sales office if you have any questions regarding the information contained in this document or Renesas Electronics products, or if you have any other inquiries.

(Note 1) “Renesas Electronics” as used in this document means Renesas Electronics Corporation and also includes its majority-owned subsidiaries.

(Note 2) “Renesas Electronics product(s)” means any product developed or manufactured by or for Renesas Electronics.

## How to Use This Manual

This manual describes the role of the CubeSuite+ integrated development environment for developing application systems for 78K0 microcontrollers, and provides an outline of its features.

CubeSuite+ is an integrated development environment (IDE) for 78K0 microcontrollers, integrating the necessary tools for the development phase of software (e.g. design, implementation, and debugging) into a single platform.

By providing an integrated environment, it is possible to perform all development using just this product, without the need to use many different tools separately.

**Readers** This manual is intended for users who wish to understand the functions of the CubeSuite+ and design software and hardware application systems.

**Purpose** This manual is intended to give users an understanding of the functions of the CubeSuite+ to use for reference in developing the hardware or software of systems using these devices.

**Organization** This manual can be broadly divided into the following units.

### **CHAPTER 1 GENERAL**

### **CHAPTER 2 FUNCTIONS (Pin Configurator)**

### **CHAPTER 3 FUNCTIONS (Code Generator)**

### **APPENDIX A WINDOW REFERENCE**

### **APPENDIX B OUTPUT FILES**

### **APPENDIX C API FUNCTIONS**

### **APPENDIX D INDEX**

**How to Read This Manual** It is assumed that the readers of this manual have general knowledge of electricity, logic circuits, and microcontrollers.

**Conventions**

|                            |   |
|----------------------------|---|
| Data significance:         | Higher digits on the left and lower digits on the right |
| Active low representation: | $\overline{XXX}$ (overscore over pin or signal name)    |
| Note:                      | Footnote for item marked with Note in the text          |
| Caution:                   | Information requiring particular attention              |
| Remark:                    | Supplementary information                               |
| Numeric representation:    | Decimal ... XXXX<br>Hexadecimal ... 0xXXXX              |

**Related Documents**

The related documents indicated in this publication may include preliminary versions. However, preliminary versions are not marked as such.

| Document Name   | Document No.           |             |
|---|------------------------|-------------|
| CubeSuite+<br>Integrated Development Environment<br>User's Manual | Start                  | R20UT0545E  |
|   | 78K0 Design            | This manual |
|   | 78K0R Design           | R20UT0547E  |
|   | RL78 Design            | R20UT0548E  |
|   | V850 Design            | R20UT0549E  |
|   | R8C Design             | R20UT0550E  |
|   | 78K0 Coding            | R20UT0551E  |
|   | RL78,78K0R Coding      | R20UT0552E  |
|   | V850 Coding            | R20UT0553E  |
|   | Coding for CX Compiler | R20UT0554E  |
|   | R8C Coding             | R20UT0576E  |
|   | 78K0 Build             | R20UT0555E  |
|   | RL78,78K0R Build       | R20UT0556E  |
|   | V850 Build             | R20UT0557E  |
|   | Build for CX Compiler  | R20UT0558E  |
|   | R8C Build              | R20UT0575E  |
|   | 78K0 Debug             | R20UT0559E  |
|   | 78K0R Debug            | R20UT0560E  |
|   | RL78 Debug             | R20UT0561E  |
|   | V850 Debug             | R20UT0562E  |
| R8C Debug   | R20UT0574E             |             |
| Analysis  | R20UT0563E             |             |
| Message   | R20UT0407E             |             |

**Caution** The related documents listed above are subject to change without notice. Be sure to use the latest edition of each document when designing.

All trademarks or registered trademarks in this document are the property of their respective owners.

[MEMO]

[MEMO]

[MEMO]

# TABLE OF CONTENTS

## CHAPTER 1 GENERAL ... 10

- 1.1 Overview ... 10
- 1.2 Features ... 10

## CHAPTER 2 FUNCTIONS (Pin Configurator) ... 11

- 2.1 Overview ... 11
- 2.2 Open Device Pin List Panel ... 13
  - 2.2.1 Select item ... 14
  - 2.2.2 Change display order ... 15
  - 2.2.3 Add column ... 16
  - 2.2.4 Delete column ... 17
- 2.3 Open Device Top View Panel ... 18
  - 2.3.1 Select shape of microcontroller ... 19
  - 2.3.2 Select color ... 20
  - 2.3.3 Select popup information ... 21
  - 2.3.4 Select additional information ... 22
- 2.4 Enter Information ... 23
- 2.5 Output Report Files ... 24
  - 2.5.1 Output device pin list ... 24
  - 2.5.2 Output device top view ... 25

## CHAPTER 3 FUNCTIONS (Code Generator) ... 26

- 3.1 Overview ... 26
- 3.2 Open Code Generator Panel ... 27
- 3.3 Enter Information ... 28
  - 3.3.1 Input rule ... 28
  - 3.3.2 Icon indicating incorrect entry ... 29
  - 3.3.3 Icon indicating pin conflict ... 30
- 3.4 Confirm Source Code ... 31
- 3.5 Output Source Code ... 32
  - 3.5.1 Setting that determines whether or not to generate source code ... 33
  - 3.5.2 Change file name ... 34
  - 3.5.3 Change API function name ... 35
  - 3.5.4 Change output mode ... 36
  - 3.5.5 Change output destination folder ... 37
- 3.6 Output Report Files ... 38
  - 3.6.1 Change output format ... 40
  - 3.6.2 Change output destination ... 41



## **APPENDIX A WINDOW REFERENCE ... 42**

**A.1 Description ... 42**

## **APPENDIX B OUTPUT FILES ... 90**

**B.1 Overview ... 90**

**B.2 Output File ... 90**

## **APPENDIX C API FUNCTIONS ... 95**

**C.1 Overview ... 95**

**C.2 Output Function ... 95**

**C.3 Function Reference ... 101**

**C.3.1 System ... 103**

**C.3.2 Port ... 114**

**C.3.3 INT ... 121**

**C.3.4 Serial ... 132**

**C.3.5 Operational Amplifier ... 172**

**C.3.6 Comparator ... 182**

**C.3.7 A/D ... 187**

**C.3.8 Timer ... 197**

**C.3.9 Watchdog Timer ... 228**

**C.3.10 RTC ... 230**

**C.3.11 Clock Output ... 264**

**C.3.12 LVI ... 270**

## **APPENDIX D INDEX ... 278**

## CHAPTER 1 GENERAL

CubeSuite+ is an integrated development environment used to carry out tasks such as design, coding, build and debug for developing application systems.

This chapter gives an overview of the design tool (Pin Configurator/Code Generator).

### 1.1 Overview

The design tool, which is one of the components provided by CubeSuite+, enables you to output the pin assignment of the microcontroller (device pin list and device top view), and the source code (device driver programs, C source files and header files) necessary to control the peripheral functions provided by the microcontroller (clock generator, port functions, etc.) by configuring various information using the GUI.

### 1.2 Features

The design tool (Pin Configurator/Code Generator) has the following features.

- Code generating function

The Code Generator can output not only device driver programs in accordance with the information configured using the GUI, but also a build environment such as sample programs containing main functions and link directive files.

Source code output by Code Generator conforms to the MISRA-C (Guidelines for the Use of the C Language in Vehicle Based Software) coding convention.

- Reporting function

You can output configured information using Pin Configurator/Code Generator as files in various formats for use as design documents.

- Renaming function

The user can change default names assigned to the files output by Code Generator and the API functions contained in the source code.

---

**CHAPTER 2 FUNCTIONS (Pin Configurator)**

This chapter describes the key functions provided by the design tool (Pin Configurator) along with operation procedures.

**2.1 Overview**

The Pin Configurator is used to output report files such as a device pin list and a device top view by entering pin assignment information of the microcontroller.

The following sections describe the operation procedures for Pin Configurator.

**(1) Start CubeSuite+**

Launch CubeSuite+ from the [Start] menu of Windows.

**Remark** See "CubeSuite+ Start User's Manual" for details on "Start CubeSuite+".

**(2) Create/Open project**

Create a new project (that defines a kind of project, microcontroller to be used, build tools to be used, etc.) or load an existing project.

**Remark** See "CubeSuite+ Start User's Manual" for details on "Create/Open project".

**(3) Open Device Pin List Panel**

Open the [Device Pin List panel](#), where you enter information on the pins of the microcontroller.

**(a) Select item**

Allows you to select items displayed in the device pin list.

**(b) Change display order**

Allows you to change the order in which items are displayed in the device pin list.

**(c) Add column**

Allows you to add columns to the device pin list.

**(d) Delete column**

Allows you to delete columns from the device pin list.

**(4) Open Device Top View Panel**

Open the [Device Top View panel](#), where you can confirm the information entered for the pins.

**(a) Select shape of microcontroller**

Allows you to select the shape of the microcontroller displayed in the [Device Top View panel](#).

**(b) Select color**

Allows you to select colors used to distinguish the type of pins (power pins, special pins, used pins, etc.) whose information is displayed in the [Device Top View panel](#).

**(c) Select popup information**

Allows you to select the type of information that popups when you move the mouse cursor over each pin in the [Device Top View panel](#).

**(d) Select additional information**

Select the type of information to display in Pin area of the [Device Top View panel](#).

**(5) Enter Information**

Enter information on the pins of the microcontroller in the [Device Pin List panel](#).

**(6) Output Report Files**

Output report files (files containing configured information using Pin Configurator: device pin list and device top view) to the specified folder.

**(a) Output device pin list**

Output a device pin list.

**(b) Output device top view**

Output a device top view.

**(7) Save project**

Save a project.

**Remark** See "CubeSuite+ Start User's Manual" for details on "Save project".

## 2.2 Open Device Pin List Panel

Open the [Device Pin List panel](#), where you enter information on the pins of the microcontroller.

To open the [Device Pin List panel](#), select [*Project name* (Project)] >> [Pin Configurator (Design Tool)] >> [Device Pin List] in the [Project Tree panel](#).

Figure 2-1. Open Device Pin List Panel

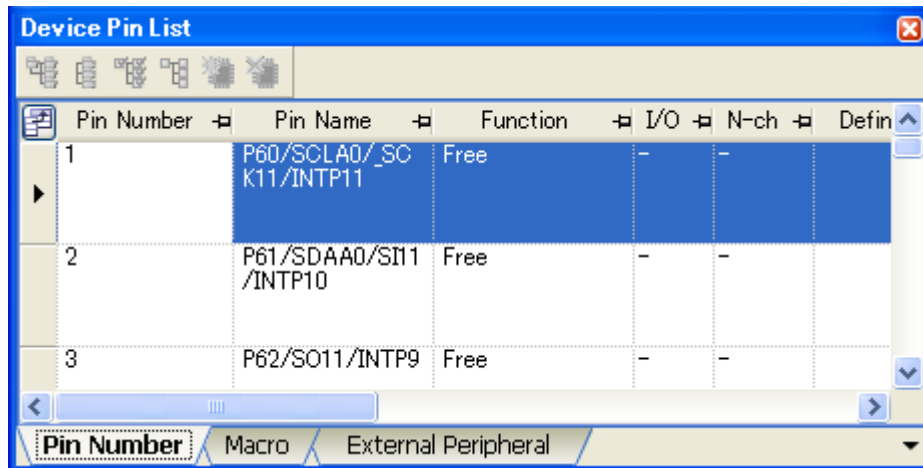

- Remarks 1.** If an unsupported microcontroller is defined in the project for Pin Configurator, then "[Pin Configurator (Design Tool)] node" will hide under [*Project name* (Project)] in the [Project Tree panel](#).
- 2.** The [Device Pin List panel](#) consists of three tabs. Selecting one of the tabs changes the order in which "information on each pin of the microcontroller" is displayed.
- [[Pin Number](#)] tab  
Information on each pin of the microcontroller is displayed in the order of pin number.
  - [[Macro](#)] tab  
Information on each pin of the microcontroller is displayed in the order it was grouped into peripheral functions.
  - [[External Peripheral](#)] tab  
Information about the pins connected to external peripherals is displayed in order grouped at the external-peripheral component level.

2.2.1 Select item

The Pin Configurator is used to select items to be displayed in the device pin list using the  button in the upper left corner of the device pin list.

To select the item to be displayed, use the [Column Chooser dialog box](#) that opens by pressing the  button in the upper left corner of the device pin list.

Figure 2-2. Select Item



**Remark** To select the item to be displayed, check the check box that corresponds to the item.

Table 2-1. Select Item

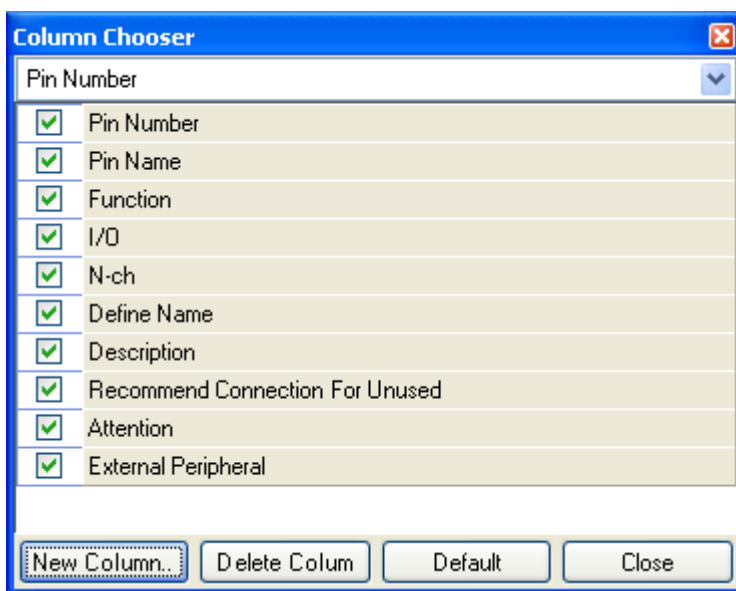
|             |  |
|-------------|--|
| Checked     | Displays the selected item in the device pin list. |
| Not checked | Hides the selected item in the device pin list.    |

2.2.2 Change display order

In Pin Configurator, you can change the display order of columns in the device pin list (move columns) by dragging and dropping columns.

Figure 2-3. Change Display Order

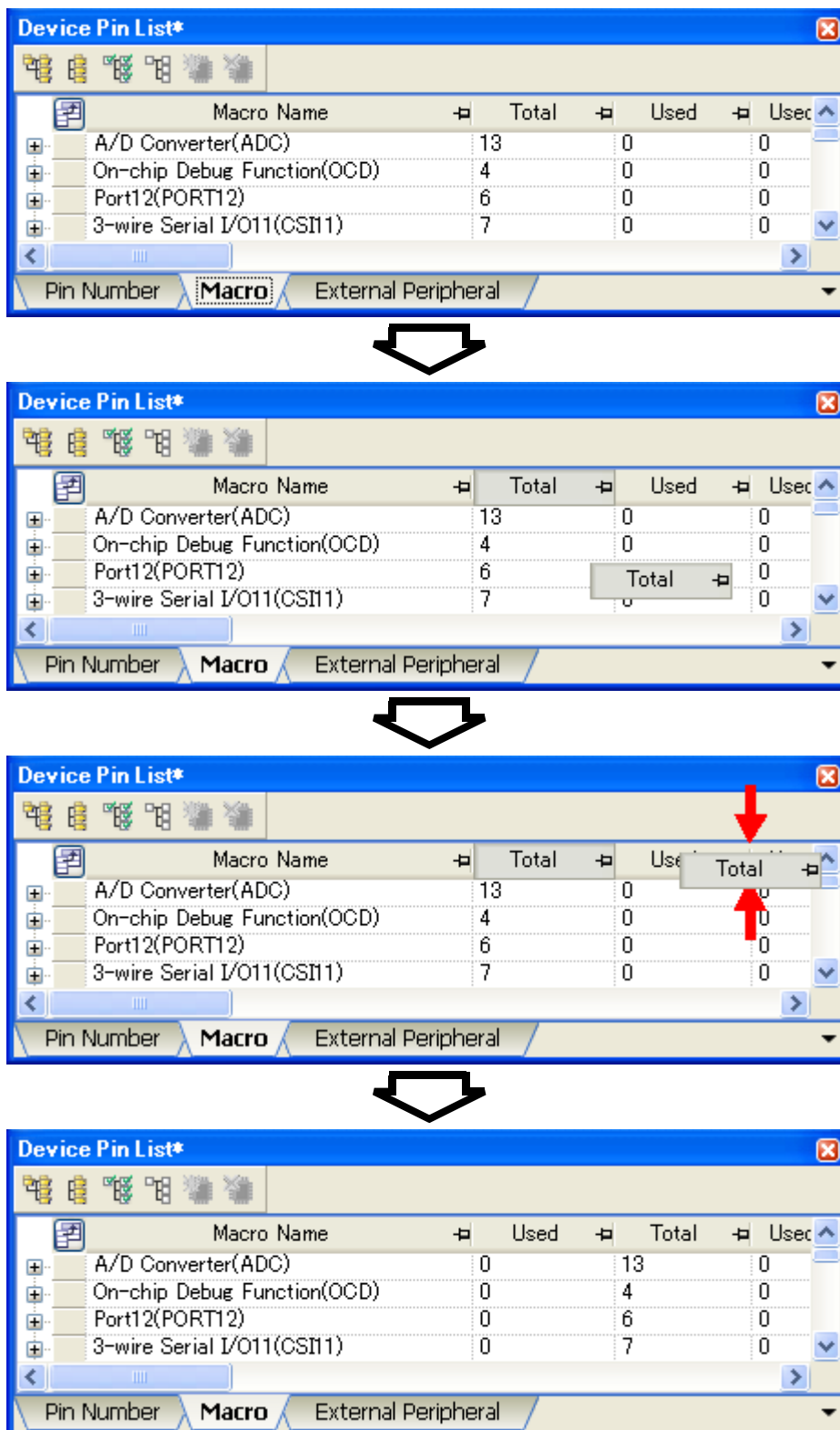

**Remark** To change the display order, click the  button in the upper left of the device pin list. The [Column Chooser dialog box](#) opens. Drag an item displayed in the dialog's select Items to display area, and drop it to the desired destination in the device pin list. This will change the display order.

### 2.2.3 Add column

The Pin Configurator is used to add the "user's own column" to the device pin list using the [New Column] button in the [Column Chooser dialog box](#) that opens by pressing the  button in the upper left corner of the device pin list.

To add a column, use the [New Column dialog box](#) that opens by pressing the [New Column] button in the [Column Chooser dialog box](#).

Figure 2-4. Add Column

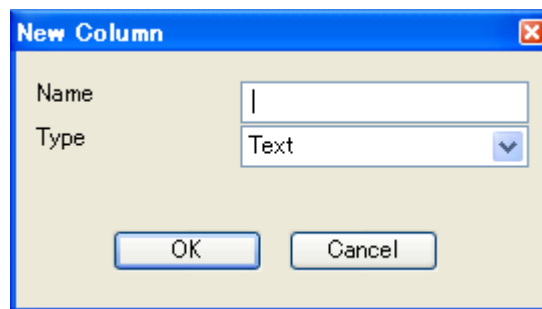

**Remark** On the device pin list, adding columns to the first level of [\[Macro\] tab](#), [\[External Peripheral\] tab](#) is restricted.



### 2.2.4 Delete column

The Pin Configurator is used to delete the "user's own column" from the device pin list using the [Delete Column] button in the [Column Chooser dialog box](#) that opens by pressing the  button in the upper left corner of the device pin list.

To delete a column, select the column you want to delete in the displayed item selection area of the [Column Chooser dialog box](#), and press the [Delete Column] button.

Figure 2-5. Delete Column

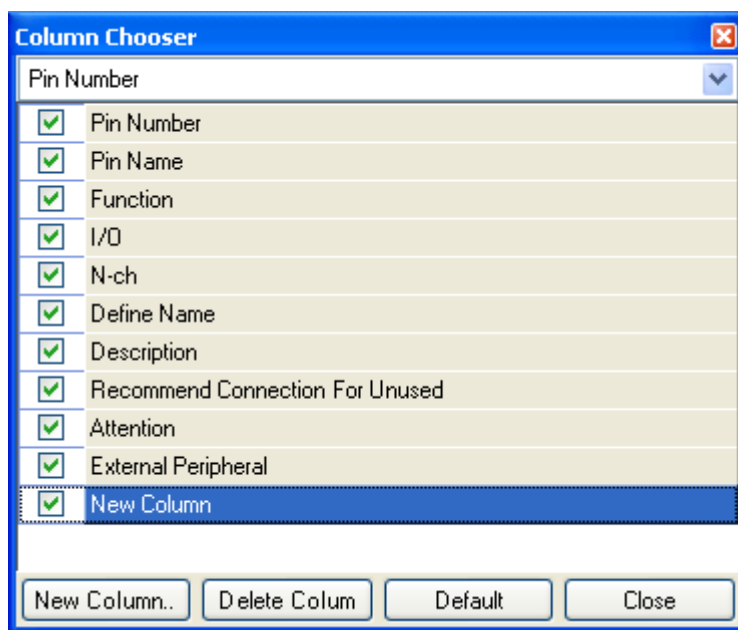

**Remark** You can only delete the column which you added using the [New Column dialog box](#).

### 2.3 Open Device Top View Panel

Open the [Device Top View panel](#), where you can confirm the information entered for the pins of the microcontroller.

To open the [Device Top View panel](#), select [*Project name* (Project)] >> [Pin Configurator (Design Tool)] >> [Device Top View] in the [Project Tree panel](#).

Figure 2-6. Open Device Top View Panel

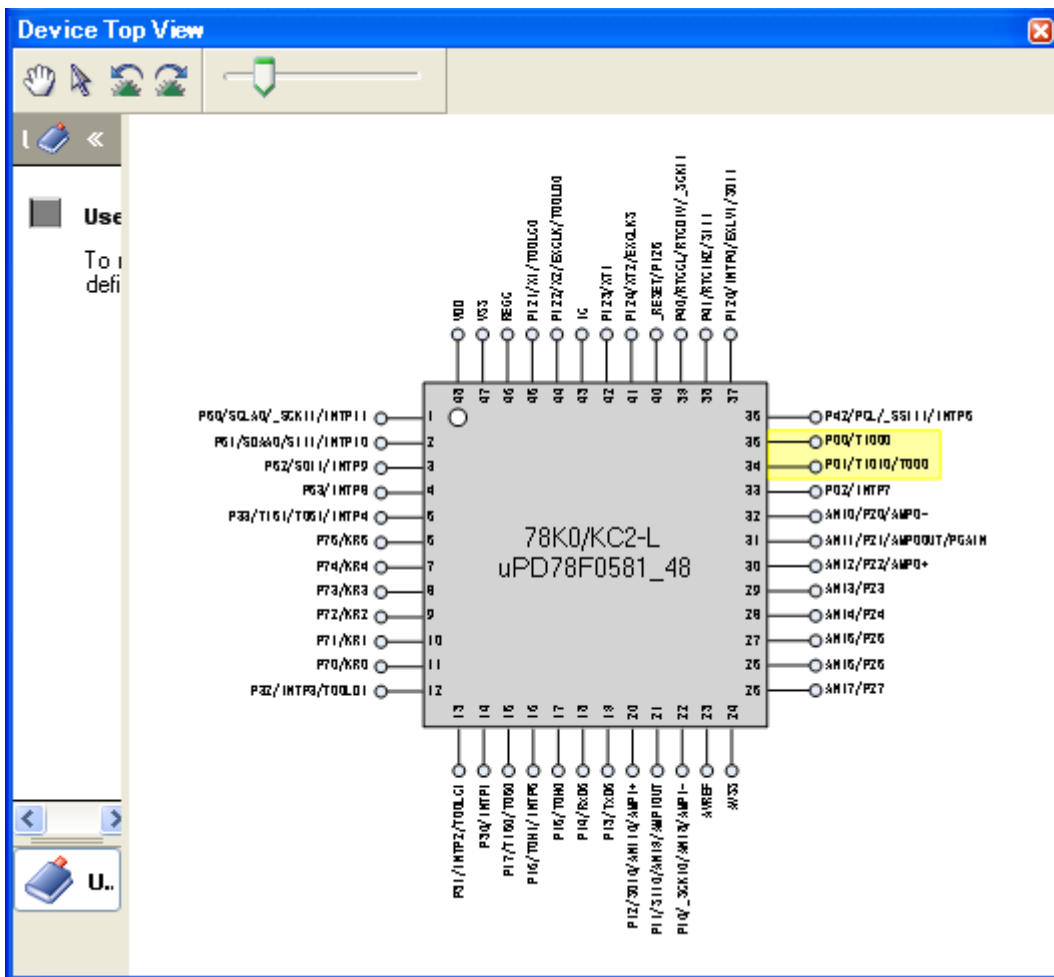

**Remark** In the [Property panel](#), on the [[Pin Configurator Settings](#)] tab, if "BGA" is selected for the Package type, then [Device Top View panel](#) cannot be opened.

2.3.1 Select shape of microcontroller

Select the shape of the microcontroller displayed in the [Device Top View panel](#) which is opened as described in "2.3 Open Device Top View Panel".

To select the shape of the microcontroller, click [[Pin Configurator Settings](#)] tab >> [Package type] in the [Property panel](#) and select the desired shape.

Figure 2-7. Select Shape of Microcontroller

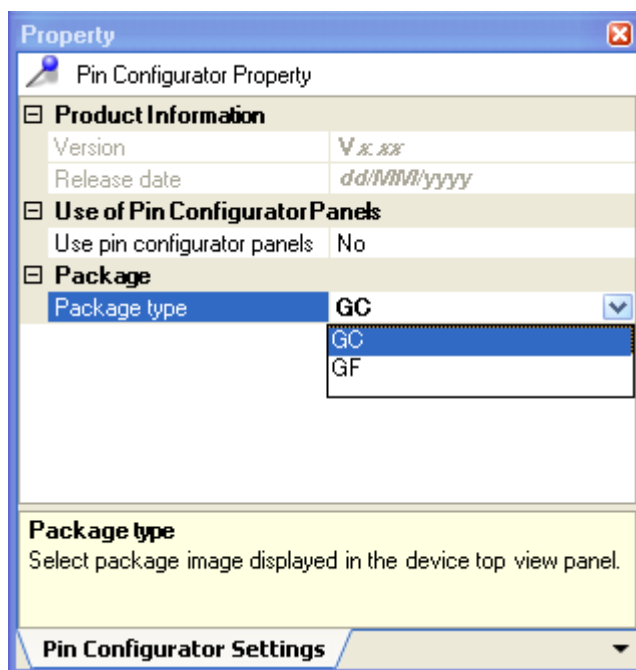

**Remark** Selection of the shape of the microcontroller is made using the order name (such as GC and GF).

2.3.2 Select color

Select the colors used to distinguish the type of pins (power pins, special pins, unused pins, etc.) whose information is displayed in the [Device Top View panel](#) which is opened as described in "2.3 Open Device Top View Panel".

To select the color to be displayed, select the desired color in the color palette that opens by clicking [[Device Top View Settings](#)] tab >> [Color] in the [Property panel](#).

Figure 2-8. Select Color

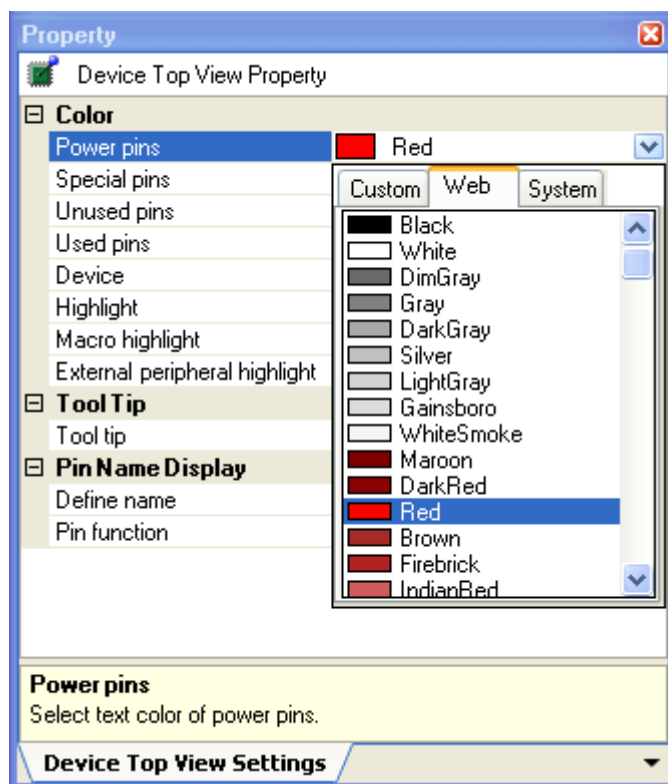

**Remark** Select the colors to be displayed for the following eight types of items.

Table 2-2. Select Color

| Item            | Outline  |
|-----------------|--|
| Power pins      | Selects the display color for power pins (pins whose use is limited to power).   |
| Special pins    | Selects the display color for special pins (pins with specified uses).   |
| Unused pins     | Selects the display color for unused pins (dual-use pins with no use set in the <a href="#">Device Pin List panel</a> ).                 |
| Used pins       | Selects the display color for used pins (dual-use pins with a use set in the <a href="#">Device Pin List panel</a> ).                    |
| Device          | Selects the display color of the microcontroller.  |
| Highlight       | Selects the background color of a pin selected in the <a href="#">Device Pin List panel</a> , on the [ <a href="#">Pin Number</a> ] tab. |
| Macro highlight | Selects the background color of pins selected in the <a href="#">Device Pin List panel</a> , on the [ <a href="#">Macro</a> ] tab.       |

| Item                          | Outline   |
|-------------------------------|---|
| External peripheral highlight | Selects the background color of pins selected in the <a href="#">Device Pin List panel</a> , on the <a href="#">[External Peripheral] tab</a> . |

**2.3.3 Select popup information**

Select the type of information that popups when you move the mouse cursor over each pin in the [Device Top View panel](#) which is opened as described in "2.3 [Open Device Top View Panel](#)".

To select the popup information, click [\[Device Top View Settings\] tab](#) >> [\[Tool tip\]](#) in the [Property panel](#) and select the desired type of information.

**Figure 2-9. Select Popup Information**

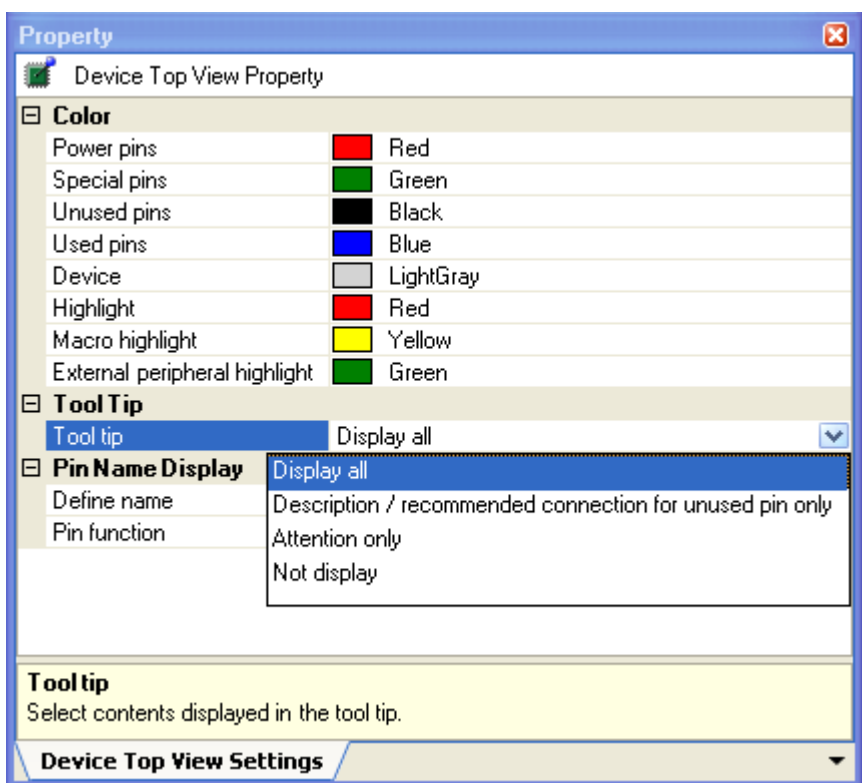

**Remark** Popup information is selected from the following four types.

**Table 2-3. Select Popup Information**

| Popup Information  | Outline   |
|--|---|
| Display all  | Displays the "Description", "Recommend Connection For Unused", and "Attention" strings for the device pin list. |
| Description / recommended connection for unused pin only | Displays the "Description", and "Recommend Connection For Unused" string for the device pin list.               |
| Attention only   | Displays the "Attention" string for the device pin list.  |
| Not display  | Hides tooltips when the mouse cursor hovers over a pin.   |

2.3.4 Select additional information

Select the type of information to display in Pin area, in the [Device Top View panel](#) opened in "2.3 Open Device Top View Panel".

Note that additional information is selected from the [Property panel](#), on the [\[Device Top View Settings\] tab](#), by selecting the corresponding information under [Pin Name Display].

Figure 2-10. Select Additional Information

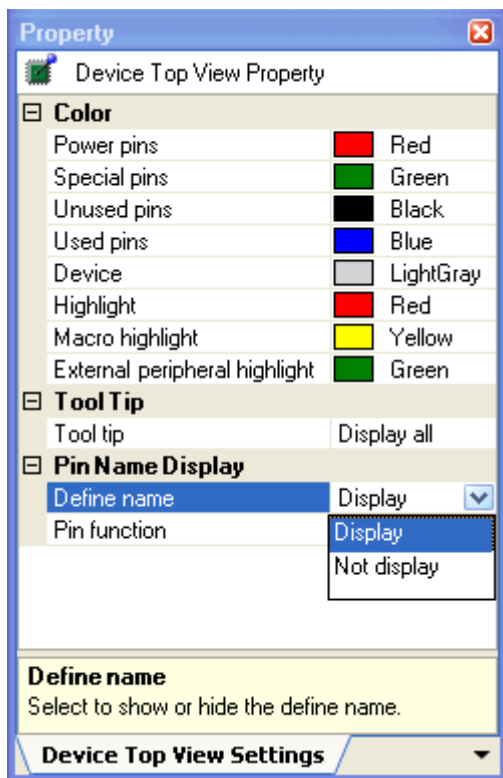

**Remarks 1.** Select one of the following two types for Define name (whether to display the "Define Name" string of the Device Pin List in appended format).

|             |  |
|-------------|--|
| Display     | Displays the "Define Name" string of the device pin list in appended format. |
| Not display | Hides the "Define Name" string of the device pin list.                       |

**2.** Select one of the following two types for Pin function (whether to display it whether or not a function is selected for "Function" on the Device Pin List).

|                        |  |
|------------------------|--|
| Display all            | Displays functions selected via the device pin list's "Function" feature in parentheses.             |
| Selected function only | Only display functions selected via the device pin list's "Function" feature in the device top view. |

### 2.4 Enter Information

Enter information on the pins of the microcontroller in the [Device Pin List panel](#) which is opened as described in "2.2 Open Device Pin List Panel".

- Remarks 1.** You cannot add information in the "Pin Number" column, "Pin Name" column, "Description" column, "Recommend Connection For Unused" column and "Attention" column because they contain fixed information.
- 2.** If the "Free" in the "Function" column is changed to a specific pin name, color of the corresponding pin in the [Device Top View panel](#) changes from the "color representing the unused pins" to the "color representing the used pins" selected by clicking [[Device Top View Settings](#)] tab >> [[Color](#)] in the [Property panel](#).

Figure 2-11. Change in Displayed Color

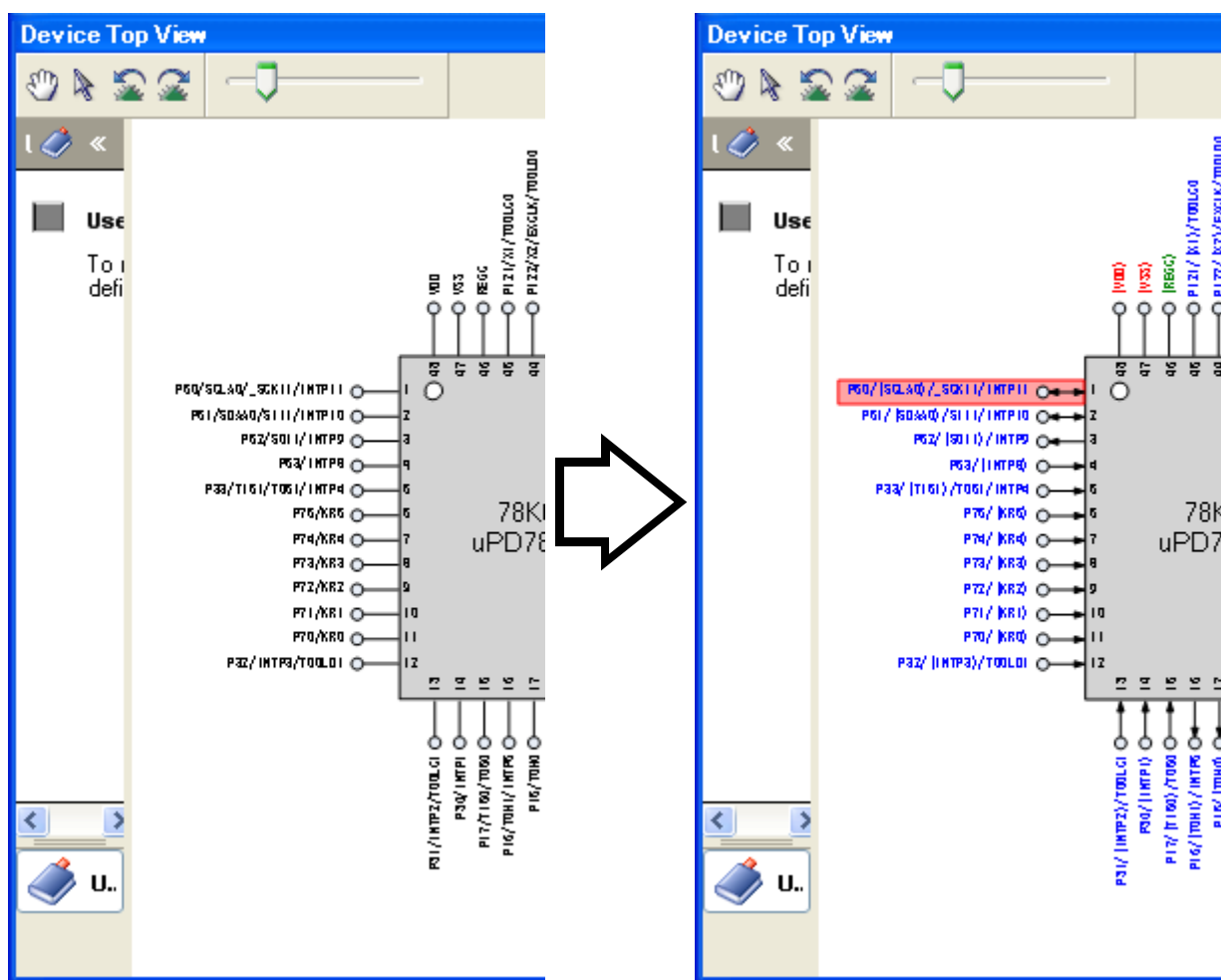

## 2.5 Output Report Files

Output report files (files containing information configured using Pin Configurator: device pin list and device top view) to the specified folder.

### 2.5.1 Output device pin list

Select [File] menu >> [Save Pin List As...] to output a report file (a file containing information configured using Pin Configurator: device pin list).

The destination folder for the device pin list is specified in the [Save As dialog box](#) which opens by selecting [File] menu >> [Save Pin List As ...].

Figure 2-12. Output Device Pin List

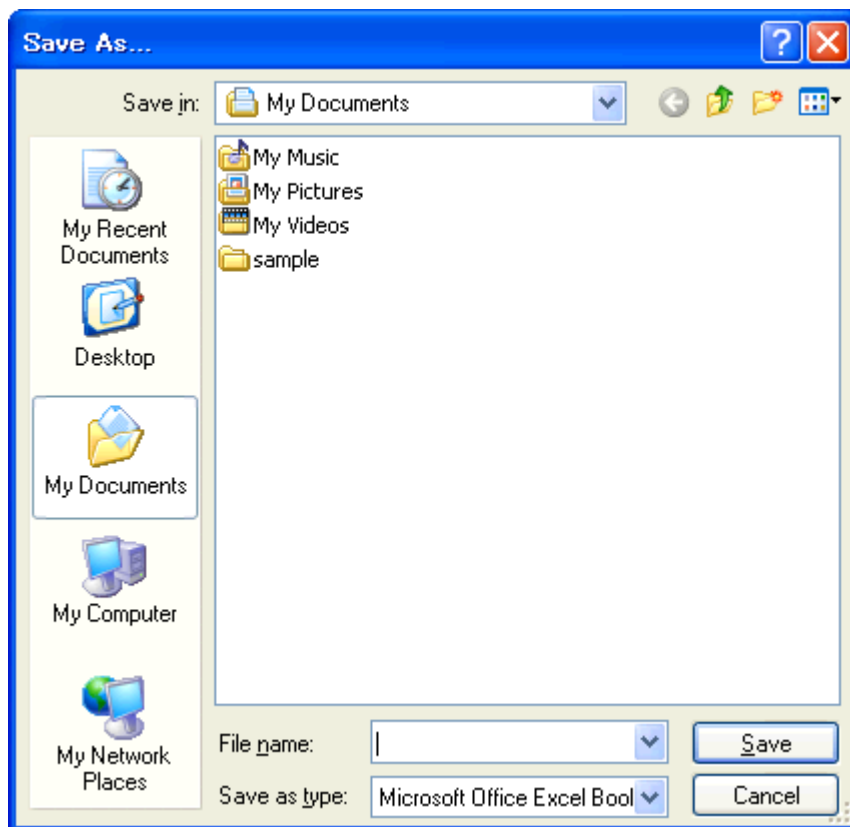

- Remarks 1.** If a device pin list has been already output, that list will be overwritten by selecting [File] menu >> [Save Pin List].
- 2.** The output format for the device pin list is limited to Microsoft Office Excel Book.



### 2.5.2 Output device top view

Select [File] menu >> [Save Top View As...] to output a report file (a file containing information configured using Pin Configurator: device top view).

The destination folder for the device top view is specified in the [Save As dialog box](#) which opens by selecting [File] menu >> [Save Top View As ...].

Figure 2-13. Output Device Top View

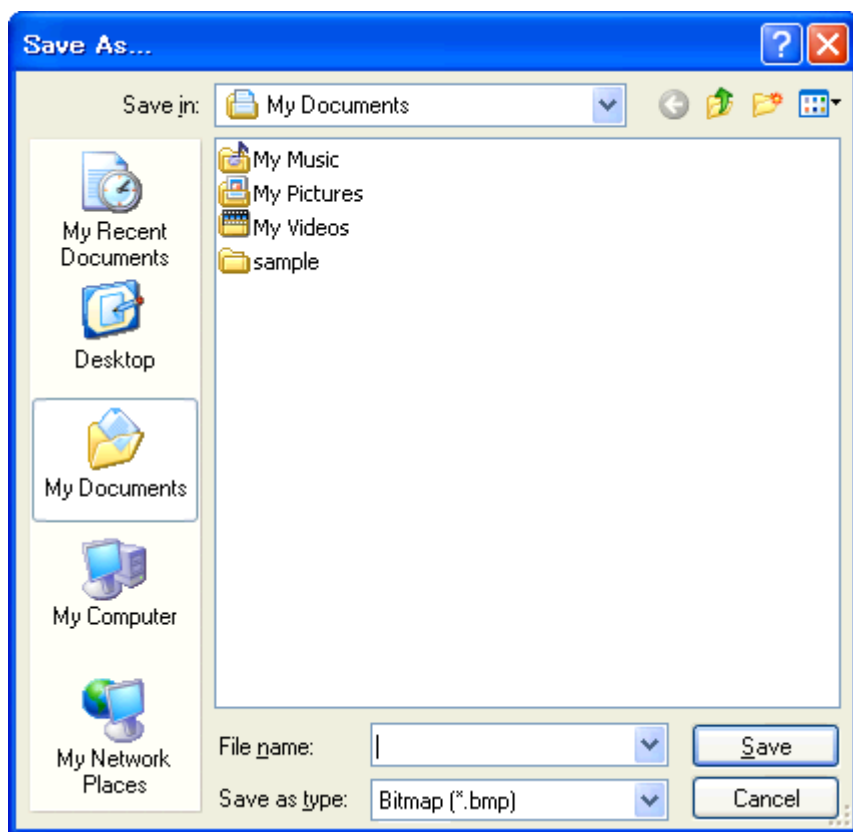

**Remark** If a device top view has been already output, that view will be overwritten by selecting [File] menu >> [Save Top View].

---

**CHAPTER 3 FUNCTIONS (Code Generator)**

This chapter describes the key functions provided by the design tool (Code Generator) along with operation procedures.

**3.1 Overview**

The Code Generator outputs source code (device driver programs) based on information selected/entered on CubeSuite+ panels that is needed to control peripheral functions provided by the microcontroller (clock generator, port functions, etc.).

The following sections describe the operation procedures for Code Generator.

**(1) Start CubeSuite+**

Launch CubeSuite+ from the [Start] menu of Windows.

**Remark** See "CubeSuite+ Start User's Manual" for details on "Start CubeSuite+".

**(2) Create/Open project**

Create a new project (that defines a kind of project, microcontroller to be used, build tools to be used, etc.) or load an existing project.

**Remark** See "CubeSuite+ Start User's Manual" for details on "Create/Open project".

**(3) Open Code Generator Panel**

Open the [Code Generator panel](#) used to configure the information necessary to control the peripheral functions (clock generator, port functions, etc.).

**(4) Enter Information**

Configure the information necessary to control the peripheral functions in the [Code Generator panel](#).

**(5) Confirm Source Code**

Confirm the source code (device driver program) that reflects the information configured in the [Code Generator panel](#).

**(6) Output Source Code**

Output the source code (device driver program) to the specified folder.

**(7) Output Report Files**

Output report files (a file containing information configured using Code Generator and a file containing information regarding the source code) to the specified folder.

**(8) Save project**

Save a project.

**Remark** See "CubeSuite+ Start User's Manual" for details on "Save project".

3.2 Open Code Generator Panel

Open the [Code Generator panel](#) to configure the information necessary to control the peripheral functions (clock generator, port functions, etc.).

To open the [Code Generator panel](#), select [*Project name (Project)*] >> [Code Generator (Design Tool)] >> Peripheral function node "[System], [Port], etc." in the [Project Tree panel](#).

Figure 3-1. Open Code Generator Panel

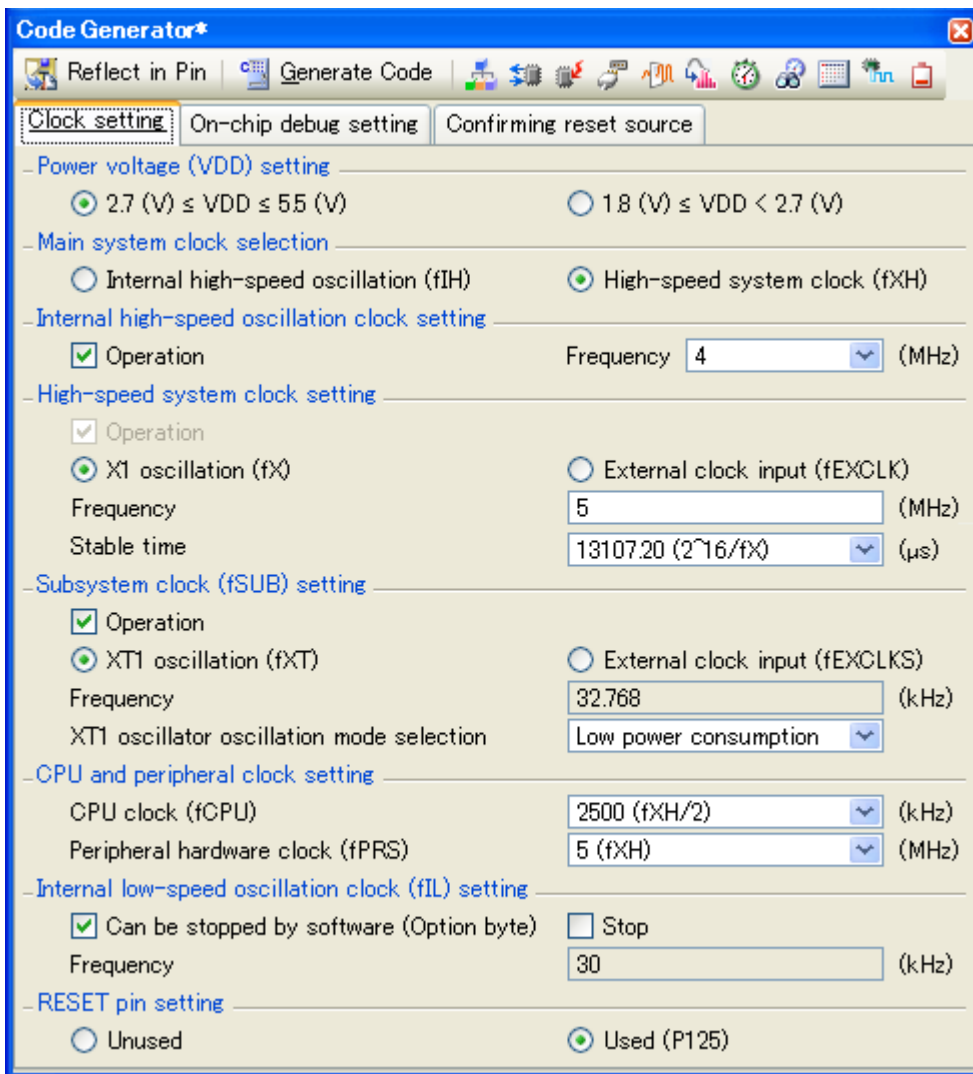

**Remark** If an unsupported microcontroller is defined in the project for Code Generator, then "[Code Generator (Design Tool)] node" will hide under [*Project name (Project)*] in the [Project Tree panel](#).

### 3.3 Enter Information

Configure the information necessary to control the peripheral functions in the information setting area of the [Code Generator panel](#) which is opened as described in "[3.2 Open Code Generator Panel](#)".

**Remark** When controlling multiple peripheral functions, repeat the procedures described in "[3.2 Open Code Generator Panel](#)" through "[3.3 Enter Information](#)".

#### 3.3.1 Input rule

Following is the rules for input to the [Code Generator panel](#).

##### (1) Character set

Character sets that are allowed to input are as follows.

**Table 3-1. List of Character Set**

| Character Set | Outline  |
|---------------|--|
| ASCII         | 1-byte alphabet, number, symbol  |
| Shift-JIS     | 2-byte alphabet, number, symbol, Hiragana, Katakana, Kanji and 1-byte Katakana                             |
| EUC-JP        | 2-byte alphabet, number, symbol, Hiragana, Katakana, Kanji and 1-byte Katakana                             |
| UTF-8         | 2-byte alphabet, number, symbol, Hiragana, Katakana, Kanji (include Chinese character) and 1-byte Katakana |

##### (2) Number

Notations allowed when entering numbers are as follows.

**Table 3-2. List of Notation**

| Notation       | Outline   |
|----------------|---|
| Decimal number | A numeric value that starts with a number between 1 and 9 and followed by numbers between 0 and 9, and the numeric value 0                              |
| Hex number     | A numeric value that starts with 0x and followed by a combination of numbers from 0 to 9 and characters from A to F (characters are not case sensitive) |

3.3.2 Icon indicating incorrect entry

When performing code generation, if you enter an invalid string in the [Code Generator panel](#), or a required input is missing, then a  icon displays next to the incorrect input, and the text is displayed in red to warn that there is a problem with the input.



**Remark** If the mouse cursor is moved over the  icon, information regarding the string that should be entered (tips for correcting the entry) pops up.

Figure 3-2. Icon Indicating Incorrect Entry

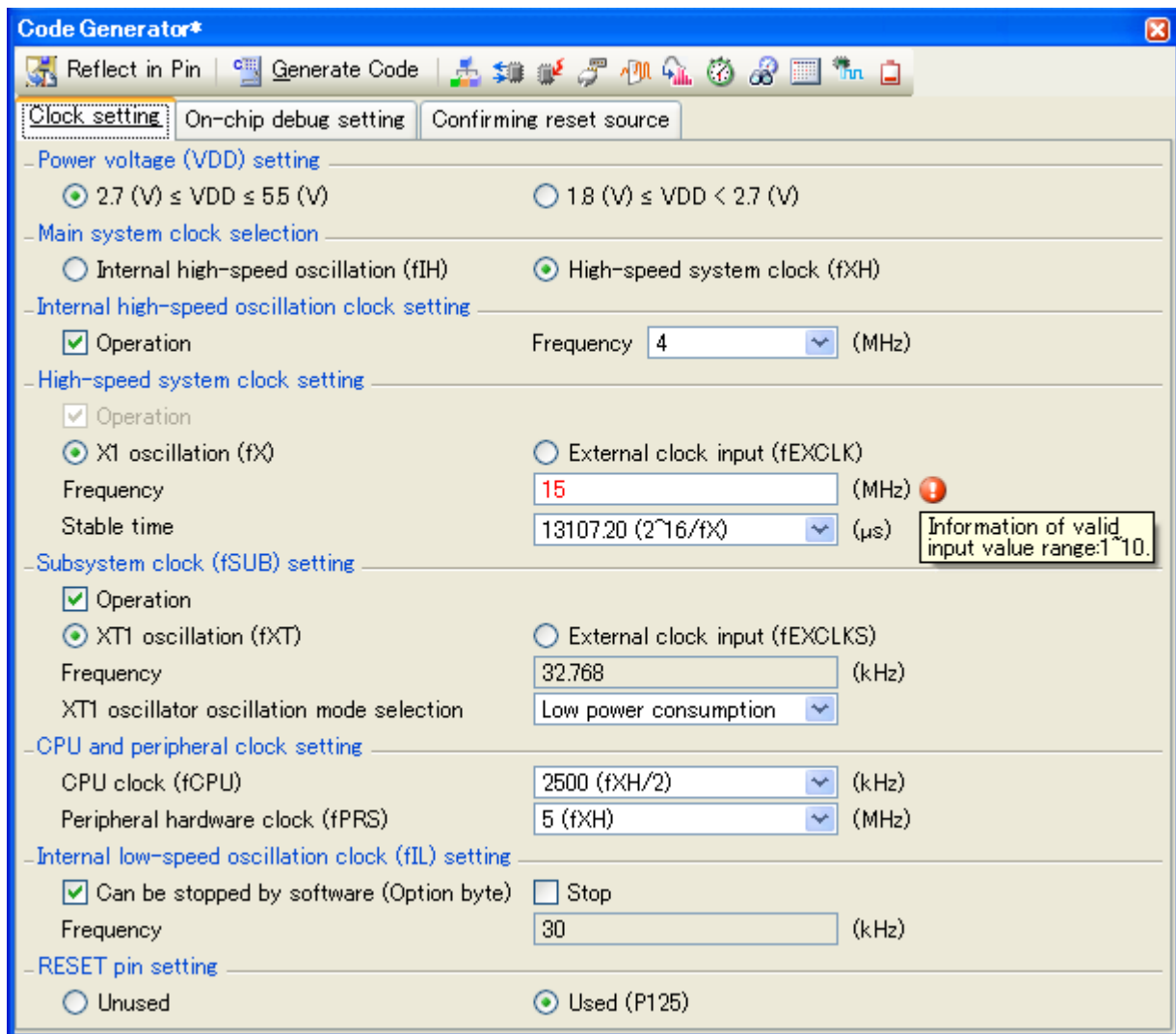

3.3.3 Icon indicating pin conflict

If a conflict occurs between the pins while setting various peripheral functions in the [Code Generator panel](#), the  icon is displayed at the location where the conflict occurs to warn the user of a conflict between the pins.

**Remark** If the mouse cursor is moved over the  icon, information regarding the conflict between the pins (tips for avoiding the conflict) pops up.

Figure 3-3. Icon Indicating Pin Conflict



### 3.4 Confirm Source Code

Confirm the source code (device driver program) that reflects the information configured as described in "3.3 Enter Information".

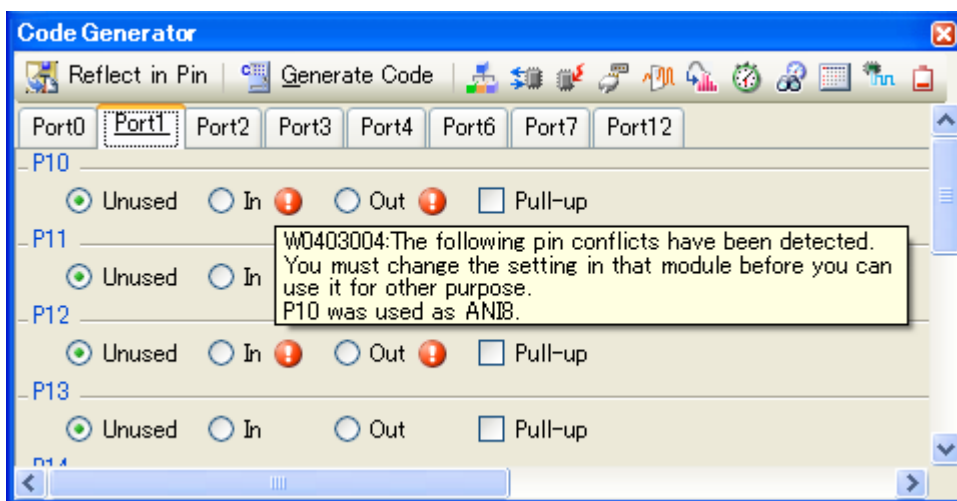
To confirm the source code, use the [Code Generator Preview panel](#) that opens by selecting [View] menu >> [Code Generator Preview].

Figure 3-4. Confirm Source Code

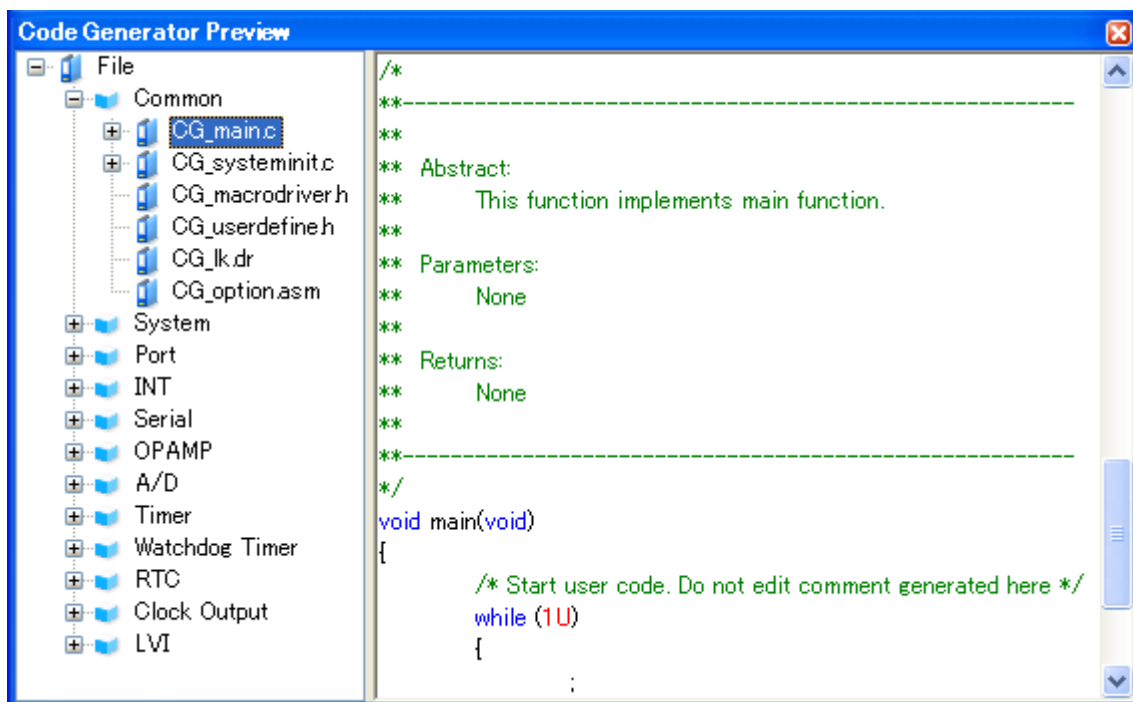

- Remarks 1.** You can change the source code to be displayed by selecting the source file name or API function name in the [Code Generator Preview panel](#).
- 2.** The following table displays the meaning of the color of the source code text displayed in the [Code Generator Preview panel](#).

Table 3-3. Color of Source Code

| Color | Outline                      |
|-------|------------------------------|
| Green | Comment                      |
| Blue  | Reserved word for C compiler |
| Red   | Numeric value                |
| Black | Code section                 |
| Gray  | File name                    |

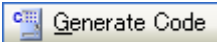
- 3.** You cannot edit the source code within the [Code Generator Preview panel](#).
- 4.** For some of the API functions (such as API functions for serial array units), values such as the SFR register value are calculated and finalized when the source code is generated (when the  button on the [Code Generator panel](#) is pressed). For this reason, the source code displayed in the [Code Generator Preview panel](#) may not be the same as that would actually be generated.

### 3.5 Output Source Code

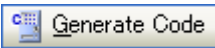
Output the source code (device driver program) by pressing the  button on the [Code Generator panel](#).

The destination folder for the source code is specified by clicking [\[Generation\] tab](#) >> [Output folder] in the [Property panel](#).

Figure 3-5. Output Source Code

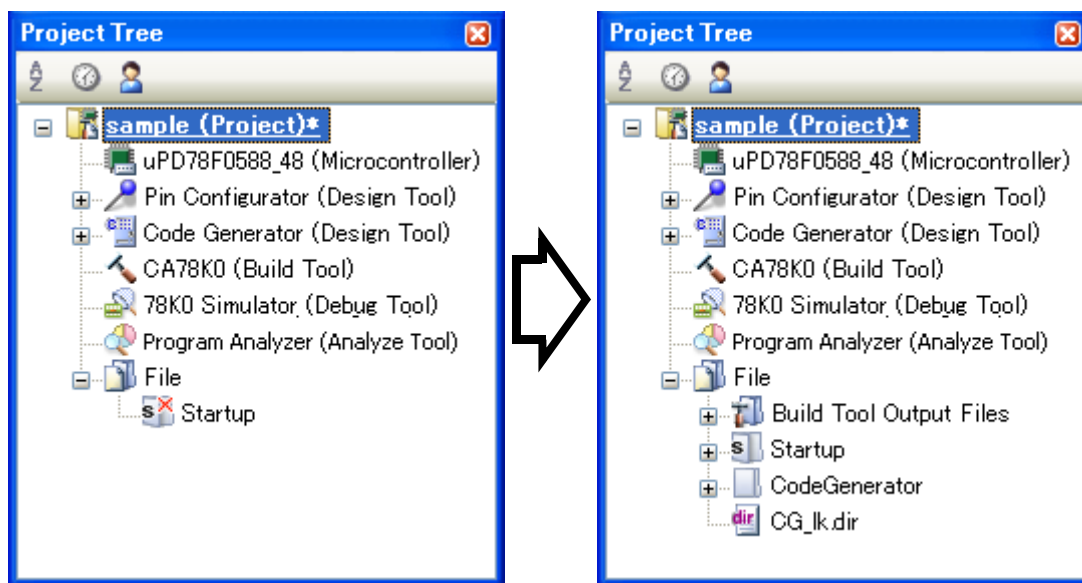

**Remark** In order to both output source files and add them to the project (display the corresponding source file names in the [Project Tree panel](#)) when you click the  button, you must open the [Property panel](#), and under [\[Generation\] tab](#) >> [Register files], specify "Output files to project".

Figure 3-6. Configure Whether to Register



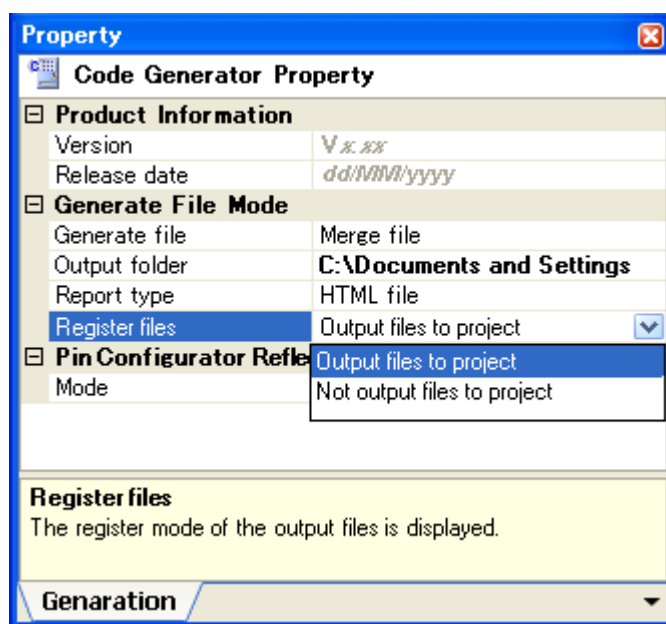

3.5.1 Setting that determines whether or not to generate source code

You can set whether or not to generate the corresponding source code on a per-API function basis by selecting [Generate code/Not generate code] from the context menu displayed by right clicking the API function name in the [Code Generator Preview panel](#).

Figure 3-7. Setting That Determines Whether or Not to Generate Source Code

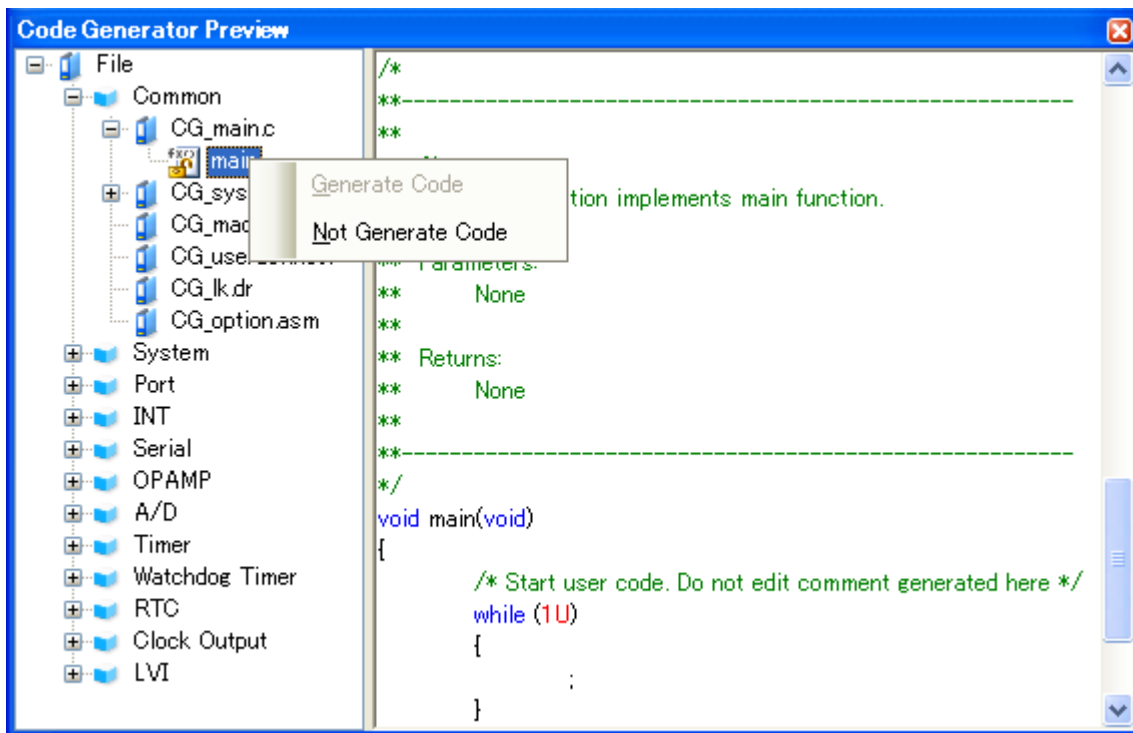

**Remark** You can confirm the current setting for the generation of source code by checking the type of icon in the [Code Generator Preview panel](#).

Table 3-4. Setting That Determines Whether or Not to Generate Source Code

| Type of Icon | Outline   |
|--------------|---|
|              | Source code for the currently selected API function is generated.<br>If this icon is displayed next to the API function, the corresponding source code must be generated (it is impossible to change the icon to ). |
|              | Source code for the currently selected API function is generated.   |
|              | Source code for the currently selected API function is not generated.   |

### 3.5.2 Change file name

The Code Generator is used to change the file name by selecting [Rename] from the context menu displayed by right clicking the file name in the [Code Generator Preview](#) panel.

Figure 3-8. Change File Name

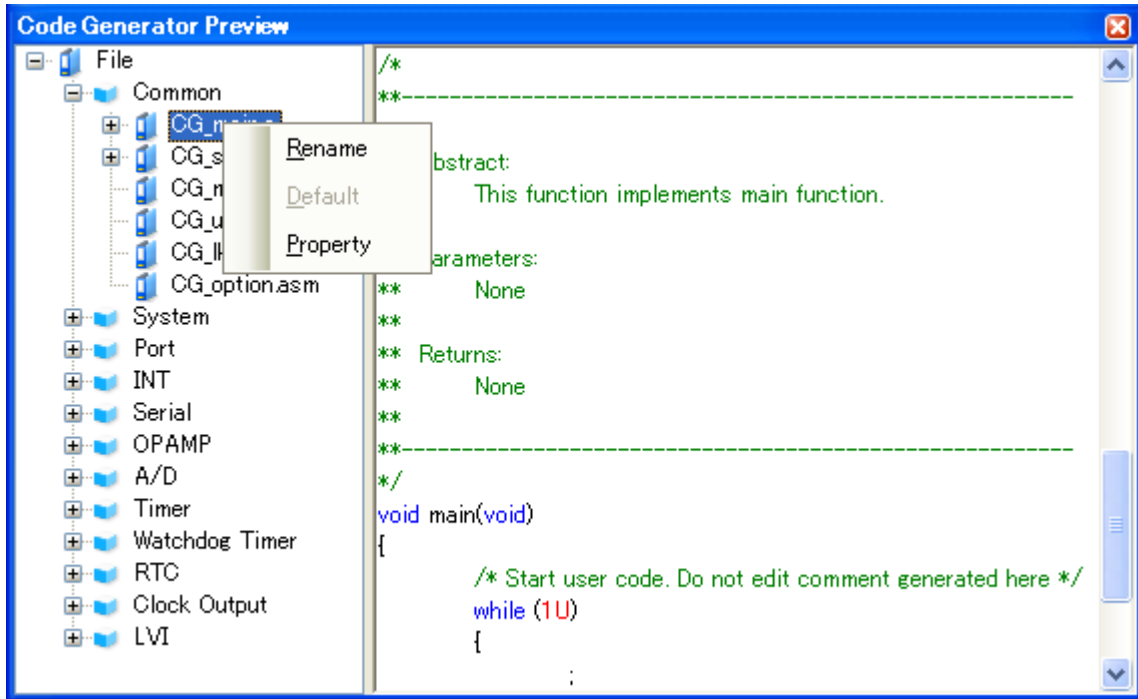

**Remark** To restore the default file name defined by Code Generator, select [Default] from the context menu.

3.5.3 Change API function name

The Code Generator is used to change the name of the API function by selecting [Rename] from the context menu displayed by right clicking the API function name in the [Code Generator Preview panel](#).

Figure 3-9. Change API Function Name

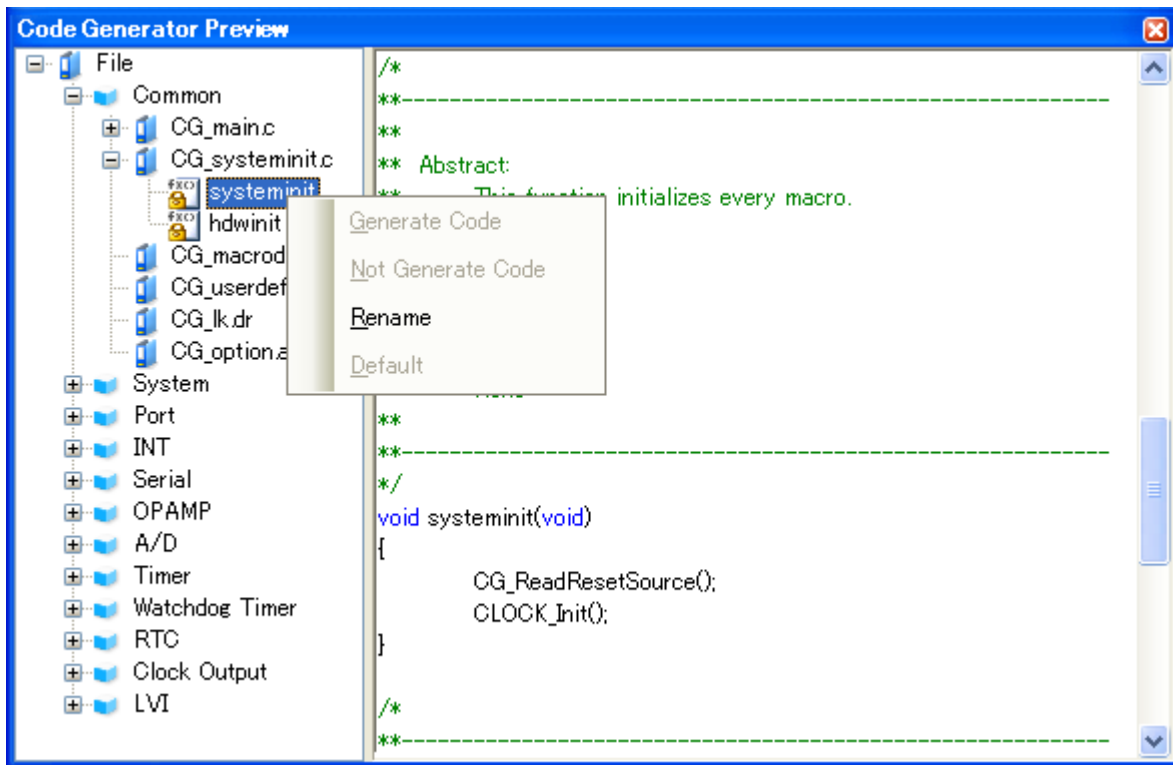

**Remark** To restore the default name of the API function defined by Code Generator, select [Default] from the context menu.

3.5.4 Change output mode

The Code Generator is used to change the output mode (Overwrite file, Merge file, Do nothing if file exists) for the source code by selecting [Generation] tab >> [Generate file] in the Property panel.

Figure 3-10. Change Output Mode

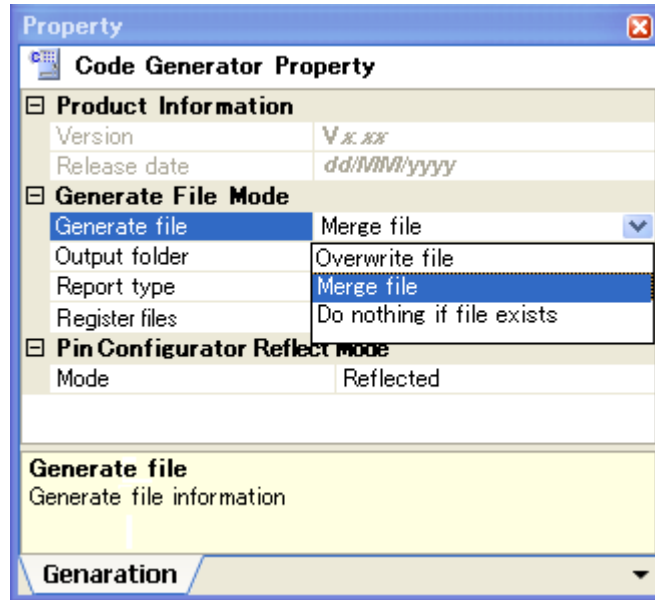

**Remark** The output mode is selected from the following three types.

Table 3-5. Output Mode of Source Code

| Output Mode              | Outline  |
|--------------------------|--|
| Overwrite file           | If a file with the same name exists, the existing file is overwritten by a new file.   |
| Merge file               | If a file with the same name exists, a new file is merged with the existing file.<br>Only the section between "/* Start user code ... . Do not edit comment generated here */" and "/* End user code. Do not edit comment generated here */" will be merged. |
| Do nothin if file exists | If a file with the same name exists, a new file will not be output.  |

### 3.5.5 Change output destination folder

The Code Generator is used to change the output destination folder for the source code by selecting [\[Generation\] tab](#) >> [\[Output folder\]](#) in the [Property panel](#).

To change the output destination, use the [Browse For Folder dialog box](#) which opens by pressing the [\[...\]](#) button in the [\[Output folder\]](#).

Figure 3-11. Change Output Destination Folder



3.6 Output Report Files

Output report files (a file containing information configured using Code Generator and a file containing information regarding the source code) by first activating the [Code Generator panel](#) or [Code Generator Preview panel](#), then selecting [File] menu >> [Save Code Generator Report].

The destination folder for the report file is specified by clicking [[Generation](#)] tab >> [Output folder] in the [Property panel](#).

**Remarks 1.** You can only use "macro" or "function" as a name of the report file.

**Table 3-6. Output Report Files**

| File Name | Outline  |
|-----------|--|
| macro     | A file that contains the information configured using Code Generator |
| function  | A file that contains the information regarding the source code       |

- The output mode for the report file is fixed to "Overwrite file".

**Figure 3-12. Output Example of Report File "macro"**

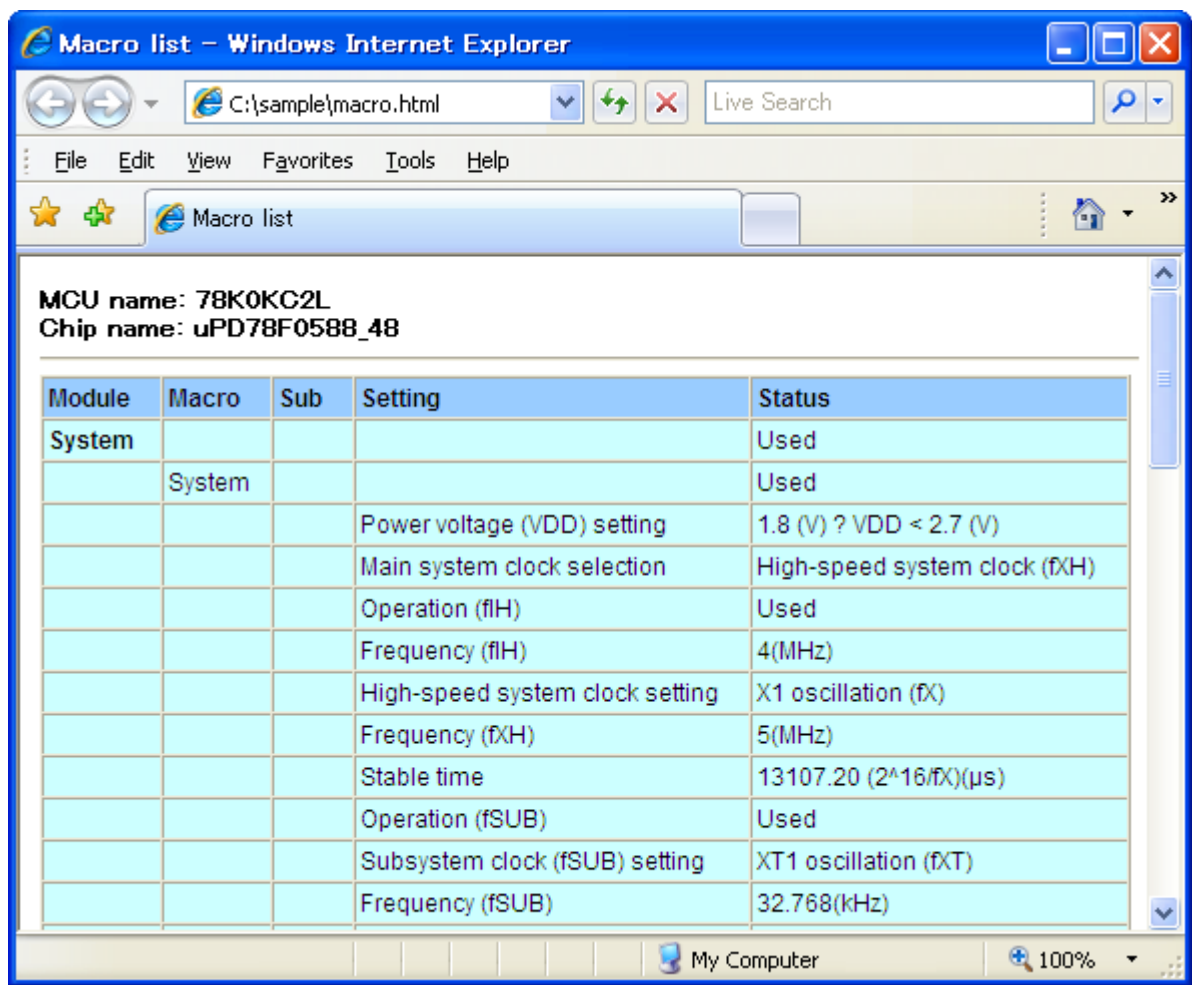
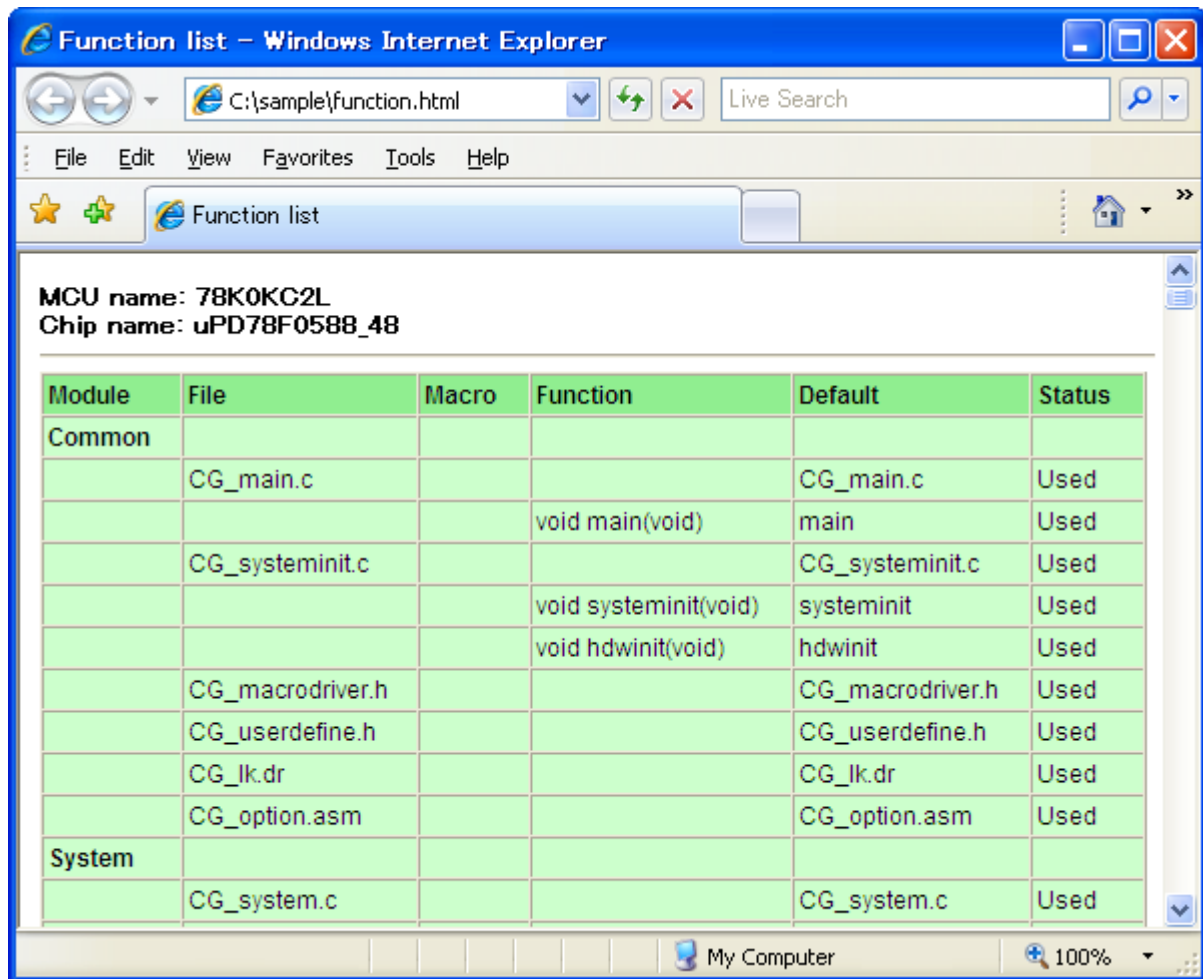

Figure 3-13. Output Example of Report File "function"



3.6.1 Change output format

The Code Generator is used to change the output format (HTML file or CSV file) of the report file by selecting [Generation] tab >> [Report type] in the Property panel.

Figure 3-14. Change Output Format

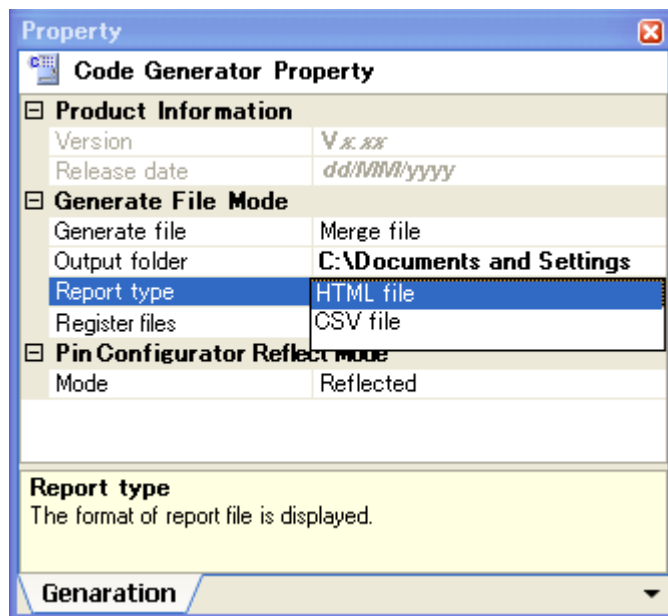

**Remark** Output format is selected from the following two types.

Table 3-7. Output Mode of Source Code

| Report Type | Outline                               |
|-------------|---------------------------------------|
| HTML file   | Outputs a report file in HTML format. |
| CSV file    | Outputs a report file in CSV format.  |



### 3.6.2 Change output destination

The Code Generator is used to change the output destination folder for the report file by selecting [\[Generation\] tab >> \[Output folder\]](#) in the [Property panel](#).

To change the output destination, use the [Browse For Folder dialog box](#) which opens by pressing the [...] button in the [Output folder].

Figure 3-15. Change Output Destination

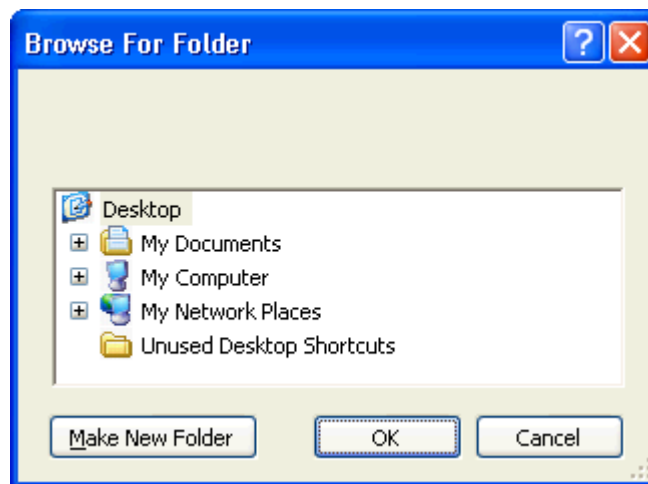

## APPENDIX A WINDOW REFERENCE

This appendix explains in detail the functions of the windows, panels and dialog boxes of the design tool.

### A.1 Description

The design tool has the following windows, panels and dialog boxes.

**Table A-1. Window/Panel/Dialog Box List**

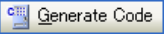
| Window/Panel/Dialog Box Name | Function  |
|------------------------------|---|
| Main window                  | This is the first window to open when CubeSuite+ is launched. This window is used to operate various components (design tool, build tool, etc.) provided by CubeSuite+.   |
| Project Tree panel           | This panel displays the components of the project (microcontroller, design tool, build tool, etc.) in a tree structure.   |
| Property panel               | This panel allows you to view the information and change the setting for the node selected in the <a href="#">Project Tree panel</a> , the peripheral function button pressed in the <a href="#">Code Generator panel</a> or the file selected in the <a href="#">Code Generator Preview panel</a> .  |
| Device Pin List panel        | This panel allows you to enter information on each pin of the microcontroller.  |
| Device Top View panel        | This panel displays the information entered in the <a href="#">Device Pin List panel</a> .  |
| Code Generator panel         | This panel allows you to configure the information necessary to control the peripheral functions provided by the microcontroller.   |
| Code Generator Preview panel | This panel allows you to confirm or configure on a per-API function basis the setting that determines whether or not the source code (device driver program) is generated when the  button is pressed in the <a href="#">Code Generator panel</a> . It also allows you to confirm the source code that reflects the information configured in the <a href="#">Code Generator panel</a> . |
| Output panel                 | This panel displays operation logs for various components (design tool, build tool, etc.) provided by CubeSuite+.   |
| Column Chooser dialog box    | This dialog box allows you to choose whether or not to display the item listed in this dialog box in the device pin list, and add columns to or delete columns from the device pin list.  |
| New Column dialog box        | This dialog box allows you to add your own column to the device pin list.   |
| Browse For Folder dialog box | This dialog box allows you to specify the output destination for files (source code, report file, etc.).  |
| Save As dialog box           | This dialog box allows you to name and save a file (such as a report file).   |

**Main window**

This is the first window to open when CubeSuite+ is launched. This window is used to operate various components (design tool, build tool, etc.) provided by CubeSuite+.

Figure A-1. Main Window

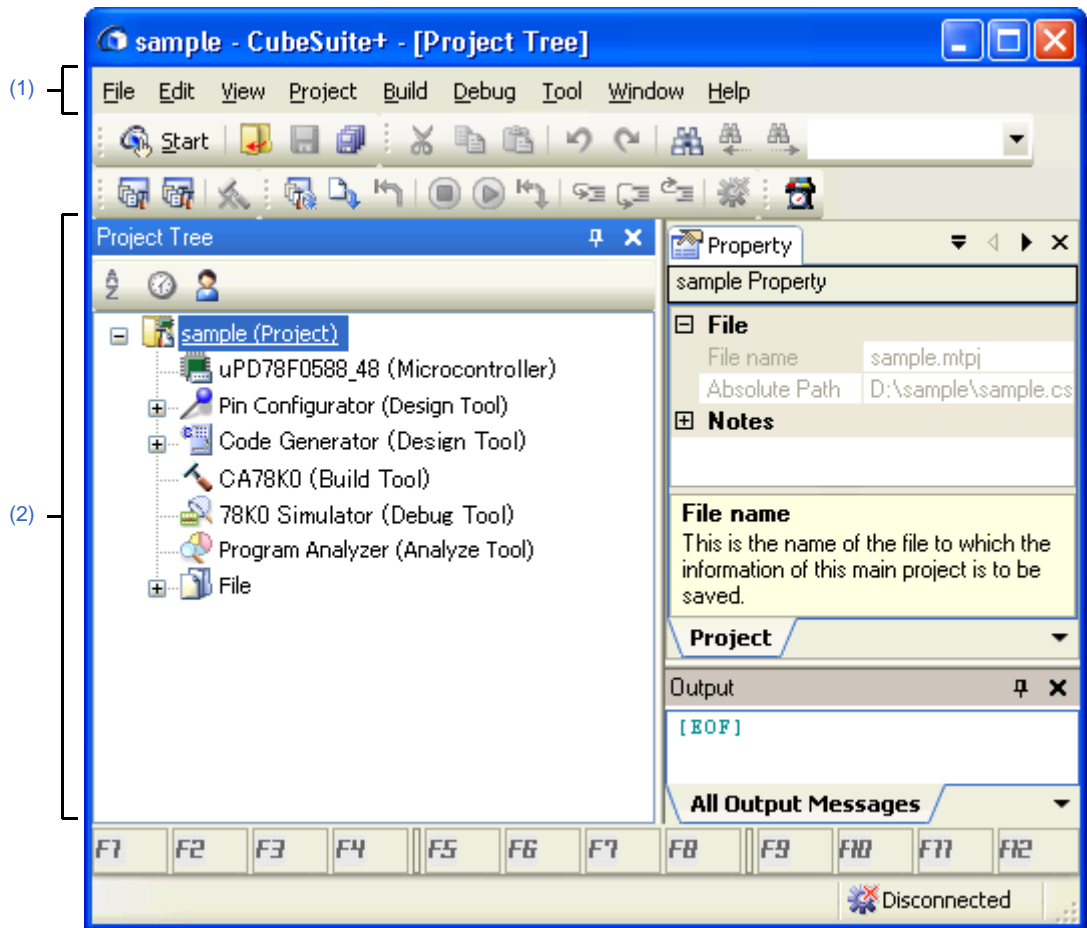

The following items are explained here.

- [\[How to open\]](#)
- [\[Description of each area\]](#)

**[How to open]**

- From the [start] menu, select [All Programs] >> [Renesas Electronics CubeSuite+] >>[CubeSuite+].

**[Description of each area]**

**(1) Menu bar**

This area consists of the following menu items.

## (a) [File] menu

|                                    |   |
|------------------------------------|---|
| Save Pin List                      | <a href="#">Device Pin List panel</a> -dedicated item<br>Saves a report file (a file containing information configured using Pin Configurator: device pin list) overwriting the existing file.  |
| Save Pin List As...                | <a href="#">Device Pin List panel</a> -dedicated item<br>Opens the <a href="#">Save As dialog box</a> for naming and saving a report file (a file containing information configured using Pin Configurator: device pin list).   |
| Save Top View                      | <a href="#">Device Top View panel</a> -dedicated item<br>Saves a report file (a file containing information configured using Pin Configurator: device top view) overwriting the existing file.  |
| Save Top View As...                | <a href="#">Device Top View panel</a> -dedicated item<br>Opens the <a href="#">Save As dialog box</a> for naming and saving a report file (a file containing information configured using Pin Configurator: device top view).   |
| Save Code Generator Report         | <a href="#">Code Generator panel</a> / <a href="#">Code Generator Preview panel</a> -dedicated item<br>Outputs report files (a file containing information configured using Code Generator and a file containing information regarding the source code).<br><br>- The output format for the report file (either HTML or CSV) is selected by clicking <a href="#">[Generation] tab</a> >> <a href="#">[Report type]</a> in the <a href="#">Property panel</a> .<br>- The destination folder for the report file is specified by clicking <a href="#">[Generation] tab</a> >> <a href="#">[Output folder]</a> in the <a href="#">Property panel</a> . |
| Save Output- <i>Tab Name</i>       | <a href="#">Output panel</a> -dedicated item<br>Saves the message corresponding to the specified tab overwriting the existing file.   |
| Save Output- <i>Tab Name</i> As... | <a href="#">Output panel</a> -dedicated item<br>Opens the <a href="#">Save As dialog box</a> for naming and saving the message corresponding to the specified tab.  |

## (b) [Edit] menu

|            |  |
|------------|--|
| Undo       | <a href="#">Property panel</a> -dedicated item<br>Cancels the effect of an edit operation to restore the previous state.   |
| Cut        | <a href="#">Property panel</a> -dedicated item<br>Sends the character string or lines selected with range selection to the clipboard and deletes them.   |
| Copy       | <a href="#">Property panel</a> / <a href="#">Output panel</a> -dedicated item<br>Sends the character string or lines selected with range selection to the clipboard.   |
| Paste      | <a href="#">Property panel</a> -dedicated item<br>Inserts the contents of the clipboard at the caret position.   |
| Delete     | <a href="#">Property panel</a> -dedicated item<br>Deletes the character string or the lines selected with the range selection.   |
| Select All | <a href="#">Property panel</a> / <a href="#">Output panel</a> -dedicated item<br>Selects all the strings displayed in the item being edited or all the strings displayed in the <a href="#">Message area</a> . |

|            |  |
|------------|--|
| Search...  | <a href="#">Device Pin List panel</a> / <a href="#">Code Generator Preview panel</a> / <a href="#">Output panel</a> -dedicated item<br>Opens the Search and Replace dialog box for searching strings with the [Quick Search] tab selected. |
| Replace... | <a href="#">Output panel</a> -dedicated item<br>Opens the Search and Replace dialog box for replacing strings with the [Whole Replace] tab selected.   |

**(c) [Help] menu**

|  |   |
|--|---|
| Open Help for Project Tree Panel           | <a href="#">Project Tree panel</a> -dedicated item<br>Displays the help of <a href="#">Project Tree panel</a> .                     |
| Open Help for Property Panel               | <a href="#">Property panel</a> -dedicated item<br>Displays the help of <a href="#">Property panel</a> .                             |
| Open Help for Device Pin List Panel        | <a href="#">Device Pin List panel</a> -dedicated item<br>Displays the help of <a href="#">Device Pin List panel</a> .               |
| Open Help for Device Top View Panel        | <a href="#">Device Top View panel</a> -dedicated item<br>Displays the help of <a href="#">Device Top View panel</a> .               |
| Open Help for Code Generator Panel         | <a href="#">Code Generator panel</a> -dedicated item<br>Displays the help of <a href="#">Code Generator panel</a> .                 |
| Open Help for Code Generator Preview Panel | <a href="#">Code Generator Preview panel</a> -dedicated item<br>Displays the help of <a href="#">Code Generator Preview panel</a> . |
| Open Help for Output Panel                 | <a href="#">Output panel</a> -dedicated item<br>Displays the help of <a href="#">Output panel</a> .                                 |

**(2) Panel display area**

This area consists of multiple panels, each dedicated to a different purpose.

See the following sections for details on this area.

- [Project Tree panel](#)
- [Property panel](#)
- [Device Pin List panel](#)
- [Device Top View panel](#)
- [Code Generator panel](#)
- [Code Generator Preview panel](#)
- [Output panel](#)

## Project Tree panel

This panel displays components of the project (microcontroller, design tool, build tool, etc.) in a tree structure.

Figure A-2. Project Tree Panel

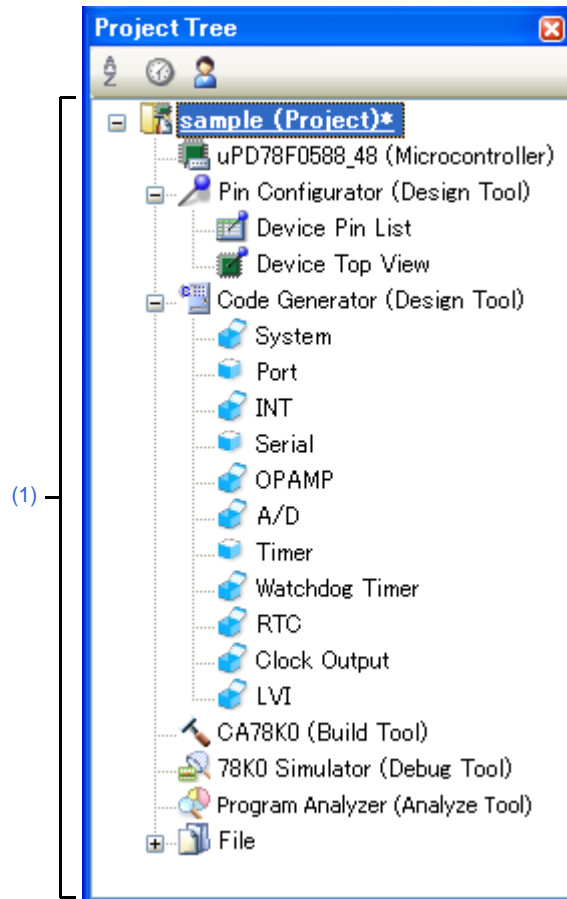

The following items are explained here.

- [How to open]
- [Description of each area]
- [[Help] menu (Project Tree panel-dedicated items)]
- [Context menu]

### [How to open]

- From the [View] menu, select [Project Tree].

### [Description of each area]

#### (1) Project tree area

This area displays components of the project (microcontroller, design tool, build tool, etc.) in a tree structure.

##### (a) Pin Configurator (Design Tool)

This node consists of the following pin nodes.

|                 |  |
|-----------------|--|
| Device Pin List | Opens the <a href="#">Device Pin List panel</a> for entering information on the pins of the microcontroller.                         |
| Device Top View | Opens the <a href="#">Device Top View panel</a> that displays the information entered in the <a href="#">Device Pin List panel</a> . |

**(b) Code Generator (Design Tool)**



This node consists of the following peripheral function nodes.

When there is peripheral function target microcontroller is not supporting, peripheral function button is not displayed.

|                       |   |
|-----------------------|---|
| System                | Opens the [System] for configuring the information necessary to control the functions of clock generator, on-chip debug function and etc. provided by the microcontroller.      |
| Port                  | Opens the [Port] for configuring the information necessary to control the port functions provided by the microcontroller.   |
| INT                   | Opens the [INT] for configuring the information necessary to control the interrupt functions and the key interrupt function provided by the microcontroller.                    |
| Serial                | Opens the [Serial] for configuring the information necessary to control the functions of serial array unit and functions of serial interface provided by the microcontroller.   |
| Operational Amplifier | Opens the [Operational Amplifier] for configuring the information necessary to control the functions of comparator/programmable gain amplifier provided by the microcontroller. |
| Comparator            | Opens the [Comparator] for configuring the information necessary to control the functions of comparator provided by the microcontroller.  |
| A/D                   | Opens the [A/D] for configuring the information necessary to control the function of A/D converter provided by the microcontroller.   |
| Timer                 | Opens the [Timer] for configuring the information necessary to control the functions of timer array unit provided by the microcontroller.                                       |
| Watchdog Timer        | Opens the [Watchdog Timer] for configuring the information necessary to control the functions of watchdog timer provided by the microcontroller.                                |
| RTC                   | Opens the [RTC] for configuring the information necessary to control the functions of real-time counter provided by the microcontroller.  |
| Clock Output          | Opens the [Clock Output] for configuring the information necessary to control the functions of clock output controller provided by the microcontroller.                         |
| LVI                   | Opens the [LVI] for configuring the information necessary to control the functions of low-voltage detector provided by the microcontroller.                                     |

**(c) Icons**

The table below displays the meaning of the icon displayed to the left of the string representing the peripheral function node.

|   |   |
|---|---|
|  | Operation in the corresponding <a href="#">Code Generator panel</a> has been carried out.                     |
|  | Operation in the corresponding <a href="#">Code Generator panel</a> has not been carried out.                 |
|  | The problem occurs on the settings because the manipulation to the other peripheral function node influences. |

**[[Help] menu (Project Tree panel-dedicated items)]**

|                                  |                                  |
|----------------------------------|----------------------------------|
| Open Help for Project Tree Panel | Displays the help of this panel. |
|----------------------------------|----------------------------------|

**[Context menu]**

The following context menu items are displayed by right clicking the mouse.

|                       |   |
|-----------------------|---|
| Return to Reset Value | Restores the information for the selected peripheral function node to its default state.  |
| Property              | Opens the <a href="#">Property panel</a> containing the information for the selected node ([Pin Configurator (Design Tool)] or [Code Generator (Design Tool)]). |



## Property panel

This panel allows you to view the information on and change the setting for the node selected in the [Project Tree panel](#), the peripheral function button pressed in the [Code Generator panel](#) or the file selected in the [Code Generator Preview panel](#).

Figure A-3. Property Panel (Selected [Pin Configurator (Design Tool)])

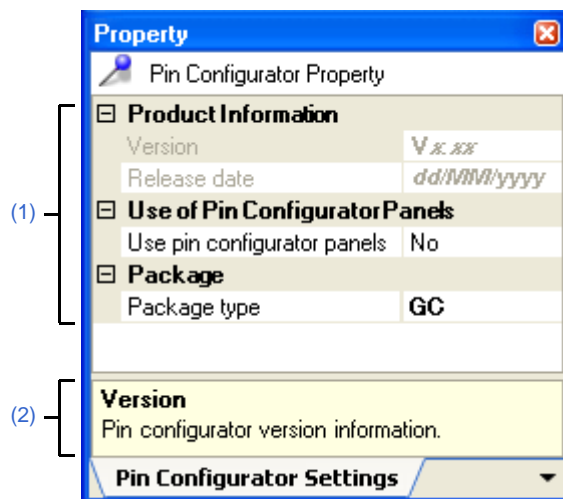



The following items are explained here.



- [\[How to open\]](#)
- [\[Description of each area\]](#)
- [\[\[Edit\] menu \(Property panel-dedicated items\)\]](#)
- [\[\[Help\] menu \(Property panel-dedicated items\)\]](#)
- [\[Context menu\]](#)

### [How to open]



- On the [Project Tree panel](#), select a node ([Pin Configurator (Design Tool)], [Device Pin List], [Device Top View], [Code Generator (Design Tool)], peripheral function node "[System], [Port], etc."), and then select [Property] from the [View] menu.
- On the [Project Tree panel](#), select a node ([Pin Configurator (Design Tool)], [Device Pin List], [Device Top View], [Code Generator (Design Tool)], peripheral function node "[System], [Port], etc."), and then select [Property] from the context menu.
- On the [Code Generator Preview panel](#), select a file, and then select [Property] from the [View] menu.
- On the [Code Generator Preview panel](#), select a file, and then select [Property] from the context menu.



- Remarks 1.** If this panel is already open, selecting a different node ([Pin Configurator (Design Tool)], [Device Pin List], [Device Top View], [Code Generator (Design Tool)] or peripheral function node "[System], [Port], etc.") in the [Project Tree panel](#) changes the content displayed in the [Detail information display/change area](#) and [Explanation area](#) accordingly.
2. If this panel is already open, pressing a different peripheral function button " ,  , etc." in the [Code Generator panel](#) changes the content displayed in the [Detail information display/change area](#) and [Explanation area](#) accordingly.
  3. If this panel is already open, selecting a different file in the [Code Generator Preview panel](#) changes the content displayed in the [Detail information display/change area](#) and [Explanation area](#) accordingly.

**[Description of each area]****(1) Detail information display/change area**



This area allows you to view the information on and change the setting for the node ([Pin Configurator (Design Tool)], [Device Pin List], [Device Top View], [Code Generator (Design Tool)] or peripheral function node "[System], [Port], etc.) selected in the [Project Tree panel](#), the peripheral function button " ,  , etc." pressed in the [Code Generator panel](#), or the file selected in the [Code Generator Preview panel](#).

The content displayed in this area differs depending on the node selected in the [Project Tree panel](#), the peripheral function button pressed in the [Code Generator panel](#) or the file selected in the [Code Generator Preview panel](#).

The following table displays the meaning of  and  displayed to the left of each category.

|   |   |
|---|---|
|  | Indicates that the items within the category are displayed as a "collapsed view". |
|  | Indicates that the items within the category are displayed as an "expanded view". |

**Remarks 1.** See the sections "[\[Pin Configurator Settings\] tab](#)", "[\[Pin Configurator Information\] tab](#)", "[\[Device Top View Settings\] tab](#)", "[\[Generation\] tab](#)", "[\[Macro Setting\] tab](#)" and "[\[File Setting\] tab](#)" for details on the content displayed in this area.

2. To switch between  and  , click this mark or double-click the category name.

**(2) Explanation area**

This area displays a "brief description" of the category or item selected in the [Detail information display/change area](#).

**[[Edit] menu (Property panel-dedicated items)]**

|            |  |
|------------|--|
| Undo       | Cancels the effect of an edit operation to restore the previous state.                               |
| Cut        | Sends the character string or lines selected with range selection to the clipboard and deletes them. |
| Copy       | Sends the character string or lines selected with range selection to the clipboard.                  |
| Paste      | Inserts the contents of the clipboard at the caret position.   |
| Delete     | Deletes the character string or the lines selected with the range selection.                         |
| Select All | Selects all strings displayed in the item being edited.  |

**[[Help] menu (Property panel-dedicated items)]**

|                              |                                  |
|------------------------------|----------------------------------|
| Open Help for Property Panel | Displays the help of this panel. |
|------------------------------|----------------------------------|

**[Context menu]**

The following context menu items are displayed by right clicking the mouse.

**(1) While the item is being edited**

|      |  |
|------|--|
| Undo | Cancels the effect of an edit operation to restore the previous state.                               |
| Cut  | Sends the character string or lines selected with range selection to the clipboard and deletes them. |

|            |   |
|------------|---|
| Copy       | Sends the character string or lines selected with range selection to the clipboard. |
| Paste      | Inserts the contents of the clipboard at the caret position.                        |
| Delete     | Deletes the character string or the lines selected with the range selection.        |
| Select All | Selects all strings displayed in the item being edited.                             |

**(2) While the item is not being edited**

|                               |  |
|-------------------------------|--|
| Property Reset to Default     | Restores the selected item to its default state. |
| Property Reset All to Default | Restores all items to their default state.       |

**[Pin Configurator Settings] tab**

This tab displays information (Product Information, Use of Pin Configurator Panels and Package) on the [Pin Configurator (Design Tool)] selected in the [Project Tree panel](#).

**Figure A-4. [Pin Configurator Settings] Tab**

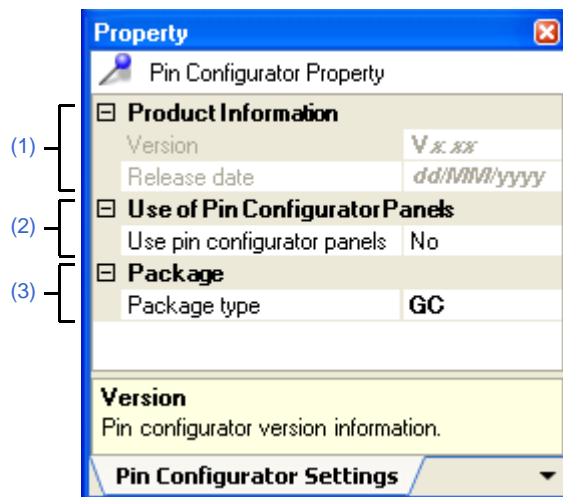

The following items are explained here.

- [\[How to open\]](#)
- [\[Description of each area\]](#)

**[How to open]**

- On the [Project Tree panel](#), select [*Project name* (Project)] >> [Pin Configurator (Design Tool)], and then select [Property] from the [View] menu.
- On the [Project Tree panel](#), select [*Project name* (Project)] >> [Pin Configurator (Design Tool)], and then select [Property] from the context menu.

**Remark** If this panel is already open, selecting a different [Pin Configurator (Design Tool)] in the [Project Tree panel](#) changes the content displayed accordingly.

**[Description of each area]**

**(1) [Product Information] category**

This area displays product information (Version and Release date) on Pin Configurator.

|              |  |
|--------------|--|
| Version      | Displays the version of Pin Configurator.      |
| Release date | Displays the release date of Pin Configurator. |

**(2) [Use of Pin Configurator Panels] category**

Select whether to show the [Device Pin List panel](#) and [Device Top View panel](#).

|                             |   |  |
|-----------------------------|---|--|
| Use pin configurator panels | Selects whether to display the <a href="#">Device Pin List panel</a> and <a href="#">Device Top View panel</a> in the <a href="#">Main window</a> the next time this project is opened. |  |
|                             | Yes   | Displays the <a href="#">Device Pin List panel</a> and <a href="#">Device Top View panel</a> . |
|                             | No  | Hides the <a href="#">Device Pin List panel</a> and <a href="#">Device Top View panel</a> .    |

**(3) [Package] category**

Change the shape (package type) and settings of the microcontroller to display as the device top view in the [Device Top View panel](#).

|              |  |
|--------------|--|
| Package type | Selects the shape of the microcontroller displayed in the device top view. |
|--------------|--|

**[Pin Configurator Information] tab**

This tab displays information (Product information) on the [Device Pin List] selected in the [Project Tree panel](#).

**Figure A-5. [Pin Configurator Information] Tab**

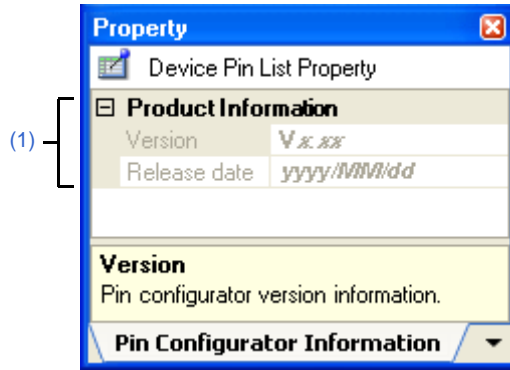

The following items are explained here.

- [\[How to open\]](#)
- [\[Description of each area\]](#)

**[How to open]**

- On the [Project Tree panel](#), select [*Project name* (Project)] >> [Pin Configurator (Design Tool)] >> [Device Pin List], and then select [Property] from the [View] menu.
- On the [Project Tree panel](#), select [*Project name* (Project)] >> [Pin Configurator (Design Tool)] >> [Device Pin List], and then select [Property] from the context menu.

**Remark** If this panel is already open, selecting a different [Device Pin List] in the [Project Tree panel](#) changes the content displayed accordingly.

**[Description of each area]**

**(1) [Product Information] category**

This area displays product information (Version and Release date) on Pin Configurator.

|              |  |
|--------------|--|
| Version      | Displays the version of Pin Configurator.      |
| Release date | Displays the release date of Pin Configurator. |

**[Device Top View Settings] tab**

This tab allows you to view the information (Color, Tool Tip and Pin Name Display) on and change the setting for the [Device Top View] selected in the [Project Tree panel](#).

Figure A-6. [Device Top View Settings] Tab

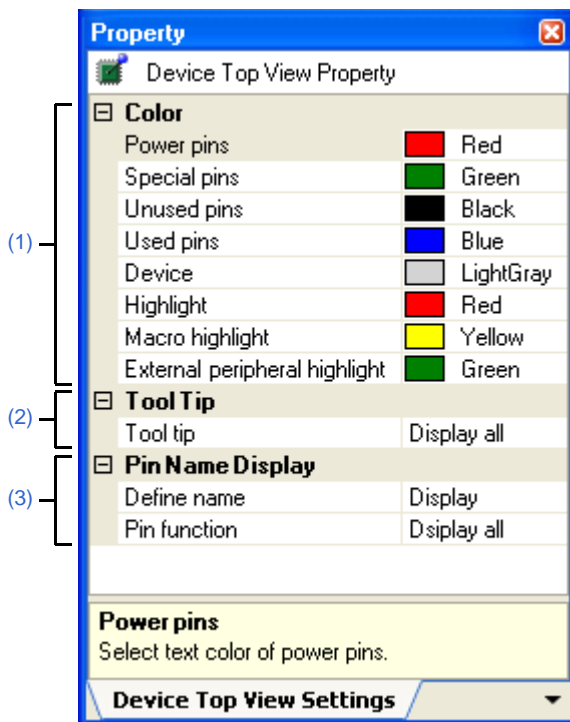

The following items are explained here.

- [\[How to open\]](#)
- [\[Description of each area\]](#)

**[How to open]**

- On the [Project Tree panel](#), select [*Project name* (Project)] >> [Pin Configurator (Design Tool)] >> [Device Top View], and then select [Property] from the [View] menu.
- On the [Project Tree panel](#), select [*Project name* (Project)] >> [Pin Configurator (Design Tool)] >> [Device Top View], and then select [Property] from the context menu.

**Remark** If this panel is already open, selecting a different [Device Top View] in the [Project Tree panel](#) changes the content displayed accordingly.

**[Description of each area]**

**(1) [Color] category**

Select the display colors to differentiate the pin groups (power pins, special pins, unused pins, etc.) in the device top view.

|            |  |
|------------|--|
| Power pins | Selects the display color for power pins (pins whose use is limited to power). |
|------------|--|

|                               |   |
|-------------------------------|---|
| Special pins                  | Selects the display color for special pins (pins with specified uses).  |
| Unused pins                   | Selects the display color for unused pins (dual-use pins with no use set in the <a href="#">Device Pin List panel</a> ).                        |
| Used pins                     | Selects the display color for used pins (dual-use pins with a use set in the <a href="#">Device Pin List panel</a> ).                           |
| Device                        | Selects the display color of the microcontroller.   |
| Highlight                     | Selects the background color of a pin selected in the <a href="#">Device Pin List panel</a> , on the <a href="#">[Pin Number] tab</a> .         |
| Macro highlight               | Selects the background color of pins selected in the <a href="#">Device Pin List panel</a> , on the <a href="#">[Macro] tab</a> .               |
| External peripheral highlight | Selects the background color of pins selected in the <a href="#">Device Pin List panel</a> , on the <a href="#">[External Peripheral] tab</a> . |

**Remark** To change the setting of the color, use the following color palette which opens by making a selection from the dropdown list in this area.

**Figure A-7. Color Palette**

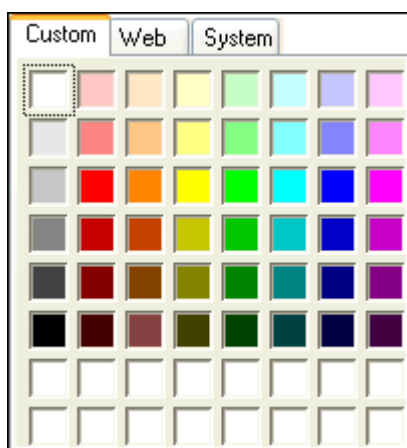

**(2) [Tool Tip] category**

Select whether to display a tooltip with information about a pin when the mouse cursor is moved over the pin in the device top view.

|          |   |   |
|----------|---|---|
| Tool tip | Selects whether to display a tooltip with information about a pin when the mouse cursor is moved over the pin in the device top view panel. |   |
|          | Display all   | Displays the "Description", "Recommend Connection For Unused", and "Attention" strings for the device pin list. |
|          | Description / recommended connection for unused pin only  | Displays the "Description", and "Recommend Connection For Unused" string for the device pin list.               |
|          | Attention only  | Displays the "Attention" string for the device pin list.  |
|          | Not display   | Hides tooltips when the mouse cursor hovers over a pin.   |



(3) [Pin Name Display] category

Select whether to display additional information about the pin in the device top view.

|              |  |  |
|--------------|--|--|
| Define name  | Selects whether to display the "Define Name" string of the device pin list appended to the pin in the device top view.                                       |  |
|              | Display  | Displays the "Define Name" string of the device pin list in appended format.                         |
|              | Not display  | Hides the "Define Name" string of the device pin list.   |
| Pin function | Selects whether to also display unselected functions in the device top view when a function has been selected from the device pin list's "Function" feature. |  |
|              | Display all  | Displays functions selected via the device pin list's "Function" feature in parentheses.             |
|              | Selected function only   | Only display functions selected via the device pin list's "Function" feature in the device top view. |

**[Generation] tab**

This tab allows you to view the information (Product Information, Generate File Mode and Pin Configurator Reflect Mode) on and change the setting for the [Code Generator (Design Tool)] selected in the [Project Tree panel](#).

Figure A-8. [Generation] Tab

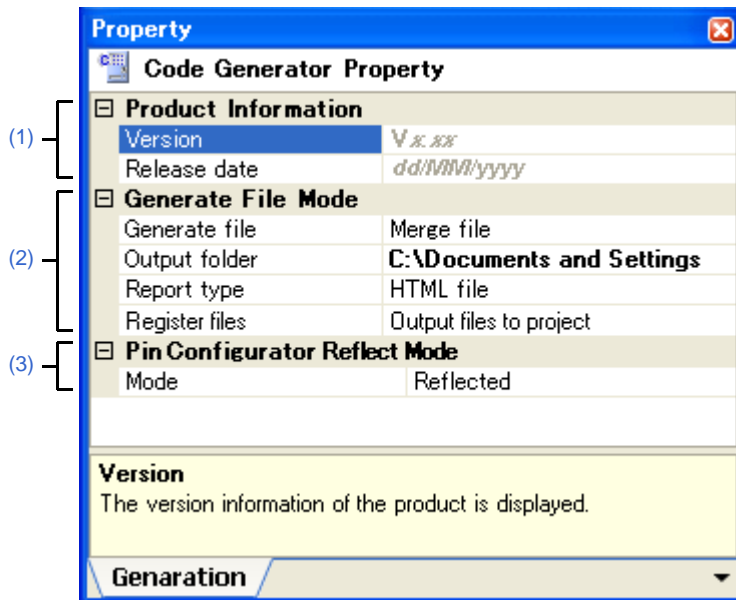

The following items are explained here.

- [\[How to open\]](#)
- [\[Description of each area\]](#)

**[How to open]**

- On the [Project Tree panel](#), select [*Project name* (Project)] >> [Code Generator (Design Tool)], and then select [Property] from the [View] menu.
- On the [Project Tree panel](#), select [*Project name* (Project)] >> [Code Generator (Design Tool)], and then select [Property] from the context menu.

**Remark** If this panel is already open, selecting a different [Code Generator (Design Tool)] in the [Project Tree panel](#) changes the content displayed accordingly.

**[Description of each area]**



**(1) [Product Information] category**

This area displays product information (Version and Release date) on Code Generator.

|              |  |
|--------------|--|
| Version      | Displays the version of Code Generator.      |
| Release date | Displays the release date of Code Generator. |

(2) [Generate File Mode] category

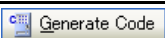
This area allows you to view and change the setting for the file generation mode (Generate file, Output folder, Report type and Register files) of Code Generator.

|                |  |  |
|----------------|--|--|
| Generate file  | Views or selects the operation mode applied when the  button is pressed.<br>Operation mode applied when you select [File] menu >> [Save Code Generator Report] is fixed to "Overwrite file".          |  |
|                | Overwrite file   | If a file with the same name exists, the existing file is overwritten by a new file.   |
|                | Merge file   | If a file with the same name exists, a new file is merged with the existing file.<br>Only the section between "/* Start user code ... . Do not edit comment generated here */" and "/* End user code. Do not edit comment generated here */" will be merged. |
|                | Do nothing if file exists  | If a file with the same name exists, a new file will not be output.  |
| Output folder  | Views or selects the destination folder for various files (source code and report files) which are output when the  button is pressed or when [File] menu >> [Save Code Generator Report] is selected. |  |
| Report type    | Views or selects the format of the report files (a file containing information configured using Code Generator and a file containing information regarding the source code) which are output when [File] menu >> [Save Code Generator Report] is selected.                               |  |
|                | HTML file  | Outputs a report file in HTML format.  |
|                | CSV file   | Outputs a report file in CSV format.   |
| Register files | Selects whether source code generated by pressing the  button should be added to the project.   |  |
|                | Output files to project  | Adds output source code to the project. The source code will be added to the <a href="#">Project Tree panel</a> , under the [File] - [Code Generator] node.  |
|                | Not output files to project  | Does not add output source code to the project.  |

**Remark** To change the output destination, use the [Browse For Folder dialog box](#) which opens by pressing the [...] button in this area.

(3) [Pin Configurator Reflect Mode] category

Configure the information linking (mode) between Code Generator and Pin Configurator.

|      |  |   |
|------|--|---|
| Mode | Selects whether to reflect the settings made in the <a href="#">Code Generator panel</a> in the <a href="#">Device Pin List panel</a> when the  button is pressed. |   |
|      | Reflected  | Reflects <a href="#">Code Generator panel</a> settings in the <a href="#">Device Pin List panel</a> .         |
|      | Not reflected  | Does not reflect <a href="#">Code Generator panel</a> settings in the <a href="#">Device Pin List panel</a> . |

**Remark** If "Not reflected" is selected, then the  button will be grayed out (deselected).

**[Macro Setting] tab**



This tab allows you to view the information (Macro Information) on and change the setting for the peripheral function node "[System], [Port], etc." selected in the [Project Tree panel](#), or the peripheral function button " ,  , etc." pressed in the [Code Generator panel](#).

Figure A-9. [Macro Setting] Tab



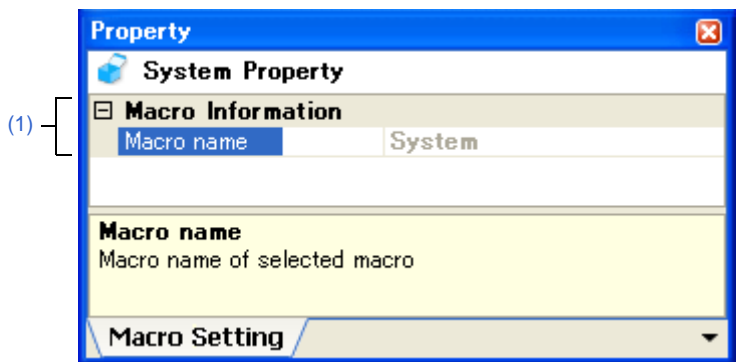

The following items are explained here.

- [\[How to open\]](#)
- [\[Description of each area\]](#)

**[How to open]**

- On the [Project Tree panel](#), select [*Project name* (Project)] >> [Code Generator (Design Tool)] >> Peripheral function node "[System], [Port], etc.", and then select [Property] from the [View] menu.
- On the [Project Tree panel](#), select [*Project name* (Project)] >> [Code Generator (Design Tool)] >> Peripheral function node "[System], [Port], etc.", and then select [Property] from the context menu.

- Remarks 1.** If this panel is already open, selecting a different peripheral function node "[System], [Port], etc." in the [Project Tree panel](#) changes the content displayed accordingly.
- 2.** If this panel is already open, pressing a different type of peripheral function button " ,  , etc." in the [Code Generator panel](#) changes the content displayed accordingly.

**[Description of each area]**

**(1) [Macro Information] category**

This area allows you to view the information (Macro name) on and change the setting for the peripheral function node "[System], [Port], etc." selected in the [Project Tree panel](#), or the peripheral function button pressed in the [Code Generator panel](#).

|            |  |
|------------|--|
| Macro name | Displays the type of peripheral function node selected in the <a href="#">Project Tree panel</a> or the type of peripheral function button pressed in the <a href="#">Code Generator panel</a> . |
|------------|--|

**[File Setting] tab**

This tab allows you to view the information (File Information) on and change the setting for the file selected in the [Code Generator Preview panel](#).

Figure A-10. [File Setting] Tab

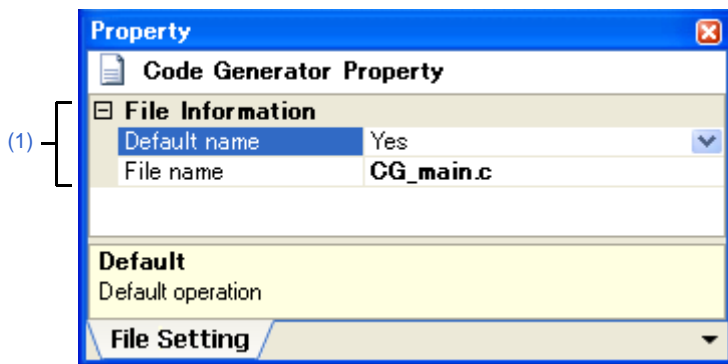

The following items are explained here.

- [\[How to open\]](#)
- [\[Description of each area\]](#)

**[How to open]**

- On the [Code Generator Preview panel](#), select a file, and then select [Property] from the [View] menu.
- On the [Code Generator Preview panel](#), select a file, and then select [Property] from the context menu.

**Remark** If this panel is already open, selecting a different file in the [Code Generator Preview panel](#) changes the content displayed accordingly.

**[Description of each area]**

**(1) [File Information] category**

This area allows you to view the information (Default, File name) on and change the setting for the file selected in the [Code Generator Preview panel](#).

|              |  |   |
|--------------|--|---|
| Default name | Views or selects the setting that determines whether the name of the file selected in the <a href="#">Code Generator Preview panel</a> is a default name or not. |   |
|              | Yes  | The file name is a default name.<br>Changing this area from "No" to "Yes" changes the name of the file to its default name. |
|              | No   | The file name is not a default name.  |
| File name    | Displays or change the name of the file selected on the <a href="#">Code Generator Preview panel</a> .   |   |

**Device Pin List panel**

This panel allows you to enter information on each pin of the microcontroller.

**Figure A-11. Device Pin List Panel**

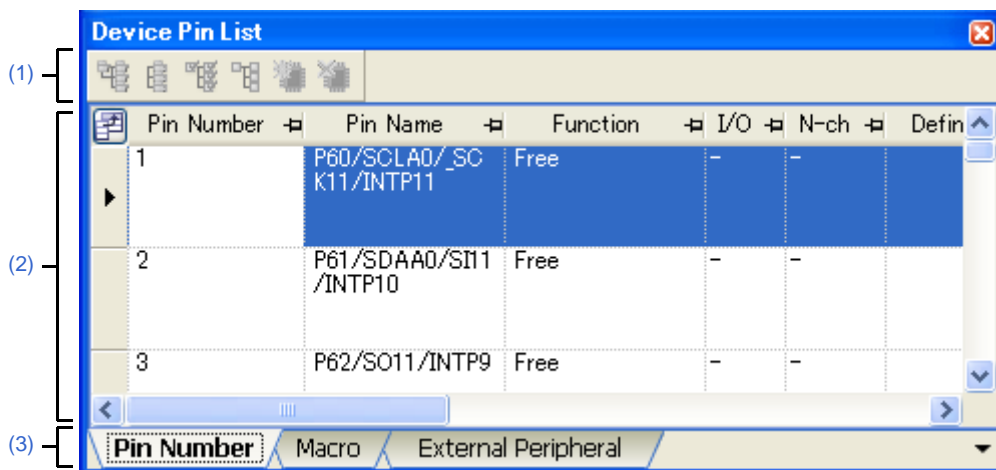

The following items are explained here.

- [How to open]
- [Description of each area]
- [[File] menu (Device Pin List panel-dedicated items)]
- [[Help] menu (Device Pin List panel-dedicated items)]

**[How to open]**



- On the **Project Tree panel**, select [*Project name* (Project)] >> [Pin Configurator (Design Tool)] >> [Device Pin List].
- From the [View] menu, select [Pin Configurator] >> [Device Pin List].

**[Description of each area]**

**(1) Toolbar**

This area consists of the following buttons.

|  |   |
|--|---|
|  | Displays the information in the <a href="#">Device pin list area</a> in an expanded view.   |
|  | Displays the information in the <a href="#">Device pin list area</a> in a folded view only.   |
|  | Clicks this button to automatically process the configuration information in the selected function, I/O, N-ch, and other fields after selecting one of the peripheral functions displayed in the first level on the <a href="#">[Macro] tab</a> . |
|  | Clicks this button to initialize the selected function, I/O, N-ch, and other fields after selecting one of the peripheral functions displayed in the first level on the <a href="#">[Macro] tab</a> .   |
|  | Clicks this button to create an external peripheral controller from the external peripheral controller information on the <a href="#">[External Peripheral] tab</a> , and display it in the <a href="#">Device Top View panel</a> .               |
|  | Clicks this button to delete the information for the external peripheral controller displayed on the <a href="#">[External Peripheral] tab</a> , on the first layer.  |

- Remarks 1.** Click the  button to add the information in question as a choice in the "External Parts" column of the [\[Macro\] tab](#) and the [\[Pin Number\] tab](#).
- 2.** Click the  button to remove the external peripheral component in question from the [Device top view area](#) if the [Device Top View panel](#).

**(2) Device pin list area**

This area displays the "device pin list" for entering information on the pins of the microcontroller.

**(3) Tab selection area**

Selecting the tab changes the order in which "information on each pin of the microcontroller" is displayed.

This panel has the following tabs:

- [\[Pin Number\] tab](#)

This tab displays information on each pin of the microcontroller in the order of pin number.

- [\[Macro\] tab](#)

This tab displays information on each pin of the microcontroller in the order it was grouped into peripheral functions.

- [\[External Peripheral\] tab](#)

This tab displays information about the pins connected to external peripherals in order grouped at the external-peripheral component level.

**[[File] menu (Device Pin List panel-dedicated items)]**

|                     |  |
|---------------------|--|
| Save Pin List       | Saves a report file (a file containing information configured using Pin Configurator: device pin list) overwriting the existing file.                                |
| Save Pin List As... | Opens the <a href="#">Save As dialog box</a> for naming and saving a report file (a file containing information configured using Pin Configurator: device pin list). |

**[[Help] menu (Device Pin List panel-dedicated items)]**

|                                     |                                  |
|-------------------------------------|----------------------------------|
| Open Help for Device Pin List Panel | Displays the help of this panel. |
|-------------------------------------|----------------------------------|

**[Pin Number] tab**

This tab displays information on each pin of the microcontroller in the order of pin number.

**Figure A-12. [Pin Number] Tab**

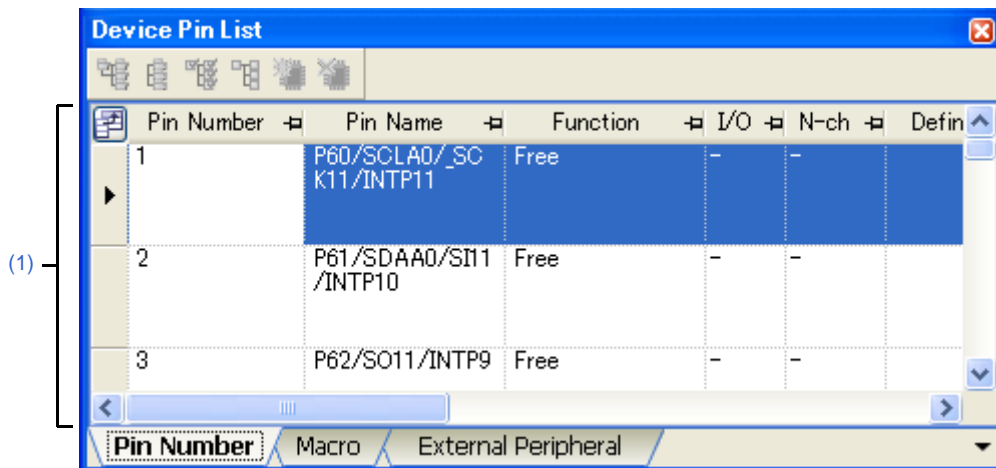

The following items are explained here.

- [\[How to open\]](#)
- [\[Description of each area\]](#)

**[How to open]**

- On the [Project Tree](#) panel, select [*Project name* (Project)] >> [Pin Configurator (Design Tool)] >> [Device Pin List].
- From the [View] menu, select [Pin Configurator] >> [Device Pin List].

**[Description of each area]**

**(1) Device pin list area**

This area displays the "device pin list" for entering information on the pins of the microcontroller. The device pin list in this area is organized in the order of pin number. The following are the columns comprising the device pin list.

| Column Heading | Outline  |
|----------------|--|
| Pin Number     | Displays the pin number of the pin.  |
| Pin Name       | This area allows you to select "which function to use" when the pin has more than one functions.   |
| Function       | This area allows you to select "which function to use" when the pin has more than one functions.   |
| I/O            | This area allows you to select the I/O mode of the pin.  |
| N-ch           | This area allows you to select "which output mode to apply" when using the pin in the output mode. |
| Define Name    | This area allows you to assign a "user-defined pin name" to the pin.                               |
| Description    | Displays the summary of function of the pin.   |



| Column Heading                  | Outline  |
|---------------------------------|--|
| Recommend Connection For Unused | Displays instructions on how to handle the pin when it is not used.<br>This column displays information only when the "Free" is selected in the "Function" column. |
| Attention                       | Displays the precaution on using the pin.  |
| External Parts                  | This area is for selecting which external peripheral controller to connect the pin to.   |

- Remarks 1.** You cannot add information in the "Pin Number" column, "Pin Name" column, "Description" column, "Recommend Connection For Unused" column and "Attention" column because they contain fixed information.
2. If the "Free" in the "Function" column is changed to a specific pin name, color of the corresponding pin in the [Device Top View panel](#) changes from the "color representing the unused pins" to the "color representing the used pins" selected by clicking [\[Device Top View Settings\] tab](#) >> [Color] in the [Property panel](#).
  3. To move columns (change the display order) in the device pin list, drag and drop the desired column to the desired location.
  4. To add the "user's own column", use the [New Column dialog box](#) which opens by pressing the [New Column] button in the [Column Chooser dialog box](#) which opens by pressing the  button in the upper left corner of the device pin list.

**[Macro] tab**

This tab displays information on each pin of the microcontroller in the order it was grouped into peripheral functions.

Figure A-13. [Macro] Tab

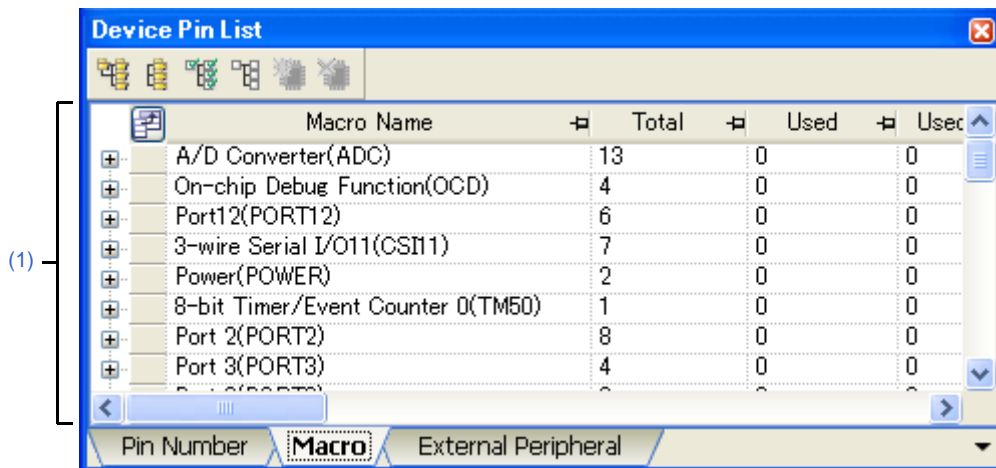

The following items are explained here.

- [How to open]
- [Description of each area]

**[How to open]**

- On the **Project Tree** panel, select [*Project name* (Project)] >> [Pin Configurator (Design Tool)] >> [Device Pin List].
- From the [View] menu, select [Pin Configurator] >> [Device Pin List].

**[Description of each area]**

**(1) Device pin list area**

This area displays the "device pin list" for entering information on the pins of the microcontroller. The device pin list in this area is organized in the order the pins were grouped into peripheral functions.

**(a) First layer**

The following are the columns comprising the device pin list.

| Column Heading      | Outline   |
|---------------------|---|
| Macro Name          | Displays the name of the peripheral function.   |
| Total               | Displays the total number of pins assigned to the peripheral function.                              |
| Used                | Displays the total number of pins for which the purpose has been set.                               |
| Used in Other Macro | Displays the total number of pins for which the purpose has been set by other peripheral functions. |

## (b) Second layer

| Column Heading                  | Outline  |
|---------------------------------|--|
| Pin Number                      | Displays the pin number of the pin.  |
| Pin Name                        | Displays the pin name of the pin.  |
| Function                        | This area allows you to select "which function to use" when the pin has more than one functions.   |
| I/O                             | This area allows you to select the I/O mode of the pin.  |
| N-ch                            | This area allows you to select "which output mode to apply" when using the pin in the output mode.   |
| Define Name                     | This area allows you to assign a "user-defined pin name" to the pin.   |
| Description                     | Displays the summary of function of the pin.   |
| Recommend Connection For Unused | Displays instructions on how to handle the pin when it is not used.<br>This column displays information only when the "Free" is selected in the "Function" column. |
| Attention                       | Displays the precaution on using the pin.  |
| External Parts                  | This area is for selecting which external peripheral controller to connect the pin to.   |

- Remarks 1.** You cannot add information in the "Macro Name", "Total", "Used", "Used by other function", "Pin Number", "Pin Name", "Description", "Recommend Connection For Unused" and "Attention" columns because they contain fixed information.
- If the "Free" in the "Function" column is changed to a specific pin name, color of the corresponding pin in the [Device Top View panel](#) changes from the "color representing the unused pins" to the "color representing the used pins" selected by clicking [\[Device Top View Settings\] tab >> \[Color\]](#) in the [Property panel](#).
  - To move columns (change the display order) in the device pin list, drag and drop the desired column to the desired location.
  - To add the "user's own column", use the [New Column dialog box](#) which opens by pressing the [New Column] button in the [Column Chooser dialog box](#) which opens by pressing the  button in the upper left corner of the device pin list.

**[External Peripheral] tab**

This tab displays information about the pins connected to external peripherals in order grouped at the external-peripheral component level.

**Figure A-14. [External Peripheral] Tab**

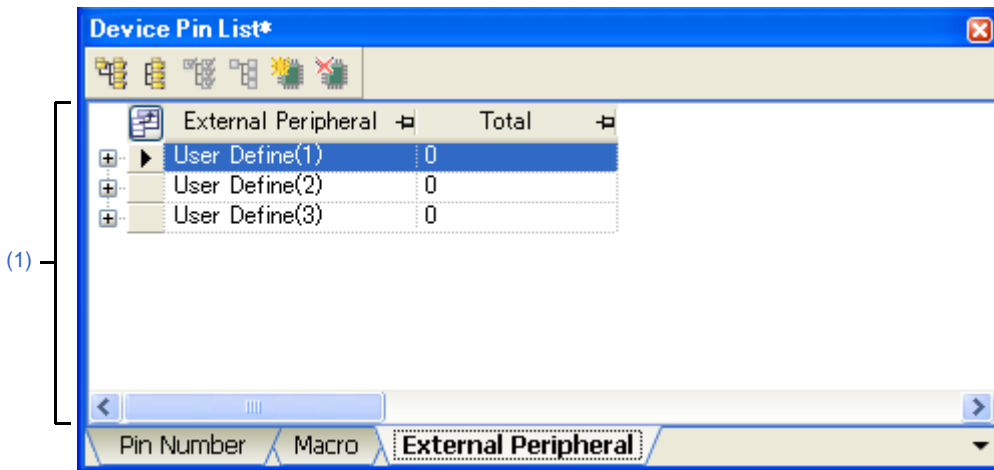

The following items are explained here.

- [How to open]
- [Description of each area]

**[How to open]**

- On the [Project Tree panel](#), select [*Project name* (Project)] >> [Pin Configurator (Design Tool)] >> [Device Pin List].
- From the [View] menu, select [Pin Configurator] >> [Device Pin List].

**[Description of each area]**

**(1) Device pin list area**

This area displays the "device pin list" for entering information on the pins connected to external peripheral parts. Note that items in this area's device pin list are sorted by groups at the external peripheral controller level.

**(a) First layer**

The following are the columns comprising the device pin list.

| Column Heading      | Outline  |
|---------------------|--|
| External Peripheral | Displays the name of the external peripheral controller.<br>To change the name, select this field and then press the [F2] key. |
| Total               | Displays the total number of pins allocated for connection with the microcontroller.   |

## (b) Second layer

| Column Heading                  | Outline  |
|---------------------------------|--|
| Pin Number                      | Displays the pin number of the pin.  |
| Pin Name                        | Displays the pin name of the pin.  |
| Function                        | This area allows you to select "which function to use" when the pin has more than one functions.   |
| I/O                             | This area allows you to select the I/O mode of the pin.  |
| N-ch                            | This area allows you to select "which output mode to apply" when using the pin in the output mode.   |
| Define Name                     | This area allows you to assign a "user-defined pin name" to the pin.   |
| Description                     | Displays the summary of function of the pin.   |
| Recommend Connection For Unused | Displays instructions on how to handle the pin when it is not used.<br>This column displays information only when the "Free" is selected in the "Function" column. |
| Attention                       | Displays the precaution on using the pin.  |

- Remarks 1.** You cannot add information in the "External Peripheral Name", "Connected Pins", "Pin Number", "Pin Name", "Description", "Recommend Connection For Unused" and "Attention" columns because they contain fixed information.
- If the "Free" in the "Function" column is changed to a specific pin name, color of the corresponding pin in the [Device Top View panel](#) changes from the "color representing the unused pins" to the "color representing the used pins" selected by clicking [\[Device Top View Settings\] tab](#) >> [Color] in the [Property panel](#).
  - To move columns (change the display order) in the device pin list, drag and drop the desired column to the desired location.
  - To add the "user's own column", use the [New Column dialog box](#) which opens by pressing the [New Column] button in the [Column Chooser dialog box](#) which opens by pressing the  button in the upper left corner of the device pin list.

Device Top View panel

This panel displays the information entered in the [Device Pin List panel](#).

Figure A-15. Device Top View Panel

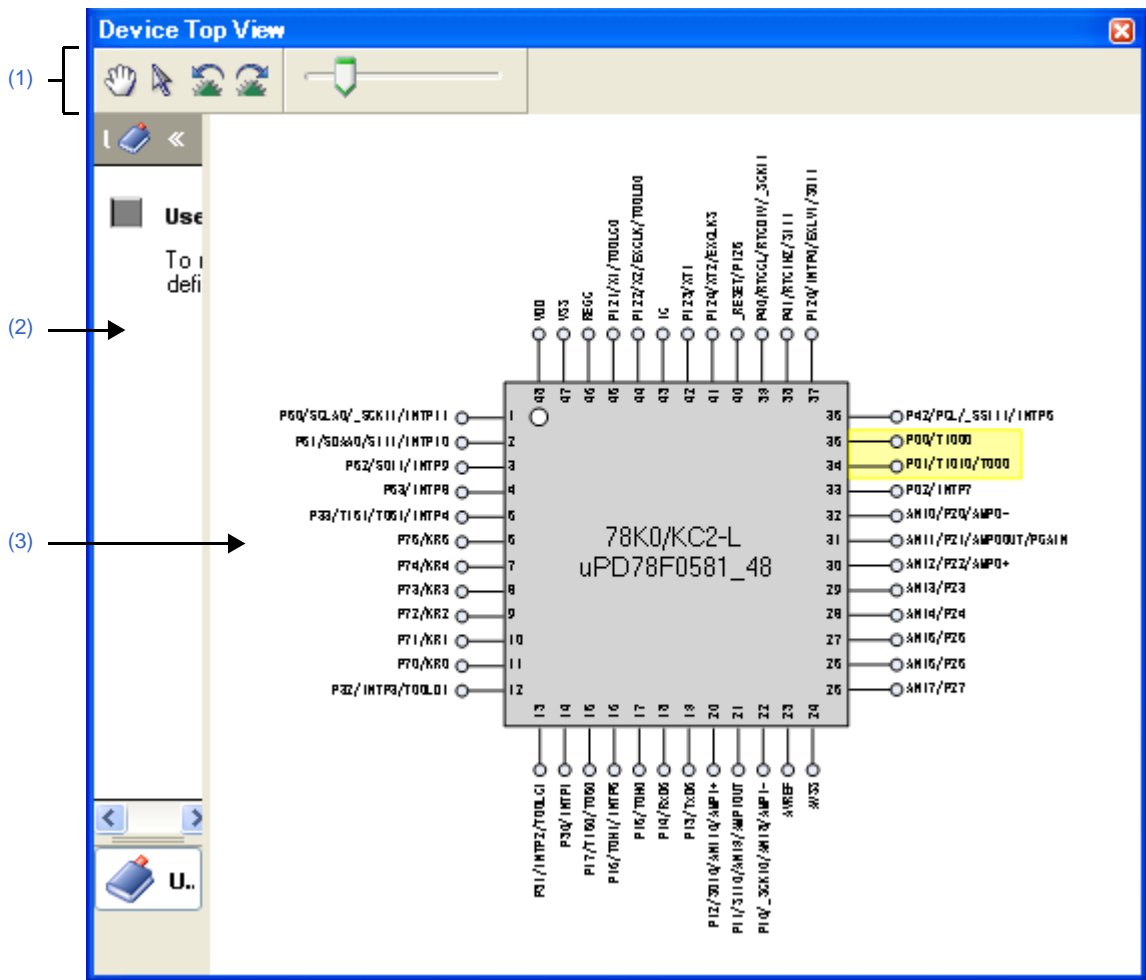

The following items are explained here.

- [\[How to open\]](#)
- [\[Description of each area\]](#)
- [\[\[File\] menu \(Device Top View panel-dedicated items\)\]](#)
- [\[\[Help\] menu \(Device Top View panel-dedicated items\)\]](#)
- [\[Context menu\]](#)

**[How to open]**





- On the [Project Tree panel](#), select [*Project name* (Project)] >> [*Pin Configurator* (Design Tool)] >> [*Device Top View*].
- From the [View] menu, select [*Pin Configurator*] >> [*Device Top View*].

**Remark** In the [Property panel](#), on the [\[Pin Configurator Settings\] tab](#), if "BGA" is selected for the Package type, then this panel cannot be opened.

[Description of each area]

(1) **Toolbar**

This area consists of the following buttons.

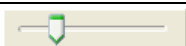
|   |   |
|---|---|
|  | Clicks this button to enable changing of the display in the <a href="#">Device top view area</a> by drag and drop.<br>By pressing this button, the shape of the mouse cursor in the <a href="#">Device top view area</a> changes from the arrow to the hand.  |
|  | Clicks this button to enable moving external peripheral components in the <a href="#">Device top view area</a> to arbitrary locations, and select pins.<br>By pressing this button, the shape of the mouse cursor which has changed into the hand by pressing the  button reverts back to the arrow. |
|  | Rotates the content in the <a href="#">Device top view area</a> 90 degrees counter-clockwise.   |
|  | Rotates the content in the <a href="#">Device top view area</a> 90 degrees clockwise.   |
|  | Expands or reduces the content in the <a href="#">Device top view area</a> .  |

(2) **[User Define] area**

Drag and drop the  button from this area to the [Device top view area](#) to creat and display an external peripheral controller.

(3) **Device top view area**

This area displays the pin assignment of the microcontroller.

Settings of the pin assignment are displayed using the colors specified by selecting [\[Device Top View Settings\] tab](#) >> [Color] in the [Property panel](#).

**Remark** If the pin name in the diagram is double-clicked, the [Device Pin List panel](#) opens and the focus moves to the clicked pin in the list.

**[[File] menu (Device Top View panel-dedicated items)]**

|                     |  |
|---------------------|--|
| Save Top View       | Saves a report file (a file containing information configured using Pin Configurator: device top view) overwriting the existing file.                                |
| Save Top View As... | Opens the <a href="#">Save As dialog box</a> for naming and saving a report file (a file containing information configured using Pin Configurator: device top view). |

**[[Help] menu (Device Top View panel-dedicated items)]**

|                                     |                                  |
|-------------------------------------|----------------------------------|
| Open Help for Device Top View Panel | Displays the help of this panel. |
|-------------------------------------|----------------------------------|

**[Context menu]**

When you right click on a pin or external peripheral controller in the [Device top view area](#), the following context menu displays.

**(1) When a pin is right clicked**

|                                |   |
|--------------------------------|---|
| Use as                         | If the pin has multiple functions, select which function to use.    |
| Connect to External Peripheral | Selects which external peripheral controller to connect the pin to. |

**(2) When an external peripheral controller is right clicked**

|                            |   |
|----------------------------|---|
| Disconnect Pin             | Disconnects from the pin.                   |
| Delete External Peripheral | Removes the external peripheral controller. |



**Code Generator panel**

This panel allows you to configure the information necessary to control the peripheral functions provided by the micro-controller.

Figure A-16. Code Generator Panel: [System]

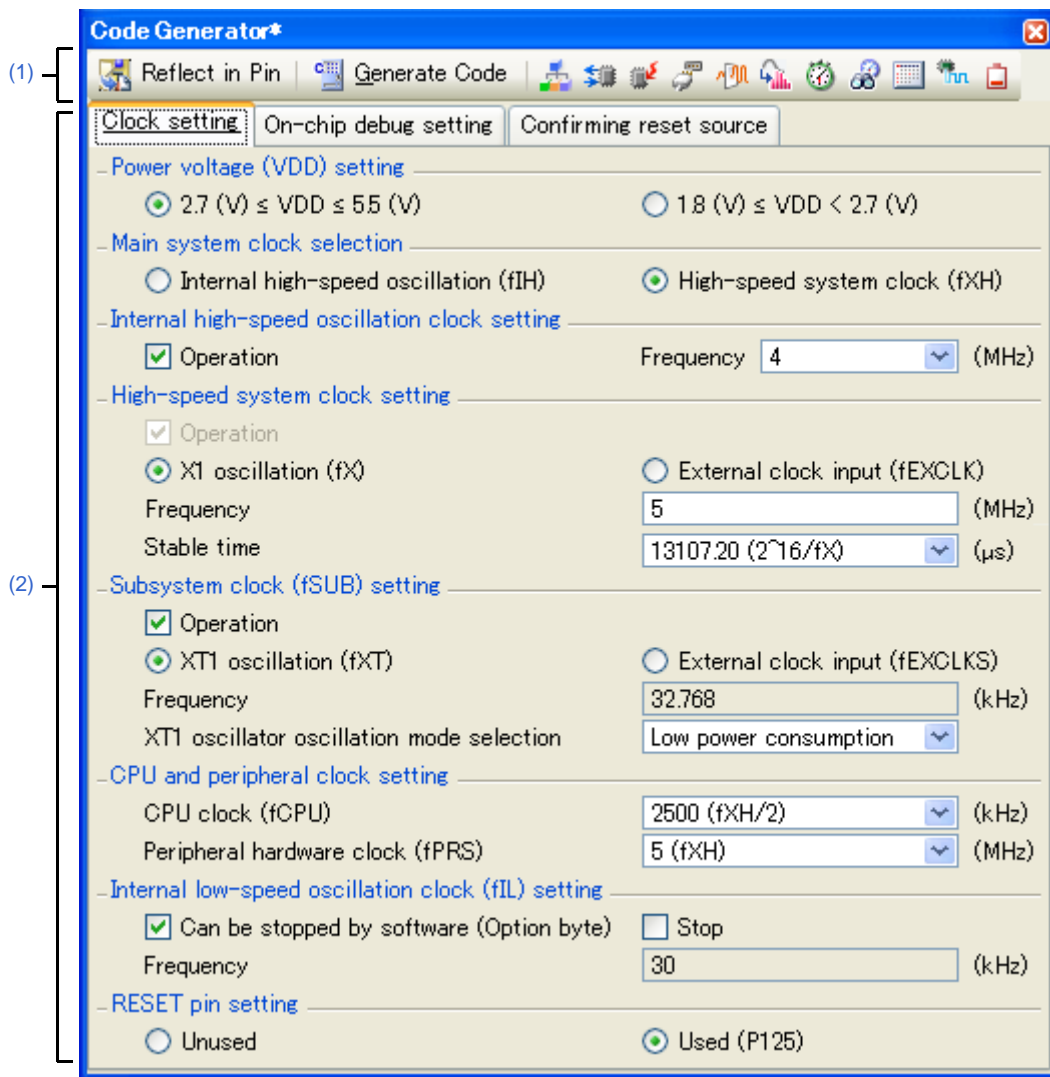



The following items are explained here.

- [How to open]
- [Description of each area]
- [[File] menu (Code Generator panel-dedicated items)]
- [[Help] menu (Code Generator panel-dedicated items)]

**[How to open]**

- On the **Project Tree panel**, select [*Project name* (Project)] >> [Code Generator (Design Tool)] >> Peripheral function node "[System], [Port], etc.".





**Remark** If this panel is already open, pressing a different peripheral function button " ,  , etc." changes the content displayed in the **Information setting area** accordingly.

## [Description of each area]

## (1) Toolbar

This area consists of the following "peripheral function buttons".

When there is peripheral function target microcontroller is not supporting, peripheral function button is not displayed.

|  |   |
|--|---|
|  Reflect in Pin | Reflects settings made on this panel in the <a href="#">Device Pin List panel</a> . This button will be grayed out (disabled) if "Not reflected" is selected in the [PinPart Combination Mode] category of the <a href="#">[Generation] tab</a> .             |
|  Generate Code  | Outputs the source code (device driver program) to the folder specified by selecting <a href="#">[Generation] tab</a> >> [Output folder] in the <a href="#">Property panel</a> .  |
|                 | Changes the content displayed in the <a href="#">Information setting area</a> to the "[System]" for configuring the information necessary to control the functions of clock generator, on-chip debug function and etc. provided by the microcontroller".      |
|                 | Changes the content displayed in the <a href="#">Information setting area</a> to the "[Port]" for configuring the information necessary to control the port functions provided by the microcontroller".   |
|                 | Changes the content displayed in the <a href="#">Information setting area</a> to the "[INT]" for configuring the information necessary to control the interrupt functions and the key interrupt function provided by the microcontroller".                    |
|               | Changes the content displayed in the <a href="#">Information setting area</a> to the "[Serial]" for configuring the information necessary to control the functions of serial array unit and functions of serial interface provided by the microcontroller".   |
|               | Changes the content displayed in the <a href="#">Information setting area</a> to the "[Operational Amplifier]" for configuring the information necessary to control the functions of comparator/programmable gain amplifier provided by the microcontroller". |
|               | Changes the content displayed in the <a href="#">Information setting area</a> to the "[Comparator]" for configuring the information necessary to control the function of comparator provided by the microcontroller".   |
|               | Changes the content displayed in the <a href="#">Information setting area</a> to the "[A/D]" for configuring the information necessary to control the function of A/D converter provided by the microcontroller".   |
|               | Changes the content displayed in the <a href="#">Information setting area</a> to the "[Timer]" for configuring the information necessary to control the functions of timer array unit provided by the microcontroller".                                       |
|               | Changes the content displayed in the <a href="#">Information setting area</a> to the "[Watchdog Timer]" for configuring the information necessary to control the functions of watchdog timer provided by the microcontroller".                                |
|               | Changes the content displayed in the <a href="#">Information setting area</a> to the "[RTC]" for configuring the information necessary to control the functions of real-time counter provided by the microcontroller".  |
|               | Changes the content displayed in the <a href="#">Information setting area</a> to the "[Clock Output]" for configuring the information necessary to control the functions of clock output controller provided by the microcontroller".                         |
|               | Changes the content displayed in the <a href="#">Information setting area</a> to the "[LVI]" for configuring the information necessary to control the functions of low-voltage detector provided by the microcontroller".                                     |

**(2) Information setting area**

The content displayed in this area differs depending on the "peripheral function node" or "peripheral function button" selected or pressed when opening this panel.

See User's Manual for Microcontroller for details on the items to be set.

**[[File] menu (Code Generator panel-dedicated items)]**

|                            |   |
|----------------------------|---|
| Save Code Generator Report | Outputs report files (a file containing information configured using Code Generator and a file containing information regarding the source code). |
|----------------------------|---|

- Remarks 1.** The output format for the report file (either HTML or CSV) is selected by clicking [\[Generation\] tab >> \[Report type\]](#) in the [Property panel](#).
- 2.** The destination folder for the report file is specified by clicking [\[Generation\] tab >> \[Output folder\]](#) in the [Property panel](#).

**[[Help] menu (Code Generator panel-dedicated items)]**

|                                    |                                  |
|------------------------------------|----------------------------------|
| Open Help for Code Generator Panel | Displays the help of this panel. |
|------------------------------------|----------------------------------|

**Code Generator Preview panel**

This panel allows you to confirm or configure on a per-API function basis the setting that determines whether or not the source code (device driver program) is generated when the  button is pressed in the [Code Generator panel](#). It also allows you to confirm the source code that reflects the information configured in the [Code Generator panel](#).

Figure A-17. Code Generator Preview Panel



The following items are explained here.

- [\[How to open\]](#)
- [\[Description of each area\]](#)
- [\[\[File\] menu \(Code Generator Preview panel-dedicated items\)\]](#)
- [\[\[Help\] menu \(Code Generator Preview panel-dedicated items\)\]](#)
- [\[Context menu\]](#)

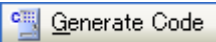
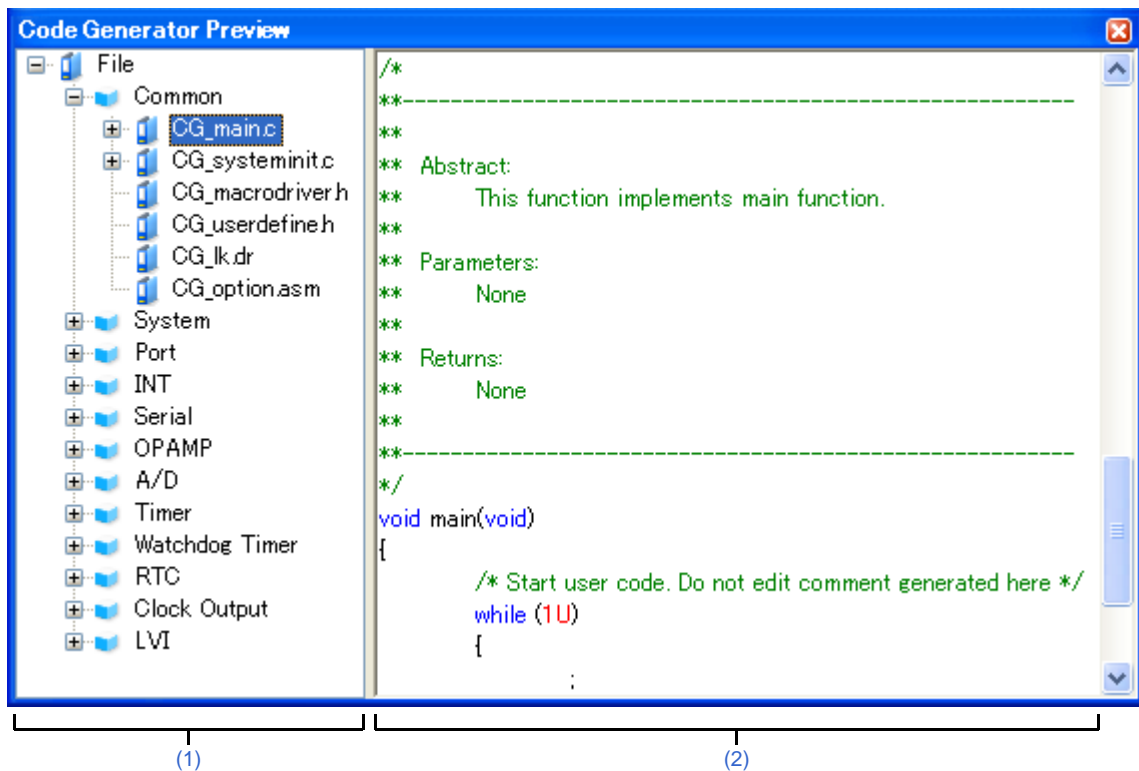
**[How to open]**

- From the [\[View\]](#) menu, select [\[Code Generator Preview\]](#).



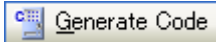

**[Description of each area]**

**(1) Preview tree**

This area allows you to confirm or configure on a per-API function basis the setting that determines whether or not the source code (device driver program) is generated when the  button is pressed in the [Code Generator panel](#).

- Remarks 1. You can change the source code to be displayed by selecting the source file name or API function name in this tree.
- 2. To select whether or not to generate the source code, use the context menu (Generate code/Not generate code) which is displayed by right-clicking the mouse while the mouse cursor is on the desired icon in the tree.
- 3. You can confirm the current setting that determines whether or not to generate the source code by checking the type of icon.

**Table A-2. Setting That Determines Whether or Not to Generate the Source Code**

| Type of Icon  | Outline   |
|---|---|
|  | Source code for the currently selected API function is generated.<br>If this icon is displayed next to the API function, the corresponding source code must be generated (it is impossible to change the icon to  ). |
|  | Source code for the currently selected API function is generated.   |
|  | Source code for the currently selected API function is not generated.   |

**(2) Source code display area**

This area allows you to confirm the source code (device driver program) that reflects the information configured in the [Code Generator panel](#).

The following table displays the meaning of the color of the source code text displayed in this area.

**Table A-3. Color of Source Code**

| Color | Outline                      |
|-------|------------------------------|
| Green | Comment                      |
| Blue  | Reserved word for C compiler |
| Red   | Numeric value                |
| Black | Code section                 |
| Gray  | File name                    |

- Remarks 1. You cannot edit the source code within this panel.
- 2. For some of the API functions (such as API functions for serial array units), values such as the SFR register value are calculated and finalized when the source code is generated (when the  button on the [Code Generator panel](#) is pressed). For this reason, the source code displayed in this panel may not be the same as that would actually be generated.
- 3. You can change the source code to be displayed by selecting the source file name or API function name in the preview tree.

**[[File] menu (Code Generator Preview panel-dedicated items)]**

|                            |   |
|----------------------------|---|
| Save Code Generator Report | Outputs report files (a file containing information configured using Code Generator and a file containing information regarding the source code). |
|----------------------------|---|





- Remarks 1. The output format for the report file (either HTML or CSV) is selected by clicking [\[Generation\] tab](#) >> [Report type] in the [Property panel](#).
- 2. The destination folder for the report file is specified by clicking [\[Generation\] tab](#) >> [Output folder] in the [Property panel](#).

**[[Help] menu (Code Generator Preview panel-dedicated items)]**

|  |                                  |
|--|----------------------------------|
| Open Help for Code Generator Preview Panel | Displays the help of this panel. |
|--|----------------------------------|

**[Context menu]**

The following context menu items are displayed by right clicking the mouse.

|                   |  |
|-------------------|--|
| Generate code     | Makes a setting so that the source code of the currently selected API function is generated to the folder specified by selecting <a href="#">[Generation] tab</a> >> [Output folder] in the <a href="#">Property panel</a> .<br>Selecting this context menu item changes the icon of the currently selected API function from  to  .                                   |
| Not generate code | Makes a setting so that the source code of the currently selected API function is not generated when the  button is pressed in the <a href="#">Code Generator panel</a> .<br>Selecting this context menu item changes the icon of the currently selected API function from  to  . |
| Rename            | Selecting this menu item changes the name portion of the currently selected file or API function into an edit box for editing the name.<br>You can change the name of the file or API function by editing its name in the edit box.  |
| Default           | Reverts the file name or API function name to its original name before it was edited.  |
| Property          | Opens the <a href="#">Property panel</a> that contains the information for the currently selected file.  |

**Output panel**

This panel displays operation logs for various components (design tool, build tool, etc.) provided by CubeSuite+.

**Figure A-18. Output Panel**



The following items are explained here.

- [How to open]
- [Description of each area]
- [[File] menu (Output panel-dedicated items)]
- [[Edit] menu (Output panel-dedicated items)]
- [[Help] menu (Output panel-dedicated items)]
- [Context menu]

**[How to open]**

- From the [View] menu, select [Output].

**[Description of each area]**

**(1) Message area**

This area displays operation logs for various components (design tool, build tool, etc.) provided by CubeSuite+. The following table displays the meaning of the color of the message text displayed in this area.

**Table A-4. Color of Message Text/Background**

| Message Text/Background | Description   |
|-------------------------|---|
| Block/White             | Information message<br>Displayed with information notices.  |
| Blue/Standard color     | Warning message<br>Displayed with warnings about operations.  |
| Red/LightGray           | Fatal error message<br>Displayed when there is a fatal error, or when execution is not possible due to a operational mistake. |

**Remark** See the sections "[All Output Messages] tab" and "[Code Generator] tab" for details on the content displayed in this area.

**(2) Tab selection area**

Select the source of message.

**Remark** When the new message is output, "\*" mark is displayed to the left of the tab name.

**[[File] menu (Output panel-dedicated items)]**

|                                    |  |
|------------------------------------|--|
| Save Output- <i>Tab Name</i>       | Saves the message corresponding to the specified tab overwriting the existing file.                                |
| Save Output- <i>Tab Name</i> As... | Opens the <a href="#">Save As dialog box</a> for naming and saving the message corresponding to the specified tab. |

**[[Edit] menu (Output panel-dedicated items)]**

|            |  |
|------------|--|
| Copy       | Sends the character string or lines selected with range selection to the clipboard.                  |
| Select All | Selects all the messages displayed on the <a href="#">Message area</a> .                             |
| Search...  | Opens the Search and Replace dialog box for searching strings with the [Quick Search] tab selected.  |
| Replace... | Opens the Search and Replace dialog box for replacing strings with the [Whole Replace] tab selected. |

**[[Help] menu (Output panel-dedicated items)]**

|                            |                                  |
|----------------------------|----------------------------------|
| Open Help for Output Panel | Displays the help of this panel. |
|----------------------------|----------------------------------|

**[Context menu]**

The following context menu items are displayed by right clicking the mouse.

|                       |  |
|-----------------------|--|
| Copy                  | Sends the character string or lines selected with range selection to the clipboard.  |
| Select All            | Selects all the messages displayed on the <a href="#">Message area</a> .   |
| Clear                 | Deletes all the messages displayed on the <a href="#">Message area</a> .   |
| Stop Searching        | <p>Cancels the search currently being executed.</p> <p>This is invalid when a search is not being executed.</p>                      |
| Open Help for Message | <p>Displays help for the message on the current caret location.</p> <p>This only applies to warning messages and error messages.</p> |



**[All Output Messages] tab**

This tab displays operation logs for all components (design tool, build tool, etc.) provided by CubeSuite+.

**Figure A-19. [All Output Messages] Tab**



The following items are explained here.

- [How to open]
- [Description of each area]

**[How to open]**

- From the [View] menu, select [Output].

**[Description of each area]**

**(1) Message area**

This area displays operation logs for all components (design tool, build tool, etc.) provided by CubeSuite+. The following table displays the meaning of the color of the message text displayed in this area.

**Table A-5. Color of Message Text/Background**

| Message Text/Background | Description   |
|-------------------------|---|
| Black/White             | Information message<br>Displayed with information notices.  |
| Blue/Standard Color     | Warning message<br>Displayed with warnings about operations.  |
| Red/LightGray           | Fatal error message<br>Displayed when there is a fatal error, or when execution is not possible due to a operational mistake. |

**[Code Generator] tab**

This tab displays only operation logs for Code Generator out of those for various components (design tool, build tool, etc.) provided by CubeSuite+.

**Figure A-20. [Code Generator] Tab**



The following items are explained here.

- [\[How to open\]](#)
- [\[Description of each area\]](#)

**[How to open]**

- From the [View] menu, select [Output].

**[Description of each area]**

**(1) Message area**

This area displays only operation logs for Code Generator out of those for various components (design tool, build tool, etc.) provided by CubeSuite+.

The following table displays the meaning of the color of the message text displayed in this area.

**Table A-6. Color of Message Text/Background**

| Message Text/Background | Outline   |
|-------------------------|---|
| Black/White             | Information message<br>Displayed with information notices.  |
| Blue/Standard Color     | Warning message<br>Displayed with warnings about operations.  |
| Red/LightGray           | Fatal error message<br>Displayed when there is a fatal error, or when execution is not possible due to a operational mistake. |

**Column Chooser dialog box**

This dialog box allows you to choose whether or not to display the item listed in this dialog box in the device pin list, and add columns to or delete columns from the device pin list.

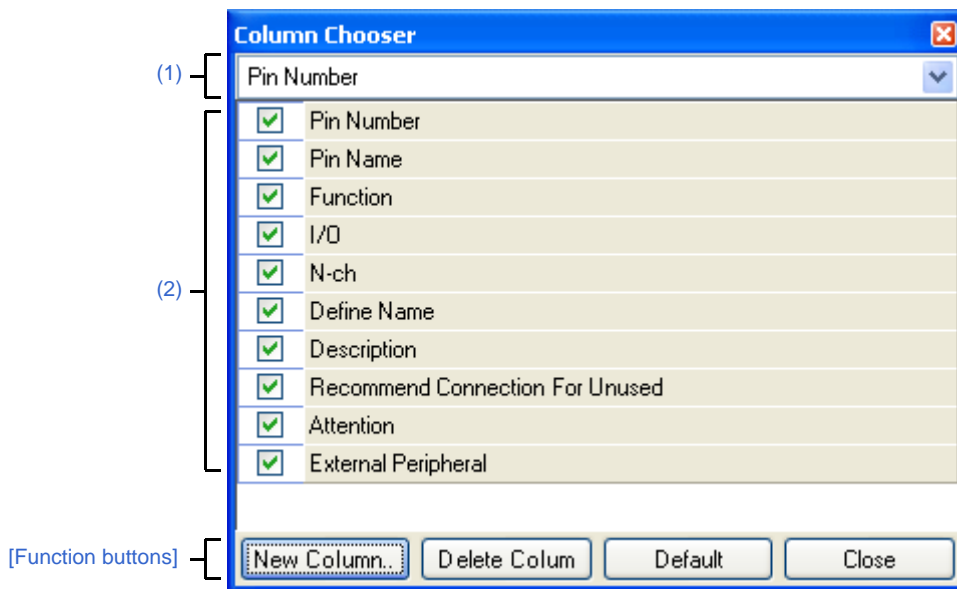

**Figure A-21. Column Chooser Dialog Box**



The following items are explained here.

- [How to open]
- [Description of each area]
- [Function buttons]

**[How to open]**

- In the [Pin Number] tab of the Device Pin List panel, click the  button.
- In the [Macro] tab of the Device Pin List panel, click the  button.
- In the [External Peripheral] tab of the Device Pin List panel, click the  button.

**[Description of each area]**

**(1) Operational object selection area**

This area allows you to select the device pin list to be configured in this dialog box.

|                           |  |
|---------------------------|--|
| Pin Number                | Configures the device pin list corresponding to the [Pin Number] tab.                          |
| Macro                     | Configures the device pin list belonging to the first layer of the [Macro] tab.                |
| Macro - Pin               | Configures the device pin list belonging to the second layer of the [Macro] tab.               |
| External Peripheral       | Configures the device pin list belonging to the first layer of the [External Peripheral] tab.  |
| External Peripheral - Pin | Configures the device pin list belonging to the second layer of the [External Peripheral] tab. |

Figure A-22. Operational Object ([Pin Number] Tab)

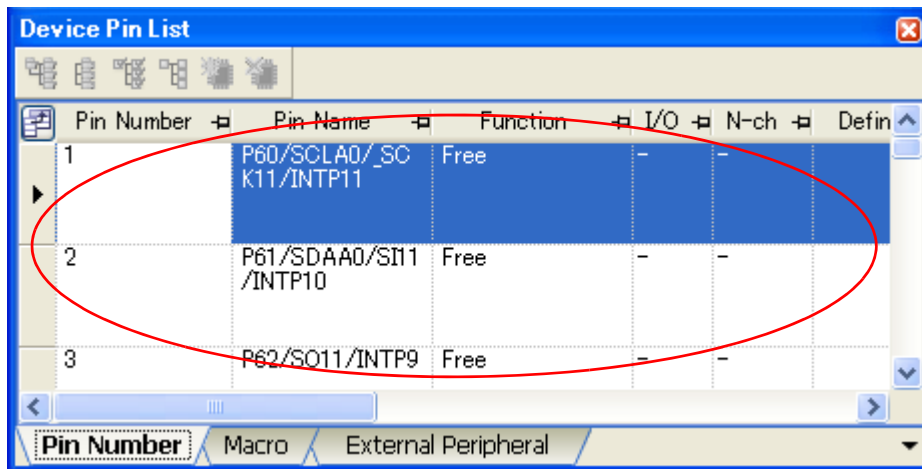

Figure A-23. Operational Object ([Macro] Tab: First Layer)

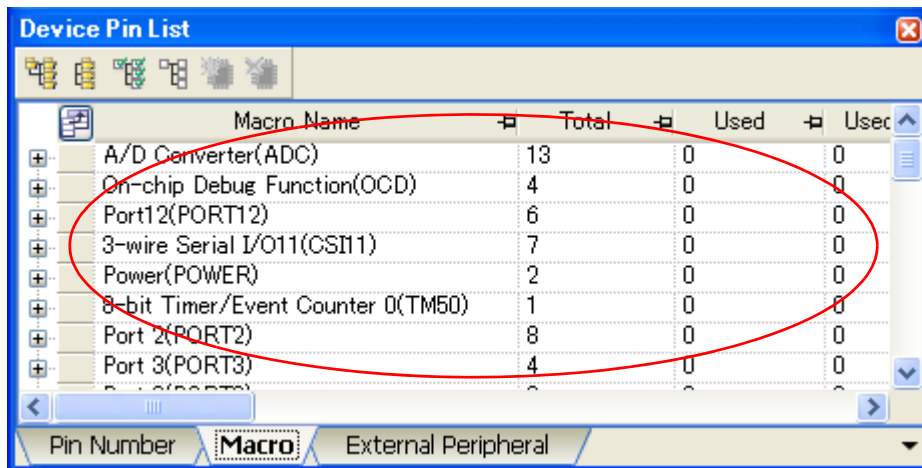

Figure A-24. Operational Object ([Macro] Tab: Second Layer)

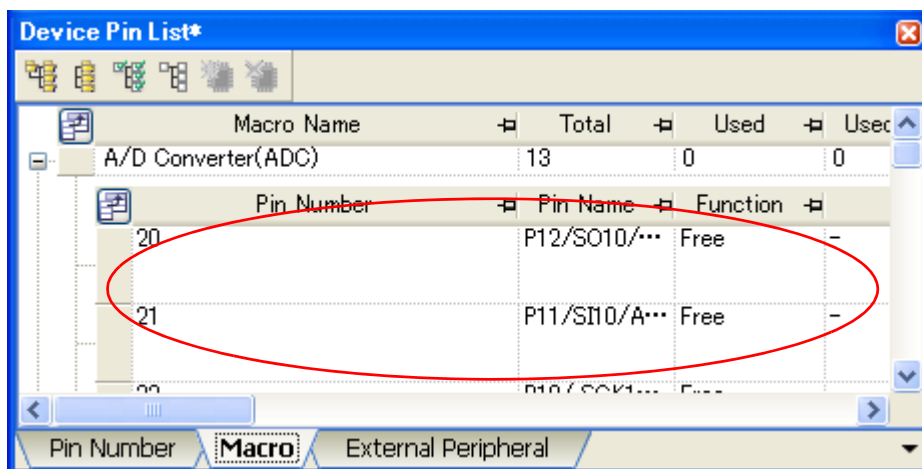

Figure A-25. Operational Object ([External Peripheral] Tab: First Layer)

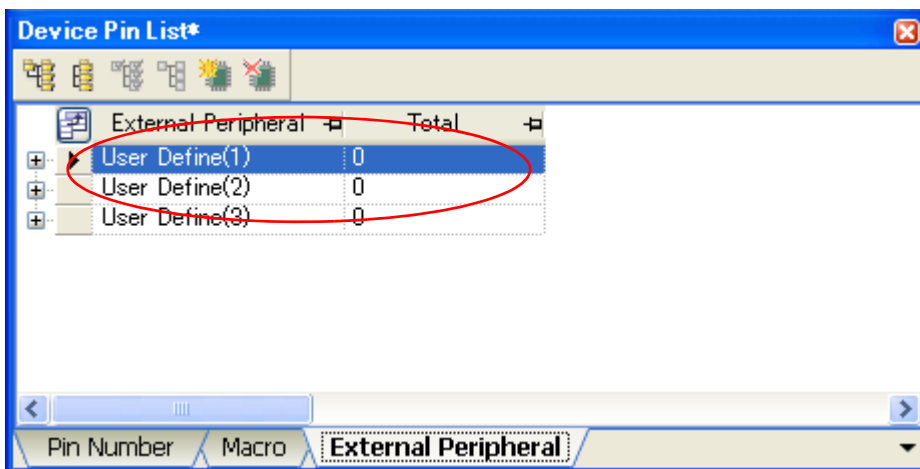
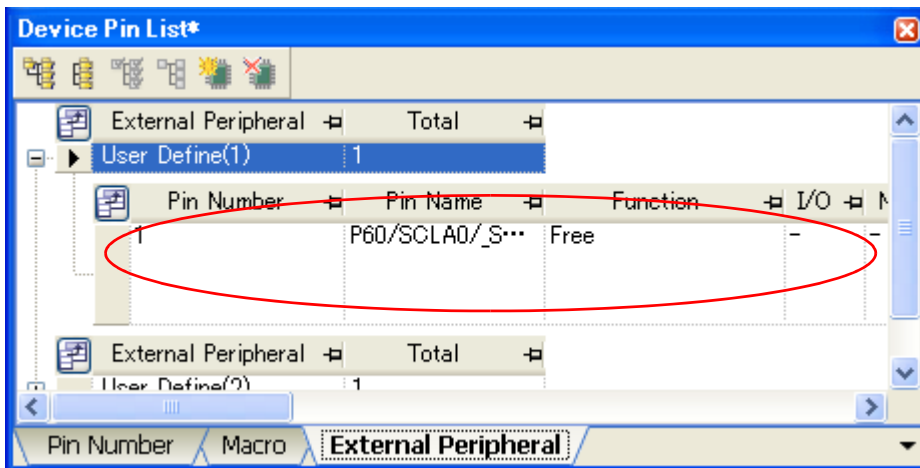

Figure A-26. Operational Object ([External Peripheral] Tab: Second Layer)



**(2) Displayed item selection area**

Select whether or not to display the item selected in the [Operational object selection area](#) in the device pin list.

|             |  |
|-------------|--|
| Checked     | Displays the selected item in the device pin list. |
| Not checked | Hides the selected item in the device pin list.    |

**[Function buttons]**

| Button        | Function   |
|---------------|--|
| New Column    | Opens the <a href="#">New Column dialog box</a> for adding columns to the device pin list.   |
| Delete Column | Deletes the selected columns from the device pin list.<br>You can only delete the column which you added using the <a href="#">New Column dialog box</a> . |
| Default       | Restores the column order to the default settings.   |
| Close         | Closes this dialog box.  |

**New Column dialog box**

This dialog box allows you to add your own column to the device pin list.

**Figure A-27. New Column Dialog Box**

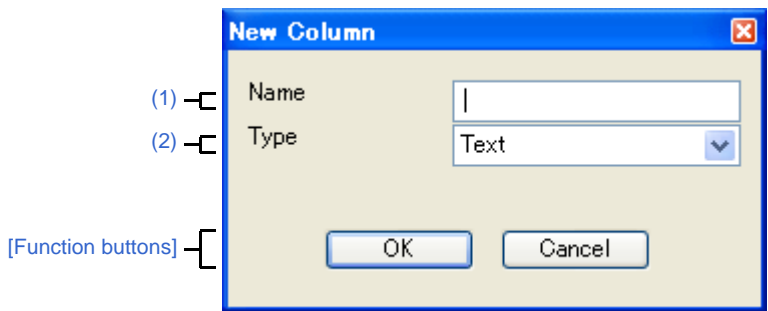

The following items are explained here.

- [How to open]
- [Description of each area]
- [Function buttons]

**[How to open]**

- Click the [New Column] button in the [Column Chooser dialog box](#).

**[Description of each area]**

**(1) [Name]**

This area allows you to enter column headings of the columns added to the device pin list.

**(2) [Type]**

Select the input format of the column to add to the device pin list.

|              |   |
|--------------|---|
| Text         | Only character strings can be entered in the column.        |
| Check box    | Adds a column of check boxes.                               |
| Whole number | Only integers can be entered in the column.                 |
| Real number  | Only real numbers can be entered in the column.             |
| Date         | Only dates in YYYYMMDD format can be entered in the column. |

**[Function buttons]**

| Button | Function   |
|--------|--|
| OK     | Adds a column that has the column heading specified in the [Name] to the right end of the device pin list. |
| Cancel | Ignores the setting and closes this dialog box.  |

**Browse For Folder dialog box**

This dialog box allows you to specify the output destination for files (source code, report file, etc.).

**Figure A-28. Browse For Folder Dialog Box**

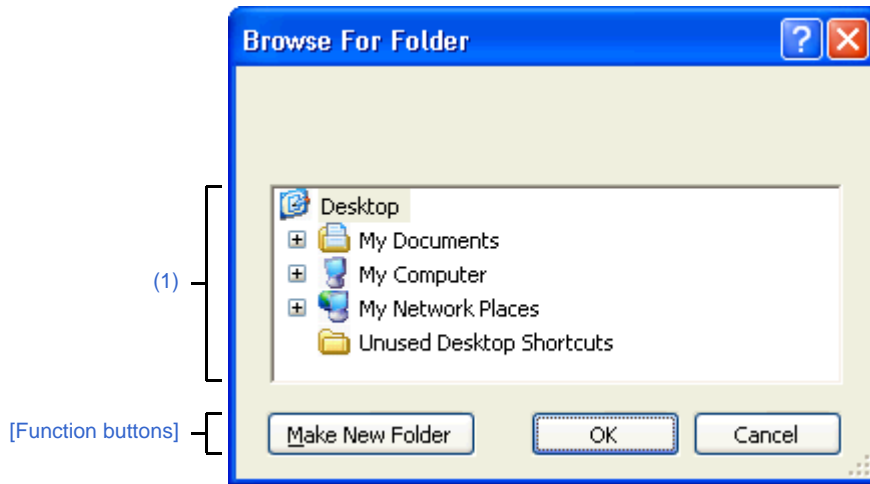

The following items are explained here.

- [How to open]
- [Description of each area]
- [Function buttons]

**[How to open]**

- In the [Generation] tab of the Property panel, click the [...] button in [Output folder].

**[Description of each area]**

**(1) Folder location**

Select the folder to which the files (source code, report file, etc.) are output.

**[Function buttons]**

| Button          | Function   |
|-----------------|--|
| Make New Folder | Creates a "New Folder" below the folder selected in the Folder location.               |
| OK              | Specifies the folder selected in the Folder location as the destination for the files. |
| Cancel          | Ignores the setting and closes this dialog box.  |

**Save As dialog box**

This dialog box allows you to name and save a file (such as a report file).

**Figure A-29. Save As Dialog Box**

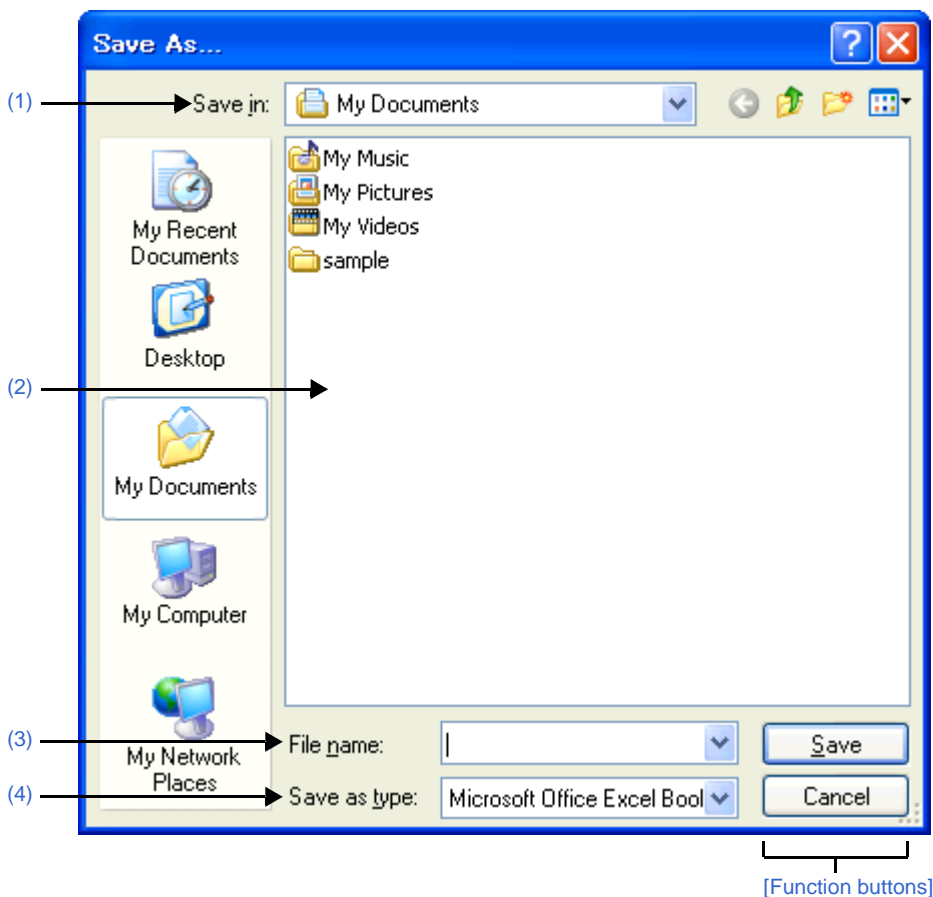

The following items are explained here.

- [How to open]
- [Description of each area]
- [Function buttons]

**[How to open]**

- From the [File] menu, select [Save <object> As...].

**[Description of each area]**

**(1) [Save in]**

Select the folder to which the files (report files, etc.) are output.

**(2) List of files**

This area displays a list of files matching the conditions selected in [Save in] and [Save as type].



**(3) [File name]**

Specify the name of the file to be output.

**(4) [Save as type]**

Select the type of the file to be output.

|                                     |                                    |
|-------------------------------------|------------------------------------|
| Microsoft Office Excel Book (*.xls) | Microsoft Office Excel Book format |
| Bitmap (*.bmp)                      | Bitmap format                      |
| PNG (*.png)                         | PNG format                         |
| JPEG (*.jpg)                        | JPEG format                        |
| EMF (*.emf)                         | EMF format                         |

**[Function buttons]**

| Button | Function   |
|--------|--|
| Save   | Outputs a file having the name specified in the [File name] and [Save as type] to the folder specified in the [Save in]. |
| Cancel | Ignores the setting and closes this dialog box.  |

## APPENDIX B OUTPUT FILES

This appendix describes the files output by Code Generator.

### B.1 Overview

Below is a list of files output by Code Generator.

**Table B-1. File List**

| Unit of Output      | File Name                        | Description   |
|---------------------|----------------------------------|---|
| Peripheral function | CG_PeripheralFunctionName.c      | Initial function, API function  |
|                     | CG_PeripheralFunctionName_user.c | Interrupt function, callback function   |
|                     | CG_PeripheralFunctionName.h      | Defines macros for assigning values to registers  |
| Project             | CG_option.asm                    | Option bytes, secures ROM for MINICUBE2   |
|                     | CG_systeminit.c                  | Call initial function of peripheral function<br>Call <a href="#">CG_ReadResetSource</a> |
|                     | CG_main.c                        | main function   |
|                     | CG_macrodriver.h                 | Defines common macros used by all source files  |
|                     | CG_user_define.h                 | Empty file (for user definitions)   |
|                     | CG_lk.dir                        | Link directive  |

### B.2 Output File

Below are the files (peripheral function) output by Code Generator.

**Table B-2. File List (PeripheralFunction)**

| Peripheral Function | Source File Name | Names of API Functions Included   |
|---------------------|------------------|---|
| System              | CG_system.c      | <a href="#">CLOCK_Init</a><br><a href="#">CG_ChangeClockMode</a><br><a href="#">CG_ChangeFrequency</a><br><a href="#">CG_SelectPowerSaveMode</a><br><a href="#">CG_SelectStabTime</a><br><a href="#">CG_ChangePIIMode</a> |
|                     | CG_system_user.c | <a href="#">CLOCK_UserInit</a><br><a href="#">CG_ReadResetSource</a>  |
|                     | CG_system.h      | -   |
| Port                | CG_port.c        | <a href="#">PORT_Init</a><br><a href="#">PORT_ChangePmnInput</a><br><a href="#">PORT_ChangePmnOutput</a>  |
|                     | CG_port_user.c   | <a href="#">PORT_UserInit</a>   |
|                     | CG_port.h        | -   |
| INT                 | CG_int.c         | <a href="#">INTP_Init</a><br><a href="#">KEY_Init</a><br><a href="#">INT_MaskableInterruptEnable</a><br><a href="#">INTPn_Disable</a>   |

| Peripheral Function | Source File Name | Names of API Functions Included   |
|---------------------|------------------|---|
| INT                 | CG_int.c         | INTPn_Enable<br>KEY_Disable<br>KEY_Enable   |
|                     | CG_int_user.c    | MD_INTPn<br>MD_INTKR<br>INTP_UserInit<br>KEY_UserInit   |
|                     | CG_int.h         | -   |
| Serial              | CG_serial.c      | UART6_Init<br>UART6_Start<br>UART6_Stop<br>UART6_SendData<br>UART6_ReceiveData<br>CSI1n_Init<br>CSI1n_Start<br>CSI1n_Stop<br>CSI1n_ReceiveData<br>CSI1n_SendReceiveData<br>IICA_Init<br>IICA_Stop<br>IICA_MasterSendStart<br>IICA_MasterReceiveStart<br>IICA_StopCondition<br>IICA_SlaveSendStart<br>IICA_SlaveReceiveStart   |
|                     | CG_serial_user.c | MD_INTSR6<br>MD_INTSRE6<br>MD_INTST6<br>MD_INTCSI1n<br>MD_INTIICA0<br>UART6_UserInit<br>UART6_SendEndCallback<br>UART6_ReceiveEndCallback<br>UART6_SoftOverRunCallback<br>UART6_ErrorCallback<br>CSI1n_UserInit<br>CSI1n_SendEndCallback<br>CSI1n_ReceiveEndCallback<br>IICA_UserInit<br>IICA_MasterSendEndCallback<br>IICA_MasterReceiveEndCallback<br>IICA_MasterErrorCallback<br>IICA_SlaveSendEndCallback<br>IICA_SlaveReceiveEndCallback<br>IICA_SlaveErrorCallback<br>IICA_GetStopConditionCallback |

| Peripheral Function   | Source File Name     | Names of API Functions Included   |
|-----------------------|----------------------|---|
| Serial                | CG_serial.h          | -   |
| Operational Amplifier | CG_opamp.c           | OPAMP_Init<br>PGA_Start<br>PGA_Stop<br>PGA_ChangePGAFactor<br>AMP_Start<br>AMP_Stop<br>AMPn_Start<br>AMPn_Stop  |
|                       | CG_opamp_user.c      | OPAMP_UserInit  |
|                       | CG_opamp.h           | -   |
| Comparator            | CG_comparator.c      | Comparator_Init<br>Comparatorm_Start<br>Comparatorm_Stop  |
|                       | CG_comparator_user.c | MD_INTCMPn<br>Comparator_UserInit   |
|                       | CG_comparator.h      | -   |
| A/D                   | CG_ad.c              | AD_Init<br>AD_ComparatorOn<br>AD_ComparatorOff<br>AD_Start<br>AD_Stop<br>AD_SelectADChannel<br>AD_Read<br>AD_ReadByte   |
|                       | CG_ad_user.c         | MD_INTAD<br>AD_UserInit   |
|                       | CG_ad.h              | -   |
| Timer                 | CG_timer.c           | TMX_Init<br>TMXn_Start<br>TMXn_Stop<br>TMXn_ChangeDuty<br>TMXn_ChangeDualDuty<br>TMX_EnableHighImpedanceState<br>TMX_DisableHighImpedanceState<br>TM00_Init<br>TM00_Start<br>TM00_Stop<br>TM00_ChangeTimerCondition<br>TM00_GetFreeRunningValue<br>TM00_SoftwareTriggerOn<br>TM00_ChangeDuty<br>TM00_GetPulseWidth<br>TM5n_Init<br>TM5n_Start |

| Peripheral Function | Source File Name | Names of API Functions Included  |
|---------------------|------------------|--|
| Timer               | CG_timer.c       | TM5n_Stop<br>TM5n_ChangeTimerCondition<br>TM5n_ChangeDuty<br>TMHn_Init<br>TMHn_Start<br>TMHn_Stop<br>TMHn_ChangeTimerCondition<br>TMHn_ChangeDuty<br>TMH1_CarrierOutputEnable<br>TMH1_CarrierOutputDisable   |
|                     | CG_timer_user.c  | MD_INTTMXn<br>MD_INTTM0n0<br>MD_INTTM5n<br>MD_INTMHn<br>TM00_UserInit<br>TM5n_UserInit<br>TMHn_UserInit  |
|                     | CG_timer.h       | -  |
| Watchdog Timer      | CG_wdt.c         | WDT_Restart  |
|                     | CG_wdt.h         | -  |
| RTC                 | CG_rtc.c         | RTC_Init<br>RTC_PowerOff<br>RTC_CounterEnable<br>RTC_CounterDisable<br>RTC_SetHourSystem<br>RTC_CounterSet<br>RTC_CounterGet<br>RTC_ConstPeriodInterruptEnable<br>RTC_ConstPeriodInterruptDisable<br>RTC_AlarmEnable<br>RTC_AlarmDisable<br>RTC_AlarmSet<br>RTC_AlarmGet<br>RTC_IntervalStart<br>RTC_IntervalStop<br>RTC_IntervallInterruptEnable<br>RTC_IntervallInterruptDisable<br>RTC_RTC1HZ_OutputEnable<br>RTC_RTC1HZ_OutputDisable<br>RTC_RTCCL_OutputEnable<br>RTC_RTCCL_OutputDisable<br>RTC_RTCDIV_OutputEnable<br>RTC_RTCDIV_OutputDisable<br>RTC_ChangeCorrectionValue |
|                     | CG_rtc_user.c    | MD_INTRTC<br>MD_INTRTCI  |

| Peripheral Function | Source File Name | Names of API Functions Included   |
|---------------------|------------------|---|
| RTC                 | CG_rtc_user.c    | RTC_UserInit<br>RTC_ConstPeriodInterruptCallback<br>RTC_AlarmInterruptCallback          |
|                     | CG_rtc.h         | -   |
| Clock Output        | CG_pcl.c         | PCL_Init<br>PCL_Start<br>PCL_Stop<br>PCL_ChangeFreq                                     |
|                     | CG_pcl_user.c    | PCL_UserInit  |
|                     | CG_pcl.h         | -   |
| LVI                 | CG_lvi.c         | LVI_Init<br>LVI_InterruptModeStart<br>LVI_ResetModeStart<br>LVI_Stop<br>LVI_SetLVILevel |
|                     | CG_lvi_user.c    | MD_INTLVI<br>LVI_UserInit   |
|                     | CG_lvi.h         | -   |

## APPENDIX C API FUNCTIONS

This appendix describes the API functions output by Code Generator.

### C.1 Overview

Below are the naming conventions for API functions output by Code Generator.

- Macro names are in ALL CAPS.
- The number in front of the macro name is a hexadecimal value; this is the same value as the macro value.
- Local variable names are in all lower case.
- Global variable names start with a "g" and use Camel Case.
- Names of pointers to local variables start with a "p" and are in all lower case.
- Names of pointers to global variables start with a "gp" and use Camel Case.
- Names of elements in enum statements are in ALL CAPS.

### C.2 Output Function

Below is a list of API functions output by Code Generator.

**Table C-1. API Function List**

| Peripheral Function | API Function Name      | Function  |
|---------------------|------------------------|---|
| System              | CLOCK_Init             | Performs initialization required to control the clock generator, on-chip debug, and etc. .      |
|                     | CLOCK_UserInit         | Performs user-defined initialization relating to the clock generator, on-chip debug, and etc. . |
|                     | CG_ReadResetSource     | Performs processing in response to RESET signal.  |
|                     | CG_ChangeClockMode     | Changes the CPU clock/peripheral hardware clock.  |
|                     | CG_ChangeFrequency     | Changes the division ratio of the CPU clock/peripheral hardware clock.                          |
|                     | CG_SelectPowerSaveMode | Configures the CPU's standby function.  |
|                     | CG_SelectStabTime      | Configures the oscillation stabilization time of the X1 clock.                                  |
|                     | CG_ChangePllMode       | Controls the operation of PLL function.   |
| Port                | PORT_Init              | Performs initialization necessary to control port functions.                                    |
|                     | PORT_UserInit          | Performs user-defined initialization relating to the port.                                      |
|                     | PORT_ChangePmnInput    | Switches the pin's I/O mode from output mode to input mode.                                     |
|                     | PORT_ChangePmnOutput   | Switches the pin's I/O mode from input mode to output mode.                                     |
| INT                 | INTP_Init              | Performs initialization necessary to control the external interrupt INTP $n$ functions.         |
|                     | INTP_UserInit          | Performs user-defined initialization relating to the external interrupt INTP $n$ functions.     |
|                     | KEY_Init               | Performs initialization necessary to control the key interrupt INTKR functions.                 |

| Peripheral Function | API Function Name           | Function   |
|---------------------|-----------------------------|--|
| INT                 | KEY_UserInit                | Performs user-defined initialization relating to the key interrupt INTKR functions.            |
|                     | INT_MaskableInterruptEnable | Disables/enables the acceptance of the maskable interrupts.                                    |
|                     | INTPn_Disable               | Disables the acceptance of the maskable interrupts INTP $n$ (external interrupt requests).     |
|                     | INTPn_Enable                | Enables the acceptance of the maskable interrupts INTP $n$ (external interrupt requests).      |
|                     | KEY_Disable                 | Disables the acceptance of the key interrupts INTKR.   |
|                     | KEY_Enable                  | Enables the acceptance of the key interrupts INTKR.  |
| Serial              | UART6_Init                  | Performs initialization of the serial interface (UART6) channel.                               |
|                     | UART6_UserInit              | Performs user-defined initialization of the serial interface (UART6).                          |
|                     | UART6_Start                 | Sets UART communication to standby mode.   |
|                     | UART6_Stop                  | Ends UART communication.   |
|                     | UART6_SendData              | Starts UART data transmission.   |
|                     | UART6_ReceiveData           | Starts UART data reception.  |
|                     | UART6_SendEndCallback       | Performs processing in response to the UART transmission complete interrupt INTST6.            |
|                     | UART6_ReceiveEndCallback    | Performs processing in response to the UART reception complete interrupt INTSR6.               |
|                     | UART6_SoftOverRunCallback   | Performs processing in response to the UART reception complete interrupt INTSR6.               |
|                     | UART6_ErrorCallback         | Performs processing in response to the UART communication error interrupt INTSRE6.             |
|                     | CSI1n_Init                  | Performs initialization of the serial interface (CSI1 $n$ ) channel.                           |
|                     | CSI1n_UserInit              | Performs user-defined initialization of the serial interface (CSI1 $n$ ).                      |
|                     | CSI1n_Start                 | Sets CSI1 $n$ communication to standby mode.   |
|                     | CSI1n_Stop                  | Ends CSI1 $n$ communication.   |
|                     | CSI1n_ReceiveData           | Starts CSI1 $n$ data reception.  |
|                     | CSI1n_SendReceiveData       | Starts CSI1 $n$ data transmission/reception.   |
|                     | CSI1n_SendEndCallback       | Performs processing in response to the CSI1 $n$ communication complete interrupt INTCSI1 $n$ . |
|                     | CSI1n_ReceiveEndCallback    | Performs processing in response to the CSI1 $n$ communication complete interrupt INTCSI1 $n$ . |
|                     | IICA_Init                   | Performs initialization of the serial interface (IICA).  |
|                     | IICA_UserInit               | Performs user-defined initialization of the serial interface (IICA).                           |
|                     | IICA_Stop                   | Ends IICA communication.   |



| Peripheral Function   | API Function Name             | Function  |
|-----------------------|-------------------------------|---|
| Serial                | IICA_MasterSendStart          | Starts IICA master transmission.  |
|                       | IICA_MasterReceiveStart       | Starts IICA master reception.   |
|                       | IICA_StopCondition            | Generates stop conditions.  |
|                       | IICA_MasterSendEndCallback    | Performs processing in response to the IICA communication complete interrupt INTICA0.       |
|                       | IICA_MasterReceiveEndCallback | Performs processing in response to the IICA communication complete interrupt INTICA0.       |
|                       | IICA_MasterErrorCallback      | Performs processing in response to detection of error in IICA master communication.         |
|                       | IICA_SlaveSendStart           | Starts IICA slave transmission.   |
|                       | IICA_SlaveReceiveStart        | Starts IICA slave reception.  |
|                       | IICA_SlaveSendEndCallback     | Performs processing in response to the IICA communication complete interrupt INTICA0.       |
|                       | IICA_SlaveReceiveEndCallback  | Performs processing in response to the IICA communication complete interrupt INTICA0.       |
|                       | IICA_SlaveErrorCallback       | Performs processing in response to detection of error in IICA slave communication.          |
|                       | IICA_GetStopConditionCallback | Performs processing in response to detection of stop condition in IICA slave communication. |
| Operational Amplifier | OPAMP_Init                    | Performs initialization necessary to control operational amplifier functions.               |
|                       | OPAMP_UserInit                | Performs user-defined initialization relating to the operational amplifier.                 |
|                       | PGA_Start                     | Starts the operation of operational amplifier (PGA mode).                                   |
|                       | PGA_Stop                      | Ends the operation of operational amplifier (PGA mode).                                     |
|                       | PGA_ChangePGAFactor           | Sets the input voltage amplification factor of a operational amplifier (PGA mode).          |
|                       | AMP_Start                     | Starts the operation of operational amplifier (single AMP mode).                            |
|                       | AMP_Stop                      | Ends the operation of operational amplifier (single AMP mode).                              |
|                       | AMPn_Start                    | Starts the operation of operational amplifier <i>n</i> (single AMP mode).                   |
|                       | AMPn_Stop                     | Ends the operation of operational amplifier <i>n</i> (single AMP mode).                     |
| Comparator            | Comparator_Init               | Performs initialization necessary to control comparator functions.                          |
|                       | Comparator_UserInit           | Performs user-defined initialization relating to the comparator.                            |
|                       | Comparatom_Start              | Starts the operation of comparator <i>n</i> .   |
|                       | Comparatom_Stop               | Ends the operation of comparator <i>n</i> .   |

| Peripheral Function | API Function Name             | Function  |
|---------------------|-------------------------------|---|
| A/D                 | AD_Init                       | Performs initialization necessary to control A/D converter functions.                       |
|                     | AD_UserInit                   | Performs user-defined initialization relating to the A/D converter.                         |
|                     | AD_ComparatorOn               | Enables operation of voltage converter.   |
|                     | AD_ComparatorOff              | Disables operation of voltage converter.  |
|                     | AD_Start                      | Starts A/D conversion.  |
|                     | AD_Stop                       | Ends A/D conversion.  |
|                     | AD_SelectADChannel            | Configures the analog voltage input pin for A/D conversion.                                 |
|                     | AD_Read                       | Reads the results of A/D conversion (10 bits).  |
|                     | AD_ReadByte                   | Reads the results of A/D conversion (8 bits; most significant 8 bits of 10-bit resolution). |
| Timer               | TMX_Init                      | Performs initialization necessary to control 16-bit timer Xn functions.                     |
|                     | TMXn_Start                    | Starts the count for 16-bit timer Xn.   |
|                     | TMXn_Stop                     | Ends the count for 16-bit timer Xn.   |
|                     | TMXn_ChangeDuty               | Changes the duty ratio of the PWM signal single-output to the TOX0n pin.                    |
|                     | TMXn_ChangeDualDuty           | Changes the duty ratio of the PWM signal dual-output to the TOX0n pin.                      |
|                     | TMX_EnableHighImpedanceState  | Begins high impedance output of the 16-bit timer Xn.  |
|                     | TMX_DisableHighImpedanceState | Ends high impedance output of the 16-bit timer Xn.  |
|                     | TM00_Init                     | Performs initialization necessary to control 16-bit timer/event counter 00 functions.       |
|                     | TM00_UserInit                 | Performs user-defined initialization relating to the 16-bit timer/event counter 00.         |
|                     | TM00_Start                    | Starts the count for 16-bit timer/event counter 00.   |
|                     | TM00_Stop                     | Ends the count for 16-bit timer/event counter 00.   |
|                     | TM00_ChangeTimerCondition     | Changes the value of capture/compare control register 00 (CRC00).                           |
|                     | TM00_GetFreeRunningValue      | Captures the content of the capture register (CR0n0).                                       |
|                     | TM00_SoftwareTriggerOn        | Generates the trigger (software trigger) for one-shot pulse output.                         |
|                     | TM00_ChangeDuty               | Changes the duty ratio of the signal output to the TO00 pin.                                |
|                     | TM00_GetPulseWidth            | Captures the high/low-level width measured for the signal (pulses) input to the TI0n0 pin.  |
|                     | TM5n_Init                     | Performs initialization necessary to control 8-bit timer/event counter 5n functions.        |
|                     | TM5n_UserInit                 | Performs user-defined initialization relating to the 8-bit timer/event counter 5n.          |

| Peripheral Function | API Function Name                    | Function  |
|---------------------|--------------------------------------|---|
| Timer               | TM5n_Start                           | Starts the count for 8-bit timer/event counter 5n.  |
|                     | TM5n_Stop                            | Ends the count for 8-bit timer/event counter 5n.  |
|                     | TM5n_ChangeTimerCondition            | Changes the value of 8-bit timer compare register 5n (CR5n).  |
|                     | TM5n_ChangeDuty                      | Changes the duty ratio of the PWM signal output to the TO5n pin.                                    |
|                     | TMHn_Init                            | Performs initialization necessary to control 8-bit timer Hn functions.                              |
|                     | TMHn_UserInit                        | Performs user-defined initialization relating to the 8-bit timer Hn.                                |
|                     | TMHn_Start                           | Starts the count for 8-bit timer Hn.  |
|                     | TMHn_Stop                            | Ends the count for 8-bit timer Hn.  |
|                     | TMHn_ChangeTimerCondition            | Changes the value of 8-bit timer H compare register 0n/1n (CMP0n/CMP1n).                            |
|                     | TMHn_ChangeDuty                      | Changes the duty ratio of the PWM signal output to the TOHn pin.                                    |
|                     | TMH1_CarrierOutputEnable             | Begins carrier pulse output of the 8-bit timer H1 (carrier generator mode).                         |
|                     | TMH1_CarrierOutputDisable            | Ends carrier pulse output of the 8-bit timer H1 (carrier generator mode).                           |
| Watchdog Timer      | WDT_Restart                          | Clears the watchdog timer counter and resumes counting.   |
| RTC                 | RTC_Init                             | Performs initialization necessary to control real-time counter functions.                           |
|                     | RTC_UserInit                         | Performs user-defined initialization relating to the real-time counter.                             |
|                     | RTC_PowerOff                         | Halts the clock supplied to the real-time counter.  |
|                     | RTC_CounterEnable                    | Starts the count of the real-time counter (year, month, weekday, day, hour, minute, second).        |
|                     | RTC_CounterDisable                   | Ends the count of the real-time counter (year, month, weekday, day, hour, minute, second).          |
|                     | RTC_SetHourSystem                    | Sets the clock type (12-hour or 24-hour clock) of the real-time counter.                            |
|                     | RTC_CounterSet                       | Sets the counter value (year, month, weekday, day, hour, minute, second) of the real-time counter.  |
|                     | RTC_CounterGet                       | Reads the counter value (year, month, weekday, day, hour, minute, second) of the real-time counter. |
|                     | RTC_ConstPeriodInterruptEnable       | Sets the cycle of the interrupts INTRTC, then starts the cyclic interrupt function.                 |
|                     | RTC_ConstPeriodInterruptDisable      | Ends the cyclic interrupt function.   |
|                     | RTC_ConstPeriodInterruptCallback     | Performs processing in response to the cyclic interrupt INTRTC.                                     |
| RTC_AlarmEnable     | Starts the alarm interrupt function. |   |

| Peripheral Function                       | API Function Name  | Function   |
|---|--|--|
| RTC                                       | <a href="#">RTC_AlarmDisable</a>                                     | Ends the alarm interrupt function.   |
|   | <a href="#">RTC_AlarmSet</a>   | Sets the alarm conditions (weekday, hour, minute).                                     |
|   | <a href="#">RTC_AlarmGet</a>   | Reads the alarm conditions (weekday, hour, minute).                                    |
|   | <a href="#">RTC_AlarmInterruptCallback</a>                           | Performs processing in response to the alarm interrupt INTRTC.                         |
|   | <a href="#">RTC_IntervalStart</a>                                    | Starts the interval interrupt function.  |
|   | <a href="#">RTC_IntervalStop</a>                                     | Ends the interval interrupt function.  |
|   | <a href="#">RTC_IntervalInterruptEnable</a>                          | Sets the cycle of the interrupts, then starts the interval interrupt INTRTCI function. |
|   | <a href="#">RTC_IntervalInterruptDisable</a>                         | Ends the interval interrupt function.  |
|   | <a href="#">RTC_RTC1HZ_OutputEnable</a>                              | Enables output of the real-time counter correction clock (1 Hz) to the RTC1HZ pin.     |
|   | <a href="#">RTC_RTC1HZ_OutputDisable</a>                             | Disables output of the real-time counter correction clock (1 Hz) to the RTC1HZ pin.    |
|   | <a href="#">RTC_RTCCL_OutputEnable</a>                               | Enables output of the real-time counter clock (32 kHz source) to the RTCCL pin.        |
|   | <a href="#">RTC_RTCCL_OutputDisable</a>                              | Disables output of the real-time counter clock (32 kHz source) to the RTCCL pin.       |
|   | <a href="#">RTC_RTCDIV_OutputEnable</a>                              | Enables output of the real-time counter clock (32 kHz cycle) to the RTCDIV pin.        |
|   | <a href="#">RTC_RTCDIV_OutputDisable</a>                             | Disables output of the real-time counter clock (32 kHz cycle) to the RTCDIV pin.       |
| <a href="#">RTC_ChangeCorrectionValue</a> | Changes the timing and correction value for correcting clock errors. |  |
| Clock Output                              | <a href="#">PCL_Init</a>   | Performs initialization necessary to control clock output control circuit functions.   |
|   | <a href="#">PCL_UserInit</a>   | Performs user-defined initialization relating to the clock output control circuits.    |
|   | <a href="#">PCL_Start</a>  | Starts clock output.   |
|   | <a href="#">PCL_Stop</a>   | Ends clock output.   |
|   | <a href="#">PCL_ChangeFreq</a>                                       | Changes the output clock to the PCL pin.   |
| LVI                                       | <a href="#">LVI_Init</a>   | Performs initialization necessary to control low-voltage detector functions.           |
|   | <a href="#">LVI_UserInit</a>   | Performs user-defined initialization relating to the low-voltage detector.             |
|   | <a href="#">LVI_InterruptModeStart</a>                               | Starts low-voltage detection (when in interrupt generation mode).                      |
|   | <a href="#">LVI_ResetModeStart</a>                                   | Starts low-voltage detection (when in internal reset mode).                            |
|   | <a href="#">LVI_Stop</a>   | Stops low-voltage detection.   |
|   | <a href="#">LVI_SetLVILevel</a>                                      | Sets the low-voltage detection level.  |

C.3 Function Reference

This section describes the API functions output by Code Generator, using the following notation format.

Figure C-1. Notation Format of API Functions

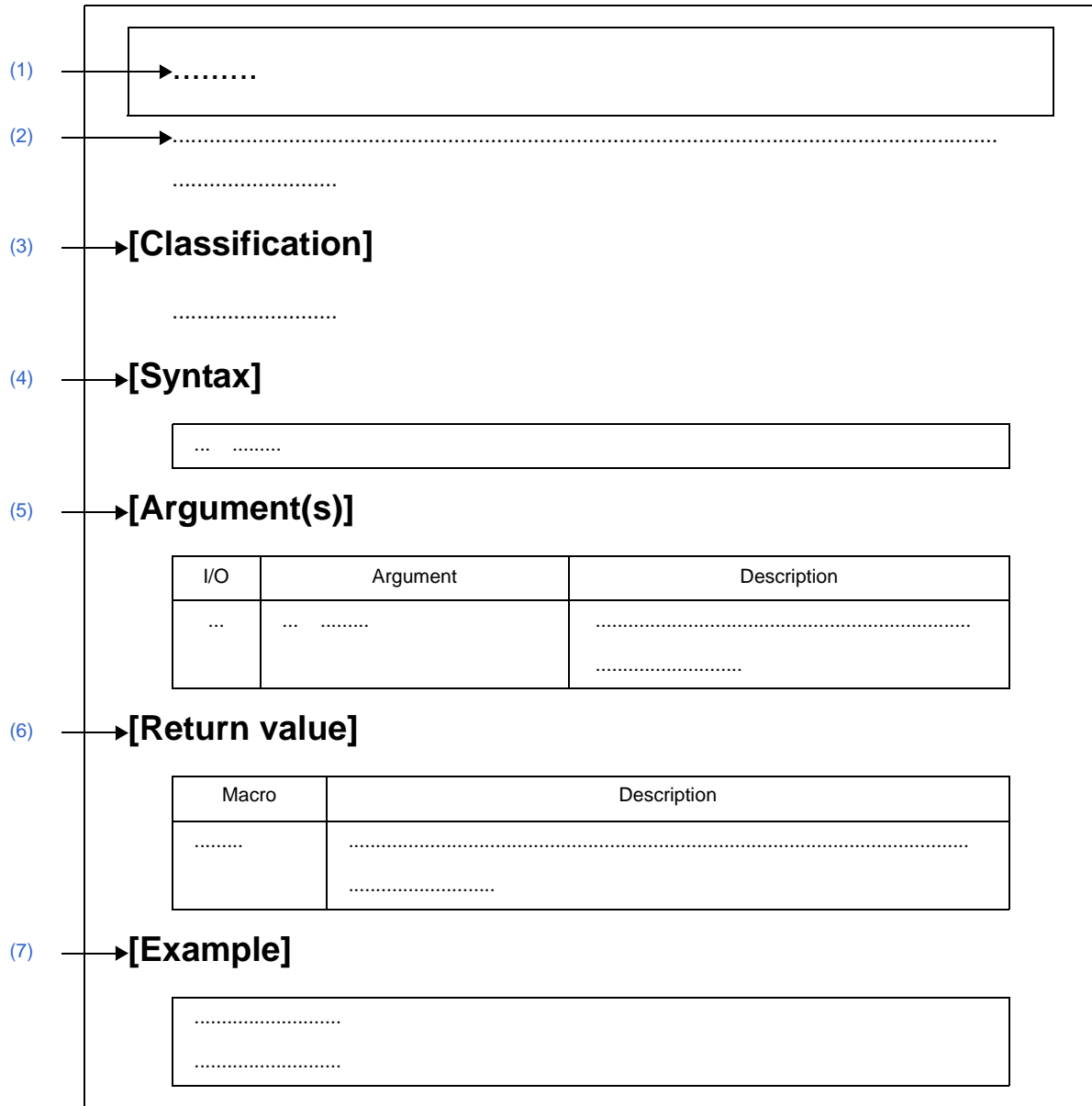

(1) **Name**

Indicates the name of the API function.

(2) **Outline**

Outlines the functions of the API function.

(3) **[Classification]**

Indicates the name of the C source file to which the API function is output.

(4) **[Syntax]**

Indicates the format to be used when describing an API function to be called in C language.

**(5) [Argument(s)]**

API function arguments are explained in the following format.

| I/O | Argument | Description |
|-----|----------|-------------|
| (a) | (b)      | (c)         |

**(a) I/O**

Argument classification

I ... Input argument

O ... Output argument

**(b) Argument**

Argument data type

**(c) Description**

Description of argument

**(6) [Return value]**

API function return value is explained in the following format.

| Macro | Description |
|-------|-------------|
| (a)   | (b)         |

**(a) Macro**

Macro of return value

**(b) Description**

Description of return value

**(7) [Example]**

Shows an example of the API function in use.

C.3.1 System

Below is a list of API functions output by Code Generator for system use.

**Table C-2. API Functions: [System]**

| API Function Name      | Function  |
|------------------------|---|
| CLOCK_Init             | Performs initialization required to control the clock generator, on-chip debug, and etc. .      |
| CLOCK_UserInit         | Performs user-defined initialization relating to the clock generator, on-chip debug, and etc. . |
| CG_ReadResetSource     | Performs processing in response to RESET signal.  |
| CG_ChangeClockMode     | Changes the CPU clock/peripheral hardware clock.  |
| CG_ChangeFrequency     | Changes the division ratio of the CPU clock/peripheral hardware clock.                          |
| CG_SelectPowerSaveMode | Configures the CPU's standby function.  |
| CG_SelectStabTime      | Configures the oscillation stabilization time of the X1 clock.                                  |
| CG_ChangePllMode       | Controls the operation of PLL function.   |

**CLOCK\_Init**

Performs initialization required to control the clock generator, on-chip debug and etc. .

**[Classification]**

CG\_system.c

**[Syntax]**

```
void    CLOCK_Init ( void );
```

**[Argument(s)]**

None.

**[Return value]**

None.



**CLOCK\_UserInit**

Performs user-defined initialization relating to the clock generator, on-chip debug, and etc. .

**Remark** This API function is called as the [CLOCK\\_Init](#) callback routine.

**[Classification]**

CG\_system\_user.c

**[Syntax]**

```
void    CLOCK_UserInit ( void );
```

**[Argument(s)]**

None.

**[Return value]**

None.

**CG\_ReadResetSource**

Performs processing in response to RESET signal.

**[Classification]**

CG\_system\_user.c

**[Syntax]**

```
void CG_ReadResetSource ( void );
```

**[Argument(s)]**

None.

**[Return value]**

None.

**[Example]**

Below are examples of the different processes executing depending on the RESET signal trigger.

[CG\_Systeminit.c]

```
void systeminit ( void ) {  
    CG_ReadResetSource ();      /* Processes executed by RESET signal trigger */  
    .....  
}
```

[CG\_system\_user.c]

```
#include "CG_macrodriver.h"  
void CG_ReadResetSource ( void ) {  
    UCHAR flag = RESF;          /* Reset control flag register: Obtain RESF contents */  
    if ( flag & 0x1 ) {         /* Trigger identification: Check LVIRF flag */  
        ..... /* Internal reset request by low-voltage detector */  
    } else if ( flag & 0x10 ) { /* Trigger identification: Check WDTRF flag */  
        ..... /* Internal reset request by watchdog timer */  
    }  
    .....  
}
```

**CG\_ChangeClockMode**

Changes the CPU clock/peripheral hardware clock.

**[Classification]**

CG\_system.c

**[Syntax]**

```
#include "CG_macrodriver.h"
#include "CG_system.h"
MD_STATUS CG_ChangeClockMode ( enum ClockMode mode );
```

**[Argument(s)]**

| I/O | Argument             | Description   |
|-----|----------------------|---|
| I   | enum ClockMode mode; | CPU clock (fCPU)/peripheral hardware clock (fPRS) type<br>HIOCLK: fCPU/fPRS >> Internal high-speed oscillation clock<br>HIOSYSCLK: fCPU >> Internal high-speed oscillation clock, fPRS >> High-speed system clock<br>SYSX1CLK: fCPU/fPRS >> X1 clock<br>SYSEXTCLK: fCPU/fPRS >> External main system clock<br>SUBXT1CLK: fCPU >> XT1 clock<br>SUBEXTCLK: fCPU >> External subsystem clock |

**Remark** SUBXT1CLK and SUBEXTCLK can only be specified when the target device is a 78K0/KC2-L.

**[Return value]**

| Macro       | Description   |
|-------------|---|
| MD_OK       | Normal completion   |
| MD_ERROR1   | Exit with error (abend)<br>- Cannot change fCPU/fPRS to the internal high-speed oscillation clock.  |
| MD_ERROR2   | Exit with error (abend)<br>- Cannot change fCPU to the internal high-speed oscillation clock.<br>- Cannot change fPRS to the high-speed system clock. |
| MD_ERROR3   | Exit with error (abend)<br>- Cannot change fCPU/fPRS to the X1 clock.   |
| MD_ERROR4   | Exit with error (abend)<br>- Cannot change fCPU/fPRS to the external main system clock.   |
| MD_ERROR5   | Exit with error (abend) [Kx2-L]<br>- Cannot change fCPU to the XT1 clock.   |
| MD_ERROR6   | Exit with error (abend) [Kx2-L]<br>- Cannot change fCPU to the external subsystem clock.  |
| MD_ARGERROR | Invalid argument specification  |

**Remark** The values MD\_ERROR5 and MD\_ERROR6 will only be returned when the target device is a 78K0/KC2-L.

**CG\_ChangeFrequency**

Changes the division ratio of the CPU clock/peripheral hardware clock.

**[Classification]**

CG\_system.c

**[Syntax]**

```
#include "CG_macrodriver.h"
#include "CG_system.h"
MD_STATUS CG_ChangeFrequency ( enum CPUClock clock );
```

**[Argument(s)]**

| I/O | Argument                     | Description   |
|-----|------------------------------|---|
| I   | enum CPUClock <i>clock</i> ; | Division ratio type<br>SYSTEMCLOCK: fMAIN<br>SYSONEHALF: fMAIN/2<br>SYSONEFOURTH: fMAIN/4<br>SYSONEEIGHTH: fMAIN/8<br>SYSONESIXTEENTH: fMAIN/16 |

**Remark** "fMAIN" signifies the frequency of the main system clock.

**[Return value]**

| Macro       | Description                    |
|-------------|--------------------------------|
| MD_OK       | Normal completion              |
| MD_ARGERROR | Invalid argument specification |

**CG\_SelectPowerSaveMode**

Configures the CPU's standby function.

**[Classification]**

CG\_system.c

**[Syntax]**

```
#include "CG_macrodriver.h"
#include "CG_system.h"
MD_STATUS CG_SelectPowerSaveMode ( enum PSLevel level );
```

**[Argument(s)]**

| I/O | Argument            | Description   |
|-----|---------------------|---|
| I   | enum PSLevel level; | Standby function type<br>PSSTOP: STOP mode<br>PSHALT: HALT mode |

**[Return value]**

| Macro       | Description  |
|-------------|--|
| MD_OK       | Normal completion  |
| MD_ERROR    | Exit with error (abend) [Kx2-L]<br>- If the CPU is operating by XT1 clock, then STOP mode cannot be specified. |
| MD_ARGERROR | Invalid argument specification   |

**Remark** The value MD\_ERROR will only be returned when the target device is a 78K0/KC2-L.

**[Example]**

Below is an example of changing the standby function to "STOP mode".

[CG\_main.c]

```
#include "CG_macrodriver.h"
#include "CG_system.h"
void main ( void ) {
    MD_STATUS ret;
    .....
    TM00_Stop (); /* Stop count */
    ret = CG_SelectPowerSaveMode ( PSSTOP ); /* Change to STOP mode */
    if ( ret != MD_OK ) {
        while ( 1 );
    }
}
```

```
TM00_Init ();                /* Initialize TM00 */
TM00_Start ();              /* Start count */
.....
}
```

**CG\_SelectStabTime**

Configures the oscillation stabilization time of the X1 clock.

**[Classification]**

CG\_system.c

**[Syntax]**

```
#include "CG_macrodriver.h"
#include "CG_system.h"
MD_STATUS CG_SelectStabTime ( enum StabTime waittime );
```

**[Argument(s)]**

| I/O | Argument                | Description  |
|-----|-------------------------|--|
| I   | enum StabTime waittime; | Oscillation stabilization time type<br>STLEVEL0: 2 <sup>11</sup> /fx<br>STLEVEL1: 2 <sup>13</sup> /fx<br>STLEVEL2: 2 <sup>14</sup> /fx<br>STLEVEL3: 2 <sup>15</sup> /fx<br>STLEVEL4: 2 <sup>16</sup> /fx |

**Remark** "fx" signifies the frequency of the X1 clock.

**[Return value]**

| Macro       | Description                    |
|-------------|--------------------------------|
| MD_OK       | Normal completion              |
| MD_ARGERROR | Invalid argument specification |



**CG\_ChangePllMode**

Controls the operation of PLL function.

**[Classification]**

CG\_system.c

**[Syntax]**

```
#include "CG_macrodriver.h"
#include "CG_system.h"
MD_STATUS CG_ChangePllMode ( enum PllMode pllmode );
```

**[Argument(s)]**

| I/O | Argument                      | Description   |
|-----|-------------------------------|---|
| I   | enum PllMode <i>pllmode</i> ; | Control of operation<br>SYSPLLON: Enable operation<br>SYSPLLOFF: Stop operation |

**[Return value]**

| Macro       | Description                    |
|-------------|--------------------------------|
| MD_OK       | Normal completion              |
| MD_ARGERROR | Invalid argument specification |

**C.3.2 Port**

Below is a list of API functions output by Code Generator for port use.

**Table C-3. API Functions: [Port]**

| API Function Name                    | Function   |
|--------------------------------------|--|
| <a href="#">PORT_Init</a>            | Performs initialization necessary to control port functions. |
| <a href="#">PORT_UserInit</a>        | Performs user-defined initialization relating to the port.   |
| <a href="#">PORT_ChangePmnInput</a>  | Switches the pin's I/O mode from output mode to input mode.  |
| <a href="#">PORT_ChangePmnOutput</a> | Switches the pin's I/O mode from input mode to output mode.  |

**PORT\_Init**

Performs initialization necessary to control port functions.

**[Classification]**

CG\_port.c

**[Syntax]**

```
void PORT_Init ( void );
```

**[Argument(s)]**

None.

**[Return value]**

None.

**PORT\_UserInit**

Performs user-defined initialization relating to the port.

**Remark** This API function is called as the [PORT\\_Init](#) callback routine.

**[Classification]**

CG\_port\_user.c

**[Syntax]**

```
void PORT_UserInit ( void );
```

**[Argument(s)]**

None.

**[Return value]**

None.

**PORT\_ChangePmnInput**

Switches the pin's I/O mode from output mode to input mode.

**[Classification]**

CG\_port.c

**[Syntax]**

The format for specifying this API function differs according to whether the target pin has built-in pull-up resistance/a SMBus input buffer.

- Built-in pull-up resistance: none; SMBus input buffer: none

```
void PORT_ChangePmnInput ( void );
```

- Built-in pull-up resistance: yes; SUBus input buffer: none

```
#include "CG_macrodriver.h"
void PORT_ChangePmnInput ( BOOL enablepu );
```

- Built-in pull-up resistance: yes; SMBus input buffer: yes

```
#include "CG_macrodriver.h"
void PORT_ChangePmnInput ( BOOL enablepu, BOOL enablesmbus );
```

**Remark** *mn* is the port number.

**[Argument(s)]**

| I/O | Argument                  | Description   |
|-----|---------------------------|---|
| I   | BOOL <i>enablepu</i> ;    | Built-in pull-up resistance used<br>MD_TRUE: Yes<br>MD_FALSE: No                  |
| I   | BOOL <i>enablesmbus</i> ; | Input buffer type<br>MD_TRUE: SMBus input buffer<br>MD_FALSE: Normal input buffer |

**[Return value]**

None.

**[Example 1]**

Below is shown an example where pin P00 (built-in pull-up resistance: yes; SMBus input buffer: none) is changed as follows:

I/O mode type:                      Input mode  
Built-in pull-up resistance used:    Yes

[CG\_main.c]

```

#include    "CG_macrodriver.h"
void main ( void ) {
    .....
    PORT_ChangeP00Input ( MD_TRUE );    /* Switch I/O mode */
    .....
}

```

**[Example 2]**

Below is shown an example where pin P00 (built-in pull-up resistance: yes; SMBus input buffer: none) is changed as follows:

|                                   |            |
|-----------------------------------|------------|
| I/O mode type:                    | Input mode |
| Built-in pull-up resistance used: | No         |

[CG\_main.c]

```

#include    "CG_macrodriver.h"
void main ( void ) {
    .....
    PORT_ChangeP00Input ( MD_FALSE );    /* Switch I/O mode */
    .....
}

```

**[Example 3]**

Below is shown an example where pin P04 (built-in pull-up resistance: yes; SMBus input buffer: yes) is changed as follows:

|                                   |                    |
|-----------------------------------|--------------------|
| I/O mode type:                    | Input mode         |
| Built-in pull-up resistance used: | No                 |
| Input buffer type:                | SMBus input buffer |

[CG\_main.c]

```

#include    "CG_macrodriver.h"
void main ( void ) {
    .....
    PORT_ChangeP04Input ( MD_FALSE, MD_TRUE );    /* Switch I/O mode */
    .....
}

```

**PORT\_ChangePmnOutput**

Switches the pin's I/O mode from input mode to output mode.

**[Classification]**

CG\_port.c

**[Syntax]**

The format for specifying this API function differs according to whether the target pin conducts N-ch open drain output.

- N-ch open drain output: none

```
#include    "CG_macrodriver.h"
void    PORT_ChangePmnOutput ( BOOL initialvalue );
```

- N-ch open drain output: yes

```
#include    "CG_macrodriver.h"
void    PORT_ChangePmnOutput ( BOOL enablench, BOOL initialvalue );
```

**Remark** *nm* is the port number.

**[Argument(s)]**

| I/O | Argument                   | Description  |
|-----|----------------------------|--|
| I   | BOOL <i>enablench</i> ;    | Output mode type<br>MD_TRUE: N-ch open drain output (V <sub>DD</sub> withstand voltage) mode<br>MD_FALSE: Normal output mode |
| I   | BOOL <i>initialvalue</i> ; | Initial output value<br>MD_SET: Output HIGH level "1"<br>MD_CLEAR: Output LOW level "0"                                      |

**[Return value]**

None.

**[Example 1]**

Below is shown an example where pin P00 (N-ch open drain output: none) is changed as follows:

I/O mode type: Output mode  
Initial output value: Output HIGH level "1"

[CG\_main.c]

```
#include    "CG_macrodriver.h"
void main ( void ) {
    .....
    PORT_ChangeP00Output ( MD_SET );    /* Switch I/O mode */
```

```
.....  
}
```

**[Example 2]**

Below is shown an example where pin P04 (N-ch open drain output: yes) is changed as follows:

I/O mode type: Output mode

Output mode type: N-ch open drain output (VDD withstand voltage) mode

Initial output value: Output LOW level "0"

[CG\_main.c]

```
#include "CG_macrodriver.h"  
void main ( void ) {  
.....  
PORT_ChangeP04Output ( MD_TRUE, MD_CLEAR ); /* Switch I/O mode */  
.....  
}
```



## C.3.3 INT

Below is a list of API functions output by Code Generator for interrupt and key interrupt use.

Table C-4. API Functions: [INT]

| API Function Name           | Function  |
|-----------------------------|---|
| INTP_Init                   | Performs initialization necessary to control the external interrupt INTP $n$ functions.     |
| INTP_UserInit               | Performs user-defined initialization relating to the external interrupt INTP $n$ functions. |
| KEY_Init                    | Performs initialization necessary to control the key interrupt INTKR functions.             |
| KEY_UserInit                | Performs user-defined initialization relating to the key interrupt INTKR functions.         |
| INT_MaskableInterruptEnable | Disables/enables the acceptance of the maskable interrupts.                                 |
| INTPn_Disable               | Disables the acceptance of the maskable interrupts INTP $n$ (external interrupt requests).  |
| INTPn_Enable                | Enables the acceptance of the maskable interrupts INTP $n$ (external interrupt requests).   |
| KEY_Disable                 | Disables the acceptance of the key interrupts INTKR.  |
| KEY_Enable                  | Enables the acceptance of the key interrupts INTKR.   |

**INTP\_Init**

Performs initialization necessary to control the external interrupt INTP $n$  functions.

**[Classification]**

CG\_int.c

**[Syntax]**

```
void    INTP_Init ( void );
```

**[Argument(s)]**

None.

**[Return value]**

None.

**INTP\_UserInit**

Performs user-defined initialization relating to the external interrupt INTP $n$  functions.

**Remark** This API function is called as the [INTP\\_Init](#) callback routine.

**[Classification]**

CG\_int\_user.c

**[Syntax]**

```
void    INTP_UserInit ( void );
```

**[Argument(s)]**

None.

**[Return value]**

None.

**KEY\_Init**

Performs initialization necessary to control the key interrupt INTKR functions.

**[Classification]**

CG\_int.c

**[Syntax]**

```
void KEY_Init ( void );
```

**[Argument(s)]**

None.

**[Return value]**

None.

**KEY\_UserInit**

Performs user-defined initialization relating to the key interrupt INTKR functions.

**Remark** This API function is called as the [KEY\\_Init](#) callback routine.

**[Classification]**

CG\_int\_user.c

**[Syntax]**

```
void KEY_UserInit ( void );
```

**[Argument(s)]**

None.

**[Return value]**

None.

**INT\_MaskableInterruptEnable**

Disables/enables the acceptance of the maskable interrupts.

**[Classification]**

CG\_int.c

**[Syntax]**

```
#include "CG_macrodriver.h"
#include "CG_int.h"
MD_STATUS INT_MaskableInterruptEnable ( enum MaskableSource name, BOOL enableflag );
```

**[Argument(s)]**

| I/O | Argument                          | Description   |
|-----|-----------------------------------|---|
| I   | enum MaskableSource <i>name</i> ; | Maskable interrupt type<br>INT_xxx: Maskable interrupt                                      |
| I   | BOOL <i>enableflag</i> ;          | Acceptance enabled/disabled<br>MD_TRUE: Acceptance enabled<br>MD_FALSE: Acceptance disabled |

**Remark** See the header file CG\_int.h for details about the maskable interrupt type INT\_xxx.

**[Return value]**

| Macro       | Description                    |
|-------------|--------------------------------|
| MD_OK       | Normal completion              |
| MD_ARGERROR | Invalid argument specification |

**[Example 1]**

Below is an example of disabling acceptance of the maskable interrupt INTTP0.

[CG\_main.c]

```
#include "CG_macrodriver.h"
#include "CG_int.h"
void main ( void ) {
    .....
    INT_MaskableInterruptEnable ( INT_INTTP0, MD_FALSE ); /* Disable acceptance of maskable
interrupt INTTP0 */
    .....
}
```

**[Example 2]**

Below is an example of enabling acceptance of the maskable interrupt INTTP0.

[CG\_main.c]

```
#include "CG_macrodriver.h"
#include "CG_int.h"
void main ( void ) {
    .....
    INT_MaskableInterruptEnable ( INT_INTTP0, MD_TRUE ); /* Enable acceptance of maskable
interrupt INTTP0 */
    .....
}
```

**INTP $n$ \_Disable**

Disables the acceptance of the maskable interrupts INTP $n$  (external interrupt requests).

**[Classification]**

CG\_int.c

**[Syntax]**

```
void    INTP $n$ _Disable ( void );
```

**Remark**  $n$  is the interrupt factor number.

**[Argument(s)]**

None.

**[Return value]**

None.



**INTP $n$ \_Enable**

Enables the acceptance of the maskable interrupts INTP $n$  (external interrupt requests).

**[Classification]**

CG\_int.c

**[Syntax]**

```
void    INTP $n$ _Enable ( void );
```

**Remark**  $n$  is the interrupt factor number.

**[Argument(s)]**

None.

**[Return value]**

None.

**KEY\_Disable**

Disables the acceptance of the key interrupts INTKR.

**[Classification]**

CG\_int.c

**[Syntax]**

```
void KEY_Disable ( void );
```

**[Argument(s)]**

None.

**[Return value]**

None.

**KEY\_Enable**

Enables the acceptance of the key interrupts INTKR.

**[Classification]**

CG\_int.c

**[Syntax]**

```
void KEY_Enable ( void );
```

**[Argument(s)]**

None.

**[Return value]**

None.

## C.3.4 Serial

Below is a list of API functions output by Code Generator for serial array unit and serial interface use.

Table C-5. API Functions: [Serial]

| API Function Name             | Function  |
|-------------------------------|---|
| UART6_Init                    | Performs initialization of the serial interface (UART6) channel.                        |
| UART6_UserInit                | Performs user-defined initialization of the serial interface (UART6).                   |
| UART6_Start                   | Sets UART communication to standby mode.  |
| UART6_Stop                    | Ends UART communication.  |
| UART6_SendData                | Starts UART data transmission.  |
| UART6_ReceiveData             | Starts UART data reception.   |
| UART6_SendEndCallback         | Performs processing in response to the UART transmission complete interrupt INTST6.     |
| UART6_ReceiveEndCallback      | Performs processing in response to the UART reception complete interrupt INTSR6.        |
| UART6_SoftOverRunCallback     | Performs processing in response to the serial transfer end interrupt INTSR6.            |
| UART6_ErrorCallback           | Performs processing in response to the UART communication error interrupt INTSRE6.      |
| CSI1n_Init                    | Performs initialization of the serial interface (CSI1n) channel.                        |
| CSI1n_UserInit                | Performs user-defined initialization of the serial interface (CSI1n).                   |
| CSI1n_Start                   | Sets CSI1n communication to standby mode.   |
| CSI1n_Stop                    | Ends CSI1n communication.   |
| CSI1n_ReceiveData             | Starts CSI1n data reception.  |
| CSI1n_SendReceiveData         | Starts CSI1n data transmission/reception.   |
| CSI1n_SendEndCallback         | Performs processing in response to the CSI1n communication complete interrupt INTCSI1n. |
| CSI1n_ReceiveEndCallback      | Performs processing in response to the CSI1n communication complete interrupt INTSCI1n. |
| IICA_Init                     | Performs initialization of the serial interface (IICA).                                 |
| IICA_UserInit                 | Performs user-defined initialization of the serial interface (IICA).                    |
| IICA_Stop                     | Ends IICA communication.  |
| IICA_MasterSendStart          | Starts IICA master transmission.  |
| IICA_MasterReceiveStart       | Starts IICA master reception.   |
| IICA_StopCondition            | Generates stop conditions.  |
| IICA_MasterSendEndCallback    | Performs processing in response to the IICA communication complete interrupt INTIICA0.  |
| IICA_MasterReceiveEndCallback | Performs processing in response to the IICA communication complete interrupt INTIICA0.  |
| IICA_MasterErrorCallback      | Performs processing in response to detection of error in IICA master communication.     |
| IICA_SlaveSendStart           | Starts IICA slave transmission.   |
| IICA_SlaveReceiveStart        | Starts IICA slave reception.  |

| API Function Name                             | Function  |
|---|---|
| <a href="#">IICA_SlaveSendEndCallback</a>     | Performs processing in response to the IICA communication complete interrupt INTIICA0.      |
| <a href="#">IICA_SlaveReceiveEndCallback</a>  | Performs processing in response to the IICA communication complete interrupt INTIICA0.      |
| <a href="#">IICA_SlaveErrorCallback</a>       | Performs processing in response to detection of error in IICA slave communication.          |
| <a href="#">IICA_GetStopConditionCallback</a> | Performs processing in response to detection of stop condition in IICA slave communication. |

**UART6\_Init**

Performs initialization of the serial interface (UART6) channel.

**[Classification]**

CG\_serial.c

**[Syntax]**

```
void    UART6_Init ( void );
```

**[Argument(s)]**

None.

**[Return value]**

None.

**UART6\_UserInit**

Performs user-defined initialization of the serial interface (UART6).

**Remark** This API function is called as the [UART6\\_Init](#) callback routine.

**[Classification]**

CG\_serial\_user.c

**[Syntax]**

```
void    UART6_UserInit ( void );
```

**[Argument(s)]**

None.

**[Return value]**

None.

**UART6\_Start**

Sets UART communication to standby mode.

**[Classification]**

CG\_serial.c

**[Syntax]**

```
void    UART6_Start ( void );
```

**[Argument(s)]**

None.

**[Return value]**

None.



**UART6\_Stop**

Ends UART communication.

**[Classification]**

CG\_serial.c

**[Syntax]**

```
void    UART6_Stop ( void );
```

**[Argument(s)]**

None.

**[Return value]**

None.

**UART6\_SendData**

Starts UART data transmission.

- Remarks 1.** This API function repeats the byte-level UART transmission from the buffer specified in parameter *txbuf* the number of times specified in parameter *txnum*.
- 2.** When performing a UART transmission, [UART6\\_Start](#) must be called before this API function is called.

**[Classification]**

CG\_serial.c

**[Syntax]**

```
#include "CG_macrodriver.h"
MD_STATUS UART6_SendData ( UCHAR *txbuf, USHORT txnum );
```

**[Argument(s)]**

| I/O | Argument               | Description                                       |
|-----|------------------------|---|
| I   | UCHAR * <i>txbuf</i> ; | Pointer to a buffer storing the transmission data |
| I   | USHORT <i>txnum</i> ;  | Total amount of data to send                      |

**Remark** You can only set 1 for the total *txnum* of the sending data in case the serial interface (UART6) operates in DALI mode.

**[Return value]**

| Macro       | Description                    |
|-------------|--------------------------------|
| MD_OK       | Normal completion              |
| MD_ARGERROR | Invalid argument specification |

**[Example]**

Below is an example of sending a UART transmission of four bytes of fixed-length data one time.

[CG\_main.c]

```
#include "CG_macrodriver.h"
BOOL gFlag; /* Transmission complete flag */
void main ( void ) {
    UCHAR txbuf[] = "ABCD";
    USHORT txnum = 4;
    gFlag = 1; /* Initialize transmission complete flag */
    .....
    UART6_Start (); /* Start UART communication*/
    UART6_SendData ( &txbuf, txnum ); /* Start UART data transmission */
```

```
while ( gFlag );          /* Wait for txnum transmissions */
.....
}
```

[CG\_serial\_user.c]

```
#include "CG_macrodriver.h"
extern BOOL gFlag;          /* Transmission complete flag */
__interrupt void MD_INTST6 ( void ) { /* Interrupt processing for INTST6 */
    if ( gUart6TxCnt > 0 ) {
        .....
    } else {
        UART6_SendEndCallback (); /* Call callback routine */
    }
}

void UART6_SendEndCallback ( void ) { /* Callback routine for INTST6 */
    gFlag = 0; /* Set transmission complete flag */
}
```

**UART6\_ReceiveData**

Starts UART data reception.

- Remarks 1.** This API function performs byte-level UART reception the number of times specified by the parameter *rxnum*, and stores the data in the buffer specified by the parameter *rxbuf*.
- 2.** Actual UART reception starts after this API function is called, and [UART6\\_Start](#) is then called.

**[Classification]**

CG\_serial.c

**[Syntax]**

```
#include "CG_macrodriver.h"
MD_STATUS UART6_ReceiveData ( UCHAR *rxbuf, USHORT rxnum );
```

**[Argument(s)]**

| I/O | Argument               | Description                                    |
|-----|------------------------|--|
| O   | UCHAR * <i>rxbuf</i> ; | Pointer to a buffer to store the received data |
| I   | USHORT <i>rxnum</i> ;  | Total amount of data to receive                |

**[Return value]**

| Macro       | Description                    |
|-------------|--------------------------------|
| MD_OK       | Normal completion              |
| MD_ARGERROR | Invalid argument specification |

**Remark** You can only set 2 for the total *rxnum* of the receiving data in case the serial interface (UART6) operates in DALI mode.

**[Example]**

Below is an example of UART reception of four bytes of fixed-length data one time.

[CG\_main.c]

```
#include "CG_macrodriver.h"
BOOL gFlag; /* Reception complete flag */
void main ( void ) {
    UCHAR rxbuf[10];
    USHORT rxnum = 4;
    gFlag = 1; /* Initialize reception complete flag */
    .....
    UART6_ReceiveData ( &rxbuf, rxnum ); /* Start UART data reception */
    UART6_Start (); /* Start UART communication */
}
```

```
while ( gFlag );          /* Wait for rxnum receptions */
.....
}
```

[CG\_serial\_user.c]

```
#include "CG_macrodriver.h"
extern BOOL gFlag;          /* Reception complete flag */
__interrupt void MD_INTSR6 ( void ) { /* Interrupt processing for INTSR6 */
    .....
    if ( gUart6RxLen > gUart6RxCnt ) {
        .....
        if ( gUart6RxLen == gUart6RxCnt ) {
            UART6_ReceiveEndCallback (); /* Call callback routine */
        }
    }
}

void UART6_ReceiveEndCallback ( void ) { /* Callback routine for INTSR6 */
    gFlag = 0;          /* Set reception complete flag */
}
```

**UART6\_SendEndCallback**

Performs processing in response to the UART transmission complete interrupt INTST6.

**Remark** This API function is called as the callback routine of interrupt process MD\_INTST6 corresponding to the UART transmission complete interrupt INTST6 (performed when number of transmission data specified by [UART6\\_SendData](#) parameter *txnum* has been completed).

**[Classification]**

CG\_serial\_user.c

**[Syntax]**

```
void UART6_SendEndCallback ( void );
```

**[Argument(s)]**

None.

**[Return value]**

None.

**UART6\_ReceiveEndCallback**

Performs processing in response to the UART reception complete interrupt INTSR6.

**Remark** This API function is called as the callback routine of interrupt process MD\_INTSR6 corresponding to the UART reception complete interrupt INTSR6 (performed when number of received data specified by [UART6\\_ReceiveData](#) parameter *rxnum* has been completed).

**[Classification]**

CG\_serial\_user.c

**[Syntax]**

```
void UART6_ReceiveEndCallback ( void );
```

**[Argument(s)]**

None.

**[Return value]**

None.

**UART6\_SoftOverRunCallback**

Performs processing in response to the UART reception complete interrupt INTSR6.

**Remark** This API function is called as the callback routine of interrupt process MD\_INTSR6 corresponding to the UART reception complete interrupt INTSR6 (process performed when the amount of data received is greater than the parameter *rxnum* specified for [UART6\\_ReceiveData](#)).

**[Classification]**

CG\_serial\_user.c

**[Syntax]**

- [Ix2]

```
void UART6_SoftOverRunCallback ( USHORT rx_data );
```

- [Kx2-L]

```
void UART6_SoftOverRunCallback ( UCHAR rx_data );
```

**[Argument(s)]**

| I/O | Argument                | Description  |
|-----|-------------------------|--|
| O   | USHORT <i>rx_data</i> ; | Received data (data received greater than the number specified in the parameter <i>rxnum</i> for <a href="#">UART6_ReceiveData</a> ) |
| O   | UCHAR <i>rx_data</i> ;  | Received data (data received greater than the number specified in the parameter <i>rxnum</i> for <a href="#">UART6_ReceiveData</a> ) |

**[Return value]**

None.



**UART6\_ErrorCallback**

Performs processing in response to the UART communication error interrupt INTSRE6.

**Remark** This API function is called as the callback routine of interrupt process MD\_INTSRE6 corresponding to the UART communication error interrupt INTSRE6.

**[Classification]**

CG\_serial\_user.c

**[Syntax]**

```
#include "CG_macrodriver.h"
void UART6_ErrorCallback ( UCHAR err_type );
```

**[Argument(s)]**

| I/O | Argument                | Description   |
|-----|-------------------------|---|
| O   | UCHAR <i>err_type</i> ; | Trigger for UART communication error interrupt<br>00000xx1B: Overrun error<br>00000x1xB: Framing error<br>000001xxB: Parity error |

**[Return value]**

None.

**[Example]**

Below are examples of callback processing by the trigger for the UART communication error interrupt.

[CG\_serial\_user.c]

```
#include "CG_macrodriver.h"
__interrupt void MD_INTSRE6 ( void ) { /* Interrupt processing for INTSRE6 */
    UCHAR err_type;
    .....
    UART6_ErrorCallback ( err_type ); /* Call callback routine */
}

void UART6_ErrorCallback ( UCHAR err_type ) { /* Callback routine for INTSRE6 */
    if ( err_type & 0x1 ) { /* Determine trigger */
        ..... /* Callback processing in response to overrun error */
    } else if ( err_type & 0x2 ) { /* Determine trigger */
        ..... /* Callback processing in response to framing error */
    } else if ( err_type & 0x4 ) { /* Determine trigger */
        ..... /* Callback processing in response to parity error */
    }
}
```

```
}  
}
```

**CSI1 $n$ \_Init**

Performs initialization of the serial interface (CSI1 $n$ ) channel.

**[Classification]**

CG\_serial.c

**[Syntax]**

```
void  CSI1n_Init ( void );
```

**Remark**  $n$  is the channel number.

**[Argument(s)]**

None.

**[Return value]**

None.

**CSI1 $n$ \_UserInit**

Performs user-defined initialization of the serial interface (CSI1 $n$ ).

**Remark** This API function is called as the [CSI1 \$n\$ \\_Init](#) callback routine.

**[Classification]**

CG\_serial\_user.c

**[Syntax]**

```
void CSI1 $n$ _UserInit ( void );
```

**Remark**  $n$  is the channel number.

**[Argument(s)]**

None.

**[Return value]**

None.

**CSI1 $n$ \_Start**

Sets CSI1 $n$  communication to standby mode.

**[Classification]**

CG\_serial.c

**[Syntax]**

```
void CSI1n_Start ( void );
```

**Remark**  $n$  is the channel number.

**[Argument(s)]**

None.

**[Return value]**

None.

**CSI1 $n$ \_Stop**

Ends CSI1 $n$  communication.

**[Classification]**

CG\_serial.c

**[Syntax]**

```
void CSI1n_Stop ( void );
```

**Remark**  $n$  is the channel number.

**[Argument(s)]**

None.

**[Return value]**

None.

**CSI1n\_ReceiveData**

Starts CSI1n data reception.

- Remarks 1.** This API function performs byte-level CSI1n reception the number of times specified by the parameter *rxnum*, and stores the data in the buffer specified by the parameter *rxbuf*.
- 2.** When performing a CSI1n reception, [CSI1n\\_Start](#) must be called before this API function is called.

**[Classification]**

CG\_serial.c

**[Syntax]**

```
#include "CG_macrodriver.h"
MD_STATUS CSI1n_ReceiveData ( UCHAR *rxbuf, USHORT rxnum );
```

**Remark** *n* is the channel number.

**[Argument(s)]**

| I/O | Argument               | Description                                    |
|-----|------------------------|--|
| O   | UCHAR * <i>rxbuf</i> ; | Pointer to a buffer to store the received data |
| I   | USHORT <i>rxnum</i> ;  | Total amount of data to receive                |

**[Return value]**

| Macro       | Description                    |
|-------------|--------------------------------|
| MD_OK       | Normal completion              |
| MD_ARGERROR | Invalid argument specification |

**[Example]**

Below is an example of receiving a CSI10 transmission of four bytes of fixed-length data from channel 10 one time.

[CG\_main.c]

```
#include "CG_macrodriver.h"
BOOL gFlag; /* Reception complete flag */
void main ( void ) {
    UCHAR rxbuf[10];
    USHORT rxnum = 4;
    gFlag = 1; /* Initialize reception complete flag */
    .....
    CSI10_Start (); /* Start CSI10 communication */
    CSI10_ReceiveData ( &rxbuf, rxnum ); /* Start CSI10 reception */
    while ( gFlag ); /* Wait for rxnum receptions */
```

```
.....  
}
```

[CG\_serial\_user.c]

```
#include "CG_macrodriver.h"  
extern BOOL gFlag; /* Reception complete flag */  
__interrupt void MD_INTCSI10 ( void ) { /* Interrupt processing for INTCSI10 */  
    if ( gCsi10RxCnt < gCsi10RxLen ) {  
        .....  
        if ( gCsi10RxCnt == gCsi10RxLen ) {  
            CSI10_ReceiveEndCallback (); /* Call callback routine */  
        } else {  
            .....  
        }  
    }  
}  
  
void CSI10_ReceiveEndCallback ( void ) { /* Callback routine for INTCSI10 */  
    gFlag = 0; /* Set reception complete flag */  
}
```



**CSI1n\_SendReceiveData**

Starts CSI1n data transmission/reception.

- Remarks 1.** This API function repeats the byte-level CSI1n transmission from the buffer specified in parameter *txbuf* the number of times specified in parameter *txnum*.
- 2.** This API function performs byte-level CSI1n reception the number of times specified by the parameter *txnum*, and stores the data in the buffer specified by the parameter *rxbuf*.
- 3.** When performing a CSI1n reception, [CSI1n\\_Start](#) must be called before this API function is called.

**[Classification]**

CG\_serial.c

**[Syntax]**

```
#include "CG_macrodriver.h"
MD_STATUS CSI1n_SendReceiveData ( UCHAR *txbuf, USHORT txnum, UCHAR *rxbuf );
```

**Remark** *n* is the channel number.

**[Argument(s)]**

| I/O | Argument               | Description                                       |
|-----|------------------------|---|
| I   | UCHAR * <i>txbuf</i> ; | Pointer to a buffer storing the transmission data |
| I   | USHORT <i>txnum</i> ;  | Total amount of data to send/receive              |
| O   | UCHAR * <i>rxbuf</i> ; | Pointer to a buffer to store the received data    |

**[Return value]**

| Macro       | Description                    |
|-------------|--------------------------------|
| MD_OK       | Normal completion              |
| MD_ARGERROR | Invalid argument specification |

**[Example]**

Below is an example of sending and receiving a CSI10 transmission of four bytes of fixed-length data from channel 10 one time.

[CG\_main.c]

```
#include "CG_macrodriver.h"
BOOL gSflag; /* Transmission complete flag */
void main ( void ) {
    UCHAR txbuf[] = "0123";
    USHORT txnum = 4;
    UCHAR rxbuf[10];
```

```

    gSflag = 1;                                /* Initialize flag */
    .....
    CSI10_Start ();                            /* Start CSI10 communication */
    CSI10_SendReceiveData ( &txbuf, txnum, &rxbuf ); /* Start CSI10 send/receive */
    while ( gSflag );                          /* Wait for txnum transmissions/receptions
*/
    .....
}

```

[CG\_serial\_user.c]

```

#include "CG_macrodriver.h"
extern BOOL gSflag; /* Transmission complete flag */
__interrupt void MD_INTCSI10 ( void ) { /* Interrupt processing for INTCSI10 */
    if ( gCsi10TxCnt > 0 ) {
        .....
    } else {
        .....
        CSI10_SendEndCallback (); /* Call callback routine */
    }
    .....
}

void CSI10_SendEndCallback ( void ) { /* Callback routine for INTCSI10 */
    gSflag = 0; /* Set transmission complete flag */
}

```

**CSI1*n*\_SendEndCallback**

Performs processing in response to the CSI1*n* communication complete interrupt INTCSI1*n*.

**Remark** This API function is called as the callback routine of interrupt process MD\_INTCSI1*n* corresponding to the CSI1*n* communication complete interrupt INTCSI1*n* (performed when number of transmission data specified by [CSI1\*n\*\\_SendReceiveData](#) parameter *txnum* has been completed).

**[Classification]**

CG\_serial\_user.c

**[Syntax]**

```
void CSI1n_SendEndCallback ( void );
```

**Remark** *n* is the channel number.

**[Argument(s)]**

None.

**[Return value]**

None.

**CSI1 $n$ \_ReceiveEndCallback**

Performs processing in response to the CSI1 $n$  communication complete interrupt INTCSI1 $n$ .

**Remark** This API function is called as the callback routine of interrupt process MD\_INTCSI1 $n$  corresponding to the CSI1 $n$  communication complete interrupt INTCSI1 $n$  (performed when number of received data specified by [CSI1 \$n\$ \\_ReceiveData](#) parameter *rxnum* has been completed).

**[Classification]**

CG\_serial\_user.c

**[Syntax]**

```
void CSI1n_ReceiveEndCallback ( void );
```

**Remark**  $n$  is the channel number.

**[Argument(s)]**

None.

**[Return value]**

None.

**IICA\_Init**

Performs initialization of the serial interface (IICA).

**[Classification]**

CG\_serial.c

**[Syntax]**

```
void IICA_Init ( void );
```

**[Argument(s)]**

None.

**[Return value]**

None.

**IICA\_UserInit**

Performs user-defined initialization of the serial interface (IICA).

**Remark** This API function is called as the [IICA\\_Init](#) callback routine.

**[Classification]**

CG\_serial\_user.c

**[Syntax]**

```
void IICA_UserInit ( void );
```

**[Argument(s)]**

None.

**[Return value]**

None.

**IICA\_Stop**

Ends IICA communication.

**[Classification]**

CG\_serial.c

**[Syntax]**

```
void IICA_Stop ( void );
```

**[Argument(s)]**

None.

**[Return value]**

None.

**IICA\_MasterSendStart**

Starts IICA master transmission.

**Remark** This API function repeats the byte-level IICA master transmission from the buffer specified in parameter *txbuf* the number of times specified in parameter *txnum*.

**[Classification]**

CG\_serial.c

**[Syntax]**

```
#include "CG_macrodriver.h"
MD_STATUS IICA_MasterSendStart ( UCHAR adr, UCHAR *txbuf, USHORT txnum, UCHAR wait );
```

**[Argument(s)]**

| I/O | Argument               | Description                                       |
|-----|------------------------|---|
| I   | UCHAR <i>adr</i> ;     | Slave address                                     |
| I   | UCHAR * <i>txbuf</i> ; | Pointer to a buffer storing the transmission data |
| I   | USHORT <i>txnum</i> ;  | Total amount of data to send                      |
| I   | UCHAR <i>wait</i> ;    | Setup time of start conditions                    |

**[Return value]**

| Macro     | Description              |
|-----------|--------------------------|
| MD_OK     | Normal completion        |
| MD_ERROR1 | Bus communication status |
| MD_ERROR2 | Bus not released status  |



**IICA\_MasterReceiveStart**

Starts IICA master reception.

**Remark** This API function performs byte-level IICA master reception the number of times specified by the parameter *rxnum*, and stores the data in the buffer specified by the parameter *rxbuf*.

**[Classification]**

CG\_serial.c

**[Syntax]**

```
#include "CG_macrodriver.h"
MD_STATUS IICA_MasterReceiveStart ( UCHAR adr, UCHAR *rxbuf, USHORT rxnum, UCHAR wait );
```

**[Argument(s)]**

| I/O | Argument              | Description                                    |
|-----|-----------------------|--|
| I   | UCHAR <i>adr</i> ;    | Slave address                                  |
| O   | UCHAR <i>*rxbuf</i> ; | Pointer to a buffer to store the received data |
| I   | USHORT <i>rxnum</i> ; | Total amount of data to receive                |
| I   | UCHAR <i>wait</i> ;   | Setup time of start conditions                 |

**[Return value]**

| Macro     | Description              |
|-----------|--------------------------|
| MD_OK     | Normal completion        |
| MD_ERROR1 | Bus communication status |
| MD_ERROR2 | Bus not released status  |

**IICA\_StopCondition**

Generates stop conditions.

**[Classification]**

CG\_serial.c

**[Syntax]**

```
void IICA_StopCondition ( void );
```

**[Argument(s)]**

None.

**[Return value]**

None.

**IICA\_MasterSendEndCallback**

Performs processing in response to the IICA communication complete interrupt INTIICA0.

**Remark** This API function is called as the callback routine of interrupt process MD\_INTIICA0 corresponding to the IICA communication complete interrupt INTIICA0.

**[Classification]**

CG\_serial\_user.c

**[Syntax]**

```
void IICA_MasterSendEndCallback ( void );
```

**[Argument(s)]**

None.

**[Return value]**

None.

**IICA\_MasterReceiveEndCallback**

Performs processing in response to the IICA communication complete interrupt INTIICA0.

**Remark** This API function is called as the callback routine of interrupt process MD\_INTIICA0 corresponding to the IICA communication complete interrupt INTIICA0.

**[Classification]**

CG\_serial\_user.c

**[Syntax]**

```
void IICA_MasterReceiveEndCallback ( void );
```

**[Argument(s)]**

None.

**[Return value]**

None.

**IICA\_MasterErrorCallback**

Performs processing in response to detection of error in IICA master communication.

**[Classification]**

CG\_serial\_user.c

**[Syntax]**

```
#include "CG_macrodriver.h"
void IICA_MasterErrorCallback ( MD_STATUS flag );
```

**[Argument(s)]**

| I/O | Argument                | Description  |
|-----|-------------------------|--|
| I   | MD_STATUS <i>flag</i> ; | Cause of communication error<br>MD_SPT: Stop condition detected<br>MD_NACK: Acknowledge not detected |

**[Return value]**

None.

**IICA\_SlaveSendStart**

Starts IICA slave transmission.

**Remark** This API function repeats the byte-level IICA slave transmission from the buffer specified in parameter *txbuf* the number of times specified in parameter *txnum*.

**[Classification]**

CG\_serial.c

**[Syntax]**

```
#include "CG_macrodriver.h"
void IICA_SlaveSendStart ( UCHAR *txbuf, USHORT txnum );
```

**[Argument(s)]**

| I/O | Argument               | Description                                       |
|-----|------------------------|---|
| I   | UCHAR * <i>txbuf</i> ; | Pointer to a buffer storing the transmission data |
| I   | USHORT <i>txnum</i> ;  | Total amount of data to send                      |

**[Return value]**

None.

**IICA\_SlaveReceiveStart**

Starts IICA slave reception.

**Remark** This API function performs byte-level IICA slave reception the number of times specified by the parameter *rxnum*, and stores the data in the buffer specified by the parameter *rxbuf*.

**[Classification]**

CG\_serial.c

**[Syntax]**

```
#include "CG_macrodriver.h"
void IICA_SlaveReceiveStart ( UCHAR *rxbuf, USHORT rxnum );
```

**[Argument(s)]**

| I/O | Argument               | Description                                    |
|-----|------------------------|--|
| O   | UCHAR * <i>rxbuf</i> ; | Pointer to a buffer to store the received data |
| I   | USHORT <i>rxnum</i> ;  | Total amount of data to receive                |

**[Return value]**

None.

**IICA\_SlaveSendEndCallback**

Performs processing in response to the IICA communication complete interrupt INTIICA0.

**Remark** This API function is called as the callback routine of interrupt process MD\_INTIICA0 corresponding to the IICA communication complete interrupt INTIICA0.

**[Classification]**

CG\_serial\_user.c

**[Syntax]**

```
void IICA_SlaveSendEndCallback ( void );
```

**[Argument(s)]**

None.

**[Return value]**

None.



**IICA\_SlaveReceiveEndCallback**

Performs processing in response to the IICA communication complete interrupt INTIICA0.

**Remark** This API function is called as the callback routine of interrupt process MD\_INTIICA0 corresponding to the IICA communication complete interrupt INTIICA0.

**[Classification]**

CG\_serial\_user.c

**[Syntax]**

```
void IICA_SlaveReceiveEndCallback ( void );
```

**[Argument(s)]**

None.

**[Return value]**

None.

**IICA\_SlaveErrorCallback**

Performs processing in response to detection of error in IICA slave communication.

**[Classification]**

CG\_serial\_user.c

**[Syntax]**

```
#include "CG_macrodriver.h"
void IICA_SlaveErrorCallback ( MD_STATUS flag );
```

**[Argument(s)]**

| I/O | Argument                | Description  |
|-----|-------------------------|--|
| I   | MD_STATUS <i>flag</i> ; | Cause of communication error<br>MD_ERROR: Address mismatch detected<br>MD_NACK: Acknowledge not detected |

**[Return value]**

None.

**IICA\_GetStopConditionCallback**

Performs processing in response to detection of stop condition in IICA slave communication.

**[Classification]**

CG\_serial\_user.c

**[Syntax]**

```
void IICA_GetStopConditionCallback ( void );
```

**[Argument(s)]**

None.

**[Return value]**

None.

### C.3.5 Operational Amplifier

Below is a list of API functions output by Code Generator for operational amplifiers use.

**Table C-6. API Functions: [Operational Amplifier]**

| API Function Name   | Function   |
|---------------------|--|
| OPAMP_Init          | Performs initialization necessary to control operational amplifier functions.      |
| OPAMP_UserInit      | Performs user-defined initialization relating to the operational amplifier.        |
| PGA_Start           | Starts the operation of operational amplifier (PGA mode).                          |
| PGA_Stop            | Ends the operation of operational amplifier (PGA mode).                            |
| PGA_ChangePGAFactor | Sets the input voltage amplification factor of a operational amplifier (PGA mode). |
| AMP_Start           | Starts the operation of operational amplifier (single AMP mode).                   |
| AMP_Stop            | Ends the operation of operational amplifier (single AMP mode).                     |
| AMPn_Start          | Starts the operation of operational amplifier <i>n</i> (single AMP mode).          |
| AMPn_Stop           | Ends the operation of operational amplifier <i>n</i> (single AMP mode).            |

**OPAMP\_Init**

Performs initialization necessary to control operational amplifier functions.

**[Classification]**

CG\_opamp.c

**[Syntax]**

```
void OPAMP_Init ( void );
```

**[Argument(s)]**

None.

**[Return value]**

None.

**OPAMP\_UserInit**

Performs user-defined initialization relating to the operational amplifier.

**Remark** This API function is called as the [OPAMP\\_Init](#) callback routine.

**[Classification]**

CG\_opamp\_user.c

**[Syntax]**

```
void OPAMP_UserInit ( void );
```

**[Argument(s)]**

None.

**[Return value]**

None.

**PGA\_Start**

Starts the operation of operational amplifier (PGA mode).

**[Classification]**

CG\_opamp.c

**[Syntax]**

```
void    PGA_Start ( void );
```

**[Argument(s)]**

None.

**[Return value]**

None.

**PGA\_Stop**

Ends the operation of operational amplifier (PGA mode).

**[Classification]**

CG\_opamp.c

**[Syntax]**

```
void    PGA_Stop ( void );
```

**[Argument(s)]**

None.

**[Return value]**

None.



**PGA\_ChangePGAFactor**

Sets the input voltage amplification factor of a operational amplifier (PGA mode).

**Remark** The value specified in parameter *factor* is set to operational amplifier control register (AMP0M).

**[Classification]**

CG\_opamp.c

**[Syntax]**

```
#include "CG_macrodriver.h"
#include "CG_opamp.h"
MD_STATUS PGA_ChangePGAFactor ( enum PGAFactor factor );
```

**[Argument(s)]**

| I/O | Argument                       | Description  |
|-----|--------------------------------|--|
| I   | enum PGAFactor <i>factor</i> ; | Input voltage amplification factor<br>PGAFACTOR0: x4<br>PGAFACTOR1: x8<br>PGAFACTOR2: x16<br>PGAFACTOR3: x32 |

**[Return value]**

| Macro       | Description                    |
|-------------|--------------------------------|
| MD_OK       | Normal completion              |
| MD_ARGERROR | Invalid argument specification |

**AMP\_Start**

Starts the operation of operational amplifier (single AMP mode).

**[Classification]**

CG\_opamp.c

**[Syntax]**

```
void AMP_Start ( void );
```

**[Argument(s)]**

None.

**[Return value]**

None.

**AMP\_Stop**

Ends the operation of operational amplifier (single AMP mode).

**[Classification]**

CG\_opamp.c

**[Syntax]**

```
void AMP_Stop ( void );
```

**[Argument(s)]**

None.

**[Return value]**

None.

**AMP $n$ \_Start**

Starts the operation of operational amplifier  $n$  (single AMP mode).

**[Classification]**

CG\_opamp.c

**[Syntax]**

```
void AMPn_Start ( void );
```

**Remark**  $n$  is the channel number.

**[Argument(s)]**

None.

**[Return value]**

None.

**AMP $n$ \_Stop**

Ends the operation of operational amplifier  $n$  (single AMP mode).

**[Classification]**

CG\_opamp.c

**[Syntax]**

```
void AMPn_Stop ( void );
```

**Remark**  $n$  is the channel number.

**[Argument(s)]**

None.

**[Return value]**

None.

**C.3.6 Comparator**

Below is a list of API functions output by Code Generator for comparator use.

**Table C-7. API Functions: [Comparator]**

| API Function Name                   | Function   |
|-------------------------------------|--|
| <a href="#">Comparator_Init</a>     | Performs initialization necessary to control comparator functions. |
| <a href="#">Comparator_UserInit</a> | Performs user-defined initialization relating to the comparator.   |
| <a href="#">Comparatorm_Start</a>   | Starts the operation of comparator <i>n</i> .                      |
| <a href="#">Comparatorm_Stop</a>    | Ends the operation of comparator <i>n</i> .                        |

**Comparator\_Init**

Performs initialization necessary to control comparator functions.

**[Classification]**

CG\_comparator.c

**[Syntax]**

```
void    Comparator_Init ( void );
```

**[Argument(s)]**

None.

**[Return value]**

None.

**Comparator\_UserInit**

Performs user-defined initialization relating to the comparator.

**Remark** This API function is called as the [Comparator\\_Init](#) callback routine.

**[Classification]**

CG\_comparator\_user.c

**[Syntax]**

```
void Comparator_UserInit ( void );
```

**[Argument(s)]**

None.

**[Return value]**

None.



**Comparatorn\_Start**

Starts the operation of comparator *n*.

**[Classification]**

CG\_comparator.c

**[Syntax]**

```
void Comparatorn_Start ( void );
```

**Remark** *n* is the channel number.

**[Argument(s)]**

None.

**[Return value]**

None.

**Comparatorn\_Stop**

Ends the operation of comparator.

**[Classification]**

CG\_comparatorn.c

**[Syntax]**

```
void Comparatorn_Stop ( void );
```

**Remark** *n* is the channel number.

**[Argument(s)]**

None.

**[Return value]**

None.

## C.3.7 A/D

Below is a list of API functions output by Code Generator for A/D converter use.

**Table C-8. API Functions: [A/D]**

| API Function Name                  | Function  |
|------------------------------------|---|
| <a href="#">AD_Init</a>            | Performs initialization necessary to control A/D converter functions.                       |
| <a href="#">AD_UserInit</a>        | Performs user-defined initialization relating to the A/D converter.                         |
| <a href="#">AD_ComparatorOn</a>    | Enables operation of voltage converter.   |
| <a href="#">AD_ComparatorOff</a>   | Disables operation of voltage converter.  |
| <a href="#">AD_Start</a>           | Starts A/D conversion.  |
| <a href="#">AD_Stop</a>            | Ends A/D conversion.  |
| <a href="#">AD_SelectADChannel</a> | Configures the analog voltage input pin for A/D conversion.                                 |
| <a href="#">AD_Read</a>            | Reads the results of A/D conversion (10 bits).  |
| <a href="#">AD_ReadByte</a>        | Reads the results of A/D conversion (8 bits; most significant 8 bits of 10-bit resolution). |

**AD\_Init**

Performs initialization necessary to control A/D converter functions.

**[Classification]**

CG\_ad.c

**[Syntax]**

```
void AD_Init ( void );
```

**[Argument(s)]**

None.

**[Return value]**

None.

**AD\_UserInit**

Performs user-defined initialization relating to the A/D converter.

**Remark** This API function is called as the [AD\\_Init](#) callback routine.

**[Classification]**

CG\_ad\_user.c

**[Syntax]**

```
void AD_UserInit ( void );
```

**[Argument(s)]**

None.

**[Return value]**

None.

**AD\_ComparatorOn**

Enables operation of voltage converter.

**Remark** About 1 microsecond of stabilization time is required when changing the voltage converter from operation stopped to operation enabled status.  
Consequently, about 1 micro second must be left free between the call to this API function and the call to [AD\\_Start](#).

**[Classification]**

CG\_ad.c

**[Syntax]**

```
void AD_ComparatorOn ( void );
```

**[Argument(s)]**

None.

**[Return value]**

None.

**AD\_ComparatorOff**

Disables operation of voltage converter.

**[Classification]**

CG\_ad.c

**[Syntax]**

```
void AD_ComparatorOff ( void );
```

**[Argument(s)]**

None.

**[Return value]**

None.

**AD\_Start**

Starts A/D conversion.

**Remark** About 1 micro second of stabilization time is required when changing the voltage converter from operation stopped to operation enabled status.  
Consequently, about 1 micro second must be left free between the call to [AD\\_ComparatorOn](#) and the call to this API function.

**[Classification]**

CG\_ad.c

**[Syntax]**

```
void AD_Start ( void );
```

**[Argument(s)]**

None.

**[Return value]**

None.



**AD\_Stop**

Ends A/D conversion.

**Remark** The voltage converter continues to operate after the process of this API function completes. Consequently, to stop the operation of the voltage converter, you must call [AD\\_ComparatorOff](#) after the process of this API function completes.

**[Classification]**

CG\_ad.c

**[Syntax]**

```
void AD_Stop ( void );
```

**[Argument(s)]**

None.

**[Return value]**

None.

**AD\_SelectADChannel**

Configures the analog voltage input pin for A/D conversion.

**Remark** The value specified in parameter *channel* is set to analog input channel specification register (ADS).

**[Classification]**

CG\_ad.c

**[Syntax]**

```
#include "CG_ad.h"
MD_STATUS AD_SelectADChannel ( enum ADChannel channel );
```

**[Argument(s)]**

| I/O | Argument                        | Description  |
|-----|---------------------------------|--|
| I   | enum ADChannel <i>channel</i> ; | Analog voltage input pin<br>ADCHANNEL <i>n</i> : Input pin<br>ADCHANNELPGAIN: Operational amplifier output pin<br>ADCHANNEL12V: Internal voltage (1.2 V) |

**Remark** See the header file CG\_ad.h for details about the analog voltage input pin ADCHANNEL*n*.

**[Return value]**

| Macro       | Description                    |
|-------------|--------------------------------|
| MD_OK       | Normal completion              |
| MD_ARGERROR | Invalid argument specification |

**AD\_Read**

Reads the results of A/D conversion (10 bits).

**Remark** The contents of the 10-bit A/D conversion result register (ADCR) are stored in the area specified by parameter *buffer*.

**[Classification]**

CG\_ad.c

**[Syntax]**

```
#include "CG_macrodriver.h"
void AD_Read ( USHORT *buffer );
```

**[Argument(s)]**

| I/O | Argument                 | Description  |
|-----|--------------------------|--|
| O   | USHORT * <i>buffer</i> ; | Pointer to area in which to store read results of A/D conversion |

**[Return value]**

None.

**AD\_ReadByte**

Reads the results of A/D conversion (8 bits; most significant 8 bits of 10-bit resolution).

**Remark** The contents of the 8-bit A/D conversion result register H (ADCRH) are stored in the area specified by parameter *buffer*.

**[Classification]**

CG\_ad.c

**[Syntax]**

```
#include "CG_macrodriver.h"
void AD_ReadByte ( UCHAR *buffer );
```

**[Argument(s)]**

| I/O | Argument                | Description   |
|-----|-------------------------|---|
| O   | UCHAR * <i>buffer</i> ; | Pointer to area in which to store the results of A/D conversion |

**[Return value]**

None.

## C.3.8 Timer

Below is a list of API functions output by Code Generator for timer array unit use.

Table C-9. API Functions: [Timer]

| API Function Name             | Function   |
|-------------------------------|--|
| TMX_Init                      | Performs initialization necessary to control 16-bit timer $Xn$ functions.                  |
| TMXn_Start                    | Starts the count for 16-bit timer $Xn$ .   |
| TMXn_Stop                     | Ends the count for 16-bit timer $Xn$ .   |
| TMXn_ChangeDuty               | Changes the duty ratio of the PWM signal single-output to the TOX0n pin.                   |
| TMXn_ChangeDualDuty           | Changes the duty ratio of the PWM signal dual-output to the TOX0n pin.                     |
| TMX_EnableHighImpedanceState  | Begins high impedance output of the 16-bit timer $Xn$ .                                    |
| TMX_DisableHighImpedanceState | Ends high impedance output of the 16-bit timer $Xn$ .                                      |
| TM00_Init                     | Performs initialization necessary to control 16-bit timer/event counter 00 functions.      |
| TM00_UserInit                 | Performs user-defined initialization relating to the 16-bit timer/event counter 00.        |
| TM00_Start                    | Starts the count for 16-bit timer/event counter 00.  |
| TM00_Stop                     | Ends the count for 16-bit timer/event counter 00.  |
| TM00_ChangeTimerCondition     | Changes the value of capture/compare control register 00 (CRC00).                          |
| TM00_GetFreeRunningValue      | Captures the content of the capture register (CR0n0).                                      |
| TM00_SoftwareTriggerOn        | Generates the trigger (software trigger) for one-shot pulse output.                        |
| TM00_ChangeDuty               | Changes the duty ratio of the signal output to the TO00 pin.                               |
| TM00_GetPulseWidth            | Captures the high/low-level width measured for the signal (pulses) input to the TI0n0 pin. |
| TM5n_Init                     | Performs initialization necessary to control 8-bit timer/event counter $5n$ functions.     |
| TM5n_UserInit                 | Performs user-defined initialization relating to the 8-bit timer/event counter $5n$ .      |
| TM5n_Start                    | Starts the count for 8-bit timer/event counter $5n$ .                                      |
| TM5n_Stop                     | Ends the count for 8-bit timer/event counter $5n$ .  |
| TM5n_ChangeTimerCondition     | Changes the value of 8-bit timer compare register $5n$ (CR5n).                             |
| TM5n_ChangeDuty               | Changes the duty ratio of the PWM signal output to the TO5n pin.                           |
| TMHn_Init                     | Performs initialization necessary to control 8-bit timer $Hn$ functions.                   |
| TMHn_UserInit                 | Performs user-defined initialization relating to the 8-bit timer $Hn$ .                    |
| TMHn_Start                    | Starts the count for 8-bit timer $Hn$ .  |
| TMHn_Stop                     | Ends the count for 8-bit timer $Hn$ .  |
| TMHn_ChangeTimerCondition     | Changes the value of 8-bit timer H compare register 0n/1n (CMP0n/CMP1n).                   |
| TMHn_ChangeDuty               | Changes the duty ratio of the PWM signal output to the TOHn pin.                           |
| TMH1_CarrierOutputEnable      | Begins carrier pulse output of the 8-bit timer H1 (carrier generator mode).                |
| TMH1_CarrierOutputDisable     | Ends carrier pulse output of the 8-bit timer H1 (carrier generator mode).                  |

**TMX\_Init**

Performs initialization necessary to control 16-bit timer Xn functions.

**[Classification]**

CG\_timer.c

**[Syntax]**

```
void    TMX_Init ( void );
```

**[Argument(s)]**

None.

**[Return value]**

None.

**TMX $n$ \_Start**

Starts the count for 16-bit timer  $Xn$ .

**Remark** The time from the call to this API function to the start of counting depends on the type of the function in question (e.g. PWMoutput, or A/D conversion start timing signal output).

**[Classification]**

CG\_timer.c

**[Syntax]**

```
void TMX $n$ _Start ( void );
```

**Remark**  $n$  is the channel number.

**[Argument(s)]**

None.

**[Return value]**

None.

**TMX $n$ \_Stop**

Ends the count for 16-bit timer X $n$ .

**[Classification]**

CG\_timer.c

**[Syntax]**

```
void    TMX $n$ _Stop ( void );
```

**Remark**  $n$  is the channel number.

**[Argument(s)]**

None.

**[Return value]**

None.



**TMX $n$ \_ChangeDuty**

Changes the duty ratio of the PWM signal single-output to the TOX $n$  pin.

**Remark** This API function can only be called when the 16-bit timer X $n$  is being used for single-output.

**[Classification]**

CG\_timer.c

**[Syntax]**

```
#include "CG_macrodriver.h"
void TMXn_ChangeDuty ( UCHAR ratio );
```

**Remark**  $n$  is the channel number.

**[Argument(s)]**

| I/O | Argument             | Description                    |
|-----|----------------------|--------------------------------|
| I   | UCHAR <i>ratio</i> ; | Duty ratio (0 to 100, unit: %) |

**Remark** The value set to duty ratio *ratio* must be in base 10 notation.

**[Return value]**

None.

**[Example]**

The example below shows changing the duty ratio to 25%.

[CG\_main.c]

```
#include "CG_macrodriver.h"
void main ( void ) {
    UCHAR ratio = 25;
    .....
    TMX0_Start ();          /* Start count */
    .....
    TMX0_ChangeDuty ( ratio ); /* Change duty ratio */
    .....
}
```

**TMXn\_ChangeDualDuty**

Changes the duty ratio of the PWM signal dual-output to the TOXn pin.

**Remark** This API function can only be called when the 16-bit timer Xn is being used for dual-output.

**[Classification]**

CG\_timer.c

**[Syntax]**

```
#include "CG_macrodriver.h"
void TMXn_ChangeDualDuty ( UCHAR ratio, UCHAR ratio1, UCHAR delay );
```

**Remark** n is the channel number.

**[Argument(s)]**

| I/O | Argument              | Description                             |
|-----|-----------------------|---|
| I   | UCHAR <i>ratio</i> ;  | Duty ratio of TOXn0 (0 to 100, unit: %) |
| I   | UCHAR <i>ratio1</i> ; | Duty ratio of TOXn1 (0 to 100, unit: %) |
| I   | UCHAR <i>delay</i> ;  | Delay time of TOXn0 (0 to 100, unit: %) |

- Remarks 1.** The value set to duty ratio *ratio*, *ratio1* and *delay* must be in base 10 notation.  
**2.** The following figure displays the meaning of each argument.

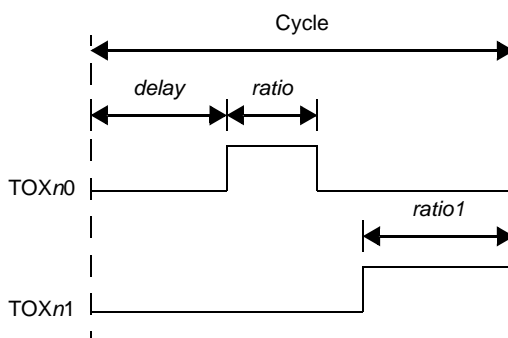

**[Return value]**

None.

**TMX\_EnableHighImpedanceState**

Begins high impedance output of the 16-bit timer *Xn*.

**[Classification]**

CG\_timer.c

**[Syntax]**

```
void    TMX_EnableHighImpedanceState ( void );
```

**[Argument(s)]**

None.

**[Return value]**

None.

**TMX\_DisableHighImpedanceState**

Ends high impedance output of the 16-bit timer  $Xn$ .

**[Classification]**

CG\_timer.c

**[Syntax]**

```
void    TMX_DisableHighImpedanceState ( void );
```

**[Argument(s)]**

None.

**[Return value]**

None.

**TM00\_Init**

Performs initialization necessary to control 16-bit timer/event counter 00 functions.

**[Classification]**

CG\_timer.c

**[Syntax]**

```
void    TM00_Init ( void );
```

**[Argument(s)]**

None.

**[Return value]**

None.

**TM00\_UserInit**

Performs user-defined initialization relating to the 16-bit timer/event counter 00.

**Remark** This API function is called as the [TM00\\_Init](#) callback routine.

**[Classification]**

CG\_timer\_user.c

**[Syntax]**

```
void    TM00_UserInit ( void );
```

**[Argument(s)]**

None.

**[Return value]**

None.

**TM00\_Start**

Starts the count for 16-bit timer/event counter 00.

**Remark** The time from the call to this API function to the start of counting depends on the type of the function in question (e.g. interval timer, square-wave output, or external event counter).

**[Classification]**

CG\_timer.c

**[Syntax]**

```
void TM00_Start ( void );
```

**[Argument(s)]**

None.

**[Return value]**

None.

**TM00\_Stop**

Ends the count for 16-bit timer/event counter 00.

**[Classification]**

CG\_timer.c

**[Syntax]**

```
void    TM00_Stop ( void );
```

**[Argument(s)]**

None.

**[Return value]**

None.



**TM00\_ChangeTimerCondition**

Changes the value of 16-bit timer capture/compare control register 0n0 (CR0n0).

**Remark** To change the contents of CR0n0, you must call [TM00\\_Stop](#) before calling this API function.

**[Classification]**

CG\_timer.c

**[Syntax]**

```
#include "CG_macrodriver.h"
#include "CG_timer.h"
MD_STATUS TM00_ChangeTimerCondition ( USHORT *array_reg, USHORT array_num );
```

**[Argument(s)]**

| I/O | Argument           | Description   |
|-----|--------------------|---|
| I   | USHORT *array_reg; | Pointer to the area storing the value to set in the target register |
| I   | USHORT array_num;  | The register to change<br>1: CR000<br>2: CR000, CR010               |

**[Return value]**

| Macro    | Description                                |
|----------|--|
| MD_OK    | Normal completion                          |
| MD_ERROR | Invalid argument "array_num" specification |

**TM00\_GetFreeRunningValue**

Captures the content of the capture register (CR0*n*0).

**Remark** This API function can only be called when the 16-bit timer/event counter 00 is running in free-running timer mode, and the 16-bit timer capture/compare control register 0*n*0 (CR0*n*0) is being used as a capture register.

**[Classification]**

CG\_timer.c

**[Syntax]**

```
#include "CG_macrodriver.h"
#include "CG_timer.h"
MD_STATUS TM00_GetFreeRunningValue ( ULONG *count, enum TMChannel channel );
```

**[Argument(s)]**

| I/O | Argument                | Description  |
|-----|-------------------------|--|
| I   | ULONG *count;           | Pointer to area in which to store the captured value                 |
| I   | enum TMChannel channel; | The pin to capture<br>TMCHANNEL0: TI000 pin<br>TMCHANNEL1: TI010 pin |

**[Return value]**

| Macro       | Description   |
|-------------|---|
| MD_OK       | Normal completion   |
| MD_ERROR    | Exit with error (abend)<br>- CR0 <i>n</i> 0 is operating as a compare register. |
| MD_ARGERROR | Invalid argument specification  |

**TM00\_SoftwareTriggerOn**

Generates the trigger (software trigger) for one-shot pulse output.

**Remark** This API function can only be called when the 16-bit timer/event counter 00 is being used for one-shot pulse output.

**[Classification]**

CG\_timer.c

**[Syntax]**

```
void TM00_SoftwareTriggerOn ( void );
```

**[Argument(s)]**

None.

**[Return value]**

None.

**TM00\_ChangeDuty**

Changes the duty ratio of the signal output to the TO00 pin.

**Remark** This API function can only be called when the 16-bit timer/event counter 00 is being used for PPG output.

**[Classification]**

CG\_timer.c

**[Syntax]**

```
#include "CG_macrodriver.h"
void TM00_ChangeDuty ( UCHAR ratio );
```

**[Argument(s)]**

| I/O | Argument             | Description                    |
|-----|----------------------|--------------------------------|
| I   | UCHAR <i>ratio</i> ; | Duty ratio (0 to 100, unit: %) |

**Remark** The value set to duty ratio *ratio* must be in base 10 notation.

**[Return value]**

None.

**[Example]**

The example below shows changing the duty ratio to 25%.

[CG\_main.c]

```
#include "CG_macrodriver.h"
void main ( void ) {
    UCHAR ratio = 25;
    .....
    TM00_Start (); /* Start count */
    .....
    TM00_ChangeDuty ( ratio ); /* Change duty ratio */
    .....
}
```

**TM00\_GetPulseWidth**

Captures the high/low-level width measured for the signal (pulses) input to the TI0n0 pin.

**Remark** This API function can only be called when the 16-bit timer/event counter 00 is being used for pulse width measurement.

**[Classification]**

CG\_timer.c

**[Syntax]**

```
#include "CG_macrodriver.h"
#include "CG_timer.h"
void TM00_GetPulseWidth ( ULONG *highwidth, ULONG *lowwidth, enum TMChannel channel );
```

**[Argument(s)]**

| I/O | Argument                | Description  |
|-----|-------------------------|--|
| O   | ULONG *highwidth;       | Pointer to area storing the high-level measurement width (0x0 to 0xffff) |
| O   | ULONG *lowwidth;        | Pointer to area storing the low-level measurement width (0x0 to 0xffff)  |
| I   | enum TMChannel channel; | The pin to measure<br>TMCHANNEL0: TI000 pin<br>TMCHANNEL1: TI010 pin     |

**[Return value]**

None.

**TM5 $n$ \_Init**

Performs initialization necessary to control 8-bit timer/event counter 5 $n$  functions.

**[Classification]**

CG\_timer.c

**[Syntax]**

```
void    TM5 $n$ _Init ( void );
```

**Remark**  $n$  is the channel number.

**[Argument(s)]**

None.

**[Return value]**

None.

**TM5 $n$ \_UserInit**

Performs user-defined initialization relating to the 8-bit timer/event counter 5 $n$ .

**Remark** This API function is called as the [TM5 \$n\$ \\_Init](#) callback routine.

**[Classification]**

CG\_timer\_user.c

**[Syntax]**

```
void    TM5 $n$ _UserInit ( void );
```

**Remark**  $n$  is the channel number.

**[Argument(s)]**

None.

**[Return value]**

None.

**TM5 $n$ \_Start**

Starts the count for 8-bit timer/event counter 5 $n$ .

**Remark** The time from the call to this API function to the start of counting depends on the type of the function in question (e.g. interval timer, or external event counter).

**[Classification]**

CG\_timer.c

**[Syntax]**

```
void TM5 $n$ _Start ( void );
```

**Remark**  $n$  is the channel number.

**[Argument(s)]**

None.

**[Return value]**

None.



**TM5 $n$ \_Stop**

Ends the count for 8-bit timer/event counter 5 $n$ .

**[Classification]**

CG\_timer.c

**[Syntax]**

```
void TM5 $n$ _Stop ( void );
```

**Remark**  $n$  is the channel number.

**[Argument(s)]**

None.

**[Return value]**

None.

**TM5n\_ChangeTimerCondition**

Changes the value of 8-bit timer compare register 5n (CR5n).

**Remark** To change the contents of CR5n, you must call [TM5n\\_Stop](#) before calling this API function.

**[Classification]**

CG\_timer.c

**[Syntax]**

```
#include "CG_macrodriver.h"
void TM5n_ChangeTimerCondition ( UCHAR value );
```

**Remark** n is the channel number.

**[Argument(s)]**

| I/O | Argument             | Description              |
|-----|----------------------|--------------------------|
| I   | UCHAR <i>value</i> ; | The value to set in CR5n |

**[Return value]**

None.

**TM5n\_ChangeDuty**

Changes the duty ratio of the PWM signal output to the TO5n pin.

**Remark** This API function can only be called when the 8-bit timer/event counter 5n is being used for PWM output.

**[Classification]**

CG\_timer.c

**[Syntax]**

```
#include "CG_macrodriver.h"
void TM5n_ChangeDuty ( UCHAR ratio );
```

**Remark** n is the channel number.

**[Argument(s)]**

| I/O | Argument             | Description                    |
|-----|----------------------|--------------------------------|
| I   | UCHAR <i>ratio</i> ; | Duty ratio (0 to 100, unit: %) |

**Remark** The value set to duty ratio *ratio* must be in base 10 notation.

**[Return value]**

None.

**[Example]**

The example below shows changing the duty ratio to 25%.

[CG\_main.c]

```
#include "CG_macrodriver.h"
void main ( void ) {
    UCHAR ratio = 25;
    .....
    TM50_Start ();          /* Start count */
    .....
    TM50_ChangeDuty ( ratio ); /* Change duty ratio */
    .....
}
```

**TMH $n$ \_Init**

Performs initialization necessary to control 8-bit timer H $n$  functions.

**[Classification]**

CG\_timer.c

**[Syntax]**

```
void    TMHn_Init ( void );
```

**Remark**  $n$  is the channel number.

**[Argument(s)]**

None.

**[Return value]**

None.

**TMH $n$ \_UserInit**

Performs user-defined initialization relating to the 8-bit timer H $n$ .

**Remark** This API function is called as the [TMH \$n\$ \\_Init](#) callback routine.

**[Classification]**

CG\_timer\_user.c

**[Syntax]**

```
void    TMH $n$ _UserInit ( void );
```

**Remark**  $n$  is the channel number.

**[Argument(s)]**

None.

**[Return value]**

None.

**TMH $n$ \_Start**

Starts the count for 8-bit timer H $n$ .

**Remark** The time from the call to this API function to the start of counting depends on the type of the function in question (e.g. interval timer, square-wave output, or PWM output).

**[Classification]**

CG\_timer.c

**[Syntax]**

```
void    TMH $n$ _Start ( void );
```

**Remark**  $n$  is the channel number.

**[Argument(s)]**

None.

**[Return value]**

None.

**TMH $n$ \_Stop**

Ends the count for 8-bit timer H $n$ .

**[Classification]**

CG\_timer.c

**[Syntax]**

```
void    TMH $n$ _Stop ( void );
```

**Remark**  $n$  is the channel number.

**[Argument(s)]**

None.

**[Return value]**

None.

**TMHn\_ChangeTimerCondition**

Changes the value of 8-bit timer H compare register 0n/1n (CMP0n/CMP1n).

**Remark** To change the contents of CMP0n/CMP1n, you must call [TMHn\\_Stop](#) before calling this API function.

**[Classification]**

CG\_timer.c

**[Syntax]**

```
#include "CG_macrodriver.h"
#include "CG_timer.h"
MD_STATUS TMHn_ChangeTimerCondition ( UCHAR *array_reg, UCHAR array_num );
```

**Remark** n is the channel number.

**[Argument(s)]**

| I/O | Argument          | Description   |
|-----|-------------------|---|
| I   | UCHAR *array_reg; | Pointer to the area storing the value to set in the target register |
| I   | UCHAR array_num;  | The register to change<br>1: CMP0n<br>2: CMP0n, CMP1n               |

**[Return value]**

| Macro       | Description                    |
|-------------|--------------------------------|
| MD_OK       | Normal completion              |
| MD_ARGERROR | Invalid argument specification |



**TMHn\_ChangeDuty**

Changes the duty ratio of the PWM signal output to the TOHn pin.

**Remark** This API function can only be called when the 8-bit timer Hn is being used for PWM output.

**[Classification]**

CG\_timer.c

**[Syntax]**

```
#include "CG_macrodriver.h"
void TMHn_ChangeDuty ( UCHAR ratio );
```

**Remark** n is the channel number.

**[Argument(s)]**

| I/O | Argument             | Description                    |
|-----|----------------------|--------------------------------|
| I   | UCHAR <i>ratio</i> ; | Duty ratio (0 to 100, unit: %) |

**Remark** The value set to duty ratio *ratio* must be in base 10 notation.

**[Return value]**

None.

**[Example]**

The example below shows changing the duty ratio to 25%.

[CG\_main.c]

```
#include "CG_macrodriver.h"
void main ( void ) {
    UCHAR ratio = 25;
    .....
    TMH0_Start ();          /* Start count */
    .....
    TMH0_ChangeDuty ( ratio ); /* Change duty ratio */
    .....
}
```

**TMH1\_CarrierOutputEnable**

Begins carrier pulse output of the 8-bit timer H1 (carrier generator mode).

**[Classification]**

CG\_timer.c

**[Syntax]**

```
void    TMH1_CarrierOutputEnable ( void );
```

**[Argument(s)]**

None.

**[Return value]**

None.

**TMH1\_CarrierOutputDisable**

Ends carrier pulse output of the 8-bit timer H1 (carrier generator mode).

**[Classification]**

CG\_timer.c

**[Syntax]**

```
void    TMH1_CarrierOutputDisable ( void );
```

**[Argument(s)]**

None.

**[Return value]**

None.

**C.3.9 Watchdog Timer**

Below is a list of API functions output by Code Generator for watchdog timer use.

**Table C-10. API Functions: [Watchdog Timer]**

| API Function Name | Function  |
|-------------------|---|
| WDT_Restart       | Clears the watchdog timer counter and resumes counting. |

**WDT\_Restart**

Clears the watchdog timer counter and resumes counting.

**[Classification]**

CG\_wdt.c

**[Syntax]**

```
void WDT_Restart ( void );
```

**[Argument(s)]**

None.

**[Return value]**

None.

## C.3.10 RTC

Below is a list of API functions output by Code Generator for real-time counter use.

Table C-11. API Functions: [RTC]

| API Function Name                | Function  |
|----------------------------------|---|
| RTC_Init                         | Performs initialization necessary to control real-time counter functions.                           |
| RTC_UserInit                     | Performs user-defined initialization relating to the real-time counter.                             |
| RTC_PowerOff                     | Halts the clock supplied to the real-time counter.  |
| RTC_CounterEnable                | Starts the count of the real-time counter (year, month, weekday, day, hour, minute, second).        |
| RTC_CounterDisable               | Ends the count of the real-time counter (year, month, weekday, day, hour, minute, second).          |
| RTC_SetHourSystem                | Sets the clock type (12-hour or 24-hour clock) of the real-time counter.                            |
| RTC_CounterSet                   | Sets the counter value (year, month, weekday, day, hour, minute, second) of the real-time counter.  |
| RTC_CounterGet                   | Reads the counter value (year, month, weekday, day, hour, minute, second) of the real-time counter. |
| RTC_ConstPeriodInterruptEnable   | Sets the cycle of the interrupts INTRTC, then starts the cyclic interrupt function.                 |
| RTC_ConstPeriodInterruptDisable  | Ends the cyclic interrupt function.   |
| RTC_ConstPeriodInterruptCallback | Performs processing in response to the cyclic interrupt INTRTC.                                     |
| RTC_AlarmEnable                  | Starts the alarm interrupt function.  |
| RTC_AlarmDisable                 | Ends the alarm interrupt function.  |
| RTC_AlarmSet                     | Sets the alarm conditions (weekday, hour, minute).  |
| RTC_AlarmGet                     | Reads the alarm conditions (weekday, hour, minute).   |
| RTC_AlarmInterruptCallback       | Performs processing in response to the alarm interrupt INTRTC.                                      |
| RTC_IntervalStart                | Starts the interval interrupt function.   |
| RTC_IntervalStop                 | Ends the interval interrupt function.   |
| RTC_IntervalInterruptEnable      | Sets the cycle of the interrupts INTRTCI, then starts the interval interrupt function.              |
| RTC_IntervalInterruptDisable     | Ends the interval interrupt function.   |
| RTC_RTC1HZ_OutputEnable          | Enables output of the real-time counter correction clock (1 Hz) to the RTC1HZ pin.                  |
| RTC_RTC1HZ_OutputDisable         | Disables output of the real-time counter correction clock (1 Hz) to the RTC1HZ pin.                 |
| RTC_RTCCL_OutputEnable           | Enables output of the real-time counter clock (32 kHz source) to the RTCCL pin.                     |
| RTC_RTCCL_OutputDisable          | Disables output of the real-time counter clock (32 kHz source) to the RTCCL pin.                    |
| RTC_RTCDIV_OutputEnable          | Enables output of the real-time counter clock (32 kHz cycle) to the RTCDIV pin.                     |
| RTC_RTCDIV_OutputDisable         | Disables output of the real-time counter clock (32 kHz cycle) to the RTCDIV pin.                    |
| RTC_ChangeCorrectionValue        | Changes the timing and correction value for correcting clock errors.                                |

**RTC\_Init**

Performs initialization necessary to control real-time counter functions.

**[Classification]**

CG\_rtc.c

**[Syntax]**

```
void    RTC_Init ( void );
```

**[Argument(s)]**

None.

**[Return value]**

None.

**RTC\_UserInit**

Performs user-defined initialization relating to the real-time counter.

**Remark** This API function is called as the [RTC\\_Init](#) callback routine.

**[Classification]**

CG\_rtc\_user.c

**[Syntax]**

```
void    RTC_UserInit ( void );
```

**[Argument(s)]**

None.

**[Return value]**

None.



**RTC\_PowerOff**

Halts the clock supplied to the real-time counter.

**Remark** Calling this API function changes the real-time counter to reset status. For this reason, writes to the control registers (e.g. real-time counter control register 0: RTCC0) after this API function is called are ignored.

**[Classification]**

CG\_rtc.c

**[Syntax]**

```
void RTC_PowerOff ( void );
```

**[Argument(s)]**

None.

**[Return value]**

None.

**RTC\_CounterEnable**

Starts the count of the real-time counter (year, month, weekday, day, hour, minute, second).

**[Classification]**

CG\_rtc.c

**[Syntax]**

```
void    RTC_CounterEnable ( void );
```

**[Argument(s)]**

None.

**[Return value]**

None.

**RTC\_CounterDisable**

Ends the count of the real-time counter (year, month, weekday, day, hour, minute, second).

**[Classification]**

CG\_rtc.c

**[Syntax]**

```
void    RTC_CounterDisable ( void );
```

**[Argument(s)]**

None.

**[Return value]**

None.

**RTC\_SetHourSystem**

Sets the clock type (12-hour or 24-hour clock) of the real-time counter.

**[Classification]**

CG\_rtc.c

**[Syntax]**

```
#include "CG_macrodriver.h"
#include "CG_rtc.h"
MD_STATUS RTC_SetHourSystem ( enum RTCHourSystem hoursystem );
```

**[Argument(s)]**

| I/O | Argument                               | Description  |
|-----|--|--|
| I   | enum RTCHourSystem <i>hoursystem</i> ; | Clock type<br>HOUR12: 12-hour clock<br>HOUR24: 24-hour clock |

**[Return value]**

| Macro       | Description  |
|-------------|--|
| MD_OK       | Normal completion                                  |
| MD_BUSY1    | Executing count process (before change to setting) |
| MD_BUSY2    | Stopping count process (after change to setting)   |
| MD_ARGERROR | Invalid argument specification                     |

**Remark** If MD\_BUSY1 or MD\_BUSY2 is returned, it may be because the counter-operation is stopped, or the counter operation start wait time is too short, so make the value of the RTC\_WAITTIME macro defined in the header file "CG\_rtc.h" larger.

**[Example]**

Below is an example of setting the clock type to the 24-hour clock.

[CG\_main.c]

```
#include "CG_rtc.h"
void main ( void ) {
    .....
    RTC_CounterEnable (); /* Start count */
    .....
    RTC_SetHourSystem ( HOUR24 ); /* Set clock type */
    .....
}
```

```
}  
}
```

**RTC\_CounterSet**

Sets the counter value (year, month, weekday, day, hour, minute, second) of the real-time counter.

**[Classification]**

CG\_rtc.c

**[Syntax]**

```
#include "CG_macrodriver.h"
#include "CG_rtc.h"
MD_STATUS RTC_CounterSet ( struct RTCCounterValue counterwriteval );
```

**[Argument(s)]**

| I/O | Argument                                | Description   |
|-----|---|---------------|
| I   | struct RTCCounterValue counterwriteval; | Counter value |

**Remark** Below is an example of the structure RTCCounterValue (counter value) for the real-time counter.

```
struct RTCCounterValue {
    UCHAR Sec; /* second */
    UCHAR Min; /* Minute */
    UCHAR Hour; /* Hour */
    UCHAR Day; /* Day */
    UCHAR Week; /* Weekday (0: Sunday, 6: Saturday) */
    UCHAR Month; /* Month */
    UCHAR Year; /* Year */
};
```

**[Return value]**

| Macro    | Description  |
|----------|--|
| MD_OK    | Normal completion                                  |
| MD_BUSY1 | Executing count process (before change to setting) |
| MD_BUSY2 | Stopping count process (after change to setting)   |

**Remark** If MD\_BUSY1 or MD\_BUSY2 is returned, it may be because the counter-operation is stopped, or the counter operation start wait time is too short, so make the value of the RTC\_WAITTIME macro defined in the header file "CG\_rtc.h" larger.

**[Example]**

The example below shows the counter value of the real-time counter being set to "2008/12/25 (Thu.) 17:30:00".

[CG\_main.c]

```
#include "CG_rtc.h"
void main ( main ) {
    struct RTCCounterValue counterwriteval;
    .....
    RTC_CounterEnable ();          /* Start count */
    .....
    counterwriteval.Year = 0x08;
    counterwriteval.Month = 0x12;
    counterwriteval.Day = 0x25;
    counterwriteval.Week = 0x05;
    counterwriteval.Hour = 0x17;
    counterwriteval.Min = 0x30;
    counterwriteval.Sec = 0;
    RTC_SetHourSystem ( HOUR24 );  /* Set clock type */
    RTC_CounterSet ( counterwriteval ); /* Set counter value */
    .....
}
```

**RTC\_CounterGet**

Reads the counter value (year, month, weekday, day, hour, minute, second) of the real-time counter.

**[Classification]**

CG\_rtc.c

**[Syntax]**

```
#include "CG_macrodriver.h"
#include "CG_rtc.h"
MD_STATUS RTC_CounterGet ( struct RTCCounterValue *counterreadval );
```

**[Argument(s)]**

| I/O | Argument                                | Description   |
|-----|---|---|
| O   | struct RTCCounterValue *counterreadval; | Pointer to structure in which to store the counter value being read |

**Remark** See [RTC\\_CounterSet](#) for details about the RTCCounterValue counter value.

**[Return value]**

| Macro    | Description                              |
|----------|--|
| MD_OK    | Normal completion                        |
| MD_BUSY1 | Executing count process (before reading) |
| MD_BUSY2 | Stopping count process (after reading)   |

**Remark** If MD\_BUSY1 or MD\_BUSY2 is returned, it may be because the counter-operation is stopped, or the counter operation start wait time is too short, so make the value of the RTC\_WAITTIME macro defined in the header file "CG\_rtc.h" larger.

**[Example]**

Below is an example of reading the counter value of the real-time counter.

[CG\_main.c]

```
#include "CG_rtc.h"
void main ( void ) {
    struct RTCCounterValue counterreadval;
    .....
    RTC_CounterEnable (); /* Start count */
    .....
    RTC_CounterGet ( &counterreadval ); /* Read count value */
    .....
}
```



```
}  
}
```

**RTC\_ConstPeriodInterruptEnable**

Sets the cycle of the interrupts INTRTC, then starts the cyclic interrupt function.

**[Classification]**

CG\_rtc.c

**[Syntax]**

```
#include "CG_rtc.h"
MD_STATUS RTC_ConstPeriodInterruptEnable ( enum RTCINTPeriod period );
```

**[Argument(s)]**

| I/O | Argument                          | Description   |
|-----|-----------------------------------|---|
| I   | enum RTCINTPeriod <i>period</i> ; | Interrupt INTRTC cycle<br>HALFSEC: 0.5 seconds<br>ONESEC: 1 second<br>ONEMIN: 1 minute<br>ONEHOUR: 1 hour<br>ONEDAY: 1 day<br>ONEMONTH: 1 month |

**[Return value]**

| Macro       | Description                    |
|-------------|--------------------------------|
| MD_OK       | Normal completion              |
| MD_ARGERROR | Invalid argument specification |

**[Example]**

Below is an example of setting the cycle of the interrupts INTRTC, then starting the cyclic interrupt function.

[CG\_main.c]

```
#include "CG_rtc.h"
void main ( void ) {
    .....
    RTC_ConstPeriodInterruptDisable (); /* End of cyclic interrupt function */
    .....
    RTC_ConstPeriodInterruptEnable ( HALFSEC ); /* Start of cyclic interrupt function */
    .....
}
```

**RTC\_ConstPeriodInterruptDisable**

Ends the cyclic interrupt function.

**[Classification]**

CG\_rtc.c

**[Syntax]**

```
void    RTC_ConstPeriodInterruptDisable ( void );
```

**[Argument(s)]**

None.

**[Return value]**

None.

**RTC\_ConstPeriodInterruptCallback**

Performs processing in response to the cyclic interrupt INTRTC.

**Remark** This API function is called as the callback routine of interrupt process MD\_INTRTC corresponding to the cyclic interrupt INTRTC.

**[Classification]**

CG\_rtc\_user.c

**[Syntax]**

```
void RTC_ConstPeriodInterruptCallback ( void );
```

**[Argument(s)]**

None.

**[Return value]**

None.

**RTC\_AlarmEnable**

Starts the alarm interrupt function.

**[Classification]**

CG\_rtc.c

**[Syntax]**

```
void    RTC_AlarmEnable ( void );
```

**[Argument(s)]**

None.

**[Return value]**

None.

**RTC\_AlarmDisable**

Ends the alarm interrupt function.

**[Classification]**

CG\_rtc.c

**[Syntax]**

```
void    RTC_AlarmDisable ( void );
```

**[Argument(s)]**

None.

**[Return value]**

None.

**RTC\_AlarmSet**

Sets the alarm conditions (weekday, hour, minute).

**[Classification]**

CG\_rtc.c

**[Syntax]**

```
#include "CG_rtc.h"
void RTC_AlarmSet ( struct RTCArmValue alarmval );
```

**[Argument(s)]**

| I/O | Argument                     | Description                              |
|-----|------------------------------|--|
| I   | struct RTCArmValue alarmval; | Alarm conditions (weekday, hour, minute) |

**Remark** Below is shown the structure RTCArmValue (alarm conditions).

```
struct RTCArmValue {
    UCHAR Alarmwm; /* Minute */
    UCHAR Alarmwh; /* Hour */
    UCHAR Alarmww; /* Weekday */
};
```

- Alarmwm (Minute)

Below are shown the meanings of each bit of the structure member Alarmwm.

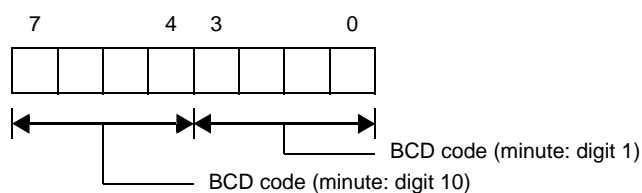

- Alarmwh (Hour)

Below are shown the meanings of each bit of the structure member Alarmwh. If the real-time counter is set to the 12-hour clock, then bit 5 has the following meaning.

- 0: AM
- 1: PM

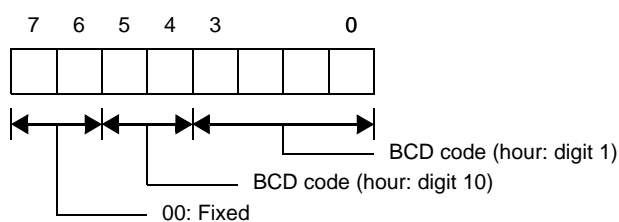

- Alarmww (Weekday)

Below are shown the meanings of each bit of the structure member Alarmww.

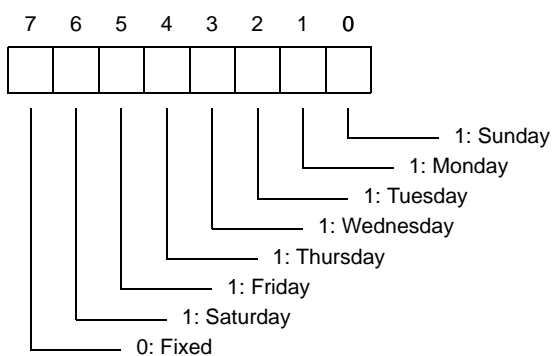

[Return value]

None.

[Example 1]

The example below shows the alarm conditions being set to "Monday/Tuesday/Wednesday at 17:30".

[CG\_main.c]

```
#include "CG_rtc.h"
void main ( void ) {
    struct RTCArmValue  alarmval;
    .....
    RTC_AlarmEnable ();          /* Start alarm interrupt function */
    RTC_CounterEnable ();       /* Start count */
    .....
    RTC_SetHourSystem ( HOUR24 ); /* Set clock type */
    alarmval.Alarmww = 0xe;
    alarmval.Alarmwh = 0x17;
    alarmval.Alarmwm = 0x30;
    RTC_AlarmSet ( alarmval );  /* Set conditions */
    .....
}
```



**[Example 2]**

The example below shows the alarm conditions being set to "Saturday/Sunday (time left unchanged)".

[CG\_main.c]

```
#include "CG_rtc.h"
void main ( void ) {
    struct RTCArmValue  alarmval;
    .....
    RTC_AlarmEnable ();          /* Start alarm interrupt function */
    .....
    RTC_AlarmSet ( alarmval );   /* Change conditions */
    .....
}
```

**RTC\_AlarmGet**

Reads the alarm conditions (weekday, hour, minute).

**[Classification]**

CG\_rtc.c

**[Syntax]**

```
#include "CG_rtc.h"
void RTC_AlarmGet ( struct RTCArmValue *alarmval );
```

**Remark** See [RTC\\_AlarmSet](#) for details about RTCArmValue (alarm conditions).

**[Argument(s)]**

| I/O | Argument                      | Description  |
|-----|-------------------------------|--|
| O   | struct RTCArmValue *alarmval; | Pointer to structure in which to store the conditions being read |

**[Return value]**

None.

**[Example]**

The example below shows the alarm conditions being read.

[CG\_main.c]

```
#include "CG_rtc.h"
void main ( void ) {
    struct RTCArmValue alarmval;
    .....
    RTC_AlarmEnable (); /* Start alarm interrupt function */
    .....
    RTC_AlarmGet ( &alarmval ); /* Read conditions */
    .....
}
```

**RTC\_AlarmInterruptCallback**

Performs processing in response to the alarm interrupt INTRTC.

**Remark** This API function is called as the callback routine of interrupt process MD\_INTRTC corresponding to the alarm interrupt INTRTC.

**[Classification]**

CG\_rtc\_user.c

**[Syntax]**

```
void RTC_AlarmInterruptCallback ( void );
```

**[Argument(s)]**

None.

**[Return value]**

None.

**RTC\_IntervalStart**

Starts the interval interrupt function.

**Remark** After setting the cycle of the interrupts INTRTCI, call [RTC\\_IntervalInterruptEnable](#) to start the interval interrupt function.

**[Classification]**

CG\_rtc.c

**[Syntax]**

```
void RTC_IntervalStart ( void );
```

**[Argument(s)]**

None.

**[Return value]**

None.

**RTC\_IntervalStop**

Ends the interval interrupt function.

**[Classification]**

CG\_rtc.c

**[Syntax]**

```
void RTC_IntervalStop ( void );
```

**[Argument(s)]**

None.

**[Return value]**

None.

**RTC\_IntervalInterruptEnable**

Sets the cycle of the interrupts INTRTCI, then starts the interval interrupt function.

**Remark** Call [RTC\\_IntervalStart](#) to start the interval interrupt function without setting the cycle of the interrupts INTRTCI.

**[Classification]**

CG\_rtc.c

**[Syntax]**

```
#include "CG_rtc.h"
MD_STATUS RTC_IntervalInterruptEnable ( enum RTCINTInterval interval );
```

**[Argument(s)]**

| I/O | Argument                      | Description   |
|-----|-------------------------------|---|
| I   | enum RTCINTInterval interval; | Interrupt INTRTCI cycle<br>INTERVAL0: 2 <sup>6</sup> /fSUB<br>INTERVAL1: 2 <sup>7</sup> /fSUB<br>INTERVAL2: 2 <sup>8</sup> /fSUB<br>INTERVAL3: 2 <sup>9</sup> /fSUB<br>INTERVAL4: 2 <sup>10</sup> /fSUB<br>INTERVAL5: 2 <sup>11</sup> /fSUB<br>INTERVAL6: 2 <sup>12</sup> /fSUB |

**Remark** fSUB is the frequency of the subsystem clock.

**[Return value]**

| Macro       | Description                    |
|-------------|--------------------------------|
| MD_OK       | Normal completion              |
| MD_ARGERROR | Invalid argument specification |

**[Example]**

Below is an example of changing the interval, the restarting the interval interrupt function.

[CG\_main.c]

```
#include "CG_rtc.h"
void main ( void ) {
    .....
    RTC_IntervalStart (); /* Start interval interrupt function */
    .....
}
```

```
RTC_IntervalStop ();                                /* End interval interrupt function */  
.....  
RTC_IntervalInterruptEnable ( INTERVAL6 ); /* Start interval interrupt function */  
.....  
}
```

**RTC\_IntervalInterruptDisable**

Ends the interval interrupt function.

**[Classification]**

CG\_rtc.c

**[Syntax]**

```
void    RTC_IntervalInterruptDisable ( void );
```

**[Argument(s)]**

None.

**[Return value]**

None.



**RTC\_RTC1HZ\_OutputEnable**

Enables output of the real-time counter correction clock (1 Hz) to the RTC1HZ pin.

**[Classification]**

CG\_rtc.c

**[Syntax]**

```
void    RTC_RTC1HZ_OutputEnable ( void );
```

**[Argument(s)]**

None.

**[Return value]**

None.

**RTC\_RTC1HZ\_OutputDisable**

Disables output of the real-time counter correction clock (1 Hz) to the RTC1HZ pin.

**[Classification]**

CG\_rtc.c

**[Syntax]**

```
void    RTC_RTC1HZ_OutputDisable ( void );
```

**[Argument(s)]**

None.

**[Return value]**

None.

**RTC\_RTCCCL\_OutputEnable**

Enables output of the real-time counter clock (32 kHz source) to the RTCCL pin.

**[Classification]**

CG\_rtc.c

**[Syntax]**

```
void    RTC_RTCCCL_OutputEnable ( void );
```

**[Argument(s)]**

None.

**[Return value]**

None.

**RTC\_RTCCCL\_OutputDisable**

Disables output of the real-time counter clock (32 kHz source) to the RTCCL pin.

**[Classification]**

CG\_rtc.c

**[Syntax]**

```
void    RTC_RTCCCL_OutputDisable ( void );
```

**[Argument(s)]**

None.

**[Return value]**

None.

**RTC\_RTCDIV\_OutputEnable**

Enables output of the real-time counter clock (32 kHz cycle) to the RTCDIV pin.

**[Classification]**

CG\_rtc.c

**[Syntax]**

```
void    RTC_RTCDIV_OutputEnable ( void );
```

**[Argument(s)]**

None.

**[Return value]**

None.

**RTC\_RTCDIV\_OutputDisable**

Disables output of the real-time counter clock (32 kHz cycle) to the RTCDIV pin.

**[Classification]**

CG\_rtc.c

**[Syntax]**

```
void    RTC_RTCDIV_OutputDisable ( void );
```

**[Argument(s)]**

None.

**[Return value]**

None.

**RTC\_ChangeCorrectionValue**

Changes the timing and correction value for correcting clock errors.

**[Classification]**

CG\_rtc.c

**[Syntax]**

```
#include "CG_macrodriver.h"
#include "CG_rtc.h"
MD_STATUS RTC_ChangeCorrectionValue ( enum RTCCorectionTiming timing, UCHAR corectval );
```

**[Argument(s)]**

| I/O | Argument                                | Description   |
|-----|---|---|
| I   | enum RTCCorectionTiming <i>timing</i> ; | When clock errors are corrected<br>EVERY20S: When the seconds digits are 00, 20 or 40<br>EVERY60S: When the seconds digits are 00 |
| I   | UCHAR <i>corectval</i> ;                | Clock error correction value  |

**Remark** This API function does not correct clock errors if correction value *corectVal* is set to 0x0, 0x1, 0x40 or 0x41.

**[Return value]**

| Macro       | Description                    |
|-------------|--------------------------------|
| MD_OK       | Normal completion              |
| MD_ARGERROR | Invalid argument specification |

**C.3.11 Clock Output**

Below is a list of API functions output by Code Generator for clock output use.

**Table C-12. API Functions: [Clock Output]**

| API Function Name | Function   |
|-------------------|--|
| PCL_Init          | Performs initialization necessary to control clock output control circuit functions. |
| PCL_UserInit      | Performs user-defined initialization relating to the clock output control circuits.  |
| PCL_Start         | Starts clock output.   |
| PCL_Stop          | Ends clock output.   |
| PCL_ChangeFreq    | Changes the output clock to the PCL pin.   |



**PCL\_Init**

Performs initialization necessary to control clock output control circuit functions.

**[Classification]**

CG\_pcl.c

**[Syntax]**

```
void PCL_Init ( void );
```

**[Argument(s)]**

None.

**[Return value]**

None.

**PCL\_UserInit**

Performs user-defined initialization relating to the clock output control circuits.

**Remark** This API function is called as the [PCL\\_Init](#) callback routine.

**[Classification]**

CG\_pcl\_user.c

**[Syntax]**

```
void PCL_UserInit ( void );
```

**[Argument(s)]**

None.

**[Return value]**

None.

**PCL\_Start**

Starts clock output.

**[Classification]**

CG\_pcl.c

**[Syntax]**

```
void PCL_Start ( void );
```

**[Argument(s)]**

None.

**[Return value]**

None.

**PCL\_Stop**

Ends clock output.

**[Classification]**

CG\_pcl.c

**[Syntax]**

```
void PCL_Stop ( void );
```

**[Argument(s)]**

None.

**[Return value]**

None.

**PCL\_ChangeFreq**

Changes the output clock to the PCL pin.

**Remark** The value specified in parameter *clock* is set to clock output select register (CKS).

**[Classification]**

CG\_pcl.c

**[Syntax]**

```
#include "CG_pclbuz.h"
MD_STATUS PCL_ChangeFreq ( enum PCLclock clock );
```

**[Argument(s)]**

| I/O | Argument                     | Description   |
|-----|------------------------------|---|
| I   | enum PCLclock <i>clock</i> ; | Output clock type<br>FPRS: fPRS<br>FPRS2: fPRS/2<br>FPRS4: fPRS/4<br>FPRS8: fPRS/8<br>FPRS16: fPRS/16<br>FPRS32: fPRS/2048<br>FPRS64: fPRS/4096<br>FPRS128: fPRS/8192<br>SUBCLOCK: fSUB |

**Remark** fPRS is the main system clock frequency; fSUB is the subsystem clock frequency.

**[Return value]**

| Macro       | Description                    |
|-------------|--------------------------------|
| MD_OK       | Normal completion              |
| MD_ARGERROR | Invalid argument specification |

**C.3.12 LVI**

Below is a list of API functions output by Code Generator for low-voltage detector use.

**Table C-13. API Functions: [LVI]**

| API Function Name                      | Function   |
|--|--|
| <a href="#">LVI_Init</a>               | Performs initialization necessary to control low-voltage detector functions. |
| <a href="#">LVI_UserInit</a>           | Performs user-defined initialization relating to the low-voltage detector.   |
| <a href="#">LVI_InterruptModeStart</a> | Starts low-voltage detection (when in interrupt generation mode).            |
| <a href="#">LVI_ResetModeStart</a>     | Starts low-voltage detection (when in internal reset mode).                  |
| <a href="#">LVI_Stop</a>               | Stops low-voltage detection.   |
| <a href="#">LVI_SetLVILevel</a>        | Sets the low-voltage detection level.  |

**LVI\_Init**

Performs initialization necessary to control low-voltage detector functions.

**[Classification]**

CG\_lvi.c

**[Syntax]**

```
void LVI_Init ( void );
```

**[Argument(s)]**

None.

**[Return value]**

None.

**LVI\_UserInit**

Performs user-defined initialization relating to the low-voltage detector.

**Remark** This API function is called as the [LVI\\_Init](#) callback routine.

**[Classification]**

CG\_lvi\_user.c

**[Syntax]**

```
void LVI_UserInit ( void );
```

**[Argument(s)]**

None.

**[Return value]**

None.



**LVI\_InterruptModeStart**

Starts low-voltage detection (when in interrupt generation mode).

**[Classification]**

CG\_lvi.c

**[Syntax]**

```
void LVI_InterruptModeStart ( void );
```

**[Argument(s)]**

None.

**[Return value]**

None.

**[Example]**

The example below shows the detection of low voltage when the operation mode is interrupt generation mode (generate the interrupt INTLVI).

[CG\_main.c]

```
void main ( void ) {  
    .....  
    LVI_InterruptModeStart ( );          /* Start low-voltage detection */  
    .....  
}
```

[CG\_lvi\_user.c]

```
__interrupt void MD_INTLVI ( void ) { /* Interrupt processing for INTLVI */  
    if ( LVIF == 1 ) {                /* Trigger identification: Check LVIF flag */  
        ..... /* Handle case when "power voltage (VDD) < detected voltage (VLVI)" detected */  
    } else {  
        ..... /* Handle case when "power voltage (VDD) >= detected voltage (VLVI)" detected */  
    }  
}
```

**LVI\_ResetModeStart**

Starts low-voltage detection (when in internal reset mode).

**[Classification]**

CG\_lvi.c

**[Syntax]**

```
MD_STATUS LVI_ResetModeStart ( void );
```

**[Argument(s)]**

None.

**[Return value]**

| Macro    | Description   |
|----------|---|
| MD_OK    | Normal completion   |
| MD_ERROR | Exit with error (abend) <ul style="list-style-type: none"> <li>- The object of low voltage detection is external voltage (VDD), and power voltage (VDD) &lt;= detected voltage (VLVI).</li> <li>- The object of low voltage detection is external input voltage (EXLVI), and external input voltage (EXLVI) &lt;= detected voltage (VEXLVI).</li> </ul> |

**LVI\_Stop**

Stops low-voltage detection.

**[Classification]**

CG\_lvi.c

**[Syntax]**

```
void LVI_Stop ( void );
```

**[Argument(s)]**

None.

**[Return value]**

None.

**LVI\_SetLVILevel**

Sets the low-voltage detection level.

- Remarks 1.** To change the low-voltage detection level, you must call [LVI\\_Stop](#) before calling this API function.  
**2.** The value specified in parameter *level* is set to low-voltage detection level select register (LVIS).

**[Classification]**

CG\_lvi.c

**[Syntax]**

```
#include "CG_macrodriver.h"
#include "CG_lvi.h"
MD_STATUS LVI_SetLVILevel ( enum LVILevel level );
```

**[Argument(s)]**

| I/O | Argument                     | Description  |
|-----|------------------------------|--|
| I   | enum LVILevel <i>level</i> ; | Voltage level to detect as low voltage<br>LVILEVEL0: 4.22 V ± 0.1 V<br>LVILEVEL1: 4.07 V ± 0.1 V<br>LVILEVEL2: 3.92 V ± 0.1 V<br>LVILEVEL3: 3.76 V ± 0.1 V<br>LVILEVEL4: 3.61 V ± 0.1 V<br>LVILEVEL5: 3.45 V ± 0.1 V<br>LVILEVEL6: 3.30 V ± 0.1 V<br>LVILEVEL7: 3.15 V ± 0.1 V<br>LVILEVEL8: 2.99 V ± 0.1 V<br>LVILEVEL9: 2.84 V ± 0.1 V<br>LVILEVEL10: 2.68 V ± 0.1 V<br>LVILEVEL11: 2.53 V ± 0.1 V<br>LVILEVEL12: 2.38 V ± 0.1 V<br>LVILEVEL13: 2.22 V ± 0.1 V<br>LVILEVEL14: 2.07 V ± 0.1 V<br>LVILEVEL15: 1.91 V ± 0.1 V |

**Remark** LVILEVEL10 to LVILEVEL15 can only be specified when the target device is a 78K0/Kx2-L.

**[Return value]**

| Macro       | Description   |
|-------------|---|
| MD_OK       | Normal completion   |
| MD_ERROR    | Exit with error (abend)<br>- The target of low-voltage detection is external input voltage (EXLVI) from the external input pin. |
| MD_ARGERROR | Invalid argument specification  |

**Remark** The value MD\_ERROR will only be returned when the target device is a 78K0/KB2-L or 78K0/KC2-L.

## APPENDIX D INDEX

**A**

A/D ... 187

- AD\_ComparatorOff ... 191
- AD\_ComparatorOn ... 190
- AD\_Init ... 188
- AD\_Read ... 195
- AD\_ReadByte ... 196
- AD\_SelectADChannel ... 194
- AD\_Start ... 192
- AD\_Stop ... 193
- AD\_UserInit ... 189

AD\_ComparatorOff ... 191

AD\_ComparatorOn ... 190

AD\_Init ... 188

AD\_Read ... 195

AD\_ReadByte ... 196

AD\_SelectADChannel ... 194

AD\_Start ... 192

AD\_Stop ... 193

AD\_UserInit ... 189

[All Output Messages] tab ... 81

AMPn\_Start ... 180

AMPn\_Stop ... 181

AMP\_Start ... 178

AMP\_Stop ... 179

API functions ... 95

- A/D ... 187
- Clock Output ... 264
- Comparator ... 182
- INT ... 121
- LVI ... 270
- Operational Amplifier ... 172
- Port ... 114
- RTC ... 230
- Serial ... 132
- System ... 103
- Timer ... 197
- Watchdog Timer ... 228

**B**

Browse For Folder dialog box ... 87

**C**

CG\_ChangeClockMode ... 107

CG\_ChangeFrequency ... 109

CG\_ChangePIIMode ... 113

CG\_ReadResetSource ... 106

CG\_SelectPowerSaveMode ... 110

CG\_SelectStabTime ... 112

CLOCK\_Init ... 104

Clock Output ... 264

- PCL\_ChangeFreq ... 269
- PCL\_Init ... 265
- PCL\_Start ... 267
- PCL\_Stop ... 268
- PCL\_UserInit ... 266

CLOCK\_UserInit ... 105

Code Generator panel ... 73

Code Generator Preview panel ... 76

[Code Generator] tab ... 82

Column Chooser dialog box ... 83

Comparator ... 182

- Comparator\_Init ... 183
- Comparatorm\_Start ... 185
- Comparatorm\_Stop ... 186
- Comparator\_UserInit ... 184

Comparator\_Init ... 183

Comparatorm\_Start ... 185

Comparatorm\_Stop ... 186

Comparator\_UserInit ... 184

CSI1n\_Init ... 147

CSI1n\_ReceiveData ... 151

CSI1n\_ReceiveEndCallback ... 156

CSI1n\_SendEndCallback ... 155

CSI1n\_SendReceiveData ... 153

CSI1n\_Start ... 149

CSI1n\_Stop ... 150

CSI1n\_UserInit ... 148

## D

Device Pin List panel ... 62

[External Peripheral] tab ... 68

[Macro] tab ... 66

[Pin Number] tab ... 64

Device Top View panel ... 70

[Device Top View Settings] tab ... 55

## E

[External Peripheral] tab ... 68

## F

[File Setting] tab ... 61

Functions ... 11, 26

Code Generator ... 26

Pin Configurator ... 11

## G

[Generation] tab ... 58

## I

IICA\_GetStopConditionCallback ... 171

IICA\_Init ... 157

IICA\_MasterErrorCallback ... 165

IICA\_MasterReceiveEndCallback ... 164

IICA\_MasterReceiveStart ... 161

IICA\_MasterSendEndCallback ... 163

IICA\_MasterSendStart ... 160

IICA\_SlaveErrorCallback ... 170

IICA\_SlaveReceiveEndCallback ... 169

IICA\_SlaveReceiveStart ... 167

IICA\_SlaveSendEndCallback ... 168

IICA\_SlaveSendStart ... 166

IICA\_Stop ... 159

IICA\_StopCondition ... 162

IICA\_UserInit ... 158

INT ... 121

INT\_MaskableInterruptEnable ... 126

INTP\_Init ... 122

INTPn\_Disable ... 128

INTPn\_Enable ... 129

INTP\_UserInit ... 123

KEY\_Disable ... 130

KEY\_Enable ... 131

KEY\_Init ... 124

KEY\_UserInit ... 125

INT\_MaskableInterruptEnable ... 126

INTP\_Init ... 122

INTPn\_Disable ... 128

INTPn\_Enable ... 129

INTP\_UserInit ... 123

## K

KEY\_Disable ... 130

KEY\_Enable ... 131

KEY\_Init ... 124

KEY\_UserInit ... 125

## L

LVI ... 270

LVI\_Init ... 271

LVI\_InterruptModeStart ... 273

LVI\_ResetModeStart ... 274

LVI\_SetLVILevel ... 276

LVI\_Stop ... 275

LVI\_UserInit ... 272

LVI\_Init ... 271

LVI\_InterruptModeStart ... 273

LVI\_ResetModeStart ... 274

LVI\_SetLVILevel ... 276

LVI\_Stop ... 275

LVI\_UserInit ... 272

## M

[Macro Setting] tab ... 60

[Macro] tab ... 66

Main window ... 43

## N

New Column dialog box ... 86

**O**

OPAMP\_Init ... 173  
 OPAMP\_UserInit ... 174  
 Operational Amplifier ... 172  
   AMPn\_Start ... 180  
   AMPn\_Stop ... 181  
   AMP\_Start ... 178  
   AMP\_Stop ... 179  
   OPAMP\_Init ... 173  
   OPAMP\_UserInit ... 174  
   PGA\_ChangePGAFactor ... 177  
   PGA\_Start ... 175  
   PGA\_Stop ... 176  
 Output panel ... 79  
   [All Output Messages] tab ... 81  
   [Code Generator] tab ... 82

**P**

PCL\_ChangeFreq ... 269  
 PCL\_Init ... 265  
 PCL\_Start ... 267  
 PCL\_Stop ... 268  
 PCL\_UserInit ... 266  
 PGA\_ChangePGAFactor ... 177  
 PGA\_Start ... 175  
 PGA\_Stop ... 176  
 [Pin Configurator Information] tab ... 54  
 [Pin Configurator Settings] tab ... 52  
 [Pin Number] tab ... 64  
 Port ... 114  
   PORT\_ChangePmnInput ... 117  
   PORT\_ChangePmnOutput ... 119  
   PORT\_Init ... 115  
   PORT\_UserInit ... 116  
 PORT\_ChangePmnInput ... 117  
 PORT\_ChangePmnOutput ... 119  
 PORT\_Init ... 115  
 PORT\_UserInit ... 116  
 Project Tree panel ... 46  
 Property panel ... 49  
   [Device Top View Settings] tab ... 55

[File Setting] tab ... 61  
 [Generation] tab ... 58  
 [Macro Setting] tab ... 60  
 [Pin Configurator Information] tab ... 54  
 [Pin Configurator Settings] tab ... 52

**R**

RTC ... 230  
   RTC\_AlarmDisable ... 246  
   RTC\_AlarmEnable ... 245  
   RTC\_AlarmGet ... 250  
   RTC\_AlarmInterruptCallback ... 251  
   RTC\_AlarmSet ... 247  
   RTC\_ChangeCorrectionValue ... 263  
   RTC\_ConstPeriodInterruptCallback ... 244  
   RTC\_ConstPeriodInterruptDisable ... 243  
   RTC\_ConstPeriodInterruptEnable ... 242  
   RTC\_CounterDisable ... 235  
   RTC\_CounterEnable ... 234  
   RTC\_CounterGet ... 240  
   RTC\_CounterSet ... 238  
   RTC\_Init ... 231  
   RTC\_IntervallInterruptDisable ... 256  
   RTC\_IntervallInterruptEnable ... 254  
   RTC\_IntervalStart ... 252  
   RTC\_IntervalStop ... 253  
   RTC\_PowerOff ... 233  
   RTC\_RTC1HZ\_OutputDisable ... 258  
   RTC\_RTC1HZ\_OutputEnable ... 257  
   RTC\_RTCCCL\_OutputDisable ... 260  
   RTC\_RTCCCL\_OutputEnable ... 259  
   RTC\_RTCDIV\_OutputDisable ... 262  
   RTC\_RTCDIV\_OutputEnable ... 261  
   RTC\_SetHourSystem ... 236  
   RTC\_UserInit ... 232  
 RTC\_AlarmDisable ... 246  
 RTC\_AlarmEnable ... 245  
 RTC\_AlarmGet ... 250  
 RTC\_AlarmInterruptCallback ... 251  
 RTC\_AlarmSet ... 247  
 RTC\_ChangeCorrectionValue ... 263



- RTC\_ConstPeriodInterruptCallback ... 244  
 RTC\_ConstPeriodInterruptDisable ... 243  
 RTC\_ConstPeriodInterruptEnable ... 242  
 RTC\_CounterDisable ... 235  
 RTC\_CounterEnable ... 234  
 RTC\_CounterGet ... 240  
 RTC\_CounterSet ... 238  
 RTC\_Init ... 231  
 RTC\_IntervallInterruptDisable ... 256  
 RTC\_IntervallInterruptEnable ... 254  
 RTC\_IntervalStart ... 252  
 RTC\_IntervalStop ... 253  
 RTC\_PowerOff ... 233  
 RTC\_RTC1HZ\_OutputDisable ... 258  
 RTC\_RTC1HZ\_OutputEnable ... 257  
 RTC\_RTCCCL\_OutputDisable ... 260  
 RTC\_RTCCCL\_OutputEnable ... 259  
 RTC\_RTCDIV\_OutputDisable ... 262  
 RTC\_RTCDIV\_OutputEnable ... 261  
 RTC\_SetHourSystem ... 236  
 RTC\_UserInit ... 232
- S**
- Save As dialog box ... 88  
 Serial ... 132
  - CSI1n\_Init ... 147
  - CSI1n\_ReceiveData ... 151
  - CSI1n\_ReceiveEndCallback ... 156
  - CSI1n\_SendEndCallback ... 155
  - CSI1n\_SendReceiveData ... 153
  - CSI1n\_Start ... 149
  - CSI1n\_Stop ... 150
  - CSI1n\_UserInit ... 148
  - IICA\_GetStopConditionCallback ... 171
  - IICA\_Init ... 157
  - IICA\_MasterErrorCallback ... 165
  - IICA\_MasterReceiveEndCallback ... 164
  - IICA\_MasterReceiveStart ... 161
  - IICA\_MasterSendEndCallback ... 163
  - IICA\_MasterSendStart ... 160
  - IICA\_SlaveErrorCallback ... 170
  - IICA\_SlaveReceiveEndCallback ... 169
  - IICA\_SlaveReceiveStart ... 167
  - IICA\_SlaveSendEndCallback ... 168
  - IICA\_SlaveSendStart ... 166
  - IICA\_Stop ... 159
  - IICA\_StopCondition ... 162
  - IICA\_UserInit ... 158
  - UART6\_ErrorCallback ... 145
  - UART6\_Init ... 134
  - UART6\_ReceiveData ... 140
  - UART6\_ReceiveEndCallback ... 143
  - UART6\_SendData ... 138
  - UART6\_SendEndCallback ... 142
  - UART6\_SoftOverRunCallback ... 144
  - UART6\_Start ... 136
  - UART6\_Stop ... 137
  - UART6\_UserInit ... 135
- System ... 103
- CG\_ChangeClockMode ... 107
  - CG\_ChangeFrequency ... 109
  - CG\_ChangePIIMode ... 113
  - CG\_ReadResetSource ... 106
  - CG\_SelectPowerSaveMode ... 110
  - CG\_SelectStabTime ... 112
  - CLOCK\_Init ... 104
  - CLOCK\_UserInit ... 105
- T**
- Timer ... 197
  - TM00\_ChangeDuty ... 212
  - TM00\_ChangeTimerCondition ... 209
  - TM00\_GetFreeRunningValue ... 210
  - TM00\_GetPulseWidth ... 213
  - TM00\_Init ... 205
  - TM00\_SoftwareTriggerOn ... 211
  - TM00\_Start ... 207
  - TM00\_Stop ... 208
  - TM00\_UserInit ... 206
  - TM5n\_ChangeDuty ... 219
  - TM5n\_ChangeTimerCondition ... 218
  - TM5n\_Init ... 214

- TM5n\_Start ... 216
  - TM5n\_Stop ... 217
  - TM5n\_UserInit ... 215
  - TMH1\_CarrierOutputDisable ... 227
  - TMH1\_CarrierOutputEnable ... 226
  - TMHn\_ChangeDuty ... 225
  - TMHn\_ChangeTimerCondition ... 224
  - TMHn\_Init ... 220
  - TMHn\_Start ... 222
  - TMHn\_Stop ... 223
  - TMHn\_UserInit ... 221
  - TMX\_DisableHighImpedanceState ... 204
  - TMX\_EnableHighImpedanceState ... 203
  - TMX\_Init ... 198
  - TMXn\_ChangeDualDuty ... 202
  - TMXn\_ChangeDuty ... 201
  - TMXn\_Start ... 199
  - TMXn\_Stop ... 200
  - TM00\_ChangeDuty ... 212
  - TM00\_ChangeTimerCondition ... 209
  - TM00\_GetFreeRunningValue ... 210
  - TM00\_GetPulseWidth ... 213
  - TM00\_Init ... 205
  - TM00\_SoftwareTriggerOn ... 211
  - TM00\_Start ... 207
  - TM00\_Stop ... 208
  - TM00\_UserInit ... 206
  - TM5n\_ChangeDuty ... 219
  - TM5n\_ChangeTimerCondition ... 218
  - TM5n\_Init ... 214
  - TM5n\_Start ... 216
  - TM5n\_Stop ... 217
  - TM5n\_UserInit ... 215
  - TMH1\_CarrierOutputDisable ... 227
  - TMH1\_CarrierOutputEnable ... 226
  - TMHn\_ChangeDuty ... 225
  - TMHn\_ChangeTimerCondition ... 224
  - TMHn\_Init ... 220
  - TMHn\_Start ... 222
  - TMHn\_Stop ... 223
  - TMHn\_UserInit ... 221
  - TMX\_DisableHighImpedanceState ... 204
  - TMX\_EnableHighImpedanceState ... 203
  - TMX\_Init ... 198
  - TMXn\_ChangeDualDuty ... 202
  - TMXn\_ChangeDuty ... 201
  - TMXn\_Start ... 199
  - TMXn\_Stop ... 200
- U**
- UART6\_ErrorCallback ... 145
  - UART6\_Init ... 134
  - UART6\_ReceiveData ... 140
  - UART6\_ReceiveEndCallback ... 143
  - UART6\_SendData ... 138
  - UART6\_SendEndCallback ... 142
  - UART6\_SoftOverRunCallback ... 144
  - UART6\_Start ... 136
  - UART6\_Stop ... 137
  - UART6\_UserInit ... 135
- W**
- Watchdog Timer ... 228
    - WDT\_Restart ... 229
  - WDT\_Restart ... 229
  - Window reference ... 42

Revision Record

| Rev. | Date         | Description |                      |
|------|--------------|-------------|----------------------|
|      |              | Page        | Summary              |
| 1.00 | Apr 01, 2011 | -           | First Edition issued |

---

CubeSuite+ V1.00.00  
User's Manual: 78K0 Design

Publication Date: Rev.1.00 Apr 01, 2011

Published by: Renesas Electronics Corporation

---

**SALES OFFICES****Renesas Electronics Corporation**<http://www.renesas.com>Refer to "<http://www.renesas.com/>" for the latest and detailed information.

**Renesas Electronics America Inc.**  
2880 Scott Boulevard Santa Clara, CA 95050-2554, U.S.A.  
Tel: +1-408-588-6000, Fax: +1-408-588-6130

**Renesas Electronics Canada Limited**  
1101 Nicholson Road, Newmarket, Ontario L3Y 9C3, Canada  
Tel: +1-905-898-5441, Fax: +1-905-898-3220

**Renesas Electronics Europe Limited**  
Dukes Meadow, Millboard Road, Bourne End, Buckinghamshire, SL8 5FH, U.K  
Tel: +44-1628-585-100, Fax: +44-1628-585-900

**Renesas Electronics Europe GmbH**  
Arcadiastrasse 10, 40472 Düsseldorf, Germany  
Tel: +49-211-65030, Fax: +49-211-6503-1327

**Renesas Electronics (China) Co., Ltd.**  
7th Floor, Quantum Plaza, No.27 ZhiChunLu Haidian District, Beijing 100083, P.R.China  
Tel: +86-10-8235-1155, Fax: +86-10-8235-7679

**Renesas Electronics (Shanghai) Co., Ltd.**  
Unit 204, 205, AZIA Center, No.1233 Lujiazui Ring Rd., Pudong District, Shanghai 200120, China  
Tel: +86-21-5877-1818, Fax: +86-21-6887-7858 / -7898

**Renesas Electronics Hong Kong Limited**  
Unit 1601-1613, 16/F., Tower 2, Grand Century Place, 193 Prince Edward Road West, Mongkok, Kowloon, Hong Kong  
Tel: +852-2886-9318, Fax: +852 2886-9022/9044

**Renesas Electronics Taiwan Co., Ltd.**  
7F, No. 363 Fu Shing North Road Taipei, Taiwan  
Tel: +886-2-8175-9600, Fax: +886 2-8175-9670

**Renesas Electronics Singapore Pte. Ltd.**  
1 harbourFront Avenue, #06-10, keppel Bay Tower, Singapore 098632  
Tel: +65-6213-0200, Fax: +65-6278-8001

**Renesas Electronics Malaysia Sdn.Bhd.**  
Unit 906, Block B, Menara Amcorp, Amcorp Trade Centre, No. 18, Jln Persiaran Barat, 46050 Petaling Jaya, Selangor Darul Ehsan, Malaysia  
Tel: +60-3-7955-9390, Fax: +60-3-7955-9510

**Renesas Electronics Korea Co., Ltd.**  
11F., Samik Laviel'or Bldg., 720-2 Yeoksam-Dong, Kangnam-Ku, Seoul 135-080, Korea  
Tel: +82-2-558-3737, Fax: +82-2-558-5141

CubeSuite+ V1.00.00



Renesas Electronics Corporation

R20UT0546EJ0100