

Bluetooth Low Energy Protocol Stack Basic Package

User's Manual

RENESAS MCU
RX Family / RX200 Series / RX23W Group

All information contained in these materials, including products and product specifications, represents information on the product at the time of publication and is subject to change by Renesas Electronics Corp. without notice. Please review the latest information published by Renesas Electronics Corp. through various means, including the Renesas Electronics Corp. website (<http://www.renesas.com>).

Notice

1. Descriptions of circuits, software and other related information in this document are provided only to illustrate the operation of semiconductor products and application examples. You are fully responsible for the incorporation or any other use of the circuits, software, and information in the design of your product or system. Renesas Electronics disclaims any and all liability for any losses and damages incurred by you or third parties arising from the use of these circuits, software, or information.
2. Renesas Electronics hereby expressly disclaims any warranties against and liability for infringement or any other claims involving patents, copyrights, or other intellectual property rights of third parties, by or arising from the use of Renesas Electronics products or technical information described in this document, including but not limited to, the product data, drawings, charts, programs, algorithms, and application examples.
3. No license, express, implied or otherwise, is granted hereby under any patents, copyrights or other intellectual property rights of Renesas Electronics or others.
4. You shall be responsible for determining what licenses are required from any third parties, and obtaining such licenses for the lawful import, export, manufacture, sales, utilization, distribution or other disposal of any products incorporating Renesas Electronics products, if required.
5. You shall not alter, modify, copy, or reverse engineer any Renesas Electronics product, whether in whole or in part. Renesas Electronics disclaims any and all liability for any losses or damages incurred by you or third parties arising from such alteration, modification, copying or reverse engineering.
6. Renesas Electronics products are classified according to the following two quality grades: "Standard" and "High Quality". The intended applications for each Renesas Electronics product depends on the product's quality grade, as indicated below.

"Standard": Computers; office equipment; communications equipment; test and measurement equipment; audio and visual equipment; home electronic appliances; machine tools; personal electronic equipment; industrial robots; etc.

"High Quality": Transportation equipment (automobiles, trains, ships, etc.); traffic control (traffic lights); large-scale communication equipment; key financial terminal systems; safety control equipment; etc.

Unless expressly designated as a high reliability product or a product for harsh environments in a Renesas Electronics data sheet or other Renesas Electronics document, Renesas Electronics products are not intended or authorized for use in products or systems that may pose a direct threat to human life or bodily injury (artificial life support devices or systems; surgical implantations; etc.), or may cause serious property damage (space system; undersea repeaters; nuclear power control systems; aircraft control systems; key plant systems; military equipment; etc.). Renesas Electronics disclaims any and all liability for any damages or losses incurred by you or any third parties arising from the use of any Renesas Electronics product that is inconsistent with any Renesas Electronics data sheet, user's manual or other Renesas Electronics document.

7. No semiconductor product is absolutely secure. Notwithstanding any security measures or features that may be implemented in Renesas Electronics hardware or software products, Renesas Electronics shall have absolutely no liability arising out of any vulnerability or security breach, including but not limited to any unauthorized access to or use of a Renesas Electronics product or a system that uses a Renesas Electronics product. RENESAS ELECTRONICS DOES NOT WARRANT OR GUARANTEE THAT RENESAS ELECTRONICS PRODUCTS, OR ANY SYSTEMS CREATED USING RENESAS ELECTRONICS PRODUCTS WILL BE INVULNERABLE OR FREE FROM CORRUPTION, ATTACK, VIRUSES, INTERFERENCE, HACKING, DATA LOSS OR THEFT, OR OTHER SECURITY INTRUSION ("Vulnerability Issues"). RENESAS ELECTRONICS DISCLAIMS ANY AND ALL RESPONSIBILITY OR LIABILITY ARISING FROM OR RELATED TO ANY VULNERABILITY ISSUES. FURTHERMORE, TO THE EXTENT PERMITTED BY APPLICABLE LAW, RENESAS ELECTRONICS DISCLAIMS ANY AND ALL WARRANTIES, EXPRESS OR IMPLIED, WITH RESPECT TO THIS DOCUMENT AND ANY RELATED OR ACCOMPANYING SOFTWARE OR HARDWARE, INCLUDING BUT NOT LIMITED TO THE IMPLIED WARRANTIES OF MERCHANTABILITY, OR FITNESS FOR A PARTICULAR PURPOSE.
8. When using Renesas Electronics products, refer to the latest product information (data sheets, user's manuals, application notes, "General Notes for Handling and Using Semiconductor Devices" in the reliability handbook, etc.), and ensure that usage conditions are within the ranges specified by Renesas Electronics with respect to maximum ratings, operating power supply voltage range, heat dissipation characteristics, installation, etc. Renesas Electronics disclaims any and all liability for any malfunctions, failure or accident arising out of the use of Renesas Electronics products outside of such specified ranges.
9. Although Renesas Electronics endeavors to improve the quality and reliability of Renesas Electronics products, semiconductor products have specific characteristics, such as the occurrence of failure at a certain rate and malfunctions under certain use conditions. Unless designated as a high reliability product or a product for harsh environments in a Renesas Electronics data sheet or other Renesas Electronics document, Renesas Electronics products are not subject to radiation resistance design. You are responsible for implementing safety measures to guard against the possibility of bodily injury, injury or damage caused by fire, and/or danger to the public in the event of a failure or malfunction of Renesas Electronics products, such as safety design for hardware and software, including but not limited to redundancy, fire control and malfunction prevention, appropriate treatment for aging degradation or any other appropriate measures. Because the evaluation of microcomputer software alone is very difficult and impractical, you are responsible for evaluating the safety of the final products or systems manufactured by you.
10. Please contact a Renesas Electronics sales office for details as to environmental matters such as the environmental compatibility of each Renesas Electronics product. You are responsible for carefully and sufficiently investigating applicable laws and regulations that regulate the inclusion or use of controlled substances, including without limitation, the EU RoHS Directive, and using Renesas Electronics products in compliance with all these applicable laws and regulations. Renesas Electronics disclaims any and all liability for damages or losses occurring as a result of your noncompliance with applicable laws and regulations.
11. Renesas Electronics products and technologies shall not be used for or incorporated into any products or systems whose manufacture, use, or sale is prohibited under any applicable domestic or foreign laws or regulations. You shall comply with any applicable export control laws and regulations promulgated and administered by the governments of any countries asserting jurisdiction over the parties or transactions.
12. It is the responsibility of the buyer or distributor of Renesas Electronics products, or any other party who distributes, disposes of, or otherwise sells or transfers the product to a third party, to notify such third party in advance of the contents and conditions set forth in this document.
13. This document shall not be reprinted, reproduced or duplicated in any form, in whole or in part, without prior written consent of Renesas Electronics.
14. Please contact a Renesas Electronics sales office if you have any questions regarding the information contained in this document or Renesas Electronics products.

(Note1) "Renesas Electronics" as used in this document means Renesas Electronics Corporation and also includes its directly or indirectly controlled subsidiaries.

(Note2) "Renesas Electronics product(s)" means any product developed or manufactured by or for Renesas Electronics.

(Rev.5.0-1 October 2020)

Corporate Headquarters

TOYOSU FORESIA, 3-2-24 Toyosu,
Koto-ku, Tokyo 135-0061, Japan
www.renesas.com

Trademarks

Renesas and the Renesas logo are trademarks of Renesas Electronics Corporation.

The Bluetooth® word mark and logos are registered trademarks owned by Bluetooth SIG, Inc. and any use of such marks by Renesas Electronics Corporation is under license. All trademarks and registered trademarks are the property of their respective owners.

Contact information

For further information on a product, technology, the most up-to-date version of a document, or your nearest sales office, please visit:
www.renesas.com/contact/.

General Precautions in the Handling of Microprocessing Unit and Microcontroller Unit Products

The following usage notes are applicable to all Microprocessing unit and Microcontroller unit products from Renesas. For detailed usage notes on the products covered by this document, refer to the relevant sections of the document as well as any technical updates that have been issued for the products.

1. Precaution against Electrostatic Discharge (ESD)

A strong electrical field, when exposed to a CMOS device, can cause destruction of the gate oxide and ultimately degrade the device operation. Steps must be taken to stop the generation of static electricity as much as possible, and quickly dissipate it when it occurs. Environmental control must be adequate. When it is dry, a humidifier should be used. This is recommended to avoid using insulators that can easily build up static electricity. Semiconductor devices must be stored and transported in an anti-static container, static shielding bag or conductive material. All test and measurement tools including work benches and floors must be grounded. The operator must also be grounded using a wrist strap. Semiconductor devices must not be touched with bare hands. Similar precautions must be taken for printed circuit boards with mounted semiconductor devices.

2. Processing at power-on

The state of the product is undefined at the time when power is supplied. The states of internal circuits in the LSI are indeterminate and the states of register settings and pins are undefined at the time when power is supplied. In a finished product where the reset signal is applied to the external reset pin, the states of pins are not guaranteed from the time when power is supplied until the reset process is completed. In a similar way, the states of pins in a product that is reset by an on-chip power-on reset function are not guaranteed from the time when power is supplied until the power reaches the level at which resetting is specified.

3. Input of signal during power-off state

Do not input signals or an I/O pull-up power supply while the device is powered off. The current injection that results from input of such a signal or I/O pull-up power supply may cause malfunction and the abnormal current that passes in the device at this time may cause degradation of internal elements. Follow the guideline for input signal during power-off state as described in your product documentation.

4. Handling of unused pins

Handle unused pins in accordance with the directions given under handling of unused pins in the manual. The input pins of CMOS products are generally in the high-impedance state. In operation with an unused pin in the open-circuit state, extra electromagnetic noise is induced in the vicinity of the LSI, an associated shoot-through current flows internally, and malfunctions occur due to the false recognition of the pin state as an input signal become possible.

5. Clock signals

After applying a reset, only release the reset line after the operating clock signal becomes stable. When switching the clock signal during program execution, wait until the target clock signal is stabilized. When the clock signal is generated with an external resonator or from an external oscillator during a reset, ensure that the reset line is only released after full stabilization of the clock signal. Additionally, when switching to a clock signal produced with an external resonator or by an external oscillator while program execution is in progress, wait until the target clock signal is stable.

6. Voltage application waveform at input pin

Waveform distortion due to input noise or a reflected wave may cause malfunction. If the input of the CMOS device stays in the area between V_{IL} (Max.) and V_{IH} (Min.) due to noise, for example, the device may malfunction. Take care to prevent chattering noise from entering the device when the input level is fixed, and also in the transition period when the input level passes through the area between V_{IL} (Max.) and V_{IH} (Min.).

7. Prohibition of access to reserved addresses

Access to reserved addresses is prohibited. The reserved addresses are provided for possible future expansion of functions. Do not access these addresses as the correct operation of the LSI is not guaranteed.

8. Differences between products

Before changing from one product to another, for example to a product with a different part number, confirm that the change will not lead to problems. The characteristics of a microprocessing unit or microcontroller unit products in the same group but having a different part number might differ in terms of internal memory capacity, layout pattern, and other factors, which can affect the ranges of electrical characteristics, such as characteristic values, operating margins, immunity to noise, and amount of radiated noise. When changing to a product with a different part number, implement a system-evaluation test for the given product.

How to Use This Manual

1. Purpose and Target Readers

This manual is designed to provide the user with an understanding of the usages and the provided functions of the Bluetooth® Low Energy protocol stack. It is intended for users designing applications incorporating the software. A basic knowledge of MCUs and software development environment and Bluetooth® Low Energy is necessary in order to use this manual.

The manual comprises an overview of the product; how to install, how to build and the usage of the provided functions.

Particular attention should be paid to the precautionary notes when using the manual. These notes occur within the body of the text and at the end of each section.

The revision history summarizes the locations of revisions and additions. It does not list all revisions. Refer to the text of the manual for details.

The following documents apply to the RX23W Group. Make sure to refer to the latest versions of these documents. The newest versions of the documents listed may be obtained from the Renesas Electronics Web site.

Document Type	Description	Document Title	Document No.
Data Sheet	Hardware overview and electrical characteristics	RX23W Group Datasheet	R01DS0342EJ
User's manual for Hardware	Hardware specifications (pin assignments, memory maps, peripheral specifications, electrical characteristics, and timing charts) and descriptions of operation	RX23W Group User's Manual: Hardware	R01UH0823EJ
User's manual for Software	Detailed descriptions of the CPU and instruction set	RX Family RXv2 Instruction Set Architecture User's Manual: Software	R01US0071EJ
User's manual for Middleware	Overview of the product, how to install, how to build and usage of the provided function	Bluetooth Low Energy Protocol Stack Basic Package User's Manual	This User's manual
Application Note	Notes on Printed Circuit Board Patterns	RX Family Hardware Design Guide	R01AN1411EJ
		RX23W Group Tuning procedure of Bluetooth dedicated clock frequency	R01AN4762EJ
	Examples of applications and sample programs	RX23W Group BLE Module Firmware Integration Technology	R01AN4860EJ
		Bluetooth Low Energy Profile Developer's Guide	R01AN6459EJ
Application Note	Examples of applications and sample programs	RX23W Group Bluetooth Low Energy Application Developer's Guide	R01AN5504EJ
Renesas Technical Update	Product specifications, updates on documents, etc.	—	—

2. List of Abbreviations and Acronyms

Abbreviation	Full Form
API	Application Programming Interface
ATT	Attribute Protocol
BD	Bluetooth Device
BD_ADDR	Bluetooth Device Address
BSP	Board Support Package
BTTS	Bluetooth Test Tool Suite
CLI	Command Line Interface
CMT	Compare Match Timer
CSRK	Connection Signature Resolving Key
DFU	Device Firmware Update
ECDH	Elliptic curve Diffie–Hellman key exchange
EDIV	Encrypted Diversifier
FIT	Firmware Integration Technology
GAP	Generic Access Profile
GATT	Generic Attribute Profile
HCI	Host Controller Interface
L2CAP	Logical Link Control and Adaptation Protocol
IRK	Identity Resolving Key
LE	Low Energy
LL	Link Layer
LTK	Long Term Key
MCU	Micro Controller Unit
MITM	Man-in-the-middle
OOB	Out of Band
OS	Operating System
OTA	Over The Air
PHY	Physical layer
QE	Quick and Effective tool solution
RF	Radio Frequency
RFP	Renesas Flash Programmer
RPA	Resolvable Private Address
RSK	Renesas Starter Kit
RSSI	Received Signal Strength Indication
RSSK	Renesas Solution Starter Kit

Abbreviation	Full Form
SC	Smart Configurator
SCI	Serial Communication Interface
SM	Security Manager
SMP	Security Manager Protocol
STK	Short Term Key
TB	Target Board
TK	Temporary Key
UART	Universal Asynchronous Receiver Transmitter
USB	Universal Serial Bus
UUID	Universal Unique Identifier
VS	Vendor Specific
WDT	Watchdog Timer

Contents

1. Overview.....	1
1.1 Features.....	1
1.2 Specifications.....	2
2. Installation	3
2.1 Package Contents.....	3
2.2 Project Configuration	5
2.3 Build Environment.....	6
2.4 Install.....	7
2.4.1 BLE FIT Module	7
2.4.2 Demo projects	8
3. Software Structure	9
3.1 Bluetooth LE Protocol Stack	10
3.1.1 Bluetooth LE Protocol Stack structure	10
3.1.2 Bluetooth LE Protocol Stack library	13
3.2 app_lib.....	16
3.2.1 Abstraction API.....	16
3.2.2 Software Timer.....	16
3.2.3 Security Data Management.....	16
3.2.4 Profile Common.....	17
3.2.5 Logger	17
3.2.6 Command line	17
3.2.7 LED and Switch Control	17
3.2.8 BLE Task Control	17
4. Software Setting	18
4.1 Configuration options.....	18
4.2 Sections	26
4.2.1 Linker settings for application project.....	27
4.3 Bluetooth Device Address.....	30
4.4 Bluetooth Device Name	30
4.4.1 Inform by Advertising packet.....	30
4.4.2 Inform by Device Name Characteristic	32
5. Original Features	33
5.1 Command Line Interface.....	33
5.1.1 GAP command.....	35
5.1.2 Vendor Specific (VS) command	48
5.1.3 SYS command	53
5.1.4 BLE command.....	54
5.2 Security Data Management	55
5.2.1 Security data management information	56
5.2.2 Local device security data.....	57
5.2.3 Remote device security data.....	59
5.3 RF communication timing notification	61
5.3.1 Connection event notification timing	62
5.3.2 Advertising event notification timing.....	63
5.3.3 Scan / Initiator event notification timing	63
5.3.4 RF sleep mode event notification timing	64
5.3.5 RF communication timing notification specifications	65

5.4	Device-specific Data Management	66
5.4.1	Specifying Device-specific data location block	66
5.4.2	Device-specific data format	67
5.4.3	Writing to user area (ROM)	67
5.4.4	Writing to data area (E2 DataFlash)	68
5.4.5	RX23W flash memory protection function.....	70
5.4.6	BD address adoption flow	71
6.	HCI Mode	72
6.1	Software Structure	72
6.2	Demo Project	73
6.2.1	Change device type of project.....	75
6.3	UART Driver.....	79
6.3.1	Configuration Options of UART Driver	79
7.	Appendix.....	81
7.1	Firmware writing procedure for Target Board for RX23W (retaining device-specific data)	81

1. Overview

1.1 Features

The Bluetooth® Low Energy Protocol Stack Basic Package includes the BLE FIT module for RX23W group compliant with Bluetooth Core Specification version 5.0 and fundamental software for developing Bluetooth Low Energy (hereinafter referred to as “Bluetooth LE”) application.

1.2 Specifications

Table 1.1 shows the specifications of the software provided by the Bluetooth Low Energy Protocol Stack Basic Package.

Table 1.1. Specifications

Item	Description
BLE FIT module	<p>The BLE FIT module for RX23W group provides the following Bluetooth LE features by R_BLE API.</p> <p><Feature of Bluetooth 5.0></p> <ul style="list-style-type: none"> • LE 2M PHY • LE Coded PHY • LE Advertising Extensions • LE Channel Selection Algorithm #2 • High Duty Cycle Non-Connectable Advertising <p><Feature of Bluetooth 4.2></p> <ul style="list-style-type: none"> • LE Secure Connections • Link Layer Privacy • LE Data Packet Length Extension • Link Layer Extended Scanner Filter Policies <p><Feature of Bluetooth 4.1></p> <ul style="list-style-type: none"> • LE L2CAP Connection Oriented Channel Support • Low Duty Cycle Directed Advertising • 32-bit UUID Support in LE • LE Link Layer Topology • LE Ping <p>The following features for Bluetooth LE Application are provided.</p> <p>[app_lib]</p> <ul style="list-style-type: none"> • Abstraction API • Software Timer • Security Data Management • Logger • Command line • LED and Switch Control • BLE Task Control <p>The BLE FIT v2.50 or later doesn't include Profile Common in app_lib. Profile Comon is provided by QE for BLE V1.6.0 or later.</p> <p>[Bluetooth LE Protocol Stack]</p> <ul style="list-style-type: none"> • RF communication timing notification • Device-specific Data Management
Demo projects	<p>The following projects are provided as sample applications for Bluetooth LE initial operation check.</p> <ul style="list-style-type: none"> • Custom profile GATT server application • Custom profile GATT client application • HCI mode
Utility	<p>The following tools (Windows applications) are provided for HCI mode.</p> <ul style="list-style-type: none"> • Public BD address writing tool for HCI mode (BDAddrWriter) • Operation tool for calibration for HCI mode (CLVALTune)

2. Installation

2.1 Package Contents

The Bluetooth Low Energy Protocol Stack Basic Package is available from the Renesas Bluetooth Low Energy Protocol Stack for RX family Web page (<https://www.renesas.com/software-tool/bluetooth-low-energy-protocol-stack-rx-family>) or “RX23W Group BLE Module Firmware Integration Technology Application Note” on e²studio Smart Browser. If you want to download only the BLE FIT module, see “2.4 Install”.

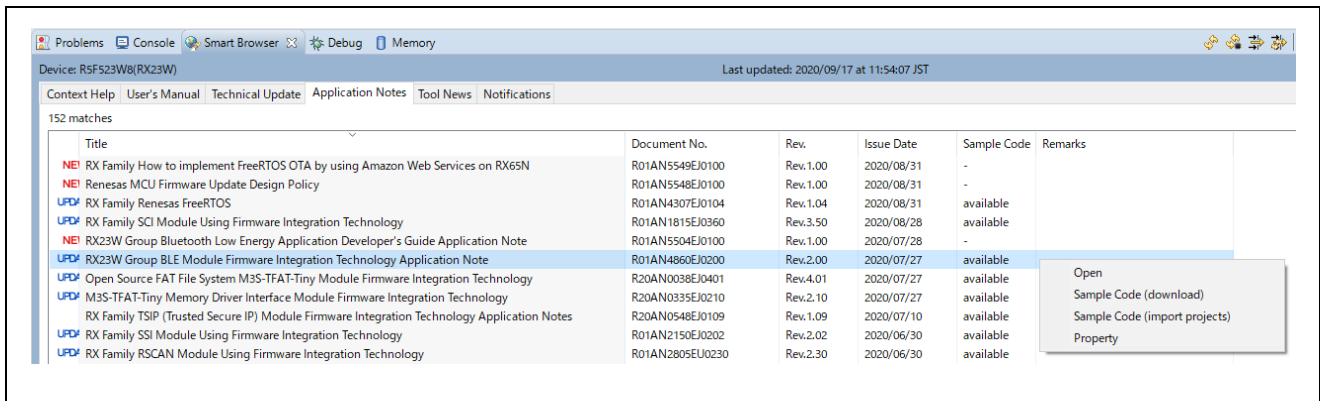

Figure 2.1. e²studio Smart Browser

Table 2.1 shows the contents of the Bluetooth Low Energy Protocol Stack Basic Package.

Table 2.1. Contents of the Bluetooth Low Energy Protocol Stack Basic Package

r01an4860xxXXXX-rx23w-ble-fit.zip	XXXX: Revision number
FITDemos\	Sample application folder
ble_demo_rsskrx23w_profile_client.zip	GATT client project for RSSK RX23W
ble_demo_rsskrx23w_profile_server.zip	GATT server project for RSSK RX23W
ble_demo_rsskrx23w_uart_hci.zip	HCI mode project for RSSK RX23W
ble_demo_tbrx23w_FreeRTOS_multi_services.zip	FreeRTOS GATT server project for Target Board for RX23W
ble_demo_tbrx23w_profile_client.zip	GATT client project for Target Board for RX23W
ble_demo_tbrx23w_profile_server.zip	GATT server project for Target Board for RX23W
ble_demo_tbrx23w_uart_hci.zip	HCI mode project for Target Board for RX23W
ble_demo_tbrx23wmodule_profile_client.zip	GATT client project for Target Board for RX23W module
ble_demo_tbrx23wmodule_profile_server.zip	GATT server project for Target Board for RX23W module
ble_demo_tbrx23wmodule_uart_hci.zip	HCI mode project for Target Board for RX23W module
ROM_Files\	Mot files
ble_demo_rsskrx23w_profile_client.mot	GATT client project mot file for RSSK RX23W
ble_demo_rsskrx23w_profile_server.mot	GATT server project mot file for RSSK RX23W
ble_demo_rsskrx23w_uart_hci.mot	HCI mode project mot file for RSSK RX23W
ble_demo_tbrx23w_FreeRTOS_multi_services.mot	FreeRTOS GATT server project mot file for Target Board for RX23W
ble_demo_tbrx23w_profile_client.mot	GATT client project mot file for Target Board for RX23W
ble_demo_tbrx23w_profile_server.mot	GATT server project mot file for Target Board for RX23W
ble_demo_tbrx23w_uart_hci.mot	HCI mode project mot file for Target Board for RX23W
ble_demo_tbrx23wmodule_profile_client.mot	GATT client project mot file for Target Board for RX23W module
ble_demo_tbrx23wmodule_profile_server.mot	GATT server project mot file for Target Board for RX23W module
ble_demo_tbrx23wmodule_uart_hci.mot	HCI mode project mot file for Target Board for RX23W module
FITModules\	FIT module folder
r_ble_rx23w_vX.XX.xml	BLE FIT module xml file
r_ble_rx23w_vX.XX.zip	BLE FIT module body package
r_ble_rx23w_vX.XX_extend.mdf	BLE FIT module mdf file
utilities\	Utility folder
BDAddrWriter.zip	Public BD address writing tool for HCI mode
CLVALTune.zip	Operation tool for calibration for HCI mode
r01an4860ejXXXX-rx23w-ble.pdf	BLE FIT Module Application Note (English)
r01an4860jjXXXX-rx23w-ble.pdf	BLE FIT Module Application Note (Japanese)
r_ble_api_spec.chm	R_BLE API document (English)

2.2 Project Configuration

A Bluetooth LE Application template project consists of Smart Configurator generation codes extracted from the BLE FIT module, the BLE QE Utility module and the QE for BLE and other FIT modules. Table 2.2 shows the project configuration.

Table 2.2. Bluetooth LE Application template project configuration

[project name]\	Project directory
_qe_gen\	
_ble\	A set of source codes generated by QE for BLE
_app_main.c	Framework for user application and profile
_gatt_db.c	GATT database
_gatt_db.h	
_r_ble_[profile name].s.c	Profile API
_r_ble_[profile name].s.h	
_r_ble_[profile name].c.c	
_r_ble_[profile name].c.h	
_src\	
_smc_gen\	A set of source codes generated by Smart Configurator
_r_ble_rx23w\	BLE FIT module
_lib\	Bluetooth LE Protocol Stack library
_src\	
_app_lib\	Bluetooth LE application auxiliary features
_abs\	Abstraction API
_board\	LED and Switch Control
_cli\	Command line (Input/Output to terminal software)
_cmd\	Command line (Command implementation)
_discovery\	Profile Common (discovery)
_logger\	Logger
_profile_cmn\	Profile Common
_rtos\	BLE Tack Control
_sec_data\	Security Data Management
_timer\	Software Timer
_platform\	Platform dependent codes
_driver\	Data Flash driver for the BLE FIT module
_r_ble_pf_config_private.h	BLE configuration control
_r_ble_pf_configs.c	
_r_ble_pf_functions.c	RF driver platform dependent
_r_ble_pf_lowpower.c	MCU low power consumption program
_r_ble_rx23w_if.h	BLE interface definition file
_FIT modules other than the BLE FIT module	
_project.c	Application template

Note: The BLE FIT v2.50 or later doesn't include Profile Common (profile_cmn, discovery). Profile Common is generated in qe_gen\ble by QE for BLE (V1.6.0 or later).

2.3 Build Environment

Table 2.3 shows the hardware requirements for building and debugging a Bluetooth LE Application.

Table 2.3. Hardware requirements

Hardware	Description
Host PC	Windows 10 PC with USB interface.
RX23W Board	Target Board for RX23W [RTK5RX23W0C00000BJ] Target Board for RX23W module [RTK5RX23W0C01000BJ] RSSK RX23W [RTK5523W8AC00001BJ]
On-chip debugging emulators	E2 emulator Lite [RTE0T0002LKCE00000R] or E1 emulator [R0E000010KCE00] When using the RSSK, either emulator is required. The Target Board has an on-board debugger equivalent to the E2 emulator Lite, so there is no need to prepare an emulator.
USB cables	Used to connect to the emulator and RX23W board. E2 or E1 emulator: 1 USB A-miniB cable Target Board: 2 USB A-microB cable RSSK: 1 USB A-microB cable

Table 2.4 shows the software requirements for building and debugging a Bluetooth LE Application.

Table 2.4. Software requirements

	Software	Version	Description
CC-RX environment	e ² studio	2024-01.1 (64bit) or later	Integrated development environment (IDE) for Renesas devices.
	CC-RX compiler	v2.08.00	C/C++ Compiler for RX Family.
	Renesas Flash Programmer	v3.06.00 or later	Tool for programming the on-chip flash memory of Renesas microcontrollers.
IAR environment	IAR Embedded Workbench for Renesas RX	v4.20.1	Integrated development environment (IDE) for Renesas devices made by IAR Systems. Note: Supported by BLE FIT module v1.10 or later.

2.4 Install

2.4.1 BLE FIT Module

This module must be added to each project in which it is used. Renesas recommends the method using the Smart Configurator described in (1) or (3) or (5) below. However, the Smart Configurator only supports some RX devices. Please use the methods of (2) or (4) for RX devices that are not supported by the Smart Configurator.

- (1) Adding the FIT module to your project using the Smart Configurator in e² studio
By using the Smart Configurator in e² studio, the FIT module is automatically added to your project. Refer to “RX Smart Configurator User’s Guide: e² studio (R20AN0451)” for details.
- (2) Adding the FIT module to your project using the FIT Configurator in e² studio
By using the FIT Configurator in e² studio, the FIT module is automatically added to your project. Refer to “RX Family Adding Firmware Integration Technology Modules to Projects (R01AN1723)” for details.
- (3) Adding the FIT module to your project using the Smart Configurator in CS+
By using the Smart Configurator Standalone version in CS+, the FIT module is automatically added to your project. Refer to “RX Smart Configurator User’s Guide: CS+ (R20AN0470)” for details.
- (4) Adding the FIT module to your project in CS+
In CS+, please manually add the FIT module to your project. Refer to “RX Family Adding Firmware Integration Technology Modules to CS+ Projects (R01AN1826)” for details.
- (5) Adding the FIT module to your project using the Smart Configurator in IAREW
By using the Smart Configurator Standalone version, the FIT module is automatically added to your project. Refer to “RX Smart Configurator User’s Guide: IAREW (R20AN0535)” for details.

2.4.2 Demo projects

2.4.2.1 e² studio Project

Import the demo project zip file under the FITDemos folder to the lowest possible hierarchy. (e.g., C:\RenesasBLE) If the folder hierarchy is deep, intermediate files cannot be output when building with e² studio, and the build may fail.

Also, select a location that does not contain blank character, multi-byte characters, and ampersand character "&" in the decompression destination path.

Refer to "BLE Module Firmware Integration Technology Application Note (R01AN4860)" for details on importing the demo project zip file to the e² studio workspace.

Note: If the demo project import location is not appropriate, the e² studio build may fail.

2.4.2.2 IAR Embedded Workbench for Renesas RX Project

Unzip the demo project zip file under the "FITDemos" folder and double-click the eww file. Build the project by [Project]→[Rebuild All] on IAR Embedded Workbench for Renesas RX. After successful build, download the firmware to the board by selecting [Project]→[Download and Debug].

3. Software Structure

Figure 3.1 shows the Bluetooth LE Application software structure.

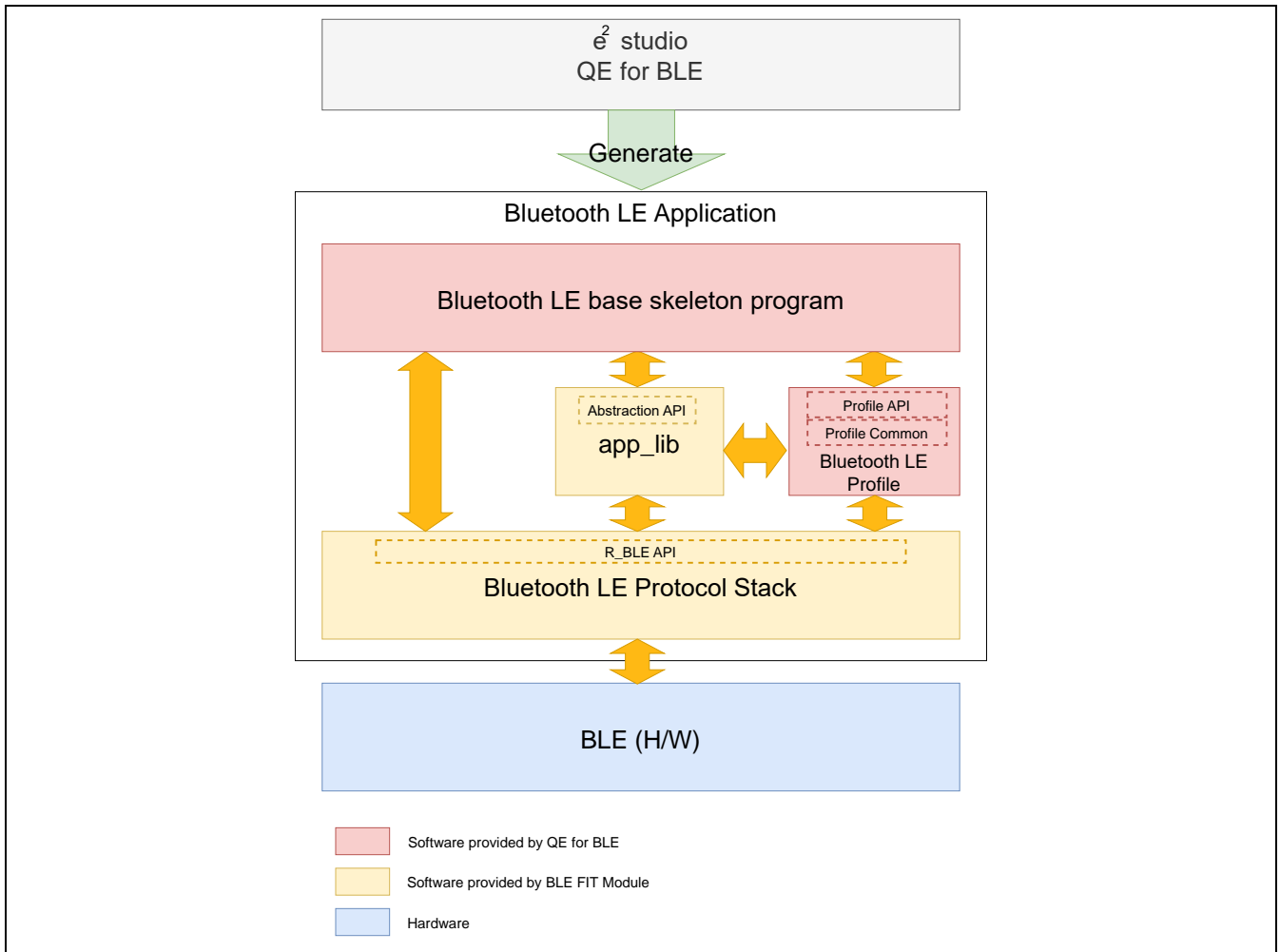

Figure 3.1. Bluetooth LE Application software structure

The Bluetooth LE Application consists of Bluetooth LE Protocol Stack and app_lib provided by the BLE FIT module and skeleton programs and Bluetooth LE Profiles generated by QE for BLE.

By calling the R_BLE API function provided by the Bluetooth LE Protocol Stack, the Bluetooth LE Application can use the Bluetooth LE function.

The app_lib provides auxiliary features that can be used by the Bluetooth LE Application. The Bluetooth LE communication can be easily used by using “Abstraction API” that abstracts R_BLE API included in app_lib.

QE for BLE, a solution toolkit that runs on e² studio, generates skeleton programs for application and profile development using Bluetooth LE Protocol Stack and Abstraction API.

Renesas recommends Bluetooth LE application development using QE for BLE.

For details about how to design a profile with QE for BLE, see “Bluetooth Low Energy Profile Developer's Guide (R01AN6459)”. For details about how to develop Bluetooth LE Application, see “RX23W Group Bluetooth Low Energy Application Developer's Guide (R01AN5504)”.

3.1 Bluetooth LE Protocol Stack

3.1.1 Bluetooth LE Protocol Stack structure

Figure 3.2 shows the Bluetooth LE Protocol Stack structure.

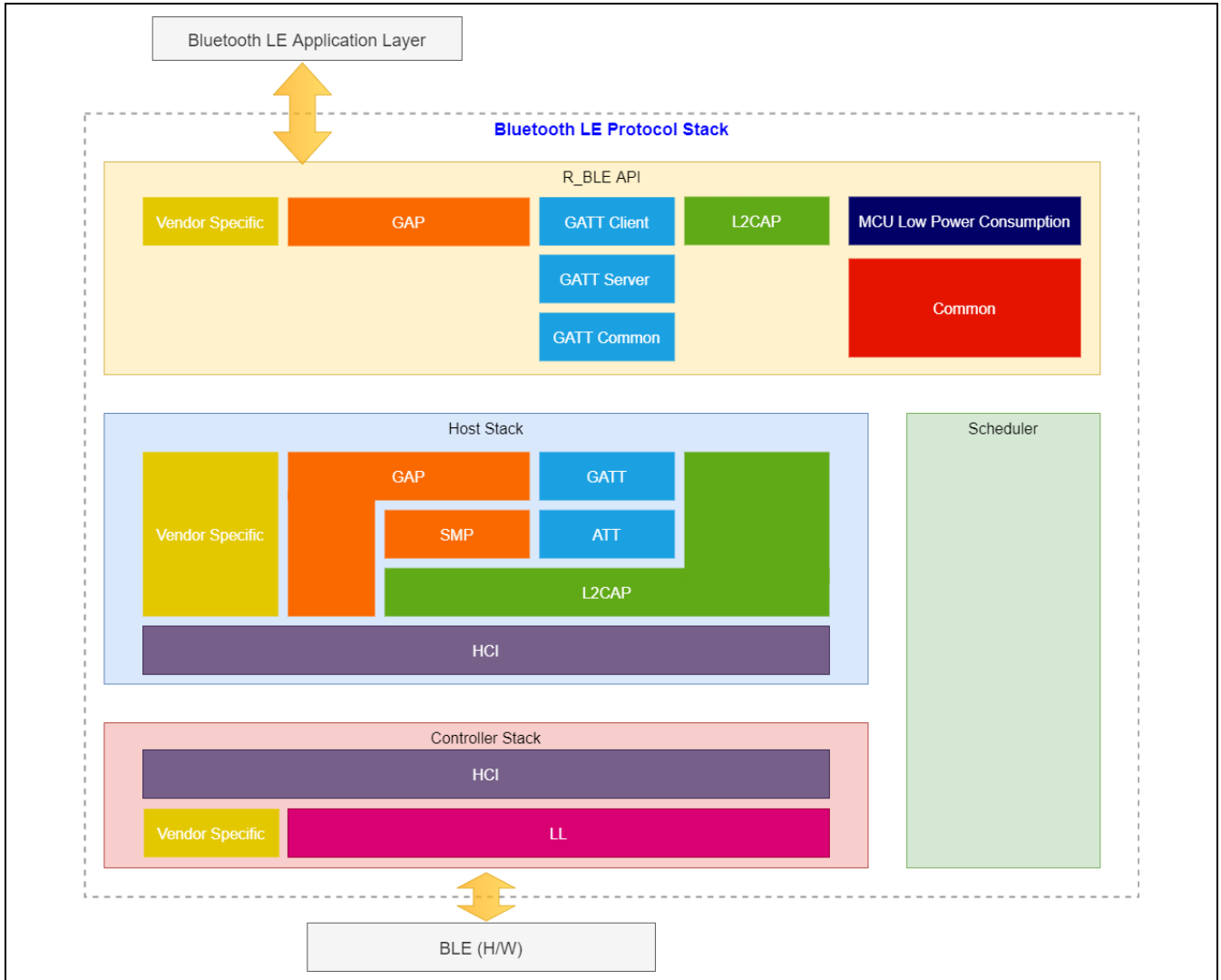

Figure 3.2. Bluetooth LE Protocol Stack structure

Bluetooth LE Protocol Stack consists of R_BLE API, Host Stack, Link Layer, and Scheduler.

- R_BLE API

The R_BLE API provides the APIs shown in Table 3.1 to provide Bluetooth LE functions for Bluetooth LE applications. Refer to “R_BLE API document (r_ble_api_spec.chm)” for detailed specifications of each API.

Table 3.1. R_BLE API overview

R_BLE_API	Protocol/Profile	Description
Common API	—	API for control BLE Open / Close and scheduler processing. <u>Main features</u> <ul style="list-style-type: none"> • Open/Close the Bluetooth LE Protocol Stack. • Execute the BLE task. • Add an event in the Bluetooth LE Protocol Stack internal queue.
GAP API	GAP SMP	API for supports procedures defined in GAP and SMP. <u>Main features</u> <ul style="list-style-type: none"> • GAP Advertising, Scan, Connection, Security • SMP Pairing
GATT Server API	ATT GATT	API for GATT Server that publishes service-related attributes and data sets (GATT Database). <u>Main features</u> <ul style="list-style-type: none"> • Access to GATT Database • Notification / Indication
GATT Client API	ATT GATT	API for GATT Client that makes requests to GATT Server. <u>Main features</u> <ul style="list-style-type: none"> • Service/Characteristic Discovery • Characteristic Read/Write
GATT Common API	ATT GATT	API for functions used in common with GATT Server/Client.
L2CAP API	L2CAP	API for data transfer on channels that perform credit-based flow control.
Vendor Specific API	—	API that provides Renesas original extended features. <u>Main features</u> <ul style="list-style-type: none"> • Enhanced Direct Test Mode • Set/Get BD Address
MCU Low Power Consumption API	—	API for reducing MCU power consumption.

The supported API differs depending on the type of Bluetooth LE Protocol Stack. See Table 3.4 for the APIs supported by each library.

- Host Stack

Host Stack provides the protocol and profile functions specified by Bluetooth SIG. The data received from the R_BLE API is sent to the Link Layer according to the procedures specified in each protocol and profile, and the data received from the Link Layer is notified as an R_BLE API event or data.

- Link Layer

The Link Layer controls the BLE hardware implemented in the MCU and provides Bluetooth LE functions such as Advertising, Scan, Connection, and Data Communication to the Host Stack via HCI (Host Controller Interface). Bluetooth LE commands and transmission data are sent from Host Stack to Link Layer. Bluetooth LE command results and data received from remote devices are sent from Link Layer to Host Stack.

- Scheduler

Scheduler processes the task according to the message queue sent to the task of each layer of Bluetooth LE Protocol Stack by *R_BLE_Execute()* of Common API. Figure 3.3 shows the basic sequence chart of Bluetooth LE Protocol Stack.

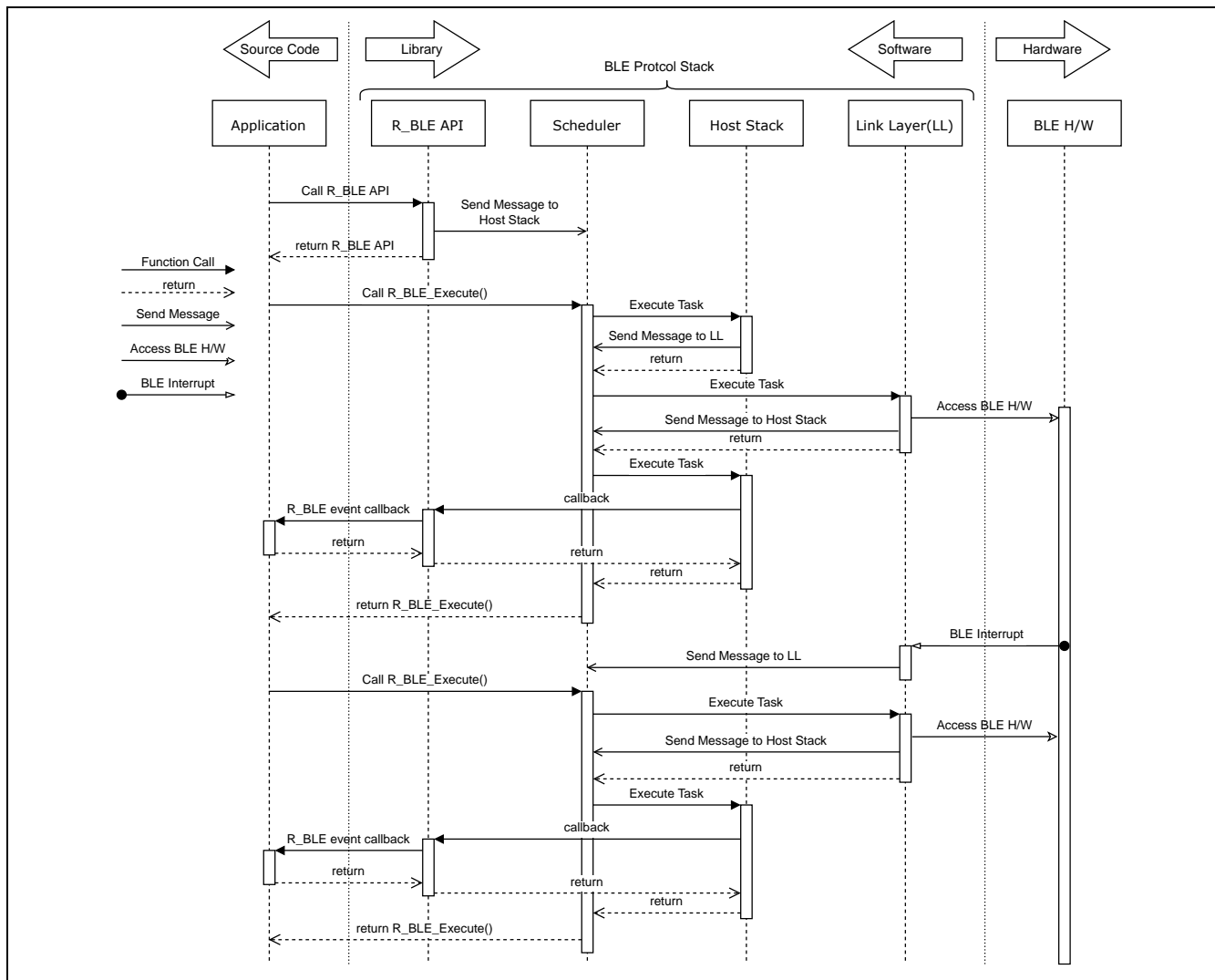

Figure 3.3. Basic sequence chart of Bluetooth LE Protocol Stack

3.1.2 Bluetooth LE Protocol Stack library

The BLE FIT module provides the following three types of Bluetooth LE Protocol Stack as a static library according to the supported Bluetooth LE features. By selecting the type according to the feature used in the Bluetooth LE Application, it is possible to reduce the ROM/RAM code size of the program.

Refer to “BLE Module Firmware Integration Technology (R01AN4860) 2.10 Code Size” for the code size of each type.

Table 3.2. Bluetooth LE Protocol Stack library

Library Type	Library File Name	Description
All features	lib_ble_ps_ccrx_a.lib	All features supported by Bluetooth LE Protocol Stack can be used.
Balance	lib_ble_ps_ccrx_b.lib	LE Advertising Extensions with large ROM/RAM size usage is disabled. However, LE 2M PHY and LE Coded PHY can be changed after connection.
Compact	lib_ble_ps_ccrx_c.lib	Dedicated to Bluetooth LE Peripheral operation, it can be used in applications that do not require Central operation, such as sensor devices.

Table 3.3 shows the Bluetooth LE features supported by each type of Bluetooth LE Protocol Stack.

Table 3.3. Features supported by each type of Bluetooth LE Protocol Stack

Bluetooth LE Features	Library Type		
	All features	Balance	Compact
LE 2M PHY	Yes	Yes	No
LE Coded PHY	Yes	Yes	No
LE Advertising Extensions	Yes	No	No
LE Channel Selection Algorithm #2	Yes	Yes	No
High Duty Cycle Non-Connectable Advertising	Yes	Yes	Yes
LE Secure Connections	Yes	Yes	Yes
Link Layer privacy	Yes	Yes	Yes
Link Layer Extended Scanner Filter policies	Yes	Yes	No
LE Data Packet Length Extension	Yes	Yes	Yes
LE L2CAP Connection Oriented Channel Support	Yes	No	No
Low Duty Cycle Directed Advertising	Yes	Yes	Yes
LE Link Layer Topology	Yes	Yes	No
LE Ping	Yes	Yes	Yes
GAP Role	Central Peripheral Observer Broadcaster	Central Peripheral Observer Broadcaster	Peripheral Broadcaster
GATT Role	Sever Client	Sever Client	Sever Client
32-bit UUID Support in LE	Yes	Yes	Yes

- LE 2M PHY
Supports Bluetooth LE communication with 2Msym/s PHY.
- LE Coded PHY
Supports Bluetooth LE communication with Coded PHY.
Communication over a long range than 1M PHY and 2M PHY is possible.
- LE Advertising Extensions
An extension of Advertising. The features are as follows.
 - Up to 4 independent advertising can be executed simultaneously.
(Use the configuration option BLE_CFG_RF_ADV_SET_MAX to set the number of Advertising executed simultaneously.)
 - Expansion of Advertising Data / Scan Response Data size up to 1650 bytes.
(Set the maximum size (bytes) with the configuration option BLE_CFG_RF_ADV_DATA_MAX.)
 - Periodic Advertising is possible.
- LE Channel Selection Algorithm # 2
This feature selects a channel using the algorithm for selecting a hopping channel added in Version 5.0.
- High Duty Cycle Non-Connectable Advertising
This feature supports non-connectable advertising with a minimum interval of 20 msec.
- LE Secure Connections
Elliptic curve Diffie-Hellman key agreement method (ECDH) supports passive eavesdropping pairing.
- Link Layer privacy
This feature avoids tracking from other Bluetooth LE devices by changing the BD Address periodically.
- LE Data Packet Length Extension
This feature expands the Bluetooth LE data communication packet size.
It can be expanded to 251 bytes.
- LE L2CAP Connection Oriented Channel Support
This feature supports communication using the L2CAP credit-based flow control channel.
- Low Duty Cycle Directed Advertising
This feature supports low duty cycle advertising for reconnection with known devices.
- LE Link Layer Topology
This feature supports both Central and Peripheral roles and can operate as Central when connected to a remote device and as Peripheral when connected to another remote device.

- LE Ping
After connection encryption, this feature checks whether connection is maintained by a packet transmission request including MIC field.

- GAP Role
GAP Role supports the following.
 - Central: A device that sends a connection request to a peripheral device.
 - Peripheral: A device that accepts connection requests from Central and establishes a connection.
 - Observer: A device that scans Advertising.
 - Broadcaster: A device that sends Advertising.

- GATT Role
GATT Role supports the following.
 - Server: A device that prepares Characteristic provided by service in GATT Database and responds to requests from Client.
 - Client: A device that makes request for services provided by Server.

- 32-bit UUID Support in LE
Supports GATT 32-bit UUID.

Table 3.4 shows R_BLE API support for each Bluetooth LE Protocol Stack library.

Table 3.4. R_BLE API support for Bluetooth LE Protocol Stack library

R_BLE_API	Library Type		
	All features	Balance	Compact
Common API	Yes	Yes	Yes
GAP API	Yes	C.1	C.1
GATT Common API	Yes	Yes	Yes
GATT Server API	Yes	Yes	Yes
GATT Client API	Yes	Yes	Yes
L2CAP API	Yes	No	No
Vendor Specific API	Yes	Yes	Yes
MCU Low Power Consumption API	Yes	Yes	Yes

C.1: Support for each GAP API varies depending on the type of Bluetooth LE Protocol Stack library.
Refer to “R_BLE API document (r_ble_api_spec.chm)” for details.

The Bluetooth LE Protocol Stack type is determined by the BLE_CFG_LIB_TYPE definition value in the configuration file (r_ble_rx23w_config.h). Determine which type is used by BLE_CFG_LIB_TYPE at the time of build, rename lib_ble_ps_ccrx_x.lib (x: a or b or c) to lib_ble_ps_ccrx.lib and link.

3.2 app_lib

Figure 3.4 shows the app_lib structure. Details of each are explained in “5 Original Features”.

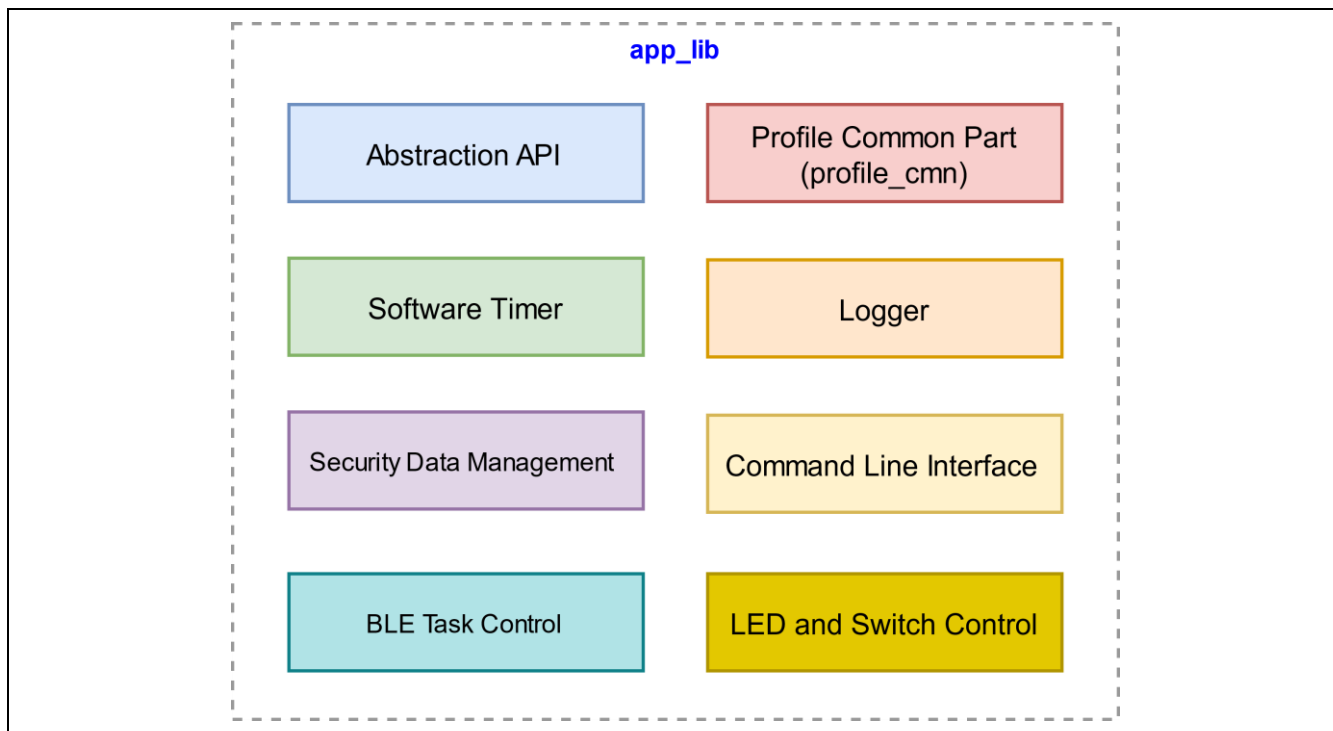

Figure 3.4. app_lib structure

Note: The BLE FIT v2.50 or later doesn't include Profile Common(profile_cmn, discovery). Profile Common is provided by QE for BLE (V1.6.0 or later).

The functions provided by app_lib, are described below.

3.2.1 Abstraction API

Abstraction API is an API that makes it easy to use frequently used functions in Bluetooth LE Protocol Stack. Refer to “R_BLE API document (r_ble_api_spec.chm)” for detailed specifications of Abstraction API. Do not change the Abstraction API codes.

3.2.2 Software Timer

The software timer uses Compare Match Timer (CMT). When using this function, add CMT FIT module to the application. The CMT channel to be used is dynamically allocated by FIT. Refer to “RX23W Group Bluetooth Low Energy Application Developer’s Guide (R01AN5504) 4.1 Software Timer” for details.

3.2.3 Security Data Management

Provides an interface for automatically saving bonding information to Data Flash when pairing is successful. When using this feature, set BLE_CFG_EN_SEC_DATA to “1” from the BLE FIT module component settings. About the use of security data management, see “RX23W Group Bluetooth Low Energy Application Developer’s Guide (R01AN5504) 4.4 Security Data Management”. About data configuration of security data management, see “5.2 Security Data Management ”.

3.2.4 Profile Common

The Profile Common is common functions to Bluetooth LE Profiles. It is called from the profile source code generated by QE for BLE. The BLE FIT v2.50 or later doesn't include Profile common. Profile common is provided by QE for BLE (V1.6.0).

3.2.5 Logger

Outputs a log message. The output level is set by the configuration option BLE_CFG_LOG_LEVEL. Refer to "RX23W Group Bluetooth Low Energy Application Developer's Guide (R01AN5504) 4.3 Logger" for details.

3.2.6 Command line

The command line feature uses the Bluetooth LE functions via a command input from serial. It uses Serial Communication Interface (SCI). Command types are standard commands provided by the BLE FIT module and user commands created by user. For details of standard commands and user commands, see the documents in Table 3.5.

Table 3.5. Command line reference documents

Command		Reference
Standard	Specification	"5.1 Command Line Interface"
	Usage	"RX23W Group Bluetooth Low Energy Application Developer's Guide (R01AN5504) 4.2.1 How to use the standard command"
User	Creation Method	"RX23W Group Bluetooth Low Energy Application Developer's Guide (R01AN5504) 4.2.2 How to create a user command"

3.2.7 LED and Switch Control

The LED and Switch Control feature controls LEDs and switches on board. About setting the BLE FIT and the IRQ FIT configuration options to use this feature, see "RX23W Group BLE Module Firmware Integration Technology (R01AN4860) 4.5.4 LED and Switch Control". About how to use this feature, see "RX23W Group Bluetooth Low Energy Application Developer's Guide (R01AN5504) 4.5 Board and LED switch".

3.2.8 BLE Task Control

The BLE Task Control feature is enabled if a project including the BLE FIT module has "FreeRTOS" as RTOS. Another task wakes the BLE task up by this feature. About how to use it, see "RX23W Group BLE Module Firmware Integration Technology (R01AN4860) 6.4 Wake up BLE task from another task".

4. Software Setting

User can configure the Bluetooth LE Application according to the purpose with the BLE FIT module.

4.1 Configuration options

Table 4.1 shows configuration options of the BLE FIT module. Configuration option settings are determined by the macro definition in `r_ble_rx23w_config.h`. When using Smart Configurator, configuration options can be set on the software component setting screen. The setting value is automatically reflected in `r_ble_rx23w_config.h` when adding a module.

Table 4.1. List of configuration options (1/8)

Configuration Options	Description
BLE_CFG_LIB_TYPE Default: "0"	Type of the Bluetooth LE Protocol Stack. Select one of the followings. 0: All features 1: Balance 2: Compact Refer to "3.1.2 Bluetooth LE Protocol Stack library" for details.
BLE_CFG_RF_DBG_PUB_ADDR Default: "{0xFF,0xFF,0xFF,0x50,0x90,0x74}"	Initial Public Address. If the public addresses in the Code Flash and the Data Flash are all 0x00 or 0xFF, the device adopts this public address. If all 0x00 or 0xFF is set, the device uses '74:90:50:FF:FF:FF' as public address.
BLE_CFG_RF_DBG_RAND_ADDR Default: "{0xFF,0xFF,0xFF,0xFF,0xFF,0xFF}"	Initial Static Address. If the static addresses in the Code Flash and the Data Flash are all 0x00 or 0xFF, the device adopts this static address. If all 0x00 or 0xFF is set, the device uses the value generated with the device specific value the static address.
BLE_CFG_RF_CONN_MAX Default: "7"	Maximum entry number of the remote device connection information management table. Specifically, it is either larger one of the maximum simultaneous connection number and the maximum stored bonding information number. The heap memory size used by the Bluetooth LE Protocol Stack increases and decreases due to this value. Range: 1 to 7
BLE_CFG_RF_CONN_DATA_MAX Default: "251"	Maximum packet data length (bytes). Range: 27 to 251
BLE_CFG_RF_ADV_DATA_MAX Default: "1650"	Maximum advertising data length (bytes). Range: 31 to 1650 The maximum advertising data length of the Bluetooth LE Protocol Stack libraries other than "All features" is fixed to 31bytes.
BLE_CFG_RF_ADV_SET_MAX Default: "4"	Maximum number of the advertising set. Range: 1 to 4 The number of the advertising set of the Bluetooth LE Protocol Stack libraries other than "All features" is fixed to one.
BLE_CFG_RF_SYNC_SET_MAX Default: "2"	Maximum number of periodic sync set. Range: 1 to 2 If the Bluetooth LE Protocol Stack library is other than "All features", this option is not used.

Table 4.1. List of configuration options (2/8)

Configuration Options	Description
BLE_CFG_EVENT_NOTIFY_CONN_START Default: "0"	<p>Enable or disable start interrupt notification of a connection complete event.</p> <p>0: Disable 1: Enable</p> <p>Because the start notification is triggered by the interrupt, it occurs after the actual RF event.</p>
BLE_CFG_EVENT_NOTIFY_CONN_CLOSE Default: "0"	<p>Enable or disable end interrupt notification of a connection complete event.</p> <p>0: Disable 1: Enable</p> <p>If the connection is terminated by a command, the notification doesn't occur.</p>
BLE_CFG_EVENT_NOTIFY_ADV_START Default: "0"	<p>Enable or disable the advertising event start interrupt notification.</p> <p>0: Disable 1: Enable</p> <p>The notification occurs at the following timings.</p> <ul style="list-style-type: none"> • Start Primary Advertising channel. • Start Secondary Advertising Channel • Start Periodic Advertising. (When the Extended Advertising is enabled.) <p>Because the start notification is triggered by the interrupt, it occurs after the actual RF event.</p>
BLE_CFG_EVENT_NOTIFY_ADV_CLOSE Default: "0"	<p>Enable or disable the advertising event complete interrupt notification.</p> <p>0: Disable 1: Enable</p> <p>The notification occurs at the following timings.</p> <ul style="list-style-type: none"> • Complete Primary Advertising channel. • Complete Secondary Advertising Channel • Complete Periodic Advertising. (When the Extended Advertising is enabled.) <p>If the advertising is terminated by a command, the notification doesn't occur.</p>

Table 4.1. List of configuration options (3/8)

Configuration Options	Description
BLE_CFG_EVENT_NOTIFY_SCAN_START Default: "0"	<p>Enable or disable the scan start interrupt notification.</p> <p>0: Disable 1: Enable</p> <p>If the scan interval is equal to the scan window, this notification doesn't occur.</p> <p>Because the start notification is triggered by the interrupt, it occurs after the actual RF event.</p>
BLE_CFG_EVENT_NOTIFY_SCAN_CLOSE Default: "0"	<p>Enable or disable the scan complete interrupt notification</p> <p>0: Disable 1: Enable</p> <p>If the scan interval is equal to the scan window, this notification doesn't occur.</p> <p>If the scan is terminated by a command, the notification doesn't occur.</p>
BLE_CFG_EVENT_NOTIFY_INIT_START Default: "0"	<p>Enable or disable the notification that the scan start interrupt has occurred in sending a connection request.</p> <p>0: Disable 1: Enable</p> <p>If the scan interval is equal to the scan window, this notification doesn't occur.</p> <p>Because the start notification is triggered by the interrupt, it occurs after the actual RF event.</p>
BLE_CFG_EVENT_NOTIFY_INIT_CLOSE Default: "0"	<p>Enable or disable the notification that the scan complete interrupt has occurred in sending a connection request.</p> <p>0: Disable 1: Enable</p> <p>If the scan interval is equal to the scan window, this notification doesn't occur.</p> <p>If the connection request is terminated by a command, the notification doesn't occur.</p>
BLE_CFG_EVENT_NOTIFY_DS_START Default: "0"	<p>Enable or disable the RF_DEEP_SLEEP start notification.</p> <p>0: Disable 1: Enable</p>
BLE_CFG_EVENT_NOTIFY_DS_WAKEUP Default: "0"	<p>Enable or disable the RF_DEEP_SLEEP wakeup notification.</p> <p>0: Disable 1: Enable</p>

Table 4.1. List of configuration options (4/8)

Configuration Options	Description
BLE_CFG_RF_CLVAL Default: "6"	Adjustment value of the 32MHz crystal oscillator for RF part. Set this option according to the board environment. Range: 0 to 15 Refer to "RX23W Group Tuning procedure of Bluetooth dedicated clock frequency(R01AN4762)" for details. If you select R5F523W8CxLN or R5F523W8DxLN, set "7".
BLE_CFG_RF_DDC_EN Default: "0"	Enable or disable the DC-DC on the RF. 0: Disable 1: Enable If you use Target Board, set "0".
BLE_CFG_RF_EXT32K_EN Default: "0"	Slow clock source to the RF. 0: RF_LOCO 1: External 32.768kHz If this option is set to 1, the sub clock is required to be enabled in the Smart Configurator clock configuration.
BLE_CFG_RF_MCU_CLKOUT_PORT Default: "0"	Port of the MCU CLKOUT. 0: PE3 1: PE4 If BLE_CFG_RF_EXT32K_EN option is 0, this option is ignored.
BLE_CFG_RF_MCU_CLKOUT_FREQ Default: "0"	Output frequency from the MCU CLKOUT. 0: MCU CLKOUT frequency 32.768kHz 1: MCU CLKOUT frequency 16.384kHz If BLE_CFG_RF_EXT32K_EN option is 0, this option is ignored.
BLE_CFG_RF_SCA Default: "250"	Sleep Clock Accuracy (SCA) for the RF slow clock. Range: 0 to 500 If BLE_CFG_RF_EXT32K_EN option is 0, the SCA is fixed to more than 250 [ppm] and this option is ignored.
BLE_CFG_RF_MAX_TX_POW Default: "1"	Maximum transmit power configuration. 0: max +0dBm 1: max +4dBm

Table 4.1. List of configuration options (5/8)

Configuration Options	Description
BLE_CFG_RF_DEF_TX_POW Default: "0"	<p>Default transmit power level. Range: 0 to 2 This option depends on BLE_CFG_RF_MAX_TX_POW option.</p> <p>If the BLE_CFG_RF_MAX_TX_POW option is 0 (0dBm), BLE_CFG_RF_DEF_TX_POW is as follows.</p> <p>0 (High) : 0 dBm 1 (Mid) : 0 dBm 2 (Low) : -18 dBm</p> <p>If the BLE_CFG_RF_MAX_TX_POW option is 1 (+4dBm), BLE_CFG_RF_DEF_TX_POW is as follows.</p> <p>0 (High) : +4 dBm 1 (Mid) : 0 dBm 2 (Low) : -20 dBm</p>
BLE_CFG_RF_CLKOUT_EN Default: "0"	<p>CLKOUT_RF output. Select one of the followings.</p> <p>0: No output 5: 4MHz output 6: 2MHz output 7: 1MHz output</p>
BLE_CFG_RF_DEEP_SLEEP_EN Default: "1"	<p>Enable or disable the RF Deep Sleep.</p> <p>0: Disable 1: Enable</p>
BLE_CFG_MCU_MAIN_CLK_KHZ Default: "4000"	<p>MCU main clock frequency (kHz). This option needs to be configured according to the board environment. If the HOCO is used, this option is ignored. If the Main Clock is used, set a value within the range between 1000 and 20000. If the PLL Circuit is used, set a value within the range between 4000 and 12500. Set the clock frequency configured in the Smart Configurator clock configuration.</p>
BLE_CFG_DEV_DATA_CF_BLOCK Default: "16"	<p>The Code Flash (ROM) block stored the device specific data. Range: -1 to 255</p> <p>If this option is set to "-1", the device specific data in the Code Flash is not used.</p> <p>The blocks from "0" to "15" are the Start-Up Program Protection block. If the Start-Up Program Protection is used, don't use the blocks from "0" to "15".</p>

Table 4.1. List of configuration options (6/8)

Configuration Options	Description
BLE_CFG_DEV_DATA_DF_BLOCK Default: "-1"	The E2 Data Flash block stored the device specific data. Range: -1 to 7 If this option is set to "-1", the device specific data in the E2 DataFlash is not used. Specify a block number different from the block number specified by BLE_CFG_SECD_DATA_DF_BLOCK.
BLE_CFG_GATT_MTU_SIZE Default: "247"	The MTU size (bytes) for the GATT communication. Range: 23 to 247
BLE_CFG_NUM_BOND Default: "7"	Maximum number of the bonding information stored in the Data Flash by the security data management. Range: 1 to 7. If you change this value for debug and so on after code generation and build, repairing may fail because bonding information managed by the security data management function before the change remains in the Data Flash area. To avoid this, delete the previous bonding information by R_BLE_GAP_DeleteBondInfo() or "gap auth del remote all" command.
BLE_CFG_EN_SEC_DATA Default: "0"	Enable or disable the security data management. The bonding information is stored in the Data Flash block specified by BLE_CFG_SECD_DATA_DF_BLOCK by this option. 0: Disable 1: Enable If this option is enabled, add the Data Flash FIT module.
BLE_CFG_SECD_DATA_DF_BLOCK Default: "0"	The Data Flash block for the security data management to store the bonding information. Range: 0 to 7 Specify a block number different from the block number specified by BLE_CFG_DEV_DATA_DF_BLOCK.
BLE_CFG_CMD_LINE_EN Default: "0"	Enable or disable the command line function. 0: Disable 1: Enable If this option is enabled, add the SCI FIT module.

Table 4.1. List of configuration options (7/8)

Configuration Options	Description
BLE_CFG_CMD_LINE_CH Default: "1"	<p>SCI Channel for the command line function.</p> <p>Set one of the following values:</p> <ul style="list-style-type: none"> 1: SCI1 5: SCI5 8: SCI8 12: SCI12 (BGA 85pin only) <p>Enable the SCI channel for the command line in the SCI FIT module configuration.</p> <p>If the BLE_CFG_CMD_LINE_EN is 0, this option is ignored. The SCI used in the HCI mode must be set in "6.3.1 Configuration Options of UART Driver" instead of this macro.</p>
BLE_CFG_BOARD_LED_SW_EN Default: "0"	<p>Enable or disable support the board LED & Switch control.</p> <ul style="list-style-type: none"> 0: Disable 1: Enable <p>If the option is enabled, add the IRQ FIT module and the GPIO FIT module.</p>
BLE_CFG_BOARD_TYPE Default: "0"	<p>Board type.</p> <p>Range: 0 to 3</p> <ul style="list-style-type: none"> 0: Customer board 1: Target Board 2: RSSK 3: Evaluation board
BLE_CFG_LOG_LEVEL Default: "3"	<p>Log level.</p> <p>Range: 0 to 3</p> <ul style="list-style-type: none"> 0: disable 1: Error 2: Error & Warning 3: Error & Warning & Debug

Table 4.1. List of configuration options (8/8)

Configuration Options	Description
BLE_CFG_ABS_API_EN Default: "1"	Set enable/disable of the Abstraction API. 0: Disable 1: Enable
BLE_CFG_SOFT_TIMER_EN Default: "1"	Set enable/disable of the software timer provided by app_lib. 0: Disable 1: Enable To use the Abstraction API, enable this option.
BLE_CFG_MCU_LPC_EN Default: "1"	Set enable/disable the low power consumption function of the MCU. 0: Disable 1: Enable
BLE_CFG_HCI_MODE_EN Default: "0"	Set startup in HCI mode. 0: Startup in normal mode 1: Startup in HCI mode

4.2 Sections

The Bluetooth LE Protocol Stack library provides a mechanism for Device Firmware Update (DFU) by Over The Air (OTA) using Bluetooth LE communication. In order to specify the section allocation of the Bluetooth LE Protocol Stack library, the section name different from the standard section name shown in Table 4.2 is added to the code of the Bluetooth LE Protocol Stack library ("BLE_" is added to the beginning of the standard section name) Specified name).

Table 4.2. Section name of Bluetooth LE Protocol Stack library

#	Name	Bluetooth LE Protocol Stack Section Name
1	Program area	BLE_P
2	Constant area	BLE_C
		BLE_C_2
		BLE_C_1
3	Initialized data area (ROM)	BLE_D
		BLE_D_2
		BLE_D_1
4	Initialized data area (RAM)	BLE_R
		BLE_R_2
		BLE_R_1
5	Uninitialized data area	BLE_B
		BLE_B_2
		BLE_B_1
6	switch statement branch table area	BLE_W
		BLE_W_2
		BLE_W_1
7	Literal area	BLE_L

The section name of the Bluetooth LE Protocol Stack library must be set as described in “4.2.1 Linker settings for application project”.

Since the BLE section is initialized by the *R_BLE_Open()* API that performs BLE initialization, there is no need to change the program code in the DTBL/BTBL table.

4.2.1 Linker settings for application project

Add the section name of the Bluetooth LE Protocol Stack library shown in Table 4.2 in the application section allocation settings. In CC-RX compiler, the wildcard character "*" can be specified for the section name.

The section layout of the e² studio project is set in [Section] of [Linker].

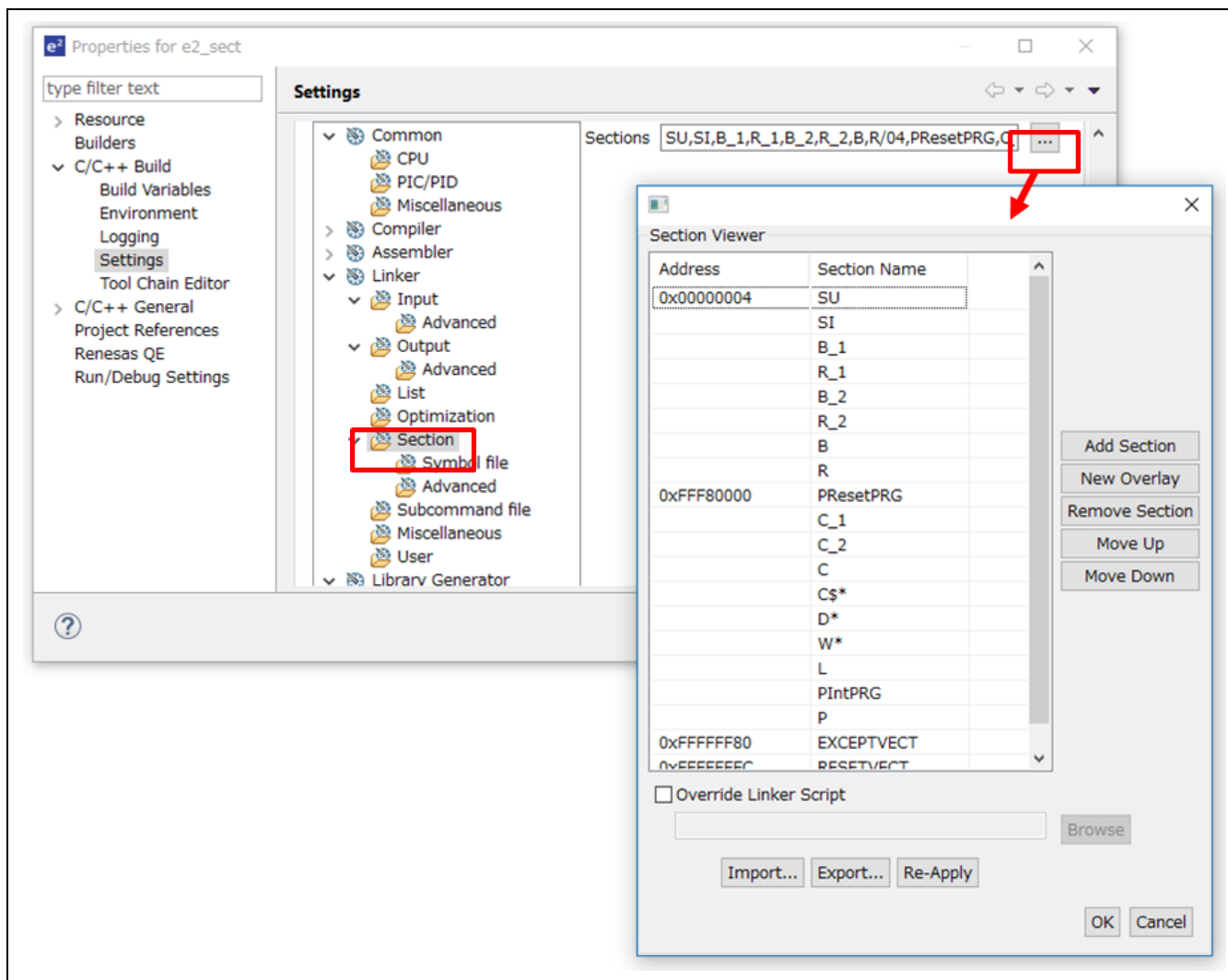

Figure 4.1. e² studio project section layout

Table 4.3 shows the section allocation settings when OTA is not used. Wildcards are used so that the section specification is not complicated.

Table 4.3. Section layout of Bluetooth LE library section (when OTA is not used)

Address	Section Name
0x00000004 (RAM)	SU
	SI
	B_1
	R_1
	B_2
	R_2
	B
	R
	BLE_B*
	BLE_R*
0xFFFF8000 (ROM)	PRResetPRG
	C_1
	C_2
	C
	C\$*
	D*
	W*
	L
	PIntPRG
	P
	BLE_C*
	BLE_D*
	BLE_W*
	BLE_L
BLE_P	
0xFFFFF80	EXCEPTVECT
0xFFFFFFF8	RESETVECT

Also, add the Bluetooth LE Protocol Stack library section in Table 4.2 to the section that mapped from ROM to RAM. This setting does not allow the use of wildcards. You only need to add sections that have assignments.

In e² studio, set [Linker] → [Section] → [Symbol file] → [ROM to RAM mapped section].

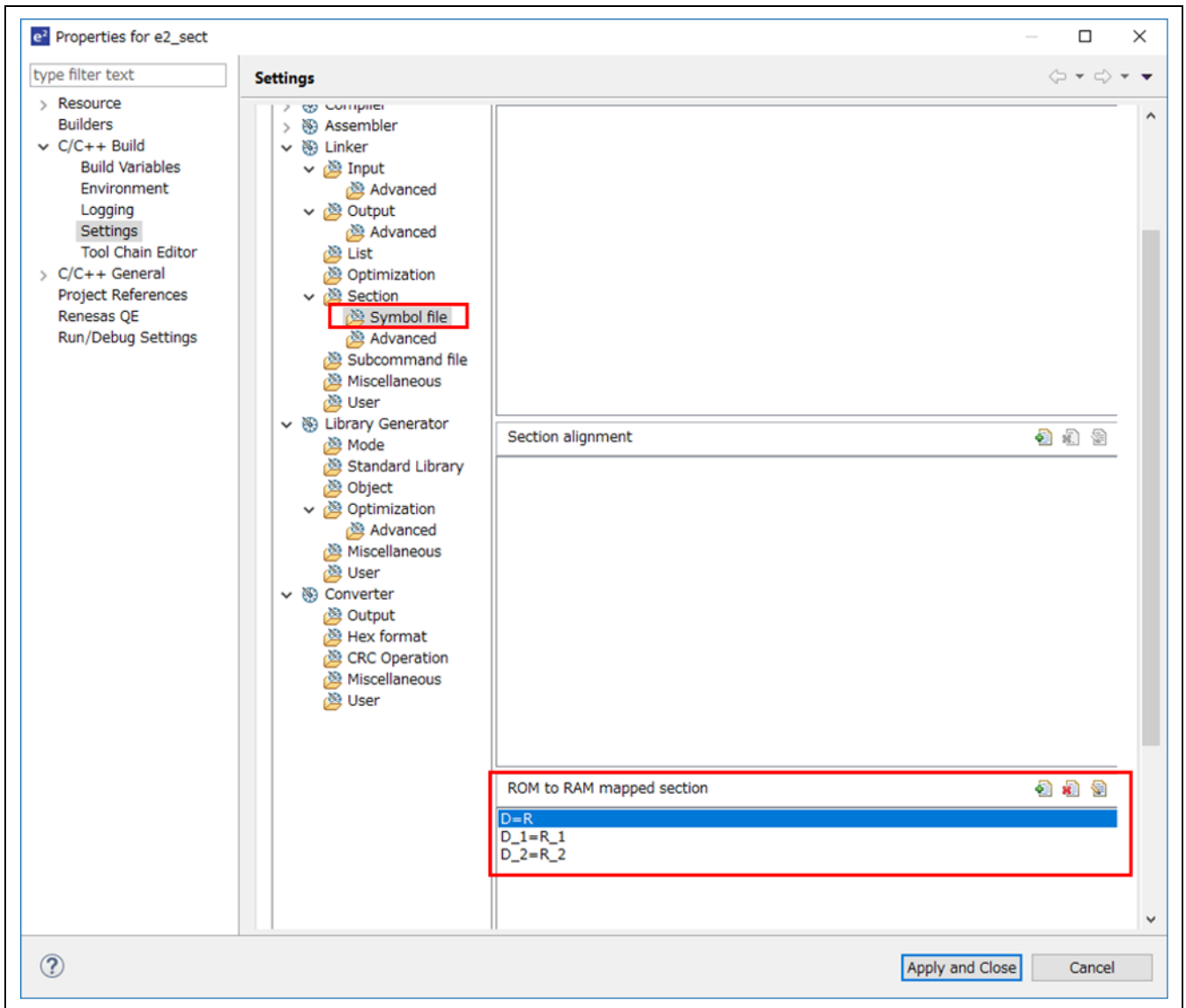

Figure 4.2. Setting “ROM to RAM mapped section” in e² studio project

Add the BLE_D/BLE_R section of the Bluetooth LE library as shown below.

```

D=R
D_1=R_1
D_2=R_2
BLE_D=BLE_R
BLE_D_1=BLE_R_1
BLE_D_2=BLE_R_2
    
```

Note: If there is no assignment to the corresponding section, a link error will occur. The “BLE_D_8” section is not used in the Bluetooth LE Protocol Stack library.

4.3 Bluetooth Device Address

Refer to "5.4 Device-specific Data Management" for Bluetooth Device Address used in Bluetooth LE Protocol Stack.

4.4 Bluetooth Device Name

The following settings are required for Bluetooth Device Name depending on the inform method.

4.4.1 Inform by Advertising packet

Using the API shown in Table 4.4, it is possible to start advertising including the Bluetooth Device Name in Advertising Data or Scan Response Data, and to inform Bluetooth Device Name to the Scanner device.

Table 4.4. API to set Advertising Data

R_BLE_API	Parameter structure	Member name for setting Advertising Data or Scan Response Data
<i>R_BLE_GAP_SetAdvSresData()</i>	st_ble_gap_adv_data_t	p_data
<i>R_BLE_ABS_StartLegacyAdv()</i>	st_ble_abs_legacy_adv_param_t	p_adv_data
		p_sres_data
<i>R_BLE_ABS_StartExtAdv()</i>	st_ble_abs_ext_adv_param_t	p_adv_data
<i>R_BLE_ABS_StartNonConnAdv()</i>	st_ble_abs_non_conn_adv_param_t	p_adv_data

Set the data in the format shown in Figure 4.3 to Advertising Data or Scan Response Data.

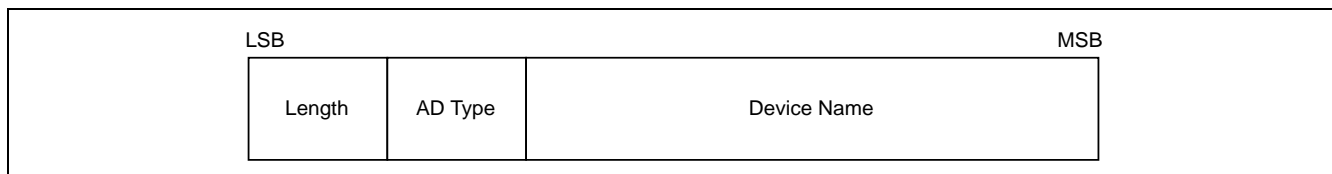

Figure 4.3. Bluetooth Device Name format in Advertising packet

Table 4.5 describes the fields in the Bluetooth device name format.

Table 4.5. Bluetooth Device Name field

Field	Description
Length	The total number of bytes for "Device Name" and "AD Type".
AD Type *1 (Advertising Data Type)	Indicates the type to be inform in the "Device Name" field. 0x08: «Shortened Local Name» 0x09: «Complete Local Name»
Device Name	Bluetooth Device Name string.

*1: For other AD types, refer to Bluetooth SIG, "Generic Access Profile" in "[Assigned numbers](#)".

Figure 4.4 shows an example of setting Bluetooth Device Name using `R_BLE_GAP_SetAdvSresData()` API.

```
/* Advertising Data */
static uint8_t gs_adv_data[] =
{
    /* Some code is omitted */
    /* Complete Local Name */
    11, /* Length */
    0x09, /* AD Type */
    'B', 'L', 'E', '-', 'S', 'E', 'R', 'V', 'E', 'R', /* Device Name */
    /* Some code is omitted */
};

/* Advertising Parameters */
static st_ble_gap_adv_data_t gs_adv_param =
{
    /* Some code is omitted */
    .p_data = gs_adv_data,
    /* Some code is omitted */
};

/* GAP callback function */
static void ble_app_gapcb(uint16_t type, ble_status_t result,
st_ble_evt_data_t *p_data)
{
    switch (type)
    {
        /* Some code is omitted */
        case BLE_GAP_EVENT_ADV_PARAM_SET_COMP :
        {
            R_BLE_GAP_SetAdvSresData (&gs_adv_param);
        } break;
        /* Some code is omitted */
    }
}
```

Figure 4.4. Setting example Bluetooth Device Name using `R_BLE_GAP_SetAdvSresData()`

4.4.2 Inform by Device Name Characteristic

By setting the Device Name Characteristic of GAP Service, it is possible to respond to the Bluetooth Device Name when receiving a Device Name Characteristic read request from GATT Client.

Device Name Characteristic can be set from QE for BLE. For details on QE for BLE settings, refer to “Bluetooth Low Energy Profile Developer’s Guide (R01AN6459) 3.2.3 Adding and configuration of characteristic”.

5. Original Features

This section describes Renesas original features provided by the BLE FIT module.

In addition to the features provided by “3.2 app_lib”, there are features provided by Bluetooth LE Protocol Stack. Table 5.1 shows the original features provided by the Bluetooth LE Protocol Stack.

Table 5.1.Original features provided by Bluetooth LE Protocol Stack

Features	Description
RF communication timing notification	The RF communication timing notification function notifies the user application layer of the timing before and after Bluetooth LE RF communication is performed with a callback. Refer to “5.3 RF communication timing notification” for details.
Device-specific Data Management	Bluetooth Device Address used by Bluetooth LE Protocol Stack can be written as device-specific data in the user area (ROM) or data area (E2 DataFlash) of flash memory. Refer to “5.4 Device-specific Data Management” for details.

5.1 Command Line Interface

Command Line Interface (CLI) provides a function to execute Bluetooth LE control commands through a terminal emulator that supports VT100 emulation. Terminal emulators that support VT100 emulation can be used with Tera Term application. The debug console provided by e² studio does not support VT100 emulation.

The features provided by Command Line Interface are shown in Table 5.2.

Table 5.2. Command Line Interface Features

Features	Description
Prompt display	"\$" is displayed as a prompt to indicate that the command can be executed.
Specifying the editing position with the left and right arrow keys	With the left and right arrow keys, you can specify the position to edit the characters in the command line.
Edit characters with backspace and delete keys	Use the BS and DEL keys to delete characters in the command line.
Command help	Enter "help" after a command and execute it, help message shown at each command.
Support hierarchical command system with subcommands	Provides a hierarchical command system.
Support multiple command sets	Multiple command sets can be registered.
Abort command execution	Press “Ctrl + C” or “Ctrl + D” keys to aborts the current command.
Command completion	Press TAB key to complete command input.

When using Command Line Interface features, set the BLE_CFG_CMD_LINE_EN configuration option to "1". Also, specify the SCI channel in the BLE_CFG_CMD_LINE_CH configuration option.

Set the following items in the terminal emulator of the computer connected to the board.

Table 5.3. Terminal emulator settings

Items	Settings
New-line (Receive)	LF
New-line (Transmit)	CR
Terminal Mode	VT100
Baud rate	115200
Data	8bit
Parity	none
Stop bits	1bit
Flow Control	none

Bluetooth LE control command provided by BLE FIT module using the command line interface features are shown in the following sections.

5.1.1 GAP command

(1) Advertising command

adv command	
Format:	gap adv [adv_type] [operation] (addr_type) (-wl) Start, stop, or remove advertising.
Parameters:	[adv_type] Select one of the followings as the type of advertising. legacy: legacy advertising ext: extended advertising non-conn: non-connectable advertising periodic: periodic advertising
	[operation] Start or stop advertising. start: start advertising stop: stop advertising. remove: remove advertising set specified by adv_type.
	(addr_type) Specify the address type of advertising. When this parameter is omitted, static address is selected. pub: Public Address rnd: Static Address rpa_pub: If registering an identity address by gap priv set command or application, RPA is used. In cases other than the above, it will be a public address. rpa_rnd: If registering an identity address by gap priv set command or application, RPA is used. In cases other than the above, it will be a static address.
	(-wl) Specify this parameter when using white list. If white list is not used, this parameter is can be omitted.
Example:	<p>gap adv legacy start Start legacy advertising. The local device address is a static address.</p> <p>gap adv legacy start pub Start legacy advertising. The local device address is a public address.</p> <p>gap adv ext stop Stop extended advertising.</p>

Other parameters related to Advertising that cannot be set from this command are set in the Advertising parameter variables of gs_legacy_adv_param, gs_ext_adv_param, gs_non_conn_adv_param, and gs_periodic_adv_param in app_lib\cmd\r_ble_cmd_abs.c. Changing these variables will change the setting of Advertising parameters. As for details of parameters, refer to Modules >> Application Library >> Abstraction API >> Structures >> st_ble_abs_legacy_adv_param_t, st_ble_abs_ext_adv_param_t, st_ble_abs_non_conn_adv_param_t, and st_ble_abs_perd_adv_param_t in API document (r_ble_api_spec.chm).

(2) Scan command

scan command	
Format:	gap scan (operation) (filter_ad_type) (filter_data) (addr_type) (-wl)
	Start scan. It is not necessary to specify (operation) when starting scan. When scan stops, input [ctrl] + [c].
Parameters:	(operation) Specify operation for scan stop: stop scan.
	(filter_ad_type) The AD type for filtering. Refer to Bluetooth SIG, "Generic Access Profile" in " Assigned numbers " for the definition of the AD type. If the filter is not used, this parameter can be omitted.
	(filter_data) The data for filtering. Specify the data for the filter_ad_type. If the filter is not used, this parameter can be omitted. If the filter_ad_type is not used, this parameter is ignored.
	(addr_type) Specify the address type of scan request. When this parameter is omitted, static address is selected. pub: Public Address rnd: Static Address rpa_pub: If registering an identity address by gap priv set command or application, RPA is used. In cases other than the above, it will be a public address. rpa_rnd: If registering an identity address by gap priv set command or application, RPA is used. In cases other than the above, it will be a static address.
	(-wl) Specify this parameter when using white list. If white list is not used, this parameter is can be omitted.
Example:	gap scan Start scan. gap scan 2 0x01,0x29 Search the advertising report which of the AD Type: Incomplete List of 16-bit Service Class UUIDs(0x02) and the service UUID: 0x2901.

Other parameters related to Scan that cannot be set from this command are set in the scan parameter variables of gs_phy_param_1m and gs_scan_param in app_lib\cmd\r_ble_cmd_abs.c. Changing these variables will change the scan parameter settings. As for details of parameters, refer to Modules >> Application Library >> Abstraction API >> Structures >> st_ble_abs_scan_param_t and st_ble_abs_scan_phy_param_t in API document (r_ble_api_spec.chm).

(3) Connection command

conn command	
Format:	gap conn [addr] [addr_type] (own_addr_type) (dummy_irk) (-wl) Send a connection request. In case of stopping connection request, input [ctrl] + [c].
Parameters:	[addr] Remote device address.
	[addr_type] Specify the followings as remote device address type. pub: Public Address rnd: Random Address
	(own_addr_type) Specify the address type of connection request. When this parameter is omitted, static address is selected. pub: Public Address rnd: Static Address rpa_pub: If registering an identity address by gap priv set command or application, RPA is used. In cases other than the above, it will be a public address. rpa_rnd: If registering an identity address by gap priv set command or application, RPA is used. In cases other than the above, it will be a static address.
	(dummy_irk) Select whether to use the IRK of the dummy of the remote device to be registered in the Resolving List when RPA is specified in own_addr_type. dummy_irk: use the IRK of the dummy of the remote device
	(-wl) Specify this parameter when using white list. If white list is not used, this parameter is can be omitted.
Example:	gap conn 74:90:50:00:95:a8 pub Send a connection request to the remote device whose public address is 74:90:50:00:95:a8. gap priv set net gap conn d8:19:e3:30:92:21 pub Send a connection request to the remote device whose random address is d8:19:e3:30:92:21. Local devices use RPA. The IRK for the remote device use dummy IRK. Note: If the local device uses RPA, it is necessary to execute the "gap priv" command in advance.

Other parameters related to Connection that cannot be set from this command are set in the connection parameter variables of gs_conn_phy_1m and gs_conn_param in app_lib\cmd\r_ble_cmd_abs.c. Changing these variables will change the connection parameter settings. As for details of parameters, refer to Modules >> Application Library >> Abstraction API >> Structures >> st_ble_abs_conn_phy_param_t and st_ble_abs_conn_param_t in API document (r_ble_api_spec.chm).

(4) Disconnection command

disconn command	
Format:	gap disconn [conn_hdl]
	Disconnect the connection.
Parameters:	[conn_hdl] Connection handle of which the connection is disconnected.
Example:	gap disconn 0x0020 Disconnect the connection with connection handle 0x0020.

(5) Device command

device command	
Format:	gap device
	Display the addresses of the connected devices.
Parameters:	None
Example:	gap device Display the addresses of the connected devices.

(6) Privacy command

priv command		
Format:	<p>gap priv [operation] {params, ...}</p> <p>gap priv set (IRK) [priv_mode]</p> <p>gap priv remove [addr] [addr_type]</p> <p>gap priv get Irpa ([addr] [addr_type])</p> <p>gap priv off</p>	
	Operate the local device's privacy.	
Parameters:	<p>[operation]</p> <p>Select one of the followings as the operation of privacy.</p> <p>set: Register the IRK of the local device in the resolving list and turn on the address generation function. It is used when the local device uses RPA in the advertising command and connection command.</p> <p>remove: Delete the remote device registered in the resolving list.</p> <p>get: Get the local device RPA for sending to remote device.</p> <p>off: Turn off the address generation function.</p>	
	<p>[operation]: set</p> <p>(IRK): The local device's IRK which is registered in the resolving list. If this parameter is omitted, the IRK is generated with the random generation function.</p> <p>[priv_mode]: Privacy mode and the address type of local device. Select one of the followings.</p> <p>net: network privacy mode. Static address is used as identity address.</p> <p>dev: device privacy mode. Static address is used as identity address.</p> <p>net_pub: network privacy mode. Public address is used as identity address.</p> <p>dev_pub: device privacy mode. Public address is used as identity address.</p> <p>net_rnd: network privacy mode. Static address is used as identity address.</p> <p>dev_rnd: device privacy mode. Static address is used as identity address.</p>	
	<p>[operation]: remove</p> <p>[addr]: Specify the address (6 bytes) of the remote device registered in the Resolving list.</p> <p>[addr_type]: Specify the address type of the remote device registered in the Resolving list.</p>	
	<p>[operation]: get</p> <p>Irpa: Get the local device RPA for advertising.</p> <p>[addr]: Specify the address (6 bytes) of the remote device registered in the Resolving list.</p> <p>[addr_type]: Specify the address type of the remote device registered in the Resolving list.</p>	

Example:

```
gap priv set 0001020304050600708090a0b0c0d0e0f dev
```

Register IRK: 0x0f0e0d0c0b0a09080706050403020100 and set the privacy mode to "device privacy mode".
Static address is used as identity address.

```
gap priv set net
```

IRK is generated by the random number generation. The privacy mode is set to "network privacy mode".
Static address is used as identity address.

```
gap priv set net_pub
```

IRK is generated by the random number generation. The privacy mode is set to "network privacy mode".
Public address is used as identity address.

```
gap priv remove 12:34:56:78:9a:bc pub
```

Delete the 12:34:56:78:9a:bc (public) remote device registered in the resolving list.

(7) Connection config command

conn_cfg command	
Format:	gap conn_cfg [operation] {params, ...} Connection configuration command.
Parameters:	<p>[operation]</p> <p>Type of connection configuration. Select one of the followings.</p> <ul style="list-style-type: none"> update: Connection parameter update. phy: Set PHY. def_phy: Set default phy. data_len: Set data packet length or data transmit time.
	<p>[operation]: update</p> <p>Parameter1: Connection handle.</p> <p>Parameter2: Connection interval. Time(ms) = Parameter2 x 1.25. Valid range is 0x0006-0x0C80.</p> <p>Parameter3: Peripheral latency. Valid range is 0x0000-0x01F3.</p> <p>Parameter4: Supervision timeout. Time(ms) = Parameter4 x 10. Valid range is 0x000A-0x0C80.</p> <p>Input Parameter2-4 to meet the following condition. Parameter4 x 10 >= (1 + Parameter3) x Parameter2 x 1.25</p>
	<p>[operation]: phy</p> <p>Parameter1: Connection handle</p> <p>Parameter2: Transmitter PHY. Parameter2 is set to a bitwise OR of the following values.</p> <ul style="list-style-type: none"> bit0: 1M PHY bit1: 2M PHY bit2: Coded PHY <p>Parameter3: Receiver PHY. Parameter3 is set to a bitwise OR of the following values.</p> <ul style="list-style-type: none"> bit0: 1M PHY bit1: 2M PHY bit2: Coded PHY <p>Parameter4: Coding scheme of Coded PHY. Select one of the following.</p> <ul style="list-style-type: none"> 0x00: The controller's preferred value. 0x01: S=2 Coding scheme. 0x02: S=8 Coding scheme.
	<p>[operation]: def_phy</p> <p>Parameter1: Transmitter PHY preferences which a remote device may change. Parameter1 is set to a bitwise OR of the following values.</p> <ul style="list-style-type: none"> bit0: 1M PHY bit1: 2M PHY bit2: Coded PHY <p>Parameter2: Receiver PHY preferences which a remote device may change. Parameter2 is set to a bitwise OR of the following values.</p> <ul style="list-style-type: none"> bit0: 1M PHY bit1: 2M PHY bit2: Coded PHY
{params, ...}	<p>[operation]: data_len</p> <p>Parameter1: Connection handle</p> <p>Parameter2: Maximum transmit packet data length (in bytes). Valid range is 0x001B-0x00FB.</p> <p>Parameter3: Maximum transmit time (us). Valid range is 0x0148-0x4290.</p>

Example:

```
gap conn_cfg update 0x0020 0x0100 0 0x0100
```

Change the connection parameters of the connection handle: 0x0020 to the following values.

```
connection interval: 0x0100  
peripheral latency: 0  
supervision timeout: 0x0100
```

```
gap conn_cfg phy 0x0020 2 2 0
```

Change the PHY of the connection (connection handle: 0x0020)

```
Transmitter PHY: 2M  
Receiver PHY: 2M
```

```
gap conn_cfg def_phy 7 7
```

Accept the following change request.
Transmitter PHY: 1M, 2M and Coded PHY.
Receiver PHY: 1M, 2M and Coded PHY.

```
gap conn_cfg data_len 0x0020 0x00FB 0x4290
```

Change the following transmit packet length or transmit time
Max transmit packet length: 251 bytes
Max transmit time: 0x4290 us

(8) White List command

wl command	
Format:	gap wl [operation] {params, ...} White List operation command.
Parameters:	[operation] White List operation. Select one of the followings. reg: Register a device specified with the {params, ...} on the White List. del: Delete the device specified with the {params, ...} on the White List. clear: Clear the White List.
	{params, ...} [operation]: reg Parameter1: Address of a device to be registered on the White List. Parameter2: Address type of a device to be registered on the White List. pub: Public Address rnd: Random Address
	{params, ...} [operation]: del Parameter1: Address of a device to be deleted on the White List. Parameter2: Address type of a device to be deleted on the White List. pub: Public Address rnd: Random Address
Example:	gap wl reg 74:90:50:00:95:a8 pub Register the device whose public address is 74:90:50:00:95:a8 on the White List. gap wl del 74:90:50:00:95:a8 pub Delete the device whose public address is 74:90:50:00:95:a8 on the White List. gap wl clear Clear the White List.

(9) Authentication command

auth command	
Format:	gap auth [operation] {params, ...} Pairing or encryption command.
Parameters:	<p>[operation]</p> <p>Security operation.</p> <p>start: Start pairing or encryption.</p> <p>passkey: Input 6-digit number(decimal) to be required in passkey entry pairing.</p> <p>numcmp: Return the result of a numeric comparison.</p> <p>del: Delete the pairing keys.</p>
	<p>[operation]: start</p> <p>Parameter1: Connection handle identifying the connection which local device starts pairing or encryption.</p>
	<p>[operation]: passkey</p> <p>Parameter1: 6 digit passkey (decimal)</p>
	<p>[operation]: numcmp</p> <p>Parameter1: Result of a numeric comparison. ("yes" or "no") Return "yes" if both devices display same number, otherwise "no".</p>
	<p>{params,...}</p> <p>[operation]: del</p> <p>Parameter1: Type of key to be deleted.</p> <p>local: keys which local device distributes.</p> <p>remote: keys distributed from the remote devices.</p> <p>all: the above two types of keys.</p> <p>Parameter2: Type of the remote device key deletion.</p> <p>addr: Delete the keys specified by the Parameter3, 4.</p> <p>all: Delete all the keys distributed from remote devices.</p> <p>not_conn: Delete the keys of the unconnected remote devices.</p> <p>Parameter3: Address of the remote device whose keys to be deleted.</p> <p>Parameter4: Address type of the remote device whose keys to be deleted.</p> <p>pub: Public Address</p> <p>rnd: Random Address</p>

Example:

```
gap auth start 0x0020
```

Start pairing or encryption with the connection (connection handle: 0x0020).

```
gap auth passkey 123456
```

Input "123456" as a passkey.

```
gap auth numcmp yes
```

Return "yes" as a result of numeric comparison.

```
gap auth del remote all
```

Delete all the keys distributed from the remote devices.

(10) Synchronization command

sync command					
Format:	gap sync [operation] {params...} Create or Terminate a periodic sync.				
Parameters:	<table border="1"> <tr> <td style="background-color: #000080; color: white;">[operation]</td> <td> Periodic sync operation. create: Create a periodic sync with the device whose address is specified by the {params...}. Scanning runs until a periodic sync is established. In case of stopping creating periodic sync, input [ctrl] + [c]. term: Terminate the periodic sync whose sync_hdl is specified by the {params...}. </td> </tr> </table>	[operation]	Periodic sync operation. create: Create a periodic sync with the device whose address is specified by the {params...}. Scanning runs until a periodic sync is established. In case of stopping creating periodic sync, input [ctrl] + [c]. term: Terminate the periodic sync whose sync_hdl is specified by the {params...}.		
	[operation]	Periodic sync operation. create: Create a periodic sync with the device whose address is specified by the {params...}. Scanning runs until a periodic sync is established. In case of stopping creating periodic sync, input [ctrl] + [c]. term: Terminate the periodic sync whose sync_hdl is specified by the {params...}.			
{params,...}	<table border="1"> <tr> <td style="background-color: #000080; color: white;">[operation]: create</td> <td> Parameter1: Address of the advertiser. Parameter2: Address type of the advertiser. </td> </tr> <tr> <td style="background-color: #000080; color: white;">[operation]: term</td> <td> Parameter1: Sync handle identifying the periodic sync to be terminated. If no parameters are given, all the established periodic syncs are terminated. </td> </tr> </table>	[operation]: create	Parameter1: Address of the advertiser. Parameter2: Address type of the advertiser.	[operation]: term	Parameter1: Sync handle identifying the periodic sync to be terminated. If no parameters are given, all the established periodic syncs are terminated.
[operation]: create	Parameter1: Address of the advertiser. Parameter2: Address type of the advertiser.				
[operation]: term	Parameter1: Sync handle identifying the periodic sync to be terminated. If no parameters are given, all the established periodic syncs are terminated.				
Example:	<pre>gap sync create 74:90:50:00:95:a8 pub Establish a periodic sync with the advertiser whose public address is 74:90:50:00:95:a8. gap sync term 0x01 Terminate the periodic sync (sync handle: 0x01).</pre>				

(11) Version command

ver command	
Format:	gap ver
	Get the following Bluetooth LE Protocol Stack version information. <ul style="list-style-type: none"> - Link Layer - HCI - Host Stack - Manufacturer ID - BLE FIT module - library type
Parameters:	None
Example:	gap ver
	Get the version information.
	<u>Result sample:</u>
	Link Layer / HCI Version
	HCI version : 0x09 *1
	HCI revision : 0x000b
	Link Layer version : 0x09 *1
	Link Layer subversion : 0x1908
	Manufacturer ID : 0x0036
	Host stack Version
	major version : 0x0d
	minor version : 0x19
subminor version : 0x08	
BLE FIT module Version	
major minor version : 0x00010000 *2	
lib type : 0x00000001 *3	

*1: The version number defined by Bluetooth SIG (<https://www.bluetooth.com/specifications/assigned-numbers>).
 The version number 0x09 shows Bluetooth 5.0.

*2: The upper 2 bytes shows the major version, and the lower 2 bytes shows the minor version.

*3: 0: All features, 1: Balance, 2: Compact

5.1.2 Vendor Specific (VS) command

(1) Tx Power command

txp command		
Format:	vs txp [operation] [conn_hdl] {params,...}	
	Set / Get the transmit power.	
Parameters:	[operation]	Transmit power operation. set: Set the transmit power. get: Get the transmit power.
	[conn_hdl]	Connection handle identifying the connection whose transmit power to be set or retrieved. Inputting 0xFFFF sets / gets the transmit power in the non-connected state.
	{params,...}	[operation]: set Parameter1: Tx power level to be set. 0: High 1: Middle 2: Low
		[operation]: get Not used.
Example:	vs txp set 0xFFFF 0 Set the non-connected state transmit power to the High level. vs txp get 0x0020 Get the transmit power of the connection (connection handle: 0x0020).	

(2) Coded Scheme command

scheme command		
Format:	vs scheme [type]	
	Set the coding scheme of the Coded PHY.	
Parameters:	[type]	Coding scheme for Primary advertising PHY, Secondary advertising PHY, request for connection establishment. This parameter is set to a bitwise OR of the following values. By default, S=8 coding scheme is enabled. bit0: Coding scheme for Primary Advertising PHY (0:S=8/1:S=2). bit1: Coding scheme for Secondary Advertising PHY (0:S=8/1:S=2). bit2: Coding scheme for Connection (0:S=8/1:S=2).
Example:	vs scheme 7 Set coding scheme for Primacy Advertising, for Secondary Advertising, and for Connection to S=2.	

(3) Extended Direct Test Mode (DTM) command

test command	
Format:	vs test [operation] {params, ...} DTM test command.
Parameters:	<p>[operation]</p> <p>DTM test operation. Select one of the followings.</p> <p>tx: Start DTM transmitter test. Set "channel", "length", "payload", "phy", "tx_power", "option" and "number of packet" to {params, ...}.</p> <p>rx: Start DTM receiver test. Set "channel" and "phy" to {params, ...}.</p> <p>end: Terminate DTM test. No parameter.</p>
	<p>{params, ...}</p> <p>[operation]: tx Parameter1: Channel used in Tx test. Valid range is 0 to 39. Frequency range is 2402 MHz to 2480 MHz. Parameter2: Length (in bytes) of the packet used in Tx Test. Valid range is 0 to 255. Parameter3: Packet Payload. Valid range is 0x00-0x07. If the Parameter6 is set to "non-modulation", this parameter is ignored.</p> <p><u>Payload type:</u> 0x00: PRBS9 sequence '1111111100000111101...' 0x01: Repeated '11110000' 0x02: Repeated '10101010' 0x03: PRBS15 sequence 0x04: Repeated '11111111' 0x05: Repeated '00000000' 0x06: Repeated '00001111' 0x07: Repeated '01010101'</p> <p>Parameter4: Transmitter PHY used in test. Select one of the following. If the Parameter6 is set to "non-modulation", this parameter is ignored. If the Parameter6 is configured to "modulation" and "continuous transmission", 0x03: Coded PHY (S=8) and 0x04: Coded PHY (S=2) are not supported.</p> <p>0x01: 1M PHY 0x02: 2M PHY 0x03: Coded PHY (S=8) 0x04: Coded PHY (S=2)</p>

Parameters:	{params, ...}	<p>Parameter5: Tx Power Level used in DTM Tx Test. Select one of the following. 0x00: High 0x01: Middle 0x02: Low</p> <p>Parameter6: The test option configuration. This parameter is set to a bitwise OR of the following bits. bit0: 0: modulation, 1: non-modulation bit1: 0: packet transmission, 1: continuous transmission</p> <p>Parameter7: The number of packets to be sent. Valid range is 0x0000-0xFFFF. If the Parameter6 is configured to "continuous transmission", this parameter is ignored. If this parameter is set to 0x0000, the packets are continuously transmitted until test end command is issued.</p>
		<p>[operation]: rx</p> <p>Parameter1: Channel used in the test. Valid range is 0 to 39. Frequency range is 2402 MHz to 2480 MHz.</p> <p>Parameter2: Receiver PHY used in the test. Select one of the following.</p> <p>0x01: 1M PHY 0x02: 2M PHY 0x03: Coded PHY</p> <p>The coding scheme (S=8/S=2) doesn't need to be specified in the receiver test.</p>
		<p>[operation]: end</p> <p>Not used.</p>
Example:	<pre>vs test tx 39 251 1 3 1 0 1 Start DTM transmitter test. CH: 39ch Packet length: 251 bytes payload: Repeated '11110000' sequence phy: Coded PHY(S=8) tx_power: Middle option: modulation packet transmission num_of_packet: 1 vs test rx 39 2 Start DTM receiver test. CH: 39ch phy: 2M PHY vs test end Terminate DTM test.</pre>	

(4) BD Address command

addr command									
Format:	vs addr [operation] [area] {params...} Set/Get the address of the local device.								
Parameters:	<table border="1"> <tr> <td style="background-color: #000080; color: white;">[operation]</td> <td>Address operation. Select one of the followings. set: Set an address to the local device. Set address type and address to {params...}. If [area] is "df", the address is enabled after reset. get: Get the address of the local device. Set the address type to {params...}.</td> </tr> <tr> <td style="background-color: #000080; color: white;">[area]</td> <td>The area where the address is stored. curr: The temporary area storing the address. df: The area storing the address in the Data Flash.</td> </tr> <tr> <td style="background-color: #000080; color: white;">{params...}</td> <td> [operation]: set Parameter1: Address type pub: Public Address rnd: Random Address Parameter2: Address </td> </tr> <tr> <td style="background-color: #000080; color: white;">{params...}</td> <td> [operation]: get Parameter1: Address type pub: Public Address rnd: Random Address </td> </tr> </table>	[operation]	Address operation. Select one of the followings. set: Set an address to the local device. Set address type and address to {params...}. If [area] is "df", the address is enabled after reset. get: Get the address of the local device. Set the address type to {params...}.	[area]	The area where the address is stored. curr: The temporary area storing the address. df: The area storing the address in the Data Flash.	{params...}	[operation]: set Parameter1: Address type pub: Public Address rnd: Random Address Parameter2: Address	{params...}	[operation]: get Parameter1: Address type pub: Public Address rnd: Random Address
	[operation]	Address operation. Select one of the followings. set: Set an address to the local device. Set address type and address to {params...}. If [area] is "df", the address is enabled after reset. get: Get the address of the local device. Set the address type to {params...}.							
	[area]	The area where the address is stored. curr: The temporary area storing the address. df: The area storing the address in the Data Flash.							
	{params...}	[operation]: set Parameter1: Address type pub: Public Address rnd: Random Address Parameter2: Address							
{params...}	[operation]: get Parameter1: Address type pub: Public Address rnd: Random Address								
Example:	vs addr set df pub 78:90:50:00:95:a8 Set the public address: 78:90:50:00:95:a8 to the Data Flash. vs addr get curr pub Get the current public address.								

(5) Random Number generation command

rand command	
Format:	vs rand [rand_size] Generate a random number.
Parameters:	[rand_size] Specify the size of the random number to be generated. Range: 4 to 16 [bytes].
Example:	vs rand 16 Generate a 16 bytes random number.

(6) Scan Channel command

scan_ch_map command	
Format:	vs scan_ch_map [operation] {params,...} Set/Get the scan channel map.
Parameter:	[operation] Scan Channel operation. Select one of the followings. set: Set the channel map specified by {params,...} as scan channel. get: Get the current scan channel map.
	{params,...} [operation]: set Parameter 1: The channel map to be set. It is a bitwise OR of the following values. bit 0: 37 ch bit 1: 38 ch bit 2: 39 ch other than the above: reserved
	[operation]: get "Get" operation does not use parameter.
Example:	vs scan_ch_map set 7 Set 37, 38, 39ch as scan channel. vs scan_ch_map get Get the current scan channel map.

5.1.3 SYS command

(1) MCU Software Standby command

stby command			
Format:	sys stby [operation]		
	Control the software standby mode.		
Parameters:	<table border="1"><tr><td>[operation]</td><td>Software standby operation. Select one of the followings. on: Enter the software standby mode. off: Come back from the software standby mode. get: Get the current software standby status.</td></tr></table>	[operation]	Software standby operation. Select one of the followings. on: Enter the software standby mode. off: Come back from the software standby mode. get: Get the current software standby status.
[operation]	Software standby operation. Select one of the followings. on: Enter the software standby mode. off: Come back from the software standby mode. get: Get the current software standby status.		
Example:	sys stby on Enter the software standby mode.		

5.1.4 BLE command

(1) Bluetooth LE Protocol Stack Reset command

stby command	
Format:	ble reset
	Reset the Bluetooth LE Protocol Stack.
Parameters:	None
Example:	ble reset

(2) Bluetooth LE Protocol Stack Close command

stby command	
Format:	ble close
	Terminate the Bluetooth LE Protocol Stack. To restart the Bluetooth LE Protocol Stack, execute "ble reset" command.
Parameters:	None
Example:	ble close

5.2 Security Data Management

The security data management feature manages the following data in the E2 DataFlash(hereafter data flash) area.

- Local device key to distribute during pairing
- Key and information obtained from the remote device during pairing

The local device key and remote device key stored in the data flash can be reconfigured in the Bluetooth LE Protocol Stack using the security data management API.

The Abstraction API uses the security data management API to manage security data for local and remote devices.

The security data management feature is set using the configuration options shown in Table 5.4.

Table 5.4. Security data management configuration options

Configuration Options	Description
BLE_CFG_EN_SEC_DATA Default: "1"	Enable or disable the security data management. The bonding information is stored in the Data Flash block specified by "BLE_CFG_SECD_DATA_DF_BLOCK" by this option. 0: Disable 1: Enable If this option is enabled, add the Data Flash FIT module.
BLE_CFG_SECD_DATA_DF_BLOCK Default: "0"	The Data Flash block for the security data management to store the bonding information. Range: 0 to 7 Specify a block number different from the block number specified by BLE_CFG_DEV_DATA_DF_BLOCK.
BLE_CFG_NUM_BOND Default: "7"	Maximum number of the bonding information stored in the Data Flash. Range: 1 to 7

The security data management feature manages security data management information, local device security data, and remote device security data. The memory map in the data flash is as shown in Figure 5.1.

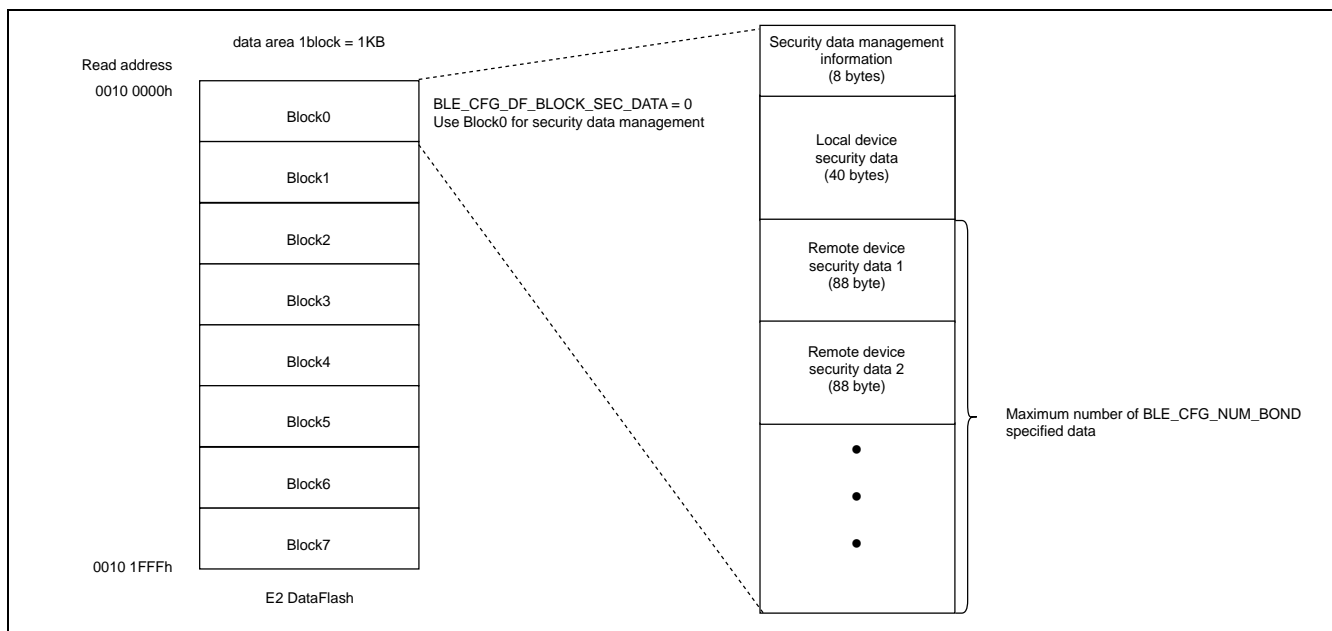

Figure 5.1. Memory map of security data in data flash

Each data information is described below.

5.2.1 Security data management information

This area stores information related to security data. The structure and structure elements of security data management information are shown in Figure 5.2 and Table 5.5. This data is handled internally by the security data management feature and does not need to be updated by the user application.

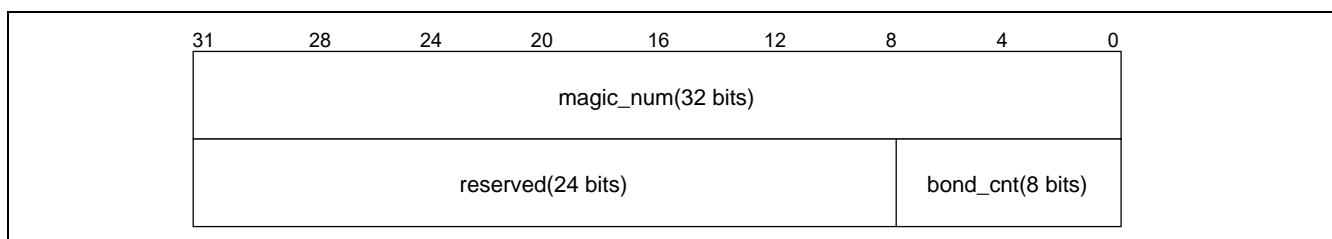

Figure 5.2. Security data management information structure

Table 5.5. Security management information structure elements

Element Name	Size [bytes]	Description
magic_num	4	Magic number of security data. Check whether security data is written. Fixed to 0x12345678. 0xFFFFFFFF when not written.
bond_cnd	1	Number of bonding information stored.
reserved	3	Reserved

5.2.2 Local device security data

The security data structure and structure elements of the local device are shown in Figure 5.3 and Table 5.6.

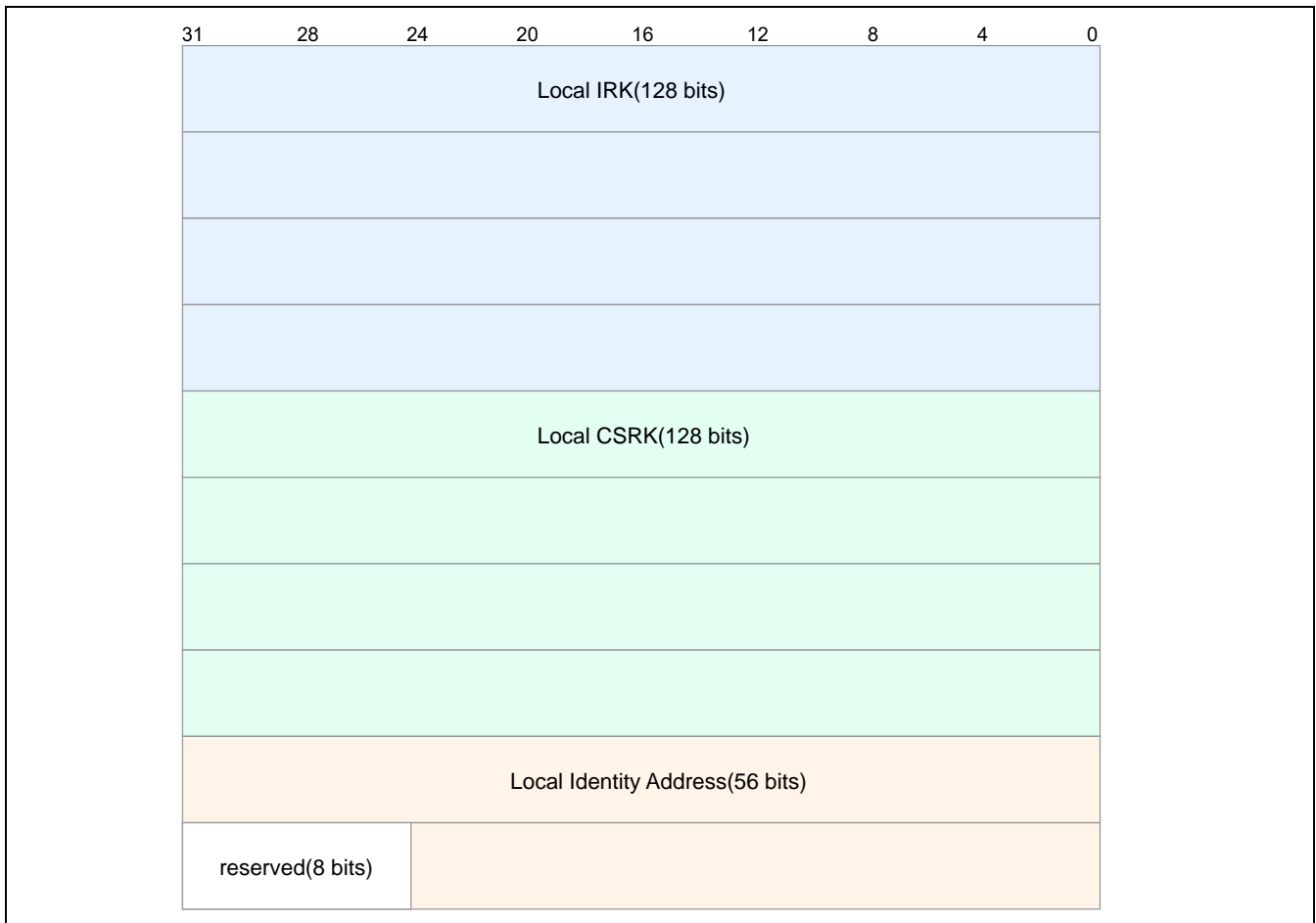

Figure 5.3. Local device security data structure

Table 5.6. Local device security data structure elements

Element Name	size [bytes]	Description
Local Identity Resolving Key (IRK)	16	IRK distributed to remote devices during pairing. Resolvable Private Address (RPA) is used when generating by Privacy feature.
Local Connection Signature Resolving Key (CSRK)	16	CSRK distributed to remote devices during pairing. Used when sending with signed data.
Local Identity Address	7	The local device that informs the remote device during pairing Identity Address.
reserved	1	Reserved

The following describes security data settings for local devices.

- IRK and CSRK generate and set a 16-byte random number.
- To set Bluetooth LE Protocol Stack, use *R_BLE_GAP_SetLocIdInfo()* (IRK, Identity Address) and *R_BLE_GAP_SetLocCsrk()* (CSRK).
- Write to the data flash using *R_BLE_SECD_WriteLocInfo()*.
- Read from the data flash using *R_BLE_SECD_ReadLocInfo()*.
- Delete from the data flash using *R_BLE_SECD_DeLocInfo()*.

By using security data management API, the generated security data can be written to data flash. It is possible to reconfigure to Bluetooth LE Protocol Stack after reboot device. Figure 5.4 shows an example of local device security data setting processing that is performed when the Bluetooth LE Protocol Stack is started.

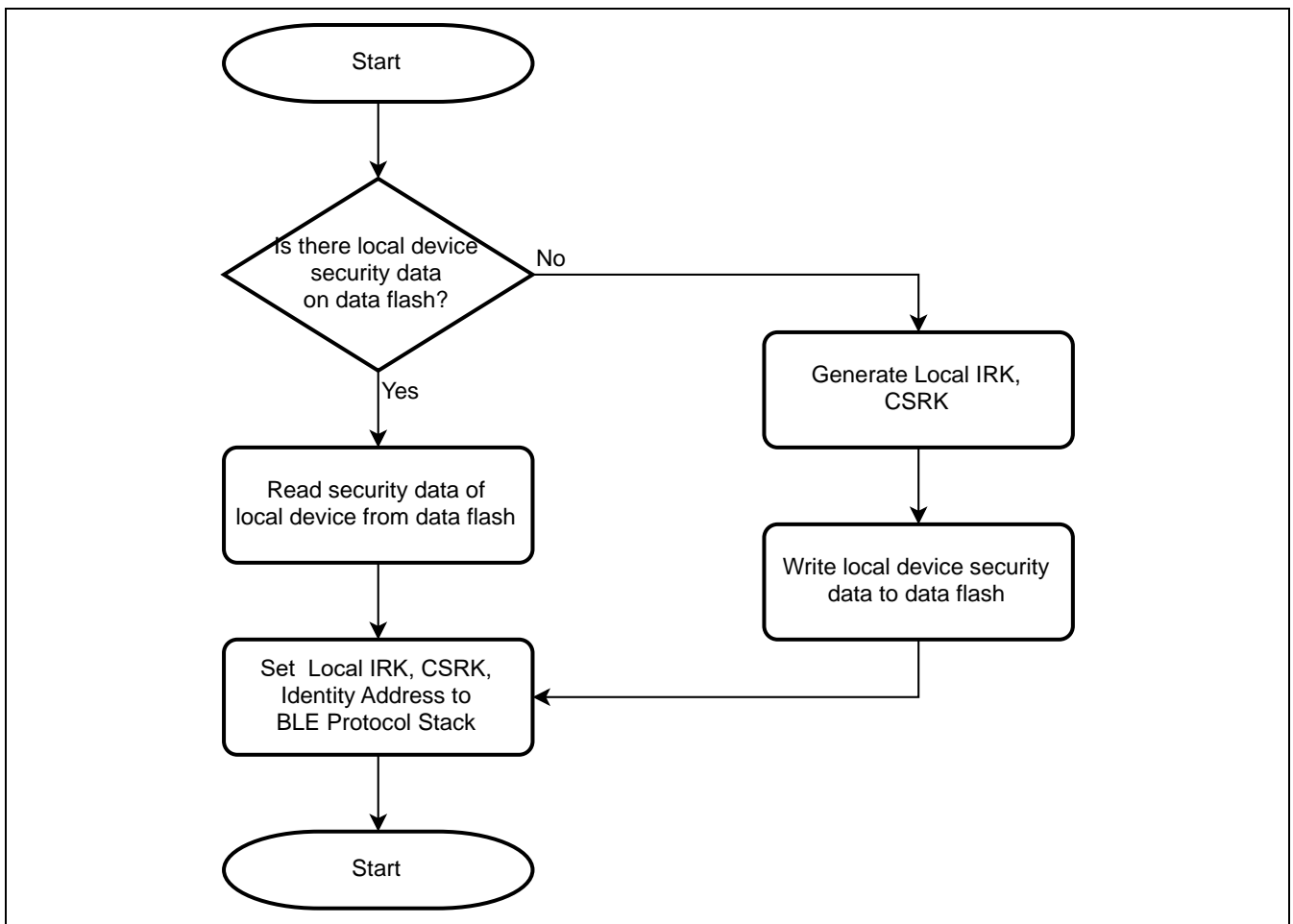

Figure 5.4. Example of setting local device security data

5.2.3 Remote device security data

The structure and structural elements of the remote device security data are shown in Figure 5.5 and Table 5.7.



Figure 5.5. Remote device security data structure

Table 5.7. Remote device security data structure elements

Element Name	size [bytes]	Description
Remote Address	7	BD address used by remote device during pairing.
bonding number	1	Bonding order.
security	1	Security level of the pairing performed. 0x01: Perform pairing with Unauthenticated pairing. 0x02: Perform pairing with Authenticated pairing
pair_mode	1	Type of pairing performed. 0x01: Perform pairing with Legacy Pairing. 0x02: Perform pairing with Secure Connections.
bonding	1	Bonding policy of remote device. 0x00: Indicates that remote device does not bonding performed. 0x01: Indicates that remote device is bonding performed.
ekey_size	1	Size of LTK.
remote key address	4	Start address of the data flash to store the remote device key (Remote LTK to Remote CSRK).
keys	1	Type of key distributed by remote device.
Remote LTK	16	LTK distributed by remote device. Used for connection encryption.
Remote EDIV and Rand	10	EDIV and Random number distributed by the remote device. Used for connection encryption.
Remote IRK	16	IRK distributed by remote device. Used for address resolution when the remote device uses the privacy feature.
Remote Identity Address	7	Identity address of remote device. Used for address resolution when remote device uses the privacy feature.
Remote CSRK	16	CSRK distributed by remote device. Used when receiving signed data.

The following describes security data settings for remote devices.

- The remote device security data is received during pairing.
- security, pair_mode, bonding, and ekey_size in Table 5.7 are written to data flash by *R_BLE_SECD_WriteRemKeys()* at the BLE_GAP_EVENT_PAIRING_COMP event. Other data is written to the data flash with *R_BLE_SECD_WriteRemKeys()* at the BLE_GAP_EVENT_PEER_KEY_INFO event.
- *R_BLE_SECD_Init()* reads the remote device security data from data flash and calls *R_BLE_GAP_SetBondInfo()* to set remote device security data in the Bluetooth LE Protocol Stack.
- Delete from the data flash using *R_BLE_SECD_DelRemKeys()*.
- If number of data written to data flash exceeds number specified by BLE_CFG_NUM_BOND macro, oldest security data entry is overwritten.

By using security data management API, the received remote device security data can be written to data flash. It is possible to reconfigure to Bluetooth LE Protocol Stack after reboot device.

5.3 RF communication timing notification

The RF communication timing notification function notifies the user application layer of the timing before and after Bluetooth LE RF communication is performed with a callback. Callback notification before and after transition to RF sleep mode can also be performed.

For the RF communication timing notification feature, you can select the Bluetooth LE RF event type to be executed and whether to enable or disable the timing notification at before and after Bluetooth LE RF event.

Note: This function performs a callback within the Bluetooth LE Protocol Stack software task processing. Therefore, callback notification is delayed from the actual RF communication timing. In addition, the delay time may not be constant depending on the operating frequency of the MCU, the interrupts of other peripheral functions, and the processing contents of the user application.

Table 5.8 shows the event types that can be notified.

Table 5.8. RF communication timing notification event type

Event Types	Description
Connection event start / event close	Callback notification at start or close of the Connection event. <Configuration options> <ul style="list-style-type: none"> • BLE_CFG_EVENT_NOTIFY_CONN_START • BLE_CFG_EVENT_NOTIFY_CONN_CLOSE
Advertising event start / event close	Callback notification at start or close of the Advertising event. <Configuration options> <ul style="list-style-type: none"> • BLE_CFG_EVENT_NOTIFY_ADV_START • BLE_CFG_EVENT_NOTIFY_ADV_CLOSE
Scan event start / event close	Callback notification at start or close of the Scan event. If Scan Interval is the same value as Scan Window, callback notification is not performed. <Configuration options> <ul style="list-style-type: none"> • BLE_CFG_EVENT_NOTIFY_SCAN_START • BLE_CFG_EVENT_NOTIFY_SCAN_CLOSE
Initiator event start / event close	Callback notification at start or close of the Initiator event. If Scan Interval is the same value as Scan Window, callback notification is not performed. <Configuration options> <ul style="list-style-type: none"> • BLE_CFG_EVENT_NOTIFY_INIT_START • BLE_CFG_EVENT_NOTIFY_INIT_CLOSE
RF sleep mode start / wakeup	Callback notification at start or wakeup of the RF sleep mode. <Configuration options> <ul style="list-style-type: none"> • BLE_CFG_EVENT_NOTIFY_DS_START • BLE_CFG_EVENT_NOTIFY_DS_WAKEUP

5.3.1 Connection event notification timing

The Connection event notification is callback at the RF communication timing for each Connection Interval.

Figure 5.6 shows the connection event notification timing.

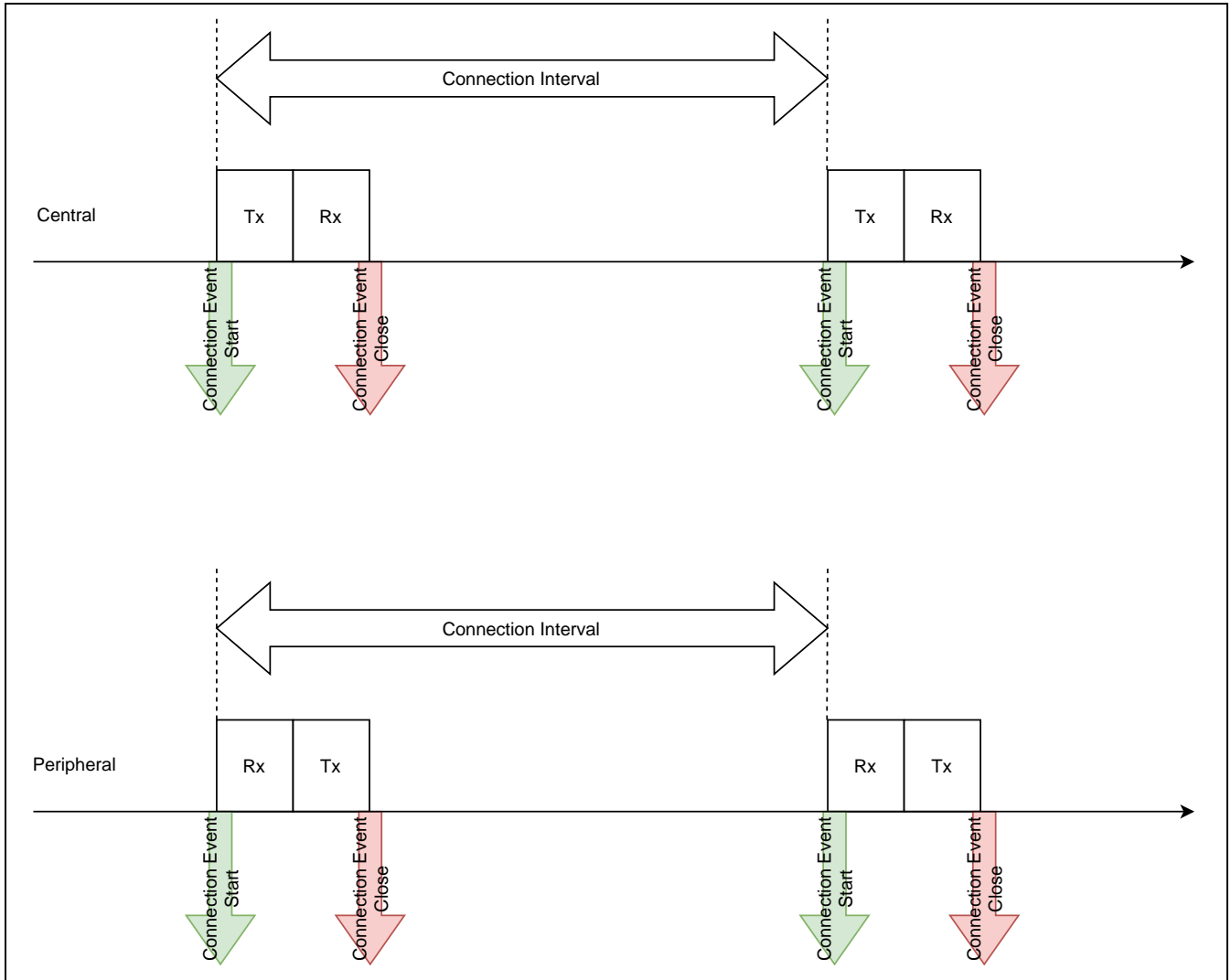

Figure 5.6. Connection event notification timing

5.3.2 Advertising event notification timing

The Advertising event notification is callback at the RF communication timing for each Advertising Interval.

Figure 5.7 shows the advertising event notification timing.

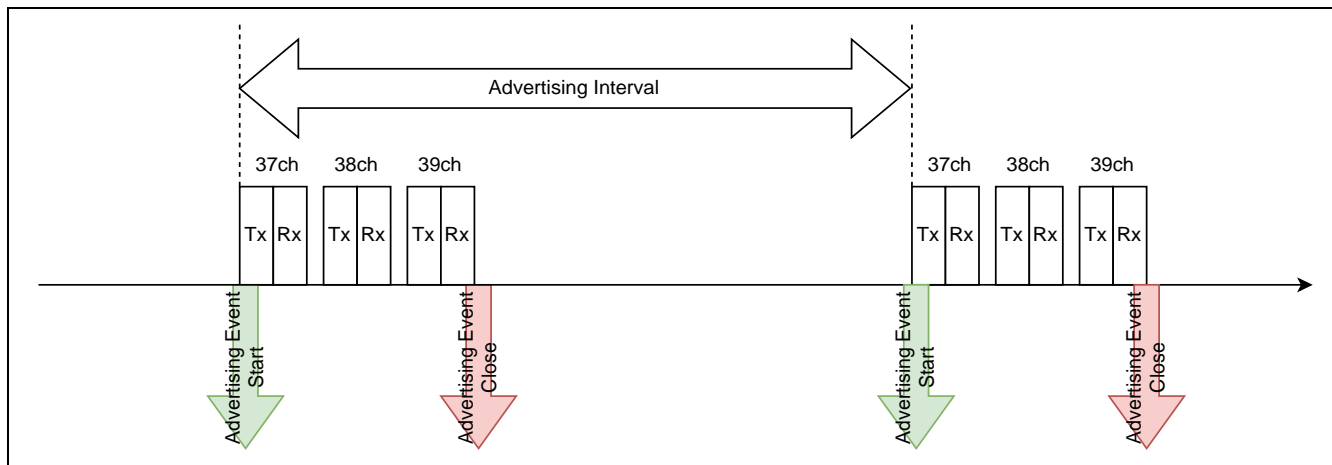

Figure 5.7. Advertising event notification timing

5.3.3 Scan / Initiator event notification timing

The Scan / Initiator event notification is callback at the RF communication timing for each Scan Interval.

Figure 5.8 shows the Scan / Initiator event notification timing.

Note: If Scan Interval is the same value as Scan Window, callback notification is not performed.

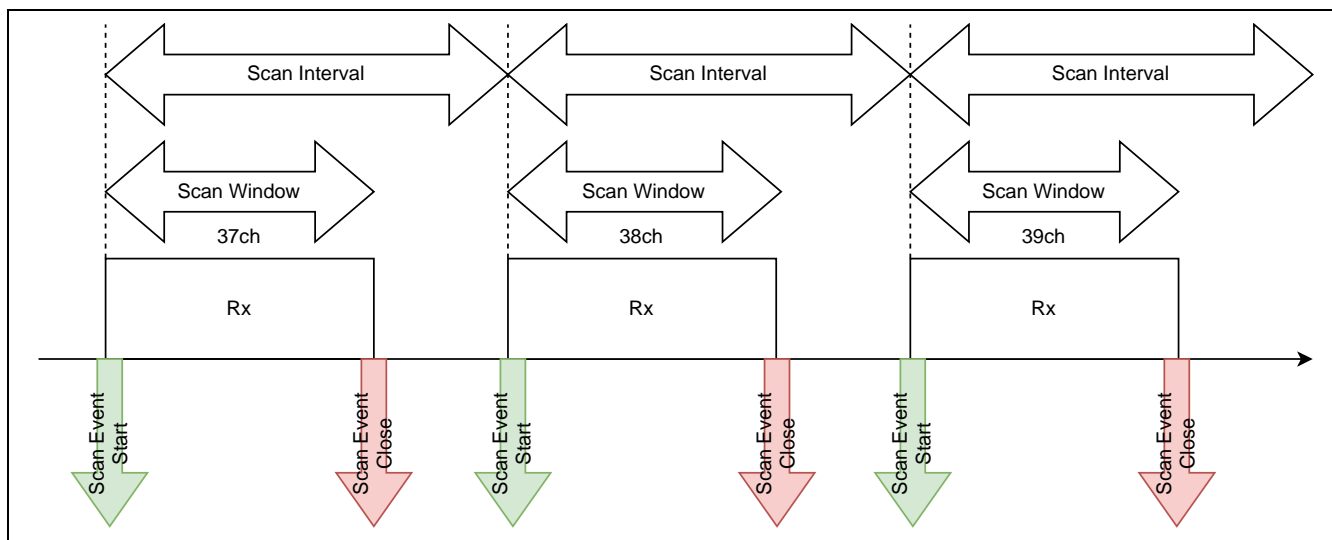

Figure 5.8. Scan / Initiator event notification timing

5.3.4 RF sleep mode event notification timing

When BLE_CFG_RF_DEEP_SLEEP_EN macro is set to 1 (Enable) and the time until the next RF event is longer than a certain time, the RF sleep mode transition is performed in the scheduler of the Bluetooth LE Protocol Stack.

The RF sleep mode event notification is callback when there is an RF sleep mode state transition between each RF events.

Figure 5.9 shows the RF sleep mode event notification timing during Advertising execution.

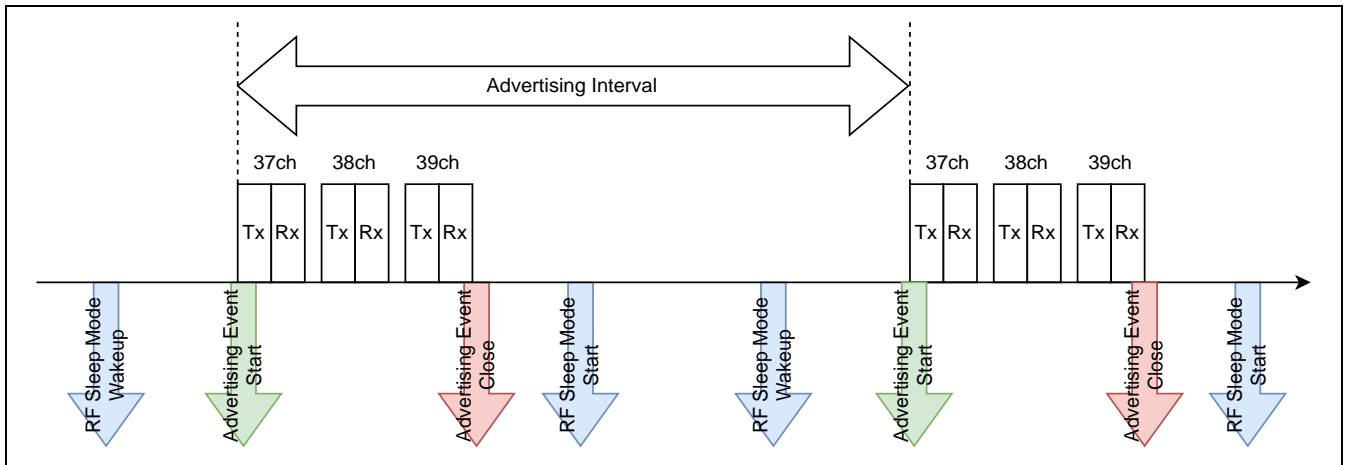

Figure 5.9. RF sleep mode event notification timing during Advertising

5.3.5 RF communication timing notification specifications

RF communication timing notification is enable/disable using the configuration options shown in Table 5.8. For an overview of each option, see “4.1 Configuration options”.

The timing notification callback function is registered in `r_ble_pf_functions.c`. Add processing within each callback function as necessary.

Note: When processing with a large cycle is added, the throughput performance may be affected.

Table 5.9 outlines the RF communication timing notification callback function.

Table 5.9. RF communication timing notification callback functions

Callback functions	Description
<code>void r_ble_rf_notify_event_start(uint32_t param)</code>	Notification callback function for each RF event start. Parameter: <code>uint32_t param</code> [31:16] Event type (see Table 5.10) [15: 0] Event identification code (see Table 5.11)
<code>void r_ble_rf_notify_event_close(uint32_t param)</code>	Notification callback function for each RF event close. Parameter: <code>uint32_t param</code> [31:16] Event type (see Table 5.10) [15: 0] Event identification code (see Table 5.11)
<code>void r_ble_rf_notify_deep_sleep(uint32_t param)</code>	Notification callback function for RF sleep mode start/wakeup event. Parameter: <code>uint32_t param</code> 0x1: RF sleep mode wakeup (return from RF sleep mode) 0x0: RF sleep mode start (transition to RF sleep mode)

Table 5.10. RF communication event type definition macros

Event Type	Macro Name	Defined Value
Connection event	<code>BLE_EVENT_TYPE_CONN</code>	0x0000
Advertising event	<code>BLE_EVENT_TYPE_ADV</code>	0x0001
Scan event	<code>BLE_EVENT_TYPE_SCAN</code>	0x0002
Initiator event	<code>BLE_EVENT_TYPE_INITIATOR</code>	0x0003

Table 5.11. RF communication event identification code

Event Type	Identification code
Connection event	Set the executed connection handle (<code>conn_hdl</code>).
Advertising event	Set the executed advertising handle (<code>adv_hdl</code>).
Scan event	Set 0x0000
Initiating event	Set 0x0000

5.4 Device-specific Data Management

Bluetooth Device Address (hereinafter referred to as BD address) used by Bluetooth LE Protocol Stack can be written as device-specific data in the user area (ROM) or data area (E2 DataFlash) of flash memory. This allows user to set different BD address for multiple RX23W devices using the same firmware.

Device-specific data is placed in a different area from the firmware program area. If the device-specific data is not deleted when rewriting the firmware, the same BD address can be used continuously. If the device-specific data is deleted, determine the BD address according to “5.4.6 BD address adoption flow”.

5.4.1 Specifying Device-specific data location block

The block number of the user area (ROM) and data area (E2 data flash) where device-specific data is located can be specified with the BLE_CFG_DEV_DATA_CF_BLOCK and BLE_CFG_DEV_DATA_DF_BLOCK configuration options in r_ble_rx23w_config.h.

The block number of user area is block 0 at end of address (0xFFFFF800) and block 255 at beginning of address (0xFFF80000). The block number of data area is block 0 at beginning of address (0x00100000) and block 7 at end of address (0x00101C00).

Figure 5.10 shows the block configuration of RX23W.

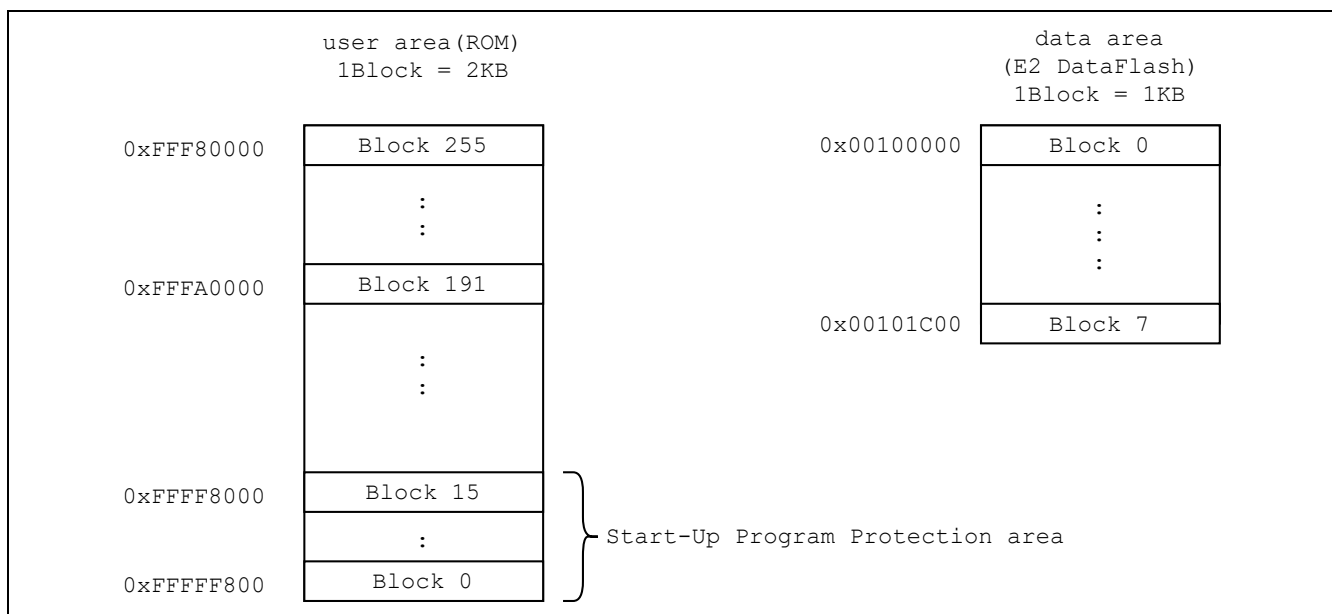

Figure 5.10. RX23W flash memory block configuration

When placing device-specific data in user area, it is necessary to specify blocks that are not used in program code. In addition, it is necessary to write device-specific data to the top address in specified user area block.

When using RX23W Start-Up Program Protection function, do not place device-specific data in blocks 0 to 15 of user area.

When placing device-specific data in data area, device-specific data is written to top address in specified data area block. Do not write other data to the block where device-specific data is placed.

5.4.2 Device-specific data format

Table 5.12 shows the device-specific data format.

Table 5.12. device-specific data format

Offset	Size[bytes]	Type	Description
0	4	uint32_t	Data length after magic number (fixed to 0x00000010)
4	4	uint32_t	Magic number (fixed 0x12345678)
8	6	uint8_t [6]	Public BD address
14	6	uint8_t [6]	Random BD address

Each data must be written in little endian. For example, if BD address is “01:02:03:04:05:06”, write to the flash memory in the order of 0x06,0x05,0x04,0x03,0x02,0x01.

Figure 5.11 shows an example of device-specific data flash memory layout.

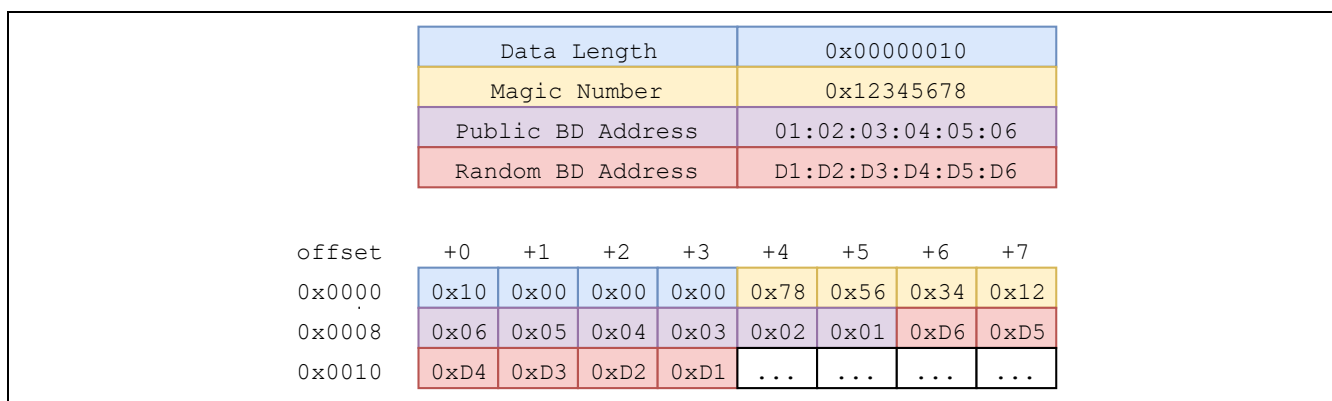

Figure 5.11. Device-specific data flash memory layout

5.4.3 Writing to user area (ROM)

To write device-specific data to user area (ROM), use Renesas Flash Programmer (RFP) unique code function to write to user area at the same time as firmware program data.

Figure 5.12 shows an overview of writing device-specific data using RFP.

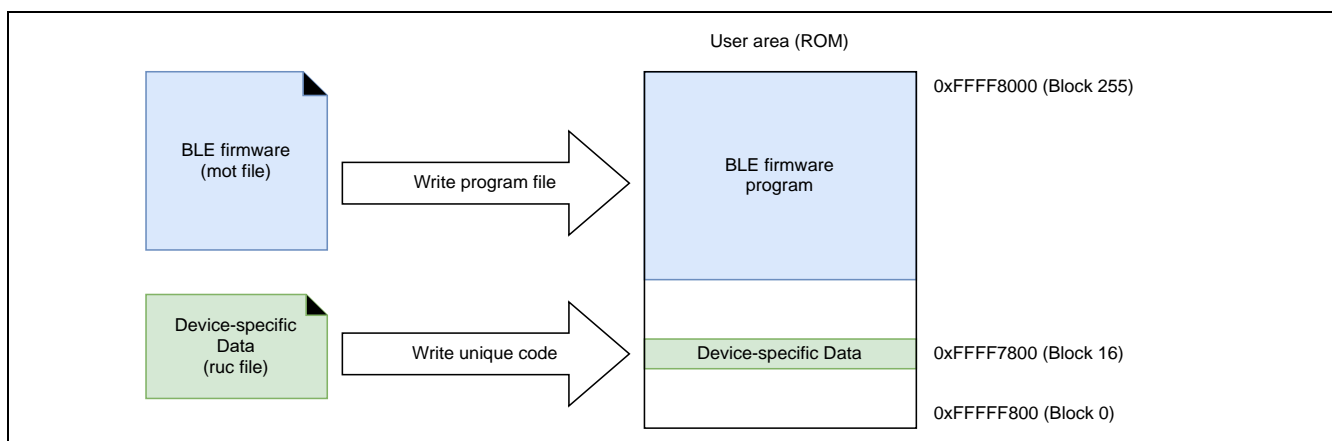

Figure 5.12. Writing device-specific data using RFP

Figure 5.13 shows an example of setting device-specific data for RFP Unique Code (ruc) file.

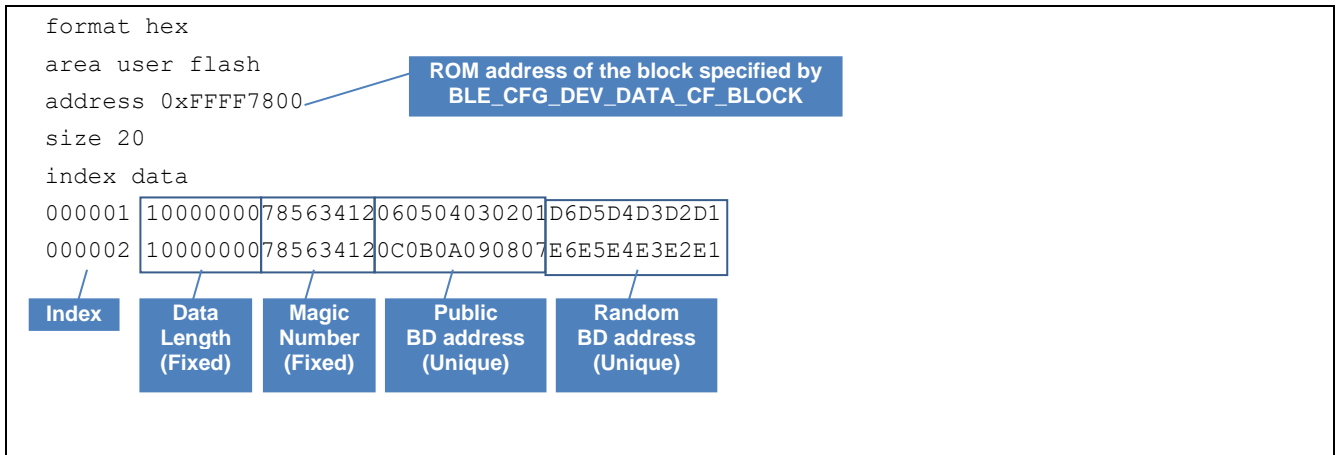

Figure 5.13. Setting device-specific data for RFP Unique Code

5.4.4 Writing to data area (E2 DataFlash)

Use the R_BLE API *R_BLE_VS_SetBdAddr()* to write device-specific data to data area.

For HCI mode firmware, write using the Public BD address writing tool (BdAddrWriter).

When device-specific data is written to the data area, BD address written by reboot once RX23W is adopt.

5.4.4.1 Write to data area using R_BLE API

Write to the data area using *R_BLE_VS_SetBdAddr()*.

Refer to “R_BLE API document (r_ble_api_spec.chm)” for details of API.

In the demo project, BD address can be written from the command line using the “BD Address command”.

5.4.4.2 Write to data area using BDAAddrWriter tool

User can write Public BD address to data area by using Public BD address writing tool (BDAAddrWriter) for the RX23W device with HCI mode firmware.

Note: BDAAddrWriter does not support Random BD address writing.

The procedure for writing Public BD address using BDAAddrWriter tool is shown below.

1. Select COM port connected to RX23W.
2. Set UART baud rate. If it is not in the list, input value manually.
3. Input Public BD address you want to write in text box. Input 12 digits (6 bytes) of hexadecimal character string (0-9, a-f, A-Z) to need. Discards non-hexadecimal character strings when writing.
4. Click [Write] button.
5. If writing is successful, the message box "Success!!" is displayed. Public BD address written by reboot RX23W device once is adopt.

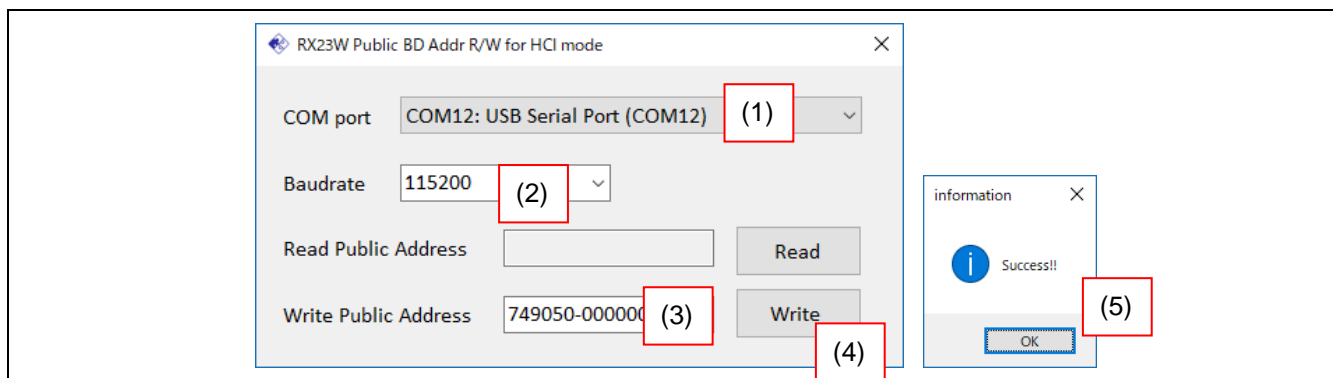

Figure 5.14. BD address writing procedure

5.4.5 RX23W flash memory protection function

RX23W has a flash memory protection function. Flash memory protection prevents the flash memory from being read or rewritten by the third party. For details of flash memory protection function, refer to “RX23W Group User's Manual: Hardware (R01UH0823) 50.9 Flash Memory Protection”.

When using serial programmer such as RFP to write new firmware without erasing device-specific data, it is necessary to enable boot mode ID code protection of RX23W so that block selection for flash memory erasing can be performed.

To enable boot mode ID code protection, set 0x45 or 0x52 to ID code protection control code, and set any ID code 1 to 15.

Note: When setting the control code to 0x52, if the ID codes 1 to 15 are forgotten, the firmware cannot be rewritten by the serial programmer.

The ID code protection control code and ID code settings can be changed from [ID code 1] to [ID code 4] by selecting [r_bsp] from [Components] tab of Smart Configurator.

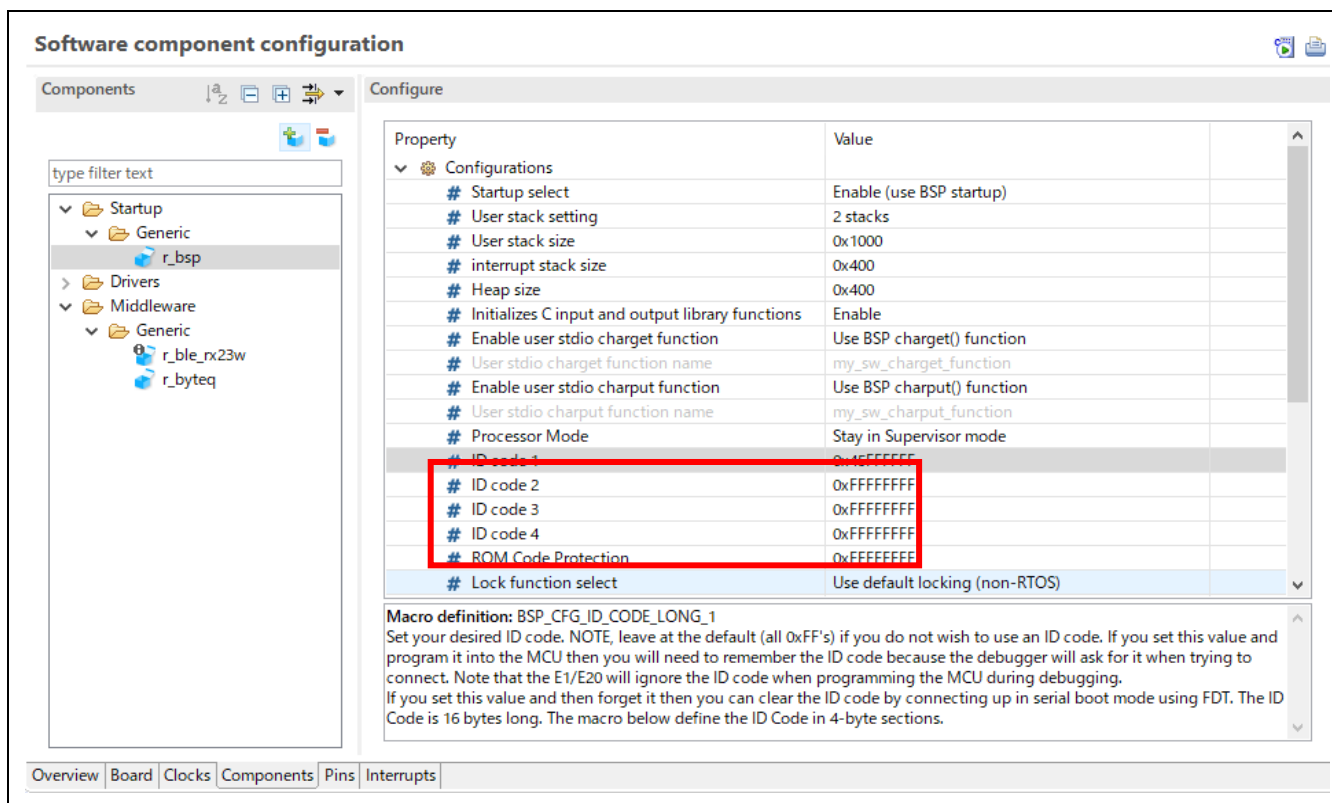

Figure 5.15. BSP configuration option setting screen

ID code protection is written to ID code protection area (address 0xFFFFFFFFA0) in user area when writing firmware. However, when debug connection from the e² studio using E2 or E1 emulator, even if ID code protection is set in firmware, ALL 0xFF is set in the ID code protection area and ID code protection is disabled.

When ID code protection is disabled, all blocks in the user area and data area are erased once when writing firmware with RFP.

Therefore, when performing debug connection in integrated development environment, remember BD address written in the user area or data area, rewrite device-specific data again after flash memory is erased.

5.4.6 BD address adoption flow

Bluetooth LE Protocol Stack adopts initial value of BD address in following priority order in *R_BLE_Open()* API.

- (1) Data area (E2 data flash) specified block
- (2) User area (ROM) specified block
- (3) Firmware initial value (BLE_CFG_RF_DBG_PUB_ADDR or BLE_CFG_RF_DBG_RAND_ADDR)

For Random BD address, if BD addresses for all areas are not specified, static address is generated from Unique ID of MCU. Generated static address can be get with the *R_BLE_VS_GetBdAddr()* API.

Note: The generated static address is a fixed value that does not change when the MCU power off or reset.

Note: A static address consists of random numbers. The possibility of duplicate values with other devices is not zero.

Even after BD address is adopts, the BD address can be changed again with *R_BLE_VS_SetBdAddr()* API.

Figure 5.16 shows BD address adoption flow of Bluetooth LE Protocol Stack.

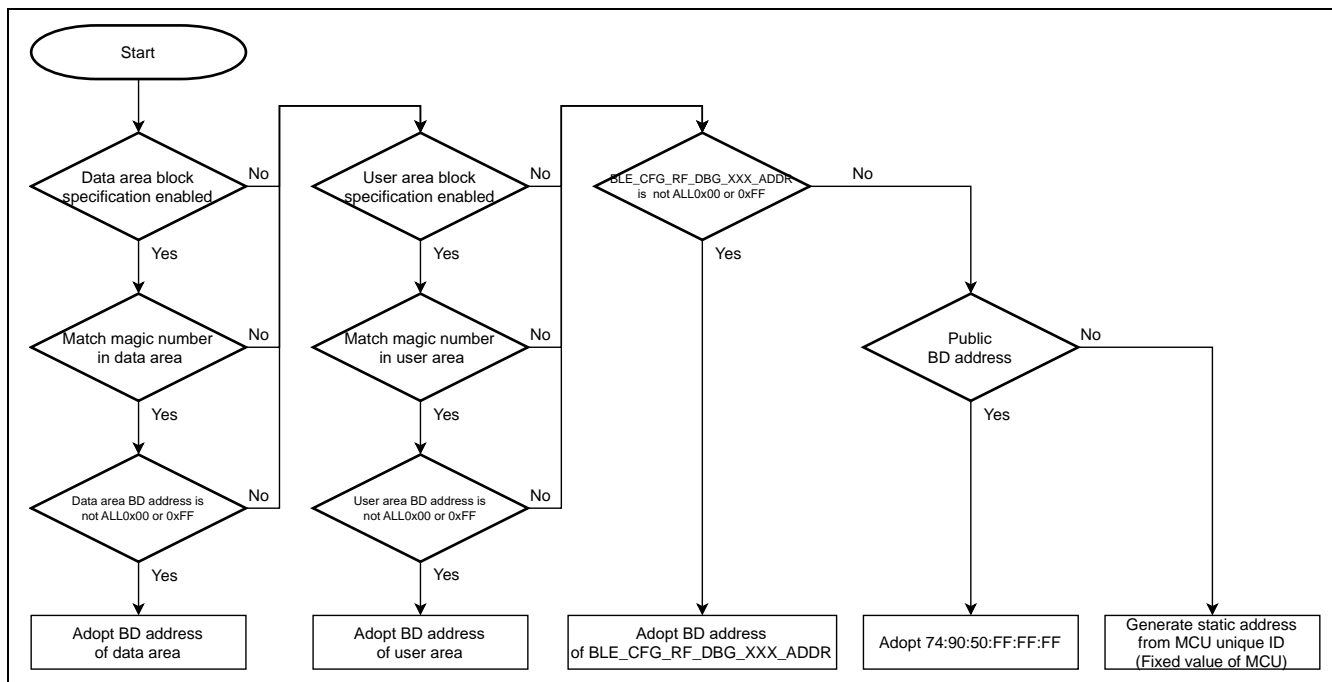

Figure 5.16. BD address adoption flow of Bluetooth LE Protocol Stack

Since Bluetooth LE Protocol Stack does not check format of BD address written in each area (1)-(3), when setting static address, set value that matches the format shown in Figure 5.17.

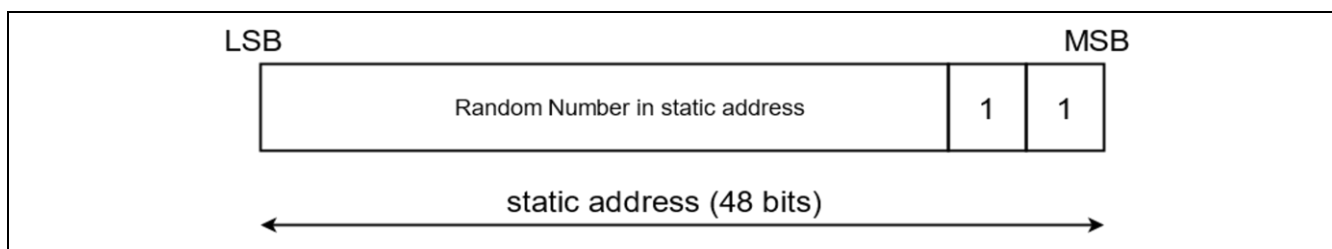

Figure 5.17. Static address format

6. HCI Mode

HCI (Host Controller Interface) mode is firmware for RF characteristics evaluation or BTTS (Bluetooth Test Tool Suite: R01AN4554). Bluetooth LE communication can be performed by sending HCI commands from the host device connected to the serial interface such as a PC to the RX23W microcomputer. HCI event corresponding to Bluetooth LE communication is sent from RX23W to the host device.

HCI mode conforms to Bluetooth Core Spec ver5.0.

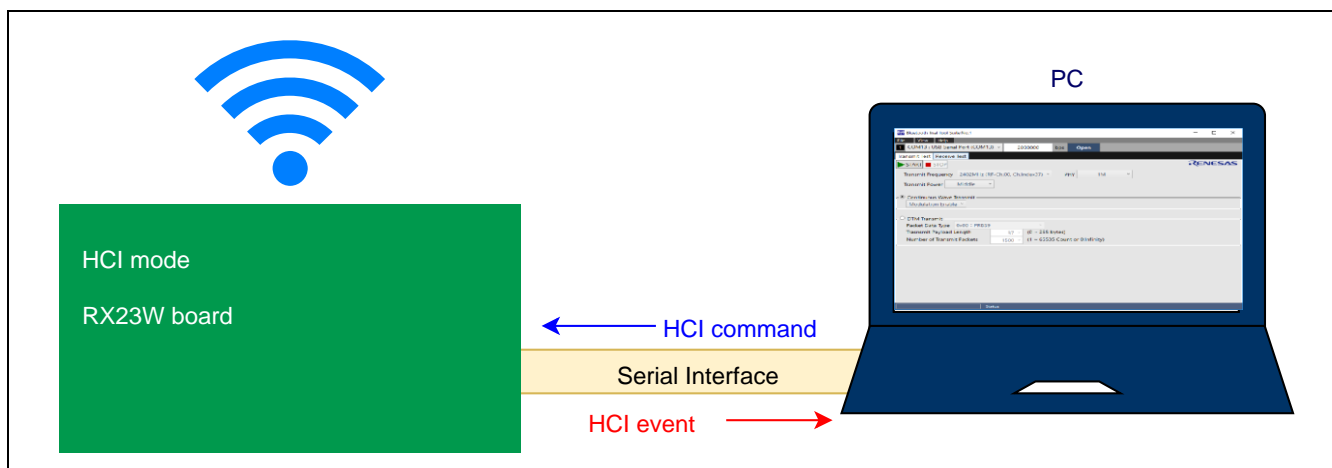

Figure 6.1. HCI mode evaluation board and PC connection

6.1 Software Structure

Figure 6.2 shows the HCI mode software structure.

User applications cannot be implemented in HCI mode.

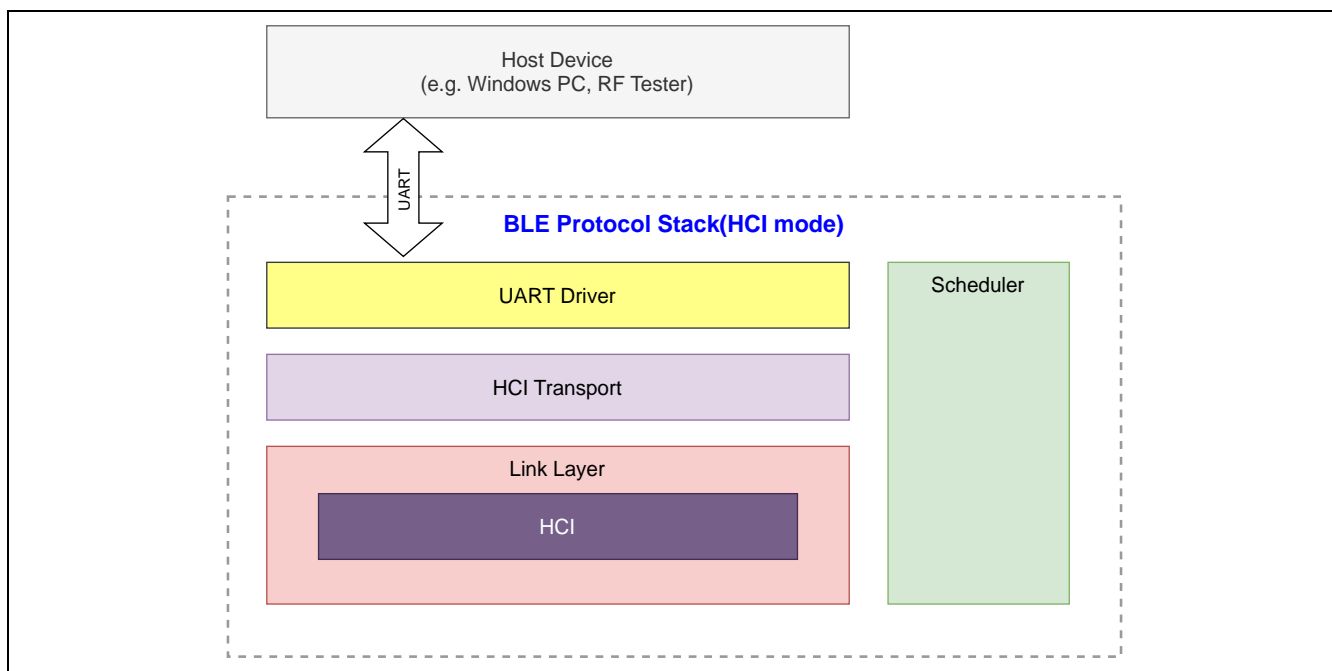

Figure 6.2. HCI mode software structure

6.2 Demo Project

The demo project for HCI mode is included in FITDemos folder of Bluetooth Low Energy Protocol Stack Basic Package. This project can also be used as base project for HCI mode firmware.

Table 6.1 shows sample project in HCI mode.

Table 6.1. Demo project for HCI mode

File Name	Description
ble_demo_rsskrx23w_uart_hci.zip	HCI mode project for RSSK (RX23W 85 pin BGA)
ble_demo_tbrx23w_uart_hci.zip	HCI mode project for Target Board for RX23W (RX23W 56-pin QFN)
ble_demo_tbrx23wmodule_uart_hci.zip	HCI mode project for Target Board for RX23W module (RX23W module 83-pin LGA)

Table 6.2 shows the file contents of demo project for HCI mode.

Table 6.2. Demo project for HCI mode file contents

ble_demo_XXrx23w(module)_uart_hci.zip	XX: rssk or tb
├── .cproject	e ² studio project file
├── .project	e ² studio project file
├── ble_demo_section_rom384kb.esi	Section information file for ROM384KB
├── ble_demo_section_rom512kb.esi	Section information file for ROM512KB
├── ble_demo_XXrx23w_uart_hci.launch	Debug information file
├── ble_demo_XXrx23w_uart_hci.scfg	Smart configurator setting file
├── ble_demo_XXrx23w_profile_client.ewd	IAR debugger configuration file
├── ble_demo_XXrx23w_profile_client.ewp	IAR project file
├── ble_demo_XXrx23w_profile_client.eww	IAR workspace file
├── Inkr5f523w7.icf	IAR R5F23W7xxxx linker configuration file
├── Inkr5f523w8.icf	IAR R5F23W8xxxx linker configuration file
├── ble_demo_uart_hci.rcpc	Renesas common project file
├── src\	
├── app_main.c	HCI mode main code
├── smc_gen\	Code generation folder (contents omitted)
├── uart_hci\	UART driver folder
├── r_ble_dtc.c	DTC control driver source file
├── r_ble_dtc.h	DTC control driver header file
├── r_ble_uart_hci.c	SCI control driver source file
├── r_ble_uart_hci.h	SCI control driver header file

In HCI mode, following files and folders of BLE FIT module need to be excluded from build targets. When creating HCI mode by new project, set following files and folders to be excluded from build targets.

```
src\smc_gen\r_ble_rx23w\src\platform\r_ble_pf_lowpower.c
src\smc_gen\r_ble_rx23w\src\app_lib Note: Exclude entire folder from build
```

- e²studio

As shown in Figure 6.3, right-click relevant file or folder on e² studio, select [Properties], check ON [Exclude resource from build], and click [Apply and Close] button.

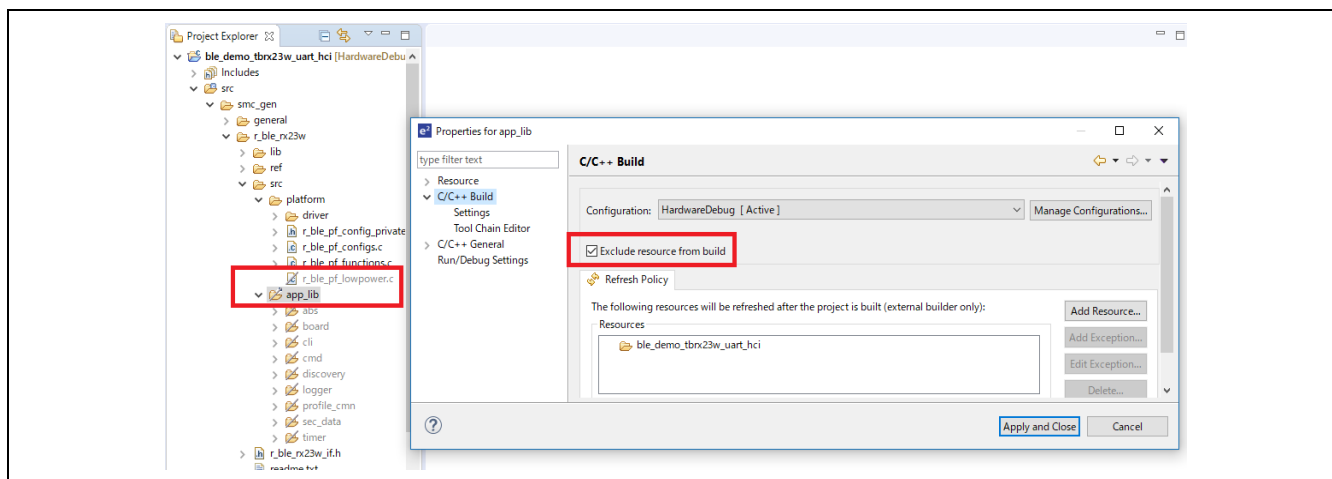

Figure 6.3. excluded from build targets of e² studio

- IAR Embedded Workbench for Renesas RX

As shown in Figure 6.4, right-click relevant file or folder on IAR Embedded Workbench for Renesas RX, select [Options], check ON [Exclude from build], and click [OK] button.

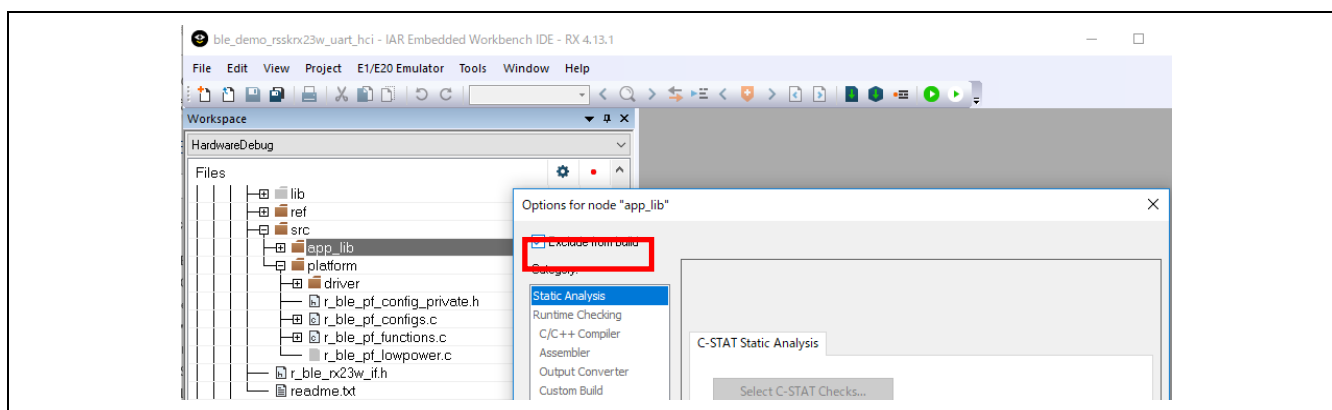

Figure 6.4. excluded from build targets of IAR Embedded Workbench for Renesas RX

In HCI mode, data flash FIT module (r_flash_rx v4.10 or later) is used as an optional function.

6.2.1 Change device type of project

In the demo project, RX23W 512KB device (R5F523W8xxxx) is selected.

This section explains how to change ble_demo_rsskrx23w_uart_hci.zip (R5F523W8AxBL) to BGA384KB device (R5F523W7AxBL).

1. Select [Project]→[Change Device] from the menu.

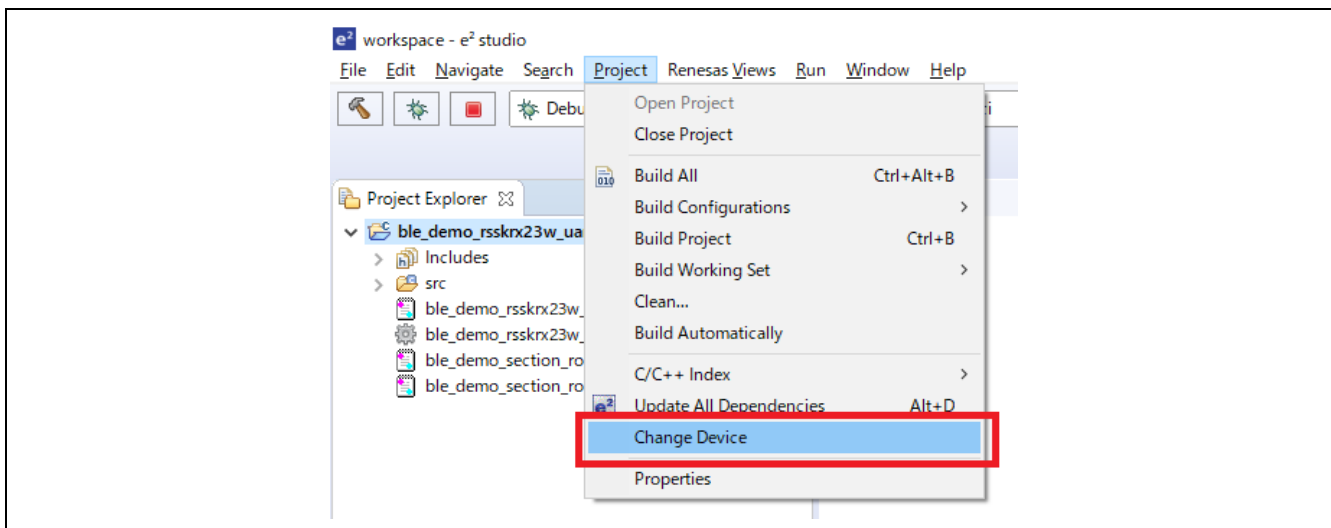

2. Select new RX23W device (85pin R5F523W7AxBL in this example) to be changed and click [Next] button.

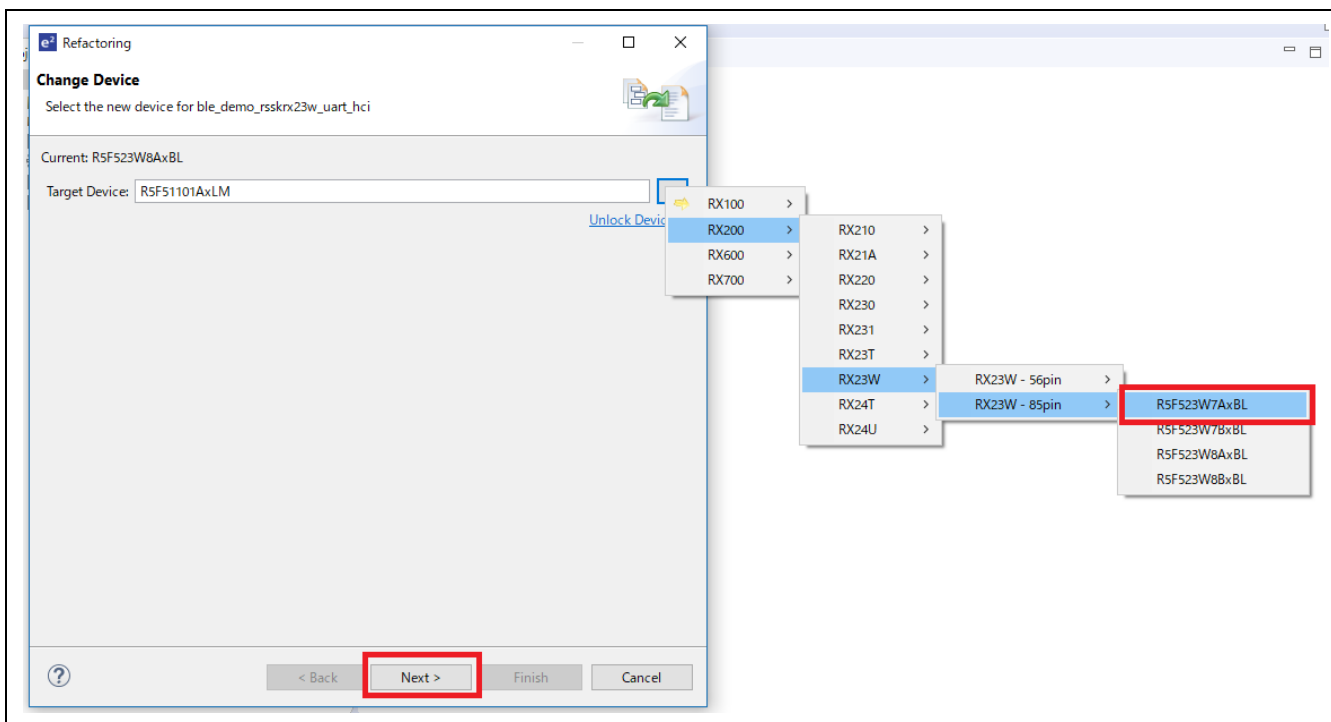

3. Click [Next] button

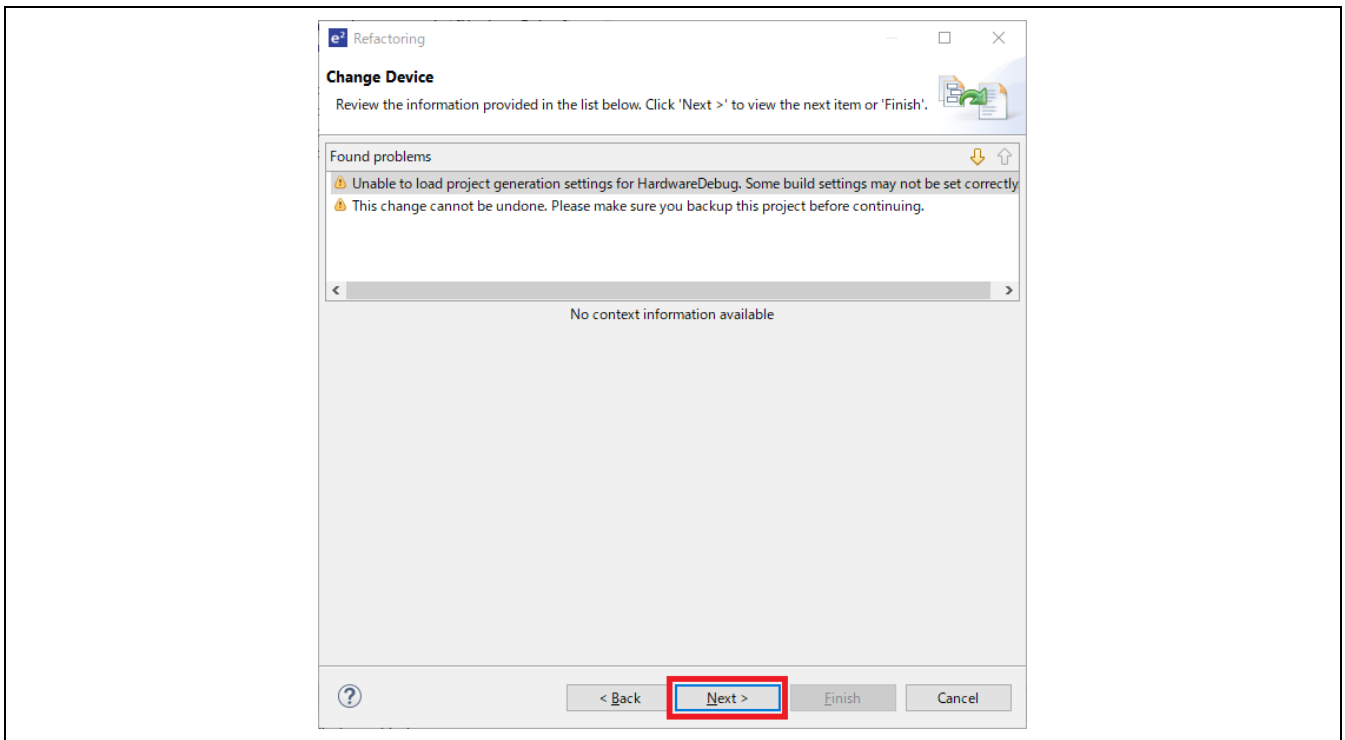

4. Confirm that all items are checked and click [Finish] button.

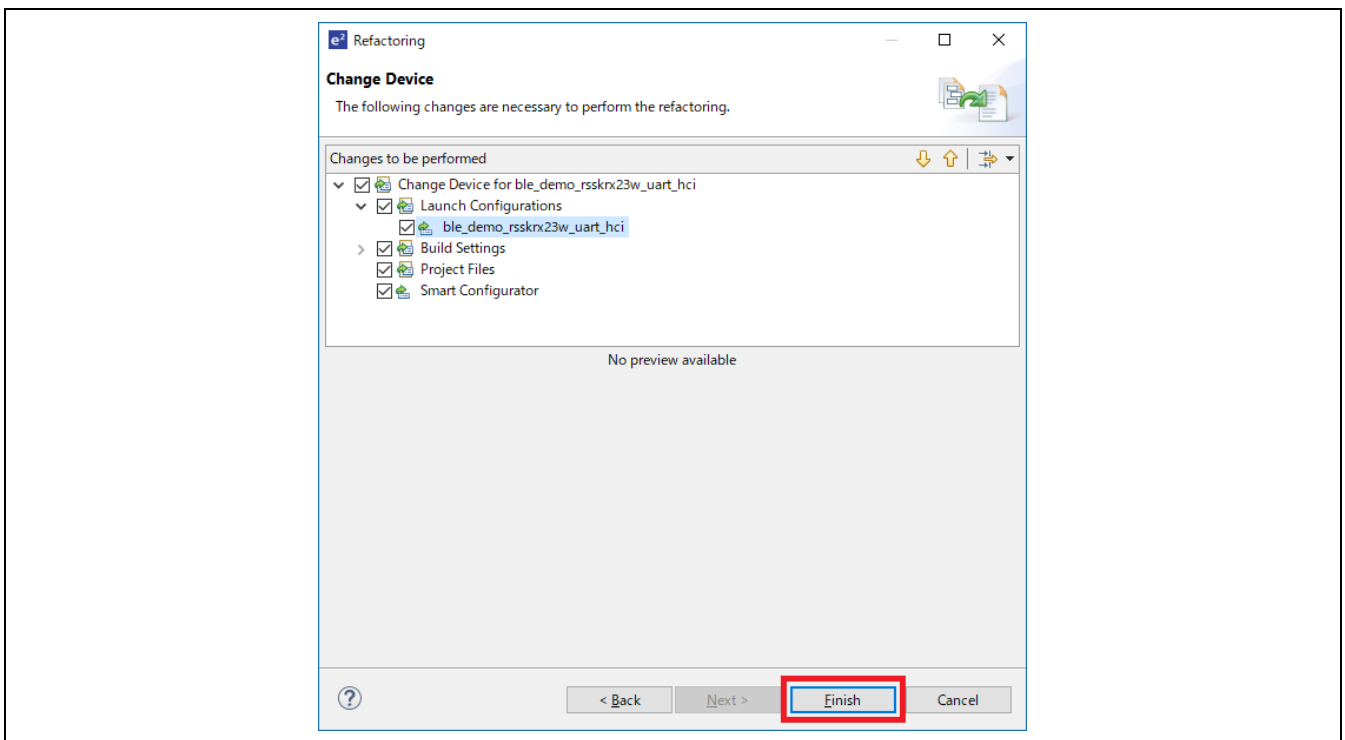

- Click [Generate Code] button in Smart Configurator. Code generation for the modified device is performed.

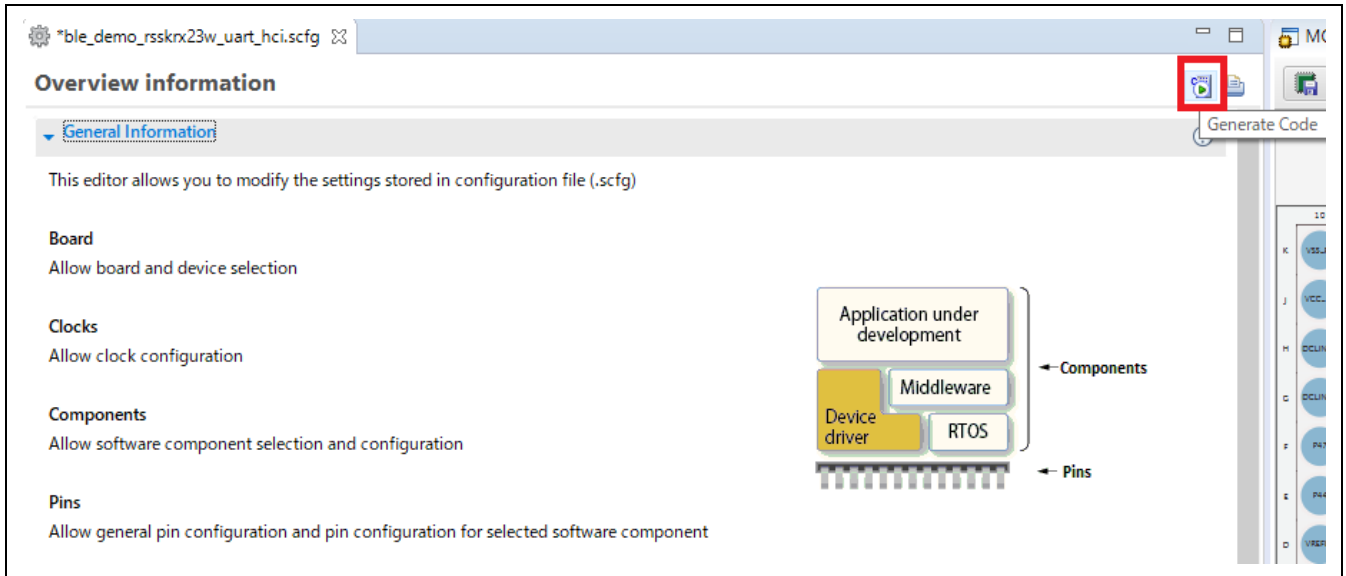

- Click [Linker] → [Section] → [...] button, and click [Import] button, select "ble_demo_section_rom384kb.esi" file, click [Open] button.
 Note: For 512KB devices, select the "ble_demo_section_rom512kb.esi" file.

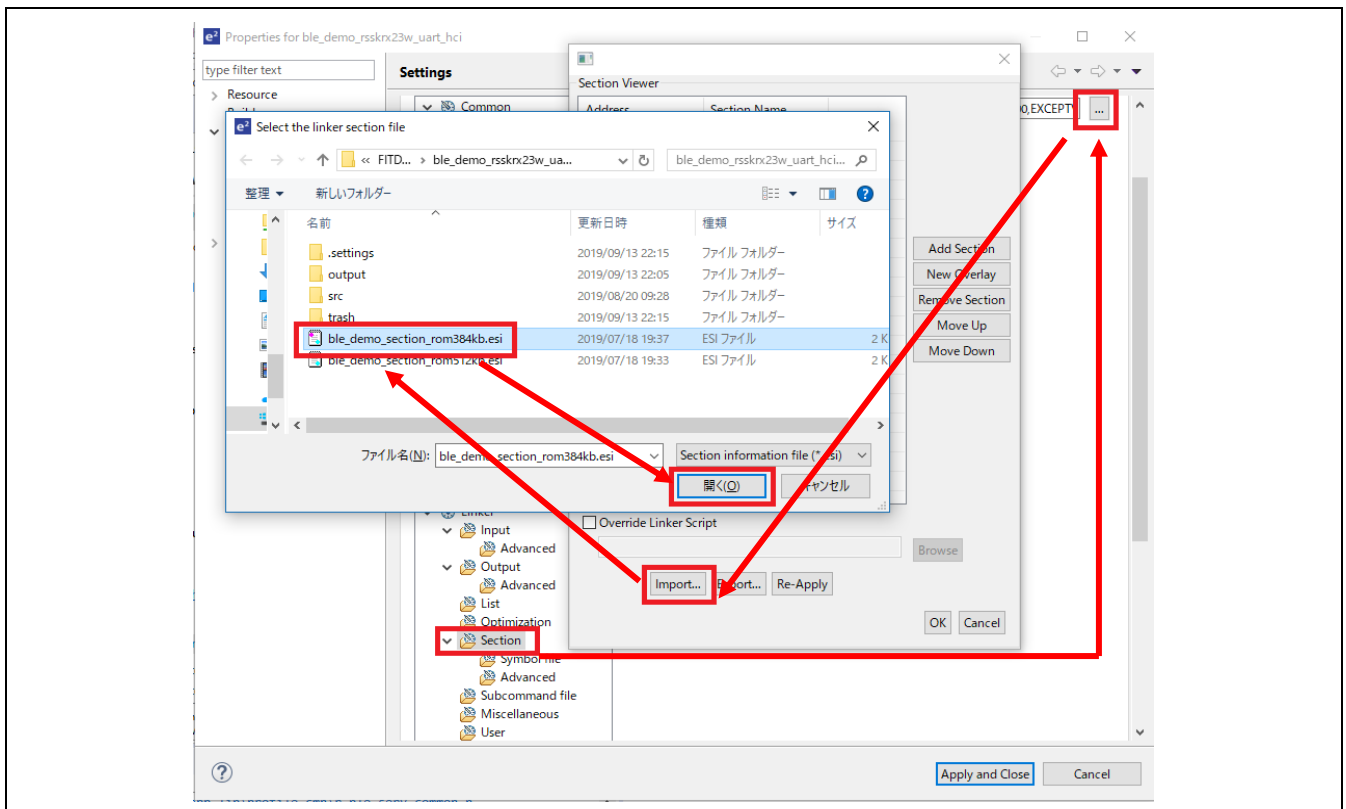

7. Set SCI channel and port number of board environment to be used. Refer to “6.3.1 Configuration Options of UART Driver” for setting details.
8. Build the project. If build error occurs, review each setting.

6.3 UART Driver

In HCI mode, UART (Universal Asynchronous Receiver/Transmitter) communication is performed using RX23W Serial Communication Interface (SCIg, SCIH) and Data Transfer Controller (DTCa) peripheral functions.

In HCI mode, dedicated UART driver is prepared and UART driver APIs are used from Bluetooth LE Protocol Stack.

Table 6.3 shows the UART driver file contents in HCI mode.

Table 6.3. UART driver file contents

File Name	Description
r_ble_dtc.c	DTC control driver source file
r_ble_dtc.h	DTC control driver header file
r_ble_uart_hci.c	SCI control driver source file
r_ble_uart_hci.h	SCI control driver header file *1

*1: When changing the SCI channel, this file needs to edit.

6.3.1 Configuration Options of UART Driver

UART driver can change SCI channel, UART baud rate, etc. by each configuration options in the "r_ble_uart_hci.h" file. Edit this file directly to change configuration options.

For each configuration options, setting location branches depending on the value of BLE_CFG_BOARD_TYPE macro in "r_ble_rx23w_config.h" file.

When setting in customer board environment, set "0" to BLE_CFG_BOARD_TYPE macro.

Table 6.4 outlines UART driver configuration.

Table 6.4. UART driver configuration (when BLE_CFG_BOARD_TYPE is 0)

No.	Macro Name	Default	Description
1	SCI_CHANNEL	1	Set SCI channel number. 1: SCI1 5: SCI5 8: SCI8 12: SCI12
2	SCI_INTR_PRIORITY	14	Sets SCI interrupt priority level. Range: 1 (low priority) to 15 (high priority)
3	SCI_CTS_RTS_EN	1	Sets SCI CTS/RTS function. 0: CTS/RTS disable 1: RTS enable 2: CTS enable
4	SCI_RXD_PIN_X SCI_RXD_PIN_Y	3 0	Set port number used at SCI RXD. Example: P30: X=3, Y=0 PC6: X=C, Y=6
5	SCI_TXD_PIN_X SCI_TXD_PIN_Y	2 6	Set port number used at SCI TXD. Example: P26: X=2, Y=6 PC7: X=C, Y=7
6	SCI_CTS_RTS_PIN_X SCI_CTS_RTS_PIN_Y	3 1	When SCI_CTS_RTS_EN is 1, set port number used at SCI CTS/RTS. Example: P31: X=3, Y=1 PC4: X=C, Y=4
7	DBG_CALC_BAUDRATE	Enable	When this macro is enabled, the register setting value corresponding to UART baudrate is automatically calculated. When this macro is disabled, SCI Bit Rate Register (BRR) and Modulation Duty Register (MDDR) must be set manually.
8	DBG_BAUDRATE_SWITCH	Enable	When this macro is enabled, the input status of the port specified by SCI_BR_SW_PIN_X and SCI_BR_SW_PIN_Y is checked when UART driver is initialized, and the baudrate is switched according to the input level. Input level low: Select D_UART_BR_SWITCH Input level high: Select D_UART_BR
9	D_UART_BR	115200	Sets the initial baudrate when DBG_CALC_BAUDRATE macro is enabled.
10	D_UART_BR_SWITCH	2000000	Sets the baudrate for switching when DBG_CALC_BAUDRATE and DBG_BAUDRATE_SWITCH macros are enabled.
11	SCI_BR_SW_PIN_X SCI_BR_SW_PIN_Y	1 4	Sets the port number to check the input level when the DBG_CALC_BAUDRATE and DBG_BAUDRATE_SWITCH macros are enabled. Example: P14, X=1, Y=4

7. Appendix

7.1 Firmware writing procedure for Target Board for RX23W (retaining device-specific data)

This section describes how to write firmware program files (mot files, etc.) created by building to the RX23W device using Renesas Flash Programmer (hereinafter referred to as RFP).

Note: Use RFP v3.06.00 or later.

The following shows the procedure for writing firmware while retaining device-specific data by RFP for Target Board for RX23W (hereinafter referred to as TB). In order to retain device-specific data, it is prerequisite that firmware with ID code protection enabled is already written.

1. Switch ESW1-2 dip-switch on the TB to "ON" side and connect Windows PC and ECN1 connector with USB A-microB cable.

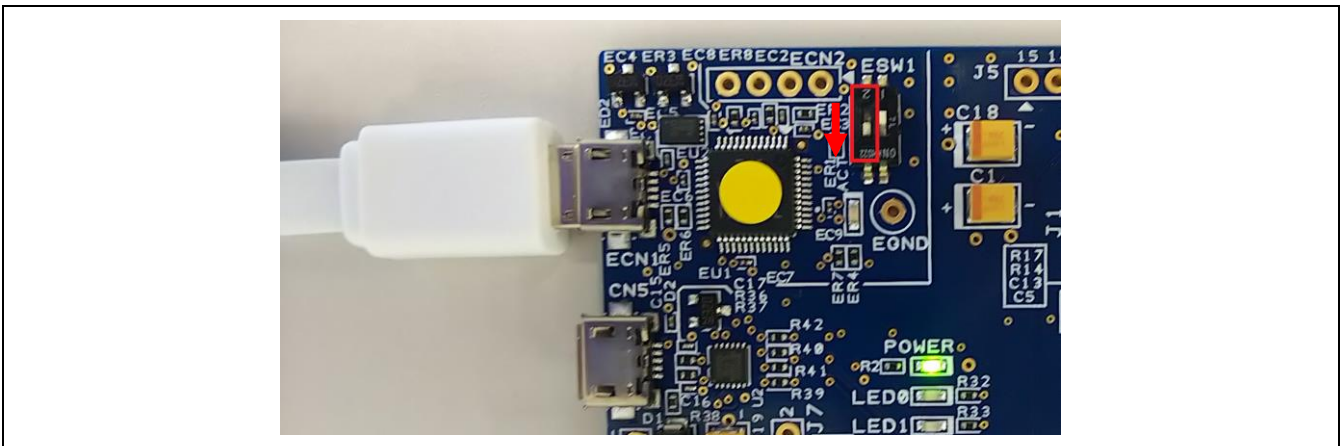

2. Start RFP and select [File] → [New Project].

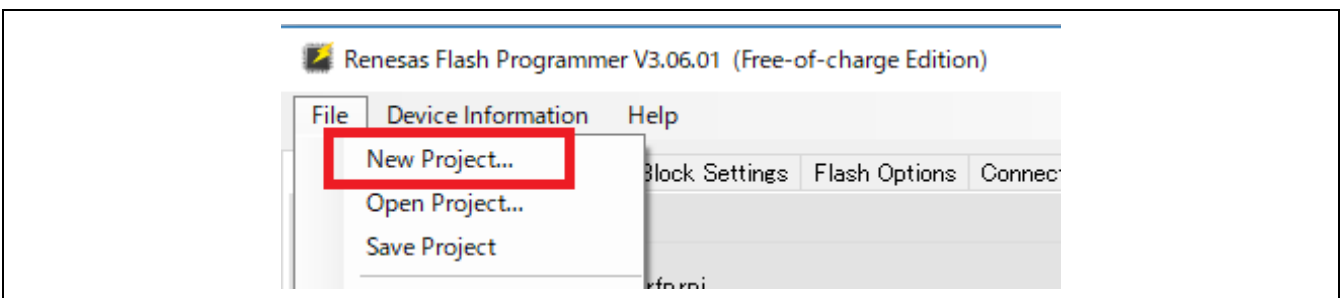

- In [Create New Project] window, make following settings and click [Connect] button.
 - Microcontroller: RX200
 - Project Name: Input any project name
 - Project Folder: Select any folder
 - Communication Tool: Select "E2 emulator Lite", Interface: Select "FINE"
 - Power: Select "None" (Selected by default)

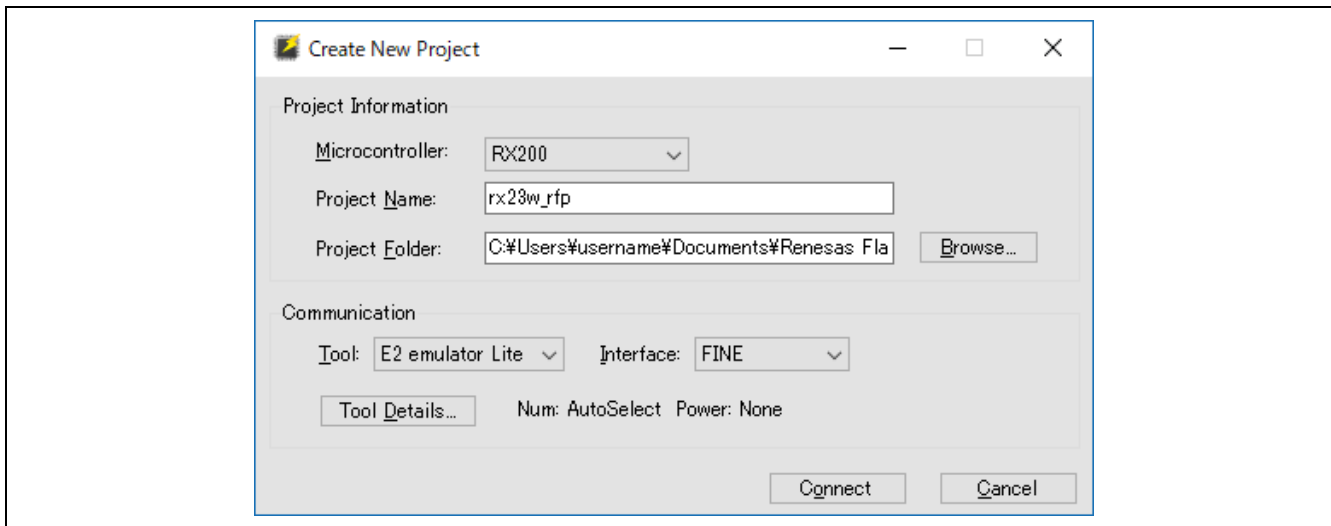

- If firmware with valid ID protection code is written, user will be prompted to input ID Code in [Set ID Code] window. In that case, input ID code that has been written and click [OK] button. Example here, ID code "45FFFFFFFFFFFFFFFFFFFFFFFFFFFFFFFF" is input. If the user has changed ID code, input an appropriate value.

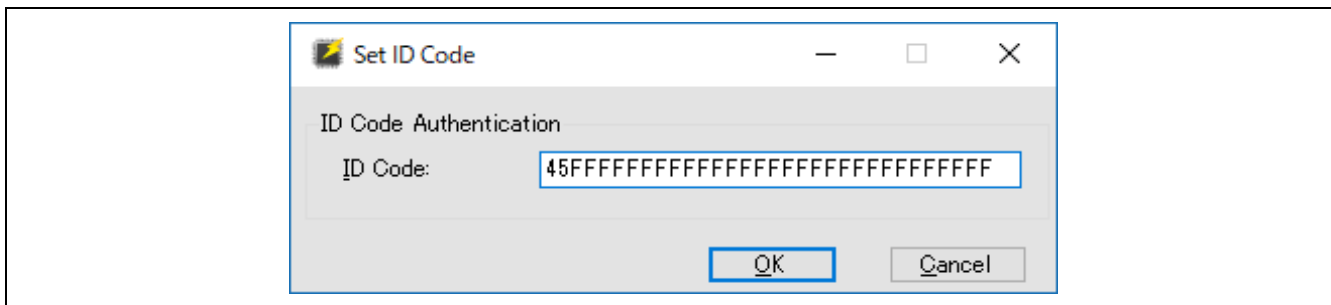

5. If the connection is successful, “**Operation completed.**” is displayed.

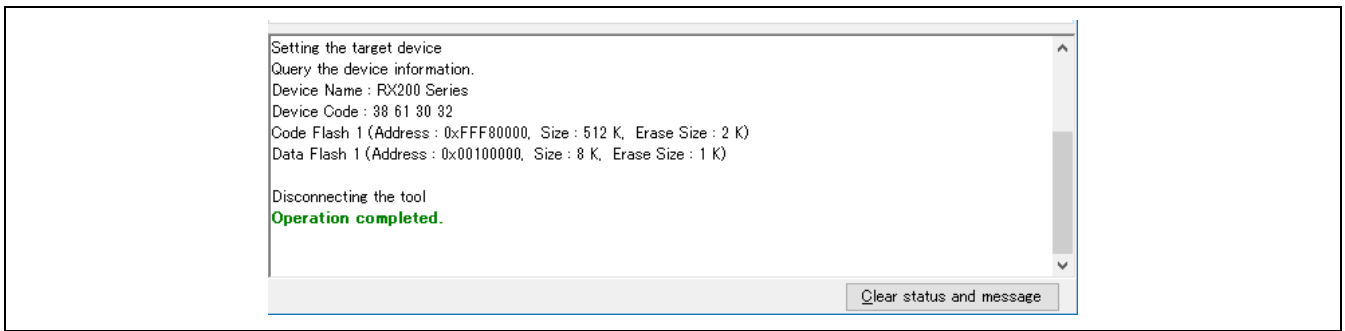

6. Click [Browse] button → Select program file (e.g. mot file) → Click [Open] button.

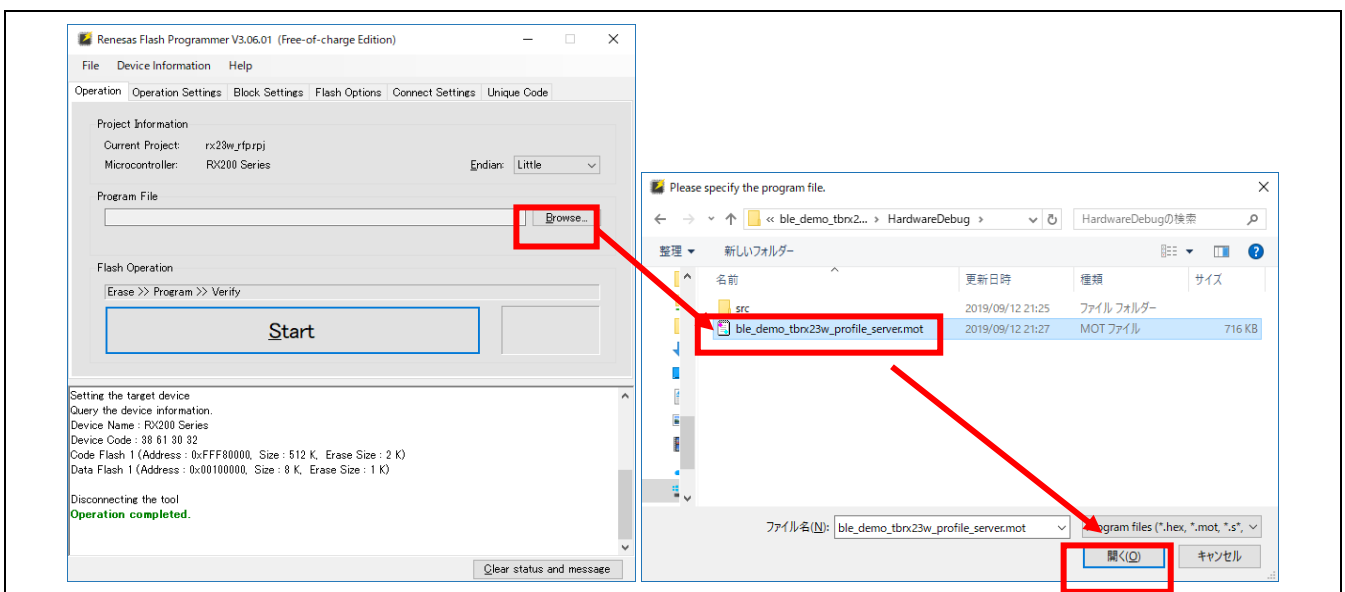

7. In [Block Settings] tab, set the following so that the device-specific data already written is not erased.
 - User area (ROM): Turn OFF [Erase] and [P.V] check box for the block specified in BLE_CFG_DEV_DATA_CF_BLOCK (Block 16 in the example)

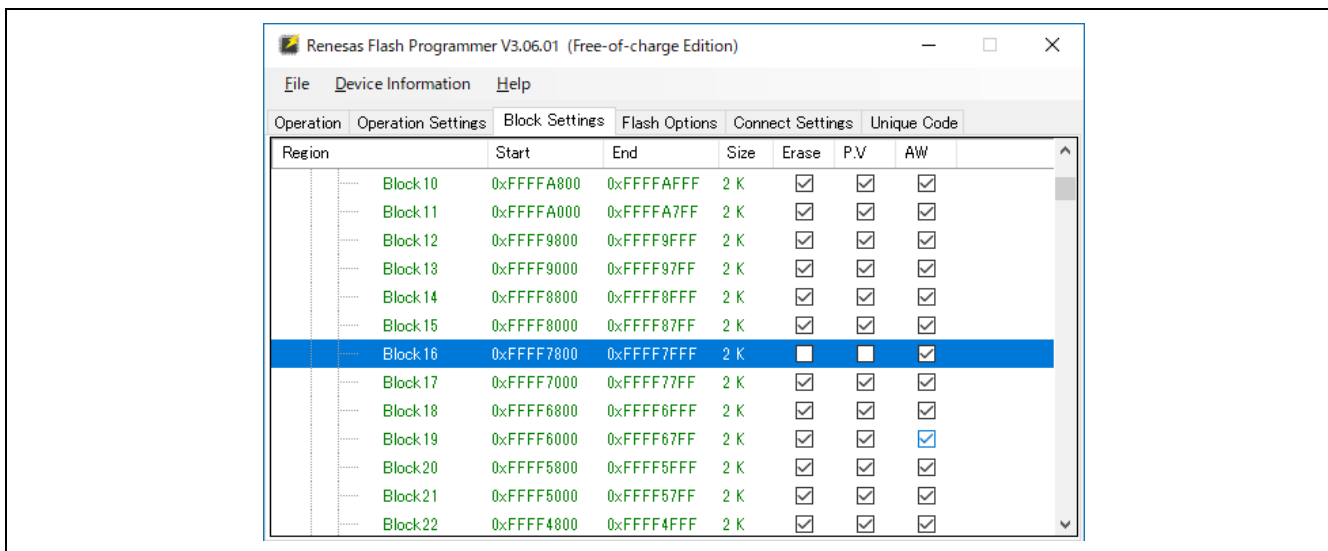

Note: When this check box is turned OFF, unique code writing to specified block cannot be performed. If user want to write a unique code to the specified block, change these check box to ON.

- Data area (E2 DataFlash): Turn OFF [Erase] and [P.V] check box for all Data Flash blocks.

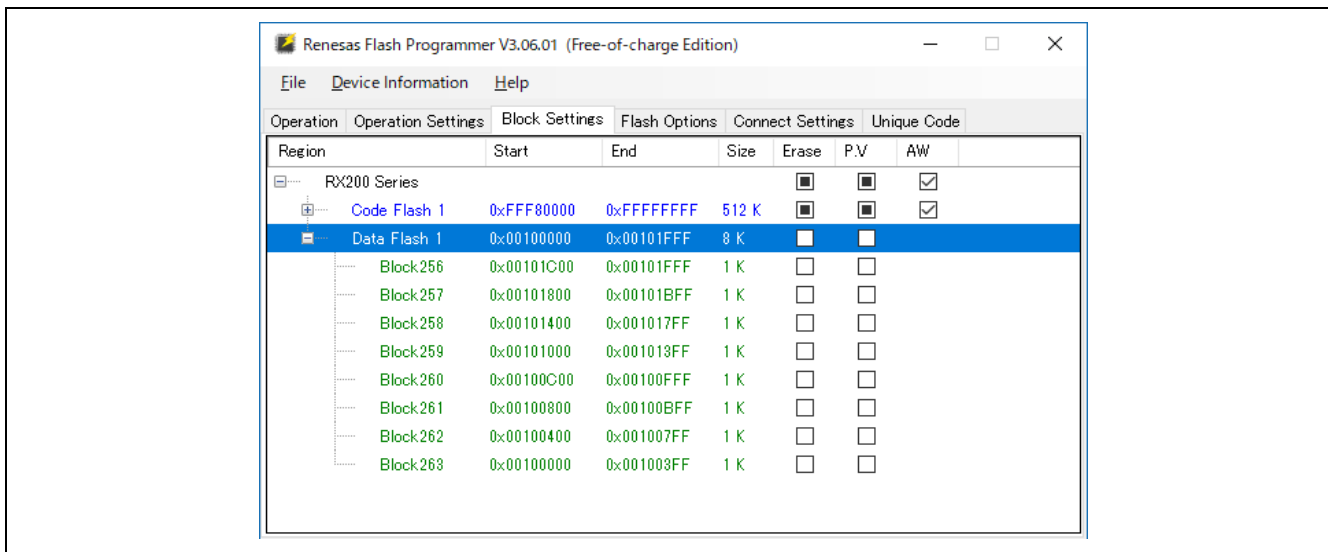

- In [Operation Settings] tab, select "Erase Selected Blocks" in [Erase Options] combo box. (Selected by default)

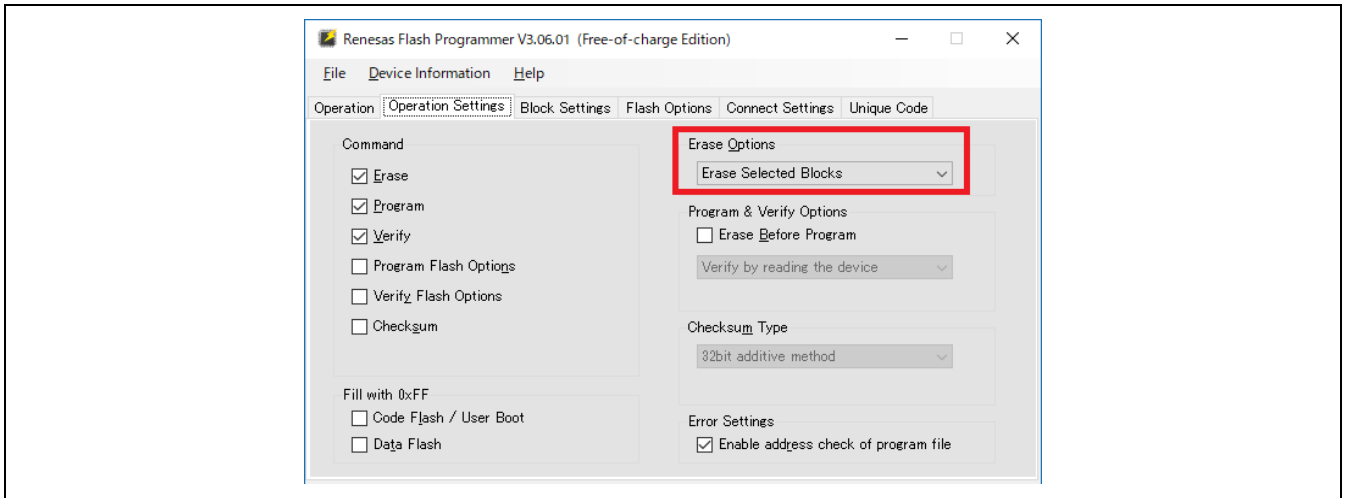

- Click [Start] button in [Operation] tab to start writing the firmware.

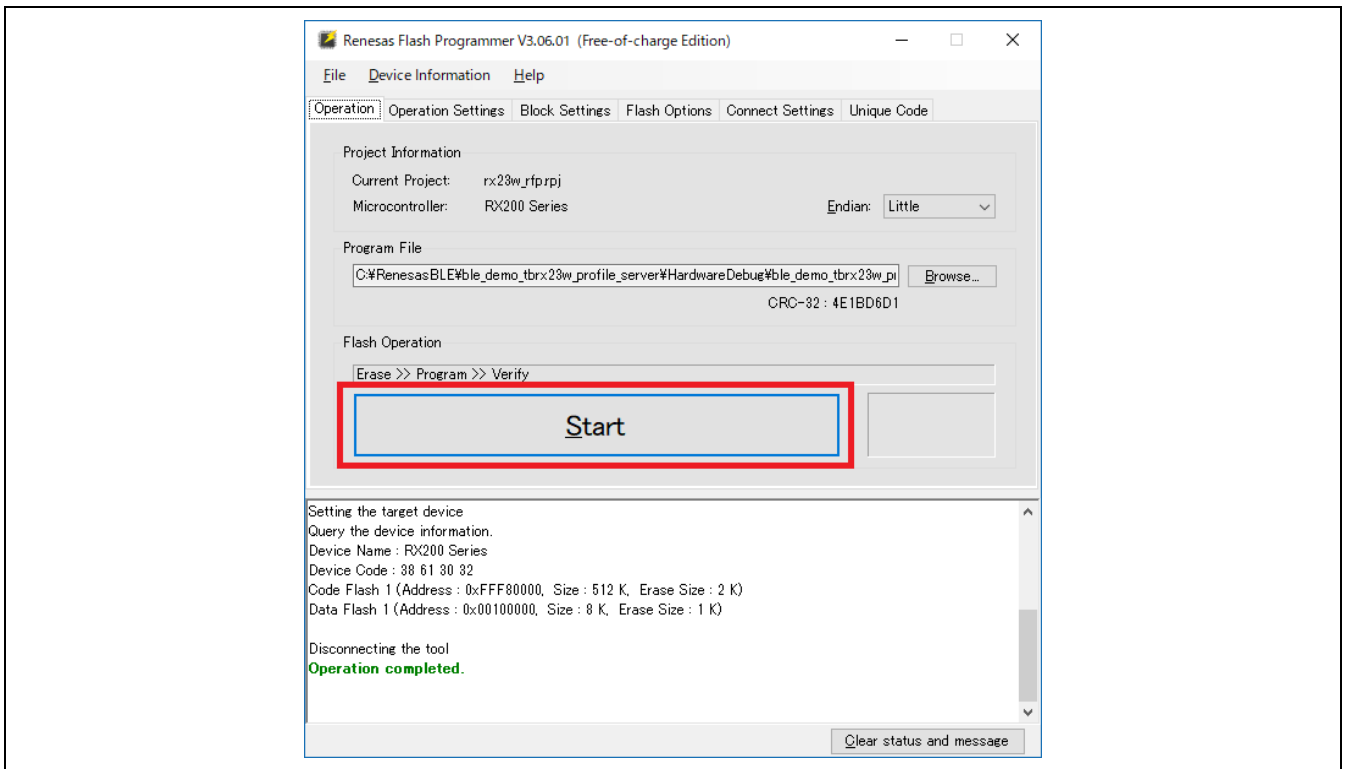

10. When the firmware has been successful written, “**Operation completed.**” and “**OK**” are displayed.

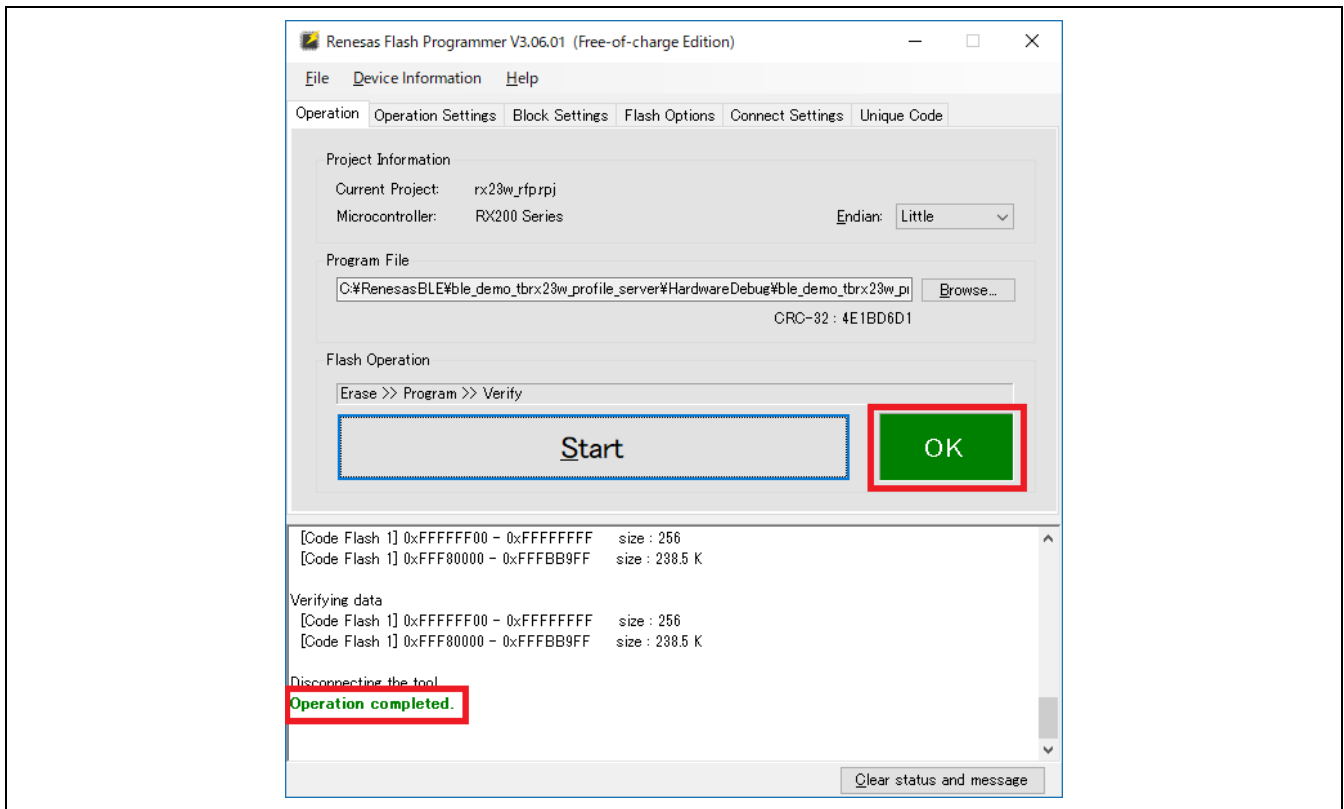

Note: If "[W0000009]: ID code is disabled." is displayed in the message area when writing, all blocks in the flash memory will be erased once and device-specific data will also be deleted. In this case, it is necessary to write device-specific data again.

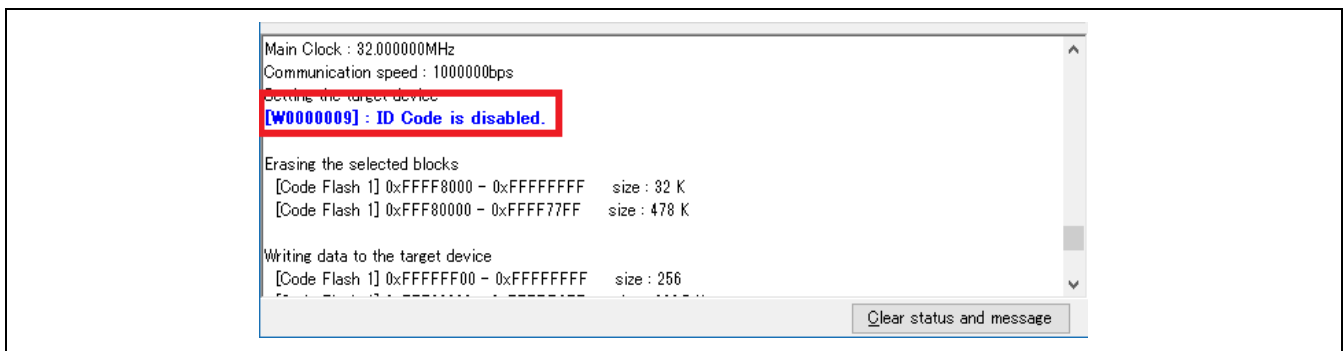

Revision History	Bluetooth Low Energy Protocol Stack Basic Package User's Manual
------------------	---

Rev.	Date	Description	
		Page	Summary
1.00	Oct.31.2019	—	First Edition issued
1.01	Jan.27.2020	3	Added "ROM_Files" to Table 2.1.
		4	Added "IAR environment" to Table 2.3.
		5	Added "2.3.2.2 IAR Embedded Workbench for Renesas RX demo project".
		15-22	Updated Table 4.1 configuration options with changes in the BLE FIT module v1.10.
		67	Added "5.1.1.4 BLE command".
		93	Added files for IAR Embedded Workbench for Renesas RX to table 6.2.
		94	Added "exclusion from build" on IAR Embedded Workbench for Renesas RX.
		107	Added "7.2 Connection Parameter Update Response".
1.02	Sep.30.2020	3	Added how to get the package to "2.1 Package Contents".
		5	Added "2.2 Project Configuration".
		6	Modified "IAR environment" description in "Table 2.3".
		16	Added "3.2.7 LED and Switch Control" and "3.2.8 BLE Task Control"
		60	Added "(6) Scan Channel command" to 5.1.2 Vendor Specific (VS) command.
		73	Corrected the parameter value error in the "Notification callback function for RF sleep mode start/wakeup event" in Table 5.17.
		79	Added note about Random BD address to be generated.
		-	Moved the followings to "RX23W Group Bluetooth Low Energy Application Developer's Guide (R01AN5504)". 4.3 Board LED and Push-Switch setting 4.4 MCU Low Power setting 5.1.2 Command creation procedure 5.2 Logger 5.3 Software Timer 7.2 Connection Parameter Update Response
1.03	2021.3.30	-	- Support RX23W module (R5F523W8CxLN, R5F523W8DxLN).
		4	- Add the FITDemos for RX23W module to Table 2.1.
		6	- Add Target Board for RX23W module to Table 2.3. - Add e ² studio 2021_01 to Table 2.4.
		20	- Add BLE_CFG_RF_CLVAL value when selecting RX23W module. - Add BLE_CFG_RF_DDC_EN value when using Target Board.
		34	- Add (addr_type) and (-wl) to Advertising command. - Removed API parameter description and changed to reference to API documentation.
		35	- Add (addr_type) and (-wl) to Scan command. - Removed API parameter description and changed to reference to API documentation.

Rev.	Date	Description	
		Page	Summary
1.03	2021.3.30	36	- Add (own_addr_type), (dummy_irk) and (-wl) to Connection command. - Removed API parameter description and changed to reference to API documentation.
		38	- Add "remove", "get" and "off" to Privacy command.
		72	- Add the HCI mode project for Target Board for RX23W module to Table 6.1.
1.04	2021.6.30	6	- Change the e ² studio (64bit) version in Table 2.4 to 2021_04.
		72	- Added the rcpc file to Table 6.2.
2.30	2021.10.15	-	- Changed the version along the BLE FIT version.
		21	- Fixed the BLE_CFG_MCU_MAIN_CLK_KHZ range in Table 4.1 when using PLL Circuit.
2.31	2022.4.15	3	- Changed the URL to Bluetooth Low Energy Protocol Stack Basic Package .
		5	- Deleted "ref" directory in Table 2.2. - Changed the project structure for QE for BLE v1.40 or later.
		6	- Deleted "e ² studio v7.8 (32bit)" from Table 2.4. - Deleted "download from e ² studio installer" from Table 2.4.
		17	- Modified the description of BLE_CFG_RF_CONN_MAX.
		22	- Modified the description of BLE_CFG_NUM_BOND.
		76	- Deleted the description about library name reset in HCI project.
2.40	2022.6.30	16	- Added "Do not change the Abstraction API codes."
2.50	2022.12.27	-	- Added the description that Profile Common is not included in the BLE FIT v2.50 or later and is provided by QE for BLE (V1.6.0).
		56-60	- Modified Figure 5.2, 5.3, 5.5 and Table 5.5-5.7.
2.60	2024.05.17	6	- The e ² studio version has been updated to 2024.01-1 due to the revision of BLE FIT v2.60.
		7	- Updated the description of how to add the FIT module.

Bluetooth Low Energy Protocol Stack Basic Package
User's Manual

Publication Date: Rev.2.60 May.17.2024

Published by: Renesas Electronics Corporation

Bluetooth Low Energy Protocol Stack Basic Package

