

To our customers,

Old Company Name in Catalogs and Other Documents

On April 1st, 2010, NEC Electronics Corporation merged with Renesas Technology Corporation, and Renesas Electronics Corporation took over all the business of both companies. Therefore, although the old company name remains in this document, it is a valid Renesas Electronics document. We appreciate your understanding.

Renesas Electronics website: <http://www.renesas.com>

April 1st, 2010
Renesas Electronics Corporation

Issued by: Renesas Electronics Corporation (<http://www.renesas.com>)

Send any inquiries to <http://www.renesas.com/inquiry>.

Notice

1. All information included in this document is current as of the date this document is issued. Such information, however, is subject to change without any prior notice. Before purchasing or using any Renesas Electronics products listed herein, please confirm the latest product information with a Renesas Electronics sales office. Also, please pay regular and careful attention to additional and different information to be disclosed by Renesas Electronics such as that disclosed through our website.
2. Renesas Electronics does not assume any liability for infringement of patents, copyrights, or other intellectual property rights of third parties by or arising from the use of Renesas Electronics products or technical information described in this document. No license, express, implied or otherwise, is granted hereby under any patents, copyrights or other intellectual property rights of Renesas Electronics or others.
3. You should not alter, modify, copy, or otherwise misappropriate any Renesas Electronics product, whether in whole or in part.
4. Descriptions of circuits, software and other related information in this document are provided only to illustrate the operation of semiconductor products and application examples. You are fully responsible for the incorporation of these circuits, software, and information in the design of your equipment. Renesas Electronics assumes no responsibility for any losses incurred by you or third parties arising from the use of these circuits, software, or information.
5. When exporting the products or technology described in this document, you should comply with the applicable export control laws and regulations and follow the procedures required by such laws and regulations. You should not use Renesas Electronics products or the technology described in this document for any purpose relating to military applications or use by the military, including but not limited to the development of weapons of mass destruction. Renesas Electronics products and technology may not be used for or incorporated into any products or systems whose manufacture, use, or sale is prohibited under any applicable domestic or foreign laws or regulations.
6. Renesas Electronics has used reasonable care in preparing the information included in this document, but Renesas Electronics does not warrant that such information is error free. Renesas Electronics assumes no liability whatsoever for any damages incurred by you resulting from errors in or omissions from the information included herein.
7. Renesas Electronics products are classified according to the following three quality grades: “Standard”, “High Quality”, and “Specific”. The recommended applications for each Renesas Electronics product depends on the product’s quality grade, as indicated below. You must check the quality grade of each Renesas Electronics product before using it in a particular application. You may not use any Renesas Electronics product for any application categorized as “Specific” without the prior written consent of Renesas Electronics. Further, you may not use any Renesas Electronics product for any application for which it is not intended without the prior written consent of Renesas Electronics. Renesas Electronics shall not be in any way liable for any damages or losses incurred by you or third parties arising from the use of any Renesas Electronics product for an application categorized as “Specific” or for which the product is not intended where you have failed to obtain the prior written consent of Renesas Electronics. The quality grade of each Renesas Electronics product is “Standard” unless otherwise expressly specified in a Renesas Electronics data sheets or data books, etc.
 - “Standard”: Computers; office equipment; communications equipment; test and measurement equipment; audio and visual equipment; home electronic appliances; machine tools; personal electronic equipment; and industrial robots.
 - “High Quality”: Transportation equipment (automobiles, trains, ships, etc.); traffic control systems; anti-disaster systems; anti-crime systems; safety equipment; and medical equipment not specifically designed for life support.
 - “Specific”: Aircraft; aerospace equipment; submersible repeaters; nuclear reactor control systems; medical equipment or systems for life support (e.g. artificial life support devices or systems), surgical implantations, or healthcare intervention (e.g. excision, etc.), and any other applications or purposes that pose a direct threat to human life.
8. You should use the Renesas Electronics products described in this document within the range specified by Renesas Electronics, especially with respect to the maximum rating, operating supply voltage range, movement power voltage range, heat radiation characteristics, installation and other product characteristics. Renesas Electronics shall have no liability for malfunctions or damages arising out of the use of Renesas Electronics products beyond such specified ranges.
9. Although Renesas Electronics endeavors to improve the quality and reliability of its products, semiconductor products have specific characteristics such as the occurrence of failure at a certain rate and malfunctions under certain use conditions. Further, Renesas Electronics products are not subject to radiation resistance design. Please be sure to implement safety measures to guard them against the possibility of physical injury, and injury or damage caused by fire in the event of the failure of a Renesas Electronics product, such as safety design for hardware and software including but not limited to redundancy, fire control and malfunction prevention, appropriate treatment for aging degradation or any other appropriate measures. Because the evaluation of microcomputer software alone is very difficult, please evaluate the safety of the final products or system manufactured by you.
10. Please contact a Renesas Electronics sales office for details as to environmental matters such as the environmental compatibility of each Renesas Electronics product. Please use Renesas Electronics products in compliance with all applicable laws and regulations that regulate the inclusion or use of controlled substances, including without limitation, the EU RoHS Directive. Renesas Electronics assumes no liability for damages or losses occurring as a result of your noncompliance with applicable laws and regulations.
11. This document may not be reproduced or duplicated, in any form, in whole or in part, without prior written consent of Renesas Electronics.
12. Please contact a Renesas Electronics sales office if you have any questions regarding the information contained in this document or Renesas Electronics products, or if you have any other inquiries.

(Note 1) “Renesas Electronics” as used in this document means Renesas Electronics Corporation and also includes its majority-owned subsidiaries.

(Note 2) “Renesas Electronics product(s)” means any product developed or manufactured by or for Renesas Electronics.



User's Manual

QB-V850EIA4

In-Circuit Emulator

Target Devices

V850ES/IK1

V850E/IA3

V850E/IA4

Document No. U17167EJ4V0UM00 (4th edition)
Date Published September 2007 NS

© NEC Electronics Corporation 2004
Printed in Japan

[MEMO]

IECUBE is a registered trademark of NEC Electronics Corporation in Japan and Germany.

MULTI, Green Hills Software, TimeMachine, and SuperTrace are trademarks of Green Hills Software, Inc.

- **The information in this document is current as of September, 2007. The information is subject to change without notice. For actual design-in, refer to the latest publications of NEC Electronics data sheets or data books, etc., for the most up-to-date specifications of NEC Electronics products. Not all products and/or types are available in every country. Please check with an NEC Electronics sales representative for availability and additional information.**

- No part of this document may be copied or reproduced in any form or by any means without the prior written consent of NEC Electronics. NEC Electronics assumes no responsibility for any errors that may appear in this document.

- NEC Electronics does not assume any liability for infringement of patents, copyrights or other intellectual property rights of third parties by or arising from the use of NEC Electronics products listed in this document or any other liability arising from the use of such products. No license, express, implied or otherwise, is granted under any patents, copyrights or other intellectual property rights of NEC Electronics or others.

- Descriptions of circuits, software and other related information in this document are provided for illustrative purposes in semiconductor product operation and application examples. The incorporation of these circuits, software and information in the design of a customer's equipment shall be done under the full responsibility of the customer. NEC Electronics assumes no responsibility for any losses incurred by customers or third parties arising from the use of these circuits, software and information.

- While NEC Electronics endeavors to enhance the quality, reliability and safety of NEC Electronics products, customers agree and acknowledge that the possibility of defects thereof cannot be eliminated entirely. To minimize risks of damage to property or injury (including death) to persons arising from defects in NEC Electronics products, customers must incorporate sufficient safety measures in their design, such as redundancy, fire-containment and anti-failure features.

- NEC Electronics products are classified into the following three quality grades: "Standard", "Special" and "Specific".

The "Specific" quality grade applies only to NEC Electronics products developed based on a customer-designated "quality assurance program" for a specific application. The recommended applications of an NEC Electronics product depend on its quality grade, as indicated below. Customers must check the quality grade of each NEC Electronics product before using it in a particular application.

"Standard": Computers, office equipment, communications equipment, test and measurement equipment, audio and visual equipment, home electronic appliances, machine tools, personal electronic equipment and industrial robots.

"Special": Transportation equipment (automobiles, trains, ships, etc.), traffic control systems, anti-disaster systems, anti-crime systems, safety equipment and medical equipment (not specifically designed for life support).

"Specific": Aircraft, aerospace equipment, submersible repeaters, nuclear reactor control systems, life support systems and medical equipment for life support, etc.

The quality grade of NEC Electronics products is "Standard" unless otherwise expressly specified in NEC Electronics data sheets or data books, etc. If customers wish to use NEC Electronics products in applications not intended by NEC Electronics, they must contact an NEC Electronics sales representative in advance to determine NEC Electronics' willingness to support a given application.

(Note)

(1) "NEC Electronics" as used in this statement means NEC Electronics Corporation and also includes its majority-owned subsidiaries.

(2) "NEC Electronics products" means any product developed or manufactured by or for NEC Electronics (as defined above).

M8E 02.11-1

General Precautions for Handling This Product

1. Circumstances not covered by product guarantee

- If the product was disassembled, altered, or repaired by the customer
- If it was dropped, broken, or given another strong shock
- Use at overvoltage, use outside guaranteed temperature range, storing outside guaranteed temperature range
- If power was turned on while connection to the AC adapter, USB interface cable, or target system was in an unsatisfactory state
- If the cable of the AC adapter, the USB interface cable, the emulation probe, or the like was bent or pulled excessively
- If an AC adapter other than the supplied product was used
- If the product got wet
- If this product is connected to the target system when there is a potential difference between the GND of this product and GND of the target system.
- If the connectors or cables are plugged/unplugged while this product is in the power-on state.
- If excessive load is applied to the connectors or sockets.

2. Safety precautions

- If used for a long time, the product may become hot (50°C to 60°C). Be careful of low temperature burns and other dangers due to the product becoming hot.
- Be careful of electrical shock. There is a danger of electrical shock if the product is used as described above in **1 Circumstances not covered by product guarantee**.
- The AC adapter supplied with the product is exclusively for this product, so do not use it with other products.

INTRODUCTION

Readers	This manual is intended for users who wish to perform debugging using the QB-V850EIA4. The readers of this manual are assumed to be familiar with the device functions and usage, and to have knowledge of debuggers.	
Purpose	This manual is intended to give users an understanding of the basic specifications and correct usage of the QB-V850EIA4.	
Organization	This manual is divided into the following sections. <ul style="list-style-type: none">• General• Setup procedure• Settings at product shipment• Notes• Optional functions	
How to Read This Manual	<p>It is assumed that the readers of this manual have general knowledge in the fields of electrical engineering, logic circuits, and microcontrollers.</p> <p>This manual describes the basic setup procedures and how to set switches.</p> <p>To understand the overall functions and usages of the QB-V850EIA4</p> <p>→Read this manual according to the CONTENTS. The mark “<R>” shows major revised points. The revised points can be easily searched by copying an “<R>” in the PDF file and specifying it in the “Find what:” field.</p> <p>To know the manipulations, command functions, and other software-related settings of the QB-V850EIA4</p> <p>→See the user’s manual of the debugger (supplied with the QB-V850EIA4) to be used.</p>	
Conventions	Note:	Footnote for item marked with Note in the text
	Caution:	Information requiring particular attention
	Remark:	Supplementary information
	Numeric representation:	Binary ... xxxx or xxxxB Decimal ... xxxx Hexadecimal ... xxxxH
	Prefix indicating power of 2 (address space, memory capacity):	K (kilo): $2^{10} = 1,024$ M (mega): $2^{20} = 1,024^2$

Terminology

The meanings of the terms used in this manual are described in the table below.

Term	Meaning
Target device	This is the device to be emulated.
Target system	This is the system to be debugged (system provided by the user). This includes the target program and the hardware provided by the user.
IECUBE™	Generic name for NEC Electronics' high-performance/compact in-circuit emulator.

Related Documents

Please use the following documents in combination with this manual.

The related documents listed below may include preliminary versions. However, preliminary versions are not marked as such.

Documents Related to Development Tools (User's Manuals)

Document Name	Document Number	
QB-V850EIA4 (in-circuit emulator)	This manual	
CA850 Ver. 3.00 C Compiler Package	Operation	U17293E
	C Language	U17291E
	Assembly Language	U17292E
	Link Directives	U17294E
ID850QB Ver. 3.40 Integrated Debugger	Operation	U18604E
SM+ System Simulator	Operation	U18010E
	User Open Interface	U17663E
RX850 Ver. 3.20 Real-Time OS	Basics	U13430E
	Installation	U17419E
	Technical	U13431E
	Task Debugger	U17420E
RX850 Pro Ver. 3.20 Real-Time OS	Basics	U13773E
	Installation	U17421E
	Technical	U13772E
	Task Debugger	U17422E
AZ850 Ver. 3.30 System Performance Analyzer	U17423E	
PM+ Ver. 6.00 Project Manager	U17178E	

Caution The related documents listed above are subject to change without notice. Be sure to use the latest version of each document for designing, etc.

CONTENTS

CHAPTER 1 GENERAL	9
1.1 Hardware Specifications	10
1.2 System Specifications	11
1.3 System Configuration	12
1.4 Package Contents	15
CHAPTER 2 SETUP PROCEDURE	17
2.1 Names and Functions of Hardware	18
2.2 Removal of Acrylic Board	20
2.3 Clock Settings	20
2.3.1 Overview of clock settings	20
2.3.2 Clock setting methods	21
2.3.3 Notes on changing resonators	22
2.3.4 Notes on using oscillator	23
2.4 Setting for Target Device	24
2.5 Software Settings	24
2.5.1 When using ID850QB as debugger	24
2.5.2 When using other than ID850QB (MULTI™, etc.) as debugger	24
2.6 Mounting and Connecting Connectors (When Using S Type)	25
2.6.1 Mounting target connector (TC) to target system	25
2.6.2 Plugging exchange adapter (EA) into TC	25
2.6.3 Notes on handling TC, EA, MA, CA, or SA	26
<R> 2.7 Mounting and Connecting Connectors (When Using T Type)	26
2.7.1 Mounting TC in target system	26
2.7.2 Connecting YQ on TC	27
2.7.3 Inserting EA into YQ	27
2.7.4 Precautions for handling TC, YQ, and SA	28
2.7.5 Precautions for mounting IC using TC and MA	28
2.8 Connecting QB-V850EIA4 to Target System	29
2.8.1 When not using extension probe (QB-144-EP-01S/02S)	29
2.8.2 When using extension probe (QB-144-EP-01S/02S)	30
2.9 Connecting USB Interface Cable and AC Adapter	34
2.10 Switching Power On and Off	34
CHAPTER 3 SETTINGS AT PRODUCT SHIPMENT	35
CHAPTER 4 NOTES	36
4.1 Cautions Regarding Differences Between Actual Device And Emulator	36
4.1.1 Operation after power application to target system	36
4.1.2 Oscillator	36
4.1.3 Pin characteristics	36
4.1.4 Notes on flash self programming function	36
4.1.5 Notes on DBTRAP instruction	36

4.1.6	CLKOUT pin in standby mode	36
4.1.7	On-chip debug function.....	36
4.1.8	Current consumption	36
4.2	Notes On Debugging	37
4.2.1	Notes on Non-map Break	37
4.2.2	PSC Register Access	37
4.2.3	Notes on DBPC, DBPSW, and ECR Registers.....	37
4.2.4	Notes on Trace Display Sequence	37
4.2.5	Notes on Starting Debugger	37
4.2.6	Simultaneously Executing Two Instructions When Hardware Break Is Set	38
4.2.7	Operation during Break.....	40
4.2.8	When an Illegal Break Occurs during Program Execution in Internal RAM	41
4.2.9	Motor control pins	41
4.2.10	Conflict between program execution for internal RAM and DMA transfer.....	41
CHAPTER 5	OPTIONAL FUNCTIONS	42
5.1	Coverage Measurement Function	43
5.1.1	Functional outline	43
5.1.2	Differences from hardware specifications	43
5.2	TimeMachine Function.....	44
5.3	Changes to Top Side of Product Consequent to Addition of Optional Functions	44
5.4	How to Add Optional Functions	45
APPENDIX A	REVISION HISTORY	46
A.1	Major Revisions in This Edition	46
A.2	Revision History of Preceding Editions	46

CHAPTER 1 GENERAL

The QB-V850EIA4 is an in-circuit emulator for emulating the target device shown below.

Hardware and software can be debugged efficiently in the development of systems in which the target device is used. This manual describes basic setup procedures, hardware specifications, system specifications, and how to set switches.

Target device : V850ES/IK1, V850E/IA3, V850E/IA4

1.1 Hardware Specifications

Table 1-1. QB-V850EIA4 Hardware Specifications

Parameter		Specification
Target system interface voltage		V850ES/IK1 $V_{DD} = EV_{DD} = 4.5$ to 5.5 V $AV_{DD} = 4.5$ to 5.5 V $V_{SS} = EV_{SS} = AV_{SS} = 0$ V
		V850E/IA3, V850E/IA4 $V_{DD} = CV_{DD} = 2.3$ to 2.7 V $EV_{DD} = AV_{DD} = 4.5$ to 5.5 V $V_{SS} = EV_{SS} = CV_{SS} = AV_{SS} = 0$ V
Maximum operating frequency		When emulating V850E/IA3 or V850E/IA4: 64 MHz
		When emulating V850ES/IK1: 32 MHz
Operating temperature range		0 to 40°C (No condensation)
Storage temperature range		-15 to +60°C (No condensation)
External dimensions		See figure below
Power consumption	AC adapter	15 V, 1 A
	Target system power supply	Same level or lower than target device
Weight		412 g
Host interface		USB interface (1.1, 2.0)

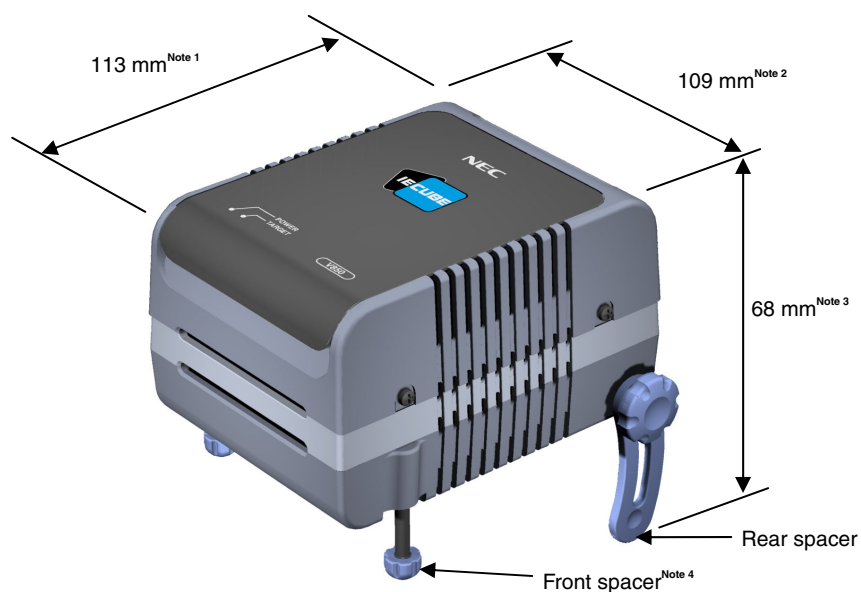

- Notes**
- 1** Does not include projection of power switch
 - 2** Includes projection of screw that fixes rear spacer
 - 3** Dimension when rear spacer is made shortest (108 mm when longest)
 - 4** Front spacer can vary from 20 mm (longest) to 5 mm (shortest)

1.2 System Specifications

This section shows the QB-V850EIA4 system specifications. For the usage of the debugging function, refer to **ID850QB Ver. 3.40 Operation User's Manual (U18604E)**.

Table 1-2. QB-V850EIA4 System Specifications

Parameter		Specification
Emulation memory capacity	Internal ROM	1 MB max.
	Internal RAM	60 KB max.
	External memory	16 MB max. (optional) (mapping possible in 1 MB units)
Program execution functions	Real-time execution function	Go, Start from Here, Go & Go, Come Here, Restart, Return Out
	Non-real-time execution function	Step In, Next Over, Slowmotion
Break functions	Hardware break	Execution: 10 points Access: 6 points
	Software break	2000 points
	Fail-safe break	Non-map, I/O illegal, write protect
	Other	Trace full break, forced break, timer overflow break
Trace functions	Trace data types	Branch-source PC, branch-destination PC, all PCs, all execution data, access data, access address, R/W status, time stamp, DMA point (start/end)
	Trace modes	Real-time trace, Complete trace
	Trace events	Delay trigger, section, qualify
	Memory capacity	256K frames
Real-time RAM monitoring function		256 bytes × 8 points
Time measurement functions	Measurement clock	50 MHz
	Measurement objects	Beginning through end of program execution Start event through end event (7 sections)
	Maximum measurement time	Approximately 195 hours (When using measurement-dedicated clock divided by 32)
	Minimum resolution	20 ns
	Number of timers for measurement	8
	Measurement results	Execution time (Start through end of execution) Maximum, minimum, average, pass count (between events)
Other		Timer overflow break function (1 point)
Coverage function		Detection of execution or pass (optional)
	Measured range	Internal ROM space + arbitrary 1 MB space
Other functions		Mapping function, event function, register manipulation function, memory manipulation function

Caution Depending on the debugger, some functions are not supported.

1.3 System Configuration

This section shows the system configuration when using the QB-V850EIA4 connected to a host machine (a computer equipped with a USB port). Connection is possible even without optional products.

Connectors <8> to <12> differ depending on the target device to be emulated.

Figure 1-1. System Configuration (S Type)

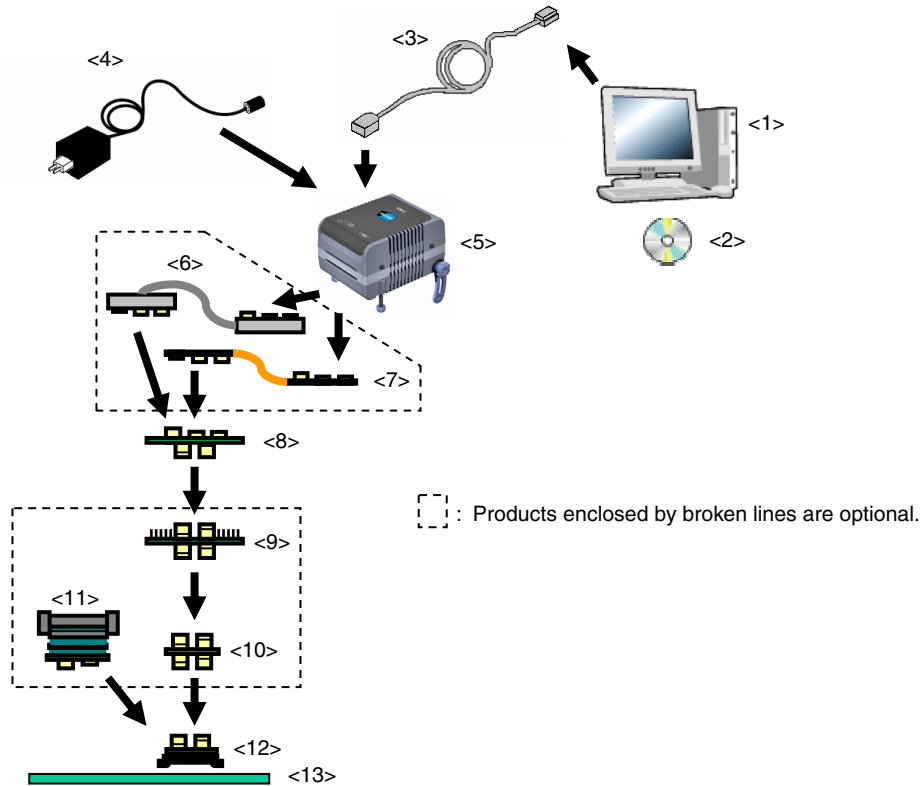

- | | |
|---|---|
| <1> Host machine: | Computer equipped with a USB port |
| <2> ID850QB Disk/Accessory Disk ^{Note 1} : | Debugger, USB drivers, manual, etc. |
| <3> USB interface cable: | Cable connecting QB-V850EIA4 to host machine |
| <4> AC adapter: | Can support 100 to 240 V by replacing AC plug |
| <5> QB-V850EIA4: | This product |
| <6> Extension probe (coaxial type) (option) | |
| <7> Extension probe (flexible type) (option) | |
| <8> Exchange adapter: | Adapter that performs pin conversion |
| <9> Check pin adapter (option): | Adapter used when observing waveforms on oscilloscope ^{Notes 2, 3} |
| <10> Space adapter (option): | Adapter for height regulation ^{Note 2} |
| <11> Mount adapter (option): | Adapter for socket mounting target device |
| <12> Target connector: | Connector soldered to target system |
| <13> Target system | |

Notes 1. Obtain device files from the NEC Electronics website.

http://www.necel.com/micro/index_e.html

2. If both <9> and <10> are used, connection sequence of <9> and <10> may be reversed.

3. <6> is always required if <9> is used.

Remark For notes on target system design and package drawings, refer to **[Related Information]** on the following URL.

http://www.necel.com/micro/index_e.html

<R>

Figure 1-2. System Configuration (T Type)

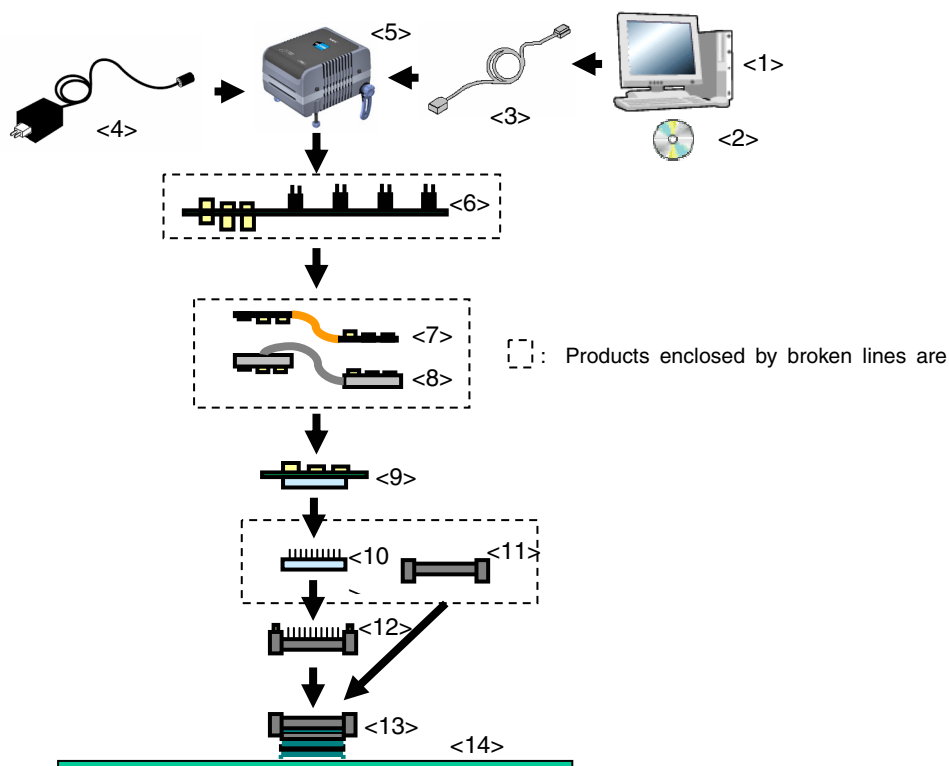

- | | |
|---|---|
| <1> Host machine: | Computer equipped with a USB port |
| <2> ID850QB Disk/Accessory Disk ^{Note} : | Debugger, USB drivers, manual, etc. |
| <3> USB interface cable: | Cable used for connecting QB-V850EIA4 to host machine |
| <4> AC adapter: | Can support 100 to 240 V by replacing AC plug |
| <5> QB-V850EIA4: | This product |
| <6> Check pin adapter (optional): | Adapter used for monitoring waveforms with oscilloscope |
| <7> Extension probe flexible type (optional) | |
| <8> Extension probe coaxial type (optional) | |
| <9> Exchange adapter: | Adapter that performs pin conversion |
| <10> Space adapter (optional): | Adapter used for height adjustment |
| <11> Mount adapter (optional): | Adapter used for mounting target device |
| <12> YQ connector: | Connector used for connecting emulator |
| <13> Target connector: | Connector to be soldered to target system |
| <14> Target system | |

Note Download the device file from the NEC Electronics website.

http://www.necel.com/micro/index_e.html

Remark For notes on target system design and package drawings, refer to **[Related Information]** on the following URL.

http://www.necel.com/micro/index_e.html

Table 1-3. List of Probe/Connector for Each Target Device (S Type)

No.	Name	Target Device to Be Emulated			
		V850ES/IK1 (64-Pin GC)	V850E/IA3 (80-Pin GC)	V850E/IA4 (100-Pin GC)	V850E/IA4 (100-Pin GF)
<6>	Extension probe (coaxial type)	QB-144-EP-01S (sold separately)			
<7>	Extension probe (flexible type)	QB-144-EP-02S (sold separately)			
<8>	Exchange adapter	QB-64GC-EA-01S (sold separately) ^{Note}	QB-80GC-EA-01S (sold separately) ^{Note}	QB-100GJ-EA-02S (sold separately) ^{Note}	QB-100GF-EA-02S (sold separately) ^{Note}
<9>	Check pin adapter	QB-64-CA-01S (sold separately)	QB-80-CA-01S (sold separately)	QB-100-CA-01S (sold separately)	
<10>	Space adapter	QB-64-SA-01S (sold separately)	QB-80-SA-01S (sold separately)	QB-100-SA-01S (sold separately)	
<11>	Mount adapter	QB-64GC-MA-01S (sold separately)	QB-80GC-MA-01S (sold separately)	QB-100GC-MA-01S (sold separately)	QB-100GF-MA-02S (sold separately)
<12>	Target adapter	QB-64GC-TC-01S (sold separately) ^{Note}	QB-80GC-TC-01S (sold separately) ^{Note}	QB-100GC-TC-01S (sold separately) ^{Note}	QB-100GF-TC-01S (sold separately) ^{Note}

<R>

Table 1-4. List of Probe/Connector for Each Target Device (T Type)

No.	Name	Target Device to Be Emulated			
		V850ES/IK1 (64-Pin GC)	V850E/IA3 (80-Pin GC)	V850E/IA4 (100-Pin GC)	V850E/IA4 (100-Pin GF)
<6>	Check pin adapter	QB-144-CA-01 (sold separately)			
<7>	Extension probe (flexible type)	QB-144-EP-02S (sold separately)			
<8>	Extension probe (coaxial type)	QB-144-EP-01S (sold separately)			
<9>	Exchange adapter	QB-64GC-EA-02T (sold separately) ^{Note}	QB-80GC-EA-03T (sold separately) ^{Note}	QB-100GC-EA-02T (sold separately) ^{Note}	QB-100GF-EA-02T (sold separately) ^{Note}
<10>	Space adapter	QB-64GC-YS-01T (sold separately)	QB-80GC-YS-01T (sold separately)	QB-100GC-YS-01T (sold separately)	QB-100GF-YS-01T (sold separately)
<11>	Mount adapter	QB-64GC-HQ-01T (sold separately)	QB-80GC-HQ-01T (sold separately)	QB-100GC-HQ-01T (sold separately)	QB-100GF-HQ-02T (sold separately)
<12>	YQ connector	QB-64GC-YQ-01T (sold separately) ^{Note}	QB-80GC-YQ-01T (sold separately) ^{Note}	QB-100GC-YQ-01T (sold separately) ^{Note}	QB-100GF-YQ-01T (sold separately) ^{Note}
<13>	Target connector	QB-64GC-NQ-01T (sold separately) ^{Note}	QB-80GC-NQ-01T (sold separately) ^{Note}	QB-100GC-NQ-01T (sold separately) ^{Note}	QB-100GF-NQ-01T (sold separately) ^{Note}

Note These accessories are supplied depending on the part number ordered (Refer to 1.4 Package Contents).

1.4 Package Contents

The following items have been placed in the QB-V850EIA4 packing box. Please check the contents.

Products supplied with QB-V850EIA4-ZZZ

- 1: QB-V850EIA4
- 2: AC adapter
- 3: USB interface cable
- 4: ID850QB Disk (CD-ROM)
- 5: Accessory Disk (CD-ROM)
- 6: IECUBE Setup Manual
- 7: User registration (Guarantee card and software contract in one)
- 8: Simple flash memory programmer (PG-FPL or QB-MINI2)
- 9: Probe holder
- 10: Parts board (for clock)

Products supplied with QB-V850EIA4-S100GC

- 1 to 10
- 11: Exchange adapter QB-100GC-EA-02S
 - 12: Target connector QB-100GC-TC-01S

Products supplied with QB-V850EIA4-S100GF

- 1 to 10
- 11: Exchange adapter QB-100GF-EA-02S
 - 12: Target connector QB-100GF-TC-01S

Products supplied with QB-V850EIA4-S80GC

- 1 to 10
- 11: Exchange adapter QB-80GC-EA-01S
 - 12: Target connector QB-80GC-TC-01S

Products supplied with QB-V850EIA4-S64GC

- 1 to 10
- 11: Exchange adapter QB-64GC-EA-01S
 - 12: Target connector QB-64GC-TC-01S

<R> Products supplied with QB-V850EIA4-T100GC

- 1 to 10
- 11: Exchange adapter QB-100GC-EA-02T
 - 12: YQ connector QB-100GC-YQ-01T
 - 13: Target connector QB-100GC-NQ-01T

<R> Products supplied with QB-V850EIA4-T100GF

- 1 to 10
- 11: Exchange adapter QB-100GF-EA-02T
 - 12: YQ connector QB-100GF-YQ-01T
 - 13: Target connector QB-100GF-NQ-01T

- <R> Products supplied with QB-V850EIA3-T80GC
1 to 10
11: Exchange adapter QB-80GC-EA-03T
12: YQ connector QB-80GC-YQ-01T
13: Target connector QB-80GC-NQ-01T

- <R> Products supplied with QB-V850ESIK1-T64GC
1 to 10
11: Exchange adapter QB-64GC-EA-02T
12: YQ connector QB-64GC-YQ-01T
13: Target connector QB-64GC-NQ-01T

CHAPTER 2 SETUP PROCEDURE

This chapter explains the QB-V850EIA4 setup procedure.

Setup can be completed by performing installation/setup in the order in which it appears in this chapter.

Perform setup along the lines of the following procedure.

See **2.1 Names and Functions of Hardware** for jumper and clock board positions.

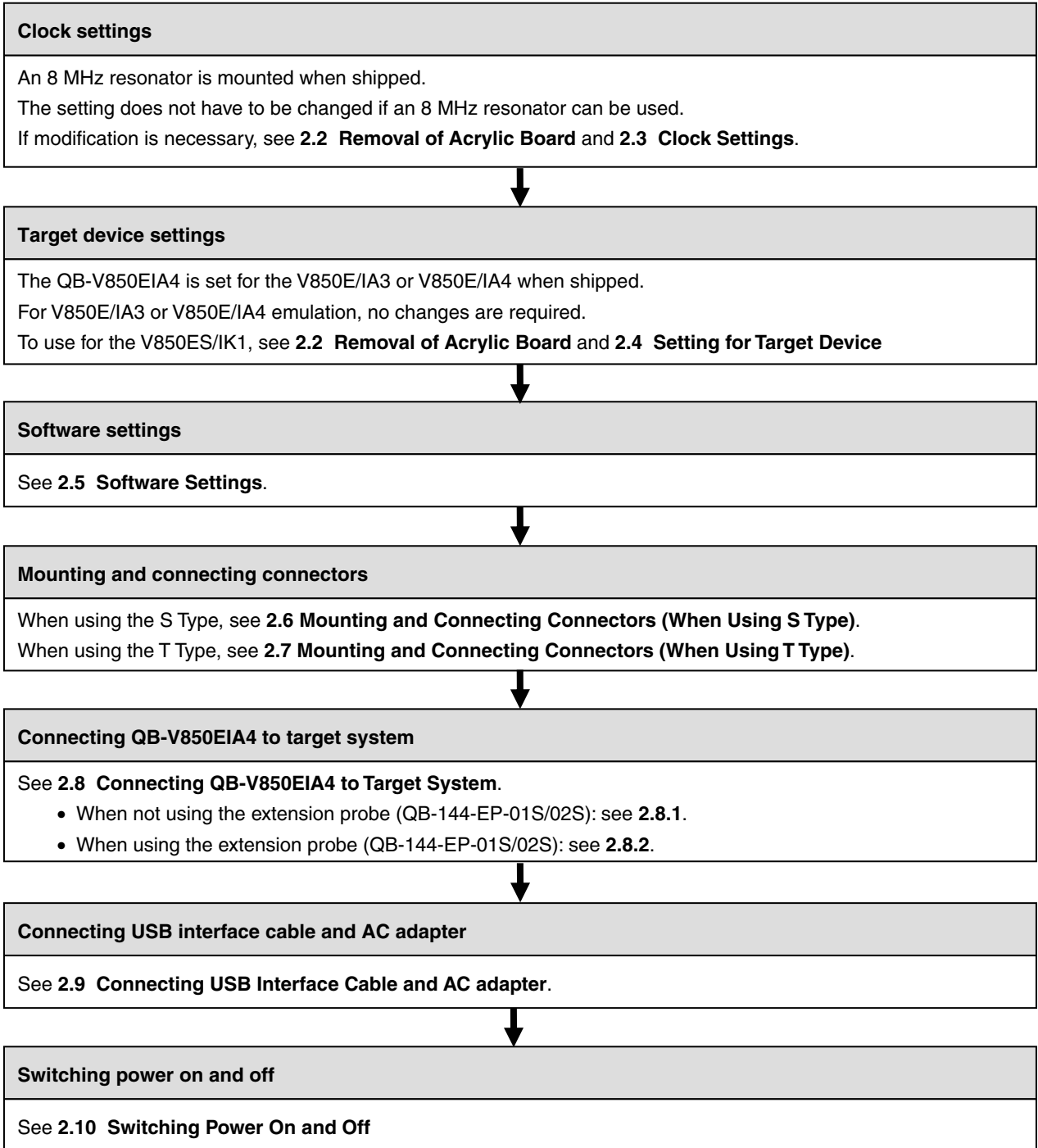

2.1 Names and Functions of Hardware

Figure 2-1. Names of Parts of QB-V850EIA4

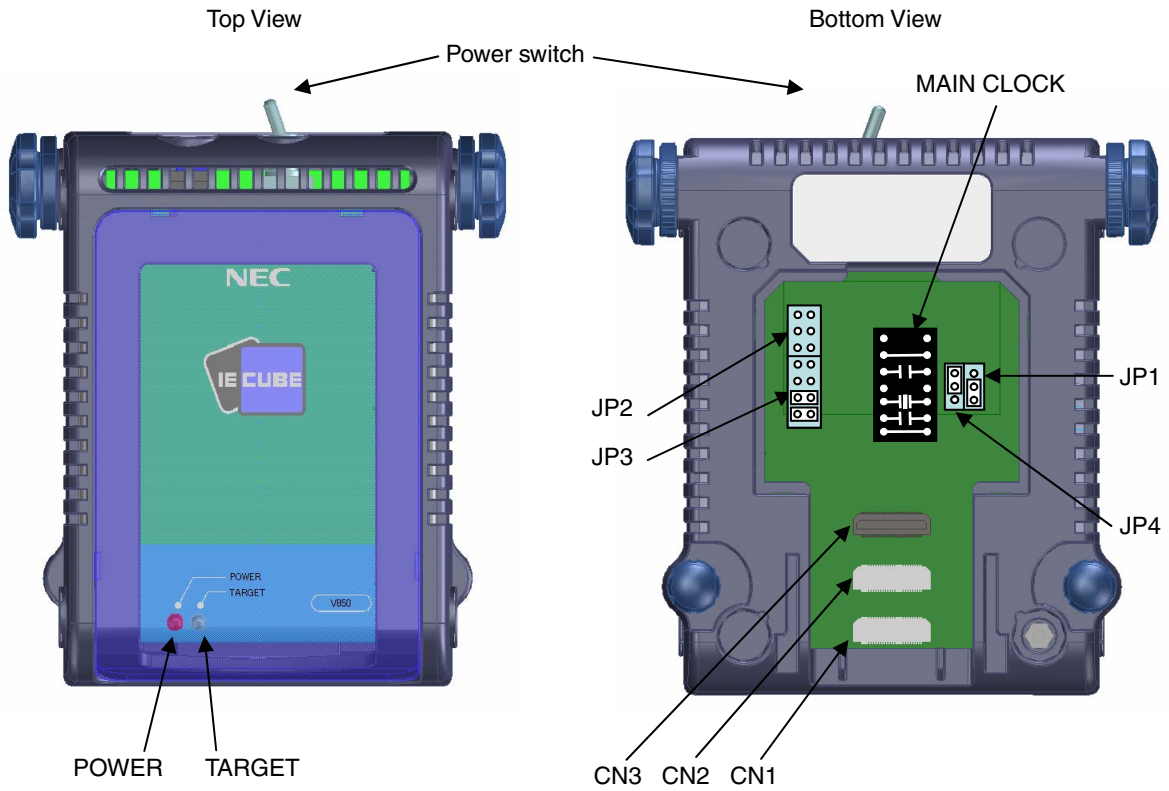

(1) CN1, CN2, CN3

These connectors are used to connect the exchange adapter or extension probe.

(2) MAIN CLOCK (for clock)

This parts board is used to mount the resonator.

An oscillator with an 8 MHz resonator and a capacitor are mounted at shipment.

(For details, refer to **2.3 Clock Settings**.)

(3) JP1

This jumper is used to change the setting depending on the operating frequency. Pins 1 and 2 are shorted at shipment.

(For details, refer to **2.3 Clock Settings**.)

(4) JP2

This jumper is used for delivery inspection.

All the pins of this jumper are open at shipment. Other settings are prohibited.

(5) JP3

This jumper is used to change the setting depending on the type of the clock mounted on the MAIN CLOCK.

Pins 1 and 2, and pins 3 and 4 are shorted, pins 5 and 6, and pins 7 and 8 are left open at shipment (refer to **2.3 Clock Settings** for details).

(6) JP4

This jumper is used to change the setting depending on the target device.

Pins 2 and 3 are shorted at shipment (refer to **2.4 Setting of Target Device**).

(7) POWER (Red LED)

This is an LED that shows whether or not the power supply of the QB-V850EIA4 is switched on.

LED State	QB-V850EIA4 State
Lit	Power switch ON
Not lit	Power switch OFF or AC adapter not connected to QB-V850EIA4
Blinking	Internal error occurred (Contact an NEC Electronics sales representative or distributor)

(8) TARGET (Green LED)

This is an LED that shows whether or not the power supply of the target system is switched on.

LED State	Target System State
Lit	Target system power supply ON
Not lit	Target system power supply OFF or target system not connected

(9) Power switch

This is the power switch of the QB-V850EIA4.

It is OFF at shipment.

2.2 Removal of Acrylic Board

To modify the jumper or clock setting, the acrylic board on the bottom of the QB-V850EIA4 must be removed. The acrylic board can be removed by lifting it up.

Figure 2-2. Acrylic Board Removal Method

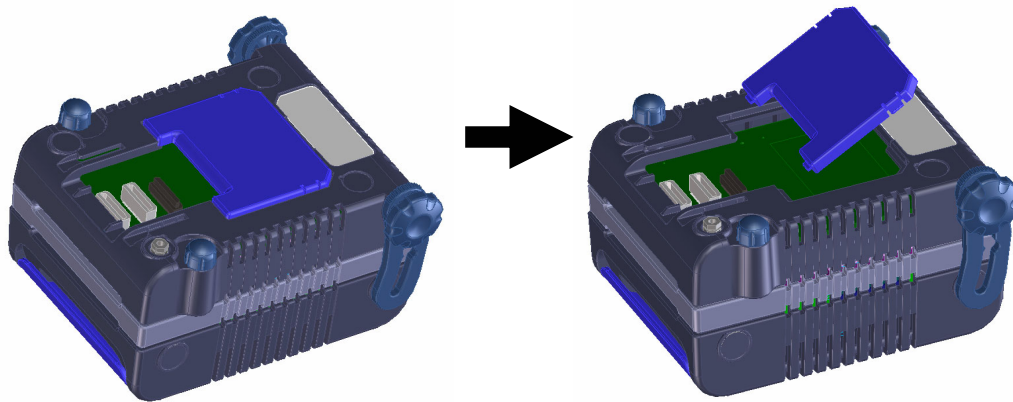

2.3 Clock Settings

2.3.1 Overview of clock settings

The following 5 types of clock settings are available.

For details, see **2.3.2 Clock setting methods**.

- (1) Using the clock generated from an 8 MHz resonator mounted on the QB-V850EIA4 as an internal clock (setting at shipment).
- (2) Using the clock generated from a 6.876 to 8 MHz resonator on the QB-V850EIA4.
- (3) Using the clock generated from a 4.0 to 6.875 MHz resonator on the QB-V850EIA4.
- (4) Using the clock generated from a 6.876 to 8 MHz oscillator on the QB-V850EIA4.
- (5) Using the clock generated from a 4.0 to 6.875 MHz oscillator on the QB-V850EIA4.

Cautions 1. In this product, clock input from the target system is not supported.

2. **Clock when emulating the V850ES/IK1**

During emulating the V850ES/IK1, half the clock mounted on the MAIN CLOCK is used as the clock in the QB-V850EIA4. Therefore, to the MAIN CLOCK, mount a resonator or oscillator whose frequency is twice that of the clock that is mounted to the target system. To use a 4 MHz clock as the main clock, for example, mount an 8 MHz clock (= two times as 4 MHz) on the MAIN CLOCK.

2.3.2 Clock setting methods

This section shows the hardware settings when setting the clock.

Table 2-1. Hardware Setting with Each Clock Setting

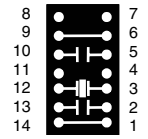
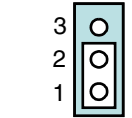
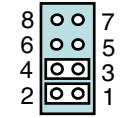
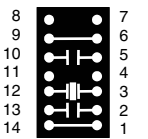
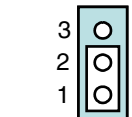
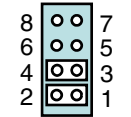
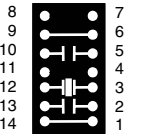
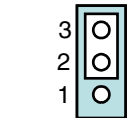
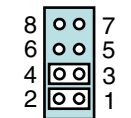
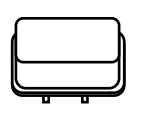
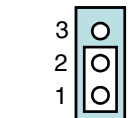
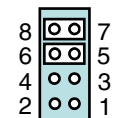
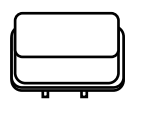
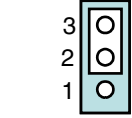
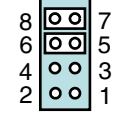
Type of Clock Used	MAIN CLOCK	JP1 Setting	V850E/IA3, V850E/IA4 PLLSIN Pin State ^{Note}	JP3 Setting
The clock generated from an 8 MHz resonator on QB-V850EIA4 is used as internal clock (Setting at shipment)	 <p>(Setting at shipment)</p>	 <p>1-2 shorted (Setting at shipment)</p>	High level	 <p>7-8: Open 5-6: Open 3-4: Shorted 1-2: Shorted (Setting at shipment)</p>
The clock generated from a 6.876 to 8 MHz resonator on QB-V850EIA4 is used as internal clock	 <p>Supplied parts board is used</p>	 <p>1-2 shorted (Setting at shipment)</p>	High level	 <p>7-8: Open 5-6: Open 3-4: Shorted 1-2: Shorted (Setting at shipment)</p>
The clock generated from a 4.0 to 6.875 MHz resonator on QB-V850EIA4 is used as internal clock	 <p>Supplied parts board is used</p>	 <p>2-3 shorted</p>	Low level	 <p>7-8: Open 5-6: Open 3-4: Shorted 1-2: Shorted (Setting at shipment)</p>
The clock generated from a 6.876 to 8 MHz oscillator on QB-V850EIA4 is used as internal clock	 <p>5 V 8-pin or 14-pin type oscillator is used</p>	 <p>1-2 shorted (Setting at shipment)</p>	High level	 <p>7-8: Shorted 5-6: Shorted 3-4: Open 1-2: Open</p>
The clock generated from a 4.0 to 6.875 MHz oscillator on QB-V850EIA4 is used as internal clock	 <p>5 V 8-pin or 14-pin type oscillator is used</p>	 <p>2-3 shorted</p>	Low level	 <p>7-8: Shorted 5-6: Shorted 3-4: Open 1-2: Open</p>

Note When using the V850ES/IK1, setting is not necessary.

Caution Settings other than above are prohibited.

2.3.3 Notes on changing resonators

When changing the resonator that was mounted when shipped, pull the MAIN CLOCK parts board out once to the top.

- Solder a resonator and a capacitor to the parts board supplied with the QB-V850EIA4.

The setting is as follows.

Pins 1 and 14: Be sure to short-circuit.

Pins 2 and 13: Connect a capacitor.

Pins 3 and 12: Connect a resonator.

Pins 4 and 11: Be sure to open.

Pins 5 and 10: Connect a capacitor.

Pins 6 and 9: Be sure to short-circuit.

Pins 7 and 8: Be sure to open.

Figure 2-3. Setting Parts Board

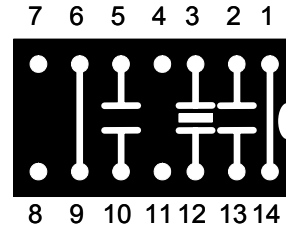

- Insert the parts board to the QB-V850EIA4 MAIN CLOCK.

Figure 2-4. Inserting Parts Board

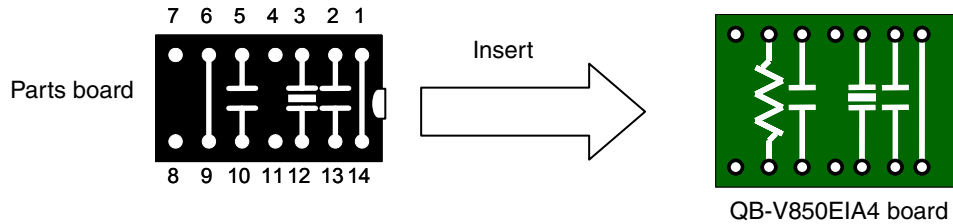

2.3.4 Notes on using oscillator

To change the main clock to the clock generated from the oscillator, pull the parts board mounted on the MAIN CLOCK out.

Mount the oscillator to be used to the MAIN CLOCK socket as shown below.

Figure 2-5. Mounting MAIN CLOCK

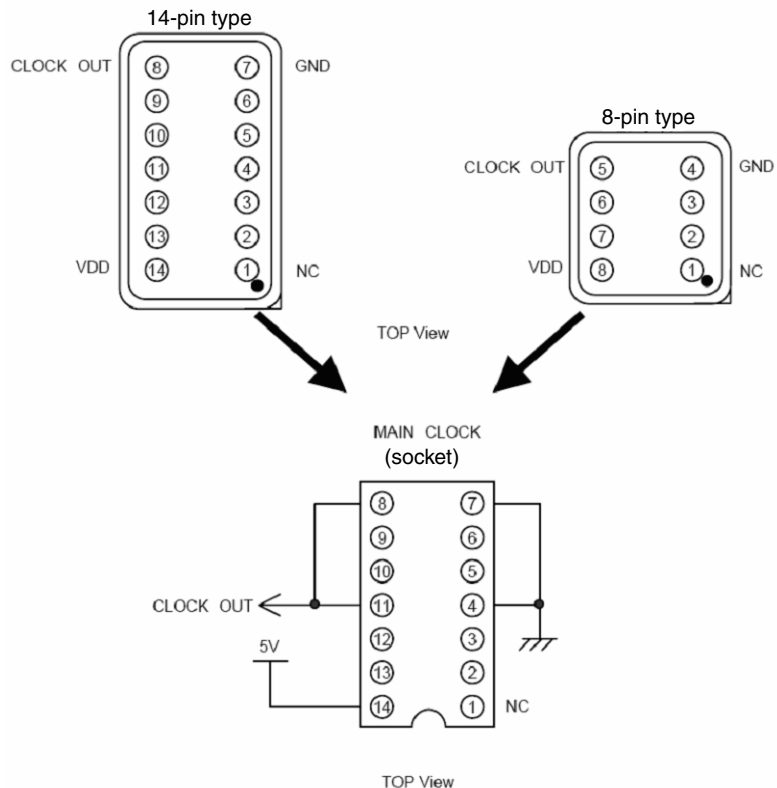

When mounting an 8-pin type crystal oscillator, make pin 1 of the oscillator and pin 1 of the MAIN CLOCK socket match and pin 8 of the oscillator and pin 14 of the MAIN CLOCK socket match.

2.4 Setting for Target Device

The setting of JP4 differs depending on the target device.

To emulate the V850ES/IK1: 1-2 shorted

To emulate the V850E/IA3, V850E/IA4: 2-3 shorted (setting at shipment)

Other settings are prohibited.

Figure 2-6. Setting JP4

To use the V850ES/IK1

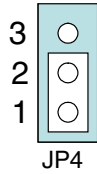

Short 1 and 2.

To use the V850E/IA3, V850E/IA4

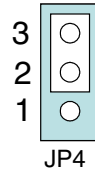

Short 2 and 3 (setting at shipment).

2.5 Software Settings

2.5.1 When using ID850QB as debugger

For details, refer to the **V850 Series Integrated Debugger ID850QB Operating Precautions** supplied with the debugger (ID850QB).

2.5.2 When using other than ID850QB (MULTI™, etc.) as debugger

Refer to the user's manual of the debugger used and the **V850 IECUBE Setup Manual** (supplied).

2.6 Mounting and Connecting Connectors (When Using S Type)

This section describes the methods of connecting the QB-V850EIA4 and target system.

Make connections with both the QB-V850EIA4 and target system powered OFF.

The following abbreviations are used in this section.

- TC: Target connector
- EA: Exchange adapter
- MA: Mount adapter
- CA: Check pin adapter
- SA: Space adapter

2.6.1 Mounting target connector (TC) to target system

- (1) Apply cream solder to the foot pattern of the target system for mounting an IC.
- (2) A circular projection is at the center of the bottom side of TC (refer to **Figure 2-7**). Sparingly apply two-liquid hardening epoxy adhesive (type that hardens in 15 to 30 minutes is recommended) to temporarily secure the connector at the specified position on the target system. At this time, match the position of pin 1 (position where a corner of the connector is cut into shape C) with the position of pin 1 from the target system.
- (3) Soldering condition of TC
 - (a) Reflow soldering
 - At 245°C for a maximum of 20 seconds (main heating)
 - (b) Manual soldering
 - At 320°C for a maximum of 5 seconds (per pin)

Figure 2-7. TC Projection

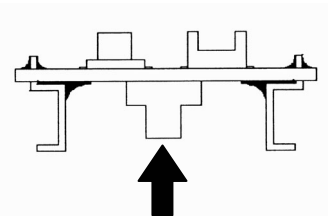

- (4) Precautions on flux splatter

If the solder flux splatters when the connector is soldered, faulty contact may occur. Be sure to cover the upper part of the connector with aluminum foil. Do not clean the connector because the flux solvent may remain inside the connector.

2.6.2 Plugging exchange adapter (EA) into TC

Match the No. 1 pin position of the EA, MA, CA, or SA to the No. 1 pin position of the TC and plug in (C cuts match in both).

- (a) When plugging or unplugging, hold down the TC with your fingers so that there is no force on the TC.
- (b) When plugging or unplugging, be careful of the direction of rocking (refer to **Figure 2-8**).

As a tool when unplugging, insert some kind of thin non-conductive material such as a wooden stick in between the TC and EA and rock in the direction shown in Figure 2-8 while slowly unplugging. Be careful since the connector will be damaged if this is done in the wrong direction.

Figure 2-8. Plugging and Unplugging

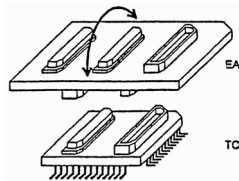

2.6.3 Notes on handling TC, EA, MA, CA, or SA

- (1) Cause of faulty contact of connector
 - (a) If flux gets inside the connector when TC is soldered
It is easy for flux to get inside of the connector. Clean the connector several times with a solvent such as alcohol if flux gets inside.
If conduction is still unstable, repeat cleaning.
 - (b) If dust gets inside the connector
Faulty contact occurs if dust such as a thread gets inside the connector. Remove dust with a brush.
 - (c) Notes on using CA or SA
When CA or SA is used, a fractional delay time of signal propagation and a little capacitance are generated as a result of inserting the adapter. Make a thorough evaluation by connecting the target system.

- (2) Notes on inserting and removing the connector
 - (a) When inserting or removing the connector, be sure to hold down the lower (mating) connector or board with your fingers.
 - (b) Before inserting a connector, make sure that the connectors are correctly positioned.
If the connector is inserted incorrectly positioned, it may be damaged.
 - (c) When removing a connector, insert some kind of thin non-conductive material such as a wooden stick beneath the connector to protect the board from being damaged. Do not remove the connector all at once.
Remove the connector by jiggling it bit by bit.
If only a metallic object such as a screwdriver is available, wind a soft cloth around its tip.

<R> 2.7 Mounting and Connecting Connectors (When Using T Type)

This section describes the methods for connecting the QB-V850EIA4 to the target system when using the T Type. Make connections with both the QB-V850EIA4 and target system powered off.

The following abbreviations are used in this section.

- TC: Target connector
- YQ: YQ connector
- EA: Exchange adapter
- MA: Mount adapter
- CA: Check pin adapter
- SA: Space adapter

2.7.1 Mounting TC in target system

- (1) Thinly apply a two-component epoxy adhesive (hardening time at least 30 minutes) to the ends of the four projections on the base of the TC and adhere the TC to the user board (clean the surface of the user board using alcohol or the like). If alignment of user board pads to TC leads is difficult, align them as in (2).
- (2) Align by inserting the guide pins for alignment for the TC (NQGUIDE) through the pin holes on the top of the TC. Accessory holes are $\phi 1.0$ mm non-through holes in two or three places.
(For hole positions, see the particular TC drawing.)

- (3) Solder after fitting the MA to the TC. This is to prevent troubles such as flux or solder splatter and adhering to the TC contact pins when soldering.

• Soldering conditions	Solder reflow	At 260°C for a maximum of 10 seconds
	Manual soldering	At 350°C for a maximum of 5 seconds (per pin)

Caution Do not perform cleaning by flux immersion or vapor.

- (4) Remove the guide pins.

2.7.2 Connecting YQ on TC

- (1) After confirming that there are no broken or bent YQ contact pins, fit the YQ in the TC and fasten it using the supplied YQGUIDE (for the fastening method, see the next step, (2)). If repeatedly inserting and removing, be sure to inspect the YQ pins before fitting. If pins are bent, correct them using something thin and flat such as the edge of a knife.
- (2) Fasten YQ to the TC on the target system using the supplied YQGUIDE. Fasten the screws equally in the four corners using the supplied flat-blade screwdriver or a torque driver. The tightening torque of YQGUIDE is 0.054 Nm (MAX.). Too great tightening causes bad connections. Four screws for fitting to the MA (M2 x 10 mm / 4 units) are included with YQ.

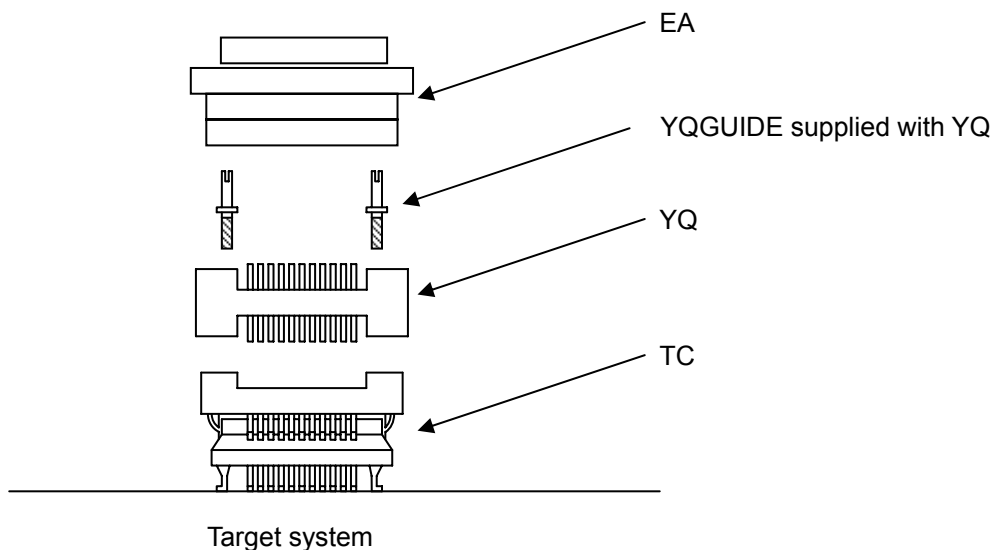

2.7.3 Inserting EA into YQ

Match the pin 1 position of the YQ or SA (corner cuts match in both) to the pin 1 position of the EA and insert it.

- When inserting or removing, press on the TC, YQ, and SA with a finger so that there is no force on the TC.
- When inserting or removing, be careful of the direction of wiggling.

As a tool when removing, insert some kind of thin non-conductive material such as a wooden stick between the YQ (SA) and EA and wiggle it while slowly removing. Be careful since the connector will be damaged if this is done in the wrong direction.

2.7.4 Precautions for handling TC, YQ, and SA

- (1) When taking the TC from the box, press down on the body and take out the sponge first.
- (2) Since the pins of the YQ are thin and easily bent, be careful. When inserting it in the TC, confirm that there are no bent pins.
- (3) When screwing a YQ soldered to a board to the TC, fasten the screws in four places in turn using a #0 or #1 Phillips precision screwdriver or torque driver after tentatively tightening them. Fix the torque at 0.054 Nm (MAX.). If just one place is overtightened, it may cause poor contact. Moreover, a board being connected to the YQ must have accessory holes in prescribed positions (4 places: $\phi 2.3$ mm or $\phi 3.3$ mm). The $\phi 3.8$ mm or $\phi 4.3$ mm that is the screw head size is an area where wiring is prohibited.
- (4) In YQ and SA removal, since there is a danger of YQ pins being bent or broken when prying and wiggling, remove them gradually using a flatbladed screwdriver from four directions. Moreover, to connect and use the YQ and SA, screw the YQ to the TC according to the YQGUIDE (included with the YQ) using a 2.3 mm flatbladed screwdriver and then connect it to the SA. Fix the torque at 0.054 Nm (MAX.). If even one place is overtightened, it may cause poor contact..
- (5) For the TC, YQ, and SA, since there is a danger that cleaning fluid on the structure will remain in the connector, do not perform cleaning.
- (6) TC, IC, and YQ cannot be used in combination.
- (7) An TC/YQ system cannot be used in an environment of vibrations or shocks.
- (8) It is assumed that this product will be used in system development and evaluation. Moreover, when used in Japan, Electrical Appliance and Material Control Law and electromagnetic disturbance countermeasures have not been applied.
- (9) Since there are rare cases of shape change if the box is left for a long time in a place where it is 50°C or higher, for safekeeping, store it in a place where it is no higher than 40°C and direct sunlight does not hit it.
- (10) For details about handling the TC, YQ, and SA, see the NQPACK series technical materials at the website of Tokyo Eletech Corporation.
Tokyo Eletech Corporation website: <http://www.tetc.co.jp/>
- (11) The check pin adapter QB-144-CA-01 is an optional product for IECUBE, and can be used to measure the waveform between IECUBE and the target system.
Since the pins on the QB-144-CA-01 do not correspond to the pin layout in each device, the pin header cover must be mounted according to the device to be used.
For mounting methods of the pin header cover, refer to **[Related Information]** on the following webpage.
URL: <http://www.necel.com/micro/english/iecube/index.html>

2.7.5 Precautions for mounting IC using TC and MA

- (1) Confirm that there is no weld flash in the resin (sealant part) of the IC. If there is weld flash, remove it using a knife or the like.
- (2) Confirm that there is no weld flash breaking or bending of IC leads. In particular, confirm the planarity of IC leads. If there is abnormality in the planarity, correct that portion.
- (3) Viewing the TC contact pins from the top, if there are foreign bodies on them, remove them using a brush or the like.
After confirming (1) to (3), fit the IC to the TC. Also fit the MA.
- (4) Put the supplied M2 × 6 mm screws in the four accessory holes of the MA and fasten the screws in opposite corners. At that time, use either the dedicated screwdriver that is supplied or a torque driver to fasten them equally in turn with a tightening torque of 0.054 Nm (MAX.). Since the contact is poor if tightening is too great, once you have lightly fastened the MA screws, tighten them again.

- (5) Depending on the use environment, when starting up a device that has been left for a long time, starting it may be difficult. In this case, loosen the screws slightly and then retighten them.
- (6) If startup still is difficult after (5) above, check (1) to (3) again.
- (7) Tightening the screws of the MA too much may give rise to cracks in the molded part of the MA (plastic part) and bend the mold into a bowed shape, making contact poor.
- (8) After soldering the TC, do not perform cleaning by flux immersion or vapor.

2.8 Connecting QB-V850EIA4 to Target System

2.8.1 When not using extension probe (QB-144-EP-01S/02S)

The QB-V850EIA4 can be connected to the target system without using an extension probe.

Adjust the height by using the spacer at the rear part of the QB-V850EIA4, so that no stress is applied to the exchange adapter, the target connector, and other connectors.

Sufficiently insulate the target system.

Figure 2-9. Connection Without Extension Probe

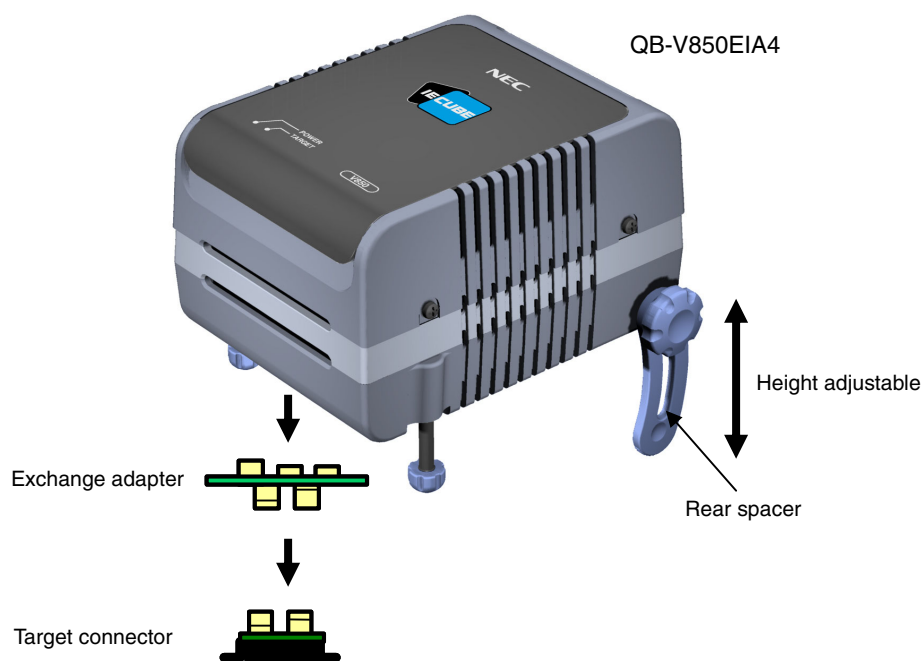

2.8.2 When using extension probe (QB-144-EP-01S/02S)

When using the extension probe (QB-144-EP-01S/02S), connect the QB-V850EIA4 and the target system in the following procedure.

(a) Connecting probe holder

Use the probe holder (supplied with the QB-V850EIA4) to connect the extension probe to the QB-V850EIA4, as shown below.

Figure 2-10. Using Probe Holder

<1> Connect the QB-V850EIA4 and probe.

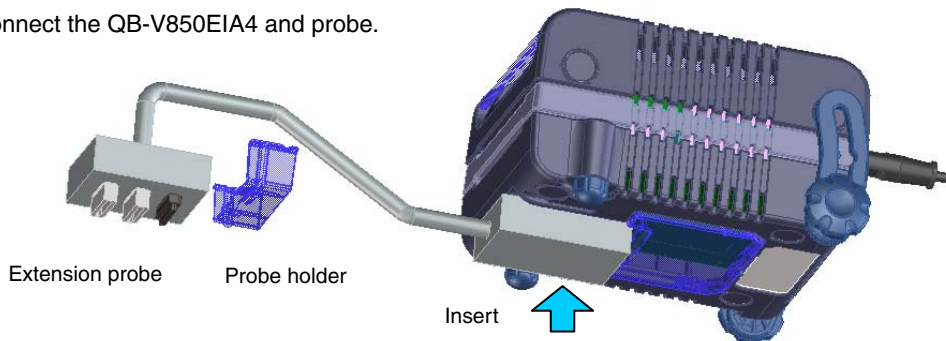

<2> Insert the probe holder into QB-V850EIA4.

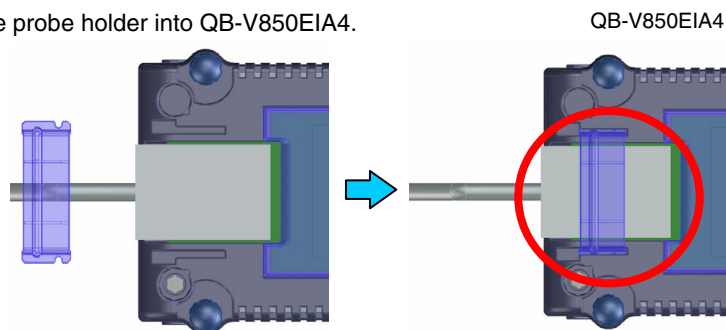

Insert the probe holder into QB-V850EIA4 until you hear a click (note the direction).

(b) Connection of extension probe GND wire

There are 3 GND wires in the extension probe. Connect them to the QB-V850EIA4 and target system.

<1> Fasten the GND wire on the QB-V850EIA4 side of the extension probe to the nut on the bottom of the QB-V850EIA4 using a #0 or #1 Phillips precision driver (connection of (B) to (A) in Figure 2-11).

<2> Next plug the connector on top of the extension probe into the connector at the opening on the bottom of the QB-V850EIA4 from below being careful of the insertion direction (connection of (C) in Figure 2-11 to QB-V850EIA4).

Figure 2-11. GND Wire

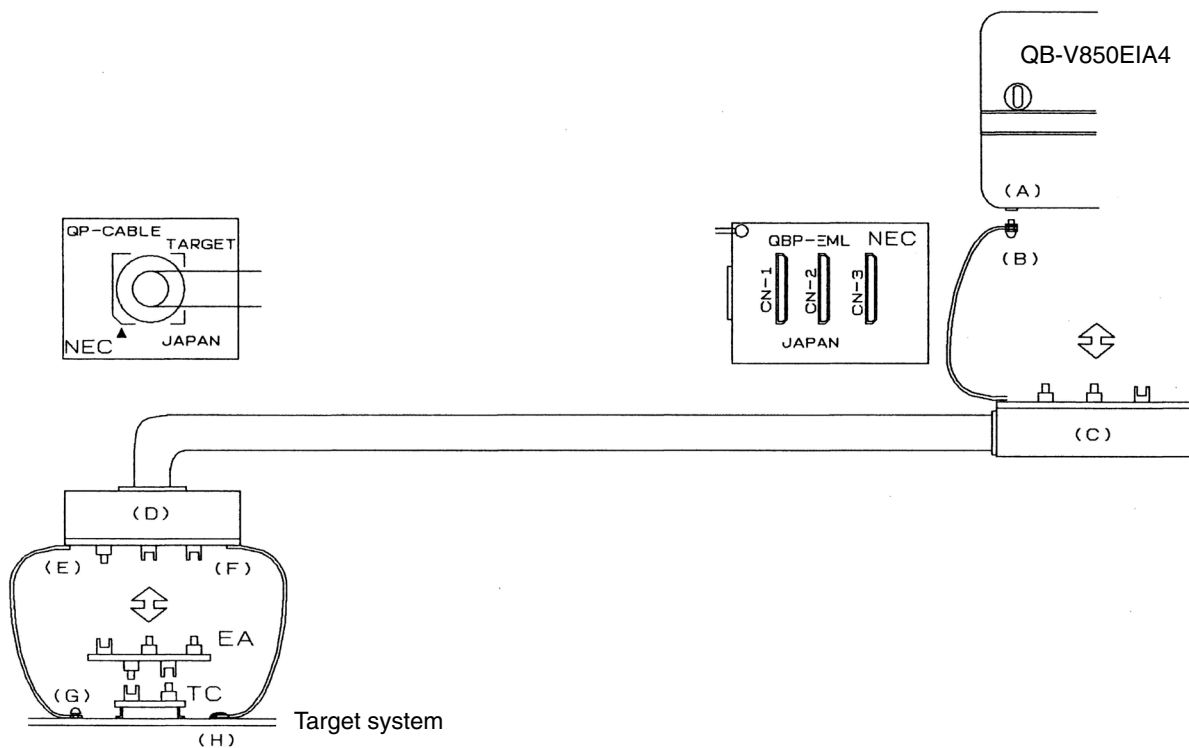

<3> Connect the exchange adapter and extension probe to the target connector.

<4> Connect two GND wires on the target system side of the extension probe to the target system GND.

If a pin or screw is fastened to the target system GND, remove the transparent terminal cover on the end of the GND wire and fasten the Y type pin of the GND wire to the target system ((G) in Figure 2-11). If the GND on the target system is an exposed pad, likewise fasten the Y type pin to the pad on the target system by soldering ((H) in Figure 2-11) (recommended soldering iron temperature setting: 300°C).

<5> If the target system has only one GND, connect only one of the GND wires of the extension probe. Cut off the other GND wires with a nipper or leave it as is without removing the pin cover.

<6> Since the length of the GND wire below the head (insulated part) is approximately 60 mm, there must be at least a GND to which it can be connected to within the range of the three approximately 60 mm radius sections of the target system for connecting the extension probe, as shown in Figure 2-12. The GND wire of the extension probe is soldered to positions J and K in Figure 2-12. To connect it to position L, remove the wire soldered to J or K and then solder it to L.

Figure 2-12. Where GND Wire Can Be Connected

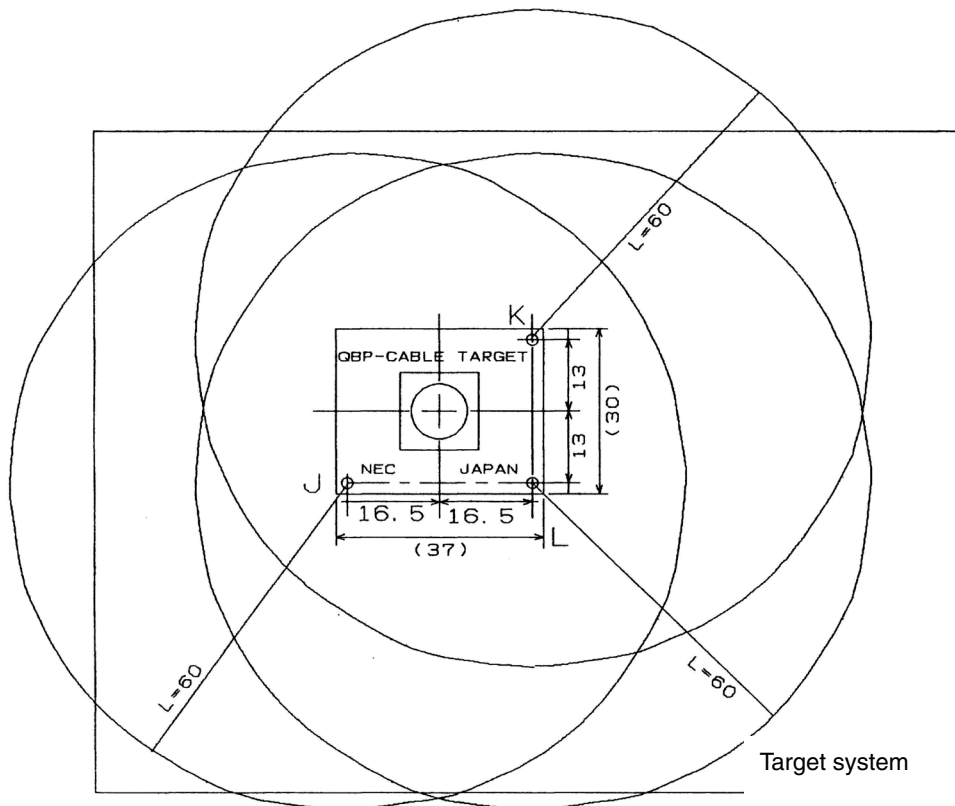

(c) Ensuring isolation

When connecting the target system to the QB-V850EIA4 using an extension probe, adjust the height using the front spacer or rear spacer of the QB-V850EIA4 and ensure isolation from the target system.

Figure 2-13. Connection Using Extension Probe

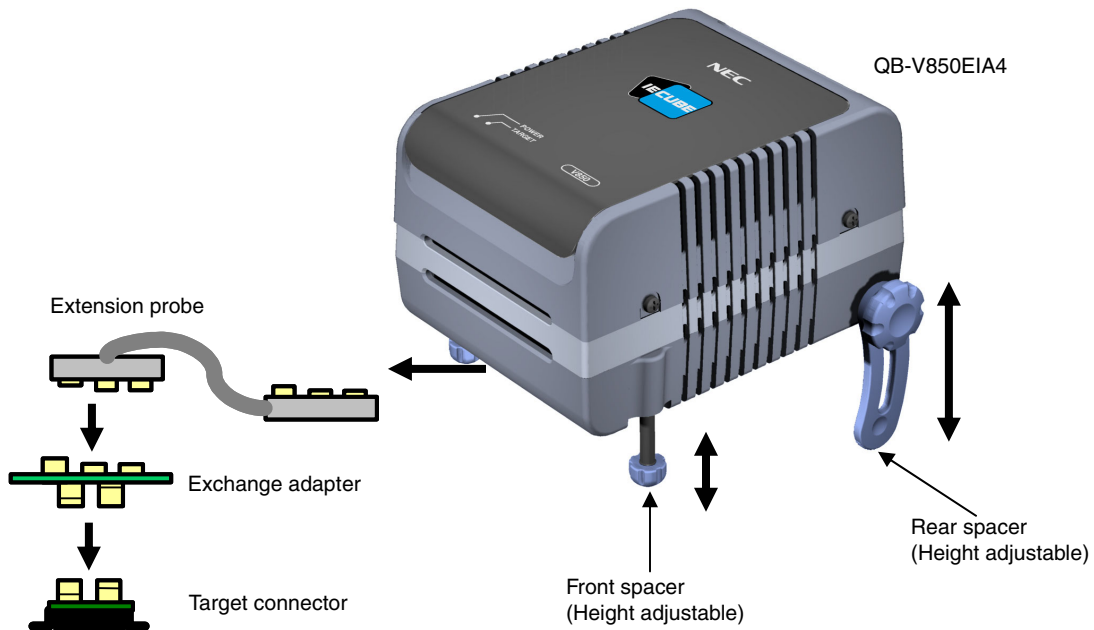
**(d) Cautions related to extension probe**

The following cautions pertain to using the extension probe.

- <1> Be careful that stress of the extension probe is not placed on the target connector. Moreover, when removing the extension probe, remove it slowly while holding down on the exchange adapter with a finger so that there is no stress on the target connector.
- <2> Be sure to connect the GND wire of the extension probe to the QB-V850EIA4 and the target system. If not, the impedance of the cable becomes unstable, resulting in the lowering of signal transmission characteristics or distortion of the output waveform for an input waveform.

2.9 Connecting USB Interface Cable and AC Adapter

Plug the USB interface cable supplied with the QB-V850EIA4 into the USB connector of the host machine, and plug the other side into the USB connector on the rear of the QB-V850EIA4.

Plug the AC adapter supplied with the QB-V850EIA4 into a receptacle and plug the other side into the power supply connector on the rear of the QB-V850EIA4.

For QB-V850EIA4 connector positions, see **Figure 2-14**.

By replacing the AC plug, the AC adapter can support the voltage from 100 to 240 V. The AC plug for 100 V is attached when shipped. Replace it with the AC plug for 220 or 240 V (supplied with the QB-V850EIA4) when the AC adapter is used at 220 or 240 V.

Figure 2-14. Connector Positions

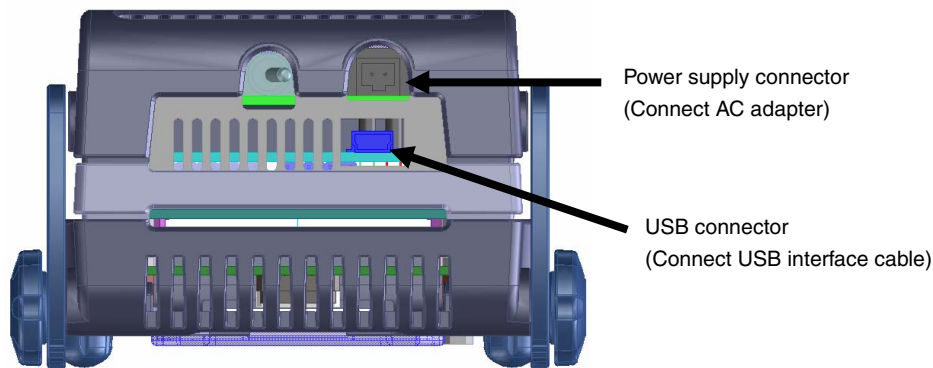

2.10 Switching Power On and Off

Be sure to switch the power on and off according to the following procedures.

- | | |
|--|---|
| • Switching power on | • Switching power off |
| <1> QB-V850EIA4 power on | <1> Debugger termination |
| <2> Target system power on ^{Note} | <2> Target system power off ^{Note} |
| <3> Debugger startup | <3> QB-V850EIA4 power off |

Note In the procedures, <2> is unnecessary if the target system is not connected.

Caution If the wrong sequence was used for the operation, the target system or QB-V850EIA4 may fail.

CHAPTER 3 SETTINGS AT PRODUCT SHIPMENT

Table 3-1. Settings at Shipment

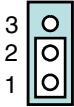
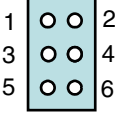
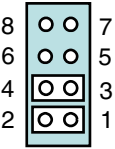
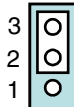
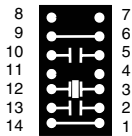
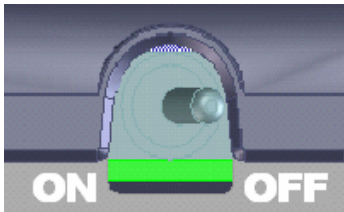
Item	Setting	Remarks
JP1		<p>Pins 1 and 2 are shorted (operating frequencies: 6.876 to 8 MHz). Short pins 2 and 3 if using at the operating frequencies of 4.1 to 6.875 MHz.</p> <p>For details, refer to 2.3 Clock Settings.</p>
JP2		<p>All pins are left open.</p> <p>Do not change this setting.</p>
JP3		<p>Pins 1 and 2, 3 and 4 are shorted, pins 5 and 6, 7 and 8 are left open (oscillator on the parts board is used).</p>
JP4		<p>Pins 2 and 3 are shorted (target device: V850E/IA3 or V850E/IA4). Short 1 and 2 if the target device is the V850ES/IK1.</p> <p>For details, refer to 2.4 Setting for Target Device.</p>
MAIN CLOCK		<p>An 8 MHz resonator is connected to pins 3 and 12. A 27 pF capacitor is connected to pins 2 and 13, and pins 5 and 10.</p> <p>The frequency can be changed by mounting an oscillator on the parts board of the QB-V850EIA4.</p> <p>For details, refer to 2.3 Clock Settings.</p>
Power switch		<p>Set to OFF at shipment.</p>

CHAPTER 4 NOTES

4.1 Cautions Regarding Differences Between Actual Device And Emulator

When debugging is performed with QB-V850EIA4 connected to the target system, QB-V850EIA4 performs emulation as if the actual device operates in the target system, although operations of the actual device and QB-V850EIA4 differ in the following points. Therefore, the user is responsible for using the actual device for the final evaluation before starting mass production and judging its applicability.

4.1.1 Operation after power application to target system

The target device mounted in the target system starts program execution when reset is released after power application. With QB-V850EIA4, however, the program will not be executed until manipulation to start the program downloaded with the debugger is performed.

QB-V850EIA4 can download and execute objects even before their initial value information of a variable is ROMized, but the actual device does not operate normally if the objects have not been ROMized. For details on ROMization, refer to **CA850 Ver.3.00 Operation User's Manual (U17293E)**.

4.1.2 Oscillator

QB-V850EIA4 does not support clock input from the oscillator in the target system. The operating clock frequency may therefore vary between when the target device is mounted and when QB-V850EIA4 is connected.

4.1.3 Pin characteristics

Since the connectors, adapters and circuit board are placed between QB-V850EIA4 and the target system, unlike when the target device is mounted in the target system, the electrical characteristics of the pins differ. In particular, note that the A/D converter conversion results can easily be affected.

4.1.4 Notes on flash self programming function

The flash self programming function cannot be emulated. To use this function, make an evaluation by using an on-chip debug emulator or the target device.

Some devices support the pseudo emulation function, using a debugger. For the usage, refer to **ID850QB Ver. 3.40 Operation User's Manual (U18604E)**.

4.1.5 Notes on DBTRAP instruction

The DBTRAP instruction cannot be used in the user program because it is used for software breaks.

4.1.6 CLKOUT pin in standby mode

The CLKOUT pin outputs the Low level in IDLE and STOP modes. The status before entering the IDLE or STOP mode is held in the actual device.

4.1.7 On-chip debug function

Emulation of the on-chip debug function is not possible.

4.1.8 Current consumption

The current consumed by QB-V850EIA4 differs from that of the actual device.

The current consumption of QB-V850EIA4 is equal to or lower than that of the actual device during normal operation, and HALT and IDLE modes, but it becomes higher than that in the actual device in the STOP mode.

4.2 Notes On Debugging

4.2.1 Notes on Non-map Break

If a program is fetched from an area not used by a program (unused area) with an emulator, a non-map break usually occurs. However, a non-map break does not occur in the first 16-byte space of each unused area (refer to **Figure 4-1**).

4.2.2 PSC Register Access

Data is written to the PSC register in the following sequence. If a software break is set to the NOP instruction immediately after the register has been accessed, the debugger hangs up.

Example:

```
mov 0x2,r1
```

```
st.b r1,prcmd
```

```
st.b r1,psc
```

```
nop      ← Debugger hangs up if a software break is set here.
```

```
nop      ← There is no problem if a software break is set here or later.
```

To set a break immediately after the PSC register has been written, use a hardware break.

Figure 4-1. Break at Fetching Unused Area

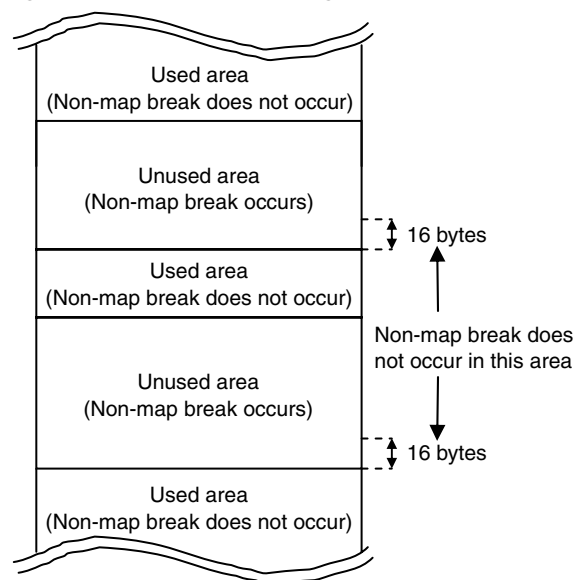

4.2.3 Notes on DBPC, DBPSW, and ECR Registers

The DBPC, DBPSW, and ECR registers cannot be accessed during a break.

If a value is written to any of these registers during a break, the written value is ignored.

If these registers are read, 0 is always read.

4.2.4 Notes on Trace Display Sequence

When the trace mode that displays the access history is used, the display sequence may be reversed.

- If read and write instructions are successively executed
- If a bit manipulation instruction that executes read-modify-write is executed (such as SET, NOT, or CLR)

In both the cases, the trace results of write and read are displayed in that order.

4.2.5 Notes on Starting Debugger

When the debugger is started, the following warning or error may occur depending on the setting of the debugger and the status of the target system. This is because the status of the target system is not in accordance with the setting of the debugger. If a warning or error occurs, check the status of the target system or the setting of the debugger.

It is recommended that the conversion adapter be connected to the QB-V850EIA4 even when the target system is not connected. If the conversion adapter is not connected, the value of the input port may not be correctly read.

• ID850QB

Error No.	Error Message	"Target" Field of ID850QB Configuration Window		Target System Connection		Exchange Adapter		Target System Power	
		Connect	Not Connect	Connected	Not Connected	Used	Not Used	ON	OFF
Ff606	Check connection with the target and turn on power to the target.	√							√
Wf607	Check the connection of the conversion adapter.		√		√		√		√
Ff608	Disconnect the target.		√	√					√
Ff609	Turn off power to the target and disconnect the target.		√					√	

• MULTI

Error Message	"-tc" of 850eserv Start Option		Target System Connection		Exchange Adapter		Target System Power	
	With -tc	Without -tc	Connected	Not Connected	Used	Not Used	ON	OFF
Check the target power on. Or please delete "-tc" option.	√							√
Check the exchange adapter is connected.		√		√		√		√
Remove the target. Or please add "-tc" option and power on the target.		√	√					√
Power off and remove the target. Or please add "-tc" option.		√					√	

4.2.6 Simultaneously Executing Two Instructions When Hardware Break Is Set

If a hardware break is set at the first or the next of two instructions that are executed at the same time, the following phenomena may occur.

- Break occurs at a place different from where it has been set.
- The set break does not occur.

To prevent these phenomena, set a software break.

The conditions under which two instructions are simultaneously executed are shown on the following pages.

[Combination of instructions for the occurrence of the simultaneous execution of two instructions]

- Condition where “mov + operation instruction” are executed as one instruction
If dst of mov and dst of the operation instruction are the same register, except r0, in combination of “mov src, dst” and one of the following instructions:

Format I	satsubr/satsub/satadd/mulh or/xor/and subr/sub/add
Format II	shr/sar/shl/mulh

Remark “mov + operation instruction” are executed as one instruction only when the mov instruction is the first instruction of the above combinations of instructions.

- Condition of parallel execution of instructions
<1> Combination of one of the following instructions and br instruction

Format I	nop/mov/not/sld satsubr/satsub/satadd/mulh or/xor/and/tst subr/sub/add/cmp
Format II	mov/satadd/add/cmp shr/sar/shl/mulh
Format IV	sld.b/sst.b/sld.h/sst.h/sld.w/sst.w

- <2> Combination of one of the following instructions (instructions that do not update flags) and bcc instruction except br instruction

Format I	nop/mov/sld mulh/sxb/sxh/zxb/zxh
Format II	mov/mulh
Format IV	sld.b/sst.b/sld.h/sst.h/sld.w/sst.w

- <3> Combination of one of the following instructions and sld instruction

Format I	nop/mov/not satsubr/satsub/satadd/mulh or/xor/and/tst subr/sub/add/cmp
Format II	mov/satadd/add/cmp shr/sar/shl/mulh

Remark Of <1> to <3>, two instructions are simultaneously executed only when the second instruction of the above combinations of instructions is br/brcc/sld

Caution **Formats I, II, and IV are the instruction formats described in the V850E1 Architecture User’s Manual (U14559E).**

- Cases in which two instructions are not simultaneously executed

In the following cases, two instructions are not simultaneously executed.

- (a) If the first instruction is the first instruction after execution branches to an address that is not word aligned.

Example

```
0x1006  mov r10,r12
0x1008  sld.b 0x8[ep],r11
```

If a branch to address 0x1006 occurs, the two instructions are not executed simultaneously because the first instruction is not word aligned (because the lower 1 byte of the address is not 0, 4, 8, A, or C).

- (b) If the second instruction is sld and writing to the ep register is not completed.

Example

```
0x1004  mov r10,ep
0x1006  sld.b 0x8[ep],r11
```

In this case, the value of r10 is written to the ep register by the mov instruction at address 0x1004. However, the two instructions are not executed simultaneously because WB (writeback) of the mov instruction is not completed when the sld.b instruction at address 0x1006 is executed.

- (c) If the second instruction is bcc (conditional branch instruction) and a flag hazard occurs (the instruction immediately before or the instruction before that instruction may update the flags).

Example

```
0x1004  cmp r0,r10
0x1006  bn 0xf0
```

The bn instruction that references the S flag and branches must wait for execution of the cmp instruction at address 0x1004 because the S flag is changed by the cmp instruction. As a consequence, the bn instruction causes a flag hazard and the two instructions are not executed simultaneously.

- (d) If the second instruction is sld and both of the load buffers are in the WB wait status.

Example

Suppose that the following instructions are located in the memory.

```
0x1000  nop
0x1002  nop
0x1004  ld.w 0x3000[r10],r11
0x1008  ld.w 0x3004[r10],r12
0x100c  mov r8,r9
0x100e  sld.b 0x10[ep],r13
```

If ld.w at addresses 0x1004 and 0x1008 accesses the external memory, several clocks of wait states are inserted. If the instruction at address 0x100e is executed, then the load buffer is in the "WB wait" status because WB of the ld.w instructions at addresses 0x1004 and 0x1008 is not completed, and the two instructions at address 0x100c and 0x100e are not simultaneously executed.

4.2.7 Operation during Break

Since various peripheral functions operate even during breaks in the in-circuit emulator, interrupts due to peripheral functions, generated during breaks, are suspended and, when re-executing after the breaks, execution may occur after processing of suspended interrupts. The watchdog timer counter, however, stops during the breaks.

The following peripheral functions can be stopped when using the peripheral break functions. When using the ID850QB, this setting can be made in the Configuration dialog box.

- Timer P
- Timer Q
- Timer M
- Watch timer

4.2.8 When an Illegal Break Occurs during Program Execution in Internal RAM

An illegal break may occur when a peripheral I/O register is accessed during program execution in the internal RAM.

A non-map break occurs if all of the following conditions are satisfied, even if the program itself is correct.

- A program is executed in the internal RAM area.
- Data access for the internal RAM area is performed twice in succession.
- An execution branches to the internal ROM area using a JR or JARL instruction immediately after the above successive data access, or one NOP instruction after the above successive data access.

In order not to generate the break, cancel the fail-safe break setting for the internal RAM in the debugger.

<When using ID850QB>

Click the [Detail] button in the Fail-safe Break field in the Configuration window and clear the check in the check box for "Internal RAM".

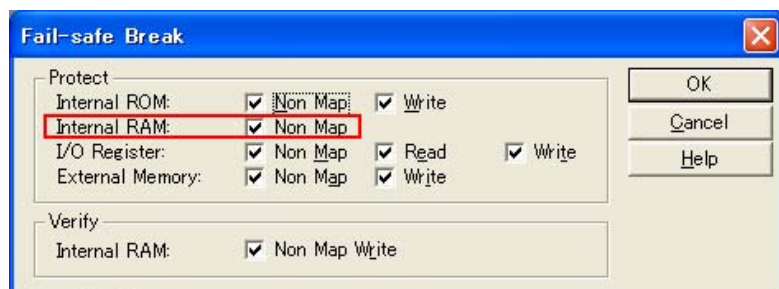

<When using MULTI>

Cancel the fail-safe break for "ramgrd" and "ramgrdv" using the Target flsf command.

4.2.9 Motor control pins

When motors are controlled with timer pins, the motor control signal is not fed back upon CPU stoppage (break), which may have an adverse effect on the motor. To avoid this, QB-V850EIA4 supports the open break function that is used to set timer pins to the high impedance state upon CPU stoppage.

The following pins are subject to the open break function. For details on the open break function settings, refer to **ID850QB Ver. 3.40 Operation User's Manual (U18604E)**.

Target pin : TOQ0T1-TOQ0T3, TOQ0B1-TOQ0B3, TOP21, TOQ1T1-TOQ1T3, TOQ1B1-TOQ1B3, TOP31

4.2.10 Conflict between program execution for internal RAM and DMA transfer

If the following two operations are executed at the same time, the CPU may deadlock due to an internal bus conflict.

- Instruction for accessing data at addresses mis-aligned in the internal RAM
- DMA transfer for the internal RAM

CHAPTER 5 OPTIONAL FUNCTIONS

The following functions can be added to the QB-V850EIA4. This chapter explains the functional outline and specifications of the optional functions, and how to obtain them.

- Coverage measurement function
- TimeMachine™ function

The support status of each optional function differs depending on the debugger used. The following table lists the support statuses as of February 2007. If you have any questions regarding the support status, consult an NEC Electronics sales representative or distributor.

Function	Support Status	
	ID850QB	MULTI
Coverage measurement function	Supported in V2.90, V3.10 and later	Support under consideration
TimeMachine function	Not supported	Supported in 850eserv2 V1.000 and later

5.1 Coverage Measurement Function

This section explains the functional outline of the coverage measurement function and differences in specifications that occur after the addition of this function.

5.1.1 Functional outline

The coverage measurement function is used to measure the percentage of the executed code in a load module, section, or other such area. After the addition of this function, the Code Coverage window will be added and the Source and Assemble windows will be modified in the debugger ID850QB, as follows.

- Code Coverage window

Displays the coverage (%) of the executed code for total code in a load module.

Displays the coverage (%) of the executed code separately by functions, sections and vectors.

- Source window and Assemble window

The executed lines are highlighted.

Refer to the user's manual for the debugger for details on use of the coverage measurement function.

5.1.2 Differences from hardware specifications

After addition of the coverage measurement function, differences from the hardware specifications described in this manual are as follows.

- External dimensions
The height increases by 9 mm.

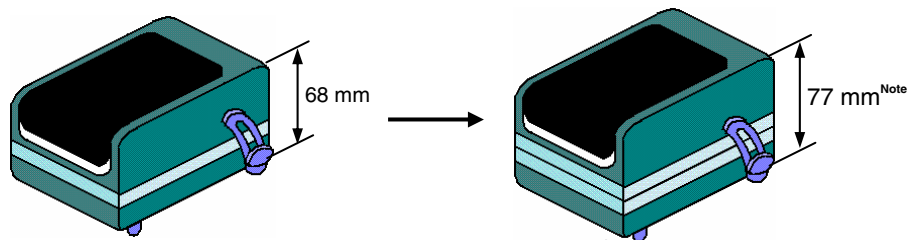

Note When the rear spacer is adjusted to the lowest height (107 mm max.)

- Weight
The weight increases by approximately 70 g.

5.2 TimeMachine Function

This function is supported by the Green Hills Software (GHS) debugger. For details on the functional outline and specifications, consult a GHS tool distributor.

5.3 Changes to Top Side of Product Consequent to Addition of Optional Functions

After the addition of the optional functions, the following stickers will be attached to the top of the QB-V850EIA4. The addition of the optional functions can be confirmed through the presence of these stickers.

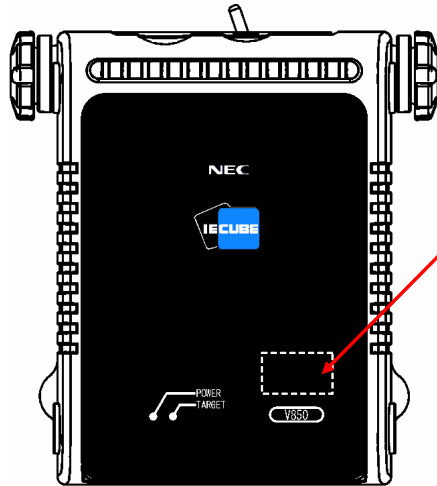

QB-V850EIA4 Top View

A sticker is attached to this position according to the function added, as follows.

For the coverage measuring function:



For the TimeMachine function:



5.4 How to Add Optional Functions

To add the optional functions, the option board corresponding to each function, as listed in the following, must be mounted.

Function	Option Board Required for Adding Function
Coverage measurement function	Coverage memory board ^{Note 1}
TimeMachine function	SuperTrace™ Probe board ^{Notes 1, 2}

- Notes**
1. Either the coverage memory board or the SuperTrace Probe board can be added, but not both.
 2. To use the TimeMachine function, the SuperTrace Probe (Green Hills Software (GHS)) must be mounted in the QB-V850EIA4, in addition to the SuperTrace Probe board.
For details on specifications and purchases, consult a GHS tool distributor.

The following two methods have been provided for mounting the option boards.

For more information on ordering, price and schedule, consult an NEC Electronics sales representative or distributor.

- New purchase

By adding one of the following suffixes at the end of the ordering code, you can purchase the QB-V850EIA4 with the corresponding option board mounted.

-C: Coverage memory board mounted

-S: SuperTrace Probe board mounted

Part number examples: QB-V850EIA4-ZZZ-S

- System upgrade

Using this method, the option board can be mounted in your QB-V850EIA4.

APPENDIX A REVISION HISTORY

A.1 Major Revisions in This Edition

Page	Description
CHAPTER 1 GENERAL	
p.13	Addition of Figure 1-2. System Configuration (T Type)
p.14	Addition of Table 1-4. List of Probe/Connector for Each Target Device (T Type)
p.15	Change of 1.4 Package Contents
CHAPTER 2 SETUP PROCEDURE	
p.26	Addition of 2.7 Mounting and Connecting Connectors (When Using T Type)

A.2 Revision History of Preceding Editions

Here is the revision history of the preceding editions. Chapter indicates the chapter of each edition.

Edition	Major Revision from Previous Edition	Applied to:
2nd edition	Table 1-3 List of Probe/Connector for Each Target Device Change of mount adapter from QB-100GF-MA-01S to QB-100GF-MA-02S	CHAPTER 1 GENERAL
	Figure B-13 Mount Adapter for V850E/IA4 (100-Pin GF Package) (QB-100GF-MA-02S) Change of part number of mount adapter	APPENDIX B PACKAGE DRAWINGS
3rd edition	Addition of QB-144-EP-02S as extension probe (flexible type)	Throughout
	Change of Figure 1-1. External Dimensions	CHAPTER 1 GENERAL
	Change of Table 1-2. QB-V850EIA4 System Specifications	
	Change of 1.3 System Configuration	
	Change of 2.3.1 Overview of clock settings	CHAPTER 2 SETUP PROCEDURE
	Change of 2.3.2 Clock setting methods	
	Addition of 4.1 Cautions Regarding Differences Between Actual Device And Emulator	CHAPTER 4 NOTES
	Addition of 4.2 Notes On Debugging	
	Addition of chapter	CHAPTER 5 OPTIONAL FUNCTIONS
	Deletion of chapter	CHAPTER 5 NOTES ON TARGET SYSTEM DESIGN in second edition
Deletion of chapter	APPENDIX A CHARACTERISTICS OF TARGET INTERFACE in second edition	
Deletion of chapter	APPENDIX B CHARACTERISTICS OF TARGET INTERFACE in second edition	

*For further information,
please contact:*

NEC Electronics Corporation
1753, Shimonumabe, Nakahara-ku,
Kawasaki, Kanagawa 211-8668,
Japan
Tel: 044-435-5111
<http://www.necel.com/>

[America]

NEC Electronics America, Inc.
2880 Scott Blvd.
Santa Clara, CA 95050-2554, U.S.A.
Tel: 408-588-6000
800-366-9782
<http://www.am.necel.com/>

[Europe]

NEC Electronics (Europe) GmbH
Arcadiastrasse 10
40472 Düsseldorf, Germany
Tel: 0211-65030
<http://www.eu.necel.com/>

Hanover Office

Podbielskistrasse 166 B
30177 Hannover
Tel: 0 511 33 40 2-0

Munich Office

Werner-Eckert-Strasse 9
81829 München
Tel: 0 89 92 10 03-0

Stuttgart Office

Industriestrasse 3
70565 Stuttgart
Tel: 0 711 99 01 0-0

United Kingdom Branch

Cygnus House, Sunrise Parkway
Linford Wood, Milton Keynes
MK14 6NP, U.K.
Tel: 01908-691-133

Succursale Française

9, rue Paul Dautier, B.P. 52
78142 Velizy-Villacoublay Cédex
France
Tel: 01-3067-5800

Sucursal en España

Juan Esplandiú, 15
28007 Madrid, Spain
Tel: 091-504-2787

Tyskland Filial

Täby Centrum
Entrance S (7th floor)
18322 Täby, Sweden
Tel: 08 638 72 00

Filiale Italiana

Via Fabio Filzi, 25/A
20124 Milano, Italy
Tel: 02-667541

Branch The Netherlands

Steijgerweg 6
5616 HS Eindhoven
The Netherlands
Tel: 040 265 40 10

[Asia & Oceania]

NEC Electronics (China) Co., Ltd
7th Floor, Quantum Plaza, No. 27 ZhiChunLu Haidian
District, Beijing 100083, P.R.China
Tel: 010-8235-1155
<http://www.cn.necel.com/>

Shanghai Branch

Room 2509-2510, Bank of China Tower,
200 Yincheng Road Central,
Pudong New Area, Shanghai, P.R.China P.C:200120
Tel:021-5888-5400
<http://www.cn.necel.com/>

Shenzhen Branch

Unit 01, 39/F, Excellence Times Square Building,
No. 4068 Yi Tian Road, Futian District, Shenzhen,
P.R.China P.C:518048
Tel:0755-8282-9800
<http://www.cn.necel.com/>

NEC Electronics Hong Kong Ltd.

Unit 1601-1613, 16/F., Tower 2, Grand Century Place,
193 Prince Edward Road West, Mongkok, Kowloon, Hong Kong
Tel: 2886-9318
<http://www.hk.necel.com/>

NEC Electronics Taiwan Ltd.

7F, No. 363 Fu Shing North Road
Taipei, Taiwan, R. O. C.
Tel: 02-8175-9600
<http://www.tw.necel.com/>

NEC Electronics Singapore Pte. Ltd.

238A Thomson Road,
#12-08 Novena Square,
Singapore 307684
Tel: 6253-8311
<http://www.sg.necel.com/>

NEC Electronics Korea Ltd.

11F., Samik Lavied'or Bldg., 720-2,
Yeoksam-Dong, Kangnam-Ku,
Seoul, 135-080, Korea
Tel: 02-558-3737
<http://www.kr.necel.com/>