

CN268-IEEE1588POCZ

IEEE 1588 Solution

Rev.0.1
Apr. 21, 2021

Description

The Precision Time Protocol (PTP) is implemented in accordance with IEEE 1588, “Standard for a Precision Clock Synchronization Protocol for Networked Measurement and Control Systems” (see references for NIST website for further details and history). The basic premise of this protocol is, not to guarantee timely delivery of Ethernet packets as some might think, but rather to keep the clocks within a PTP domain in Sync so that they can operate in harmony so to speak. So, the many applications for this are: • Motion control • Telecommunications • Measurement equipment • Any industrial application requiring precise synchronized operation of many nodes.

An over-simplified example might be a robotic machine that must move product by “handing” it from one robot to another. Without precise timing, the motion profiles must operate at reduced speeds so that product is not “Dropped”. With precision clocks, the master control can set up motion profiles where the product can be moved at the fastest possible rate, since everyone knows within microseconds or even nanoseconds when the “hand-off” must occur and run their motion profiles to meet this requirement

In general, a node joining the PTP domain can synchronize to the Master clock in less than a minute. Once synchronized, operations across nodes will happen in perfect time synchronization. Synchronization accuracies will be dependent on the Clock and Timestamp implementation. Typical numbers are given in Table 1.

Time Stamp Generation Point	Range of Accuracy
With Application (PTP Stack level)	milliseconds
ISR level	1-100 Microseconds
Hardware assisted Timestamp	10's of nanoseconds

Table 1: Clock Accuracy Range

In this demo we provide Hardware assisted timestamp through the use of an Ethernet PHY (88E1512P GbE) containing a hardware time stamping unit and an clock chip(8A34002) with high accuracy clock adjusting.

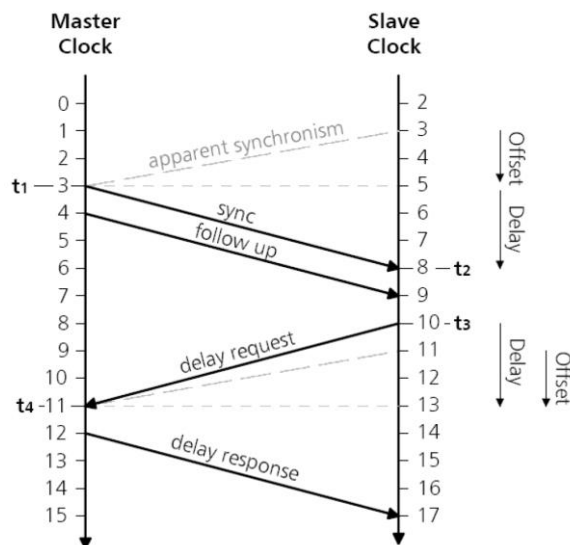

Figure 1 PTP Basic Sync Operation

CN268-IEEE1588POCZ solution

Specifications

The design specifications of the CN268-IEEE1588POCZ solution are shown in Table 2.

Parameters	Values
Jitter with no load	<50ns
Jitter with 5% and 95% with both side independently	<1us
Lock time	<10min
Support 8265.1	Yes
Support 8275.1	Yes

Table 2 IEEE1588 Specifications

Key Features

- Full IEEE1588 system solution
- Full support from system firmware to hardware
- High performance system by Renesas clock matrix and MPU
- Easy to test, easy to use, easy to copy.

References



Figure 2 Top View

Functional Description

IEEE 1588 is a precise time protocol (PTP) system used to synchronize clocks in computer networks. In local area network, it can control the clock accuracy in sub microsecond range, making it suitable for measurement and control system. With 5G coming, there are large number of base stations and IoT devices, which requires a large-scale network synchronization. Renesas synchronous timing device 8A34002 designed for IEEE 1588 applications. Renesas advanced clock recovery algorithms and precision timing devices reconstruct accurate synchronization signals for 5G network.

Quick Test Setup

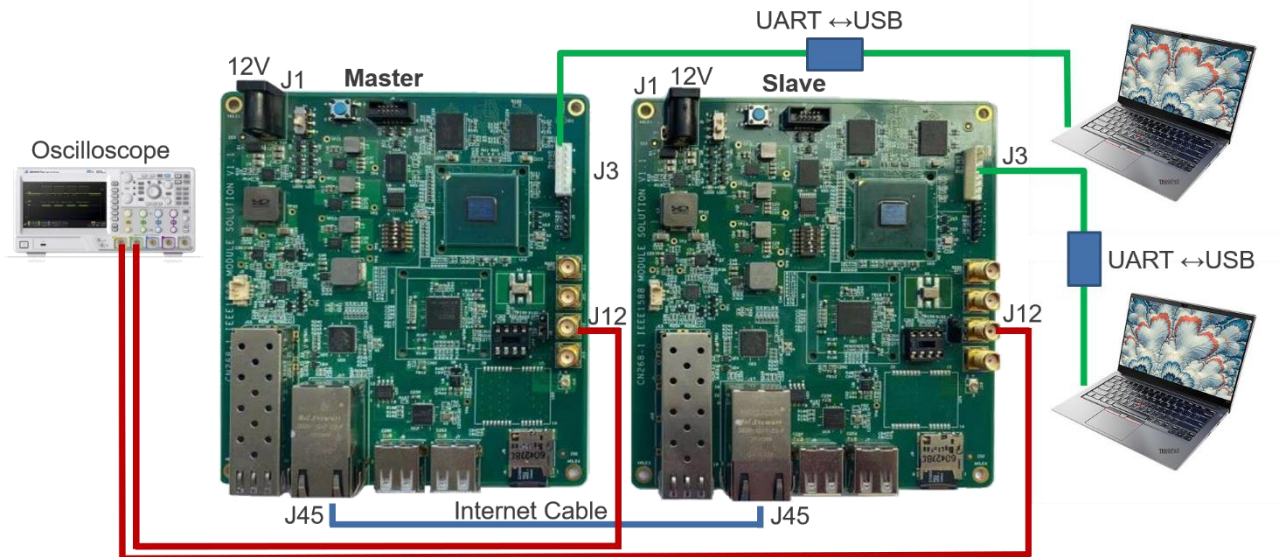

Figure 3 Quick Test Setup



Figure 4 Actual Test Setup

CN268-IEEE1588POCZ solution

Please set the software and hardware connection just as bellow table:

Item		Comment
Software	Tera Term	Please install Tera Term in PC
Hardware Connection	J3	Please connect J3 with Uart↔USB converter then connect to PC
	J12	Please connect J12 with oscilloscope
	J1	Please connect to 12V power supply
	J45	Please connect J45 of slave and master board together with Internet Cable

Table 3 Software and Hardware Connection

Please set TeraTerm connection parameters in [Setup]→[Serial port] of Tera Term

Board rate: 115200, Data: 8 bit, Parity: none, Stop bits: 1 bit

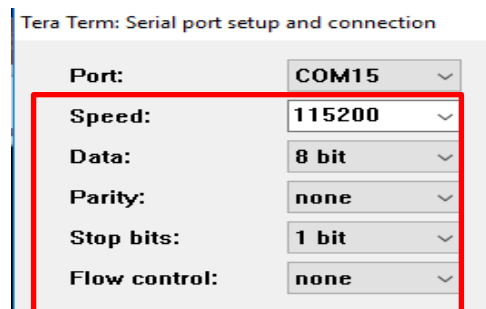

Figure 5 Communication Parameter Set

Please set oscilloscope as Intensity mode and set accum time as long as you want:

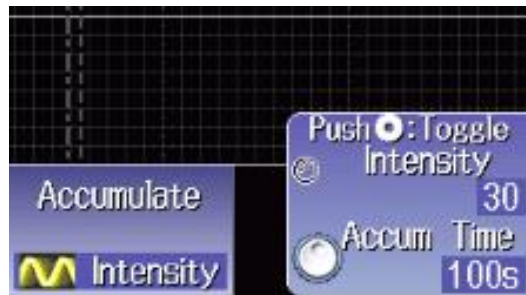

Figure 6 Oscilloscope Set

Other settings:

Power on set : Switch S1 to 2-3

1PPS output set : Connect J9 with 2-3

Operation Procedure

- After power on, master board and slave board will start automatically and running master operation and slave operation automatically, at last you will see bellow status, then both master board and slave board can operate normally. Customer also can observe the 1pps from master and slave in oscilloscope.

Master

```
ptp4l -i eth0 -f pcr4l_multicast_master.cfg -n -H
ptp4l[113.228]: selected /dev/ptp0 as PTP clock
ptp4l[113.235]: port 1: INITIALIZING to LISTENING on INIT_COMPLETE
ptp4l[113.235]: port 0: INITIALIZING to LISTENING on INIT_COMPLETE
ptp4l[126.649]: port 1: LISTENING to MASTER on ANNOUNCE_RECEIPT_TIMEOUT_EXPIRES
ptp4l[126.649]: selected local clock baf5b7.ffff.3f8908 as best master
ptp4l[126.649]: port 1: assuming the grand master role
```



Slave

```
ptp4l[118.186]: selected /dev/ptp1 as PTP clock
ptp4l[118.192]: port 1: INITIALIZING to LISTENING on INIT_COMPLETE
ptp4l[118.192]: port 0: INITIALIZING to LISTENING on INIT_COMPLETE
ptp4l[125.750]: selected local clock 2e7326.ffff.922a82 as best master
ptp4l[126.546]: port 1: new foreign master baf5b7.ffff.3f8908-1
ptp4l[130.546]: selected best master clock baf5b7.ffff.3f8908
ptp4l[130.546]: port 1: LISTENING to UNCALIBRATED on RS_SLAVE
ptp4l[132.483]: port 1: minimum delay request interval 2^-4
ptp4l[132.749]: port 1: UNCALIBRATED to SLAVE on MASTER_CLOCK_SELECTED
ptp4l[133.438]: rms 56369727 max 56370896 freq +183008 +/- 105641 delay 309 +/- 41
ptp4l[134.440]: rms 44561241 max 56367368 freq +148141 +/- 123754 delay 2168408 +/- 7510581
ptp4l[135.443]: rms 2833 max 4772 freq -9993 +/- 1412 delay 180 +/- 40
ptp4l[136.445]: rms 2259 max 2908 freq -2483 +/- 2376 delay 228 +/- 35
ptp4l[137.448]: rms 2267 max 2856 freq +1726 +/- 300 delay 290 +/- 18
ptp4l[138.450]: rms 740 max 1296 freq +1329 +/- 330 delay 279 +/- 13
ptp4l[139.453]: rms 129 max 188 freq +400 +/- 183 delay 270 +/- 4
ptp4l[140.454]: rms 157 max 184 freq +58 +/- 36 delay 262 +/- 2
ptp4l[141.456]: rms 64 max 108 freq +50 +/- 21 delay 261 +/- 2
ptp4l[142.458]: rms 12 max 16 freq +127 +/- 19 delay 264 +/- 2
ptp4l[143.460]: rms 12 max 16 freq +153 +/- 5 delay 264 +/- 2
ptp4l[144.462]: rms 6 max 12 freq +79 +/- 80 delay 264 +/- 2
```

- If want to stop slave PTP operation, for the first time after power on, please type “killall ptp4l” just like bellow, then using “Enter” Key of key board to confirm this line command.

Note: because it should be type when output continue in slave console, please write this “killall ptp4l” + “Enter” in text file, then past it to Tera Term.

```
ptp4l[188.557]: rms 28 max 32 freq +0 +/- 0 delay 264 +/- 2
ptp4l[189.559]: rms 23 max 28 freq +0 +/- 0 delay 264 +/- 2
killall ptp4l
```

- If want to restart slave PTP operation, please type “sh /usr/bin/start.sh” just like bellow:

```
root@ek874:~# sh /usr/bin/start.sh
ts2phc -nq -f /renesas/linuxptp/ts2phc.cfg &
PTP_PIN SETFUNC failed: Invalid argument
ts2phc[346.608]: Failed to set the pin. Continuing bravely on...
ptp4l -nqs -p /dev/ptp1 -f /renesas/ptp4l/udp_multicast.cfg
ptp4l[351.630]: selected /dev/ptp1 as PTP clock
ptp4l[351.632]: port 1: taking /dev/ptp1 from the command line, not the attached ptp0
ptp4l[351.634]: port 1: INITIALIZING to LISTENING on INIT_COMPLETE
ptp4l[351.634]: port 0: INITIALIZING to LISTENING on INIT_COMPLETE
ptp4l[352.559]: port 1: new foreign master baf5b7.ffff.3f8908-1
ptp4l[356.560]: selected best master clock baf5b7.ffff.3f8908
ptp4l[356.560]: port 1: LISTENING to UNCALIBRATED on RS_SLAVE
ptp4l[358.320]: port 1: minimum delay request interval 2^-4
ptp4l[358.567]: port 1: UNCALIBRATED to SLAVE on MASTER_CLOCK_SELECTED
ptp4l[359.318]: rms 1087 max 1516 freq +1609 +/- 922 delay 287 +/- 23
ptp4l[360.320]: rms 276 max 380 freq +602 +/- 355 delay 271 +/- 6
ptp4l[361.323]: rms 311 max 376 freq -38 +/- 58 delay 261 +/- 3
ptp4l[362.325]: rms 108 max 188 freq -3 +/- 46 delay 262 +/- 3
ptp4l[363.328]: rms 17 max 24 freq +127 +/- 26 delay 264 +/- 2
ptp4l[364.331]: rms 19 max 24 freq +168 +/- 4 delay 264 +/- 2
```

CN268-1 IEEE1588 solution

4. If you want to stop again, please use “Ctrl +C “on key board.

```
ptp4l[118.186]: selected /dev/ptp1 as PTP clock
ptp4l[118.192]: port 1: INITIALIZING to LISTENING on INIT_COMPLETE
ptp4l[118.192]: port 0: INITIALIZING to LISTENING on INIT_COMPLETE
ptp4l[125.750]: selected local clock 2e7326.ffe.922a82 as best master
ptp4l[126.546]: port 1: new foreign master baf5b7.ffe.3f8908-1
ptp4l[130.546]: selected best master clock baf5b7.ffe.3f8908
ptp4l[130.546]: port 1: LISTENING to UNCALIBRATED on RS_SLAVE
ptp4l[132.483]: port 1: minimum delay request interval 2^-4
ptp4l[132.749]: port 1: UNCALIBRATED to SLAVE on MASTER_CLOCK_SELECTED
ptp4l[133.438]: rms 56369727 max 56370896 freq +183008 +/- 105641 delay 309 +/-
- 41
ptp4l[134.440]: rms 44561241 max 56367368 freq +148141 +/- 123754 delay 2168408
+/- 7510581
ptp4l[135.443]: rms 2833 max 4772 freq -9993 +/- 1412 delay 180 +/- 40
ptp4l[136.445]: rms 2259 max 2908 freq -2483 +/- 2376 delay 228 +/- 35
ptp4l[137.448]: rms 2267 max 2856 freq +1726 +/- 300 delay 290 +/- 18
ptp4l[138.450]: rms 740 max 1296 freq +1329 +/- 330 delay 279 +/- 13
ptp4l[139.453]: rms 129 max 188 freq +400 +/- 183 delay 270 +/- 4
ptp4l[140.454]: rms 157 max 184 freq +58 +/- 36 delay 262 +/- 2
ptp4l[141.456]: rms 64 max 108 freq +50 +/- 21 delay 261 +/- 2
ptp4l[142.458]: rms 12 max 16 freq +127 +/- 19 delay 264 +/- 2
ptp4l[143.460]: rms 12 max 16 freq +153 +/- 5 delay 264 +/- 2
ptp4l[144.462]: rms 0 max 12 freq +29 +/- 80 delay 258 +/- 2
```

RMS: Offset root mean square

Max: Maximum absolute offset

Freq: Frequency offset mean and

+/-: Standard deviation

Delay: Path delay mean

+/-: Standard deviation.

All the unit is nanoseconds

CN268-IEEE1588POCZ solution

CN268-IEEE1588POCZ solution Circuit Schematic

As the whole schematic has 20 pages, it will not be shown here. Please check the relevant design documents for reference.

PAGE	DESCRIPTION
1	Index
2-5	Power Supply
6-11	MCU
12	Mode Setting
13-14	DDR3
15	QSPI, SD
16	USB Host
17-18	BA34002 Circuit
19	Ethernet
20	GPS

Revision History

Rev. Code	Date	Description
V1.0	2020.11.06	Initial Draft
V1.1	2021.02.26	1. Update the version to V1.1 2. Change the net D12.0V to D1.8V in R15 3. Revise UART pins from GPIO012&GPIO013 to GPIO208&GPIO207 in U26 4. Revise UART pins from GPIO501&GPIO502 to GPIO210&GPIO209 in J5 5. Revise SFP power supply from 2.5V to 3.3V, and related connection in J15

RECH/SST

CN268-1 IEEE1588 Module Solution

CN268-1 IEEE1588 Module Solution		
Index		
Version: V1.1	Author: SST	http://renesas.com
Release Date: 2021.02.26	Sheet: 1 of 20	
File: CN268-1 IEEE1588 Index.SchDoc		

Bill of Materials

TABLE 4 BOM List (1/5)

Designator	Description	Manufacturer	Mfg Part Number	QTY
C1, C2, C7, C8, C9, C10	Ceramic Chip Capacitor 0805 22uF 25V	YAGEO	CC0805MKX5R8BB226	6
C3, C58, C64, C74, C75, C76, C77, C78, C79, C80, C81, C82, C83, C84, C85, C86, C87, C88, C89, C90, C91, C92, C93, C94, C95, C96, C97, C98, C99, C100, C101, C106, C107, C109, C111, C116, C120, C123, C125, C129, C132, C133, C136, C139, C140, C141, C143, C144, C145, C146, C148, C149, C152, C153, C168, C169, C170, C171, C172, C173, C174, C175, C176, C177, C178, C181, C182, C183, C184, C185, C199, C201, C202, C203, C204, C205, C206, C207, C208, C209, C210, C211, C212, C213, C214, C215, C216, C217, C218, C219, C220, C223, C224, C226, C227, C228, C229, C230, C231, C232, C233, C234, C235, C236, C237, C238, C239, C240, C241, C242, C243, C246, C247, C248, C249, C250, C251, C252, C255, C257, C258, C259, C261, C262, C263, C265, C266, C267	Ceramic Chip Capacitor 0201 0.1uF 16V	YAGEO	CC0201KRX5R7BB104	128
C4, C187, C189, C190	Ceramic Chip Capacitor 0201 1000pF 25V	YAGEO	CC0201KRX7R8BB102	4
C5	Ceramic Chip Capacitor 0402 8.2pF 50V	YAGEO	CC0402BRNPO9BN8R2	1
C6	Ceramic Chip Capacitor 0402 1uF 16V	YAGEO	CC0402KRX5R7BB105	1
C11, C12, C13, C14	Ceramic Chip Capacitor 1206 100uF 10V	TDK	C3216X5R1A107M160AC	4
C1, C2, C7, C8, C9, C10	Ceramic Chip Capacitor 0805 22uF 25V	YAGEO	CC0805MKX5R8BB226	6
C3, C58, C64, C74, C75, C76, C77, C78, C79, C80, C81, C82, C83, C84, C85, C86, C87, C88, C89, C90, C91, C92, C93, C94, C95, C96, C97, C98, C99, C100, C101, C106, C107, C109, C111, C116, C120, C123, C125, C129, C132, C133, C136, C139, C140, C141, C143, C144, C145, C146, C148, C149, C152, C153, C168, C169, C170, C171, C172, C173, C174, C175, C176, C177, C178, C181, C182, C183, C184, C185, C199, C201, C202, C203, C204, C205, C206, C207, C208, C209, C210, C211, C212, C213, C214, C215, C216, C217, C218, C219, C220, C223, C224, C226, C227, C228, C229, C230, C231, C232, C233, C234, C235, C236, C237, C238, C239, C240, C241, C242, C243, C246, C247, C248, C249, C250, C251, C252, C255, C257, C258, C259, C261, C262, C263, C265, C266, C267	Ceramic Chip Capacitor 0201 0.1uF 16V	YAGEO	CC0201KRX5R7BB104	128
C4, C187, C189, C190	Ceramic Chip Capacitor 0201 1000pF 25V	YAGEO	CC0201KRX7R8BB102	4
C5	Ceramic Chip Capacitor 0402 8.2pF 50V	YAGEO	CC0402BRNPO9BN8R2	1
C6	Ceramic Chip Capacitor 0402 1uF 16V	YAGEO	CC0402KRX5R7BB105	1
C11, C12, C13, C14	Ceramic Chip Capacitor 1206 100uF 10V	TDK	C3216X5R1A107M160AC	4
C15, C221, C268, C270, C272, C276, C280, C283, C285, C288, C291, C293, C295, C297, C299, C301, C303, C305, C307, C309, C310, C311, C314, C316, C318, C321, C323, C325, C326, C327, C328, C329, C331, C333, C334, C335, C337, C338, C340	Ceramic Chip Capacitor 0402 0.1uF 16V	YAGEO	CC0402KPX7R7BB104	39
C16, C110, C122, C135, C147, C166	Ceramic Chip Capacitor 0402 2.2uF 10V	YAGEO	CC0402KRX5R6BB225	6
C17, C18, C19, C20, C21, C22, C23, C24, C26, C27, C28, C29, C30, C31, C32, C33, C34, C35, C36, C37, C38, C39, C40, C41, C44, C45, C46, C47, C253, C260	Ceramic Chip Capacitor 0603 22uF 10V	YAGEO	CC0603MRX5R6BB226	30
C25, C42, C43, C54, C59	Ceramic Chip Capacitor 0201 10pF 25V	Murata	GRM0335C1E100GA01D	5
C48	Ceramic Chip Capacitor 0201 22pF 50V	YAGEO	CC0201JRNPO9BN220	1
C49, C51, C55, C57, C60, C62, C65, C113, C126, C165, C179, C180, C186, C192, C254, C256, C264, C287	Ceramic Chip Capacitor 0603 10uF 10V	YAGEO	CC0603MRX5R6BB106	18
C50, C53, C61, C188, C191	Ceramic Chip Capacitor 0201 4700pF 25V	YAGEO	CC0201KRX7R8BB472	5
C52, C56, C63, C102, C117, C118, C121, C130, C131, C156, C157, C158, C159, C160, C161, C162, C163, C164	Ceramic Chip Capacitor 0201 0.01uF 16V	Murata	GRM033R61C103KA12D	18
C66	Ceramic Chip Capacitor 0201 0.027uF 16V	Murata	GRM033R61C273ME84D	1
C67, C70	Ceramic Chip Capacitor 0201 0.039uF 16V	Murata	GRM033R61C393KE84D	2

TABLE 4 BOM List (2/5)

Designator	Description	Manufacturer	Mfg Part Number	QTY
C68	Ceramic Chip Capacitor 0201 0.012uF 16V	Murata	GRM033R61C123KE84D	1
C69	Ceramic Chip Capacitor 0201 0.033uF 16V	Murata	GRM033R61C333KE84D	1
C71	Ceramic Chip Capacitor 0201 5.6nF 16V	Murata	GRM033R61E562KA12D	1
C72	Ceramic Chip Capacitor 0201 0.056uF 16V	Murata	GRM033R61C563KE84D	1
C73	Ceramic Chip Capacitor 0201			0
C105	Ceramic Chip Capacitor 0402 10pF 50V	YAGEO	CC0402JRNPO9BN100	1
C108, C112, C114, C115, C119, C124, C127, C128, C134, C137, C138, C151, C154, C155	Ceramic Chip Capacitor 0201 1uF 10V	YAGEO	CC0201MRX5R6BB105	14
C142	Ceramic Chip Capacitor 0201 100pF 50V	YAGEO	CC0201JRNPO9BN101	1
C150	Ceramic Chip Capacitor 0201 470pF 25V	YAGEO	CC0201KRX7R8BB471	1
C167, C200, C225	Ceramic Chip Capacitor 0805 47uF 10V	TDK	C2012X5R1A476M125AC	3
C193, C194, C195, C196, C197, C198	Ceramic Chip Capacitor 0201 2200pF 25V	YAGEO	CC0201KRX7R8BB222	6
C269, C271, C273, C277, C281, C284, C286, C292, C294, C296, C298, C300, C302, C304, C306, C308, C313, C315, C317, C322, C324, C330, C332, C336, C339	Ceramic Chip Capacitor 0402 4.7uF 6.3V	YAGEO	CC0402MRX5R5BB475	25
C274, C275, C319, C320	Ceramic Chip Capacitor 0402 8pF 50V	YAGEO	CC0402DRNPO9BN8R0	4
C278	Ceramic Chip Capacitor 0402 0.1uF 16V	YAGEO	CC0402KPX7R7BB104	0
C279	Ceramic Chip Capacitor 0402 4.7uF 6.3V	YAGEO	CC0402MRX5R5BB475	0
C282, C289	Ceramic Chip Capacitor 0402 10uF 6.3V	YAGEO	CC0402MRX5R5BB106	2
C290	Ceramic Chip Capacitor 0402 2.2nF 50V	YAGEO	CC0402KRX7R9BB222	1
C312	Ceramic Chip Capacitor 0402 0.22uF 10V	YAGEO	CC0402KRX5R6BB224	1
D1	TVS DIODE 15V 24.4V DO214AC	Littelfuse Inc.	SMAJ15A	1
FB1	FERRITE BEAD 120 OHM 0402 1LN	Murata	BLM15EG121SZ1D	1
FB2	FERRITE BEAD 80 OHM 0402 1LN	Murata	BLM15PD800SN1D	1
FB3, FB4, FB5, FB6, FB8, FB9, FB10, FB11, FB12, FB13, FB14, FB15, FB16, FB17, FB18, FB19, FB20, FB21	Ferrite Bead,470ohm@100MHz,1A,SMD0603	Murata	BLM18PG471SN1D	18
FB7	Ferrite Bead,470ohm@100MHz,1A,SMD0603	Murata	BLM18PG471SN1D	0
HOLE1, HOLE2, HOLE3, HOLE4	COOLER			0
J1	Kobicon DC Jack 2.0mm TH	Kobiconn	163-7620E-E	1
J2	CONN HEADER SMD 3POS 1.25MM	Molex	0533980371	1
J3	CONN HEADER VERT 7POS 2MM	JST	B7B-PH-K-S(LF)(SN)	1
J4	CONN HEADER SMD 10POS 1.27MM	Samtec Inc.	FTSH-105-01-L-DV-007-K	1
J5	CONN HEADER VERT 6POS 2MM	Harwin Inc.	M22-2510605	1
J6	MICRO SD PUSH/PUSH SMALL 8C	Molex	5033981892	1
J7, J8	CONN RCPT USB2.0 TYPEA 4POS R/A	TE Connectivity	6364372-2	2
J9	Header 0.1" pitch 3pos 1x3	FCI	77311-818-03LF	1
J10, J11, J12, J13	CONN SMA JACK STR 50 OHM PCB	TE	5-1814832-1	4
J14	CONN IC DIP SOCKET 8POS TIN	Assmann WSW Components	A08-LC-TT	1
J15	CONN SFP+ RCPT 20POS SLD R/A SMD	Molex	0744410001	1
J16	CONN SFP CAGE PRESS-FIT R/A	Molex	0747370009	1
J17	CONN MAGJACK 1PORT 1000 BASE-T	Bel Fuse Inc.	0826-1G1T-23-F	1
J18	Antenna CONN U.FL RCPT STR 50 OHM SMD	TE Connectivity	1909763-1	1

TABLE 4 BOM List (3/5)

Designator	Description	Manufacturer	Mfg Part Number	QTY
L1	FIXED IND 1.5UH 20.4A 3.85MOHM	TDK	SPM10040T-1R5M-HZ	1
L2, L3, L4	FIXED IND 1UH 10.1A 11.44 MOHM	TDK	SPM5030T-1R0M	3
L5	FIXED IND 2.2UH 14.5A 9.41 MOHM	Vishay Dale	IHLP3232DZER2R2M11	1
L6, L7	FIXED IND 1UH 50MA 500 MOHM SMD	TDK	MLF1608A1R0JTD25	2
L8	FIXED IND 1UH 1.15A 60 MOHM SMD	TDK	MLZ2012N1R0LTD25	1
L9	FIXED IND 22NH 350MA 580 MOHM	Murata	LQG15HN22NJ02D	1
LED1, LED2	Lite-On LED Green Clear 0603	Lite-On	LTST-C191KGKT	2
M1, M2, M3, M4	IC DRAM 4G PARALLEL 78FBGA	Micron Technology Inc.	MT41K512M8DA-107 IT:P	4
N1, N2	COOLER			2
Q1, Q2, Q3, Q4, Q5, Q6, Q13, Q14	1.2V DRIVE NCH MOSFET	Rohm Semiconductor	RUC002N05HZGT116	8
Q7, Q8, Q9, Q10, Q11, Q12	N-CHANNEL MOSFET SOT-23	Micro Commercial Co	BSS138-TP	6
R1	Chip Resistor Thick Film 0402 47K 1% 1/16W	YAGEO	RC0402FR-0747KL	1
R2, R4	Chip Resistor Thick Film 0402 6.8K 1% 1/16W	YAGEO	RC0402FR-076K8L	2
R3, R11, R33, R54, R55, R56, R57, R71, R72, R73, R74, R75, R79, R80, R81, R92, R117, R118, R119, R120, R121, R129, R133, R134, R135, R137, R170, R171, R172, R173, R174, R175, R176, R177, R182, R183, R184, R185, R186, R187, R188, R189, R190	Chip Resistor Thick Film 0402 10K 1% 1/16W	YAGEO	RC0402FR-0710KL	43
R5, R14, R24, R39, R43, R49, R66, R69, R70, R82, R84, R85, R86, R87, R88, R89, R90, R91, R105, R107, R109, R110, R111, R168, R178, R179, R203, R241, R245, E2	Chip Resistor Thick Film 0402 0R 1% 1/16W	YAGEO	RC0402JR-070RL	30
R6, R18, R19	Chip Resistor Thick Film 0402 330K 1% 1/16W	YAGEO	RC0402FR-07330KL	3
R7	Chip Resistor Thick Film 0402 26.1K 1% 1/16W	YAGEO	RC0402FR-0726K1L	1
R8, R20, R21	Chip Resistor Thick Film 0402 57.6K 1% 1/16W	YAGEO	RC0402FR-0757K6L	3
R9, R68, R169, R242, E1	Chip Resistor Thick Film 0402 0R 1% 1/16W	YAGEO	RC0402JR-070RL	0
R10	Chip Resistor Thick Film 0402 200R 1% 1/16W	YAGEO	RC0402FR-07200RL	1
R12	Chip Resistor Thick Film 0402 365K 1% 1/16W	YAGEO	RC0402FR-07365KL	1
R13	Chip Resistor Thick Film 0402 49.9K 1% 1/16W	YAGEO	RC0402FR-0749K9L	1
R15, R41, R48, R51, R77, R150, R165	Chip Resistor Thick Film 0402 1K 1% 1/16W	YAGEO	RC0402FR-071KL	7
R16, R17, R22, R26, R27, R34, R78, R122, R123, R124, R130, R131	Chip Resistor Thick Film 0402 100K 1% 1/16W	YAGEO	RC0402FR-07100KL	12
R23	Chip Resistor Thick Film 0402 21.5K 0.1% 1/16W	YAGEO	RT0402BRE0721K5L	1
R25, R28	Chip Resistor Thick Film 0402 30K 0.1% 1/16W	YAGEO	RT0402BRE0730KL	2
R29, R30	Chip Resistor Thick Film 0402 15K 0.1% 1/16W	YAGEO	RT0402BRE0715KL	2
R31	Chip Resistor Thick Film 0402 12K 0.1% 1/16W	YAGEO	RT0402BRD0712KL	1
R32	Chip Resistor Thick Film 0402 453K 1% 1/16W	YAGEO	RC0402FR-07453KL	1
R35, R44	Chip Resistor Thick Film 0402 1.62K 1% 1/16W	YAGEO	RC0402FR-071K62L	2
R36, R40, R45	Chip Resistor Thick Film 0402 5.6K 1% 1/16W	YAGEO	RC0402FR-075K6L	3
R37, R46	Chip Resistor Thick Film 0402 2.15K 1% 1/16W	YAGEO	RC0402FR-072K15L	2
R38, R47	Chip Resistor Thick Film 0402 1.87K 1% 1/16W	YAGEO	RC0402FR-071K87L	2
R42	Chip Resistor Thick Film 0402 1.4K 1% 1/16W	YAGEO	RC0402FR-071K4L	1
R50	Chip Resistor Thick Film 0402 8.45K 1% 1/16W	YAGEO	RC0402FR-078K45L	1

TABLE 4 BOM List (4/5)

Designator	Description	Manufacturer	Mfg Part Number	QTY
R52	Chip Resistor Thick Film 0402 3.3K 1% 1/16W	YAGEO	RC0402FR-073K3L	1
R53	Chip Resistor Thick Film 0402 1.47K 1% 1/16W	YAGEO	RC0402FR-071K47L	1
R58, R59, R60, R61, R62, R63, R232, R234, R236, R237, R238, R239	Chip Resistor Thick Film 0402 24.9R 1% 1/16W	YAGEO	RC0402FR-0724R9L	12
R64, R76, R257	Chip Resistor Thick Film 0402 22R 1% 1/16W	YAGEO	RT0402FRE0722RL	3
R65, R83, R126, R127, R128, R136	Chip Resistor Thick Film 0402 10K 1% 1/16W	YAGEO	RC0402FR-0710KL	0
R93	Chip Resistor Thick Film 0402 1.8K 1% 1/16W	YAGEO	RC0402FR-071K8L	1
R94, R95, R180, R204, R205, R206, R207, R208, R209, R211, R218, R253, R254	Chip Resistor Thick Film 0402 4.7K 1% 1/16W	YAGEO	RC0402FR-074K7L	0
R96, R97	Chip Resistor Thick Film 0402 10R 1% 1/16W	YAGEO	RC0402JR-0710RL	2
R98, R99	Chip Resistor Thick Film 0402 2K 1% 1/16W	YAGEO	RC0402FR-072KL	2
R100, R151, R152, R166, R167	Chip Resistor Thick Film 0402 240R 1% 1/16W	YAGEO	RC0402FR-07240RL	5
R101, R102, R103, R104, R106, R108	Chip Resistor Thick Film 0402 1R 1% 1/16W	YAGEO	RC0402FR-071RL	6
R112, R113, R114, R115, R116, R125, R132	Chip Resistor Thick Film 0402 1K 1% 1/16W	YAGEO	RC0402FR-071KL	0
R138, R139, R140, R141, R146, R147, R148, R149, R153, R154, R155, R156, R161, R162, R163, R164	Chip Resistor Thick Film 0402 20K 1% 1/16W	YAGEO	RC0402FR-0720KL	16
R142, R143	Chip Resistor Thick Film 0402 51R 1% 1/16W	YAGEO	RC0402FR-0751RL	2
R181	Chip Resistor Thick Film 0402 5.6K 1% 1/16W	YAGEO	RC0402FR-075K6L	0
R191	Chip Resistor Thick Film 0402 1K6 1% 1/16W	YAGEO	RC0402FR-071K6L	1
R192, R193, R194, R195, R196, R202, R220, R243, R255, R256	Chip Resistor Thick Film 0402 33R 5% 1/16W	YAGEO	RC0402JR-0733RL	10
R197	Chip Resistor Thick Film 0603 0R 1% 1/10W	YAGEO	RC0603FR-070RL	1
R198	Chip Resistor Thick Film 0603 0R 1% 1/10W	YAGEO	RC0603FR-070RL	0
R199	Chip Resistor Thick Film 0402 33R 5% 1/16W	YAGEO	RC0402JR-0733RL	0
R200, R201, R210, R212, R213, R214, R215, R216, R217, R219, R221, R222, R223, R224, R225, R226, R228, R229, R230, R231, R233, R235, R240, R244, R251, R252	Chip Resistor Thick Film 0402 4.7K 1% 1/16W	YAGEO	RC0402FR-074K7L	26
R246	Chip Resistor Thick Film 0402 4.99K 1% 1/16W	YAGEO	RC0402FR-074K99L	1
R247, R248	Chip Resistor Thick Film 0402 49.9R 1% 1/16W	YAGEO	RC0402FR-0749R9L	2
R249	Chip Resistor Thick Film 0402 470R 1% 1/16W	YAGEO	RC0402FR-07470RL	1
R250, R258, R259	Chip Resistor Thick Film 0402 100R 1% 1/16W	YAGEO	RC0402FR-07100RL	3
RA1, RA2, RA3, RA4, RA5	Chip Resistor Array 0804 10R 5% 1/16W 4 x 0402	YAGEO	YC124-JR-0710RL	5
RA6, RA7	Chip Resistor Array 0804 100K 5% 1/16W 4 x 0402	YAGEO	YC124-JR-07100KL	2
RA8, RA9	Chip Resistor Array 0804 10K 5% 1/16W 4 x 0402	YAGEO	YC124-JR-0710KL	2
S1	SWITCH SLIDE DPDT 200MA 12V	Nidec Copal Electronics	CL-SB-22B-02T	1
S2	Push Button Switch 6 x 6mm 4.3mm High	C&K	PTS645SM43SMTR92 LFS	1
SW1	SW 6P SPST DIP 25mA 24V SMT	CTS	218-6LPSTR	1
TP1, TP2, TP3, TP4, TP5, TP6, TP7, TP8, TP9, TP10, TP11, TP12, TP13	Test Point			0

TABLE 4 BOM List (5/5)

Designator	Description	Manufacturer	Mfg Part Number	QTY
U1	IC REG BUCK ADJ 14A 15TQFN	Renesas	ISL85014FRZ-T7A	1
U2	IC REG BUCK ADJUSTABLE 8A 20QFN	Renesas	ISL8018IRAJZ-T7A	1
U3, U4	IC REG BUCK ADJUSTABLE 6A 20QFN	Renesas	ISL8016IRAJZ-T	2
U5	IC REG BUCK ADJUSTABLE 3A 8DFN	Intersil	ISL80031AFRZ-T7A	1
U6, U7, U8	IC REG LINEAR POS ADJ 1A 8-DFN (3x3)	Intersil	ISL80510IRAJZ-T7A	3
U9	IC POWER SUPPLY SEQUENCER 24QFN	Renesas	ISL8723IRZ	1
U10	Renesas RZ/G2E MCU	Renesas	R8A774C0	1
U12, U13, U15	IC BUF NON-INVERT 5.5V 5TSSOP	TI	74LVC1G125GW	3
U14	IC BUF NON-INVERT 5.5V 5TSSOP	TI	SN74LV1T34DCK	1
U16	IC INVERTER SCHMITT 2CH SC70-6	ON Semiconductor	NC7WP14P6X	1
U17	IC QUAD1:2 FET MUX/DEMUX 16TSSOP	TI	SN74CB3Q3257PWR	1
U18	IC FLASH 512M SPI 24TFBGA	Winbond	W25M512JVBIQ	1
U19	IC USB CONTROLLER 40VQFN	Renesas	uPD720115K8-711-BAK-A	1
U20	IC PWR SWITCH N-CHAN 1:2 8SOIC	TI	TPS2042BDR	1
U21	Synchronization Management Unit	Renesas	8A34002E-000NLG	1
U23	Integrated 10/100/1000 Mbps Energy Efficient Ethernet Transceiver	Marvell	88E1512P	1
U24	IC GATE AND 1CH 2-INP SC70-5	TI	SN74AUC1G08DCKR	1
U25	IC GATE AND 1CH 2-INP USV	Toshiba	TC7SH08FU	1
U26	LEA-6T u-blox 6 timing GPS modules	u-blox	LEA-6T-1-001	0
X1	XTAL OSC XO 125.0000MHZ CMOS SMD	EPSON	SG-210SCH 125.0000ML5	1
X2	XTAL OSC XO 48.0000MHZ CMOS SMD	Kyocera	KC2520K48.0000C1GE00	1
X3	XTAL OSC XO 24.0000MHZ CMOS SMD	Kyocera	KC2520B24.0000C1GE00	1
X4	CRYSTAL 50.0000MHz 8pF 1.6x1.2 SMD	TXC	8Q50077001	1
X5	TCXO Oscillator 12.8MHz	Connor-Winfield	M100F-012.8M	1
X6	CRYSTAL 25.0000MHz 8pF 1.6x1.2 SMD	TXC	8Q25070009	1

Board Layout

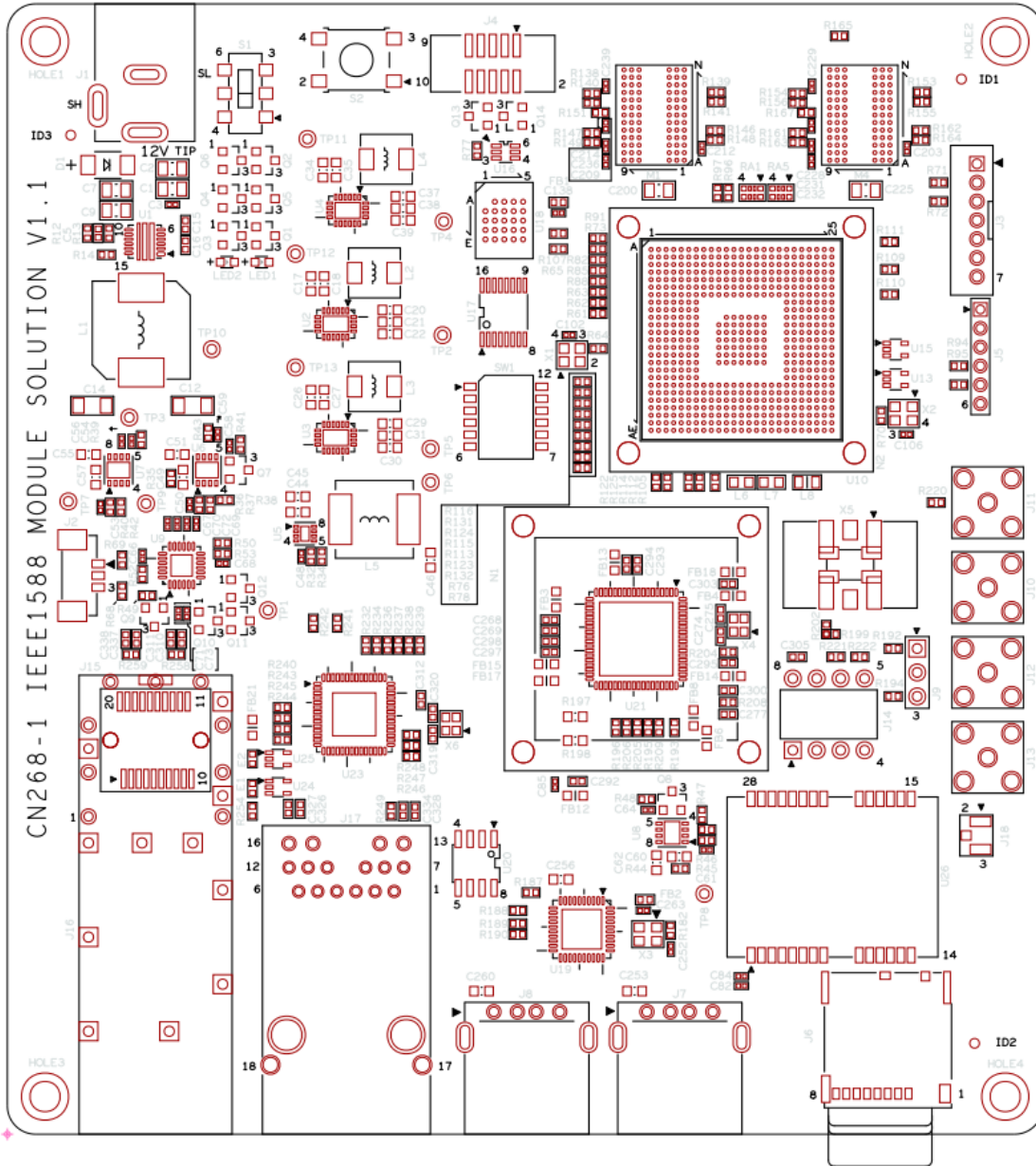

Figure 7 Silkscreen TOP

Revision History

Rev.	Date	Description	
		Page	Summary
0.1	Apr. 21, 2021	—	First edition issued

General Precautions in the Handling of Micro processing Unit and Microcontroller Unit Products

The following usage notes are applicable to all Micro processing unit and Microcontroller unit products from Renesas. For detailed usage notes on the products covered by this document, refer to the relevant sections of the document as well as any technical updates that have been issued for the products.

1. Precaution against Electrostatic Discharge (ESD)

A strong electrical field, when exposed to a CMOS device, can cause destruction of the gate oxide and ultimately degrade the device operation. Steps must be taken to stop the generation of static electricity as much as possible, and quickly dissipate it when it occurs. Environmental control must be adequate. When it is dry, a humidifier should be used. This is recommended to avoid using insulators that can easily build up static electricity. Semiconductor devices must be stored and transported in an anti-static container, static shielding bag or conductive material. All test and measurement tools including work benches and floors must be grounded. The operator must also be grounded using a wrist strap. Semiconductor devices must not be touched with bare hands. Similar precautions must be taken for printed circuit boards with mounted semiconductor devices.

2. Processing at power-on

The state of the product is undefined at the time when power is supplied. The states of internal circuits in the LSI are indeterminate and the states of register settings and pins are undefined at the time when power is supplied. In a finished product where the reset signal is applied to the external reset pin, the states of pins are not guaranteed from the time when power is supplied until the reset process is completed. In a similar way, the states of pins in a product that is reset by an on-chip power-on reset function are not guaranteed from the time when power is supplied until the power reaches the level at which resetting is specified.

3. Input of signal during power-off state

Do not input signals or an I/O pull-up power supply while the device is powered off. The current injection that results from input of such a signal or I/O pull-up power supply may cause malfunction and the abnormal current that passes in the device at this time may cause degradation of internal elements. Follow the guideline for input signal during power-off state as described in your product documentation.

4. Handling of unused pins

Handle unused pins in accordance with the directions given under handling of unused pins in the manual. The input pins of CMOS products are generally in the high-impedance state. In operation with an unused pin in the open-circuit state, extra electromagnetic noise is induced near the LSI, an associated shoot-through current flows internally, and malfunctions occur due to the false recognition of the pin state as an input signal become possible.

5. Clock signals

After applying a reset, only release the reset line after the operating clock signal becomes stable. When switching the clock signal during program execution, wait until the target clock signal is stabilized. When the clock signal is generated with an external resonator or from an external oscillator during a reset, ensure that the reset line is only released after full stabilization of the clock signal. Additionally, when switching to a clock signal produced with an external resonator or by an external oscillator while program execution is in progress, wait until the target clock signal is stable.

6. Voltage application waveform at input pin

Waveform distortion due to input noise or a reflected wave may cause malfunction. If the input of the CMOS device stays in the area between V_{IL} (Max.) and V_{IH} (Min.) due to noise, for example, the device may malfunction. Take care to prevent chattering noise from entering the device when the input level is fixed, and also in the transition period when the input level passes through the area between V_{IL} (Max.) and V_{IH} (Min.).

7. Prohibition of access to reserved addresses

Access to reserved addresses is prohibited. The reserved addresses are provided for possible future expansion of functions. Do not access these addresses as the correct operation of the LSI is not guaranteed.

8. Differences between products

Before changing from one product to another, for example to a product with a different part number, confirm that the change will not lead to problems. The characteristics of a micro processing unit or microcontroller unit products in the same group but having a different part number might differ in terms of internal memory capacity, layout pattern, and other factors, which can affect the ranges of electrical characteristics, such as characteristic values, operating margins, immunity to noise, and amount of radiated noise. When changing to a product with a different part number, implement a system-evaluation test for the given product.

Notice

1. Descriptions of circuits, software and other related information in this document are provided only to illustrate the operation of semiconductor products and application examples. You are fully responsible for the incorporation or any other use of the circuits, software, and information in the design of your product or system. Renesas Electronics disclaims any and all liability for any losses and damages incurred by you or third parties arising from the use of these circuits, software, or information.
2. Renesas Electronics hereby expressly disclaims any warranties against and liability for infringement or any other claims involving patents, copyrights, or other intellectual property rights of third parties, by or arising from the use of Renesas Electronics products or technical information described in this document, including but not limited to, the product data, drawings, charts, programs, algorithms, and application examples.
3. No license, express, implied or otherwise, is granted hereby under any patents, copyrights or other intellectual property rights of Renesas Electronics or others.
4. You shall not alter, modify, copy, or reverse engineer any Renesas Electronics product, whether in whole or in part. Renesas Electronics disclaims any and all liability for any losses or damages incurred by you or third parties arising from such alteration, modification, copying or reverse engineering.
5. Renesas Electronics products are classified according to the following two quality grades: "Standard" and "High Quality". The intended applications for each Renesas Electronics product depends on the product's quality grade, as indicated below.
 - "Standard": Computers; office equipment; communications equipment; test and measurement equipment; audio and visual equipment; home electronic appliances; machine tools; personal electronic equipment; industrial robots; etc.
 - "High Quality": Transportation equipment (automobiles, trains, ships, etc.); traffic control (traffic lights); large-scale communication equipment; key financial terminal systems; safety control equipment; etc.
6. Unless expressly designated as a high reliability product or a product for harsh environments in a Renesas Electronics data sheet or other Renesas Electronics document, Renesas Electronics products are not intended or authorized for use in products or systems that may pose a direct threat to human life or bodily injury (artificial life support devices or systems; surgical implantations; etc.), or may cause serious property damage (space system; undersea repeaters; nuclear power control systems; aircraft control systems; key plant systems; military equipment; etc.). Renesas Electronics disclaims any and all liability for any damages or losses incurred by you or any third parties arising from the use of any Renesas Electronics product that is inconsistent with any Renesas Electronics data sheet, user's manual or other Renesas Electronics document.
6. When using Renesas Electronics products, refer to the latest product information (data sheets, user's manuals, application notes, "General Notes for Handling and Using Semiconductor Devices" in the reliability handbook, etc.), and ensure that usage conditions are within the ranges specified by Renesas Electronics with respect to maximum ratings, operating power supply voltage range, heat dissipation characteristics, installation, etc. Renesas Electronics disclaims any and all liability for any malfunctions, failure or accident arising out of the use of Renesas Electronics products outside of such specified ranges.
7. Although Renesas Electronics endeavors to improve the quality and reliability of Renesas Electronics products, semiconductor products have specific characteristics, such as the occurrence of failure at a certain rate and malfunctions under certain use conditions. Unless designated as a high reliability product or a product for harsh environments in a Renesas Electronics data sheet or other Renesas Electronics document, Renesas Electronics products are not subject to radiation resistance design. You are responsible for implementing safety measures to guard against the possibility of bodily injury, injury or damage caused by fire, and/or danger to the public in the event of a failure or malfunction of Renesas Electronics products, such as safety design for hardware and software, including but not limited to redundancy, fire control and malfunction prevention, appropriate treatment for aging degradation or any other appropriate measures. Because the evaluation of microcomputer software alone is very difficult and impractical, you are responsible for evaluating the safety of the final products or systems manufactured by you.
8. Please contact a Renesas Electronics sales office for details as to environmental matters such as the environmental compatibility of each Renesas Electronics product. You are responsible for carefully and sufficiently investigating applicable laws and regulations that regulate the inclusion or use of controlled substances, including without limitation, the EU RoHS Directive, and using Renesas Electronics products in compliance with all these applicable laws and regulations. Renesas Electronics disclaims any and all liability for damages or losses occurring as a result of your noncompliance with applicable laws and regulations.
9. Renesas Electronics products and technologies shall not be used for or incorporated into any products or systems whose manufacture, use, or sale is prohibited under any applicable domestic or foreign laws or regulations. You shall comply with any applicable export control laws and regulations promulgated and administered by the governments of any countries asserting jurisdiction over the parties or transactions.
10. It is the responsibility of the buyer or distributor of Renesas Electronics products, or any other party who distributes, disposes of, or otherwise sells or transfers the product to a third party, to notify such third party in advance of the contents and conditions set forth in this document.
11. This document shall not be reprinted, reproduced or duplicated in any form, in whole or in part, without prior written consent of Renesas Electronics.
12. Please contact a Renesas Electronics sales office if you have any questions regarding the information contained in this document or Renesas Electronics products.

(Note1) "Renesas Electronics" as used in this document means Renesas Electronics Corporation and also includes its directly or indirectly controlled subsidiaries.

(Note2) "Renesas Electronics product(s)" means any product developed or manufactured by or for Renesas Electronics.

(Rev.4.0-1 November 2017)

Corporate Headquarters

TOYOSU FORESIA, 3-2-24 Toyosu,

Koto-ku, Tokyo 135-0061, Japan

www.renesas.com

Trademarks

Renesas and the Renesas logo are trademarks of Renesas Electronics Corporation. All trademarks and registered trademarks are the property of their respective owners.

Contact information

For further information on a product, technology, the most up-to-date version of a document, or your nearest sales office, please visit:

www.renesas.com/contact/.