

Introduction

The ISL9212EVAL1Z is the evaluation board for the ISL9212 double-fault tolerant charging system solution. The components for the entire solution are placed inside the white rectangular box (see Figure 1). The system mainly consists of the ISL6292C charging IC and the ISL9212 protection IC. The ISL6292C is an integrated Li-ion battery charger with the charge current set at 0.5A (refer to the ISL6292C datasheet for more information). The ISL9212 protects the charging system against three types of failures:

- Input overvoltage when the AC adapter fails to regulate its voltage under 6.5V
- Load overcurrent when failures such as a short circuit occurs in the charging system
- Battery over charge

When any single failure occurs in the charging system, the ISL6292C Output node will not output a voltage higher than 4.5V nor a current higher than the set current limit (1A for this board).

As shown in Figure 1, the evaluation board has multiple test points for the convenience of evaluation. The upper half of the board contains connectors for the power connection. The lower half contains test points for easy access to various pins of the two ICs.

This application note introduces the ISL9212EVAL1Z evaluation board and the ISL9212 behavior based on the board.

ISL9212EVAL1Z Photo

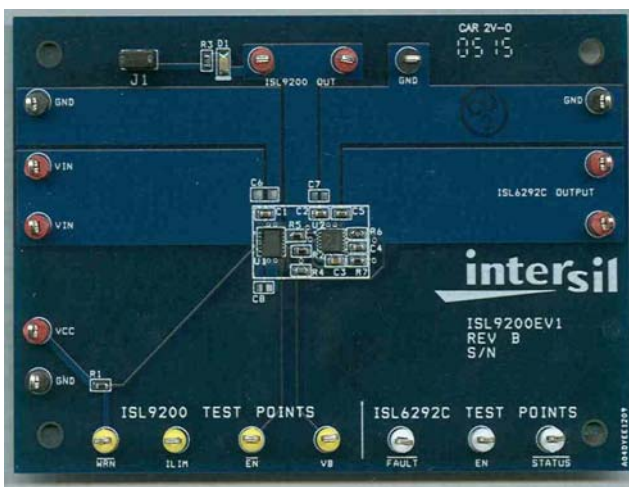

FIGURE 1. PHOTO OF THE ISL9212EVAL1Z

Design Specification

The design specifications are given in Table 1.

TABLE 1. DESIGN SPECIFICATIONS

SPECIFICATION	MIN	TYP	MAX	UNIT
Input OVP Threshold	6.65	6.80	7.00	V
Overcurrent Protection Threshold	-	1.0	-	A
Battery OVP Threshold	-	4.34	4.40	V
Input Voltage	-	-	30	V
Charge Current	-	0.5	-	A
Charger Output Voltage	4.20	4.25	4.30	V

Schematic, Layout, and BOM

The schematic, layout and the BOM for the evaluation board are shown in Figures 21, 22, and Table 2 respectively.

Evaluation Waveforms

This section introduces the waveforms captured using the ISL9212EVAL1Z to verify the functionality of the ISL9212.

Power-up

There are two ways to power-up the evaluation board. One way is to connect an ac adapter or the power supply to the evaluation board and then turn on the power. The second way is to connect the supply to the evaluation board after the supply is powered up (hot insertion).

Figure 2 shows the first way. Approximately 10ms after the input voltage rises to 5V, the ISL9212 begins the soft-start process. The 10ms delay allows any transient to settle down before the start-up, which is demonstrated during the hot insertion. The blue waveform is the load current into a 10Ω resistive load.

Figure 3 shows the captured waveforms during the hot insertion of the power supply. The input overshoot caused by the resonance of the parasitic inductance of the supply cable and the ceramic input decoupling capacitor is clearly shown. Figure 4 shows the zoomed-in view of Figure 3 at the power-up moment. The transient is completed before the ISL9212 starts to turn on.

Evaluation Waveforms

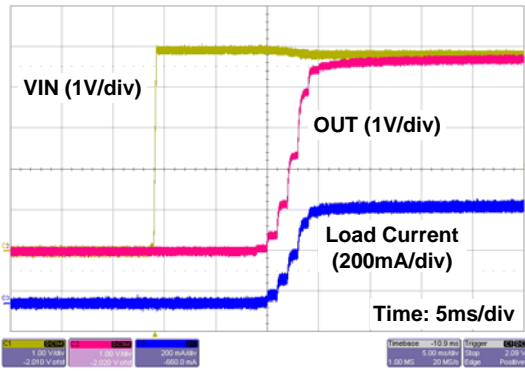

FIGURE 2. CAPTURED WAVEFORMS FOR POWER-UP. THE OUTPUT IS LOADED WITH A 10Ω RESISTOR

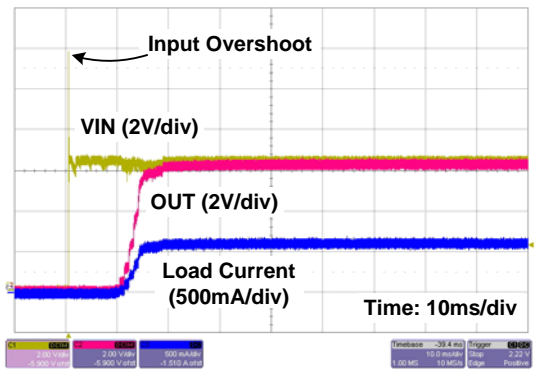

FIGURE 3. CAPTURED WAVEFORMS FOR HOT INSERTION OF THE POWER SUPPLY

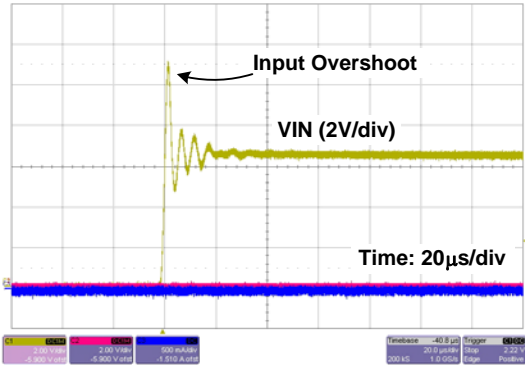

FIGURE 4. ZOOMED-IN VIEW OF FIGURE 3

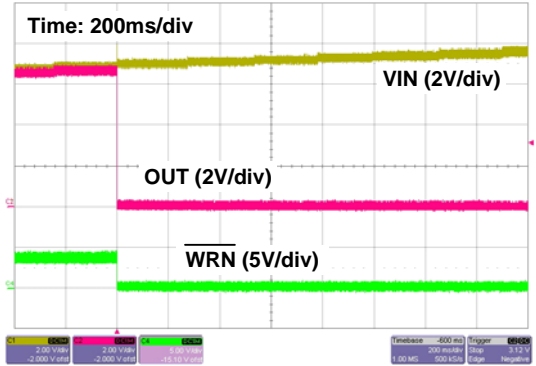

FIGURE 5. THE INPUT RISES GRADUALLY AND EXCEEDS THE INPUT OVP THRESHOLD

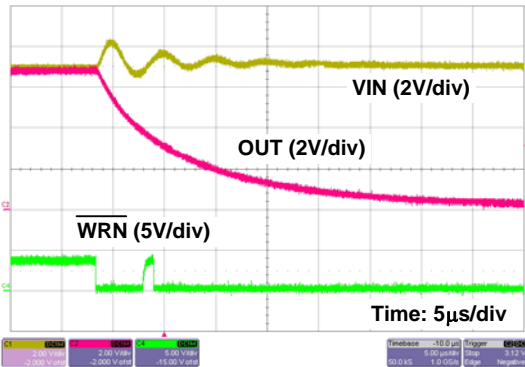

FIGURE 6. THE ZOOMED-IN VIEW OF FIGURE 5

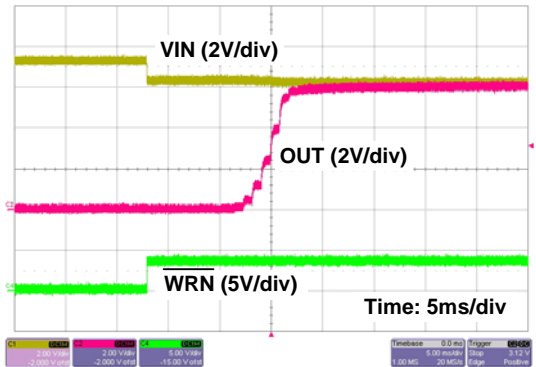

FIGURE 7. THE INPUT RISES GRADUALLY AND EXCEEDS THE INPUT OVP THRESHOLD

Evaluation Waveforms (Continued)

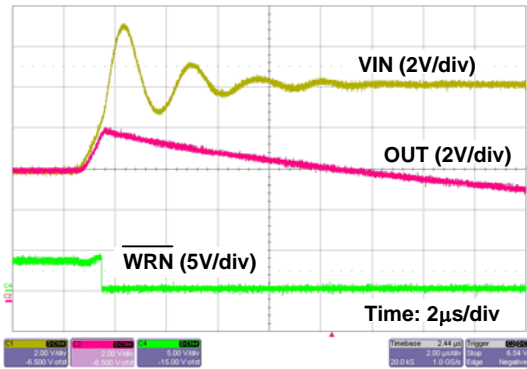

FIGURE 8. THE INPUT RISES QUICKLY FROM 6.5V TO 10.5V

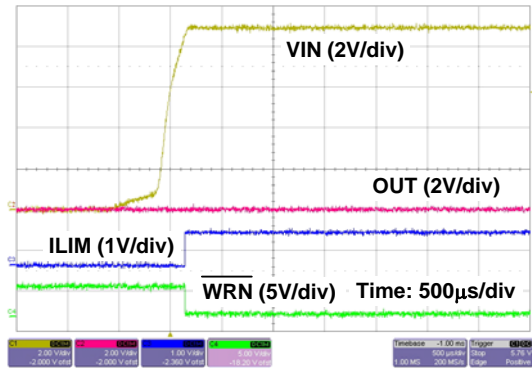

FIGURE 9. TRANSIENT WAVEFORMS WHEN INPUT STEPS FROM 0V TO 9V

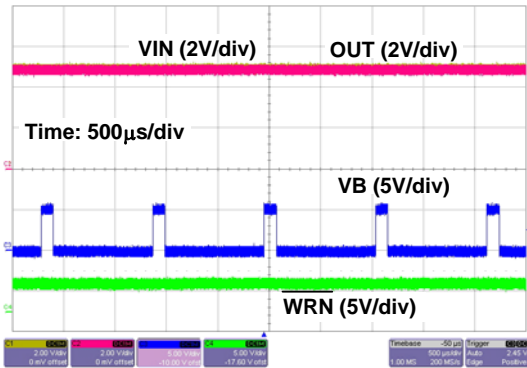

FIGURE 10. NO REACTION TO THE 0V TO 5V VB-PIN VOLTAGE WHEN THE PULSE WIDTH IS LESS THAN THE BLANKING TIME

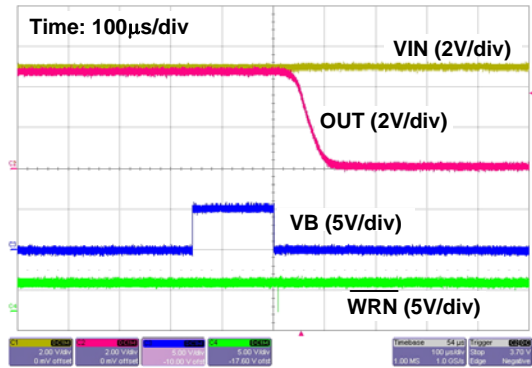

FIGURE 11. THE ISL9212 TURNS OFF THE OUTPUT WHEN VB VOLTAGE EXCEEDS 160µs

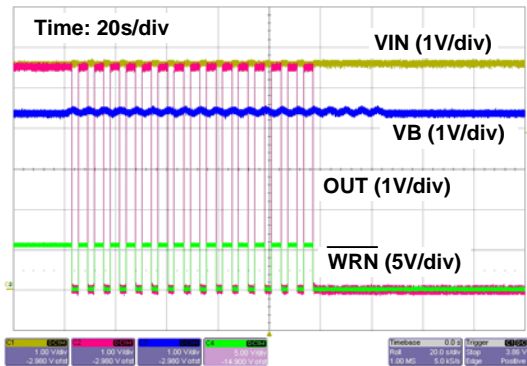

FIGURE 12. THE ISL9212 LATCHES OFF AFTER 16-COUNT OF BATTERY OVP

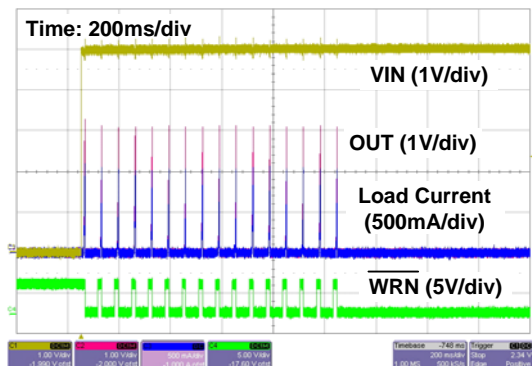

FIGURE 13. THE POWER-UP WAVEFORMS WHEN THE OUTPUT IS OVER-LOADED WITH A 3Ω RESISTOR

Evaluation Waveforms (Continued)

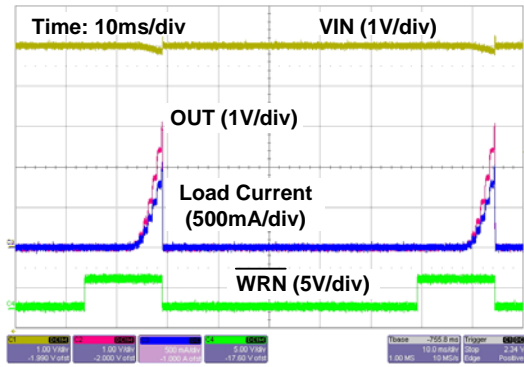

FIGURE 14. THE ZOOMED-IN VIEW OF FIGURE 13

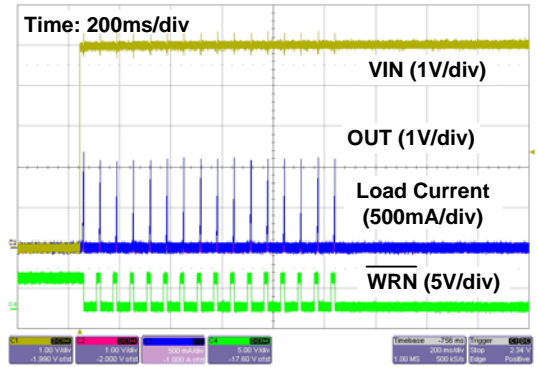

FIGURE 15. THE POWER-UP WAVEFORMS WHEN THE OUTPUT IS SHORT-CIRCUITED

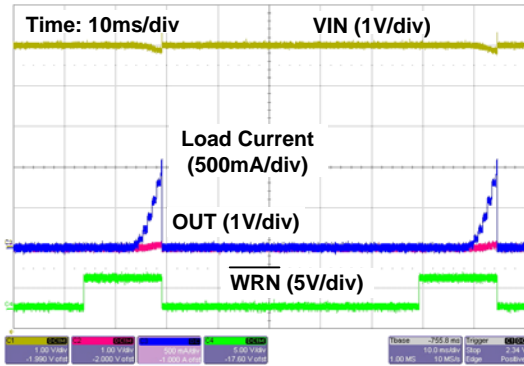

FIGURE 16. THE ZOOMED-IN VIEW OF FIGURE 15

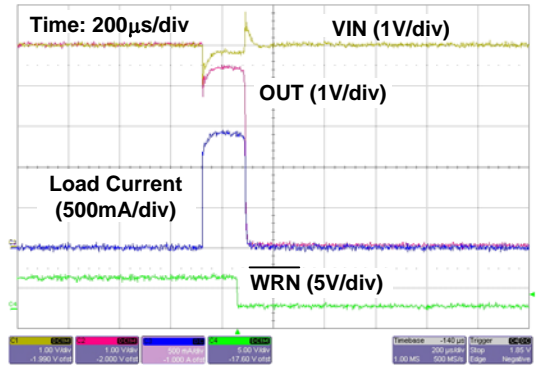

FIGURE 17. THE ZOOMED-IN VIEW OF FIGURE 18

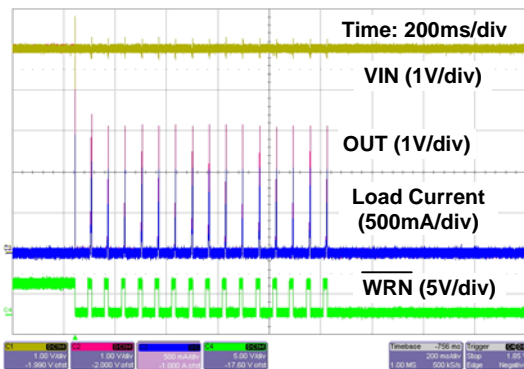

FIGURE 18. THE 3Ω RESISTOR OVER LOAD OCCURS AFTER THE POWER IS ON

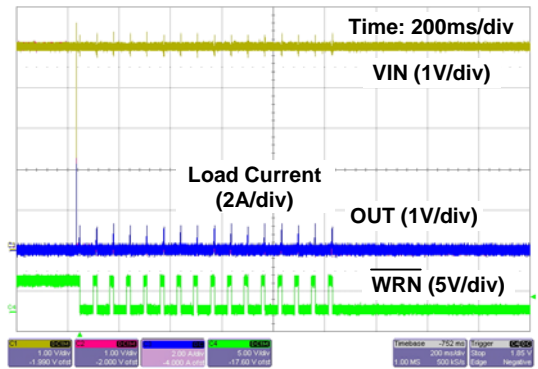

FIGURE 19. SHORT-CIRCUIT HAPPENS AFTER THE INPUT POWER IS UP

Evaluation Waveforms (Continued)

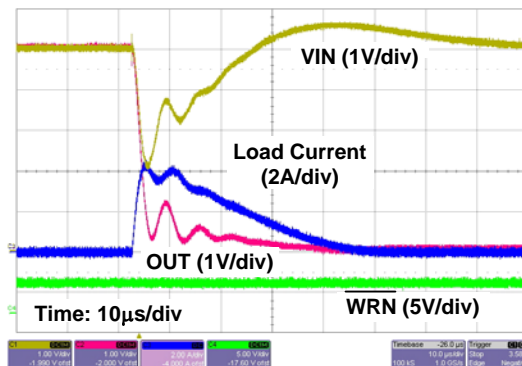

FIGURE 20. THE ZOOMED-IN VIEW OF FIGURE 19

Input Over-Voltage Protection (OVP)

The ISL9212 turns off the internal power FET when the input voltage exceeds the input OVP threshold to protect other electronics in the system. Figure 5 shows the action when the input is exceeding the OVP threshold gradually. The output voltage falls to ground after and the WRN logic signal turns to low. Figure 6 is a zoomed-in view to show more details during the transition. The ISL9212 was conducting 0.5A before the protection is triggered. When the OVP is triggered, the input voltage signal has a ringing due the parasitic cable inductance. The OVP threshold typically has a 100mV hysteresis. The WRN signal has a narrow pulse after the OVP because the ringing of the input voltage signal exceeds the hysteresis during the first cycle.

Figure 7 shows the waveforms when the input voltage drops below the falling threshold for the input OVP. The WRN signal rises immediately to show the removal of the input overvoltage situation but the output rises after the 10ms delay.

When the input voltage exceeds the OVP threshold, the internal power FET is turned off within 1µs. Figure 8 shows the behavior when the input voltage rises quickly from 6.5V to 10.5V. The time scale is 2µs/div and the reaction time is well within 1µs.

When a power supply that is already failed (unable to regulate the output below 6.5V) is used to power-up the ISL9212, the high input voltage will not show up at the ISL9212 output at all. Figure 9 illustrates such case. A 9V supply is used to power-up. The ISL9212 starts to operate once the input voltage exceeds the POR threshold, as indicated by the ILIM and the WRN pin voltages, but the internal power FET does not start to turn on before the end of the 10ms delay. Since the input voltage rises above the OVP threshold within 10ms, the OVP is issued before the soft-start process. The failed supply voltage will never show up at the OUT pin in this case.

Battery Overvoltage Protection

The battery OVP function is to prevent over-charge of the Li-ion battery. The typical protection threshold is 4.34V. There is a blanking time of approximately 160µs to prevent triggering of the battery OVP by a transient voltage. Only when the battery voltage exceeds the threshold for longer than the blanking time, will the OVP be triggered. The ISL9212 also has a 4-bit binary counter to count the battery OVP event. The internal power FET will be permanently latched off if the battery OVP event exceeds 16 counts. Then IC can then be reset only by cycling the input power or the enable input pin.

Figures 10 through 12 illustrate the battery OVP behavior. Figure 10 shows the captured waveforms when the VB-pin voltage pulses between 0V and 5V but the pulse width is less than the blanking time. The ISL9212 does not react to the VB-pin overvoltage in this case. Figure 11 shows the case that the pulse width barely exceeds the blanking time. The battery OVP is triggered, as indicated by the falling voltage on the OUT pin. A very narrow pulse can be found at the falling edge of the VB pulse. Figure 12 illustrates the latch off of the ISL9212 after 16-count of the battery OVP events. The VB pin voltage changes between 4.3V to 4.5V for 20 times but the IC does not react to the VB voltage after 16 counts.

Overcurrent Protection (OCP)

The ISL9212EVAL1Z sets the overcurrent protection threshold at 1A. When the current in the internal power FET exceeds 1A, the power FET is turned off. The ISL9212 tries to soft-start again after approximately 60ms. Same as the battery OVP event, an internal 4-bit binary counter sets the limit of 16 counts for the OCP event before latching off. The OCP also has a blanking time to prevent any transient current from triggering the protection.

The behavior of the ISL9212 is slightly different between the cases that the output is over-loaded before and after the

input power is up. When the over-load exists before the input power is up, the over load will be detected during the soft-start. The gate voltage of the internal power FET is controlled near the gate threshold voltage during the soft start; hence the FET current is controlled and is not capable to rise very fast. If the load current stays above the OCP threshold for longer than the blanking time, the power FET is turned off. Figures 13 through 16 show the captured waveforms during the power-up. The output is over loaded with a 3Ω resistor and a hard short-circuit respectively. Both cases the ISL9212 is latched off after 16 attempts of soft start. The zoomed-in views show the difference in the output voltage, one rises proportionally to the current and the other one shorted to ground all the time. For both cases, the peak load current is only slightly higher than the 1A limit.

If the input power is already on, the internal power FET is fully turned on and the gate voltage has passed the gate threshold voltage. When an over load case occurs, there is a delay for the gate voltage to move to the gate threshold voltage. Before reaching the gate threshold voltage, the power FET remains fully on, hence the current in the FET is totally dependent on the conditions outside the ISL9212.

Figure 18 illustrates the behavior that the output is loaded with a 3Ω resistor after the power is on. The ISL9212 still latches off after 16 count of OCP. After every OCP, the IC starts softly, hence the waveforms are same as those in Figure 14. The only difference happens during the first OCP event.

Figure 17 shows the zoomed-in view of the first OCP event. The current rises to the level limited by the 3Ω resistor and other parasitics. Note that the input voltage stays above the POR threshold since this case represents a minor overcurrent situation.

When a hard short-circuit event happens after the power is up, the overcurrent during the initial pulse is more severe. Figure 19 illustrate the case that the output is short-circuited after the IC is powered up. Note that the current waveform has 17 pulses with the first pulse very close to the second one on the time scale but the magnitude is significantly higher than the second and the rest. The current scale is changed to 2A/div in order to see the magnitude of the first pulse.

Figure 20 shows the zoomed-in view of the first pulse. For the same reason, the power FET is fully turned on when the short-circuit occurs and the current is totally depended on the conditions outside the ISL9212. Since the output is a short circuit, the current is totally dependent on the parasitics. The current in Figure 20 shoots up more than 4A. Note that the input voltage is pulled under the POR threshold due to the high current; hence the IC is actually reset during the first pulse. That is the explanation why there are 17 current pulses in this case. Once the initial overcurrent event is finished, the ISL9212 begins the soft-start process. The rest of the waveforms are the same as the ones in Figure 15 and Figure 16. The high current when a hard short-circuit is happening after the power is up does not flow through the battery so is not a hazardous condition to the Li-ion battery.

Summary

This application note introduced the schematics, layout, and BOM of the ISL9212EVAL1Z evaluation board for the ISL9212. Captured scope waveforms during power-up, input OVP, battery OVP and output OCP cases are shown to demonstrate the robustness of the ISL9212. The FMEA document for the charging system using the two chips of this evaluation board will be available upon request to further prove the safety of the ISL9212 solution.

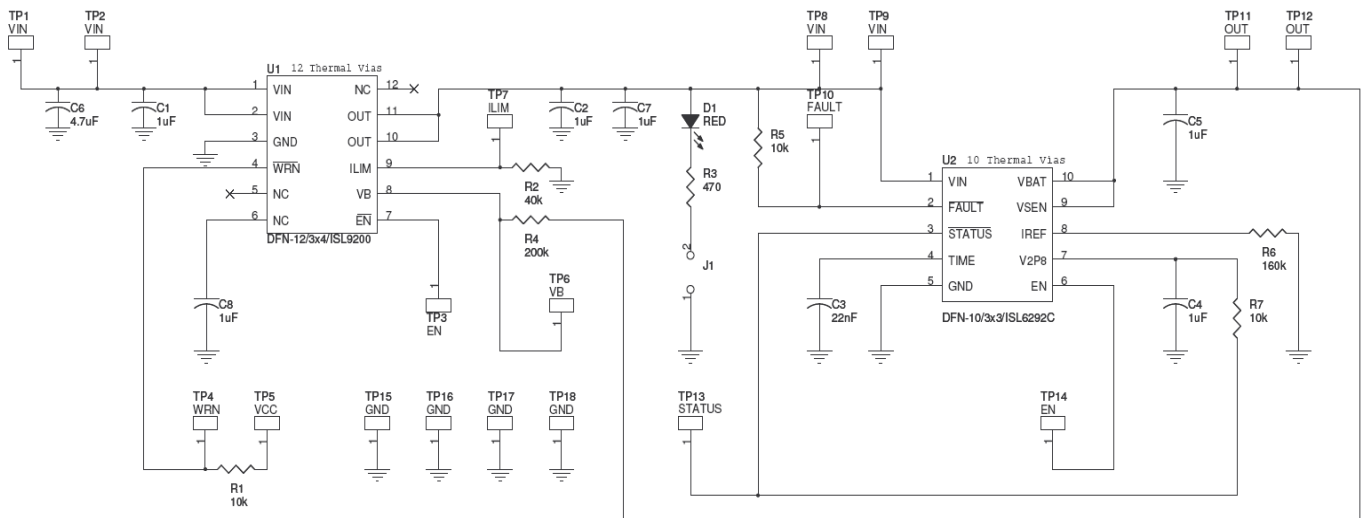
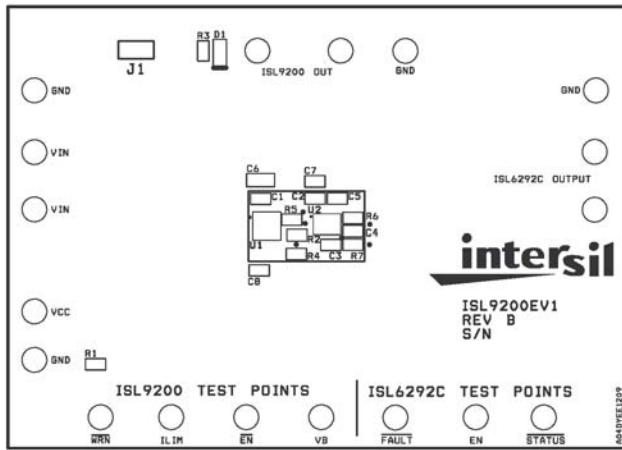
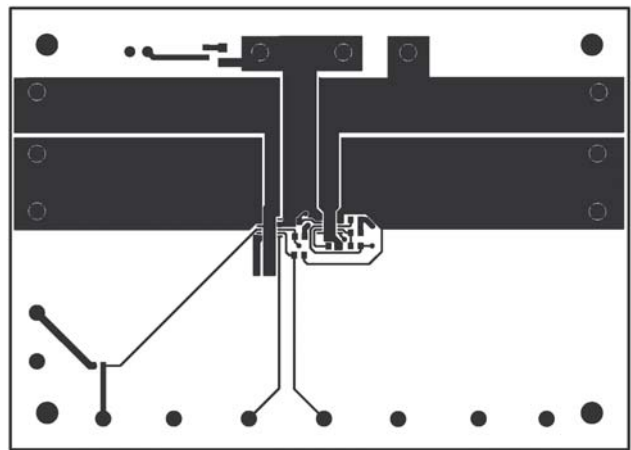

FIGURE 21. SCHEMATICS FOR THE EVALUATION BOARD



(A) SILK SCREEN LAYER



(B) TOP LAYER

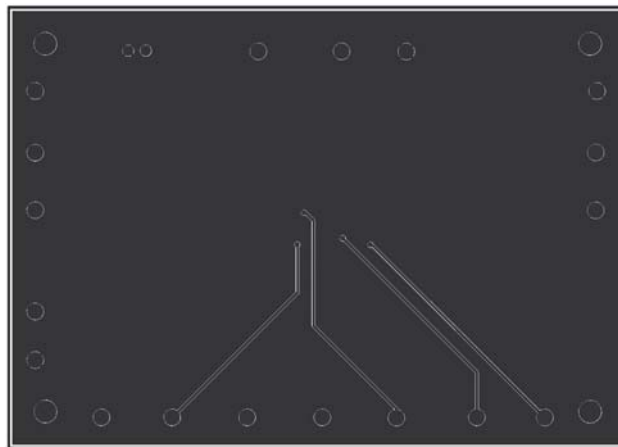

(C) BOTTOM LAYER

FIGURE 22. LAYOUT FOR THE EVALUATION BOARD

Application Note 1301

TABLE 2. BILL-OF-MATERIAL FOR THE ISL9212 EVALUATION BOARD

ITEM #	QTY	REFERENCE	DESCRIPTION	PART #	PACKAGE	VENDOR
1	1	C1	1 μ F, 16V, X5R	PCC2224CT-ND	0603	Digikey
2	5	C2, C4, C5, C7, C8	1 μ F, 6.3V, X5R	PCC1915CT-ND	0603	Digikey
3	1	C3	22nF, 16V, X7R	PCC1754CT-ND	0603	Digikey
4	1	C6	4.7 μ F, 16V, X5R	PCC2323CT-ND	0805	Digikey
5	3	R1, R5, R7	10k, 1%	P10.0KHCT-ND	0603	Digikey
6	1	R2	25.5k, 1%	311-25.5KHCT-ND	0603	Digikey
7	1	R3	470 Ω , 5%	311-470HCT-ND	0603	Digikey
8	1	R4	200k, 1%	311-200KHCT-ND	0603	Digikey
9	1	R6	160k, 1%	311-160KHCT-ND	0603	Digikey
10	1	D1	Red LED	67-1552-1-ND	0805	Digikey
11	1	J1	Jumper	A19423-ND		Digikey
12	1		Shunt	S9001-ND		Digikey
13	4	GND(4)	Test Points - Black	5011K-ND		Digikey
14	6	ISL6292C OUTPUT(2), VIN(2), VCC, ISL9212 OUT	Test Points - Red	5010K-ND		Digikey
15	7	WRN, ILIM, EN, VB, FAULT, EN, STATUS	Test Points - Yellow	5014K-ND		Digikey
16	1	U1	Charging System Protection IC	ISL9212B	4X3 DFN	Intersil
17	1	U2	Li-ion Battery Charger	ISL6292C	3X3 DFN	Intersil

NOTE: Do not populate C6, C7, and C8.

Intersil Corporation reserves the right to make changes in circuit design, software and/or specifications at any time without notice. Accordingly, the reader is cautioned to verify that the Application Note or Technical Brief is current before proceeding.

For information regarding Intersil Corporation and its products, see www.intersil.com