

32-bit MCU Ideal for Motor Control Applications

RX-T MCU GROUP



RX for Motor Control Solution Info

The RX-T series is specially developed for motor control applications with a broad line up from 32MHz to 200MHz capable of driving one to four motors.



Benefit 1

Simplify Motor Control Implementation

- Control multiple motors with a single chip (figure 1)

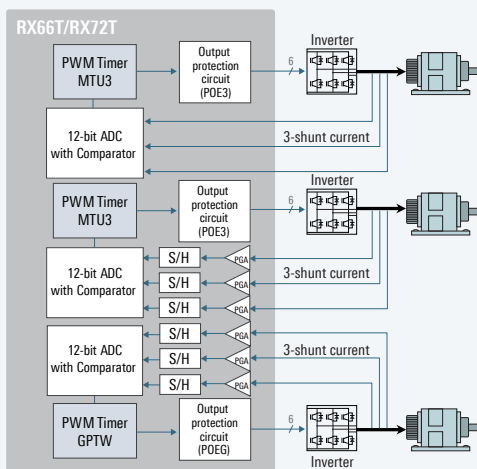

Figure 1. Application Example: Controlling Multiple Motors with a Single Chip

- High-speed arithmetic performance (figure 2)

High-speed arithmetic operations (RXv3 core + TFU)

- High-speed vector calculations
 - High-speed processing at 240MHz
 - FPU for high-speed floating point operations
 - TFU for high-speed trigonometric functions
 - single-precision floating point
 - sin, cos, arctan, sqrt (x²+y²)
 - Fast/fixed cycle operation

*Only RX72T/RX72M/RX72N supports TFU

Waveform control/feedback control (GPTW, MTU3 with POE)

- PWM waveform output
 - PWM output with 0 to 100% duty
 - Automatic insertion of dead time
 - A/D activation at user-defined timing for 1-shunt current detection
 - Disable output signals for the MTU and the GPT without using software

Feedback control (high-speed 12-bit A/D converter 3unit)

- High-speed (1.0μs) 12-bit A/D converter
- Simultaneous sampling of three tracks for 3-shunt current detection
- Reduce BOM by using built-in comparator and pseudo-diff PGA

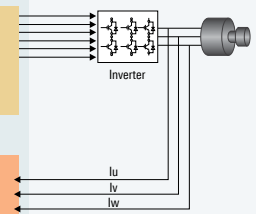

Figure 2. RX delivers high-speed arithmetic performance alongside MTU3, GPT timer, 12-bit A/D converter, and POE functions to simplify the process of implementing motor control.

Benefit 2

Shorten Development Time

- Motor Control Starter Kit to check motor drive and try various control methods easily.



RX motor control starter kit (24V Motor Control Evaluation System for RX)

- Motor Control Workbench supports smoother debugging.

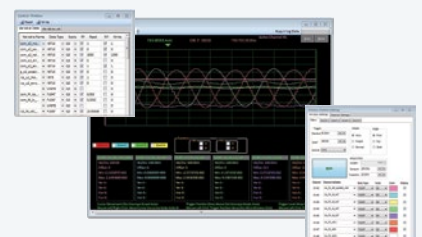











RX-T MCU GROUP





Memory/Pin Lineup (RX-T)

● RX72T	● RX66T	● RX23T	● RX24T/U	● RX13T
RX700 Series 200MHz, 512KB~1MB 100~144pin	RX600 Series 160MHz, 256KB~1MB 64~144pin	RX200 Series 40~80MHz, 64KB~512KB 48~144pin		RX100 Series 32MHz, 64KB~128KB 32~48pin

Flash memory	pin	32	48	52	64	80	100	112	144
1MB					RX600		RX700		
512KB			RX200						
384KB									
256KB	RX100								
128KB									
64KB									

Recommended RX MCU Series for Motor Control Applications

MCU Series	RX13T				RX23T/RX24T/RX24U					
Motor Types	Brushless DC Motor	Brushless DC Motor	AC Induction Motor	Stepping Motor	Brushless DC Motor	Brushless DC Motor	AC Induction Motor	AC Induction Motor	Stepping Motor	Stepping Motor
Control Method	Vector Control (180-degree conducting control)	Square Wave Control (120-degree conducting control)	V/f Control	Pulse Output	Vector Control (180-degree conducting control)	Square wave control (120-degree conducting control)	Vector Control	V/f Control	Pulse Output	Vector Control (Resolver)
Performance	Up to 32MHz				Up to 80MHz					
Recommended Applications	 <ul style="list-style-type: none"> Compact industrial motors Fans Drone 	 <ul style="list-style-type: none"> Refrigerators Fans Compact robots 	 <ul style="list-style-type: none"> Washing machine Fans Refrigerators Pumps 	 <ul style="list-style-type: none"> Printers/Multifunction units Surveillance cameras 	 <ul style="list-style-type: none"> Air conditioner outdoor unit Compact robots Surveillance cameras Drone 	 <ul style="list-style-type: none"> Pumps Refrigerators Compressors 	 <ul style="list-style-type: none"> Industrial pumps 	 <ul style="list-style-type: none"> Pumps 	 <ul style="list-style-type: none"> Printers/Multifunction units Surveillance cameras 	 <ul style="list-style-type: none"> Compact robots Carrier machine Textile machine Printers/Multifunction units

MCU Series	RX66T/RX72T				
Motor Types	Brushless DC Motor		AC Induction Motor	Stepping Motor	
Control Method	Vector Control		Vector Control	Vector Control (resolver)	
Performance	Over 100MHz				
Recommended Applications	 <ul style="list-style-type: none"> Air conditioner outdoor units (2-motor) Washing machines (2-motor) General-purpose inverters (Fans, Pumps) Machine tools AC servos 	 <ul style="list-style-type: none"> General-purpose inverters (Fans, Pumps) 	 <ul style="list-style-type: none"> General-purpose inverters (Fans, Pumps) 	 <ul style="list-style-type: none"> Industrial motors 	 <ul style="list-style-type: none"> Compact robots Industrial robots Carrier machine Textile machine Printers/Multifunction units

Recommended Application Notes and Software

Application Specific Methodology	Application Notes about Algorithm	Implementation Software	Integrated Development Environment
Sensorless vector control	Vector control (speed) (algorithm)	RX13T, RX23T, RX24T, RX24U, RX66T (MTU/GPT)*1, RX72T (MTU/GPT)*1	CS+, e ² studio
Encoder vector control	Vector control (position) (algorithm)	RX23T, RX24T, RX24U, RX66T (MTU/GPT)*1, RX72T (MTU/GPT)*1	CS+, e ² studio

*1: Two types of timer (MTU / GPT) setting are implemented as PWM output timer, and it can be selected at compile time.

For more information, please visit: www.renesas.com/rx-motor-control