

To our customers,

Old Company Name in Catalogs and Other Documents

On April 1st, 2010, NEC Electronics Corporation merged with Renesas Technology Corporation, and Renesas Electronics Corporation took over all the business of both companies. Therefore, although the old company name remains in this document, it is a valid Renesas Electronics document. We appreciate your understanding.

Renesas Electronics website: <http://www.renesas.com>

April 1st, 2010
Renesas Electronics Corporation

Issued by: Renesas Electronics Corporation (<http://www.renesas.com>)

Send any inquiries to <http://www.renesas.com/inquiry>.

Notice

1. All information included in this document is current as of the date this document is issued. Such information, however, is subject to change without any prior notice. Before purchasing or using any Renesas Electronics products listed herein, please confirm the latest product information with a Renesas Electronics sales office. Also, please pay regular and careful attention to additional and different information to be disclosed by Renesas Electronics such as that disclosed through our website.
2. Renesas Electronics does not assume any liability for infringement of patents, copyrights, or other intellectual property rights of third parties by or arising from the use of Renesas Electronics products or technical information described in this document. No license, express, implied or otherwise, is granted hereby under any patents, copyrights or other intellectual property rights of Renesas Electronics or others.
3. You should not alter, modify, copy, or otherwise misappropriate any Renesas Electronics product, whether in whole or in part.
4. Descriptions of circuits, software and other related information in this document are provided only to illustrate the operation of semiconductor products and application examples. You are fully responsible for the incorporation of these circuits, software, and information in the design of your equipment. Renesas Electronics assumes no responsibility for any losses incurred by you or third parties arising from the use of these circuits, software, or information.
5. When exporting the products or technology described in this document, you should comply with the applicable export control laws and regulations and follow the procedures required by such laws and regulations. You should not use Renesas Electronics products or the technology described in this document for any purpose relating to military applications or use by the military, including but not limited to the development of weapons of mass destruction. Renesas Electronics products and technology may not be used for or incorporated into any products or systems whose manufacture, use, or sale is prohibited under any applicable domestic or foreign laws or regulations.
6. Renesas Electronics has used reasonable care in preparing the information included in this document, but Renesas Electronics does not warrant that such information is error free. Renesas Electronics assumes no liability whatsoever for any damages incurred by you resulting from errors in or omissions from the information included herein.
7. Renesas Electronics products are classified according to the following three quality grades: “Standard”, “High Quality”, and “Specific”. The recommended applications for each Renesas Electronics product depends on the product’s quality grade, as indicated below. You must check the quality grade of each Renesas Electronics product before using it in a particular application. You may not use any Renesas Electronics product for any application categorized as “Specific” without the prior written consent of Renesas Electronics. Further, you may not use any Renesas Electronics product for any application for which it is not intended without the prior written consent of Renesas Electronics. Renesas Electronics shall not be in any way liable for any damages or losses incurred by you or third parties arising from the use of any Renesas Electronics product for an application categorized as “Specific” or for which the product is not intended where you have failed to obtain the prior written consent of Renesas Electronics. The quality grade of each Renesas Electronics product is “Standard” unless otherwise expressly specified in a Renesas Electronics data sheets or data books, etc.
 - “Standard”: Computers; office equipment; communications equipment; test and measurement equipment; audio and visual equipment; home electronic appliances; machine tools; personal electronic equipment; and industrial robots.
 - “High Quality”: Transportation equipment (automobiles, trains, ships, etc.); traffic control systems; anti-disaster systems; anti-crime systems; safety equipment; and medical equipment not specifically designed for life support.
 - “Specific”: Aircraft; aerospace equipment; submersible repeaters; nuclear reactor control systems; medical equipment or systems for life support (e.g. artificial life support devices or systems), surgical implantations, or healthcare intervention (e.g. excision, etc.), and any other applications or purposes that pose a direct threat to human life.
8. You should use the Renesas Electronics products described in this document within the range specified by Renesas Electronics, especially with respect to the maximum rating, operating supply voltage range, movement power voltage range, heat radiation characteristics, installation and other product characteristics. Renesas Electronics shall have no liability for malfunctions or damages arising out of the use of Renesas Electronics products beyond such specified ranges.
9. Although Renesas Electronics endeavors to improve the quality and reliability of its products, semiconductor products have specific characteristics such as the occurrence of failure at a certain rate and malfunctions under certain use conditions. Further, Renesas Electronics products are not subject to radiation resistance design. Please be sure to implement safety measures to guard them against the possibility of physical injury, and injury or damage caused by fire in the event of the failure of a Renesas Electronics product, such as safety design for hardware and software including but not limited to redundancy, fire control and malfunction prevention, appropriate treatment for aging degradation or any other appropriate measures. Because the evaluation of microcomputer software alone is very difficult, please evaluate the safety of the final products or system manufactured by you.
10. Please contact a Renesas Electronics sales office for details as to environmental matters such as the environmental compatibility of each Renesas Electronics product. Please use Renesas Electronics products in compliance with all applicable laws and regulations that regulate the inclusion or use of controlled substances, including without limitation, the EU RoHS Directive. Renesas Electronics assumes no liability for damages or losses occurring as a result of your noncompliance with applicable laws and regulations.
11. This document may not be reproduced or duplicated, in any form, in whole or in part, without prior written consent of Renesas Electronics.
12. Please contact a Renesas Electronics sales office if you have any questions regarding the information contained in this document or Renesas Electronics products, or if you have any other inquiries.

(Note 1) “Renesas Electronics” as used in this document means Renesas Electronics Corporation and also includes its majority-owned subsidiaries.

(Note 2) “Renesas Electronics product(s)” means any product developed or manufactured by or for Renesas Electronics.

16M-BIT CMOS FAST SRAM 2M-WORD BY 8-BIT

Description

The μPD4416008 is a high speed, low power, 16,777,216 bits (2,097,152 words by 8 bits) CMOS static RAM.

Operating supply voltage is 3.3 V ± 0.3 V.

The μPD4416008 is packaged in a 54-PIN PLASTIC TSOP (II) (10.16 mm (400))

Features

- 2,097,152 words by 8 bits
- Fast access time : 15 ns (MAX.)
- Output Enable input for easy application

<R> Ordering Information

Part number	Package	Supply voltage V	Access time ns (MAX.)	Supply current mA (MAX.)	
				At operating	At standby
μPD4416008G5-A15-9JF	54-PIN PLASTIC TSOP (II) (10.16 mm (400))	3.3 ± 0.3	15	230	10
μPD4416008G5-A15-9JF-A					

Remark Products with -A at the end of the part number are lead-free products.

The information in this document is subject to change without notice. Before using this document, please confirm that this is the latest version.
Not all products and/or types are available in every country. Please check with an NEC Electronics sales representative for availability and additional information.

Pin Configuration (Marking Side)

/xxx indicates active low signal.

54-PIN PLASTIC TSOP (II) (10.16 mm (400))

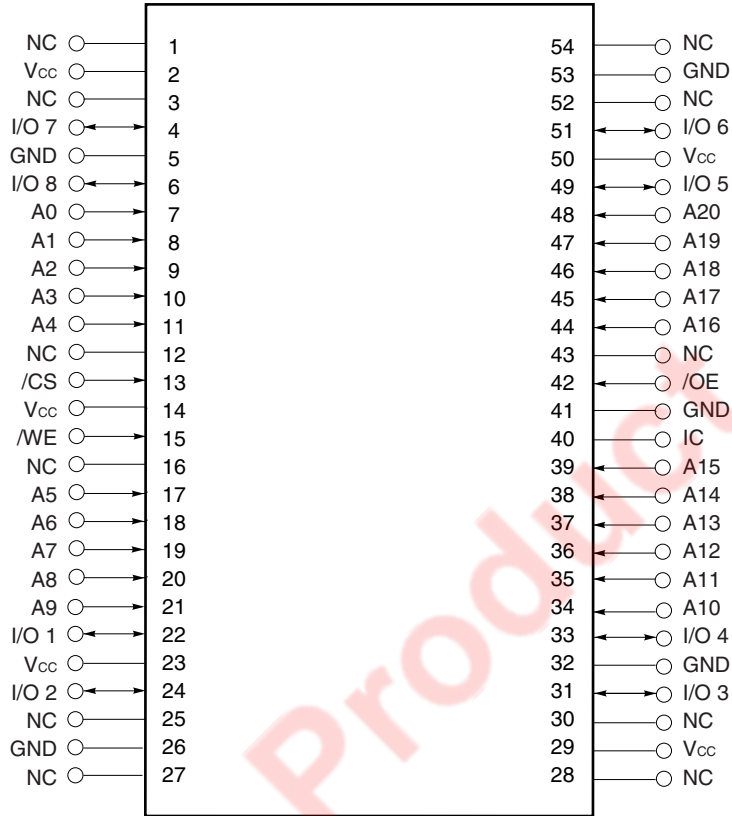

- A0 - A20 : Address Inputs
- I/O1 - I/O8 : Data Inputs / Outputs
- /CS : Chip Select
- /WE : Write Enable
- /OE : Output Enable
- Vcc : Power supply
- GND : Ground
- NC : No connection
- IC : Internal connection ^{Note}

Note Leave this pin connect to GND.

Remark Refer to **Package Drawing** for 1-pin index mark.

Block Diagram

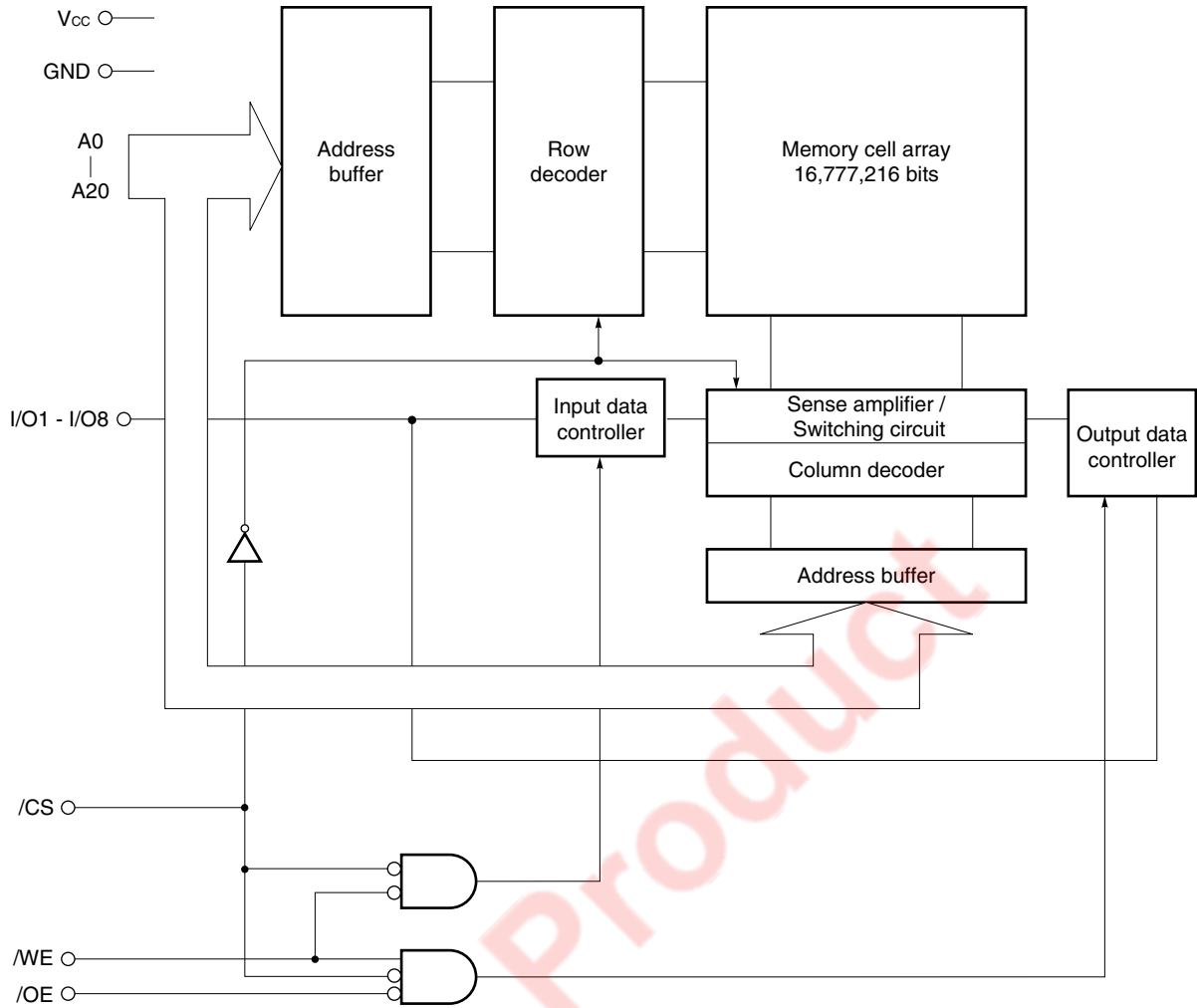

Truth Table

/CS	/OE	/WE	Mode	I/O	Supply current
H	x	x	Not selected	High impedance	I _{SB}
L	L	H	Read	D _{OUT}	I _{CC}
L	x	L	Write	D _{IN}	
L	H	H	Output disable	High impedance	

Remark x : Don't care

Electrical Specifications

Absolute Maximum Ratings

Parameter	Symbol	Condition	Rating	Unit
Supply voltage	V _{CC}		-0.5 ^{Note} to +4.0	V
Input / Output voltage	V _T		-0.5 ^{Note} to +4.0	V
Operating ambient temperature	T _A		0 to 70	°C
Storage temperature	T _{stg}		-55 to +125	°C

Note -2.0 V (MIN.) (pulse width : 2 ns)

Caution Exposing the device to stress above those listed in Absolute Maximum Rating could cause permanent damage. The device is not meant to be operated under conditions outside the limits described in the operational section of this specification. Exposure to Absolute Maximum Rating conditions for extended periods may affect device reliability.

Recommended Operating Conditions

Parameter	Symbol	Condition	MIN.	TYP.	MAX.	Unit
Supply voltage	V _{CC}		3.0	3.3	3.6	V
High level input voltage	V _{IH}		2.0		V _{CC} + 0.3	V
Low level input voltage	V _{IL}		-0.3 ^{Note}		+0.8	V
Operating ambient temperature	T _A		0		70	°C

Note -2.0 V (MIN.) (pulse width : 2 ns)

DC Characteristics (Recommended Operating Conditions Unless Otherwise Noted)

Parameter	Symbol	Test condition	MIN.	TYP.	MAX.	Unit
Input leakage current	I _{LI}	V _{IN} = 0 V to V _{CC}	-2		+2	μA
Output leakage current	I _{LO}	V _{I/O} = 0 V to V _{CC} , /CS = V _{IH} or /OE = V _{IH} or /WE = V _{IL}	-2		+2	μA
Operating supply current	I _{CC}	/CS = V _{IL} , I _{I/O} = 0 mA, Minimum cycle time			230	mA
Standby supply current	I _{SB}	/CS = V _{IH} , V _{IN} = V _{IH} or V _{IL} , Minimum cycle time			80	mA
	I _{SB1}	/CS ≥ V _{CC} - 0.2 V, V _{IN} ≤ 0.2 V or V _{IN} ≥ V _{CC} - 0.2 V			10	
High level output voltage	V _{OH}	I _{OH} = -4.0 mA	2.4			V
Low level output voltage	V _{OL}	I _{OL} = +8.0 mA			0.4	V

Remark V_{IN} : Input voltage, V_{I/O} : Input / Output voltage

Capacitance (TA = 25 °C, f = 1 MHz)

Parameter	Symbol	Test condition	MIN.	TYP.	MAX.	Unit
Input capacitance	C _{IN}	V _{IN} = 0 V			6	pF
Input / Output capacitance	C _{I/O}	V _{I/O} = 0 V			8	pF

Remarks 1. V_{IN} : Input voltage, V_{I/O} : Input / Output voltage
 2. These parameters are periodically sampled and not 100% tested.

AC Characteristics (Recommended Operating Conditions Unless Otherwise Noted)

AC Test Conditions

LVTTTL Interface

Input Waveform (Rise and Fall Time ≤ 3 ns)

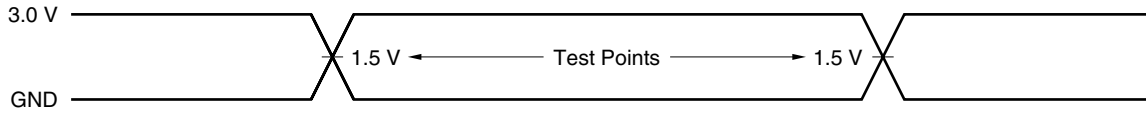

Output Waveform

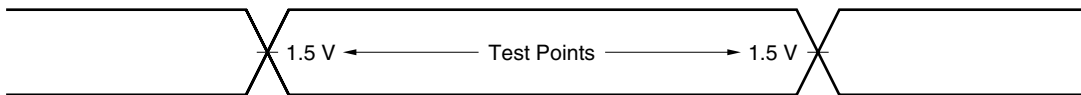

Output Load

AC characteristics directed with the note should be measured with the output load shown in Figure 1 or Figure 2.

Figure 1

(for t_{AA} , t_{ACS} , t_{OE} , t_{OH})

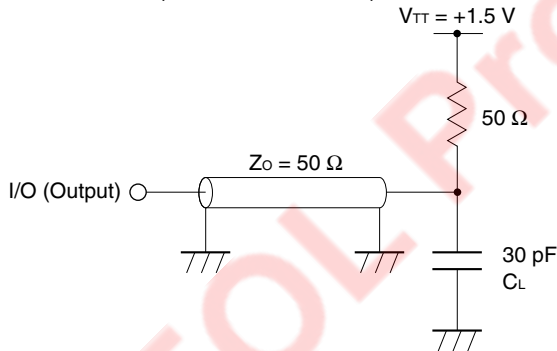
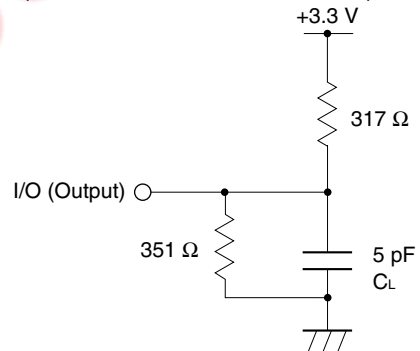

Figure 2

(for t_{CLZ} , t_{OLZ} , t_{CHZ} , t_{OHZ} , t_{WHZ} , t_{OW})



Remark C_L includes capacitances of the probe and jig, and stray capacitances.

Read Cycle

Parameter	Symbol	MIN.	MAX.	Unit	Notes
Read cycle time	t_{RC}	15		ns	
Address access time	t_{AA}		15	ns	1
/CS access time	t_{ACS}		15	ns	
/OE access time	t_{OE}		7	ns	
Output hold from address change	t_{OH}	3		ns	
/CS to output in low impedance	t_{CLZ}	3		ns	2, 3
/OE to output in low impedance	t_{OLZ}	0		ns	
/CS to output in high impedance	t_{CHZ}		7	ns	
/OE to output hold in high impedance	t_{OHZ}		7	ns	

- Notes**
1. See the output load shown in **Figure 1**.
 2. Transition is measured at ± 200 mV from steady-state voltage with the output load shown in **Figure 2**.
 3. These parameters are periodically sampled and not 100% tested.

Read Cycle Timing Chart 1 (Address Access)

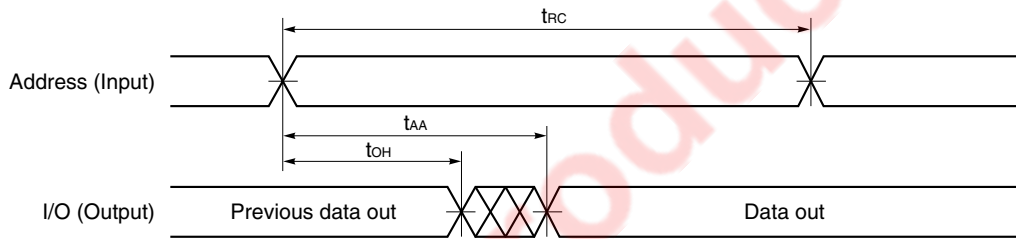

- Remarks**
1. In read cycle, /WE should be fixed to high level.
 2. /CS = /OE = V_{IL}

Read Cycle Timing Chart 2 (/CS Access)

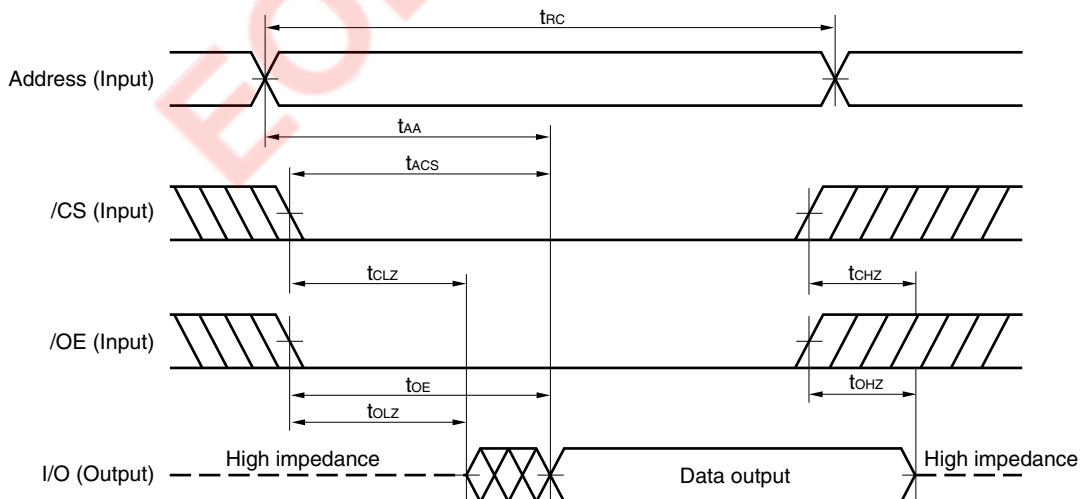

Caution Address valid prior to or coincident with /CS low level input.

Remark In read cycle, /WE should be fixed to high level.

Write Cycle

Parameter	Symbol	MIN.	MAX.	Unit	Notes
Write cycle time	t_{WC}	15		ns	
/CS to end of write	t_{CW}	10		ns	
Address valid to end of write	t_{AW}	10		ns	
Write pulse width	t_{WP}	10		ns	
Data valid to end of write	t_{DW}	7		ns	
Data hold time	t_{DH}	0		ns	
Address setup time	t_{AS}	0		ns	
Write recovery time	t_{WR}	1		ns	
/WE to output in high impedance	t_{WHZ}		7	ns	1, 2
Output active from end of write	t_{OW}	3		ns	

- Notes**
1. Transition is measured at ± 200 mV from steady-state voltage with the output load shown in **Figure 2**.
 2. These parameters are periodically sampled and not 100% tested.

Write Cycle Timing Chart 1 (/WE Controlled)

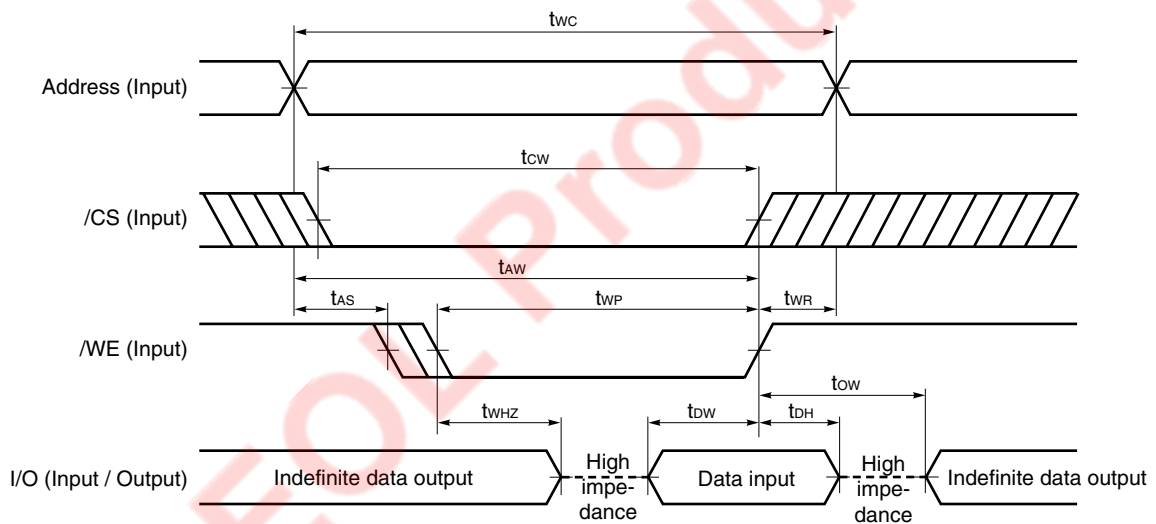

- Cautions**
1. /CS or /WE should be fixed to high level during address transition.
 2. Do not input data to the I/O pins while they are in the output state.

- Remarks**
1. Write operation is done during the overlap time of a low level /CS, a low level /WE.
 2. During t_{WHZ} , I/O pins are in the output state, therefore the input signals of opposite phase to the output must not be applied.
 3. When /WE is at low level, the I/O pins are always high impedance. When /WE is at high level, read operation is executed. Therefore /OE should be at high level to make the I/O pins high impedance.

Write Cycle Timing Chart 2 (/CS Controlled)

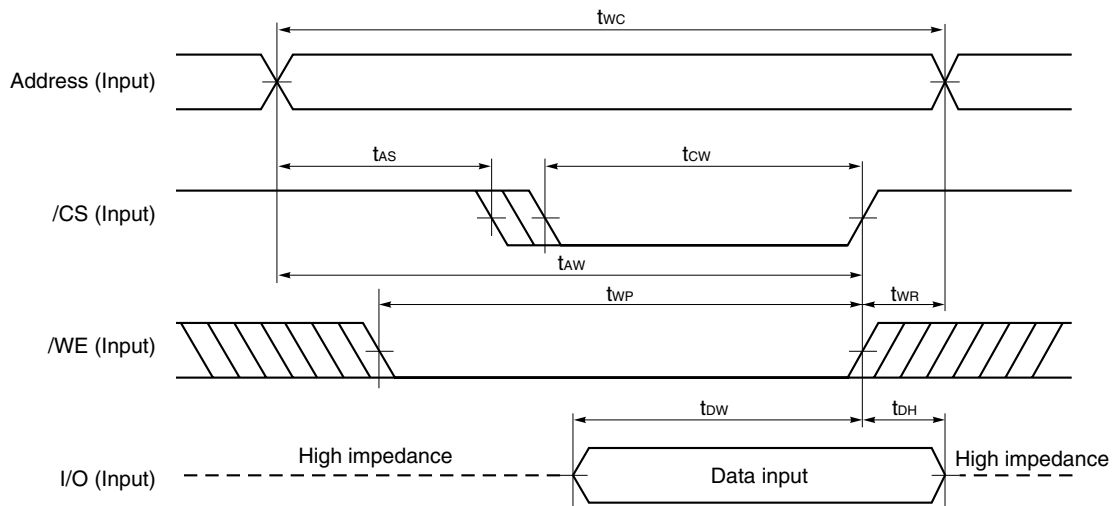

- Cautions**
1. \overline{CS} or \overline{WE} should be fixed to high level during address transition.
 2. Do not input data to the I/O pins while they are in the output state.

Remark Write operation is done during the overlap time of a low level \overline{CS} and a low level \overline{WE} .

EOL Product

Package Drawing

54-PIN PLASTIC TSOP (II) (10.16 mm (400))

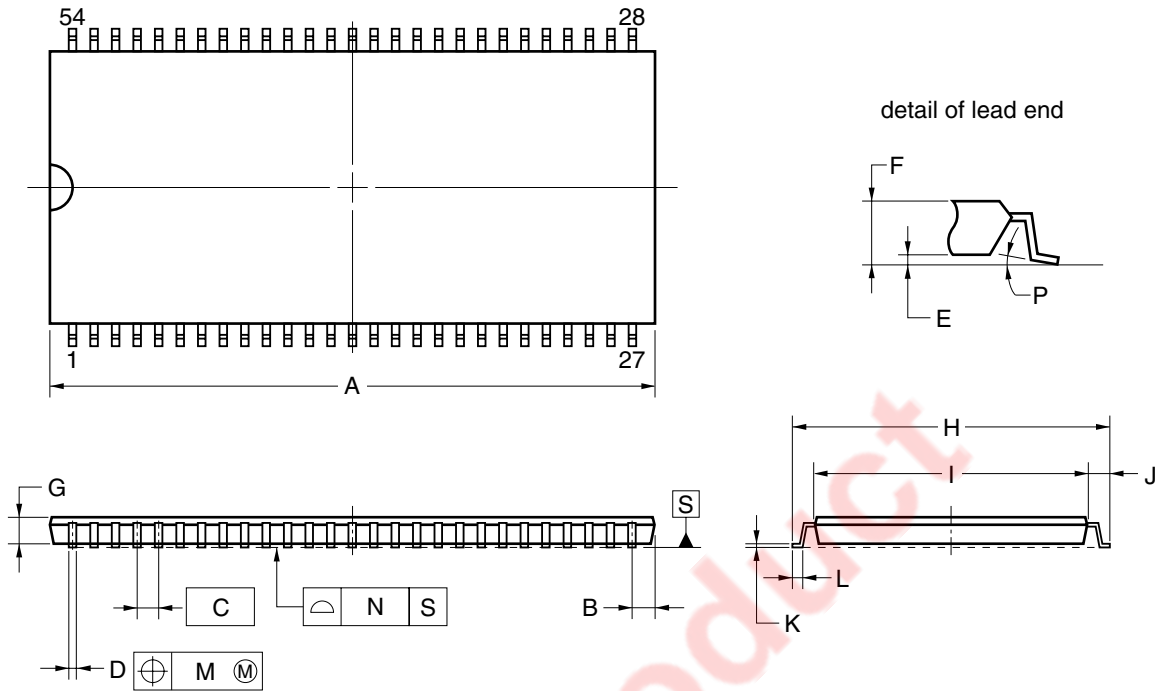

NOTES

1. Each lead centerline is located within 0.13 mm of its true position (T.P.) at maximum material condition.
2. Dimension "A" does not include mold flash, protrusions or gate burrs. Mold flash, protrusions or gate burrs shall not exceed 0.15 mm per side.

ITEM	MILLIMETERS
A	22.22±0.05
B	0.91 MAX.
C	0.80 (T.P.)
D	0.32 ^{+0.08} _{-0.07}
E	0.10±0.05
F	1.1±0.1
G	1.00
H	11.76±0.20
I	10.16±0.10
J	0.80±0.20
K	0.145 ^{+0.025} _{-0.015}
L	0.50±0.10
M	0.13
N	0.10
P	3° ^{+7°} _{-3°}

S54G5-80-9JF-3

Recommended Soldering Conditions

Please consult with our sales offices for soldering conditions of the μ PD4416008.

Type of Surface Mount Device

μ PD4416008G5-9JF : 54-PIN PLASTIC TSOP (II) (10.16 mm (400))

μ PD4416008G5-9JF-A : 54-PIN PLASTIC TSOP (II) (10.16 mm (400))

<R> Quality Grade

- A quality grade of the products is "Standard".
- Anti-radioactive design is not implemented in the products.
- Semiconductor devices have the possibility of unexpected defects by affection of cosmic ray that reach to the ground and so forth.

EOL Product

Revision History

Edition/ Date	Page		Type of revision	Location	Description (Previous edition → This edition)
	This edition	Previous edition			
6th edition/ Sep. 2006	p.1	p.1	Deletion	Ordering Information	μPD4416008G5-A17-9JF μPD4416008G5-A17-9JF-A
	p.10	p.10	Addition	Quality Grade	Section of Quality Grade has been added.

EOL Product

[MEMO]

EOL Product

[MEMO]

EOL Product

[MEMO]

EOL Product

NOTES FOR CMOS DEVICES

① VOLTAGE APPLICATION WAVEFORM AT INPUT PIN

Waveform distortion due to input noise or a reflected wave may cause malfunction. If the input of the CMOS device stays in the area between V_{IL} (MAX) and V_{IH} (MIN) due to noise, etc., the device may malfunction. Take care to prevent chattering noise from entering the device when the input level is fixed, and also in the transition period when the input level passes through the area between V_{IL} (MAX) and V_{IH} (MIN).

② HANDLING OF UNUSED INPUT PINS

Unconnected CMOS device inputs can be cause of malfunction. If an input pin is unconnected, it is possible that an internal input level may be generated due to noise, etc., causing malfunction. CMOS devices behave differently than Bipolar or NMOS devices. Input levels of CMOS devices must be fixed high or low by using pull-up or pull-down circuitry. Each unused pin should be connected to V_{DD} or GND via a resistor if there is a possibility that it will be an output pin. All handling related to unused pins must be judged separately for each device and according to related specifications governing the device.

③ PRECAUTION AGAINST ESD

A strong electric field, when exposed to a MOS device, can cause destruction of the gate oxide and ultimately degrade the device operation. Steps must be taken to stop generation of static electricity as much as possible, and quickly dissipate it when it has occurred. Environmental control must be adequate. When it is dry, a humidifier should be used. It is recommended to avoid using insulators that easily build up static electricity. Semiconductor devices must be stored and transported in an anti-static container, static shielding bag or conductive material. All test and measurement tools including work benches and floors should be grounded. The operator should be grounded using a wrist strap. Semiconductor devices must not be touched with bare hands. Similar precautions need to be taken for PW boards with mounted semiconductor devices.

④ STATUS BEFORE INITIALIZATION

Power-on does not necessarily define the initial status of a MOS device. Immediately after the power source is turned ON, devices with reset functions have not yet been initialized. Hence, power-on does not guarantee output pin levels, I/O settings or contents of registers. A device is not initialized until the reset signal is received. A reset operation must be executed immediately after power-on for devices with reset functions.

⑤ POWER ON/OFF SEQUENCE

In the case of a device that uses different power supplies for the internal operation and external interface, as a rule, switch on the external power supply after switching on the internal power supply. When switching the power supply off, as a rule, switch off the external power supply and then the internal power supply. Use of the reverse power on/off sequences may result in the application of an overvoltage to the internal elements of the device, causing malfunction and degradation of internal elements due to the passage of an abnormal current.

The correct power on/off sequence must be judged separately for each device and according to related specifications governing the device.

⑥ INPUT OF SIGNAL DURING POWER OFF STATE

Do not input signals or an I/O pull-up power supply while the device is not powered. The current injection that results from input of such a signal or I/O pull-up power supply may cause malfunction and the abnormal current that passes in the device at this time may cause degradation of internal elements. Input of signals during the power off state must be judged separately for each device and according to related specifications governing the device.

- **The information in this document is current as of September, 2006. The information is subject to change without notice. For actual design-in, refer to the latest publications of NEC Electronics data sheets or data books, etc., for the most up-to-date specifications of NEC Electronics products. Not all products and/or types are available in every country. Please check with an NEC Electronics sales representative for availability and additional information.**
- No part of this document may be copied or reproduced in any form or by any means without the prior written consent of NEC Electronics. NEC Electronics assumes no responsibility for any errors that may appear in this document.
- NEC Electronics does not assume any liability for infringement of patents, copyrights or other intellectual property rights of third parties by or arising from the use of NEC Electronics products listed in this document or any other liability arising from the use of such products. No license, express, implied or otherwise, is granted under any patents, copyrights or other intellectual property rights of NEC Electronics or others.
- Descriptions of circuits, software and other related information in this document are provided for illustrative purposes in semiconductor product operation and application examples. The incorporation of these circuits, software and information in the design of a customer's equipment shall be done under the full responsibility of the customer. NEC Electronics assumes no responsibility for any losses incurred by customers or third parties arising from the use of these circuits, software and information.
- While NEC Electronics endeavors to enhance the quality, reliability and safety of NEC Electronics products, customers agree and acknowledge that the possibility of defects thereof cannot be eliminated entirely. To minimize risks of damage to property or injury (including death) to persons arising from defects in NEC Electronics products, customers must incorporate sufficient safety measures in their design, such as redundancy, fire-containment and anti-failure features.
- NEC Electronics products are classified into the following three quality grades: "Standard", "Special" and "Specific".

The "Specific" quality grade applies only to NEC Electronics products developed based on a customer-designated "quality assurance program" for a specific application. The recommended applications of an NEC Electronics product depend on its quality grade, as indicated below. Customers must check the quality grade of each NEC Electronics product before using it in a particular application.

"Standard": Computers, office equipment, communications equipment, test and measurement equipment, audio and visual equipment, home electronic appliances, machine tools, personal electronic equipment and industrial robots.

"Special": Transportation equipment (automobiles, trains, ships, etc.), traffic control systems, anti-disaster systems, anti-crime systems, safety equipment and medical equipment (not specifically designed for life support).

"Specific": Aircraft, aerospace equipment, submersible repeaters, nuclear reactor control systems, life support systems and medical equipment for life support, etc.

The quality grade of NEC Electronics products is "Standard" unless otherwise expressly specified in NEC Electronics data sheets or data books, etc. If customers wish to use NEC Electronics products in applications not intended by NEC Electronics, they must contact an NEC Electronics sales representative in advance to determine NEC Electronics' willingness to support a given application.

(Note)

- (1) "NEC Electronics" as used in this statement means NEC Electronics Corporation and also includes its majority-owned subsidiaries.
- (2) "NEC Electronics products" means any product developed or manufactured by or for NEC Electronics (as defined above).