

To our customers,

Old Company Name in Catalogs and Other Documents

On April 1st, 2010, NEC Electronics Corporation merged with Renesas Technology Corporation, and Renesas Electronics Corporation took over all the business of both companies. Therefore, although the old company name remains in this document, it is a valid Renesas Electronics document. We appreciate your understanding.

Renesas Electronics website: <http://www.renesas.com>

April 1st, 2010
Renesas Electronics Corporation

Issued by: Renesas Electronics Corporation (<http://www.renesas.com>)

Send any inquiries to <http://www.renesas.com/inquiry>.

Notice

1. All information included in this document is current as of the date this document is issued. Such information, however, is subject to change without any prior notice. Before purchasing or using any Renesas Electronics products listed herein, please confirm the latest product information with a Renesas Electronics sales office. Also, please pay regular and careful attention to additional and different information to be disclosed by Renesas Electronics such as that disclosed through our website.
2. Renesas Electronics does not assume any liability for infringement of patents, copyrights, or other intellectual property rights of third parties by or arising from the use of Renesas Electronics products or technical information described in this document. No license, express, implied or otherwise, is granted hereby under any patents, copyrights or other intellectual property rights of Renesas Electronics or others.
3. You should not alter, modify, copy, or otherwise misappropriate any Renesas Electronics product, whether in whole or in part.
4. Descriptions of circuits, software and other related information in this document are provided only to illustrate the operation of semiconductor products and application examples. You are fully responsible for the incorporation of these circuits, software, and information in the design of your equipment. Renesas Electronics assumes no responsibility for any losses incurred by you or third parties arising from the use of these circuits, software, or information.
5. When exporting the products or technology described in this document, you should comply with the applicable export control laws and regulations and follow the procedures required by such laws and regulations. You should not use Renesas Electronics products or the technology described in this document for any purpose relating to military applications or use by the military, including but not limited to the development of weapons of mass destruction. Renesas Electronics products and technology may not be used for or incorporated into any products or systems whose manufacture, use, or sale is prohibited under any applicable domestic or foreign laws or regulations.
6. Renesas Electronics has used reasonable care in preparing the information included in this document, but Renesas Electronics does not warrant that such information is error free. Renesas Electronics assumes no liability whatsoever for any damages incurred by you resulting from errors in or omissions from the information included herein.
7. Renesas Electronics products are classified according to the following three quality grades: “Standard”, “High Quality”, and “Specific”. The recommended applications for each Renesas Electronics product depends on the product’s quality grade, as indicated below. You must check the quality grade of each Renesas Electronics product before using it in a particular application. You may not use any Renesas Electronics product for any application categorized as “Specific” without the prior written consent of Renesas Electronics. Further, you may not use any Renesas Electronics product for any application for which it is not intended without the prior written consent of Renesas Electronics. Renesas Electronics shall not be in any way liable for any damages or losses incurred by you or third parties arising from the use of any Renesas Electronics product for an application categorized as “Specific” or for which the product is not intended where you have failed to obtain the prior written consent of Renesas Electronics. The quality grade of each Renesas Electronics product is “Standard” unless otherwise expressly specified in a Renesas Electronics data sheets or data books, etc.
 - “Standard”: Computers; office equipment; communications equipment; test and measurement equipment; audio and visual equipment; home electronic appliances; machine tools; personal electronic equipment; and industrial robots.
 - “High Quality”: Transportation equipment (automobiles, trains, ships, etc.); traffic control systems; anti-disaster systems; anti-crime systems; safety equipment; and medical equipment not specifically designed for life support.
 - “Specific”: Aircraft; aerospace equipment; submersible repeaters; nuclear reactor control systems; medical equipment or systems for life support (e.g. artificial life support devices or systems), surgical implantations, or healthcare intervention (e.g. excision, etc.), and any other applications or purposes that pose a direct threat to human life.
8. You should use the Renesas Electronics products described in this document within the range specified by Renesas Electronics, especially with respect to the maximum rating, operating supply voltage range, movement power voltage range, heat radiation characteristics, installation and other product characteristics. Renesas Electronics shall have no liability for malfunctions or damages arising out of the use of Renesas Electronics products beyond such specified ranges.
9. Although Renesas Electronics endeavors to improve the quality and reliability of its products, semiconductor products have specific characteristics such as the occurrence of failure at a certain rate and malfunctions under certain use conditions. Further, Renesas Electronics products are not subject to radiation resistance design. Please be sure to implement safety measures to guard them against the possibility of physical injury, and injury or damage caused by fire in the event of the failure of a Renesas Electronics product, such as safety design for hardware and software including but not limited to redundancy, fire control and malfunction prevention, appropriate treatment for aging degradation or any other appropriate measures. Because the evaluation of microcomputer software alone is very difficult, please evaluate the safety of the final products or system manufactured by you.
10. Please contact a Renesas Electronics sales office for details as to environmental matters such as the environmental compatibility of each Renesas Electronics product. Please use Renesas Electronics products in compliance with all applicable laws and regulations that regulate the inclusion or use of controlled substances, including without limitation, the EU RoHS Directive. Renesas Electronics assumes no liability for damages or losses occurring as a result of your noncompliance with applicable laws and regulations.
11. This document may not be reproduced or duplicated, in any form, in whole or in part, without prior written consent of Renesas Electronics.
12. Please contact a Renesas Electronics sales office if you have any questions regarding the information contained in this document or Renesas Electronics products, or if you have any other inquiries.

(Note 1) “Renesas Electronics” as used in this document means Renesas Electronics Corporation and also includes its majority-owned subsidiaries.

(Note 2) “Renesas Electronics product(s)” means any product developed or manufactured by or for Renesas Electronics.



384-OUTPUT TFT-LCD SOURCE DRIVER (COMPATIBLE WITH 64-GRAY SCALES)

- ★ The μ PD16732 is a source driver for TFT-LCDs capable of dealing with displays with 64-gray scales. Data input is based on digital input configured as 6 bits by 6 dots (2 pixels), which can realize a full-color display of 260,000 colors by output of 64 values γ -corrected by an internal D/A converter and 5-by-2 external power modules. Because the output dynamic range is as large as $V_{SS2}+0.1$ V to $V_{DD2}-0.1$ V, level inversion operation of the LCD's common electrode is rendered unnecessary. Also, to be able to deal with dot-line inversion, n-line inversion and column line inversion when mounted on a single side, this source driver is equipped with a built-in 6-bit D/A converter circuit whose odd output pins and even output pins respectively output gray scale voltages of differing polarity. Assuring a maximum clock frequency of 40 MHz when driving at 3.0 V, this driver is applicable to XGA-standard TFT-LCD panels and SXGA TFT-LCD panels by input display signal 2 systems (Clock divide).

FEATURES

- 384 Outputs
- Capable of outputting 64 values by means of 5-by-2 external power modules (10 units) and a D/A converter
- ★ • Output dynamic range : $V_{SS2}+0.1$ V to $V_{DD2}-0.1$ V
- ★ • Logic part power supply voltage (V_{DD1}) : 3.3 ± 0.3 V
- ★ • Driver part power supply voltage (V_{DD2}) : 8.5 ± 0.5 V
- CMOS level input
- Input of 6 bits (gradation data) by 6 dots
- High-speed data transfer: $f_{MAX.} = 40$ MHz (internal data transfer speed when operating at 3.0 V)
- Apply for dot-line inversion, n-line inversion and column line inversion
- Single bank arrangement is possible (loaded with slim or bending TCP) (POL)
- Display data inversion function (POL2)

ORDERING INFORMATION

Part Number	Package
μ PD16732N-xxx	TCP (TAB package)

Remark The TCP's external shape is customized. To order your TCP's external shape, please contact a NEC salesperson.

The information in this document is subject to change without notice. Before using this document, please confirm that this is the latest version.
Not all devices/types available in every country. Please check with local NEC representative for availability and additional information.

BLOCK DIAGRAM

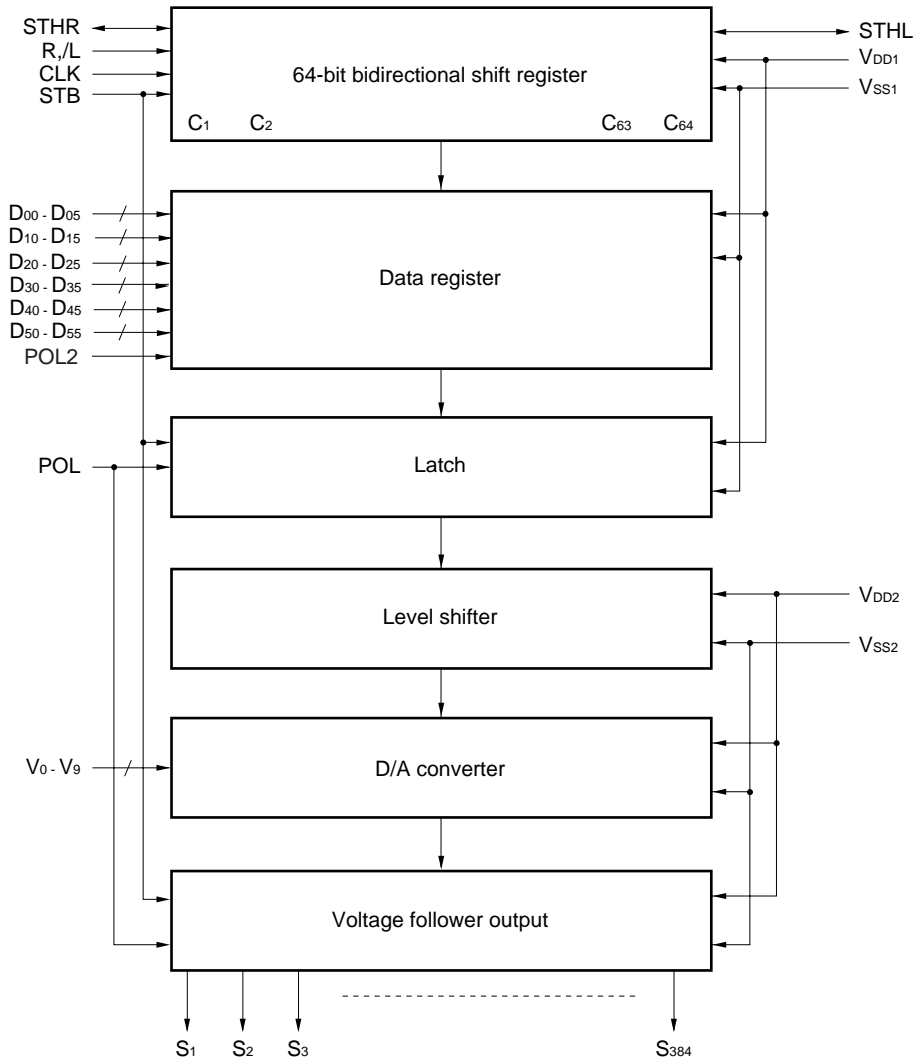

Remark /xxx indicates active low signal.

RELATIONSHIP BETWEEN OUTPUT CIRCUIT AND D/A CONVERTER

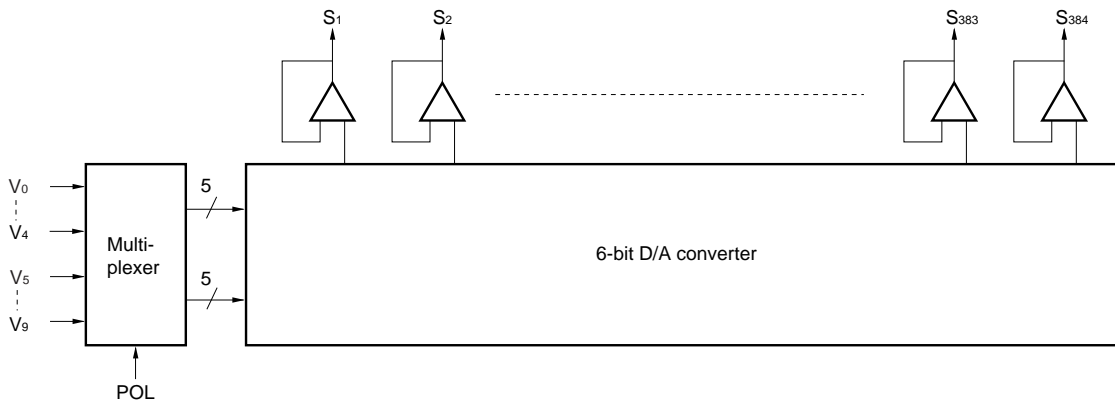

1. PIN FUNCTIONS

Pin Symbol	Pin Name	Description
S ₁ to S ₃₈₄	Driver output	The D/A converted 64-gray-scale analog voltage is output.
D ₀₀ to D ₀₅	Display data input	The display data is input with a width of 36 bits, viz., the gray scale data (6 bits) by 6 dots (2 pixels). D _{X0} : LSB, D _{X5} : MSB
D ₁₀ to D ₁₅		
D ₂₀ to D ₂₅		
D ₃₀ to D ₃₅		
D ₄₀ to D ₄₅		
D ₅₀ to D ₅₅		
R,/L	Shift direction control input	These refer to the start pulse input/output pins when driver ICs are connected in cascade. The shift directions of the shift registers are as follows. R,/L = H : STHR input, S ₁ → S ₃₈₄ , STHL output R,/L = L : STHL input, S ₃₈₄ → S ₁ , STHR output
STHR	Right shift start pulse input/output	R,/L = H : Becomes the start pulse input pin. R,/L = L : Becomes the start pulse output pin.
STHL	Left shift start pulse input/output	R,/L = H : Becomes the start pulse output pin. R,/L = L : Becomes the start pulse input pin.
CLK	Shift clock input	Refers to the shift register's shift clock input. The display data is incorporated into the data register at the rising edge. At the rising edge of the 64th clock after the start pulse input, the start pulse output reaches the high level, thus becoming the start pulse of the next-level driver.
STB	Latch input	The contents of the data register are transferred to the latch circuit at the rising edge. And, at the falling edge, the gray scale voltage is supplied to the driver. It is necessary to ensure input of one pulse per horizontal period.
POL	Polarity input	POL = L : The S _{2n-1} output uses V ₀ to V ₄ as the reference supply. The S _{2n} output uses V ₅ to V ₉ as the reference supply. POL = H : The S _{2n-1} output uses V ₅ to V ₉ as the reference supply. The S _{2n} output uses V ₀ to V ₄ as the reference supply. S _{2n-1} indicates the odd output: and S _{2n} indicates the even output. Input of the POL signal is allowed the setup time(t _{POL-STB}) with respect to STB's rising edge.
POL2	Data inversion	POL2 = H : Display data is inverted. POL2 = L : Display data is not inverted.
V ₀ to V ₉	γ-corrected power supplies	Input the γ-corrected power supplies from outside by using operational amplifier. Make sure to maintain the following relationships. During the gray scale voltage output, be sure to keep the gray scale level power supply at a constant level. V _{DD2} > V ₀ > V ₁ > V ₂ > V ₃ > V ₄ > V ₅ > V ₆ > V ₇ > V ₈ > V ₉ > V _{SS2}
V _{DD1}	Logic power supply	3.3 V ± 0.3 V
★ V _{DD2}	Driver power supply	8.5 V ± 0.5 V
V _{SS1}	Logic ground	Grounding
V _{SS2}	Driver ground	Grounding

- Cautions 1. The power start sequence must be V_{DD1}, logic input, and V_{DD2} & V₀ to V₉ in that order. Reverse this sequence to shut down. (Simultaneous power application to V_{DD2} and V₀ to V₉ is possible.)**
- 2. To stabilize the supply voltage, please be sure to insert a 0.1 μF bypass capacitor between V_{DD1}-V_{SS1} and V_{DD2}-V_{SS2}. Furthermore, for increased precision of the D/A converter, insertion of a bypass capacitor of about 0.01 μF is also advised between the γ-corrected power supply terminals (V₀, V₁, V₂, ..., V₉) and V_{SS2}.**

2. RELATIONSHIP BETWEEN INPUT DATA AND OUTPUT VOLTAGE VALUE

This product incorporates a 6-bit D/A converter whose odd output pins and even output pins output respectively gray scale voltages of differing polarity with respect to the LCD's counter electrode (common electrode) voltage. The D/A converter consists of ladder resistors and switches.

Figure 2-1 shows the relationship between the driving voltages such as liquid-crystal driving voltages V_{DD2} and V_{SS2} , common electrode potential V_{COM} , and γ -corrected voltages V_0 to V_9 and the input data. Be sure to maintain the voltage relationships of $V_{DD2} > V_0 > V_1 > V_2 > V_3 > V_4 > V_5 > V_6 > V_7 > V_8 > V_9 > V_{SS2}$.

Figures 2-2 and 2-3 show the relationship between the input data and the output data. This driver IC is designed for only single-sided mounting. Therefore, please do not use it for γ -corrected power supply level inversion in double-sided mounting.

Figure 2-1. Relationship between Input Data and γ -corrected Power Supply

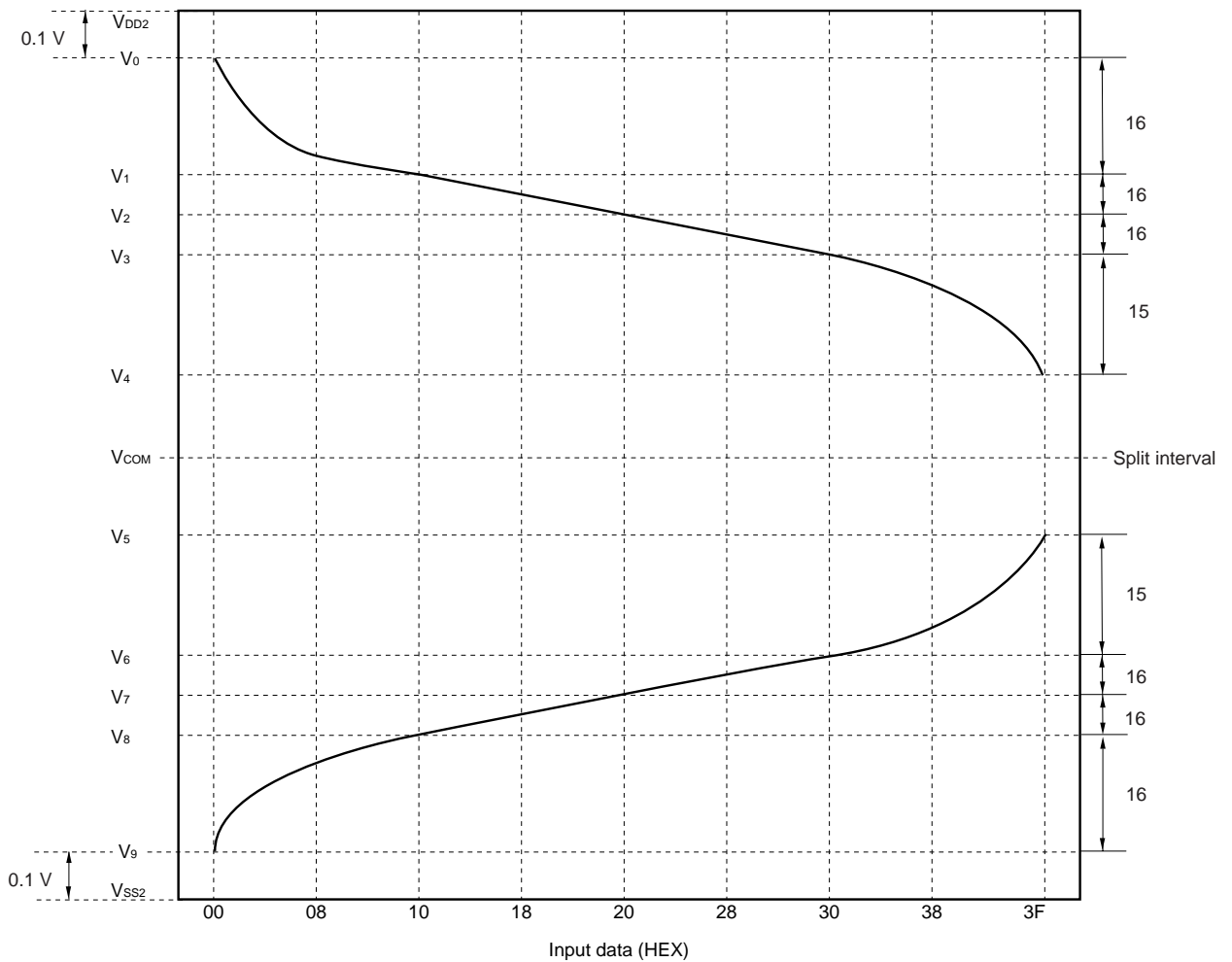
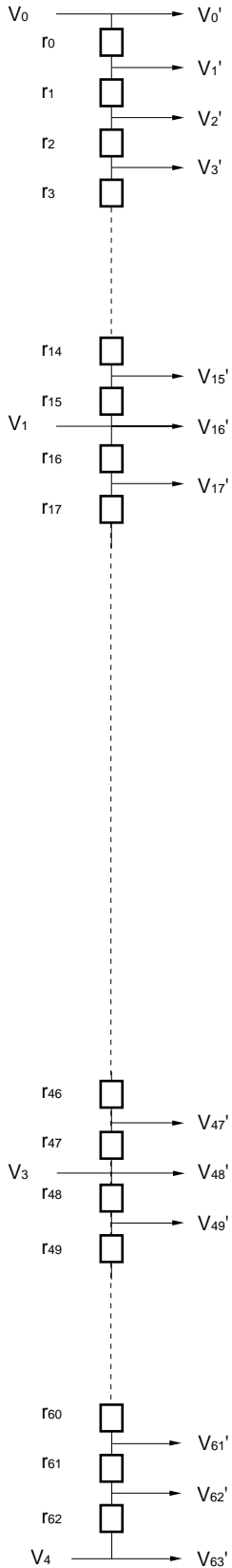

Figure 2–2. Relationship between Input Data and Output Voltage(1/2)

$V_{DD2} > V_0 > V_1 > V_2 > V_3 > V_4 > V_5$, POL2 = L



Data	Dx5	Dx4	Dx3	Dx2	Dx1	Dx0	Output Voltage	
00H	0	0	0	0	0	0	V0'	V0
01H	0	0	0	0	0	1	V1'	$V1+(V_0-V_1) \times 7250/8050$
02H	0	0	0	0	1	0	V2'	$V1+(V_0-V_1) \times 6500/8050$
03H	0	0	0	0	1	1	V3'	$V1+(V_0-V_1) \times 5800/8050$
04H	0	0	0	1	0	0	V4'	$V1+(V_0-V_1) \times 5150/8050$
05H	0	0	0	1	0	1	V5'	$V1+(V_0-V_1) \times 4550/8050$
06H	0	0	0	1	1	0	V6'	$V1+(V_0-V_1) \times 4000/8050$
07H	0	0	0	1	1	1	V7'	$V1+(V_0-V_1) \times 3450/8050$
08H	0	0	1	0	0	0	V8'	$V1+(V_0-V_1) \times 2950/8050$
09H	0	0	1	0	0	1	V9'	$V1+(V_0-V_1) \times 2450/8050$
0AH	0	0	1	0	1	0	V10'	$V1+(V_0-V_1) \times 2050/8050$
0BH	0	0	1	0	1	1	V11'	$V1+(V_0-V_1) \times 1650/8050$
0CH	0	0	1	1	0	0	V12'	$V1+(V_0-V_1) \times 1300/8050$
0DH	0	0	1	1	0	1	V13'	$V1+(V_0-V_1) \times 950/8050$
0EH	0	0	1	1	1	0	V14'	$V1+(V_0-V_1) \times 600/8050$
0FH	0	0	1	1	1	1	V15'	$V1+(V_0-V_1) \times 300/8050$
10H	0	1	0	0	0	0	V16'	V1
11H	0	1	0	0	0	1	V17'	$V2+(V_1-V_2) \times 2450/2750$
12H	0	1	0	0	1	0	V18'	$V2+(V_1-V_2) \times 2200/2750$
13H	0	1	0	0	1	1	V19'	$V2+(V_1-V_2) \times 1950/2750$
14H	0	1	0	1	0	0	V20'	$V2+(V_1-V_2) \times 1700/2750$
15H	0	1	0	1	0	1	V21'	$V2+(V_1-V_2) \times 1500/2750$
16H	0	1	0	1	1	0	V22'	$V2+(V_1-V_2) \times 1300/2750$
17H	0	1	0	1	1	1	V23'	$V2+(V_1-V_2) \times 1100/2750$
18H	0	1	1	0	0	0	V24'	$V2+(V_1-V_2) \times 950/2750$
19H	0	1	1	0	0	1	V25'	$V2+(V_1-V_2) \times 800/2750$
1AH	0	1	1	0	1	0	V26'	$V2+(V_1-V_2) \times 650/2750$
1BH	0	1	1	0	1	1	V27'	$V2+(V_1-V_2) \times 500/2750$
1CH	0	1	1	1	0	0	V28'	$V2+(V_1-V_2) \times 400/2750$
1DH	0	1	1	1	0	1	V29'	$V2+(V_1-V_2) \times 300/2750$
1EH	0	1	1	1	1	0	V30'	$V2+(V_1-V_2) \times 200/2750$
1FH	0	1	1	1	1	1	V31'	$V2+(V_1-V_2) \times 100/2750$
20H	1	0	0	0	0	0	V32'	V2
21H	1	0	0	0	0	1	V33'	$V3+(V_2-V_3) \times 1500/1600$
22H	1	0	0	0	1	0	V34'	$V3+(V_2-V_3) \times 1400/1600$
23H	1	0	0	0	1	1	V35'	$V3+(V_2-V_3) \times 1300/1600$
24H	1	0	0	1	0	0	V36'	$V3+(V_2-V_3) \times 1200/1600$
25H	1	0	0	1	0	1	V37'	$V3+(V_2-V_3) \times 1100/1600$
26H	1	0	0	1	1	0	V38'	$V3+(V_2-V_3) \times 1000/1600$
27H	1	0	0	1	1	1	V39'	$V3+(V_2-V_3) \times 900/1600$
28H	1	0	1	0	0	0	V40'	$V3+(V_2-V_3) \times 800/1600$
29H	1	0	1	0	0	1	V41'	$V3+(V_2-V_3) \times 700/1600$
2AH	1	0	1	0	1	0	V42'	$V3+(V_2-V_3) \times 600/1600$
2BH	1	0	1	0	1	1	V43'	$V3+(V_2-V_3) \times 500/1600$
2CH	1	0	1	1	0	0	V44'	$V3+(V_2-V_3) \times 400/1600$
2DH	1	0	1	1	0	1	V45'	$V3+(V_2-V_3) \times 300/1600$
2EH	1	0	1	1	1	0	V46'	$V3+(V_2-V_3) \times 200/1600$
2FH	1	0	1	1	1	1	V47'	$V3+(V_2-V_3) \times 100/1600$
30H	1	1	0	0	0	0	V48'	V3
31H	1	1	0	0	0	1	V49'	$V4+(V_3-V_4) \times 3350/3450$
32H	1	1	0	0	1	0	V50'	$V4+(V_3-V_4) \times 3250/3450$
33H	1	1	0	0	1	1	V51'	$V4+(V_3-V_4) \times 3150/3450$
34H	1	1	0	1	0	0	V52'	$V4+(V_3-V_4) \times 3050/3450$
35H	1	1	0	1	0	1	V53'	$V4+(V_3-V_4) \times 2950/3450$
36H	1	1	0	1	1	0	V54'	$V4+(V_3-V_4) \times 2800/3450$
37H	1	1	0	1	1	1	V55'	$V4+(V_3-V_4) \times 2650/3450$
38H	1	1	1	0	0	0	V56'	$V4+(V_3-V_4) \times 2500/3450$
39H	1	1	1	0	0	1	V57'	$V4+(V_3-V_4) \times 2300/3450$
3AH	1	1	1	0	1	0	V58'	$V4+(V_3-V_4) \times 2100/3450$
3BH	1	1	1	0	1	1	V59'	$V4+(V_3-V_4) \times 1850/3450$
3CH	1	1	1	1	0	0	V60'	$V4+(V_3-V_4) \times 1600/3450$
3DH	1	1	1	1	0	1	V61'	$V4+(V_3-V_4) \times 1300/3450$
3EH	1	1	1	1	1	0	V62'	$V4+(V_3-V_4) \times 800/3450$
3FH	1	1	1	1	1	1	V63'	V4

m	(Ω)
r0	800
r1	750
r2	700
r3	650
r4	600
r5	550
r6	550
r7	500
r8	500
r9	400
r10	400
r11	350
r12	350
r13	350
r14	300
r15	300
r16	300
r17	250
r18	250
r19	250
r20	200
r21	200
r22	200
r23	150
r24	150
r25	150
r26	150
r27	100
r28	100
r29	100
r30	100
r31	100
r32	100
r33	100
r34	100
r35	100
r36	100
r37	100
r38	100
r39	100
r40	100
r41	100
r42	100
r43	100
r44	100
r45	100
r46	100
r47	100
r48	100
r49	100
r50	100
r51	100
r52	100
r53	150
r54	150
r55	150
r56	200
r57	200
r58	250
r59	250
r60	300
r61	500
r62	800
Total	15850

Caution Between V4 and V5 terminal is not connected in the chip.

Figure 2-3. Relationship between Input Data and Output Voltage(2/2)

$$V_4 > V_5 > V_6 > V_7 > V_8 > V_9 > V_{SS2}, POL2 = L$$

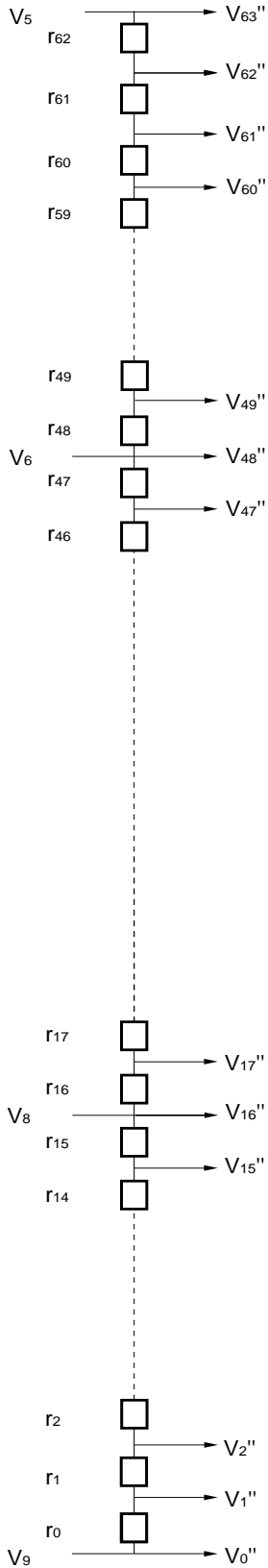

Data	Dx5	Dx4	Dx3	Dx2	Dx1	Dx0	Output Voltage	
3FH	1	1	1	1	1	1	V63''	V5
3EH	1	1	1	1	1	0	V62''	$V_6+(V_5-V_6) \times 2650/3450$
3DH	1	1	1	1	0	1	V61''	$V_6+(V_5-V_6) \times 2150/3450$
3CH	1	1	1	1	0	0	V60''	$V_6+(V_5-V_6) \times 1850/3450$
3BH	1	1	1	0	1	1	V59''	$V_6+(V_5-V_6) \times 1600/3450$
3AH	1	1	1	0	1	0	V58''	$V_6+(V_5-V_6) \times 1350/3450$
39H	1	1	1	0	0	1	V57''	$V_6+(V_5-V_6) \times 1150/3450$
38H	1	1	1	0	0	0	V56''	$V_6+(V_5-V_6) \times 950/3450$
37H	1	1	0	1	1	1	V55''	$V_6+(V_5-V_6) \times 800/3450$
36H	1	1	0	1	1	0	V54''	$V_6+(V_5-V_6) \times 650/3450$
35H	1	1	0	1	0	1	V53''	$V_6+(V_5-V_6) \times 500/3450$
34H	1	1	0	1	0	0	V52''	$V_6+(V_5-V_6) \times 400/3450$
33H	1	1	0	0	1	1	V51''	$V_6+(V_5-V_6) \times 300/3450$
32H	1	1	0	0	1	0	V50''	$V_6+(V_5-V_6) \times 200/3450$
31H	1	1	0	0	0	1	V49''	$V_6+(V_5-V_6) \times 100/3450$
30H	1	1	0	0	0	0	V48''	V6
2FH	1	0	1	1	1	1	V47''	$V_7+(V_6-V_7) \times 1500/1600$
2EH	1	0	1	1	1	0	V46''	$V_7+(V_6-V_7) \times 1400/1600$
2DH	1	0	1	1	0	1	V45''	$V_7+(V_6-V_7) \times 1300/1600$
2CH	1	0	1	1	0	0	V44''	$V_7+(V_6-V_7) \times 1200/1600$
2BH	1	0	1	0	1	1	V43''	$V_7+(V_6-V_7) \times 1100/1600$
2AH	1	0	1	0	1	0	V42''	$V_7+(V_6-V_7) \times 1000/1600$
29H	1	0	1	0	0	1	V41''	$V_7+(V_6-V_7) \times 900/1600$
28H	1	0	1	0	0	0	V40''	$V_7+(V_6-V_7) \times 800/1600$
27H	1	0	0	1	1	1	V39''	$V_7+(V_6-V_7) \times 700/1600$
26H	1	0	0	1	1	0	V38''	$V_7+(V_6-V_7) \times 600/1600$
25H	1	0	0	1	0	1	V37''	$V_7+(V_6-V_7) \times 500/1600$
24H	1	0	0	1	0	0	V36''	$V_7+(V_6-V_7) \times 400/1600$
23H	1	0	0	0	1	1	V35''	$V_7+(V_6-V_7) \times 300/1600$
22H	1	0	0	0	1	0	V34''	$V_7+(V_6-V_7) \times 200/1600$
21H	1	0	0	0	0	1	V33''	$V_7+(V_6-V_7) \times 100/1600$
20H	1	0	0	0	0	0	V32''	V7
1FH	0	1	1	1	1	1	V31''	$V_8+(V_7-V_8) \times 2650/2750$
1EH	0	1	1	1	1	0	V30''	$V_8+(V_7-V_8) \times 2550/2750$
1DH	0	1	1	1	0	1	V29''	$V_8+(V_7-V_8) \times 2450/2750$
1CH	0	1	1	1	0	0	V28''	$V_8+(V_7-V_8) \times 2350/2750$
1BH	0	1	1	0	1	1	V27''	$V_8+(V_7-V_8) \times 2250/2750$
1AH	0	1	1	0	1	0	V26''	$V_8+(V_7-V_8) \times 2100/2750$
19H	0	1	1	0	0	1	V25''	$V_8+(V_7-V_8) \times 1950/2750$
18H	0	1	1	0	0	0	V24''	$V_8+(V_7-V_8) \times 1800/2750$
17H	0	1	0	1	1	1	V23''	$V_8+(V_7-V_8) \times 1650/2750$
16H	0	1	0	1	1	0	V22''	$V_8+(V_7-V_8) \times 1450/2750$
15H	0	1	0	1	0	1	V21''	$V_8+(V_7-V_8) \times 1250/2750$
14H	0	1	0	1	0	0	V20''	$V_8+(V_7-V_8) \times 1050/2750$
13H	0	1	0	0	1	1	V19''	$V_8+(V_7-V_8) \times 800/2750$
12H	0	1	0	0	1	0	V18''	$V_8+(V_7-V_8) \times 550/2750$
11H	0	1	0	0	0	1	V17''	$V_8+(V_7-V_8) \times 300/2750$
10H	0	1	0	0	0	0	V16''	V8
0FH	0	0	1	1	1	1	V15''	$V_9+(V_8-V_9) \times 7750/8050$
0EH	0	0	1	1	1	0	V14''	$V_9+(V_8-V_9) \times 7450/8050$
0DH	0	0	1	1	0	1	V13''	$V_9+(V_8-V_9) \times 7100/8050$
0CH	0	0	1	1	0	0	V12''	$V_9+(V_8-V_9) \times 6750/8050$
0BH	0	0	1	0	1	1	V11''	$V_9+(V_8-V_9) \times 6400/8050$
0AH	0	0	1	0	1	0	V10''	$V_9+(V_8-V_9) \times 6000/8050$
09H	0	0	1	0	0	1	V9''	$V_9+(V_8-V_9) \times 5600/8050$
08H	0	0	1	0	0	0	V8''	$V_9+(V_8-V_9) \times 5100/8050$
07H	0	0	0	1	1	1	V7''	$V_9+(V_8-V_9) \times 4600/8050$
06H	0	0	0	1	1	0	V6''	$V_9+(V_8-V_9) \times 4050/8050$
05H	0	0	0	1	0	1	V5''	$V_9+(V_8-V_9) \times 3500/8050$
04H	0	0	0	1	0	0	V4''	$V_9+(V_8-V_9) \times 2900/8050$
03H	0	0	0	0	1	1	V3''	$V_9+(V_8-V_9) \times 2250/8050$
02H	0	0	0	0	1	0	V2''	$V_9+(V_8-V_9) \times 1550/8050$
01H	0	0	0	0	0	1	V1''	$V_9+(V_8-V_9) \times 800/8050$
00H	0	0	0	0	0	0	V0''	V9

m	(Ω)
r62	800
r61	500
r60	300
r59	250
r58	250
r57	200
r56	200
r55	150
r54	150
r53	150
r52	100
r51	100
r50	100
r49	100
r48	100
r47	100
r46	100
r45	100
r44	100
r43	100
r42	100
r41	100
r40	100
r39	100
r38	100
r37	100
r36	100
r35	100
r34	100
r33	100
r32	100
r31	100
r30	100
r29	100
r28	100
r27	100
r26	150
r25	150
r24	150
r23	150
r22	200
r21	200
r20	200
r19	250
r18	250
r17	250
r16	300
r15	300
r14	300
r13	350
r12	350
r11	350
r10	400
r9	400
r8	500
r7	500
r6	550
r5	550
r4	600
r3	650
r2	700
r1	750
r0	800
rTotal	15850

Caution Between V4 and V5 terminal is not connected in the chip.

3. RELATIONSHIP BETWEEN INPUT DATA AND OUTPUT PIN

Data format: 6 bits × 2 RGBs (6 dots)

Input width : 36 bits (2-pixel data)

R,/L = H (Right shift)

Output	S ₁	S ₂	S ₃	S ₄	...	S ₃₈₃	S ₃₈₄
Data	D ₀₀ to D ₀₅	D ₁₀ to D ₁₅	D ₂₀ to D ₂₅	D ₃₀ to D ₃₅	...	D ₄₀ to D ₄₅	D ₅₀ to D ₅₅

R,/L = L (Left shift)

Output	S ₁	S ₂	S ₃	S ₄	...	S ₃₈₃	S ₃₈₄
Data	D ₀₀ to D ₀₅	D ₁₀ to D ₁₅	D ₂₀ to D ₂₅	D ₃₀ to D ₃₅	...	D ₄₀ to D ₄₅	D ₅₀ to D ₅₅

POL	S _{2n-1} ^{Note}	S _{2n} ^{Note}
L	V ₀ to V ₄	V ₅ to V ₉
H	V ₅ to V ₉	V ₀ to V ₄

Note S_{2n-1} (Odd output), S_{2n} (Even output)

4. RELATIONSHIP BETWEEN STB, POL, AND OUTPUT WAVEFORM

The output voltage is written to the LCD panel synchronized with the STB falling edge.

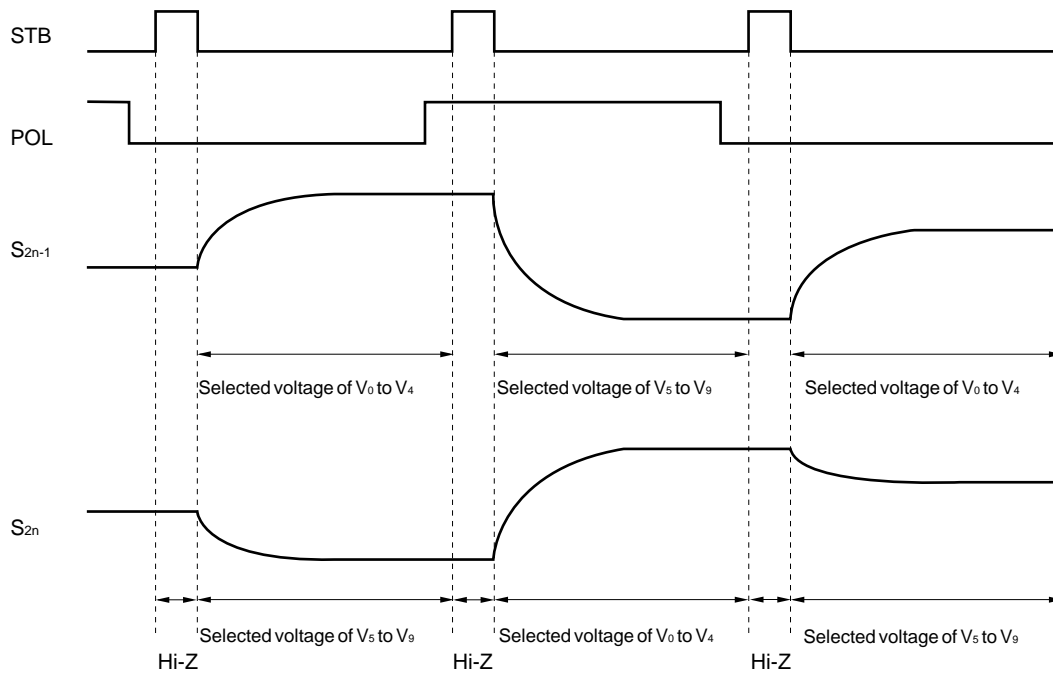

5. ELECTRICAL SPECIFICATION

Absolute Maximum Ratings ($T_A = +25\text{ °C}$, $V_{SS1} = V_{SS2} = 0\text{ V}$)

Parameter	Symbol	Rating	Unit
Logic Part Supply Voltage	V_{DD1}	-0.5 to +5.0	V
Driver Part Supply Voltage	V_{DD2}	-0.5 to +10.0	V
Logic Part Input Voltage	V_{I1}	-0.5 to $V_{DD1} + 0.5$	V
Driver Part Input Voltage	V_{I2}	-0.5 to $V_{DD2} + 0.5$	V
Logic Part Output Voltage	V_{O1}	-0.5 to $V_{DD1} + 0.5$	V
Driver Part Output Voltage	V_{O2}	-0.5 to $V_{DD2} + 0.5$	V
Operating Temperature Range	T_A	-10 to +75	°C
Storage Temperature Range	T_{stg}	-55 to +125	°C

Caution If the absolute maximum rating of even one of the above parameters is exceeded even momentarily, the quality of the product may be degraded. Absolute maximum ratings, therefore, specify the values exceeding which the product may be physically damaged. Be sure to use the product within the range of the absolute maximum ratings.

Recommended Operating Range ($T_A = -10\text{ to }+75\text{ °C}$, $V_{SS1} = V_{SS2} = 0\text{ V}$)

Parameter	Symbol	MIN.	TYP.	MAX.	Unit
Logic Part Supply Voltage	V_{DD1}	3.0	3.3	3.6	V
Driver Part Supply Voltage	V_{DD2}	8.0	8.5	9.0	V
High-Level Input Voltage	V_{IH}	$0.7 V_{DD1}$		V_{DD1}	V
Low-Level Input Voltage	V_{IL}	0		$0.3 V_{DD1}$	V
γ-Corrected Voltage	V_0 to V_9	V_{SS2}		V_{DD2}	V
Driver Part Output Voltage	V_O	$V_{SS2} + 0.1$		$V_{DD2} - 0.1$	V
Maximum Clock Frequency	f_{MAX}	40			MHz

Electrical Specifications (T_A = -10 to +75 °C, V_{DD1} = 3.3 V ±0.3 V, V_{DD2} = 8.5 V ±0.5 V, V_{SS1} = V_{SS2} = 0 V)

Parameter	Symbol	Condition	MIN.	TYP.	MAX.	Unit	
Input Leak Current	I _{IL}				±1.0	μ A	
High-Level Output Voltage	V _{OH}	STHR (STHL), I _{OH} = 0 mA	V _{DD1} - 0.1			V	
Low-Level Output Voltage	V _{OL}	STHR (STHL), I _{OL} = 0 mA			0.1	V	
γ-Corrected Supply Current	I _γ	V ₀ to V ₄ = V ₅ to V ₉ = 4.0 V	V ₀ pin, V ₄ pin	126	252	504	μ A
			V ₅ pin, V ₉ pin	-504	-252	-126	μ A
Driver Output Current	I _{VOH}	V _X = 7.0 V, V _{OUT} = 6.5 V ^{Note}			-30	μ A	
	I _{VOL}	V _X = 1.0 V, V _{OUT} = 1.5 V ^{Note}	30			μ A	
Output Voltage Deviation	ΔV _O	V _{DD1} = 3.3 V, V _{DD2} = 8.5 V,		±7	±20	mV	
Output swing difference deviation	ΔV _{P-P}	V _{OUT} = 2.0 V, 4.25 V, 6.5 V		±2	±15	mV	
Output Voltage Range	V _O	Input data	0.1		V _{DD2} - 0.1	V	
Logic Part Dynamic Current Consumption	I _{DD1}	V _{DD1} , with no load		2.0	10	mA	
Driver Part Dynamic Current Consumption	I _{DD2}	V _{DD2} , with no load		3.0	10	mA	

Note V_X refers to the output voltage of analog output pins S₁ to S₃₈₄.
V_{OUT} refers to the voltage applied to analog output pins S₁ to S₃₈₄.

- Cautions**
1. The STB cycle is defined to be 20 μs at f_{CLK} = 40 MHz.
 2. The TYP. values refer to an all black or all white input pattern. The MAX. value refers to the measured values in the dot checkerboard input pattern.
 3. Refers to the current consumption per driver when cascades are connected under the assumption of XGA single-sided mounting (8 units).

Switching Characteristics (T_A = -10 to +75 °C, V_{DD1} = 3.3 V ±0.3 V, V_{DD2} = 8.5 V ±0.5 V, V_{SS1} = V_{SS2} = 0 V)

Parameter	Symbol	Condition	MIN.	TYP.	MAX.	Unit
Start Pulse Delay Time	t _{PLH1}	C _L = 10 pF		10	20	ns
Driver Output Delay Time	t _{PLH2}	C _L = 75 pF, R _L = 5 kΩ, V _{DD1} = 3.3 V, V _{DD2} = 9.0 V		2.5	4	μ s
	t _{PLH3}			5	7	μ s
	t _{PHL2}			2.5	4	μ s
	t _{PHL3}			5	7	μ s
Input Capacitance	C _{I1}	STHR (STHL) excluded, T _A = 25°C		5	10	pF
	C _{I2}	STHR (STHL), T _A = 25°C		5	10	pF

Measurement Condition

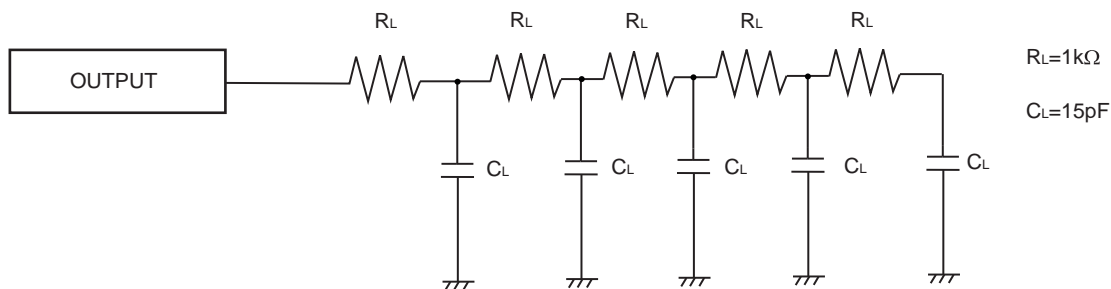

Timing Requirement ($T_A = -10$ to $+75$ °C, $V_{DD1} = 3.3$ V ± 0.3 V, $V_{SS1} = V_{SS2} = 0$ V)

Parameter	Symbol	Condition	MIN.	TYP.	MAX.	Unit
Clock Pulse Width	PW_{CLK}		25			ns
Clock Pulse High Period	$PW_{CLK(H)}$		4			ns
Clock Pulse Low Period	$PW_{CLK(L)}$		4			ns
Data Setup Time	t_{SETUP1}		4			ns
Data Hold Time	t_{HOLD1}		0			ns
Start Pulse Setup Time	t_{SETUP2}		4			ns
Start Pulse Hold Time	t_{HOLD2}		0			ns
POL2 Setup Time	t_{SETUP3}		4			ns
POL2 Hold Time	t_{HOLD3}		0			ns
Start Pulse Low Period	t_{SPL}		6			ns
STB Pulse Width	PW_{STB}		2			CLK
					4	μs
Data Invalid Period	t_{INV}		1			CLK
Last Data Timing	t_{LDT}		2			CLK
★ CLK-STB Time	$t_{CLK-STB}$	CLK ↑ → STB ↑	6			ns
★ STB-CLK Time	$t_{STB-CLK}$	STB ↑ → CLK ↑	6			ns
Time Between STB and Start Pulse	$t_{STB-STH}$	STB ↑ → STHR(STHL) ↑	2			CLK
POL-STB Time	$t_{POL-STB}$	POL ↑ or ↓ → STB ↑	-5			ns
STB-POL Time	$t_{STB-POL}$	STB ↓ → POL ↓ or ↑	6			ns

*** 6. SWITCHING CHARACTERISTICS WAVEFORM (R_s/L = H)**

(Unless otherwise specified, the input level is defined to be $V_{IH} = 0.7 V_{DD1}$, $V_{IL} = 0.3 V_{DD1}$.)

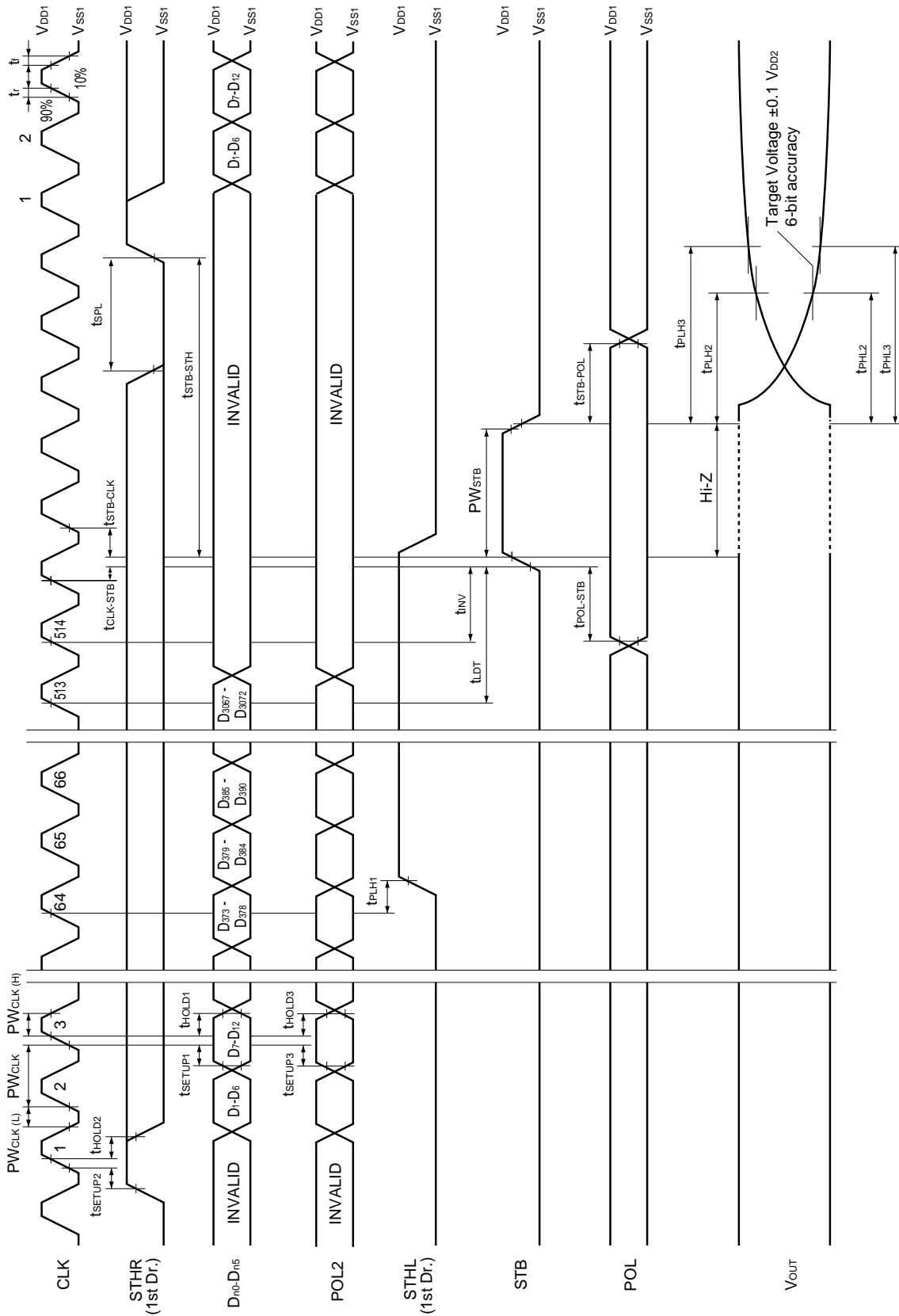

7. RECOMMENDED SOLDERING CONDITIONS

The following conditions must be met for soldering conditions of the μ PD16732.

For more details, refer to the **Semiconductor Device Mounting Technology Manual (C10535E)**.

Please consult with our sales offices in case other soldering process is used, or in case the soldering is done under different conditions.

Type of Surface Mount Device

μ PD16732N-xxx : TCP (TAB package)

Mounting Condition	Mounting Method	Condition
Thermocompression	Soldering	Heating tool 300 to 350°C: heating for 2 to 3 seconds: pressure 100g (per solder)
	ACF (Adhesive Conductive Film)	Temporary bonding 70 to 100°C: pressure 3 to 8 kg/cm ² : time 3 to 5 secs. Real bonding 165 to 180°C: pressure 25 to 45 kg/cm ² : time 30 to 40 secs. (When using the anisotropy conductive film SUMIZAC1003 of Sumitomo Bakelite, Ltd.)

Caution To find out the detailed conditions for packaging the ACF part, please contact the ACF manufacturing company. Be sure to avoid using two or more packaging methods at a time.

[MEMO]

NOTES FOR CMOS DEVICES

① PRECAUTION AGAINST ESD FOR SEMICONDUCTORS

Note:

Strong electric field, when exposed to a MOS device, can cause destruction of the gate oxide and ultimately degrade the device operation. Steps must be taken to stop generation of static electricity as much as possible, and quickly dissipate it once, when it has occurred. Environmental control must be adequate. When it is dry, humidifier should be used. It is recommended to avoid using insulators that easily build static electricity. Semiconductor devices must be stored and transported in an anti-static container, static shielding bag or conductive material. All test and measurement tools including work bench and floor should be grounded. The operator should be grounded using wrist strap. Semiconductor devices must not be touched with bare hands. Similar precautions need to be taken for PW boards with semiconductor devices on it.

② HANDLING OF UNUSED INPUT PINS FOR CMOS

Note:

No connection for CMOS device inputs can be cause of malfunction. If no connection is provided to the input pins, it is possible that an internal input level may be generated due to noise, etc., hence causing malfunction. CMOS devices behave differently than Bipolar or NMOS devices. Input levels of CMOS devices must be fixed high or low by using a pull-up or pull-down circuitry. Each unused pin should be connected to V_{DD} or GND with a resistor, if it is considered to have a possibility of being an output pin. All handling related to the unused pins must be judged device by device and related specifications governing the devices.

③ STATUS BEFORE INITIALIZATION OF MOS DEVICES

Note:

Power-on does not necessarily define initial status of MOS device. Production process of MOS does not define the initial operation status of the device. Immediately after the power source is turned ON, the devices with reset function have not yet been initialized. Hence, power-on does not guarantee out-pin levels, I/O settings or contents of registers. Device is not initialized until the reset signal is received. Reset operation must be executed immediately after power-on for devices having reset function.

Reference Documents**NEC Semiconductor Device Reliability / Quality Control System (C10983E)****Quality Grades to NEC's Semiconductor Devices (C11531E)**

- **The information in this document is subject to change without notice. Before using this document, please confirm that this is the latest version.**
 - No part of this document may be copied or reproduced in any form or by any means without the prior written consent of NEC Corporation. NEC Corporation assumes no responsibility for any errors which may appear in this document.
 - NEC Corporation does not assume any liability for infringement of patents, copyrights or other intellectual property rights of third parties by or arising from use of a device described herein or any other liability arising from use of such device. No license, either express, implied or otherwise, is granted under any patents, copyrights or other intellectual property rights of NEC Corporation or others.
 - Descriptions of circuits, software, and other related information in this document are provided for illustrative purposes in semiconductor product operation and application examples. The incorporation of these circuits, software, and information in the design of the customer's equipment shall be done under the full responsibility of the customer. NEC Corporation assumes no responsibility for any losses incurred by the customer or third parties arising from the use of these circuits, software, and information.
 - While NEC Corporation has been making continuous effort to enhance the reliability of its semiconductor devices, the possibility of defects cannot be eliminated entirely. To minimize risks of damage or injury to persons or property arising from a defect in an NEC semiconductor device, customers must incorporate sufficient safety measures in its design, such as redundancy, fire-containment, and anti-failure features.
 - NEC devices are classified into the following three quality grades:
"Standard", "Special", and "Specific". The Specific quality grade applies only to devices developed based on a customer designated "quality assurance program" for a specific application. The recommended applications of a device depend on its quality grade, as indicated below. Customers must check the quality grade of each device before using it in a particular application.
 - Standard: Computers, office equipment, communications equipment, test and measurement equipment, audio and visual equipment, home electronic appliances, machine tools, personal electronic equipment and industrial robots
 - Special: Transportation equipment (automobiles, trains, ships, etc.), traffic control systems, anti-disaster systems, anti-crime systems, safety equipment and medical equipment (not specifically designed for life support)
 - Specific: Aircraft, aerospace equipment, submersible repeaters, nuclear reactor control systems, life support systems or medical equipment for life support, etc.
- The quality grade of NEC devices is "Standard" unless otherwise specified in NEC's Data Sheets or Data Books. If customers intend to use NEC devices for applications other than those specified for Standard quality grade, they should contact an NEC sales representative in advance.