

To our customers,

Old Company Name in Catalogs and Other Documents

On April 1st, 2010, NEC Electronics Corporation merged with Renesas Technology Corporation, and Renesas Electronics Corporation took over all the business of both companies. Therefore, although the old company name remains in this document, it is a valid Renesas Electronics document. We appreciate your understanding.

Renesas Electronics website: <http://www.renesas.com>

April 1st, 2010
Renesas Electronics Corporation

Issued by: Renesas Electronics Corporation (<http://www.renesas.com>)

Send any inquiries to <http://www.renesas.com/inquiry>.

Notice

1. All information included in this document is current as of the date this document is issued. Such information, however, is subject to change without any prior notice. Before purchasing or using any Renesas Electronics products listed herein, please confirm the latest product information with a Renesas Electronics sales office. Also, please pay regular and careful attention to additional and different information to be disclosed by Renesas Electronics such as that disclosed through our website.
2. Renesas Electronics does not assume any liability for infringement of patents, copyrights, or other intellectual property rights of third parties by or arising from the use of Renesas Electronics products or technical information described in this document. No license, express, implied or otherwise, is granted hereby under any patents, copyrights or other intellectual property rights of Renesas Electronics or others.
3. You should not alter, modify, copy, or otherwise misappropriate any Renesas Electronics product, whether in whole or in part.
4. Descriptions of circuits, software and other related information in this document are provided only to illustrate the operation of semiconductor products and application examples. You are fully responsible for the incorporation of these circuits, software, and information in the design of your equipment. Renesas Electronics assumes no responsibility for any losses incurred by you or third parties arising from the use of these circuits, software, or information.
5. When exporting the products or technology described in this document, you should comply with the applicable export control laws and regulations and follow the procedures required by such laws and regulations. You should not use Renesas Electronics products or the technology described in this document for any purpose relating to military applications or use by the military, including but not limited to the development of weapons of mass destruction. Renesas Electronics products and technology may not be used for or incorporated into any products or systems whose manufacture, use, or sale is prohibited under any applicable domestic or foreign laws or regulations.
6. Renesas Electronics has used reasonable care in preparing the information included in this document, but Renesas Electronics does not warrant that such information is error free. Renesas Electronics assumes no liability whatsoever for any damages incurred by you resulting from errors in or omissions from the information included herein.
7. Renesas Electronics products are classified according to the following three quality grades: “Standard”, “High Quality”, and “Specific”. The recommended applications for each Renesas Electronics product depends on the product’s quality grade, as indicated below. You must check the quality grade of each Renesas Electronics product before using it in a particular application. You may not use any Renesas Electronics product for any application categorized as “Specific” without the prior written consent of Renesas Electronics. Further, you may not use any Renesas Electronics product for any application for which it is not intended without the prior written consent of Renesas Electronics. Renesas Electronics shall not be in any way liable for any damages or losses incurred by you or third parties arising from the use of any Renesas Electronics product for an application categorized as “Specific” or for which the product is not intended where you have failed to obtain the prior written consent of Renesas Electronics. The quality grade of each Renesas Electronics product is “Standard” unless otherwise expressly specified in a Renesas Electronics data sheets or data books, etc.
 - “Standard”: Computers; office equipment; communications equipment; test and measurement equipment; audio and visual equipment; home electronic appliances; machine tools; personal electronic equipment; and industrial robots.
 - “High Quality”: Transportation equipment (automobiles, trains, ships, etc.); traffic control systems; anti-disaster systems; anti-crime systems; safety equipment; and medical equipment not specifically designed for life support.
 - “Specific”: Aircraft; aerospace equipment; submersible repeaters; nuclear reactor control systems; medical equipment or systems for life support (e.g. artificial life support devices or systems), surgical implantations, or healthcare intervention (e.g. excision, etc.), and any other applications or purposes that pose a direct threat to human life.
8. You should use the Renesas Electronics products described in this document within the range specified by Renesas Electronics, especially with respect to the maximum rating, operating supply voltage range, movement power voltage range, heat radiation characteristics, installation and other product characteristics. Renesas Electronics shall have no liability for malfunctions or damages arising out of the use of Renesas Electronics products beyond such specified ranges.
9. Although Renesas Electronics endeavors to improve the quality and reliability of its products, semiconductor products have specific characteristics such as the occurrence of failure at a certain rate and malfunctions under certain use conditions. Further, Renesas Electronics products are not subject to radiation resistance design. Please be sure to implement safety measures to guard them against the possibility of physical injury, and injury or damage caused by fire in the event of the failure of a Renesas Electronics product, such as safety design for hardware and software including but not limited to redundancy, fire control and malfunction prevention, appropriate treatment for aging degradation or any other appropriate measures. Because the evaluation of microcomputer software alone is very difficult, please evaluate the safety of the final products or system manufactured by you.
10. Please contact a Renesas Electronics sales office for details as to environmental matters such as the environmental compatibility of each Renesas Electronics product. Please use Renesas Electronics products in compliance with all applicable laws and regulations that regulate the inclusion or use of controlled substances, including without limitation, the EU RoHS Directive. Renesas Electronics assumes no liability for damages or losses occurring as a result of your noncompliance with applicable laws and regulations.
11. This document may not be reproduced or duplicated, in any form, in whole or in part, without prior written consent of Renesas Electronics.
12. Please contact a Renesas Electronics sales office if you have any questions regarding the information contained in this document or Renesas Electronics products, or if you have any other inquiries.

(Note 1) “Renesas Electronics” as used in this document means Renesas Electronics Corporation and also includes its majority-owned subsidiaries.

(Note 2) “Renesas Electronics product(s)” means any product developed or manufactured by or for Renesas Electronics.

Phase-out/Discontinued

1/17, 1/25, 1/33 DUTY LCD CONTROLLER/DRIVER

DESCRIPTION

The μ PD16670 is a LCD controller/driver with 1/17, 1/25 and 1/33 duty capable of displaying a dot matrix LCD. It has 60 segment outputs, 33 common outputs, giving a maximum display capability of 12 columns x 4 lines (at 1/33 duty).

The μ PD16670 includes 4 x mode on-chip booster circuit, capable of operating on single 3 V-power supply.

FEATURES

- Dot matrix LCD controller/driver
- Able to operate using +3-V single power supply
- 4 x mode on-chip boost circuit
- Display contents
 - 1/17 duty: 12 columns x 2 lines + 60 pictograph displays
 - 1/25 duty: 12 columns x 3 lines + 60 pictograph displays
 - 1/33 duty: 12 columns x 4 lines + 60 pictograph displays
- Serial data input (SCK, STB, DATA)

ORDERING INFORMATION

Part number	Package
μ PD16670W-xxx	Wafer
μ PD16670P-xxx	Chip

- ★ **Remark** Purchasing the above chip/wafer entails exchange of documents such as a separate memorandum or product quality, so please contact one of our sales representatives.

The information in this document is subject to change without notice. Before using this document, please confirm that this is the latest version.
 Not all devices/types available in every country. Please check with local NEC representative for availability and additional information.

★ 1. BLOCK DIAGRAM

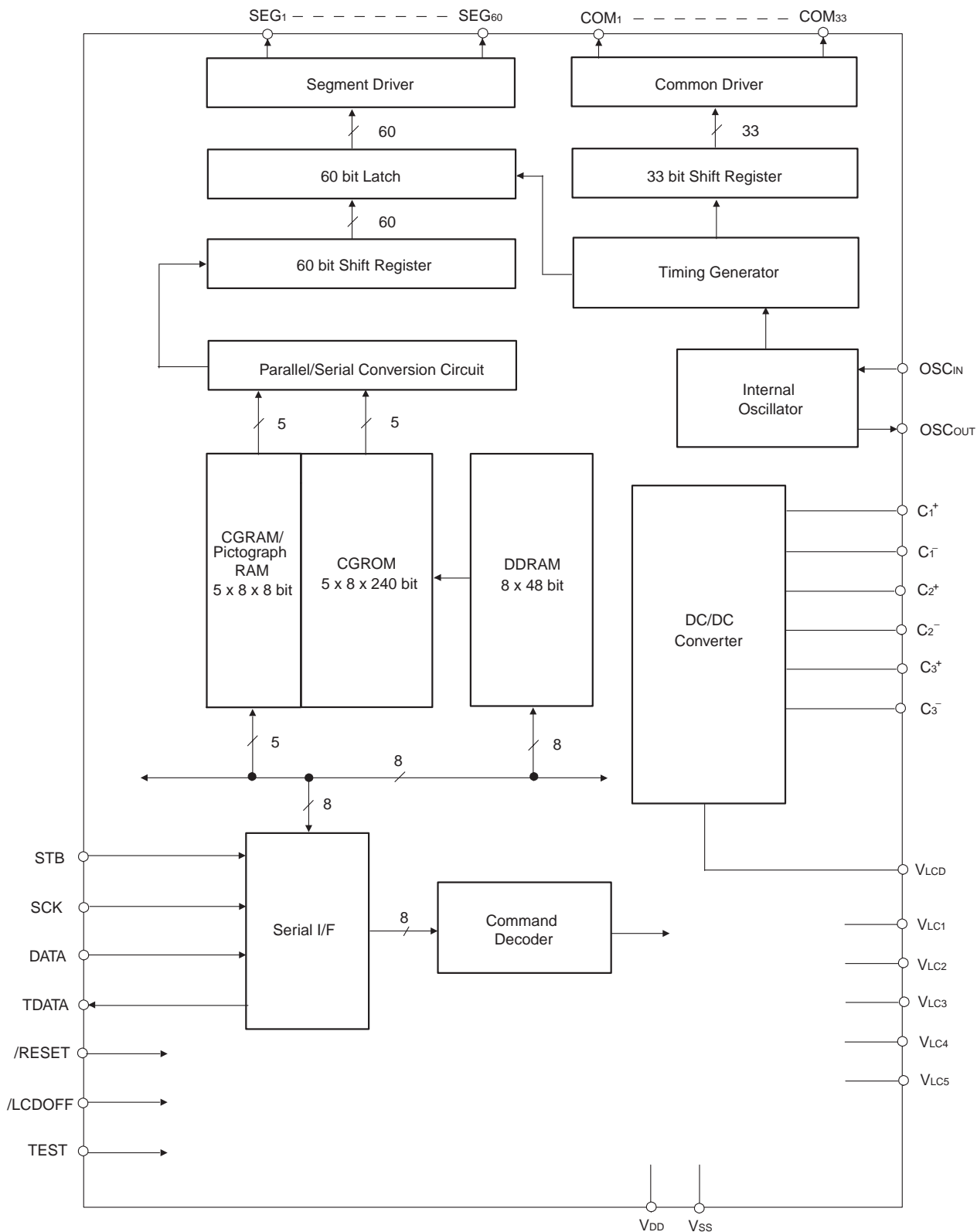

★ **Remark** /xxx indicates active low signals.

2. PIN CONFIGURATION (Pad Layout)

Chip size: 4.20 x 5.40 mm²

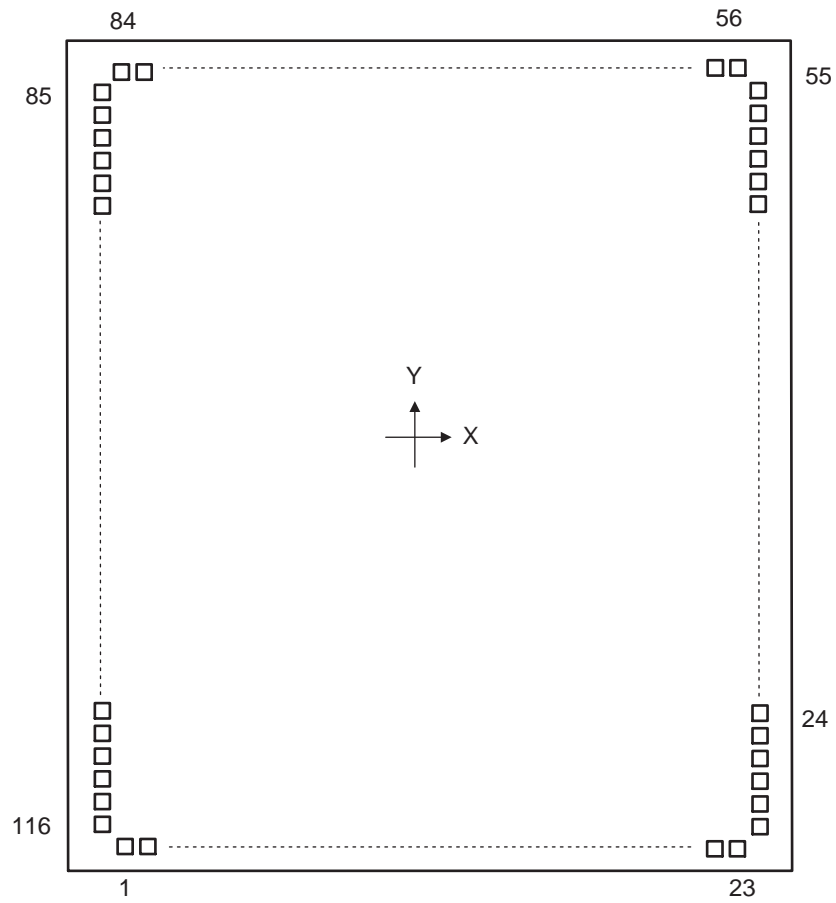

Table 2-1. Pad Layout

PAD No.	Pad Name	X (μm)	Y (μm)	PAD No.	Pad Name	X (μm)	Y (μm)
1	C ₂ ⁺	-1545	-2480	59	SEG41	1319	2479
2	C ₂ ⁻	-1425	-2480	60	SEG40	1199	2479
3	C ₃ ⁺	-1305	-2480	61	SEG39	1079	2479
4	C ₃ ⁻	-1135	-2480	62	SEG38	959	2479
5	C ₁ ⁺	-1015	-2480	63	SEG37	839	2479
6	C ₁ ⁻	-845	-2480	64	SEG36	719	2479
7	V _{DD}	-725	-2480	65	SEG35	599	2479
8	V _{LCD}	-605	-2480	66	SEG34	479	2479
9	V _{LC1}	-435	-2480	67	SEG33	359	2479
10	V _{LC2}	-265	-2480	68	SEG32	239	2479
11	V _{LC3}	-95	-2480	69	SEG31	119	2479
12	V _{LC4}	75	-2480	70	SEG30	-1	2479
13	V _{LC5}	245	-2480	71	SEG29	-121	2479
14	V _{SS}	365	-2480	72	SEG28	-241	2479
15	OSC _{IN}	485	-2480	73	SEG27	-361	2479
16	OSC _{OUT}	605	-2480	74	SEG26	-481	2479
17	TEST	775	-2480	75	SEG25	-601	2479
18	TDATA	895	-2480	76	SEG24	-721	2479
19	RESETB	1065	-2480	77	SEG23	-841	2479
20	LCDOFFB	1185	-2480	78	SEG22	-961	2479
21	STB	1355	-2480	79	SEG21	-1081	2479
22	SCK	1475	-2480	80	SEG20	-1201	2479
23	DATA	1645	-2480	81	SEG19	-1321	2479
24	COM ₁₈	1837	-1839	82	SEG18	-1441	2479
25	COM ₁₉	1837	-1719	83	SEG17	-1561	2479
26	COM ₂₀	1837	-1599	84	SEG16	-1681	2479
27	COM ₂₁	1837	-1479	85	SEG15	-1837	1880
28	COM ₂₂	1837	-1359	86	SEG14	-1837	1760
29	COM ₂₃	1837	-1239	87	SEG13	-1837	1640
30	COM ₂₄	1837	-1119	88	SEG12	-1837	1520
31	COM ₂₅	1837	-999	89	SEG11	-1837	1400
32	COM ₂₆	1837	-879	90	SEG10	-1837	1280
33	COM ₂₇	1837	-759	91	SEG9	-1837	1160
34	COM ₂₈	1837	-639	92	SEG8	-1837	1040
35	COM ₂₉	1837	-519	93	SEG7	-1837	920
36	COM ₃₀	1837	-399	94	SEG6	-1837	800
37	COM ₃₁	1837	-279	95	SEG5	-1837	680
38	COM ₃₂	1837	-159	96	SEG4	-1837	560
39	COM ₃₃	1837	-39	97	SEG3	-1837	440
40	SEG60	1837	81	98	SEG2	-1837	320
41	SEG59	1837	201	99	SEG1	-1837	200
42	SEG58	1837	321	100	COM17	-1837	80
43	SEG57	1837	441	101	COM16	-1837	-40
44	SEG56	1837	561	102	COM15	-1837	-160
45	SEG55	1837	681	103	COM14	-1837	-280
46	SEG54	1837	801	104	COM13	-1837	-400
47	SEG53	1837	921	105	COM12	-1837	-520
48	SEG52	1837	1041	106	COM11	-1837	-640
49	SEG51	1837	1161	107	COM10	-1837	-760
50	SEG50	1837	1281	108	COM9	-1837	-880
51	SEG49	1837	1401	109	COM8	-1837	-1000
52	SEG48	1837	1521	110	COM7	-1837	-1120
53	SEG47	1837	1641	111	COM6	-1837	-1240
54	SEG46	1837	1761	112	COM5	-1837	-1360
55	SEG45	1837	1881	113	COM4	-1837	-1480
56	SEG44	1679	2479	114	COM3	-1837	-1600
57	SEG43	1559	2479	115	COM2	-1837	-1720
58	SEG42	1439	2479	116	COM1	-1837	-1840

3. PIN FUNCTIONS

Pin Symbol	Pin Name	Pad No.	I/O	Description
SEG ₁ to SEG ₆₀	Segment	40 to 99	O	Segment output pins
★ COM ₁ to COM ₃₃	Common	24 to 39 100 to 116	O	Common output pins COM ₁ is assigned to common for pictograph.
SCK	Shift clock	22	I	Data shift clock During the read-in operation, data is captured in the shift register at the signal's rising edge. During a read-out operation, data is read from the shift register at the signal's falling edge.
DATA	Data	23	I	Performs input of commands and data. Input is performed from the MSB on the rise of the shift clock.
STB	Strobe	21	I	Communication is enabled when STB is low.
/LCDOFF	LCD off input	20	I	When at low level, a forced LCD off operation is performed SEGN = COMn = V _{SS}
/RESET	Reset	19	I	This pin is used for internal resets at low level.
TDATA	Test output	18	O	This is a test output pin. Leave this pin open when using the device.
TEST	Test pin	17	I	Test mode is set when at high level.
OSC _{IN}	Oscillator pins	15, 16	I	These pins are connected to a 100-kΩ resistance. When using an external oscillator, input to OSC _{IN} and leave OSC _{OUT} open.
OSC _{OUT}		5, 6	O	
C ₁ ⁺ , C ₁ ⁻ C ₂ ⁺ , C ₂ ⁻ C ₃ ⁺ , C ₃ ⁻	Capacitor connection pins	1 to 6	-	These are capacitor connection pins for the boost circuit. Connect a 1-μF capacitor.
V _{DD}	Logic power supply pin	7	-	Power supply pins for logic
V _{SS}	Logic ground pin	14	-	Ground pin for logic
V _{LCD}	Driver power supply pins	8	-	Power supply pin for driver. Output pin for internal boost circuit. Connect a 1-μF capacitor between this pin and the V _{SS} pin for boosting. If not using the internal boost circuit, a direct driver power supply can be input.
V _{LC1} - V _{LC5}	Reference power supply pins for driver	9 to 13	-	These are reference power supply pins for the LCD driver. Input divided register by each external power supply pin.

Figure 3-1. Example of LCD driver's circuit and external circuit for boosted circuit

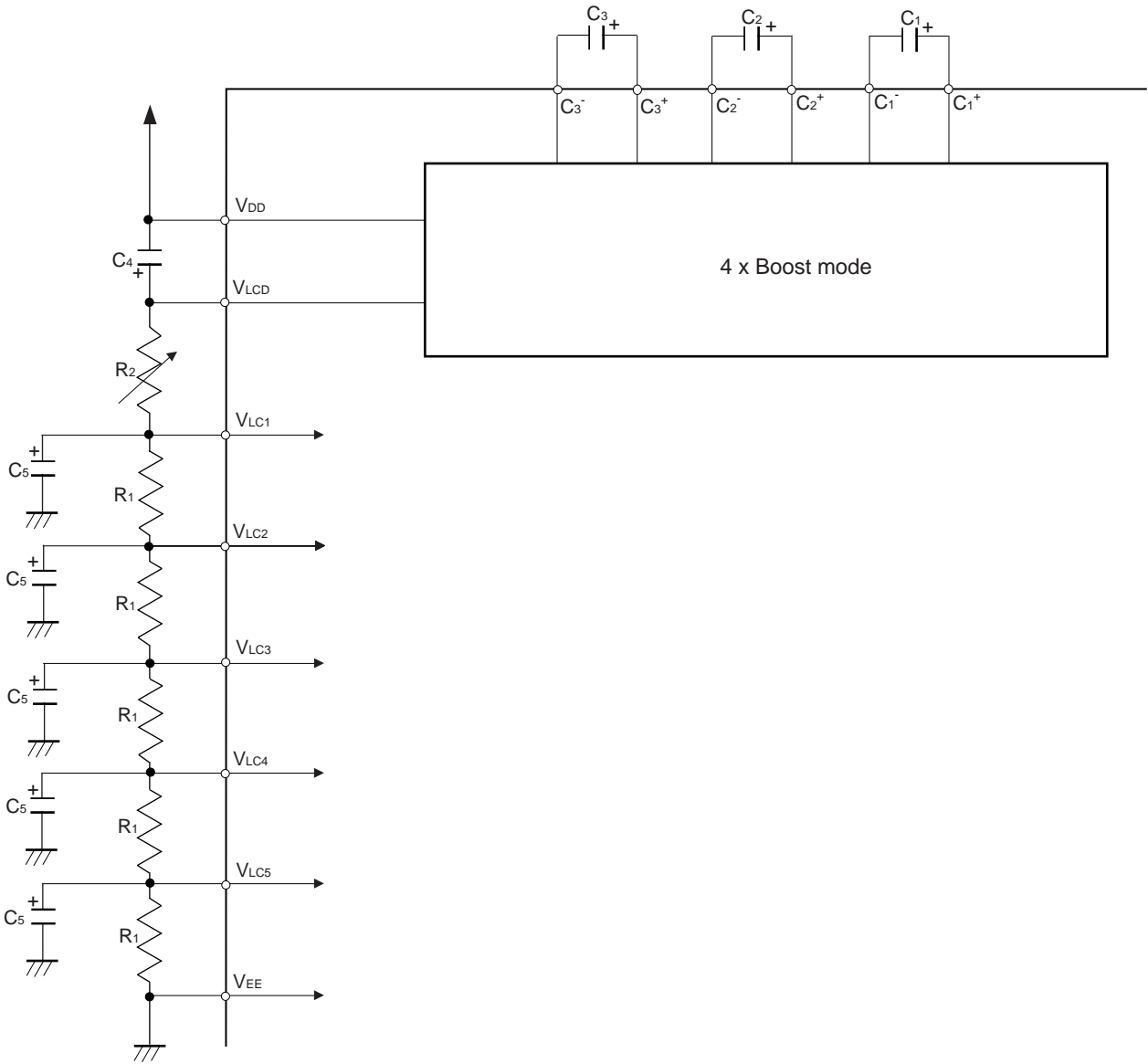

4. LCD DISPLAY DRIVER

μ PD16670, a 5 x 8 segment display and pictograph display segments can be driven.

(1) Example of 1/17 duty connection: 12 columns x 2 lines + 60 pictograph displays

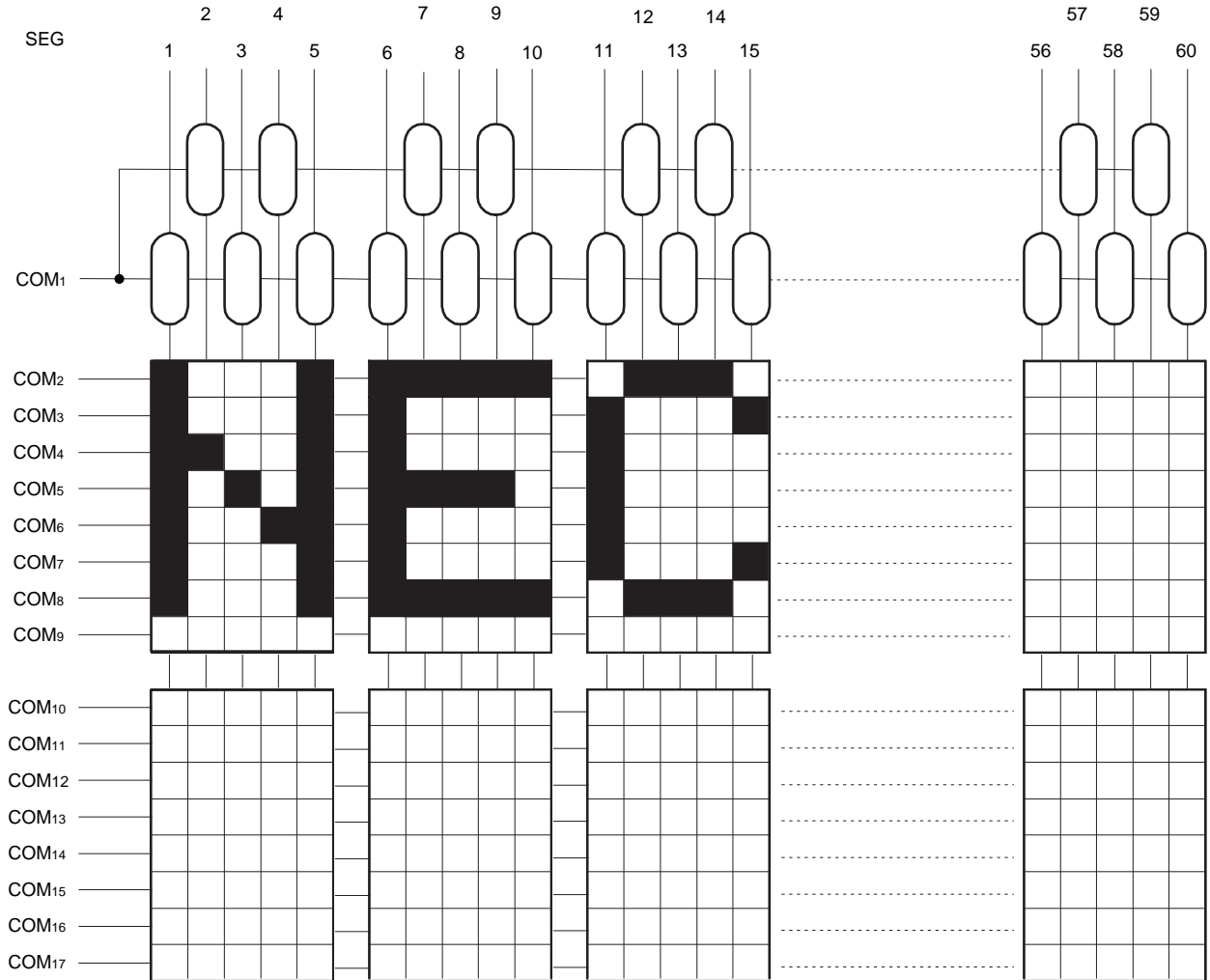

(2) Example of 1/25 duty connection: 12 columns x 3 lines + 60 pictograph displays

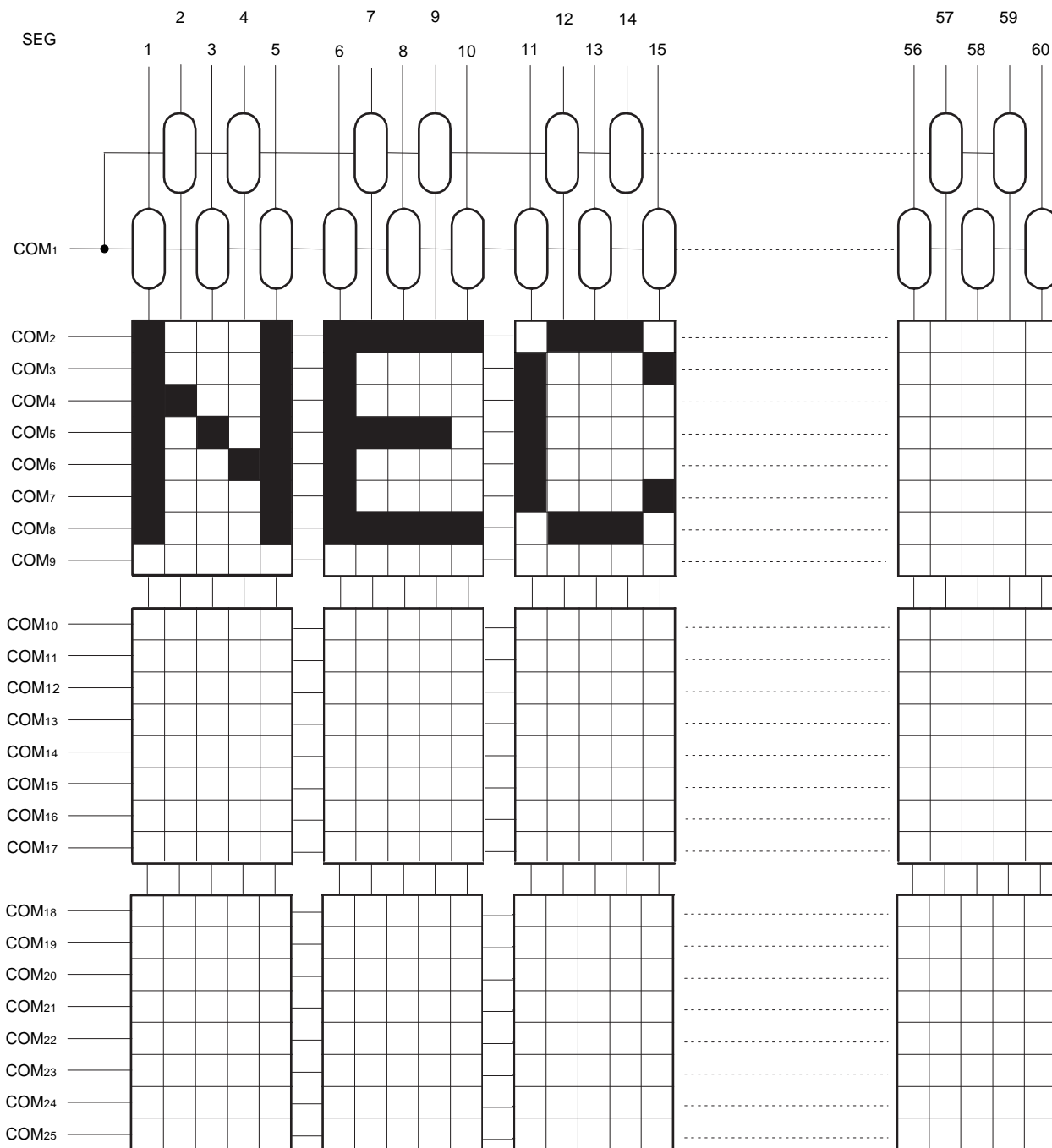

(3) Example of 1/33 duty connection: 12 columns x 4 lines + 60 pictograph displays

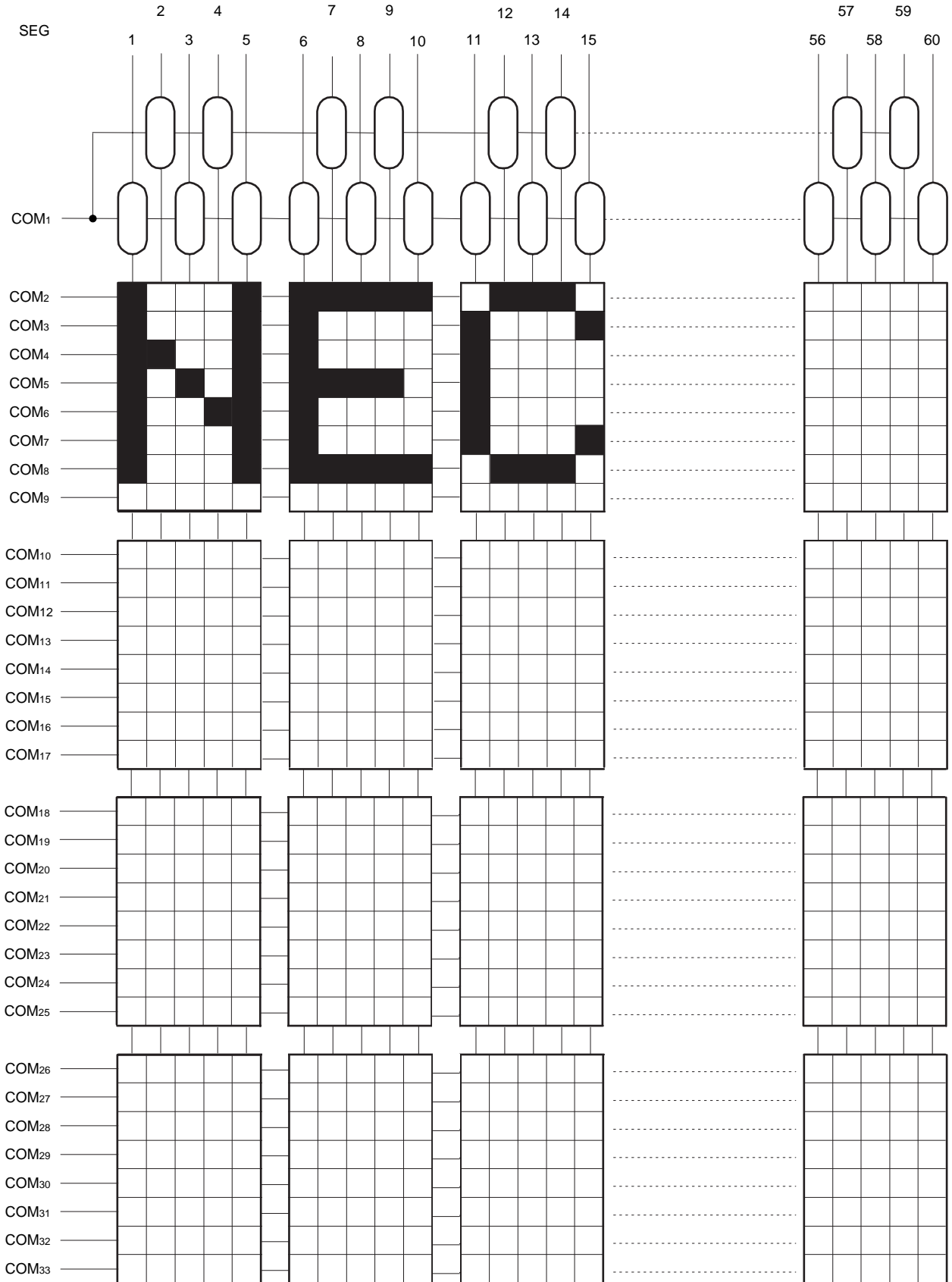

5. CHARACTER CODE

The relation between character codes and character patterns is shown below. Character codes [0xxx] are allocated to CGRAM.

Higher bits Lower bits 4 bits	0000	0001	0010	0011	0100	0101	0110	0111	1010	1011	1100	1101	1110	1111
XXXX0000	CGRAM (1)	△	□	○	▽	◇	◇	◇	◇	◇	◇	◇	◇	◇
XXXX0001	(2)	α	!	1	A	Q	a	9	a	7	+	4	é	ó
XXXX0010	(3)	⊛	"	2	B	R	b	r	Γ	4	W	x	i	N
XXXX0011	(4)	Γ	#	3	C	S	c	s	∩	7	τ	ε	ó	ú
XXXX0100	(5)	A	*	4	D	T	d	t	∩	1	1	τ	é	ó
XXXX0101	(6)	α	%	5	E	U	e	u	∩	+	+	1	é	á
XXXX0110	(7)	π	&	6	F	V	f	v	∩	∩	∩	∩	∩	∩
XXXX0111	(8)	ψ	'	7	G	W	g	w	∩	+	∩	∩	∩	∩
XXXX1000	(1)	Σ	(8	H	X	h	x	∩	∩	∩	∩	∩	∩
XXXX1001	(2)	θ)	9	I	Y	i	y	∩	∩	∩	∩	∩	∩
XXXX1010	(3)	Σ	*	∩	J	Z	j	z	∩	∩	∩	∩	∩	∩
XXXX1011	(4)	i	+	∩	K	L	k	l	∩	∩	∩	∩	∩	∩
XXXX1100	(5)	E	,	∩	L	*	l	∩	∩	∩	∩	∩	∩	∩
XXXX1101	(6)	æ	-	=	M	I	m)	a	∩	∩	∩	∩	∩
XXXX1110	(7)	B	.	>	N	^	n	∩	∩	∩	∩	∩	∩	∩
XXXX1111	(8)	E	/	?	O	_	o	∩	∩	∩	∩	∩	∩	∩

6. DESCRIPTION OF BLOCKS

6.1 Display Data RAM (DDRAM)

DDRAM addresses are allocated as shown below

	1	2	3	4	5	6	7	8	9	10	11	12
1st line	00H	01H	02H	03H	04H	05H	06H	07H	08H	09H	0AH	0BH
2nd line	12H	13H	14H	15H	16H	17H	18H	19H	1AH	1BH	1CH	1DH
3rd line	24H	25H	26H	27H	28H	29H	2AH	2BH	2CH	2DH	2EH	2FH
4th line	36H	37H	38H	39H	3AH	3BH	3CH	3DH	3EH	3FH	40H	41H

Caution DDRAM are used 0BH → 10H, 1BH → 20H, 2BH → 30H, 3BH → 00H when in auto increment mode.

6.2 Character Generator RAM (CGRAM)

CGRAM is RAM to which the user can freely set character patterns. Eight types of 5 x 8 dot character patterns can be defined. CGRAM is the RAM that contains pictograph display data.

The relation between character codes and CGRAM addresses used to access CGRAM is shown below.

CGRAM address	D4	D3	D2	D1	D0	CGROM address
00H						00H
01H						
02H						
03H						
04H						
05H						
06H						
07H						
08H						00H
09H						
0AH						
0BH						
0CH						
0DH						
0EH						
0FH						
10H						01H
11H						
12H						
13H						
14H						
15H						
16H						
17H						
18H						02H
19H						
1AH						
1BH						
1CH						
1DH						
1EH						
1FH						

CGRAM address	D4	D3	D2	D1	D0	CGROM address
20H						04H
21H						
22H						
23H						
24H						
25H						
26H						
27H						
28H						05H
29H						
2AH						
2BH						
2CH						
2DH						
2EH						
2FH						
30H						06H
31H						
32H						
33H						
34H						
35H						
36H						
37H						
38H						07H
39H						
3AH						
3BH						
3CH						
3DH						
3EH						
3FH						

Caution Some addresses in 06H and all 07H address in CGROM are shared with pictograph data RAM.

6.2.1 Pictograph Display RAM (PDRAM)

Pictograph display RAM addresses used to some parts of CGRAM is shown below.

CGRAM address	D5	D4	D3	D2	D1	CGROM address
30H	45	44	43	42	41	06H
31H	50	49	48	47	46	
32H	55	54	53	52	51	
33H	60	59	58	57	56	
34H						
35H						
36H						
37H						
38H	5	4	3	2	1	07H
39H	10	9	8	7	6	
3AH	15	14	13	12	11	
3BH	20	19	18	17	16	
3CH	25	24	23	22	21	
3DH	30	29	28	27	26	
3EH	35	34	33	32	31	
3FH	40	39	38	37	36	

7. COMMANDS

7.1 Basic format

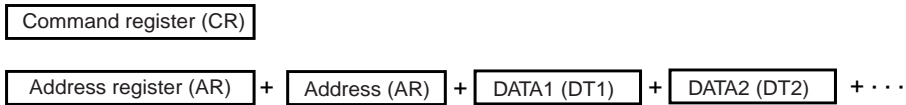

7.2 Command register

The command register's basic configuration is as follows.

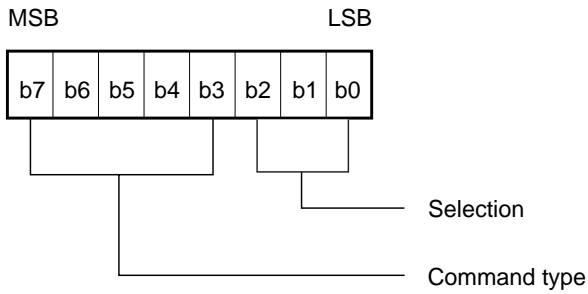

7.2.1 Reset

This command resets all of the commands in the μPD16670.

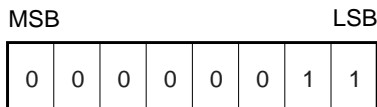

7.2.2 Display ON/OFF

This command controls the display's ON/OFF status.

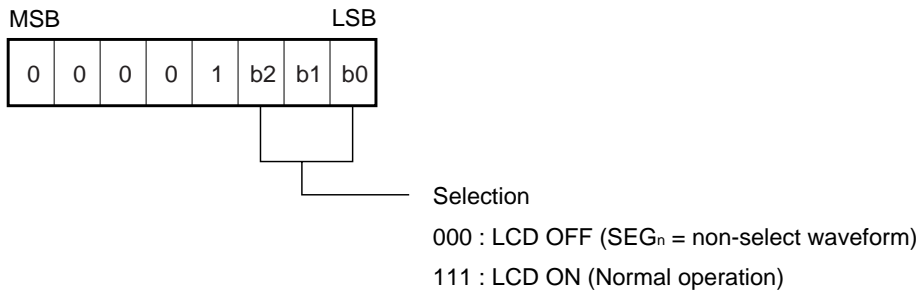

7.2.3 Standby

This command stops the DC/DC converter, which reduces the supply current. The display is set to OFF mode (SEG_n, COM_n = V_{LC5}).

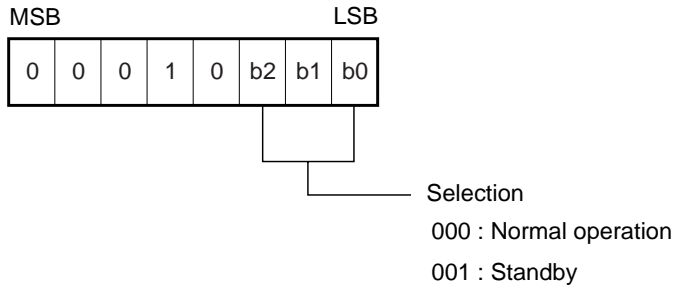

7.2.4 Duty setting

This command specifies the duty setting.

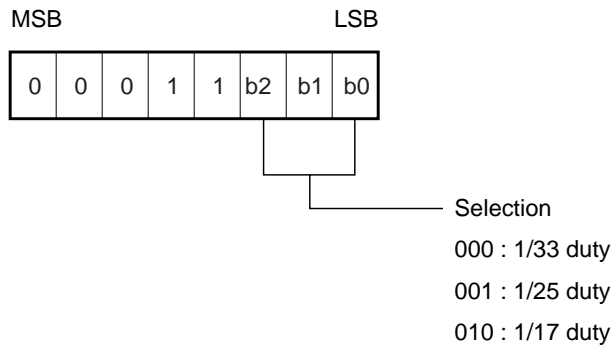

7.2.5 Test mode

This command sets the test mode. The test mode is only for confirming the IC's operation. Regular or continuous use while in test mode is not guaranteed.

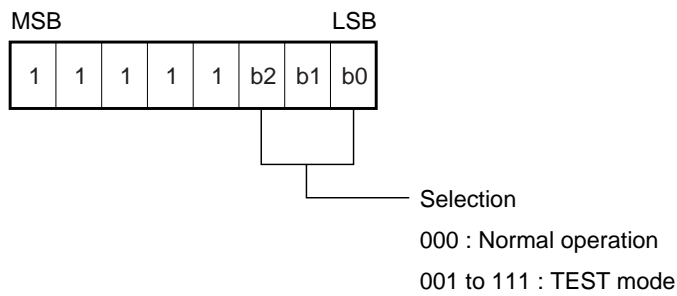

7.3 Address Register

This command selects the address type and specifies addresses.

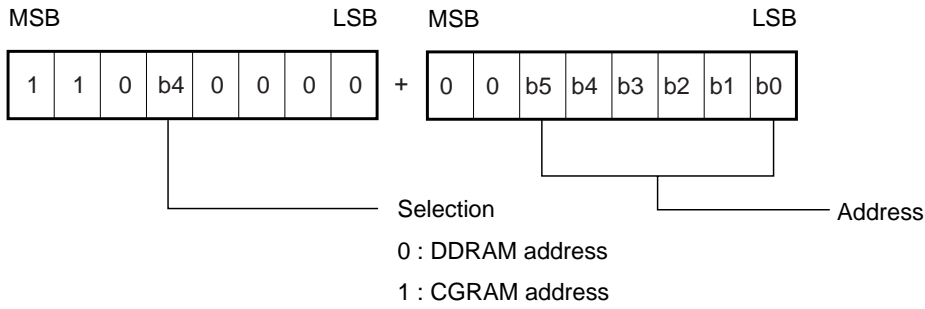

Caution Operation is not guaranteed if an invalid address is set.

★ **7.4 Reset**

The contents of the various registers appear as shown below after a reset (command reset or hardware [pin] reset).

Command	Register Contents								Description
	b7	b6	b5	b4	b3	b2	b1	b0	
Display ON/OFF	0	0	0	0	1	0	0	0	LCD OFF
Standby	0	0	0	1	0	0	0	0	Normal operation
Duty setting	0	0	0	1	1	0	1	0	1/33 duty
Test mode	1	1	1	1	1	0	0	0	Normal operation

7.5 Serial communication format

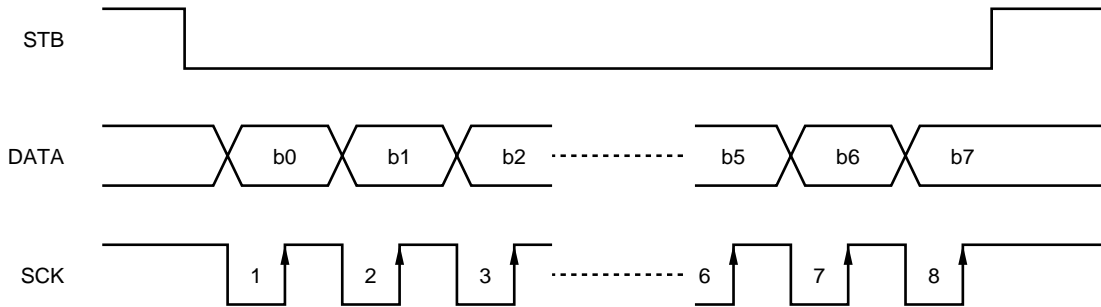

8. CPU ACCESS EXAMPLES

Examples of access procedure are shown below.

8.1 Initialize and Data Write

Parameter	STB	Command/data								Description
		b7	B6	b5	b4	b3	b2	b1	b0	
Start	H	X	X	X	X	X	X	X	X	
Reset	L	0	0	0	0	0	1	1	1	All commands initialized
	H	X	X	X	X	X	X	X	X	
Duty setting	L	0	0	0	1	1	0	0	1	12 columns by 3 rows + 60 pictographs (1/25 duty)
	H	X	X	X	X	X	X	X	X	
Address register 1	L	1	1	0	1	0	0	0	0	CGRAM
Address register 2	L	0	0	0	0	0	0	0	0	CGRAM address = 00H
Data 1 to CGRAM data48	L : L	X : X	X : X	X : X	D4 : D4	D3 : D3	D2 : D2	D1 : D1	D0 : D0	CGRAM data
	H	X	X	X	X	X	X	X	X	
Address register 1	L	1	1	0	1	0	0	0	0	Pictograph data RAM
Address register 2	L	0	0	1	1	0	0	0	0	Pictograph data RAM address = 30H
Pictograph data 1 to Pictograph data 4	L : L	X : X	X : X	D5 : D5	D4 : D4	D3 : D3	D2 : D2	D1 : D1	X : X	Pictograph data
	H	X	X	X	X	X	X	X	X	
Address register 1	L	1	1	0	1	0	0	0	0	Pictograph data RAM
Address register 2	L	0	0	1	1	0	0	0	0	Pictograph data RAM address = 38H
Pictograph data 5 to Pictograph data 12	L : L	X : X	X : X	X : X	D4 : D4	D3 : D3	D2 : D2	D1 : D1	D0 : D0	Pictograph data
	H	X	X	X	X	X	X	X	X	
Address register 1	L	1	1	0	1	0	0	0	0	Display data RAM
Address register 2	L	0	0	0	0	0	0	0	0	Display data RAM address = 00H
Character data 1 to Character data 36	L : L	D : D	D : D	D : D	D : D	D : D	D : D	D : D	D : D	Display data
	H	X	X	X	X	X	X	X	X	
Display ON/OFF	L	0	0	0	0	1	1	1	1	LCD ON (at the STB rising edge)
End	H	X	X	X	X	X	X	X	X	

★ **Remark** X = Don't care, D = Data

8.2 Initialize and Data Write (unused pictograph)

Parameter	STB	Command/data								Description
		b7	b6	b5	b4	b3	b2	b1	b0	
Start	H	X	X	X	X	X	X	X	X	
Reset	L	0	0	0	0	0	1	1	1	All commands initialized
	H	X	X	X	X	X	X	X	X	
Duty setting	L	0	0	0	1	1	0	0	1	12 columns by 3 rows + 60 pictographs (1/25 duty)
	H	X	X	X	X	X	X	X	X	
Address register 1	L	1	1	0	1	0	0	0	0	CGRAM
Address register 2	L	0	0	0	0	0	0	0	0	CGRAM address = 00H
CGRAM data1 to CGRAM data 64	L : L	X : X	X : X	X : X	D4 : D4	D3 : D3	D2 : D2	D1 : D1	D0 : D0	CGRAM data
	H	X	X	X	X	X	X	X	X	
Address register 1	L	1	1	0	0	0	0	0	0	Display data RAM
Address register 2	L	0	0	0	0	0	0	0	0	Display data RAM address = 00H
Character data 1 to Character data 36	L : L	D : D	D : D	D : D	D : D	D : D	D : D	D : D	D : D	Display data
	H	X	X	X	X	X	X	X	X	
Display ON/OFF	L	0	0	0	0	1	1	1	1	LCD ON (at the STB rising edge)
End	H	X	X	X	X	X	X	X	X	

★ Remark X = Don't care, D = Data

8.3 Change display data

Parameter	STB	Command/data								Description
		b7	b6	b5	b4	b3	b2	b1	b0	
Start	H	X	X	X	X	X	X	X	X	
Address register 1	L	1	1	0	0	0	0	0	0	Display data RAM
Address register 2	L	0	0	0	1	0	0	0	1	Display RAM address = 11H (2 lines 2 clumns)
Character data 1	L	0	0	1	0	0	0	0	0	Display RAM address = 11H, Data write: character code (20H: space)
Character data 2	L	0	1	0	0	1	1	1	0	Display RAM address = 12H, Data write: character code (4EH: "N")
Character data 3	L	0	1	0	0	0	1	0	1	Display RAM address = 13H, Data write: character code (45H: "E")
Character data 4	L	0	1	0	0	0	0	1	1	Display RAM address = 14H, Data write: character code (43H: "C")
Character data 5	L	0	0	1	0	0	0	0	0	Display RAM address = 15H, Data write: character code (20H: space)
End	H	X	X	X	X	X	X	X	X	

★ Remark X = Don't Care

8.4 Standby mode

Parameter	STB	Command/data								Description
		b7	b6	b5	b4	b3	b2	b1	b0	
Start	H	X	X	X	X	X	X	X	X	
Standby	L	0	0	0	1	0	0	0	1	Standby
	H	X	X	X	X	X	X	X	X	
Standby off	L	0	0	0	1	0	0	0	0	Normal operation ^{Note}
End	H	X	X	X	X	X	X	X	X	

Note When in standby mode, DC/DC converter is stop.

If the display operation mode is set before entering the standby mode, it may not be normally working until DC/DC converter, which set after cleaning the standby mode.

★ Remark X = Don't Care

9. ELECTRICAL SPECIFICATIONS

Absolute Maximum Ratings (T_A = 25°C, V_{SS} = 0 V)

Parameter	Symbol	Rating	Unit
Logic power supply voltage	V _{DD}	-0.3 to +7.0	V
Logic input voltage	V _{IN}	-0.3 to V _{DD} +0.3	V
Driver supply voltage	V _{LCD}	-0.3 to +16.0	V
Driver reference supply input voltage	V _{LC1} -V _{LC5}	-0.3 to V _{LCD} +0.3	V
Logic system output voltage (SEG _n , COM _n)	V _{OUT}	-0.3 to V _{DD} +0.3	V
Operating ambient temperature	T _A	-40 to +85	°C
Storage temperature	T _{stg}	-55 to +150	°C

★ **Caution** Product quality may suffer if the absolute maximum rating is exceeded even momentarily for any parameter. That is, the absolute maximum ratings are rated values at which the product is on the verge of suffering physical damage, and therefore the product must be used under conditions that ensure that the absolute maximum ratings are not exceeded.

Recommended Operating Range (T_A = 25°C, V_{SS} = 0 V)

Parameter	Symbol	MIN.	TYP.	MAX.	Unit
Logic power supply voltage	V _{DD}	2.7	3.0	3.6	V
Logic system input voltage	V _{IN}	0		V _{DD}	V
Driver supply voltage	V _{LCD}	2.7		14.4	V
Logic system input voltage	V _{LC1} -V _{LC5}	0		V _{LCD}	V
Output capacitance	C ₁ -C ₃	0.05	0.1	1.0	μF
	C ₄	0.05	0.1	1.0	μF
Oscillation frequency	f _{osc}	245	350	455	kHz

Electrical characteristics (Unless otherwise specified, T_A = -40 to +85°C, V_{SS} = 0 V, V_{DD} = 2.7 to 3.6 V)

Parameter	Symbol	Condition	MIN.	TYP.	MAX.	Unit
High-level input voltage 1	V _{IH1}	SCK,STB,DATA,/RESET,/LCDOFF	0.8 V _{DD}		V _{DD}	V
Low-level input voltage 1	V _{IL1}	SCK,STB,DATA,/RESET,/LCDOFF	0		0.2 V _{DD}	V
High-level input voltage 2	V _{IH2}	TEST,OSC _{IN}	0.7 V _{DD}		V _{DD}	V
Low-level input voltage 2	V _{IL2}	TEST,OSC _{IN}	0		0.3 V _{DD}	V
High-level input current	I _{IH}	SCK,STB,DATA,/RESET,/LCDOFF, OSC _{IN}			1	μA
		TEST	3	15	75	μA
Low-level input current	I _{IL}	SCK,STB,DATA,TEST,OSC _{IN}			-1	μA
		/RESET,/LCDOFF	-3	-15	-75	μA
High-level output voltage	V _{OH}	TDATA,I _{OH} = -100 μA	0.8 V _{DD}		V _{DD}	V
Low-level output voltage	V _{OL}	TDATA,I _{OL} = 100 μA	V _{SS}		0.2 V _{DD}	V
Common output ON resistance	R _{COM}	COM ₁ to COM ₃₃ , I _{ol} = 50 μA			15	kΩ
Segment output ON resistance	R _{SEG}	SEG ₁ to SEG ₆₀ , I _{ol} = 50 μA			30	kΩ
Current consumption (Normal mode)	I _{DD1}	V _{DD} = 3 V, f _{OSC} = 350 kHz, 4-fold voltage mode, no load		200	300	μA
Current consumption (Standby mode)	I _{DD2}	V _{DD} = 3 V, no load			100	μA
Driver voltage (boost voltage)	V _{LCD}	No load	3.5 V _{DD}		4.0 V _{DD}	V

Switching characteristics (Unless otherwise specified, $T_A = -40$ to $+85^\circ\text{C}$, $V_{SS} = 0\text{ V}$, $V_{DD} = 2.7$ to 3.6 V)

Parameter	Symbol	Conditions	MIN.	TYP.	MAX.	Unit
Oscillation frequency	f_{osc}	Self-oscillation, $V_{DD} = 3\text{ V} \pm 10\%$, $R = 100\text{ k}\Omega$	245	350	455	kHz

Required timing conditions (Unless otherwise specified, $T_A = -40$ to $+85^\circ\text{C}$, $V_{SS} = 0\text{ V}$, $V_{DD} = 2.7$ to 3.6 V)

Parameter	Symbol	Conditions	MIN.	TYP.	MAX.	Unit
Clock frequency	f_{osc}	OSC _{IN} external clock	245	350	455	kHz
High-level clock pulse width	t_{WHC}	OSC _{IN} external clock	$0.4 f_{osc}$		$0.6 f_{osc}$	–
Low-level clock pulse width	t_{WLC}	OSC _{IN} external clock	$0.4 f_{osc}$		$0.6 f_{osc}$	–
Shift clock cycle	t_{CYK}	SCK	1.2			ns
High-level shift clock pulse width	t_{WHK}	SCK	350			ns
Low-level shift clock pulse width	t_{WLK}	SCK	350			ns
Shift clock hold time	t_{HSTBK}	STB ↓ → SCK ↓	350			ns
★ Data setup time	t_{DS}	DATA ↑↓ → SCK ↑	100			ns
★ Data hold time	t_{DH}	SCK ↑ → DATA ↑↓	450			ns
STB hold time	t_{HKSTB}	SCK ↑ → STB ↑	350			ns
STB pulse width	t_{WSTB}		350			ns

Switching characteristic waveform

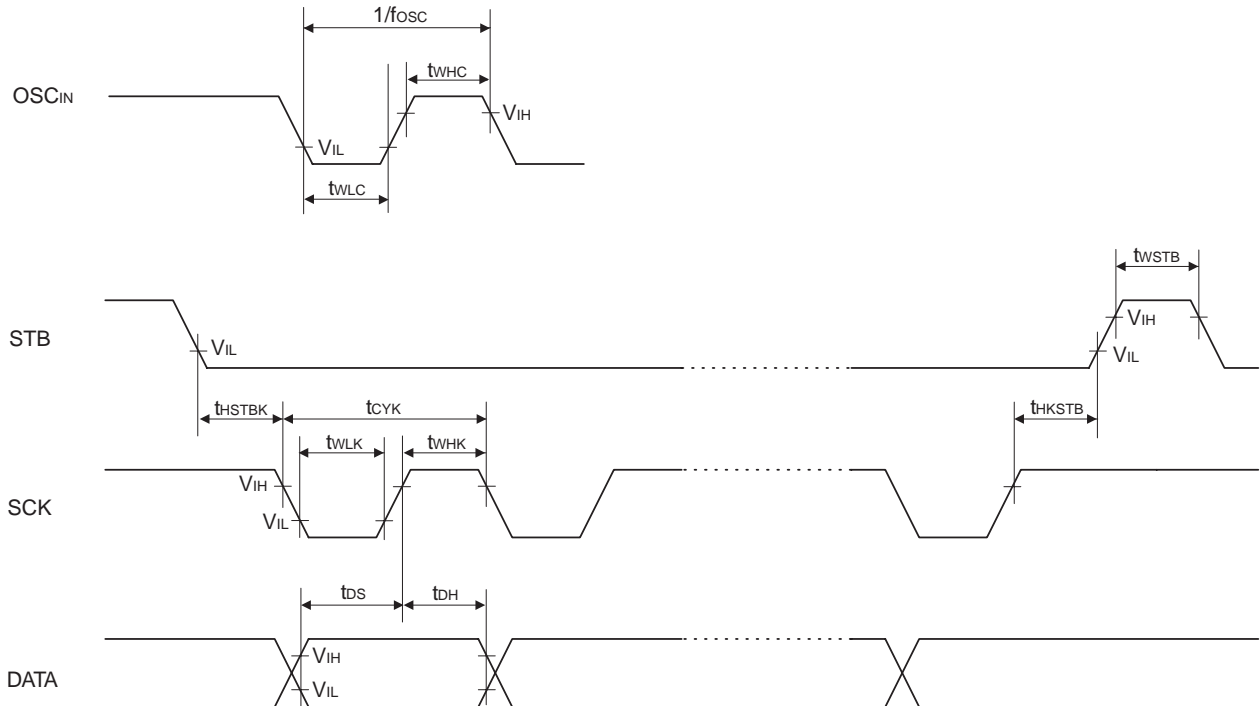

NOTES FOR CMOS DEVICES

① PRECAUTION AGAINST ESD FOR SEMICONDUCTORS

Note:

Strong electric field, when exposed to a MOS device, can cause destruction of the gate oxide and ultimately degrade the device operation. Steps must be taken to stop generation of static electricity as much as possible, and quickly dissipate it once, when it has occurred. Environmental control must be adequate. When it is dry, humidifier should be used. It is recommended to avoid using insulators that easily build static electricity. Semiconductor devices must be stored and transported in an anti-static container, static shielding bag or conductive material. All test and measurement tools including work bench and floor should be grounded. The operator should be grounded using wrist strap. Semiconductor devices must not be touched with bare hands. Similar precautions need to be taken for PW boards with semiconductor devices on it.

② HANDLING OF UNUSED INPUT PINS FOR CMOS

Note:

No connection for CMOS device inputs can be cause of malfunction. If no connection is provided to the input pins, it is possible that an internal input level may be generated due to noise, etc., hence causing malfunction. CMOS devices behave differently than Bipolar or NMOS devices. Input levels of CMOS devices must be fixed high or low by using a pull-up or pull-down circuitry. Each unused pin should be connected to V_{DD} or GND with a resistor, if it is considered to have a possibility of being an output pin. All handling related to the unused pins must be judged device by device and related specifications governing the devices.

③ STATUS BEFORE INITIALIZATION OF MOS DEVICES

Note:

Power-on does not necessarily define initial status of MOS device. Production process of MOS does not define the initial operation status of the device. Immediately after the power source is turned ON, the devices with reset function have not yet been initialized. Hence, power-on does not guarantee out-pin levels, I/O settings or contents of registers. Device is not initialized until the reset signal is received. Reset operation must be executed immediately after power-on for devices having reset function.

★ Reference Documents

NEC Semiconductor Device Reliability/Quality Control System (C10983E)

Semiconductor Device Mounting Technology (C10535E)

- **The information in this document is current as of September, 2000. The information is subject to change without notice. For actual design-in, refer to the latest publications of NEC's data sheets or data books, etc., for the most up-to-date specifications of NEC semiconductor products. Not all products and/or types are available in every country. Please check with an NEC sales representative for availability and additional information.**
 - No part of this document may be copied or reproduced in any form or by any means without prior written consent of NEC. NEC assumes no responsibility for any errors that may appear in this document.
 - NEC does not assume any liability for infringement of patents, copyrights or other intellectual property rights of third parties by or arising from the use of NEC semiconductor products listed in this document or any other liability arising from the use of such products. No license, express, implied or otherwise, is granted under any patents, copyrights or other intellectual property rights of NEC or others.
 - Descriptions of circuits, software and other related information in this document are provided for illustrative purposes in semiconductor product operation and application examples. The incorporation of these circuits, software and information in the design of customer's equipment shall be done under the full responsibility of customer. NEC assumes no responsibility for any losses incurred by customers or third parties arising from the use of these circuits, software and information.
 - While NEC endeavours to enhance the quality, reliability and safety of NEC semiconductor products, customers agree and acknowledge that the possibility of defects thereof cannot be eliminated entirely. To minimize risks of damage to property or injury (including death) to persons arising from defects in NEC semiconductor products, customers must incorporate sufficient safety measures in their design, such as redundancy, fire-containment, and anti-failure features.
 - NEC semiconductor products are classified into the following three quality grades:
"Standard", "Special" and "Specific". The "Specific" quality grade applies only to semiconductor products developed based on a customer-designated "quality assurance program" for a specific application. The recommended applications of a semiconductor product depend on its quality grade, as indicated below. Customers must check the quality grade of each semiconductor product before using it in a particular application.
"Standard": Computers, office equipment, communications equipment, test and measurement equipment, audio and visual equipment, home electronic appliances, machine tools, personal electronic equipment and industrial robots
"Special": Transportation equipment (automobiles, trains, ships, etc.), traffic control systems, anti-disaster systems, anti-crime systems, safety equipment and medical equipment (not specifically designed for life support)
"Specific": Aircraft, aerospace equipment, submersible repeaters, nuclear reactor control systems, life support systems and medical equipment for life support, etc.
- The quality grade of NEC semiconductor products is "Standard" unless otherwise expressly specified in NEC's data sheets or data books, etc. If customers wish to use NEC semiconductor products in applications not intended by NEC, they must contact an NEC sales representative in advance to determine NEC's willingness to support a given application.
- (Note)
- (1) "NEC" as used in this statement means NEC Corporation and also includes its majority-owned subsidiaries.
 - (2) "NEC semiconductor products" means any semiconductor product developed or manufactured by or for NEC (as defined above).