

To our customers,

Old Company Name in Catalogs and Other Documents

On April 1st, 2010, NEC Electronics Corporation merged with Renesas Technology Corporation, and Renesas Electronics Corporation took over all the business of both companies. Therefore, although the old company name remains in this document, it is a valid Renesas Electronics document. We appreciate your understanding.

Renesas Electronics website: <http://www.renesas.com>

April 1st, 2010
Renesas Electronics Corporation

Issued by: Renesas Electronics Corporation (<http://www.renesas.com>)

Send any inquiries to <http://www.renesas.com/inquiry>.

Notice

1. All information included in this document is current as of the date this document is issued. Such information, however, is subject to change without any prior notice. Before purchasing or using any Renesas Electronics products listed herein, please confirm the latest product information with a Renesas Electronics sales office. Also, please pay regular and careful attention to additional and different information to be disclosed by Renesas Electronics such as that disclosed through our website.
2. Renesas Electronics does not assume any liability for infringement of patents, copyrights, or other intellectual property rights of third parties by or arising from the use of Renesas Electronics products or technical information described in this document. No license, express, implied or otherwise, is granted hereby under any patents, copyrights or other intellectual property rights of Renesas Electronics or others.
3. You should not alter, modify, copy, or otherwise misappropriate any Renesas Electronics product, whether in whole or in part.
4. Descriptions of circuits, software and other related information in this document are provided only to illustrate the operation of semiconductor products and application examples. You are fully responsible for the incorporation of these circuits, software, and information in the design of your equipment. Renesas Electronics assumes no responsibility for any losses incurred by you or third parties arising from the use of these circuits, software, or information.
5. When exporting the products or technology described in this document, you should comply with the applicable export control laws and regulations and follow the procedures required by such laws and regulations. You should not use Renesas Electronics products or the technology described in this document for any purpose relating to military applications or use by the military, including but not limited to the development of weapons of mass destruction. Renesas Electronics products and technology may not be used for or incorporated into any products or systems whose manufacture, use, or sale is prohibited under any applicable domestic or foreign laws or regulations.
6. Renesas Electronics has used reasonable care in preparing the information included in this document, but Renesas Electronics does not warrant that such information is error free. Renesas Electronics assumes no liability whatsoever for any damages incurred by you resulting from errors in or omissions from the information included herein.
7. Renesas Electronics products are classified according to the following three quality grades: “Standard”, “High Quality”, and “Specific”. The recommended applications for each Renesas Electronics product depends on the product’s quality grade, as indicated below. You must check the quality grade of each Renesas Electronics product before using it in a particular application. You may not use any Renesas Electronics product for any application categorized as “Specific” without the prior written consent of Renesas Electronics. Further, you may not use any Renesas Electronics product for any application for which it is not intended without the prior written consent of Renesas Electronics. Renesas Electronics shall not be in any way liable for any damages or losses incurred by you or third parties arising from the use of any Renesas Electronics product for an application categorized as “Specific” or for which the product is not intended where you have failed to obtain the prior written consent of Renesas Electronics. The quality grade of each Renesas Electronics product is “Standard” unless otherwise expressly specified in a Renesas Electronics data sheets or data books, etc.
 - “Standard”: Computers; office equipment; communications equipment; test and measurement equipment; audio and visual equipment; home electronic appliances; machine tools; personal electronic equipment; and industrial robots.
 - “High Quality”: Transportation equipment (automobiles, trains, ships, etc.); traffic control systems; anti-disaster systems; anti-crime systems; safety equipment; and medical equipment not specifically designed for life support.
 - “Specific”: Aircraft; aerospace equipment; submersible repeaters; nuclear reactor control systems; medical equipment or systems for life support (e.g. artificial life support devices or systems), surgical implantations, or healthcare intervention (e.g. excision, etc.), and any other applications or purposes that pose a direct threat to human life.
8. You should use the Renesas Electronics products described in this document within the range specified by Renesas Electronics, especially with respect to the maximum rating, operating supply voltage range, movement power voltage range, heat radiation characteristics, installation and other product characteristics. Renesas Electronics shall have no liability for malfunctions or damages arising out of the use of Renesas Electronics products beyond such specified ranges.
9. Although Renesas Electronics endeavors to improve the quality and reliability of its products, semiconductor products have specific characteristics such as the occurrence of failure at a certain rate and malfunctions under certain use conditions. Further, Renesas Electronics products are not subject to radiation resistance design. Please be sure to implement safety measures to guard them against the possibility of physical injury, and injury or damage caused by fire in the event of the failure of a Renesas Electronics product, such as safety design for hardware and software including but not limited to redundancy, fire control and malfunction prevention, appropriate treatment for aging degradation or any other appropriate measures. Because the evaluation of microcomputer software alone is very difficult, please evaluate the safety of the final products or system manufactured by you.
10. Please contact a Renesas Electronics sales office for details as to environmental matters such as the environmental compatibility of each Renesas Electronics product. Please use Renesas Electronics products in compliance with all applicable laws and regulations that regulate the inclusion or use of controlled substances, including without limitation, the EU RoHS Directive. Renesas Electronics assumes no liability for damages or losses occurring as a result of your noncompliance with applicable laws and regulations.
11. This document may not be reproduced or duplicated, in any form, in whole or in part, without prior written consent of Renesas Electronics.
12. Please contact a Renesas Electronics sales office if you have any questions regarding the information contained in this document or Renesas Electronics products, or if you have any other inquiries.

(Note 1) “Renesas Electronics” as used in this document means Renesas Electronics Corporation and also includes its majority-owned subsidiaries.

(Note 2) “Renesas Electronics product(s)” means any product developed or manufactured by or for Renesas Electronics.

DOT CHARACTER VFD CONTROLLER/DRIVER
DESCRIPTION

The μ PD16314 is a VFD controller/driver capable of displaying a dot matrix VFD. It has 80 anode outputs and 24 grid outputs. A single μ PD16314 can display up to 16C x 2L, 20C x 2L, or 24C x 2L. The μ PD16314 has character generator ROM in which 248 x 5 x 8 dot characters are stored.

FEATURES

- Dot matrix VFD controller/driver
- Capable of driving anodes for cursor display (48 units)
- 80 x 8 bits display RAM incorporated
- Capable of alphanumeric and symbolic display through internal ROM (5 by 8 dots)
240 characters plus 8 user-defined characters
- Display contents
16 columns by 2(1) rows + 32(16) cursors, 20 columns by 2(1) rows + 40(20) cursors,
or 24 columns by 2(1) rows + 48(24) cursors.
- Parallel data input/output (switchable between 4 bits and 8 bits) or serial data input/output can be selected.
- On-chip oscillator
- Custom ROM supported

ORDERING INFORMATION

Part Number	Package
μ PD16314GJ-001-8EU	144-PIN PLASTIC LQFP(FINE PITCH)(20x20), Standard ROM (ROM code: 001)
μ PD16314GJ-002-8EU	144-PIN PLASTIC LQFP(FINE PITCH)(20x20), Standard ROM (ROM code: 002)

The information in this document is subject to change without notice. Before using this document, please confirm that this is the latest version.
 Not all devices/types available in every country. Please check with local NEC representative for availability and additional information.

Phase-out/Discontinued

1. BLOCK DIAGRAM

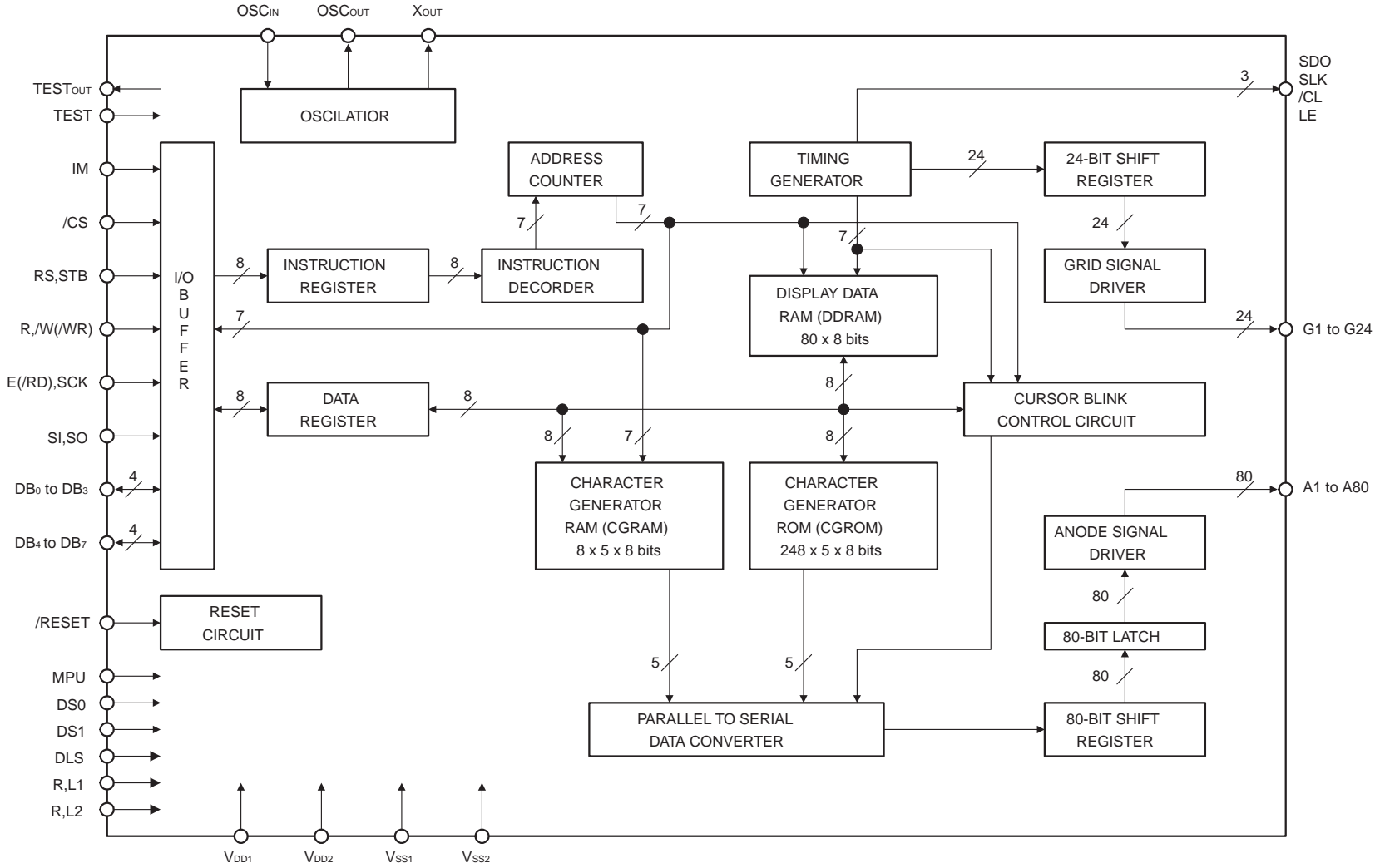

Remark /xxx indicates active low signals.

2. PIN CONFIGURATION (Top View)

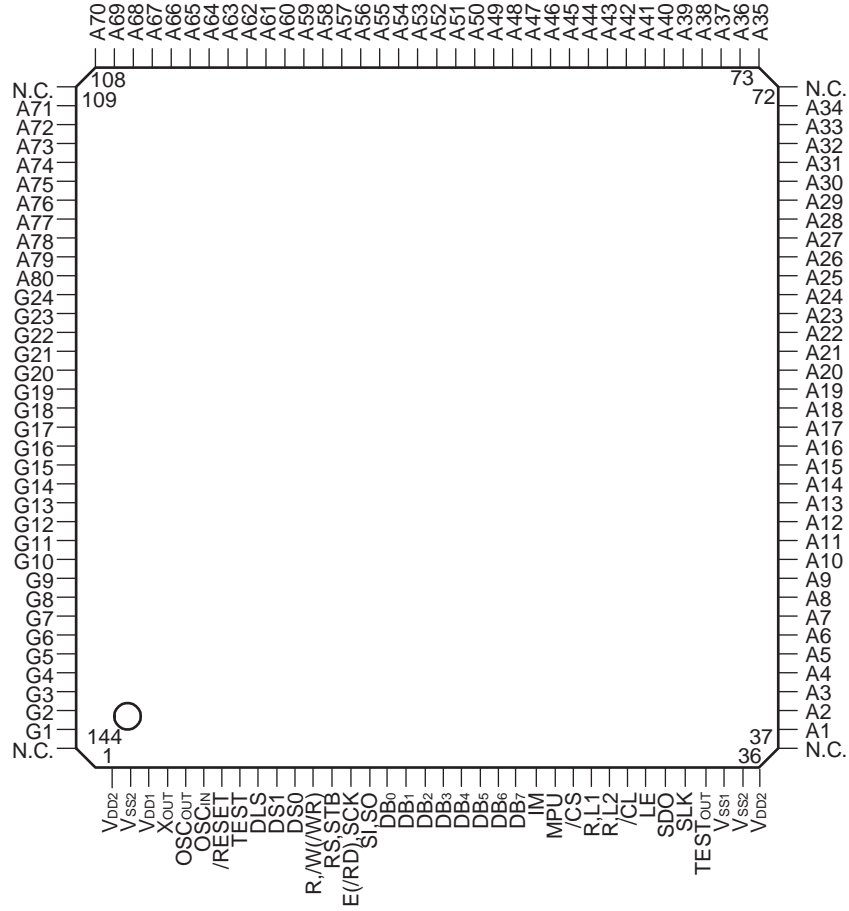

Remark Use all power supply pins. Leave N.C. pins open.

3. PIN FUNCTIONS

3.1 Power System

Pin Symbol	Pin Name	Pin No.	I/O	Output	Description
V _{DD1}	Logic power supply pin	3	—	—	Power supply for logic
V _{SS1}	Logic ground pin	34	—	—	Ground pin for logic
V _{DD2}	VFD driving power supply pin	1,36	—	—	Power supply for VFD driving circuit
V _{SS2}	VFD driving ground pin	2,35	—	—	Ground pin for VFD driving

3.2 Logic system (Microprocessor Interface)

Pin Symbol	Pin Name	Pin No.	I/O	Output	Description
RS,STB	Register select/strobe	13	I	—	When Parallel data transfer is selected, this pin is Register select. L: Select instruction register(IR). H: Select data register(DR). When serial data transfer mode is selected, this pin is the strobe input. Data can be input when this signal goes L. Command processing is performed at the rising edge of this signal.
/CS	Chip select	26	I	—	When this pin is L, this device is active.
E(/RD), SCK	Enable(read)/shift clock	14	I	—	When M68 parallel data transfer mode is selected (E), this pin is enabled. Data is written at the falling edge. When i80 parallel data transfer selected (/RD), this pin is a read-enable pin. When this pin is L, data is output to the data bus. When serial data transfer is selected, this pin is the shift clock input. Data is written at the rising edge.
R,/W(WR)	Read/write signal (write)	12	I	—	When M68 parallel data transfer mode is selected (R,/W), this pin is the data transfer select pin. L: Write H: Read When i80 parallel data transfer mode is selected (/WR), this pin is written a write-enable pin. Data is written at rising edge of this signal. When serial data transfer mode is selected this pin is fixed to H or L.
SI,SO	Serial I/O	15	I/O	CMOS-3-states	When serial data transfer mode is selected, this pin is used as an I/O pin. When parallel data transfer mode is selected, this pin is fixed to H or L. DB ₀ to DB ₇
DB ₀ - DB ₇	Parallel data I/O	16 to 23	I/O	CMOS-3-states	When parallel data transfer mode is selected, these pins are used as I/O pins. When 4-bits transfer mode is selected, DB ₄ to DB ₇ are used. Data is transferred starting from the most significant bit (MSB) and stored sequentially.
/RESET	Reset	7	I	—	L: Initializes all the internal registers and commands. Anode and grid outputs are fixed to V _{SS2} .

3.3 Logic System (Other Logic)

Pin Symbol	Pin Name	Pin No.	I/O	Output	Description
OSC _{IN}	Oscillator pin	6	—	—	The resistor for determining the oscillation frequency is externally attached to this pin.
OSC _{OUT}		5			
X _{OUT}	Oscillator output	4		CMOS	Oscillator signal output pin.
DS0	Duty selector	11	I	—	Sets the duty ratio. The duty ratio is determined by the number of grids. The relationship between the duty ratio and these pins is shown in 4 DUTY RATIO SETTING .
DS1		10			
IM	Interface select	24	I	—	Selects the interface mode: Serial transfer or parallel transfer. L: Selects serial data transfer H: Selects parallel data transfer (In Parallel data transfer mode, the word length differs depending on the instruction.)
MPU	Interface select	25	I	—	Selects the interface mode: i80-type CPU mode or M68-type CPU mode. L: Selects i80-type CPU mode. H: Selects M68-type CPU mode.
DLS	Display line select	9	I		Selects the number of display lines at power ON reset or reset. L: Selects 1 line (N ^{Note} = 0) H: Selects 2 lines (N ^{Note} = 1)
R,L1	Anode output select	27	I	—	Sets the anode outputs. The Ox pins are set by these pins. The relationship between Ox and Ax (anode) is shown in 5 ANODE SETTING .
R,L2		28			
TEST	Test pin	8	I	—	A pin for testing the IC. L or open: Normal operation mode H: Test mode
TEST _{OUT}	Test pin	33	O	—	A pin for testing the IC. Leave this pin open.

Note N: Display line selection flag for function setting command.

3.4 Logic System (External Extension Driver)

Pin Symbol	Pin Name	Pin No.	I/O	Output	Description
SDO	Serial data output	31	O	CMOS	Serial data output for extension grid driver.
SLK	Serial clock output	32	O	CMOS	Shift clock pulse for extension grid driver.
/CL	Clear signal	29	O	CMOS	Clear signal for extension grid driver. The signal is active low. The grid data stored in the latch of the extension driver is output when this signal is H. If this signal is L, the extension driver outputs L.
LE	Latch enable	30	O	CMOS	Latch enable signal for extension grid driver.

3.5 Output Pins

Pin Symbol	Pin Name	Pin No.	I/O	Output	Description
G1 - G24	Grid output	Note	O	CMOS	Grid signal output pins.
A1 - A80 (O1 - O80)	Anode output	Note	O	CMOS	Anode signal output pins.

Note Refer to **4 DUTY RATIO SETTING**.

4. DUTY RATIO SETTING

The duty ratio of the μ PD16314 is set by DS0 and DS1 as shown in Table 4–1 below.

Table 4–1. Duty Ratio Setting

DS0	DS1	Duty ratio
L	L	1/16 (# of grids = 16)
L	H	1/20 (# of grids = 20)
H	L	1/24 (# of grids = 24)
H	H	1/40 (# of grids = 40) ^{Note}

Note When to set to 1/40 duty mode, the external extension grid driver can be used.

5. ANODE SETTING

The anode pins are set by R,L1 and R,L2 as shown in Table 5–1 below.

Table 5–1. Anode Setting: 2 Line Display (N=1)

R,L1	R,L2	Table No.
L	L	Table 5–2
L	H	Table 5–3
H	L	Table 5–3
H	H	Table 5–4

Table 5-2. Anode Pin Layout (When R,L1 = L, R,L2 = L)

No.	Name	No.	Name	No.	Name	No.	Name
1	V _{DD2}	37	N.C.	73	A35	109	N.C.
2	V _{SS2}	38	A1	74	A36	110	A71
3	V _{DD1}	39	A2	75	A37	111	A72
4	X _{OUT}	40	A3	76	A38	112	A73
5	OSC _{OUT}	41	A4	77	A39	113	A74
6	OSC _{IN}	42	A5	78	A40	114	A75
7	/RESET	43	A6	79	A41	115	A76
8	TEST	44	A7	80	A42	116	A77
9	DLS	45	A8	81	A43	117	A78
10	DS1	46	A9	82	A44	118	A79
11	DS0	47	A10	83	A45	119	A80
12	R,W(/WR)	48	A11	84	A46	120	G24
13	RS,STB	49	A12	85	A47	121	G23
14	E(/RD),SCK	50	A13	86	A48	122	G22
15	SI,SO	51	A14	87	A49	123	G21
16	DB ₀	52	A15	88	A50	124	G20
17	DB ₁	53	A16	89	A51	125	G19
18	DB ₂	54	A17	90	A52	126	G18
19	DB ₃	55	A18	91	A53	127	G17
20	DB ₄	56	A19	92	A54	128	G16
21	DB ₅	57	A20	93	A55	129	G15
22	DB ₆	58	A21	94	A56	130	G14
23	DB ₇	59	A22	95	A57	131	G13
24	IM	60	A23	96	A58	132	G12
25	MPU	61	A24	97	A59	133	G11
26	/CS	62	A25	98	A60	134	G10
27	R,L1	63	A26	99	A61	135	G9
28	R,L2	64	A27	100	A62	136	G8
29	/CL	65	A28	101	A63	137	G7
30	LE	66	A29	102	A64	138	G6
31	SDO	67	A30	103	A65	139	G5
32	SLK	68	A31	104	A66	140	G4
33	TEST _{OUT}	69	A32	105	A67	141	G3
34	V _{SS1}	70	A33	106	A68	142	G2
35	V _{SS2}	71	A34	107	A69	143	G1
36	V _{DD2}	72	N.C.	108	A70	144	N.C.

Table 5-3. Anode Pin Layout (When R,L1 = L, R,L2 = H)

No.	Name	No.	Name	No.	Name	No.	Name
1	V _{DD2}	37	N.C.	73	A6	109	N.C.
2	V _{SS2}	38	A40	74	A5	110	A71
3	V _{DD1}	39	A39	75	A4	111	A72
4	X _{OUT}	40	A38	76	A3	112	A73
5	OSC _{OUT}	41	A37	77	A2	113	A74
6	OSC _{IN}	42	A36	78	A1	114	A75
7	/RESET	43	A35	79	A41	115	A76
8	TEST	44	A34	80	A42	116	A77
9	DLS	45	A33	81	A43	117	A78
10	DS ₁	46	A32	82	A44	118	A79
11	DS ₀	47	A31	83	A45	119	A80
12	R,W(/WR)	48	A30	84	A46	120	G24
13	RS,STB	49	A29	85	A47	121	G23
14	E(/RD),SCK	50	A28	86	A48	122	G22
15	SI,SO	51	A27	87	A49	123	G21
16	DB ₀	52	A26	88	A50	124	G20
17	DB ₁	53	A25	89	A51	125	G19
18	DB ₂	54	A24	90	A52	126	G18
19	DB ₃	55	A23	91	A53	127	G17
20	DB ₄	56	A22	92	A54	128	G16
21	DB ₅	57	A21	93	A55	129	G15
22	DB ₆	58	A20	94	A56	130	G14
23	DB ₇	59	A19	95	A57	131	G13
24	IM	60	A18	96	A58	132	G12
25	MPU	61	A17	97	A59	133	G11
26	/CS	62	A16	98	A60	134	G10
27	R,L1	63	A15	99	A61	135	G9
28	R,L2	64	A14	100	A62	136	G8
29	/CL	65	A13	101	A63	137	G7
30	LE	66	A12	102	A64	138	G6
31	SDO	67	A11	103	A65	139	G5
32	SLK	68	A10	104	A66	140	G4
33	TEST _{OUT}	69	A9	105	A67	141	G3
34	V _{SS1}	70	A8	106	A68	142	G2
35	V _{SS2}	71	A7	107	A69	143	G1
36	V _{DD2}	72	N.C.	108	A70	144	N.C.

Table 5-4. Anode Pin Layout (When R,L1 = H, R,L2 = L)

No.	Name	No.	Name	No.	Name	No.	Name
1	V _{DD2}	37	N.C.	73	A75	109	N.C.
2	V _{SS2}	38	A41	74	A76	110	A10
3	V _{DD1}	39	A42	75	A77	111	A9
4	X _{OUT}	40	A43	76	A78	112	A8
5	OSC _{OUT}	41	A44	77	A79	113	A7
6	OSC _{IN}	42	A45	78	A80	114	A6
7	/RESET	43	A46	79	A40	115	A5
8	TEST	44	A47	80	A39	116	A4
9	DLS	45	A48	81	A38	117	A3
10	DS1	46	A49	82	A37	118	A2
11	DS0	47	A50	83	A36	119	A1
12	R,W(/WR)	48	A51	84	A35	120	G24
13	RS,STB	49	A52	85	A34	121	G23
14	E(/RD),SCK	50	A53	86	A33	122	G22
15	SI,SO	51	A54	87	A32	123	G21
16	DB ₀	52	A55	88	A31	124	G20
17	DB ₁	53	A56	89	A30	125	G19
18	DB ₂	54	A57	90	A29	126	G18
19	DB ₃	55	A58	91	A28	127	G17
20	DB ₄	56	A59	92	A27	128	G16
21	DB ₅	57	A60	93	A26	129	G15
22	DB ₆	58	A61	94	A25	130	G14
23	DB ₇	59	A62	95	A24	131	G13
24	IM	60	A63	96	A23	132	G12
25	MPU	61	A64	97	A22	133	G11
26	/CS	62	A65	98	A21	134	G10
27	R,L1	63	A66	99	A20	135	G9
28	R,L2	64	A67	100	A19	136	G8
29	/CL	65	A68	101	A18	137	G7
30	LE	66	A69	102	A17	138	G6
31	SDO	67	A70	103	A16	139	G5
32	SLK	68	A71	104	A15	140	G4
33	TEST _{OUT}	69	A72	105	A14	141	G3
34	V _{SS1}	70	A73	106	A13	142	G2
35	V _{SS2}	71	A74	107	A12	143	G1
36	V _{DD2}	72	N.C.	108	A11	144	N.C.

Table 5-5. Anode Pin Layout (When R,L1 = H, R,L2 = H)

★
★
★
★
★
★

No.	Name	No.	Name	No.	Name	No.	Name
1	V _{DD2}	37	N.C.	73	A46	109	N.C.
2	V _{SS2}	38	A80	74	A45	110	A10
3	V _{DD1}	39	A79	75	A44	111	A9
4	X _{OUT}	40	A78	76	A43	112	A8
5	OSC _{OUT}	41	A77	77	A42	113	A7
6	OSC _{IN}	42	A76	78	A41	114	A6
7	/RESET	43	A75	79	A40	115	A5
8	TEST	44	A74	80	A39	116	A4
9	DLS	45	A73	81	A38	117	A3
10	DS1	46	A72	82	A37	118	A2
11	DS0	47	A71	83	A36	119	A1
12	R,W	48	A70	84	A35	120	G24
13	RS,STB	49	A69	85	A34	121	G23
14	E(/RD),SCK	50	A68	86	A33	122	G22
15	SI,SO	51	A67	87	A32	123	G21
16	DB ₀	52	A66	88	A31	124	G20
17	DB ₁	53	A65	89	A30	125	G19
18	DB ₂	54	A64	90	A29	126	G18
19	DB ₃	55	A63	91	A28	127	G17
20	DB ₄	56	A62	92	A27	128	G16
21	DB ₅	57	A61	93	A26	129	G15
22	DB ₆	58	A60	94	A25	130	G14
23	DB ₇	59	A59	95	A24	131	G13
24	IM	60	A58	96	A23	132	G12
25	MPU	61	A57	97	A22	133	G11
26	/CS	62	A56	98	A21	134	G10
27	R,L1	63	A55	99	A20	135	G9
28	R,L2	64	A54	100	A19	136	G8
29	/CL	65	A53	101	A18	137	G7
30	LE	66	A52	102	A17	138	G6
31	SDO	67	A51	103	A16	139	G5
32	SLK	68	A50	104	A15	140	G4
33	TEST _{OUT}	69	A49	105	A14	141	G3
34	V _{SS1}	70	A48	106	A13	142	G2
35	V _{SS2}	71	A47	107	A12	143	G1
36	V _{DD2}	72	N.C.	108	A11	144	N.C.

Table 5-6. Anode Setting: 1 Line Display (N=0)

R,L1	R,L2	Table No.
Don't care	L	Table 5-7
Don't care	H	Table 5-8

Table 5-7. Anode Pin Layout (When R,L2 = L)

No.	Name	No.	Name	No.	Name	No.	Name
1	V _{DD2}	37	N.C.	73	A35	109	N.C.
2	V _{SS2}	38	A1	74	A36	110	Unused
3	V _{DD1}	39	A2	75	A37	111	
4	X _{OUT}	40	A3	76	A38	112	
5	OSC _{OUT}	41	A4	77	A39	113	
6	OSC _{IN}	42	A5	78	A40	114	
7	/RESET	43	A6	79	Unused	115	
8	TEST	44	A7	80		116	
9	DLS	45	A8	81		117	
10	DS1	46	A9	82		118	
11	DS0	47	A10	83		119	▼
12	R, _W	48	A11	84		120	G24
13	RS,STB	49	A12	85		121	G23
14	E(/RD),SCK	50	A13	86		122	G22
15	SI,SO	51	A14	87		123	G21
16	DB ₀	52	A15	88		124	G20
17	DB ₁	53	A16	89		125	G19
18	DB ₂	54	A17	90		126	G18
19	DB ₃	55	A18	91		127	G17
20	DB ₄	56	A19	92		128	G16
21	DB ₅	57	A20	93		129	G15
22	DB ₆	58	A21	94		130	G14
23	DB ₇	59	A22	95		131	G13
24	IM	60	A23	96		132	G12
25	MPU	61	A24	97		133	G11
26	/CS	62	A25	98		134	G10
27	R,L1	63	A26	99		135	G9
28	R,L2	64	A27	100		136	G8
29	/CL	65	A28	101		137	G7
30	LE	66	A29	102		138	G6
31	SDO	67	A30	103		139	G5
32	SLK	68	A31	104		140	G4
33	TEST _{OUT}	69	A32	105		141	G3
34	V _{SS1}	70	A33	106		142	G2
35	V _{SS2}	71	A34	107		143	G1
36	V _{DD2}	72	N.C.	108	▼	144	N.C.

Table 5-8. Anode Pin Layout (When R,L2 = H)

No.	Name	No.	Name	No.	Name	No.	Name
1	V _{DD2}	37	N.C.	73	A6	109	N.C.
2	V _{SS2}	38	A40	74	A5	110	Unused
3	V _{DD1}	39	A39	75	A4	111	
4	X _{OUT}	40	A38	76	A3	112	
5	OSC _{OUT}	41	A37	77	A2	113	
6	OSC _{IN}	42	A36	78	A1	114	
7	/RESET	43	A35	79	Unused	115	
8	TEST	44	A34	80		116	
9	DLS	45	A33	81		117	
10	DS1	46	A32	82		118	
11	DS0	47	A31	83		119	▼
12	R,W	48	A30	84		120	G24
13	RS,STB	49	A29	85		121	G23
14	E(/RD),SCK	50	A28	86		122	G22
15	SI,SO	51	A27	87		123	G21
16	DB ₀	52	A26	88		124	G20
17	DB ₁	53	A25	89		125	G19
18	DB ₂	54	A24	90		126	G18
19	DB ₃	55	A23	91		127	G17
20	DB ₄	56	A22	92		128	G16
21	DB ₅	57	A21	93		129	G15
22	DB ₆	58	A20	94		130	G14
23	DB ₇	59	A19	95		131	G13
24	IM	60	A18	96		132	G12
25	MPU	61	A17	97		133	G11
26	/CS	62	A16	98		134	G10
27	R,L1	63	A15	99		135	G9
28	R,L2	64	A14	100		136	G8
29	/CL	65	A13	101		137	G7
30	LE	66	A12	102		138	G6
31	SDO	67	A11	103		139	G5
32	SLK	68	A10	104		140	G4
33	TEST _{OUT}	69	A9	105		141	G3
34	V _{SS1}	70	A8	106		142	G2
35	V _{SS2}	71	A7	107		143	G1
36	V _{DD2}	72	N.C.	108		144	N.C.

6. VFD DISPLAY

The μ PD16314 can display 24 characters x 2 lines, and a VFD can be connected as shown in the figure below.

Figure 6-1. VFD Display

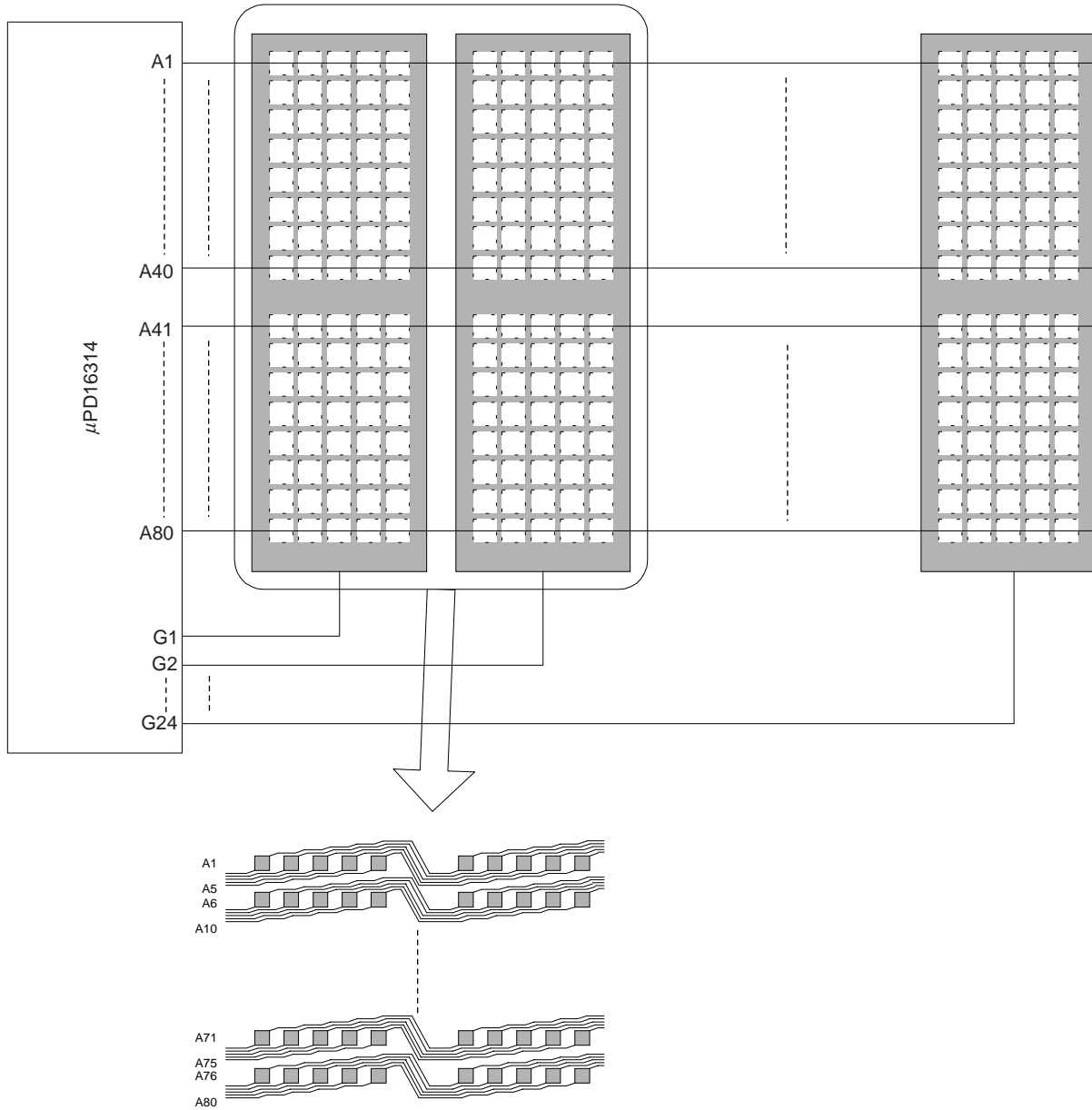

7. BLOCK FUCTIONS

7.1 CPU Interface

The μ PD16314 is provided with a 4-or 8-bit parallel interface and a serial interface. The interface mode is set by the IM pin.

IM = "L": Serial data transfer

IM = "H": Parallel data transfer

Table 7-1. CPU Interface

IM	/CS	RS,STB	E(/RD),SCK	R,/W(/WR)	MPU	SI,SO	DBn
L	/CS	STB	SCK	Note	Note	SI,SO	Note
H	/CS	RS	E(/RD)	R,/W(/WR)	MPU	Note	DBn

Note Fix this pin to H or L.

7.2 Registers (IR, DR)

The μ PD16314 has two 8-bit registers: an instruction register (IR) and a data register (DR). The IR stores instruction codes, such as display clear and cursor shift, and address information for display data RAM (DDRAM) and character generator RAM (CGRAM). The IR can only be written to from the MPU. The DR temporarily stores the data to be written or read from DDRAM or CGRAM

Table 7-2. Register Selection (IR, DR)

Common	M68	i80		Function
		R,/W	/RD	
L	L	H	L	IR data is written as an internal operation (display clear, etc.)
L	H	L	H	Data is read to the busy flag (DB ₇) and address counter (DB ₆ to DB ₀)
H	L	H	L	DR data is written (DR → DDRAM, CGRAM).
H	H	L	H	DR data is read (DDRAM, CGRAM → DR).

7.3 Busy Flag (Read BF Flag)

L is always output for busy flag data (DB₇).

7.4 Address Counter (AC)

The address counter(AC) assigns addresses to both DDRAM and CGRAM. When an instruction address is written the IR, the address information is sent from the IR to the AC.

Selection of either DDRAM or CGRAM is also determined concurrently by the instruction. After writing to (reading from) DDRAM or CGRAM, the AC is automatically incremented (+1) . The AC contents are output to DB₀ to DB₆ when RS = L and R,/W = H (Refer to **Table 7-2. Register Selection (IR,DR).**)

7.5 Display Data RAM (DDRAM)

Display data RAM (DDRAM) stores display data displayed in 8-bit character codes. Its capacity is 80 x 8 bits, or 80 characters. The area in DDRAM that is not used for display can be used as general data RAM. Refer to **7.5.1 1-line display (N = 0)**, **7.5.2 2-line display (N = 1)** for the relationship between the DDRAM address and the position on the VFD.

The DDRAM address (ADD) is set in the address counter (AC) as hexadecimal.

Figure 7-1. DDRAM Address

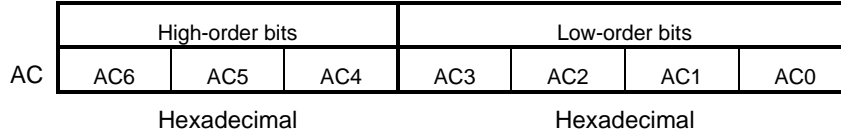

Example : DDRAM address "26"

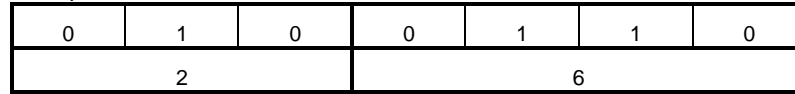

7.5.1 1-line display (N = 0)

Figure 7-2. 1-Line Display

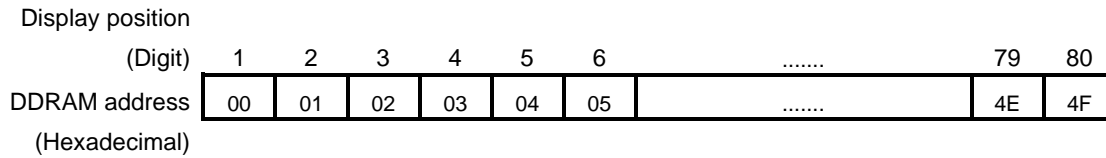

When there are fewer than 80 display characters, the display begins at the head position. For example, if using only one μ PD16314, 24 characters are displayed. When a display shift operation is executed, the DDRAM address shifts. Refer to **Figure 7-3. Example of 1-line/24-Character Display**.

Figure 7-3. 1-line by 24 Characters Display Example

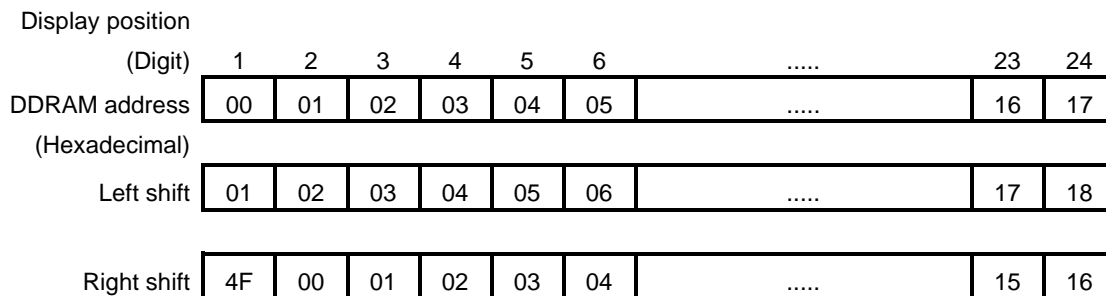

7.5.2 2-line display (N = 1)

Figure 7-4. 2-Line Display

Display position (Digit)	1	2	3	4	5	6	39	40
DDRAM address	00	01	02	03	04	05	26	27
(Hexadecimal)	40	41	42	43	44	45	66	67

When the number of display character is less than 40 x 2 lines, the 2 lines are displayed from the head. The first line end address and the second line start address are not consecutive.

For example, if using only one μ PD16314, 24 characters x 2 lines are displayed. When a display shift operation is executed, the DDRAM address shifts. Refer to Figure 7-5. Example of 2-Line/24-Character Display.

Figure 7-5. Example of 2-Line/24-Character Display

Display position (Digit)	1	2	3	4	5	6	23	24
DDRAM address	00	01	02	03	04	05	16	17
(Hexadecimal)	40	41	42	43	44	45	56	57

Left shift	01	02	03	04	05	06	17	18
	41	42	43	44	45	46	57	58

Right shift	27	00	01	02	03	04	15	16
	67	40	41	42	43	44	55	56

For 40 characters x 2 lines display, the μ PD16314 can be extended using one 16-output grid extension driver. When a display shift operation is executed, the DDRAM address shifts. Refer to Figure 7-6. Example of 2-Line/40-Character Display.

Figure 7-6. Example of 2-Line/40-Character Display

Display position (Digit)	1	2	3	4	23	24	25	39	40
DDRAM address	00	01	02	03	16	17	18	26	27
(Hexadecimal)	40	41	42	43	56	57	58	66	67

Left shift	01	02	03	04	17	18	19	27	00
	41	42	43	44	57	58	59	57	40

Right shift	27	00	01	02	15	16	17	25	26
	67	40	41	42	55	56	57	65	66

μ PD16314 display								Extension driver display			
-------------------	--	--	--	--	--	--	--	--------------------------	--	--	--

7.6 Character Generator ROM (CGROM)

CGROM, which is ROM for generating character patterns of 5 x 8 dots from 8-bit character codes, generates 240 types of character patterns.

The character codes are shown on the following page. The character codes 00H to 0FH are allocated to the CGRAM.

Figure 7-7. Character Code Table 1 (ROM code: 001)

		0	1	2	3	4	5	6	7	8	9	A	B	C	D	E	F
XXXX0000	0	CG RAM (0)	CG RAM (0)	CG RAM (0)	CG RAM (0)	CG RAM (0)	CG RAM (0)	CG RAM (0)	CG RAM (0)	CG RAM (0)	CG RAM (0)	CG RAM (0)	CG RAM (0)	CG RAM (0)	CG RAM (0)	CG RAM (0)	CG RAM (0)
XXXX0001	1	CG RAM (1)	CG RAM (1)	CG RAM (1)	CG RAM (1)	CG RAM (1)	CG RAM (1)	CG RAM (1)	CG RAM (1)	CG RAM (1)	CG RAM (1)	CG RAM (1)	CG RAM (1)	CG RAM (1)	CG RAM (1)	CG RAM (1)	CG RAM (1)
XXXX0010	2	CG RAM (2)	CG RAM (2)	CG RAM (2)	CG RAM (2)	CG RAM (2)	CG RAM (2)	CG RAM (2)	CG RAM (2)	CG RAM (2)	CG RAM (2)	CG RAM (2)	CG RAM (2)	CG RAM (2)	CG RAM (2)	CG RAM (2)	CG RAM (2)
XXXX0011	3	CG RAM (3)	CG RAM (3)	CG RAM (3)	CG RAM (3)	CG RAM (3)	CG RAM (3)	CG RAM (3)	CG RAM (3)	CG RAM (3)	CG RAM (3)	CG RAM (3)	CG RAM (3)	CG RAM (3)	CG RAM (3)	CG RAM (3)	CG RAM (3)
XXXX0100	4	CG RAM (4)	CG RAM (4)	CG RAM (4)	CG RAM (4)	CG RAM (4)	CG RAM (4)	CG RAM (4)	CG RAM (4)	CG RAM (4)	CG RAM (4)	CG RAM (4)	CG RAM (4)	CG RAM (4)	CG RAM (4)	CG RAM (4)	CG RAM (4)
XXXX0101	5	CG RAM (5)	CG RAM (5)	CG RAM (5)	CG RAM (5)	CG RAM (5)	CG RAM (5)	CG RAM (5)	CG RAM (5)	CG RAM (5)	CG RAM (5)	CG RAM (5)	CG RAM (5)	CG RAM (5)	CG RAM (5)	CG RAM (5)	CG RAM (5)
XXXX0110	6	CG RAM (6)	CG RAM (6)	CG RAM (6)	CG RAM (6)	CG RAM (6)	CG RAM (6)	CG RAM (6)	CG RAM (6)	CG RAM (6)	CG RAM (6)	CG RAM (6)	CG RAM (6)	CG RAM (6)	CG RAM (6)	CG RAM (6)	CG RAM (6)
XXXX0111	7	CG RAM (7)	CG RAM (7)	CG RAM (7)	CG RAM (7)	CG RAM (7)	CG RAM (7)	CG RAM (7)	CG RAM (7)	CG RAM (7)	CG RAM (7)	CG RAM (7)	CG RAM (7)	CG RAM (7)	CG RAM (7)	CG RAM (7)	CG RAM (7)
XXXX1000	8	CG RAM (0)	CG RAM (0)	CG RAM (0)	CG RAM (0)	CG RAM (0)	CG RAM (0)	CG RAM (0)	CG RAM (0)	CG RAM (0)	CG RAM (0)	CG RAM (0)	CG RAM (0)	CG RAM (0)	CG RAM (0)	CG RAM (0)	CG RAM (0)
XXXX1001	9	CG RAM (1)	CG RAM (1)	CG RAM (1)	CG RAM (1)	CG RAM (1)	CG RAM (1)	CG RAM (1)	CG RAM (1)	CG RAM (1)	CG RAM (1)	CG RAM (1)	CG RAM (1)	CG RAM (1)	CG RAM (1)	CG RAM (1)	CG RAM (1)
XXXX1010	A	CG RAM (2)	CG RAM (2)	CG RAM (2)	CG RAM (2)	CG RAM (2)	CG RAM (2)	CG RAM (2)	CG RAM (2)	CG RAM (2)	CG RAM (2)	CG RAM (2)	CG RAM (2)	CG RAM (2)	CG RAM (2)	CG RAM (2)	CG RAM (2)
XXXX1011	B	CG RAM (3)	CG RAM (3)	CG RAM (3)	CG RAM (3)	CG RAM (3)	CG RAM (3)	CG RAM (3)	CG RAM (3)	CG RAM (3)	CG RAM (3)	CG RAM (3)	CG RAM (3)	CG RAM (3)	CG RAM (3)	CG RAM (3)	CG RAM (3)
XXXX1100	C	CG RAM (4)	CG RAM (4)	CG RAM (4)	CG RAM (4)	CG RAM (4)	CG RAM (4)	CG RAM (4)	CG RAM (4)	CG RAM (4)	CG RAM (4)	CG RAM (4)	CG RAM (4)	CG RAM (4)	CG RAM (4)	CG RAM (4)	CG RAM (4)
XXXX1101	D	CG RAM (5)	CG RAM (5)	CG RAM (5)	CG RAM (5)	CG RAM (5)	CG RAM (5)	CG RAM (5)	CG RAM (5)	CG RAM (5)	CG RAM (5)	CG RAM (5)	CG RAM (5)	CG RAM (5)	CG RAM (5)	CG RAM (5)	CG RAM (5)
XXXX1110	E	CG RAM (6)	CG RAM (6)	CG RAM (6)	CG RAM (6)	CG RAM (6)	CG RAM (6)	CG RAM (6)	CG RAM (6)	CG RAM (6)	CG RAM (6)	CG RAM (6)	CG RAM (6)	CG RAM (6)	CG RAM (6)	CG RAM (6)	CG RAM (6)
XXXX1111	F	CG RAM (7)	CG RAM (7)	CG RAM (7)	CG RAM (7)	CG RAM (7)	CG RAM (7)	CG RAM (7)	CG RAM (7)	CG RAM (7)	CG RAM (7)	CG RAM (7)	CG RAM (7)	CG RAM (7)	CG RAM (7)	CG RAM (7)	CG RAM (7)

Figure 7-8. Character Code Table 2 (ROM code: 002)

	0	1	2	3	4	5	6	7	8	9	A	B	C	D	E	F		
XXXX0000	0	CG RAM (0)	!	1	2	3	4	5	6	7	8	9	A	B	C	D	E	F
XXXX0001	1	CG RAM (1)	!	1	2	3	4	5	6	7	8	9	A	B	C	D	E	F
XXXX0010	2	CG RAM (2)	!	1	2	3	4	5	6	7	8	9	A	B	C	D	E	F
XXXX0011	3	CG RAM (3)	!	1	2	3	4	5	6	7	8	9	A	B	C	D	E	F
XXXX0100	4	CG RAM (4)	!	1	2	3	4	5	6	7	8	9	A	B	C	D	E	F
XXXX0101	5	CG RAM (5)	!	1	2	3	4	5	6	7	8	9	A	B	C	D	E	F
XXXX0110	6	CG RAM (6)	!	1	2	3	4	5	6	7	8	9	A	B	C	D	E	F
XXXX0111	7	CG RAM (7)	!	1	2	3	4	5	6	7	8	9	A	B	C	D	E	F
XXXX1000	8	CG RAM (0)	!	1	2	3	4	5	6	7	8	9	A	B	C	D	E	F
XXXX1001	9	CG RAM (1)	!	1	2	3	4	5	6	7	8	9	A	B	C	D	E	F
XXXX1010	A	CG RAM (2)	!	1	2	3	4	5	6	7	8	9	A	B	C	D	E	F
XXXX1011	B	CG RAM (3)	!	1	2	3	4	5	6	7	8	9	A	B	C	D	E	F
XXXX1100	C	CG RAM (4)	!	1	2	3	4	5	6	7	8	9	A	B	C	D	E	F
XXXX1101	D	CG RAM (5)	!	1	2	3	4	5	6	7	8	9	A	B	C	D	E	F
XXXX1110	E	CG RAM (6)	!	1	2	3	4	5	6	7	8	9	A	B	C	D	E	F
XXXX1111	F	CG RAM (7)	!	1	2	3	4	5	6	7	8	9	A	B	C	D	E	F

7.7 Character Generator RAM (CGRAM)

With character generator RAM (CGRAM), the user can rewrite character patterns by program. For 5 x 8 dots, 8-character patterns can be written.

Character codes 00H to 07H and 08H to 0FH have the same CGRAM contents.

Refer to **Figure 7-9 for the relationship between the CGRAM address and data and display patterns.** Areas that are not used for display can be used as general data RAM.

Figure 7-9. Relationship between the CGRAM Address, Character Code (DDRAM) and 5 x 7 (With Cursor) Dot Character Patterns (CGRAM)

Character code (DDRAM data)								CGRAM address						CGRAM data								
D7	D6	D5	D4	D3	D2	D1	D0	A5	A4	A3	A2	A1	A0	D7	D6	D5	D4	D3	D2	D1	D0	
High-order bits				Low-order bits				High-order bits			Low-order bits			High-order bits				Low-order bits				
0	0	0	0	x	0	0	0	0	0	0	0	0	0	x	x	x	1	0	0	0	1	Character pattern (0)
											0	0	1				1	0	0	0	1	
											0	1	0				1	1	0	0	1	
											0	1	1				1	0	1	0	1	
											1	0	0				1	0	0	1	1	
											1	0	1				1	0	0	0	1	
											1	1	0				1	0	0	0	1	
											1	1	1				0	0	0	0	0	
0	0	0	0	x	0	0	1	0	0	1	0	0	0	x	x	x	1	1	1	1	1	Character pattern (1)
											0	0	1				1	0	0	0	0	
											0	1	0				1	0	0	0	0	
											0	1	1				1	1	1	1	1	
											1	0	0				1	0	0	0	0	
											1	0	1				1	0	0	0	0	
											1	1	0				1	1	1	1	1	
											1	1	1				0	0	0	0	0	
0	0	0	0	x	1	1	1	1	1	1	0	0	0	x	x	x	0	1	1	1	0	Character pattern (7)
											0	0	1				1	0	0	0	1	
											0	1	0				1	0	0	0	0	
											0	1	1				1	0	0	0	0	
											1	0	0				1	0	0	0	0	
											1	0	1				1	0	0	0	1	
											1	1	0				0	1	1	1	0	
											1	1	1				1	1	1	1	1	

- Remarks**
1. x: Don't care.
 2. Character code bits 0 to 2 correspond to CGRAM address bits 3 to 5 (3 bits: 8 types).
 3. CGRAM address bits 0 to 2 designate the character pattern line position. The 8th line is the cursor position and its display is formed by a logical OR with the cursor specification. If the 8th line data is made 0, the display is determined by the cursor specification. If the 8th line data is 1, the 8th line will light up regardless of the cursor presence.
 4. 1 for CGRAM data corresponds to display selection and 0 to non selection.

7.8 Timing Generator

The timing generator generates timing signals for the operation of internal circuits such as DDRAM, CGRAM and CGROM. The RAM read timing for display and internal operation timing by MPU access are generated separately to avoid interference. Therefore, when writing data to DDRAM, for example, there will be no undesirable interference, such as flickering, in areas other than the display area.

7.9 VFD Driver Circuit

The VFD driver circuit consists of 24 grid signal drivers and 80 anode signal drivers. When the character font and number of digits are selected, the required grid signal drivers automatically output drive waveforms.

7.10 Cursor/Blink Control Circuit

The cursor/blink control circuit generates the cursor or character blink. The cursor or blink is valid at the digit located at the display data RAM (DDRAM) address set in the address counter (AC).

For example, when the address counter is 08H, the cursor position is displayed at DDRAM address 08H.

Figure 7-10. Cursor/Blink Control

	AC6	AC5	AC4	AC3	AC2	AC1	AC0
AC	0	0	0	1	0	0	0

For 1-line display

Display position (Digit)	1	2	3	4	5	6	7	8	9	10	11	12
DDRAM address (Hexadecimal)	00	01	02	03	04	05	06	07	08	09	0A	0B



 Cursor position

For 2-line display

Display position (Digit)	1	2	3	4	5	6	7	8	9	10	11	12
DDRAM address (Hexadecimal)	00	01	02	03	04	05	06	07	08	09	0A	0B
	40	41	42	43	44	45	46	47	48	49	4A	4B



 Cursor position

8. INTERFACING WITH CPU (DATA TRANSFER)

★ 8.1 Parallel Data Transfer M68 (IM = H, MPU = H)

This IC can interface (data transfer) with the CPU in 4 or 8 bits (M68 interface: IM = H, MPU = H).

However, because the internal registers consist of 8 bits, when transferring data in 4 bits DB₄ to DB₇ must be used twice. When using 4-bit parallel data transfer, maintain the DB₀ to DB₃ pins at H or L. The transfer order is the higher 4 bits first (D₄ to D₇) followed by the lower 4 bits (D₀ to D₃).

Figure 8-1. Parallel Data Transfer M68 (IM = H, MPU = H)

(a) 4-bit data transfer (M68)

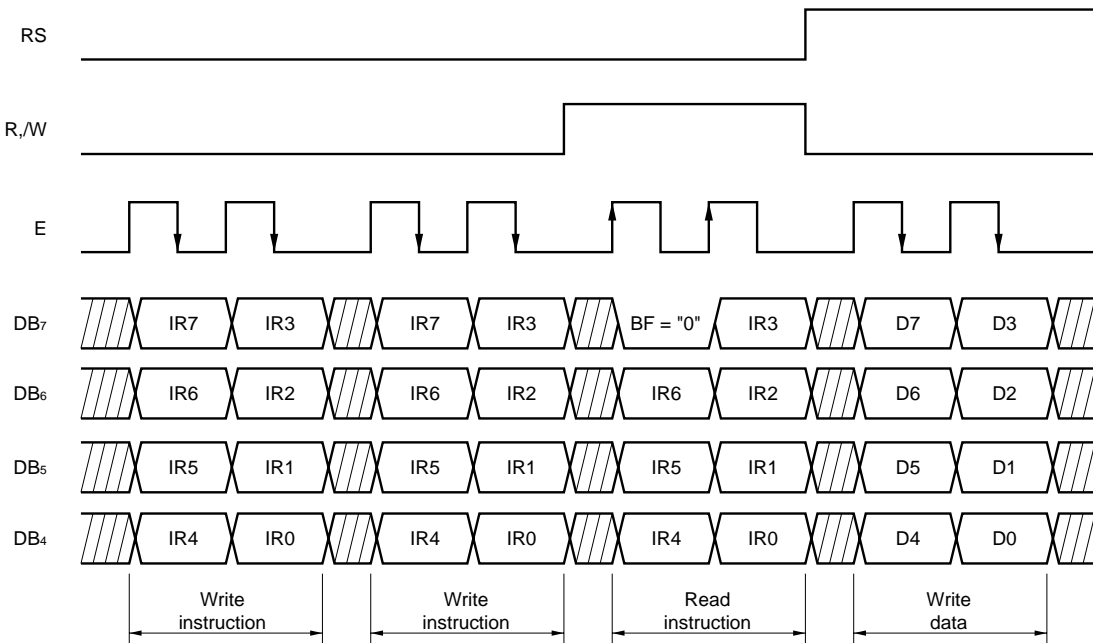

(b) 8-bit data transfer (M68)

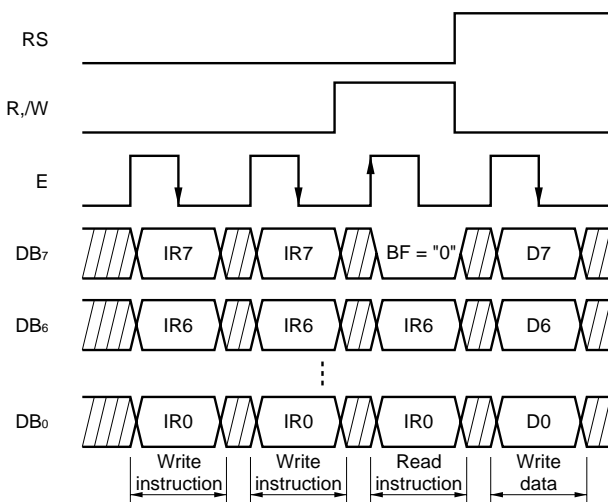

8.2 Parallel Data Transfer i80 (IM = H, MPU = L)

When IM = H, MPU = L is set, i80 is selected. In the μ PD16314, each time data is sent to and from the CPU, the data is retained the bus holder attached to internal data bus, and is written to the display data RAM by the next data write cycle. When the CPU reads the contents of the display data RAM, the read data is retained in the bus holder for the first data read cycle (dummy), and is read out on the system bus at the next data read cycle.

There are certain restrictions in the read sequence of this display data RAM. Be advised that data of the specified address is not generated by the read instruction issued immediately after the address setting. This data is generated when the data is read of the second time. Thus, a dummy read is required following an address setting or write cycle. This relationship is shown in following figure.

Figure 8-2. Parallel Data Transfer i80 (IM = H, MPU = L)

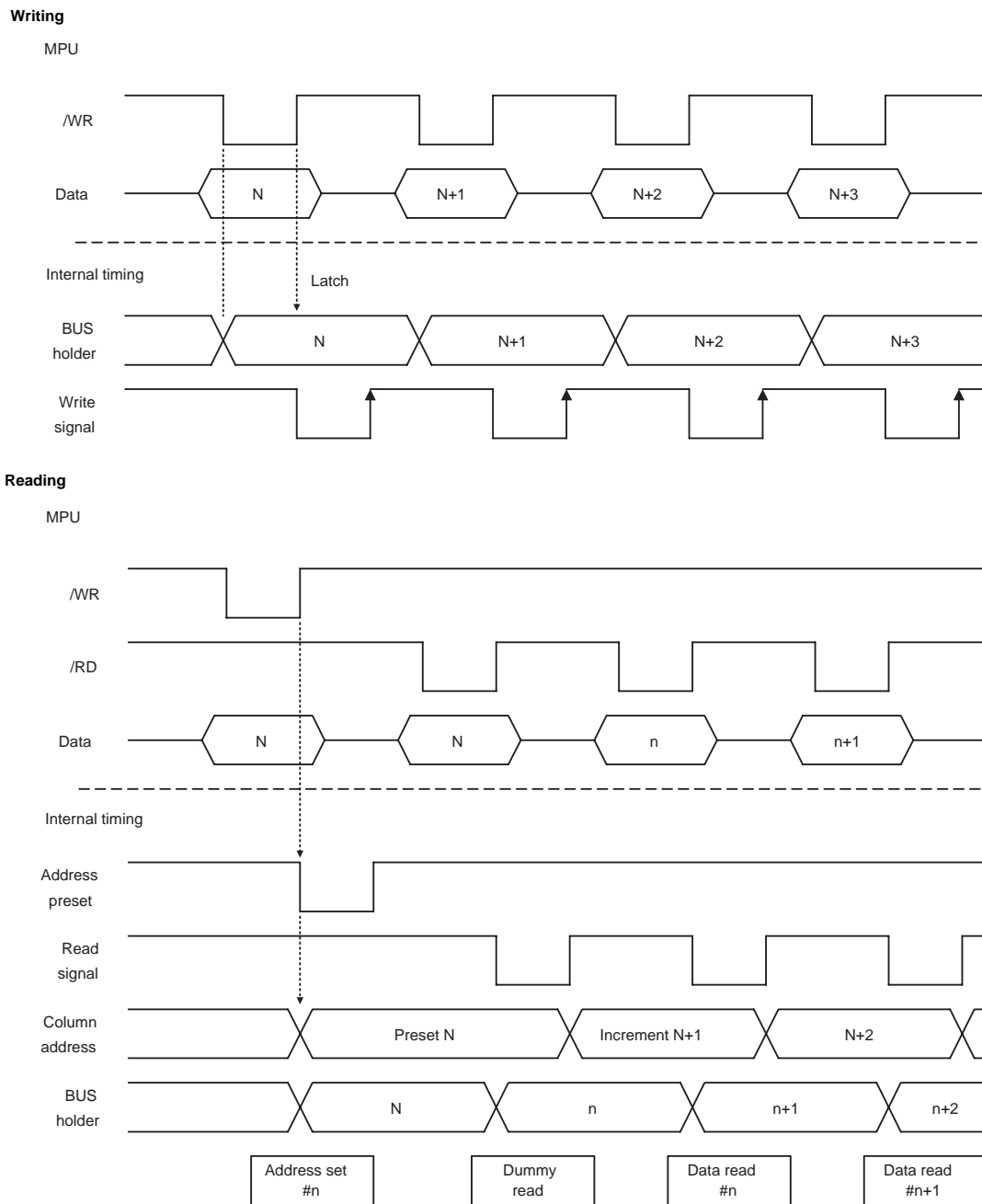

8.3 Serial Data Transfer

This IC can interface (data transfer) with the CPU in serial.

Data can be written when STB = L. The first byte is the start byte. The IR or the DR is selected by the RS bit(bit 6) and data write or read by R,_W(bit 5 = 0). The next first bytes are instructions on data.

When data is read, whether to read the busy flag + address counter (AC6 to AC0) or to read the data written in DDRAM or CGRAM is chosen by the start byte input first. Data is output at the falling edge of the shift clock.

Figure 8-3. Serial Data Transfer

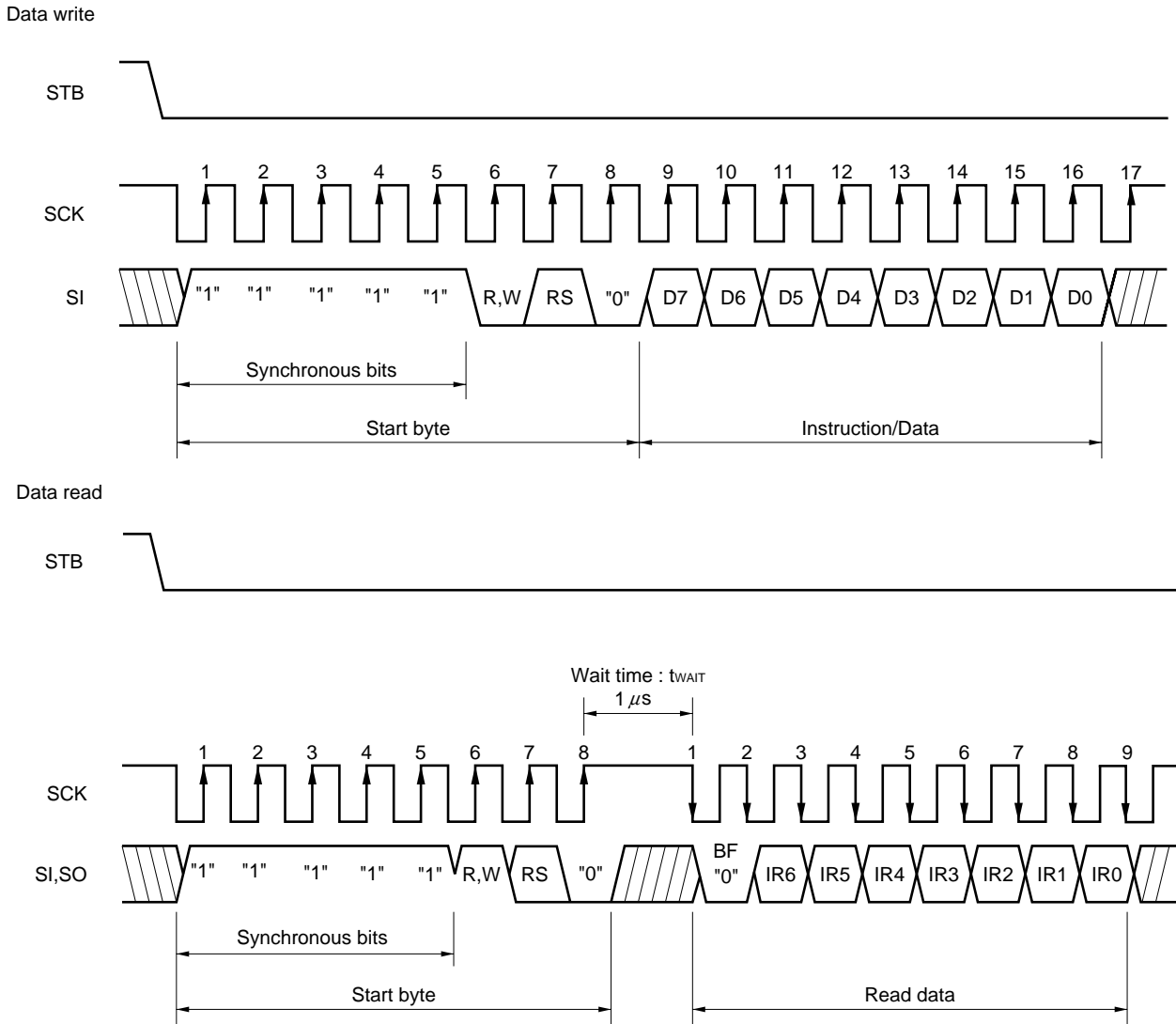

9. INSTRUCTIONS

Instruction	RS	R,/W	DB ₇	DB ₆	DB ₅	DB ₄	DB ₃	DB ₂	DB ₁	DB ₀	Description
Clear display	0	0	0	0	0	0	0	0	0	1	Clears the entire display, and sets the DDRAM address to 00H.
Cursor home	0	0	0	0	0	0	0	0	1	x	Sets the DDRAM address to 00H. Also returns the display being shifted to the original position. DDRAM contents remain unchanged.
Entry mode set	0	0	0	0	0	0	0	1	I/D	S	Sets the cursor direction and specifies display shift. These operations are performed during writing/reading data.
Display ON/OFF	0	0	0	0	0	0	1	D	C	B	Turns the entire display ON/OFF(D), the cursor ON/OFF(C), and sets the cursor blink at the character position(B).
Cursor or display shift	0	0	0	0	0	1	S/C	R/L	x	x	Shifts the display or cursor. Maintains DDRAM contents.
Function set	0	0	0	0	1	DL	N	x	BR1	BR0	Sets the data length (parallel data transfer) and number of lines
CGRAM address set	0	0	0	1	ACG					Set the address of CGRAM. After that, CGRAM data is transferred.	
DDRAM address set	0	0	1	AD D					Set the address of DDRAM. After that, DDRAM data is transferred.		
Read busy flag & address	0	1	BF='0'	AC					Reads the busy flag (BF) and address counter. BF o always outputs '0'.		
Write data to CGRAM or DDRAM	1	0	Write data					Writes data to CGRAM or DDRAM.			
Read data from CGRAM or DDRAM	1	1	Read DR data					Reads data from CGRAM or DDRAM.			

Remarks 1. I/D = 1: Increment

I/D = 0: Decrement

S = 1: Display shift enabled

S = 0: Cursor shift enabled

S/C = 1: Display shift

S/C = 0: Cursor shift

R/L = 1: Shift to the right

R/L = 0: Shift to the left

DL = 1: 8 bits

DL = 0: 4 bits

N = 0: 1 Line

N = 1: 2 Lines

BR1, BR0 = 00: 100%

01: 75%

10: 50%

11: 25%

2. X: Don't care

DDRAM: Display Data RAM

CGRAM: Character Generator RAM

ACG: CGRAM address

ADD: DDRAM address

AC: Address counter

10. INSTRUCTION DESCRIPTION

10.1 Clear Display

	RS	R,/W	DB ₇	DB ₆	DB ₅	DB ₄	DB ₃	DB ₂	DB ₁	DB ₀
Code	0	0	0	0	0	0	0	0	0	1

This instruction:

- (1) Writes to 20H (Space code) all locations in display data RAM (DDRAM)
- (2) Sets the address counter (AC) to the DDRAM address 00H.
- (3) Returns the display Shift to 0.
- (4) If cursor is displayed, the cursor is moved to the far left edge of the top line (upper line).

After reset:

DB ₇	DB ₆	DB ₅	DB ₄	DB ₃	DB ₂	DB ₁	DB ₀
0	0	0	0	0	0	0	1

10.2 Cursor Home

	RS	R,/W	DB ₇	DB ₆	DB ₅	DB ₄	DB ₃	DB ₂	DB ₁	DB ₀
Code	0	0	0	0	0	0	0	0	0	x

This instruction:

- (1) Sets the address counter (AC) to the DDRAM address 00H.
- (2) Returns the display Shift to 0.
- (3) If cursor is displayed, the cursor is held at the far edge of left the top line (upper line).

10.3 Entry Mode

	RS	R,/W	DB ₇	DB ₆	DB ₅	DB ₄	DB ₃	DB ₂	DB ₁	DB ₀
Code	0	0	0	0	0	0	0	1	I/D	S

The I/D determines the way in which the contents of address counter are modified after every access to DDRAM or CGRAM.

- I/D = 1: Address counter incremented after access to DDRAM or CGRAM.
- I/D = 0: Address counter decremented after access to DDRAM or CGRAM.

The S bit determines a display shift whether or a cursor shift occurs after each write or read to/from DDRAM.

- S = 1: Display shift enabled.
- S = 0: Cursor shift enabled.

The direction in which the display is shifted is the opposite to that of the cursor.
 For example, if S = 0 and I/D = 1, cursor would shift one character to the right after a CPU write to DDRAM. However if S = 1 and I/D = 1, the display would shift one character to the left and cursor would maintain its position on the panel.

Note that the cursor is shifted in the direction selected by I/D when DDRAM is read, irrespective of the value of S. Similarly reading and writing CGRAM always causes the cursor to shift.

Table 10–1. Cursor Move and Display Shift by Entry Mode Setting

I/D	S	After Writing DDRAM Data	After Reading DDRAM Data
0	0	Cursor moves one character to the left.	Cursor moves one character to the left.
1	0	Cursor moves one character to the right.	Cursor moves one character to the right.
0	1	Display shifts one character to the right without cursor moving.	Cursor moves one character to the left.
1	1	Display shifts one character to the left without cursor moving.	Cursor moves one character to the right.

After reset:

DB ₇	DB ₆	DB ₅	DB ₄	DB ₃	DB ₂	DB ₁	DB ₀
0	0	0	0	0	1	1	0

10.4 Display ON/OFF

	RS	R,/W	DB ₇	DB ₆	DB ₅	DB ₄	DB ₃	DB ₂	DB ₁	DB ₀
Code	0	0	0	0	0	0	1	D	C	B

This instruction controls various features of the display.

D = 1: Display on, D = 0: Display off.

C = 1: Cursor on, C = 0: Cursor off.

B = 1: Blink on, B = 0: Blink off.

Blinking is achieved by alternating between a normal and all-on display of a character.

The cursor blinks with a frequency of 1 Hz and a duty of 50 %.

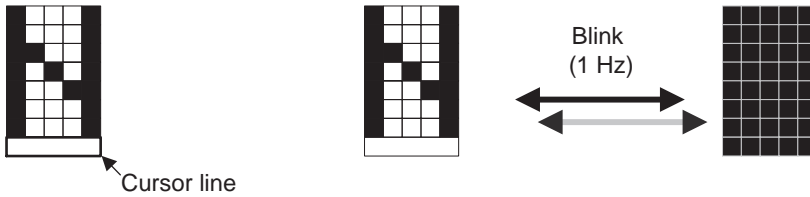

After reset:

DB ₇	DB ₆	DB ₅	DB ₄	DB ₃	DB ₂	DB ₁	DB ₀
0	0	0	0	1	0	0	0

10.5 Cursor or Display Shift

	RS	R,/W	DB ₇	DB ₆	DB ₅	DB ₄	DB ₃	DB ₂	DB ₁	DB ₀
Code	0	0	0	0	0	1	S/C	R/L	x	x

This instruction shifts the display and/or moves the cursor, one character to the left or right, without reading or writing to DDRAM.

The S/C bit selects movement of the cursor or movement of both the cursor and display.

S/C = 1: Shifts both the cursor and display.

S/C = 0: Shifts only the cursor.

The R/L bit selects whether to move the display and/or cursor to the left or right.

R/L = 1 : Shift one character to the right.

R/L = 0 : Shift one character to the left.

Table 10–2. Cursor or Display Shift

S/C	R/L	Cursor	Display
0	0	Moves one character to the left.	No shift.
0	1	Moves one character to the right.	No shift.
1	0	Moves one character to the left with the display.	Shifts one character to the left.
1	1	Moves one character to the right with the display.	Shifts one character to the right.

10.6 Function Setting

	RS	R,/W	DB ₇	DB ₆	DB ₅	DB ₄	DB ₃	DB ₂	DB ₁	DB ₀
Code	0	0	0	0	1	DL	N	x	BR1	BR0

This instruction sets the data length of the data bus line (when using the parallel interface, IM = H), the number of display lines and the brightness adjustment.

This instruction initializes the system, and must be the first instruction executed after power-on.

DL = 1: 8-bit CPU interface using DB₇ to DB₀

DL = 0: 4-bit CPU interface using DB₇ to DB₄

N = 0: Selects 1-line display (using anode outputs A1 to A40. A41 to A80 are fixed to low .).

N = 1: Selects 2-line display (using anode outputs A1 to A80).

The BR1, BR0 flags control the brightness of VFD by adjusting the to pulse width of the anode outputs as follows.

$t_{DSP} \cong 200 \mu s, t_{BLK} \cong 10 \mu s$

BR1	BR0	Brightness	tp
0	0	100 %	$t_{DSP} \times 1.00$
0	1	75 %	$t_{DSP} \times 0.75$
1	0	50 %	$t_{DSP} \times 0.50$
1	1	25 %	$t_{DSP} \times 0.25$

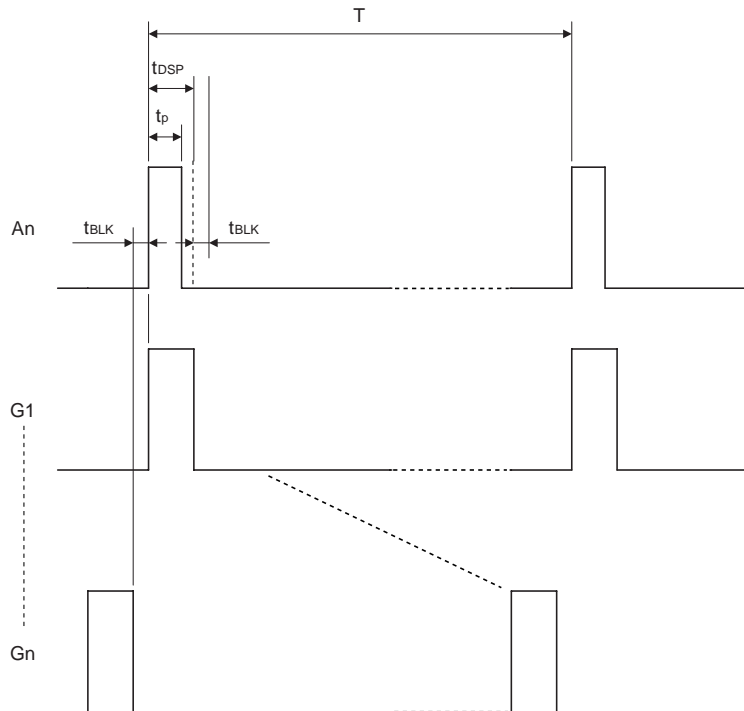

Remark n: Number of grids, $T = n \times (t_{DSP} + t_{BLK})$

After reset:

DB ₇	DB ₆	DB ₅	DB ₄	DB ₃	DB ₂	DB ₁	DB ₀
0	0	1	1	1	0	0	0

10.7 CGRAM Address Setting

	RS	R _i /W	DB ₇	DB ₆	DB ₅	DB ₄	DB ₃	DB ₂	DB ₁	DB ₀
Code	0	0	0	1	A	A	A	A	A	A

This instruction:

- (1) Loads a new 6-bit address into the address counter.
- (2) Sets the address counter to point to CGRAM.

Once the CGRAM data write instruction has been executed, the value of the address counter (AC) will be automatically incremented (+1) or decremented (-1), as determined by the entry mode setting instruction. The CGRAM address is moved from 3FH to 00H (+1, increment setting) or from 00H to 3FH (-1, decrement setting).

After reset: Don't care.

10.8 DDRAM address setting

	RS	R _i /W	DB ₇	DB ₆	DB ₅	DB ₄	DB ₃	DB ₂	DB ₁	DB ₀
Code	0	0	1	A	A	A	A	A	A	A

This instruction:

- (1) Loads a new 7-bit address into the address counter.
- (2) Sets the address counter to point to DDRAM.

Once the DDRAM address setting has been executed once, the contents of the address counter (AC) will be automatically incremented (+1) or decremented (-1) after every access of DDRAM, as determined by the entry mode setting instruction.

Table 10–3. Valid DDRAM Address Range

	Number of Characters	Address Range
1st line	40	00H to 27H
2nd line	40	40H to 67H

After reset: Don't care.

10.9 Reading Busy Flag and Address

	RS	R _i /W	DB ₇	DB ₆	DB ₅	DB ₄	DB ₃	DB ₂	DB ₁	DB ₀
Code	0	1	BF	A	A	A	A	A	A	A

This instruction reads the busy flag (BF)^{Note} and the value of the address counter in binary “AAAAAAA”. This address counter is used by the CGRAM and DDRAM addresses, and its value is determined by the previous instruction. The address counter contents are same as for the CGRAM address setting and DDRAM address setting instructions.

Note The busy flag (BF) always outputs 0.

10.10 Writing Data to CGRAM or DDRAM

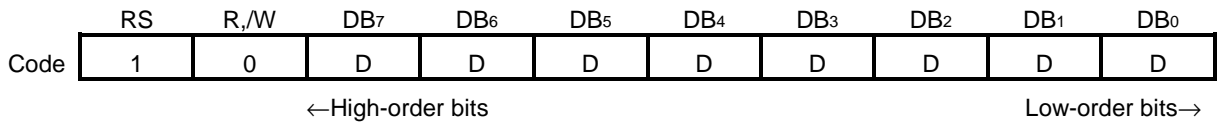

This instruction writes 8-bit binary data “DDDDDDDD” to CGRAM or DDRAM.

Whether to write to CGRAM or DDRAM is determined by the following instruction of CGRAM address setting or DDRAM address setting. After a data write, the value address is automatically incremented or decremented by 1 according to the entry mode set. The entry mode also determines the display shift.

10.11 Reading Data from CGRAM or DDRAM

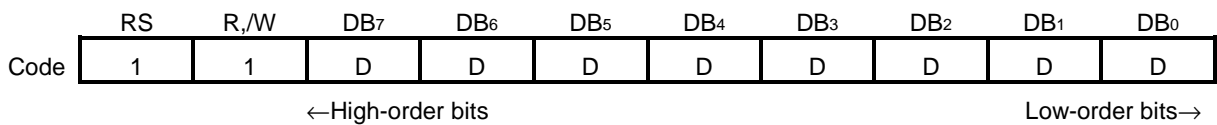

This instruction reads 8-bit binary data “DDDDDDDD” from CGRAM or DDRAM.

The previous specification determines whether CGRAM or DDRAM is to be read. Before entering this instruction, either the CGRAM address setting or the DDRAM address setting instruction must be executed. If neither is executed, the first read data is invalid, so when consecutively executing read instructions, the next address data is normally read from the second read. The address setting instructions do not need to be executed just before this read instruction, when the cursor is shifted by the cursor or display shift instruction (only when reading out data from DDRAM).

The operation of the cursor shift instruction is the same as the DDRAM address setting instruction. After reading one data, the value of the address is automatically incremented or decremented by 1 according to the entry mode selection.

Caution The address counter is automatically incremented or decremented by 1 after the data write instruction to CGRAM or DDRAM is executed. However, even if the contents of the RAM to be data read instruction is executed indicated by the address counter cannot be read.

Therefore, to read the data correctly, execute the address setting instruction or the cursor shift instruction (only in the case of DDRAM data read) just before reading, or, read from the second data in the case of executing the consecutive read data instruction.

10.12 Power On Reset

The Internal status of μ PD16314 is initialized as follows after the power supply is turned on.

- (1) Display clear: DDRAM is filled with 20H (space code).
- (2) The address counter is set to 00H.

The address counter is set to point to DDRAM.

- (3) Display ON/OFF: D = 0, C = 0, B = 0
- (4) Entry mode set: I/D = 1, S = 0
- (5) Function set: DL = 1, N = 1
- (6) Brightness adjustment: BR0 = BR1 = 0
- (7) The CPU interface and duty ratio selection are based on Table 10–4.

Table 10–4. Relationship between Status of μ PD16314 and Pin Selection at Power on Reset

Pin Name				Function	Remark
TEST	IM	DS1	DS0		
H	x	x	x	Self test mode	
L or open	L	x	x	Serial interface	SI,SO, SCK, STB used
L or open	H	x	x	Parallel interface	RS, E, R,/W, DB ₇ to DB ₄ , or DB ₇ to DB ₀ used
L or open	x	L	L	Duty = 1/16 (16C x 1 or 2L display)	The extension driver does not need to be used. The number of lines is selected by insutruccion.
L or open	x	L	H	Duty = 1/20 (20C x 1 or 2L display)	
L or open	x	H	L	Duty = 1/24 (24C x 1 or 2L display)	
L or open	x	H	H	Duty = 1/40 (40C x 1 or 2L display)	The extension driver should be used. The number of lines is selected by instruction.

Remark X: Don't care

11. EXAMPLE OF DATA TRANSFER (8-bit Parallel, Data Increment Mode)

Figure 11–1. Initialization and Data Setting Procedure

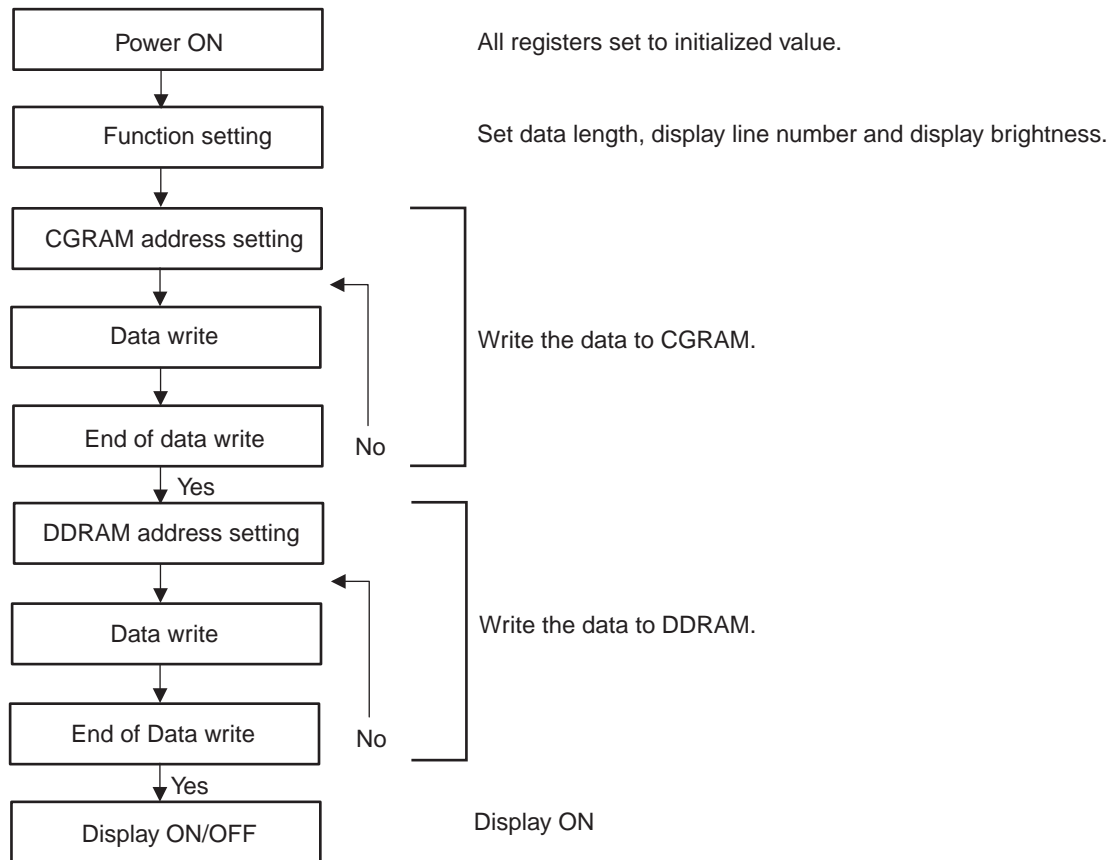

Table 11–1. Example of Initialization and Data Setting (M68 Series CPU)

RS	R,/W	D7	D6	D5	D4	D3	D2	D1	D0	
Power ON										
0	0	0	0	1	1	1	x	0	1	Function setting Data length: 8 bits, Display line number: 2 lines VFD brightness: 75%
0	0	0	1	0	0	0	0	0	0	CGRAM address set to 00H
1	0	x	x	x	D	D	D	D	D	Write data to CGRAM 64 bytes (8 characters)
		x	x	x	D	D	D	D	D	
		x	x	x	D	D	D	D	D	
0	0	1	0	0	0	0	0	0	0	DDRAM address set to 00H
1	0	D	D	D	D	D	D	D	D	Write data to DDRAM 80 bytes (80 characters)
		D	D	D	D	D	D	D	D	
		D	D	D	D	D	D	D	D	
0	0	0	0	0	0	1	1	0	0	Display ON, cursor OFF, cursor blink OFF

12. ELECTRICAL SPECIFICATIONS

Absolute Maximum Ratings (T_A = 25 °C, V_{SS1} = V_{SS2} = 0 V)

Parameter	Symbol	Rating	Unit	
Logic power supply voltage	V _{DD1}	-0.5 to +6.0	V	
Logic input voltage	V _I	-0.5 to V _{DD1} + 0.5	V	
Logic output voltage	V _{O1}	-0.5 to V _{DD1} + 0.5	V	
Driver power supply voltage	V _{DD2}	-0.5 to +60	V	
Driver output voltage	V _{O2}	-0.5 to V _{DD2} + 0.5	V	
Driver output current	Anode	I _{OL2A}	10	mA
		I _{OH2A}	-2	mA
	Grid	I _{OL2G}	15	mA
		I _{OH2G}	-20	mA
Allowable loss	P _D	1.2	W	
Operating ambient temperature	T _A	-40 to +85	°C	
Storage temperature	T _{stg}	-65 to +150	°C	

★
★

Caution Product quality may suffer if the absolute maximum rating is exceeded even momentarily for any parameter. That is, the absolute maximum ratings are rated values at which the product is on the verge of suffering physical damage, and therefore the product must be used under conditions that ensure that the absolute maximum ratings are not exceeded.

Recommended Operating Range (T_A = 25 °C, V_{SS1} = V_{SS2} = 0 V)

Parameter	Symbol	MIN.	TYP.	MAX.	Unit
Logic power supply voltage	V _{DD1}	2.7	5.0	5.5	V
Logic system input voltage	V _{IN}	0		V _{DD1}	V
Driver power supply voltage	V _{DD2}	20		50	V
Driver output current	Anode	I _{OL2A}		5	mA
		I _{OH2A}		-1	mA
	Grid	I _{OL2G}		8	mA
		I _{OH2G}		-15	mA

★
★

Remark NEC recommends that power is applied to the chipset in the order given below.

V_{DD1} → Input → V_{DD2}

When turning the power off, the reverse order should be applied.

Electrical Characteristics

(Unless otherwise specified, $T_A = -40$ to $+85$ °C, $V_{DD1} = 5.0$ V, $V_{DD2} = 50$ V, $V_{SS1} = V_{SS2} = 0$ V)

Parameter	Symbol	Conditions	MIN.	TYP.	MAX.	Unit
★ High-level input voltage 1	V_{IH1}	Logic, except E,SCK, /RESET, R,/W	$0.7 V_{DD1}$			V
★ Low-level input voltage 1	V_{IL1}	Logic, except E,SCK, /RESET, R,/W			$0.3 V_{DD1}$	V
★ High-level input voltage 2	V_{IH2}	E,SCK, /RESET, R,/W	$0.8 V_{DD1}$			V
★ Low-level input voltage 2	V_{IL2}	E,SCK, /RESET, R,/W			$0.2 V_{DD1}$	V
High-level output voltage (Logic)	V_{OH1}	DBn, SI,SO, SDO, SLK, LE, /CL $I_{O1L} = -0.1$ mA	$V_{DD1} - 0.5$			V
Low-level output voltage (Logic)	V_{OL1}	DBn, SI,SO, SDO, SLK, LE, /CL $I_{O1L} = 0.1$ mA			$V_{SS1} + 0.5$	V
High-level input current	I_{IH}	TEST, $V_{IN} = V_{DD1}$	20		500	μA
High-level leakage current	I_{LOH}	Logic, $V_{IN/OUT} = V_{DD1}$			1.0	μA
★ Low-level leakage current	I_{LOL}	Logic, except DBn, SI, SO			-1.0	μA
★ Pull-up MOS current	-I _p	DBn, SI, SO	30	125	280	μA
★ High-level output voltage (Driver)	V_{OH2A1}	A1 to A80, $I_{OH2} = -0.5$ mA	48			V
★	V_{OH2A2}	A1 to A80, $I_{OH2} = -1$ mA	46			V
★	V_{OH2G}	G1 to G24, $I_{OH2} = -15$ mA	45			V
Low-level output voltage (Driver)	V_{OL2}	A1 to A80, G1 to G24, $I_{OL2} = 1$ mA			5	V
★ Current consumption	I_{DD1}	Logic (no CPU access)			100	μA
	I_{DD2}	Driver			100	μA

Remark The TYP. value is a reference value when $T_A = 25$ °C.

Switching Characteristics (Unless otherwise specified, $T_A = -40$ to $+85$ °C, $V_{DD1} = 5.0$ V \pm 10 %)

Parameter	Symbol	Condition	MIN.	TYP.	MAX.	Unit
Oscillation frequency	f_{OSC}	$R = 56$ kΩ	392	560	728	kHZ
★ Oscillation frequency	f_c	OSC _{IN} external clock	350	560	750	kHZ
★ Rise time	T_{TLH1}	A1 to A80, $C_L = 50$ pF			2.5	μs
	T_{TLH2}	G1 to G24, $C_L = 50$ pF			0.25	μs
Fall time	T_{THL}	A1 to A80, G1 to G24, $C_L = 50$ pF			1.0	μs

Remark The TYP. value is a reference value when $T_A = 25$ °C.

Switching Timing

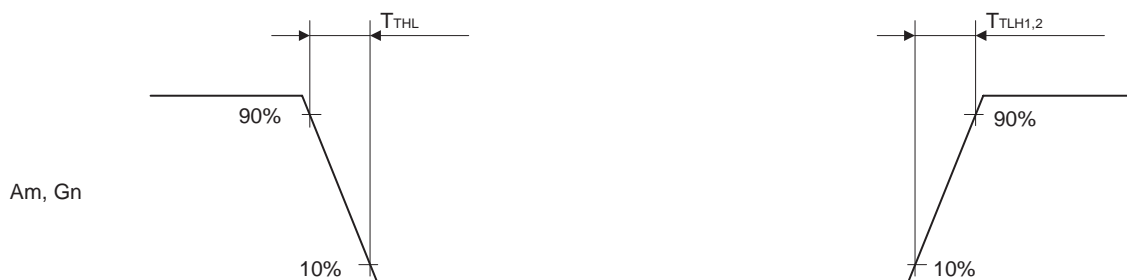

Required Conditions for Timing 1 (Unless otherwise specified, T_A = -40 to +85 °C)

Parallel data transfer (M68 interface): Write (V_{DD1} = 5.0 V ± 10 %)

Parameter	Symbol	Conditions	MIN.	TYP.	MAX.	Unit
Enable cycle time	t _{CYCE}	E ↑ → E ↑	500			ns
Enable "H" pulse width	PW _{EH}	E	230			ns
Enable "L" pulse width	PW _{EL}	E	230			ns
RS, R,/W - E setup time	t _{AS}	RS, R,/W → E ↑	20			ns
RS, R,/W - E hold time	t _{AH}	E ↓ → RS, R,/W	10			ns
Data setup time	t _{DS}	DATA → E ↑	80			ns
Data hold time	t _{DH}	E ↓ → DATA	10			ns
Reset pulse width	t _{WRE}		500			ns

Parallel data transfer (M68 interface): Read (V_{DD1} = 5.0 V ± 10 %)

Parameter	Symbol	Conditions	MIN.	TYP.	MAX.	Unit
Enable cycle time	t _{CYCE}	E ↑ → E ↑	500			ns
Enable "H" pulse width	PW _{EH}	E	230			ns
Enable "L" pulse width	PW _{EL}	E	230			ns
RS, R,/W - E setup time	t _{AS}	RS, R,/W → E ↑	20			ns
RS, R,/W - E hold time	t _{AH}	E ↓ → RS, R,/W	10			ns
Data delay time	t _{DD}	E ↑ → DATA			160	ns
Data hold time	t _{DHR}	E ↓ → DATA	5			ns

Parallel Interface (M68 input)

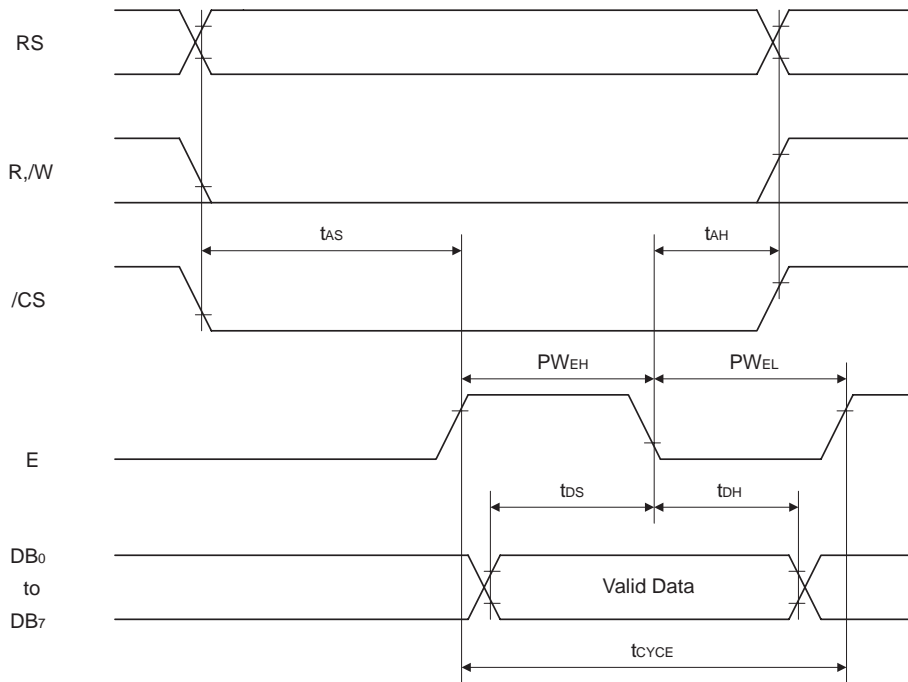

Parallel Interface (M68 output)

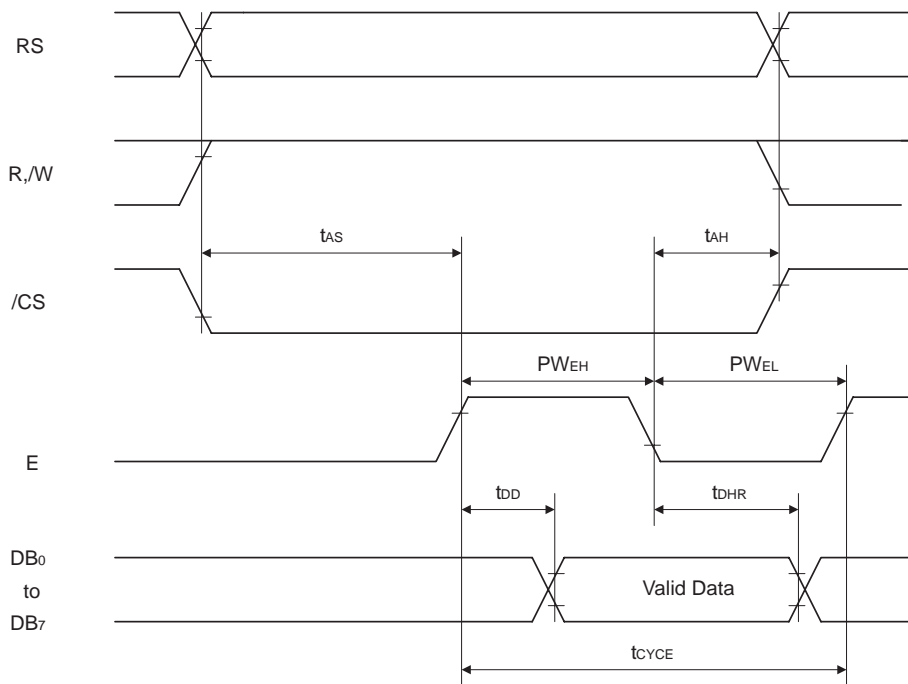

Remarks 1. The input signal rise time and fall time (t_r , t_f) is specified at 15 ns or less.

2. All timing is specified using 20 % and 80 % of V_{DD1} as the reference.

3. P_{WEH} is specified as the overlap between /CS being L and E.

Required Conditions for Timing 2 (Unless otherwise specified, T_A = -40 to +85 °C)

Parallel data transfer (i80 interface): Write (V_{DD1} = 5.0 V ± 10 %)

Parameter	Symbol	Conditions	MIN.	TYP.	MAX.	Unit
RS hold time	t _{RH8}	A0	10			ns
RS setup time	t _{RS8}	A0	10			ns
★ System cycle time	t _{CYC8}		200			ns
Control "L" pulse width(WR)	t _{CCLW}	/WR	30			ns
Control "L" pulse width(RD)	t _{CCLR}	/RD	70			ns
Control "H" pulse width(WR)	t _{CCHW}	/WR	100			ns
★ Control "H" pulse width(RD)	t _{CCHR}	/RD	100			ns
Data setup time	t _{DS8}	DB ₀ to DB ₇	30			ns
Data hold time	t _{DH8}	DB ₀ to DB ₇	10			ns
/RD access time	t _{ACC8}	DB ₀ to DB ₇ , C _L = 100 pF			70	ns
Output disable time	t _{OH8}	DB ₀ to DB ₇ , C _L = 100 pF	5			ns
Reset pulse width	t _{WRE}		500			ns

Parallel Interface (i80)

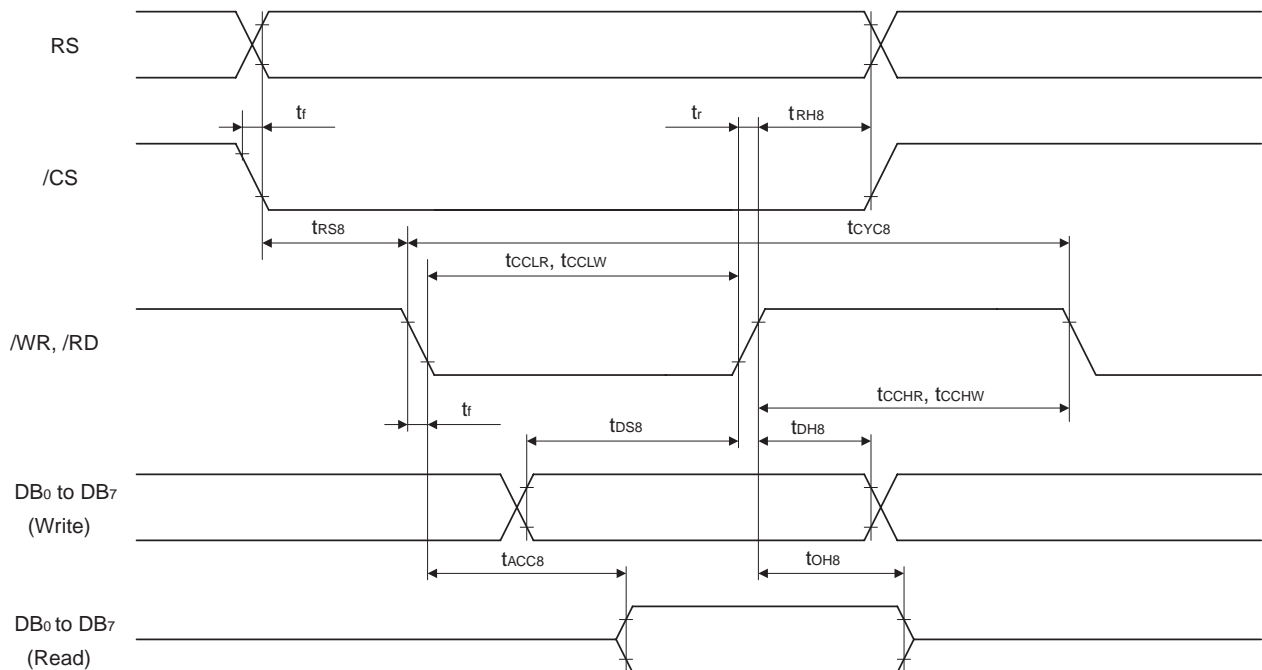

- Remarks**
1. The input signal rise time and fall time (t_r , t_f) is specified at 15 ns or less.
 2. All timing is specified using 20 % and 80 % of V_{DD1} as the reference.
 3. t_{CCLW} and t_{CCLR} are specified as the overlap between /CS being L and /WR and /RD being at the L level.

Required Conditions for Timing 3 (Unless otherwise specified, $T_A = -40$ to $+85$ °C)

Serial data transfer ($V_{DD1} = 5.0\text{ V} \pm 10\%$)

Parameter	Symbol	Conditions	MIN.	TYP.	MAX.	Unit
Shift clock cycle	t_{CYK}	SCK	500			ns
High-level shift clock pulse width	t_{WHK}	SCK	200			ns
Low-level shift clock pulse width	t_{WLK}	SCK	200			ns
Shift clock hold time	t_{HSTBK}	STB ↓ → SCK ↓	100			ns
Data setup time	t_{DS}	DATA → SCK ↑	100			ns
Data hold time	t_{DH}	SCK ↑ → DATA	100			ns
STB hold time	t_{DKSTB}	SCK ↑ → STB ↑	500			ns
STB pulse width	t_{WSTB}		500			ns
Wait time	t_{WAIT}	8th CLK ↑ → 1st CLK ↓	1			μs
Output data delay time	t_{ODD}	STB ↓ → DATA			150	ns
Output data hold time	t_{ODH}	SCK ↑ → DATA	5			ns
Reset pulse width	t_{WRE}		500			ns

Serial Interface (Input)

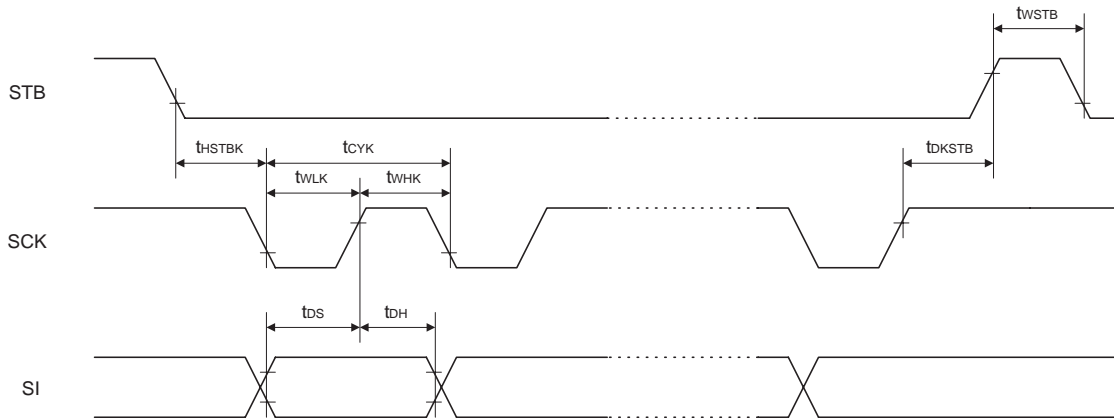

Serial Interface (Output)

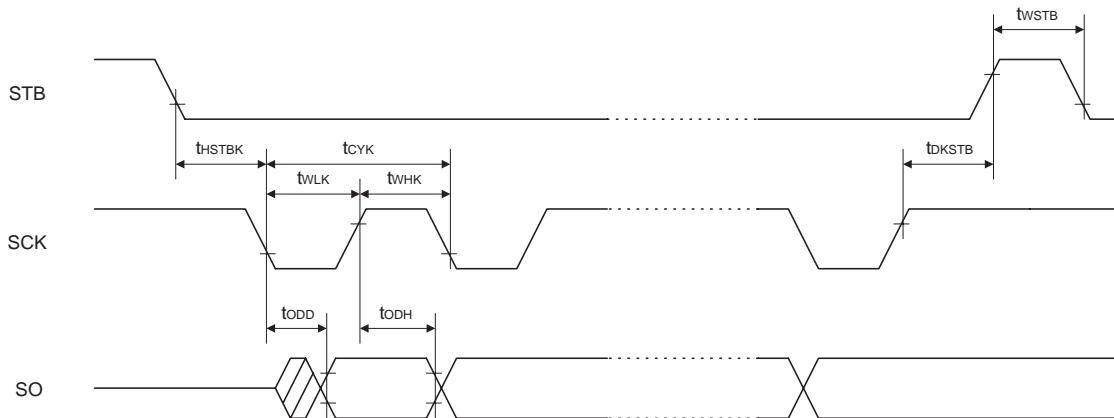

- Remarks 1. The input signal rise time and fall time (t_r , t_f) is specified at 15 ns or less.
- 2. All timing is specified using 20 % and 80 % of V_{DD1} as the reference.

AC Measurement Point

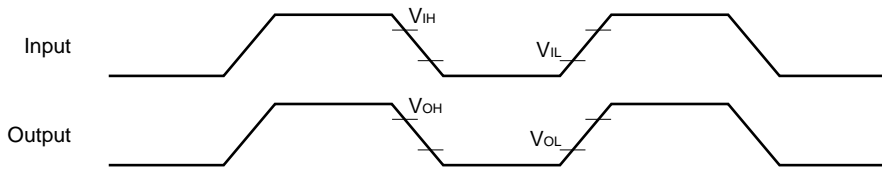

Reset

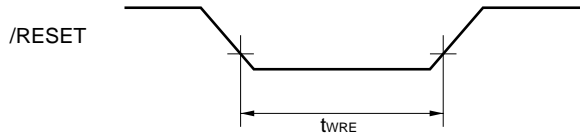

Required Conditions for Timing 4 (Unless otherwise specified, $T_A = -40$ to $+85$ °C)

Common timing (M68, i80, serial interface): Power ON reset ($V_{DD1} = 5.0 \text{ V} \pm 10\%$)

Parameter	Symbol	Conditions	MIN.	TYP.	MAX.	Unit
Resetting time	t_{RES}	V_{DD}	100			μs
V_{DD} rising time	t_{rDD}	V_{DD}	1			μs
V_{DD} OFF width	t_{OFF}	V_{DD}	1			ms

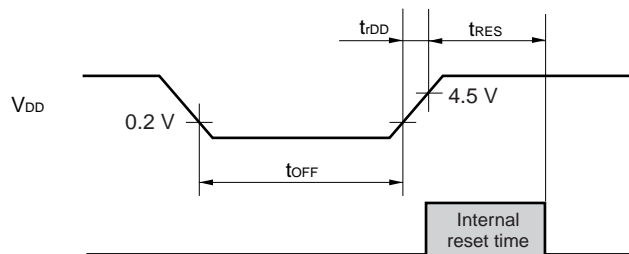

13. PACKAGE DRAWING

144-PIN PLASTIC LQFP (FINE PITCH) (20×20)

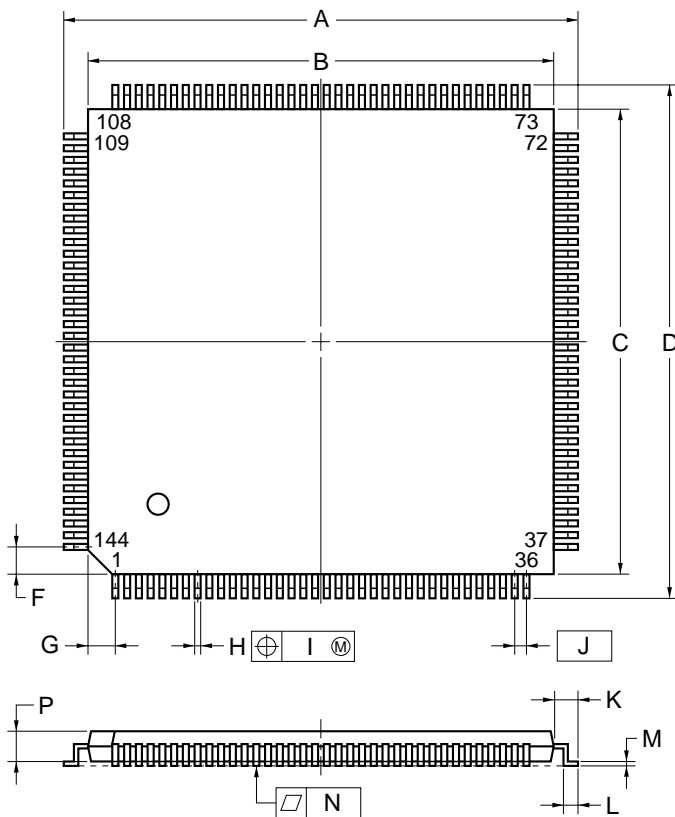

Detail of lead end

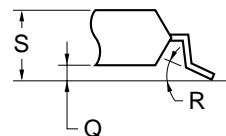

NOTE

Each lead centerline is located within 0.10 mm (0.004 inch) of its true position (T.P.) at maximum material condition.

ITEM	MILLIMETERS	INCHES
A	22.0±0.2	0.866±0.008
B	20.0±0.2	0.787 ^{+0.009} _{-0.008}
C	20.0±0.2	0.787 ^{+0.009} _{-0.008}
D	22.0±0.2	0.866±0.008
F	1.25	0.049
G	1.25	0.049
H	0.22 ^{+0.05} _{-0.04}	0.009±0.002
I	0.10	0.004
J	0.5 (T.P.)	0.020 (T.P.)
K	1.0±0.2	0.039 ^{+0.009} _{-0.008}
L	0.5±0.2	0.020 ^{+0.008} _{-0.009}
M	0.145 ^{+0.055} _{-0.045}	0.006±0.002
N	0.10	0.004
P	1.4±0.1	0.055±0.004
Q	0.125±0.075	0.005±0.003
R	3 ⁺⁷ ₋₃	3 ⁺⁷ ₋₃
S	1.7 MAX.	0.067 MAX.

S144GJ-50-8EU-2

★ 14. SOLDERING CONDITIONS

Solder the product under the following recommended conditions.

For details of the recommended soldering conditions, refer to information Document **Semiconductor Device Mounting Technology Manual (C10535E)**.

For soldering methods and soldering conditions other than those recommended, please contact an NEC salesperson.

Surface Mount Type

μ PD16314GJ-001-8EU: 144-PIN PLASTIC LQFP (20x20 mm)

Soldering Method	Soldering Condition	Symbol of Recommended Soldering Condition
Infrared reflow	Package peak temperature: 235 °C, Time: 30 seconds MAX. (210 °C MIN.), Number of times: 3 MAX. <Precaution> Products other than in heat-resistant trays (such as those packaged in a magazine, taping, or non-thermal-resistant tray) cannot be baked in their package.	IR35-103-3
VPS	Package peak temperature: 215 °C, Time: 40 seconds MAX. (200 °C MIN.), Number of times: 3 MAX. <Precaution> Products other than in heat-resistant trays (such as those packaged in a magazine, taping, or non-thermal-resistant tray) cannot be baked in their package.	VP15-103-3
Wave soldering	Solder path temperature: 260 °C MAX., Time: 10 seconds MAX., Number of times:1, Preheating temperature: 120 °C MAX. (Package surface)	WS-60-103-1
Partial heating	Pin temperature: 300 °C MAX., Time: 3 seconds MAX. (per side of device)	—

Caution Do not use two or more soldering methods in combination (except the partial heating method).

[MEMO]

NOTES FOR CMOS DEVICES

① PRECAUTION AGAINST ESD FOR SEMICONDUCTORS

Note:

Strong electric field, when exposed to a MOS device, can cause destruction of the gate oxide and ultimately degrade the device operation. Steps must be taken to stop generation of static electricity as much as possible, and quickly dissipate it once, when it has occurred. Environmental control must be adequate. When it is dry, humidifier should be used. It is recommended to avoid using insulators that easily build static electricity. Semiconductor devices must be stored and transported in an anti-static container, static shielding bag or conductive material. All test and measurement tools including work bench and floor should be grounded. The operator should be grounded using wrist strap. Semiconductor devices must not be touched with bare hands. Similar precautions need to be taken for PW boards with semiconductor devices on it.

② HANDLING OF UNUSED INPUT PINS FOR CMOS

Note:

No connection for CMOS device inputs can be cause of malfunction. If no connection is provided to the input pins, it is possible that an internal input level may be generated due to noise, etc., hence causing malfunction. CMOS devices behave differently than Bipolar or NMOS devices. Input levels of CMOS devices must be fixed high or low by using a pull-up or pull-down circuitry. Each unused pin should be connected to V_{DD} or GND with a resistor, if it is considered to have a possibility of being an output pin. All handling related to the unused pins must be judged device by device and related specifications governing the devices.

③ STATUS BEFORE INITIALIZATION OF MOS DEVICES

Note:

Power-on does not necessarily define initial status of MOS device. Production process of MOS does not define the initial operation status of the device. Immediately after the power source is turned ON, the devices with reset function have not yet been initialized. Hence, power-on does not guarantee out-pin levels, I/O settings or contents of registers. Device is not initialized until the reset signal is received. Reset operation must be executed immediately after power-on for devices having reset function.

- **The information in this document is subject to change without notice. Before using this document, please confirm that this is the latest version.**
 - No part of this document may be copied or reproduced in any form or by any means without the prior written consent of NEC Corporation. NEC Corporation assumes no responsibility for any errors which may appear in this document.
 - NEC Corporation does not assume any liability for infringement of patents, copyrights or other intellectual property rights of third parties by or arising from use of a device described herein or any other liability arising from use of such device. No license, either express, implied or otherwise, is granted under any patents, copyrights or other intellectual property rights of NEC Corporation or others.
 - Descriptions of circuits, software, and other related information in this document are provided for illustrative purposes in semiconductor product operation and application examples. The incorporation of these circuits, software, and information in the design of the customer's equipment shall be done under the full responsibility of the customer. NEC Corporation assumes no responsibility for any losses incurred by the customer or third parties arising from the use of these circuits, software, and information.
 - While NEC Corporation has been making continuous effort to enhance the reliability of its semiconductor devices, the possibility of defects cannot be eliminated entirely. To minimize risks of damage or injury to persons or property arising from a defect in an NEC semiconductor device, customers must incorporate sufficient safety measures in its design, such as redundancy, fire-containment, and anti-failure features.
 - NEC devices are classified into the following three quality grades:
"Standard", "Special", and "Specific". The Specific quality grade applies only to devices developed based on a customer designated "quality assurance program" for a specific application. The recommended applications of a device depend on its quality grade, as indicated below. Customers must check the quality grade of each device before using it in a particular application.
 - Standard: Computers, office equipment, communications equipment, test and measurement equipment, audio and visual equipment, home electronic appliances, machine tools, personal electronic equipment and industrial robots
 - Special: Transportation equipment (automobiles, trains, ships, etc.), traffic control systems, anti-disaster systems, anti-crime systems, safety equipment and medical equipment (not specifically designed for life support)
 - Specific: Aircraft, aerospace equipment, submersible repeaters, nuclear reactor control systems, life support systems or medical equipment for life support, etc.
- The quality grade of NEC devices is "Standard" unless otherwise specified in NEC's Data Sheets or Data Books. If customers intend to use NEC devices for applications other than those specified for Standard quality grade, they should contact an NEC sales representative in advance.