

To our customers,

---

## Old Company Name in Catalogs and Other Documents

---

On April 1<sup>st</sup>, 2010, NEC Electronics Corporation merged with Renesas Technology Corporation, and Renesas Electronics Corporation took over all the business of both companies. Therefore, although the old company name remains in this document, it is a valid Renesas Electronics document. We appreciate your understanding.

Renesas Electronics website: <http://www.renesas.com>

April 1<sup>st</sup>, 2010  
Renesas Electronics Corporation

Issued by: Renesas Electronics Corporation (<http://www.renesas.com>)

Send any inquiries to <http://www.renesas.com/inquiry>.

Not recommended  
for new design

## Notice

1. All information included in this document is current as of the date this document is issued. Such information, however, is subject to change without any prior notice. Before purchasing or using any Renesas Electronics products listed herein, please confirm the latest product information with a Renesas Electronics sales office. Also, please pay regular and careful attention to additional and different information to be disclosed by Renesas Electronics such as that disclosed through our website.
2. Renesas Electronics does not assume any liability for infringement of patents, copyrights, or other intellectual property rights of third parties by or arising from the use of Renesas Electronics products or technical information described in this document. No license, express, implied or otherwise, is granted hereby under any patents, copyrights or other intellectual property rights of Renesas Electronics or others.
3. You should not alter, modify, copy, or otherwise misappropriate any Renesas Electronics product, whether in whole or in part.
4. Descriptions of circuits, software and other related information in this document are provided only to illustrate the operation of semiconductor products and application examples. You are fully responsible for the incorporation of these circuits, software, and information in the design of your equipment. Renesas Electronics assumes no responsibility for any losses incurred by you or third parties arising from the use of these circuits, software, or information.
5. When exporting the products or technology described in this document, you should comply with the applicable export control laws and regulations and follow the procedures required by such laws and regulations. You should not use Renesas Electronics products or the technology described in this document for any purpose relating to military applications or use by the military, including but not limited to the development of weapons of mass destruction. Renesas Electronics products and technology may not be used for or incorporated into any products or systems whose manufacture, use, or sale is prohibited under any applicable domestic or foreign laws or regulations.
6. Renesas Electronics has used reasonable care in preparing the information included in this document, but Renesas Electronics does not warrant that such information is error free. Renesas Electronics assumes no liability whatsoever for any damages incurred by you resulting from errors in or omissions from the information included herein.
7. Renesas Electronics products are classified according to the following three quality grades: “Standard”, “High Quality”, and “Specific”. The recommended applications for each Renesas Electronics product depends on the product’s quality grade, as indicated below. You must check the quality grade of each Renesas Electronics product before using it in a particular application. You may not use any Renesas Electronics product for any application categorized as “Specific” without the prior written consent of Renesas Electronics. Further, you may not use any Renesas Electronics product for any application for which it is not intended without the prior written consent of Renesas Electronics. Renesas Electronics shall not be in any way liable for any damages or losses incurred by you or third parties arising from the use of any Renesas Electronics product for an application categorized as “Specific” or for which the product is not intended where you have failed to obtain the prior written consent of Renesas Electronics. The quality grade of each Renesas Electronics product is “Standard” unless otherwise expressly specified in a Renesas Electronics data sheets or data books, etc.
  - “Standard”: Computers; office equipment; communications equipment; test and measurement equipment; audio and visual equipment; home electronic appliances; machine tools; personal electronic equipment; and industrial robots.
  - “High Quality”: Transportation equipment (automobiles, trains, ships, etc.); traffic control systems; anti-disaster systems; anti-crime systems; safety equipment; and medical equipment not specifically designed for life support.
  - “Specific”: Aircraft; aerospace equipment; submersible repeaters; nuclear reactor control systems; medical equipment or systems for life support (e.g. artificial life support devices or systems), surgical implantations, or healthcare intervention (e.g. excision, etc.), and any other applications or purposes that pose a direct threat to human life.
8. You should use the Renesas Electronics products described in this document within the range specified by Renesas Electronics, especially with respect to the maximum rating, operating supply voltage range, movement power voltage range, heat radiation characteristics, installation and other product characteristics. Renesas Electronics shall have no liability for malfunctions or damages arising out of the use of Renesas Electronics products beyond such specified ranges.
9. Although Renesas Electronics endeavors to improve the quality and reliability of its products, semiconductor products have specific characteristics such as the occurrence of failure at a certain rate and malfunctions under certain use conditions. Further, Renesas Electronics products are not subject to radiation resistance design. Please be sure to implement safety measures to guard them against the possibility of physical injury, and injury or damage caused by fire in the event of the failure of a Renesas Electronics product, such as safety design for hardware and software including but not limited to redundancy, fire control and malfunction prevention, appropriate treatment for aging degradation or any other appropriate measures. Because the evaluation of microcomputer software alone is very difficult, please evaluate the safety of the final products or system manufactured by you.
10. Please contact a Renesas Electronics sales office for details as to environmental matters such as the environmental compatibility of each Renesas Electronics product. Please use Renesas Electronics products in compliance with all applicable laws and regulations that regulate the inclusion or use of controlled substances, including without limitation, the EU RoHS Directive. Renesas Electronics assumes no liability for damages or losses occurring as a result of your noncompliance with applicable laws and regulations.
11. This document may not be reproduced or duplicated, in any form, in whole or in part, without prior written consent of Renesas Electronics.
12. Please contact a Renesas Electronics sales office if you have any questions regarding the information contained in this document or Renesas Electronics products, or if you have any other inquiries.

(Note 1) “Renesas Electronics” as used in this document means Renesas Electronics Corporation and also includes its majority-owned subsidiaries.

(Note 2) “Renesas Electronics product(s)” means any product developed or manufactured by or for Renesas Electronics.

**SILICON MMIC LOW CURRENT AMPLIFIER  
FOR MOBILE COMMUNICATIONS**
**DESCRIPTION**

The μPC8178TB is a silicon monolithic integrated circuit designed as amplifier for mobile communications. This IC can realize low current consumption with external chip inductor which can not be realized on internal 50 Ω wideband matched IC. This low current amplifier operates on 3.0 V.

This IC is manufactured using NEC's 30 GHz  $f_{max}$  UHS0 (Ultra High Speed Process) silicon bipolar process. This process uses direct silicon nitride passivation film and gold electrodes. These materials can protect the chip surface from pollution and prevent corrosion/migration. Thus, this IC has excellent performance, uniformity and reliability.

**FEATURES**

- Low current consumption :  $I_{CC} = 1.9$  mA TYP. @  $V_{CC} = 3.0$  V
- Supply voltage :  $V_{CC} = 2.4$  to 3.3 V
- Excellent isolation : ISL = 39 dB TYP. @  $f = 1.0$  GHz  
ISL = 40 dB TYP. @  $f = 1.9$  GHz  
ISL = 38 dB TYP. @  $f = 2.4$  GHz
- Power gain :  $G_P = 11.0$  dB TYP. @  $f = 1.0$  GHz  
 $G_P = 11.5$  dB TYP. @  $f = 1.9$  GHz  
 $G_P = 11.5$  dB TYP. @  $f = 2.4$  GHz
- Gain 1 dB compression output power:  $P_{O(1\text{ dB})} = -4.0$  dBm TYP. @  $f = 1.0$  GHz  
 $P_{O(1\text{ dB})} = -7.0$  dBm TYP. @  $f = 1.9$  GHz  
 $P_{O(1\text{ dB})} = -7.5$  dBm TYP. @  $f = 2.4$  GHz
- Operating frequency : 0.1 to 2.4 GHz (Output port LC matching)
- High-density surface mounting : 6-pin super minimold package (2.0 × 1.25 × 0.9 mm)
- Low weight : 7 mg (Standard value)

**APPLICATION**

- Buffer amplifiers on 0.1 to 2.4 GHz mobile communications system

**Caution Electro-static sensitive devices**

The information in this document is subject to change without notice. Before using this document, please confirm that this is the latest version.  
Not all devices/types available in every country. Please check with local NEC representative for availability and additional information.

**ORDERING INFORMATION**

Part Number	Package	Marking	Supplying Form
μPC8178TB-E3	6-pin super minimold	C3B	Embossed tape 8 mm wide. 1, 2, 3 pins face the perforation side of the tape. Qty 3 kpcs/reel.

**Remark** To order evaluation samples, please contact your local NEC sales office.  
(Part number for sample order: μPC8178TB)

**PIN CONNECTIONS**

(Top View)

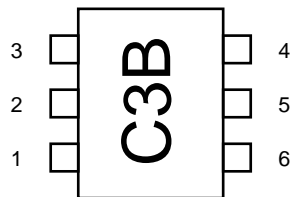

(Bottom View)

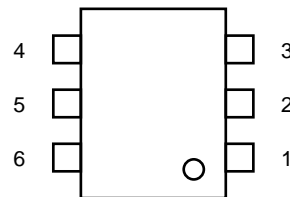

Pin No.	Pin Name
1	INPUT
2	GND
3	GND
4	OUTPUT
5	GND
6	V <sub>cc</sub>

Not recommended for new design

**PRODUCT LINE-UP** ( $T_A = +25^\circ\text{C}$ ,  $V_{CC} = V_{out} = 3.0\text{ V}$ ,  $Z_s = Z_L = 50\ \Omega$ )

Parameter Part No.	I <sub>cc</sub> (mA)	1.0 GHz output port matching frequency			1.66 GHz output port matching frequency			1.9 GHz output port matching frequency			2.4 GHz output port matching frequency			Marking
		G <sub>P</sub> (dB)	ISL (dB)	P <sub>O(1dB)</sub> (dBm)	G <sub>P</sub> (dB)	ISL (dB)	P <sub>O(1dB)</sub> (dBm)	G <sub>P</sub> (dB)	ISL (dB)	P <sub>O(1dB)</sub> (dBm)	G <sub>P</sub> (dB)	ISL (dB)	P <sub>O(1dB)</sub> (dBm)	
μPC8178TB	1.9	11	39	-4.0	-	-	-	11.5	40	-7.0	11.5	38	-7.5	C3B
μPC8179TB	4.0	13.5	44	+3.0	-	-	-	15.5	42	+1.5	15.5	41	+1.0	C3C
μPC8128TB	2.8	12.5	39	-4.0	13	39	-4.0	13	37	-4.0	-	-	-	C2P
μPC8151TB	4.2	12.5	38	+2.5	15	36	+1.5	15	34	+0.5	-	-	-	C2U
μPC8152TB	5.6	23	40	-4.5	19.5	38	-8.5	17.5	35	-8.5	-	-	-	C2V

**Remark** Typical performance. Please refer to ELECTRICAL CHARACTERISTICS in detail.

**SYSTEM APPLICATION EXAMPLE**

Location examples in digital cellular

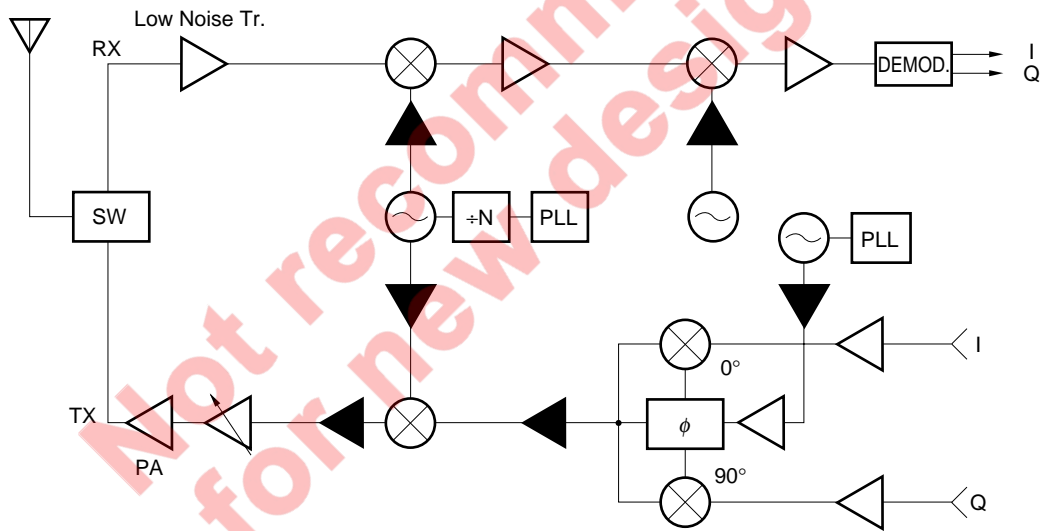

These ICs can be added to your system around ▲ parts, when you need more isolation or gain. The application herein, however, shows only examples, therefore the application can depend on your kit evaluation.

**PIN EXPLANATION**

Pin No.	Pin Name	Applied Voltage (V)	Pin Voltage (V) <sup>Note</sup>	Function and Applications	Internal Equivalent Circuit
1	INPUT	–	0.91	Signal input pin. A internal matching circuit, configured with resistors, enables 50 Ω connection over a wide band. This pin must be coupled to signal source with capacitor for DC cut.	
2 3 5	GND	0	–	Ground pin. This pin should be connected to system ground with minimum inductance. Ground pattern on the board should be formed as wide as possible. All the ground pins must be connected together with wide ground pattern to decrease impedance difference.	
4	OUTPUT	voltage as same as V <sub>cc</sub> through external inductor	–	Signal output pin. This pin is designed as collector output. Due to the high impedance output, this pin should be externally equipped with LC matching circuit to next stage. For L, a size 1005 chip inductor can be chosen.	
6	V <sub>cc</sub>	2.4 to 3.3	–	Power supply pin. This pin should be externally equipped with bypass capacitor to minimize its impedance.	

**Note** Pin voltage is measured at V<sub>cc</sub> = 3.0 V.

**ABSOLUTE MAXIMUM RATINGS**

Parameter	Symbol	Conditions	Ratings	Unit
Supply Voltage	V <sub>CC</sub>	T <sub>A</sub> = +25°C, Pin 4, Pin 6	3.6	V
Circuit Current	I <sub>CC</sub>	T <sub>A</sub> = +25°C	15	mA
Power Dissipation	P <sub>D</sub>	Mounted on double sided copper clad 50 × 50 × 1.6 mm epoxy glass PWB (T <sub>A</sub> = +85°C)	270	mW
Operating Ambient Temperature	T <sub>A</sub>		-40 to +85	°C
Storage Temperature	T <sub>stg</sub>		-55 to +150	°C
Input Power	P <sub>in</sub>	T <sub>A</sub> = +25°C	+5	dBm

**RECOMMENDED OPERATING CONDITIONS**

Parameter	Symbol	MIN.	TYP.	MAX.	Unit	Remarks
Supply Voltage	V <sub>CC</sub>	2.4	3.0	3.3	V	The same voltage should be applied to pin 4 and pin 6.
Operating Ambient Temperature	T <sub>A</sub>	-40	+25	+85	°C	

★ **ELECTRICAL CHARACTERISTICS**

(Unless otherwise specified, T<sub>A</sub> = +25°C, V<sub>CC</sub> = V<sub>out</sub> = 3.0 V, Z<sub>s</sub> = Z<sub>L</sub> = 50 Ω, at LC matched frequency)

Parameter	Symbol	Conditions	MIN.	TYP.	MAX.	Unit
Circuit Current	I <sub>CC</sub>	No signal	1.4	1.9	2.4	mA
Power Gain	G <sub>P</sub>	f = 1.0 GHz, P <sub>in</sub> = -30 dBm f = 1.9 GHz, P <sub>in</sub> = -30 dBm f = 2.4 GHz, P <sub>in</sub> = -30 dBm	9.0 9.0 9.0	11.0 11.5 11.5	13.0 13.5 13.5	dB
Isolation	ISL	f = 1.0 GHz, P <sub>in</sub> = -30 dBm f = 1.9 GHz, P <sub>in</sub> = -30 dBm f = 2.4 GHz, P <sub>in</sub> = -30 dBm	34 35 33	39 40 38	- - -	dB
Gain 1 dB Compression Output Power	P <sub>O(1dB)</sub>	f = 1.0 GHz f = 1.9 GHz f = 2.4 GHz	-8.0 -11.0 -11.5	-4.0 -7.0 -7.5	- - -	dBm
Noise Figure	NF	f = 1.0 GHz f = 1.9 GHz f = 2.4 GHz	- - -	5.5 5.5 5.5	7.0 7.0 7.0	dB
Input Return Loss	RL <sub>in</sub>	f = 1.0 GHz, P <sub>in</sub> = -30 dBm f = 1.9 GHz, P <sub>in</sub> = -30 dBm f = 2.4 GHz, P <sub>in</sub> = -30 dBm	4 5 6.5	7 8 9.5	- - -	dB

TEST CIRCUITS

★ <1>  $f = 1.0 \text{ GHz}$

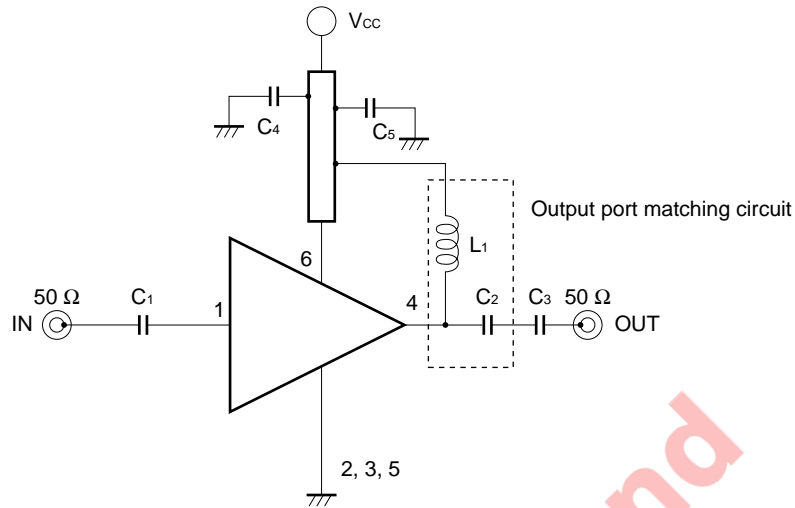

<2>  $f = 1.9 \text{ GHz}$

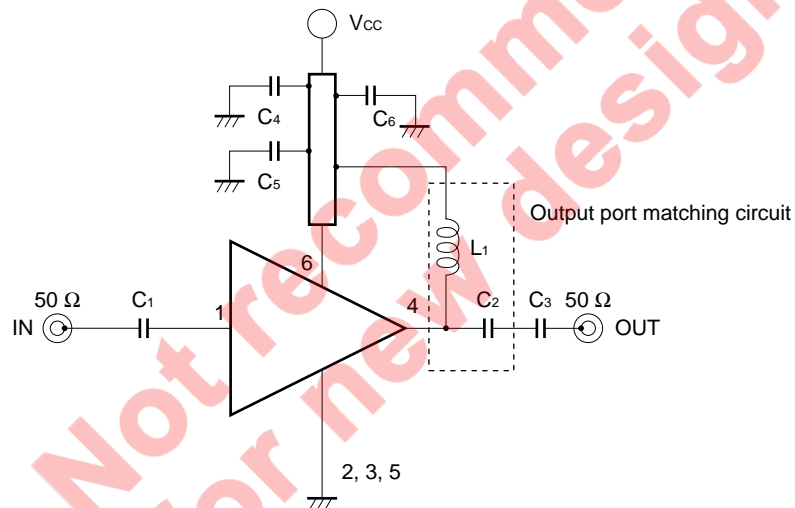

<3>  $f = 2.4 \text{ GHz}$

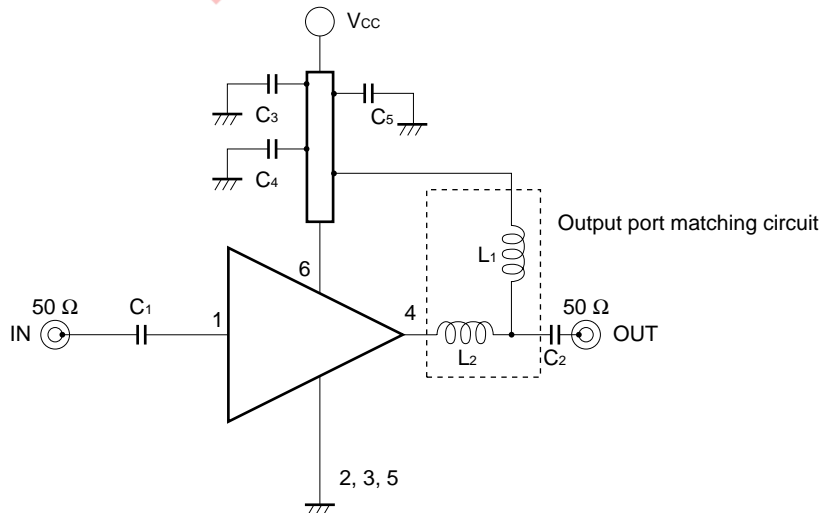
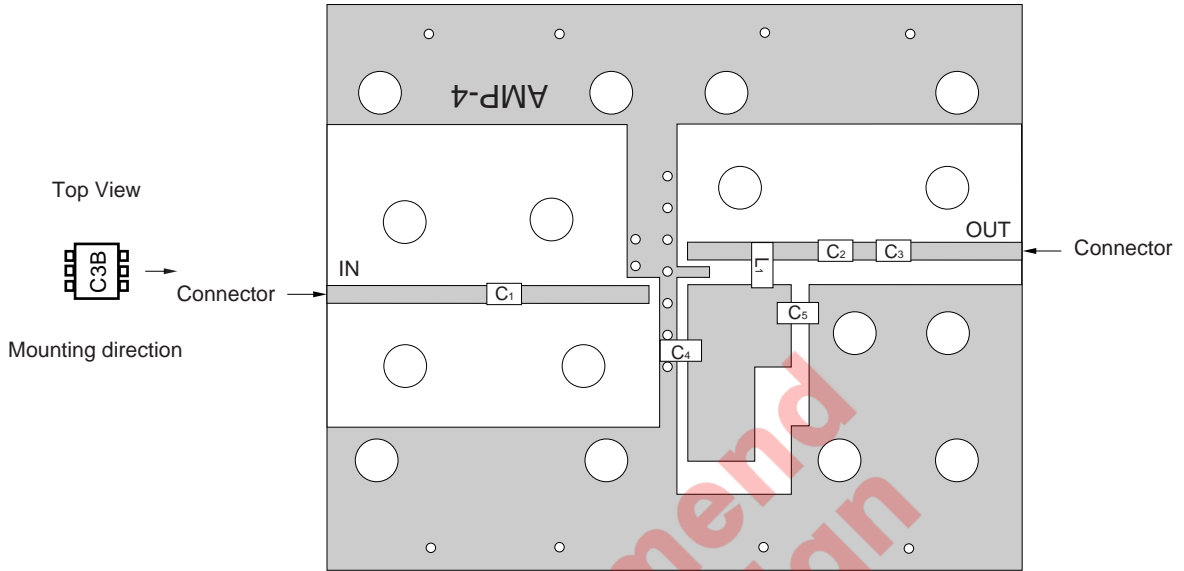



ILLUSTRATION OF THE TEST CIRCUIT ASSEMBLED ON EVALUATION BOARD

<1>  $f = 1.0 \text{ GHz}$



COMPONENT LIST

1.0 GHz Output Port Matching	
C <sub>1</sub> , C <sub>3</sub> , C <sub>5</sub>	1 000 pF
C <sub>2</sub>	0.75 pF
C <sub>4</sub>	10 pF
L <sub>1</sub>	12 nH

<2> f = 1.9 GHz

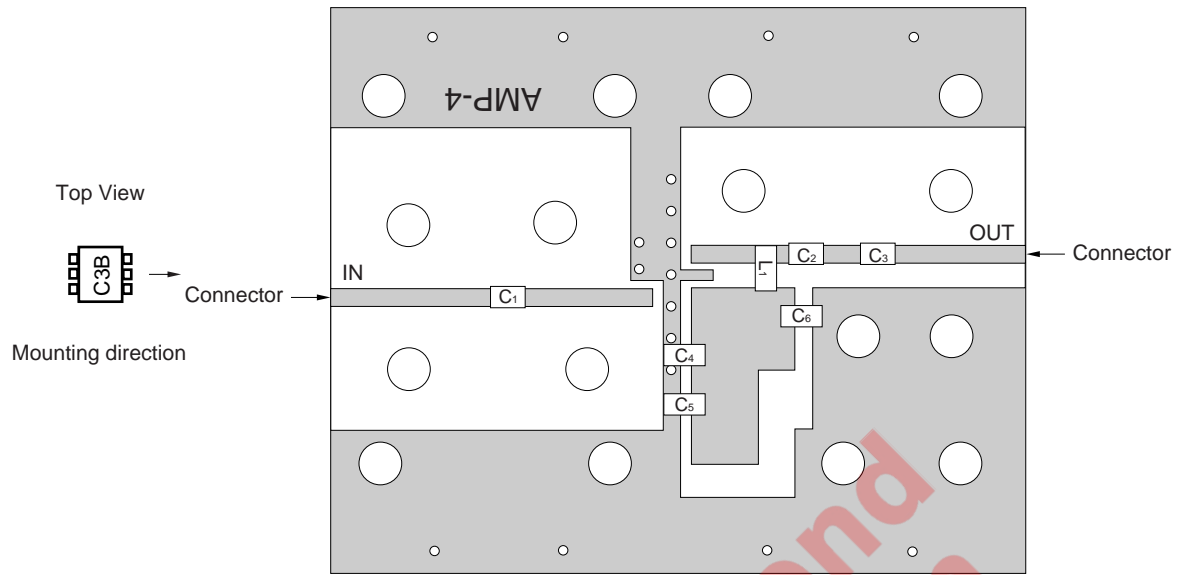

**COMPONENT LIST**

1.9 GHz Output Port Matching	
C1, C3, C5, C6	1 000 pF
C2	0.5 pF
C4	10 pF
L1	3.9 nH

*Not recommended for new design*

<3> f = 2.4 GHz

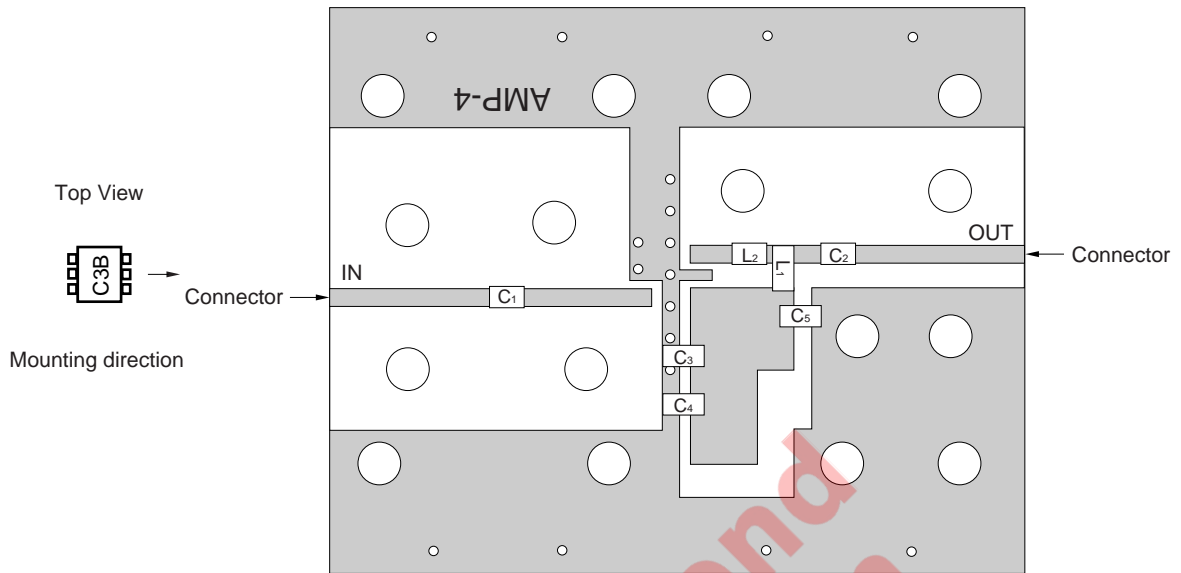

**COMPONENT LIST**

2.4 GHz Output Port Matching	
C <sub>1</sub> , C <sub>2</sub> , C <sub>4</sub> , C <sub>5</sub>	1 000 pF
C <sub>3</sub>	10 pF
L <sub>1</sub>	1.8 nH
L <sub>2</sub>	2.7 nH

**NOTES**

- (\*1) 42 × 35 × 0.4 mm double sided copper clad polyimide board
- (\*2) Solder plated on pattern
- (\*3) Back side: GND pattern
- (\*4) ○ ○ : Through holes

★ TYPICAL CHARACTERISTICS (Unless otherwise specified,  $T_A = +25^\circ\text{C}$ )

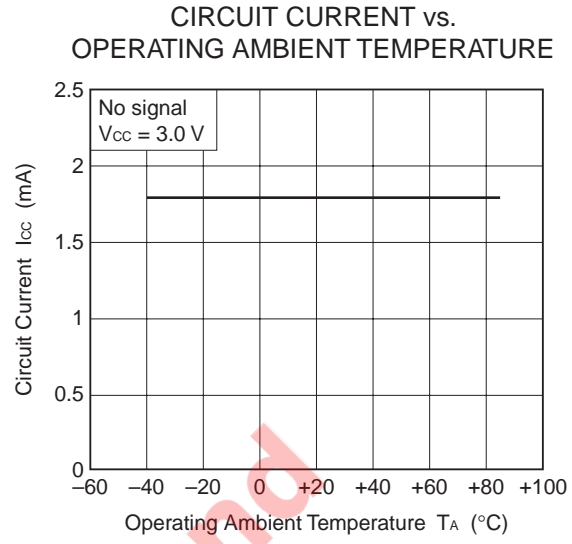
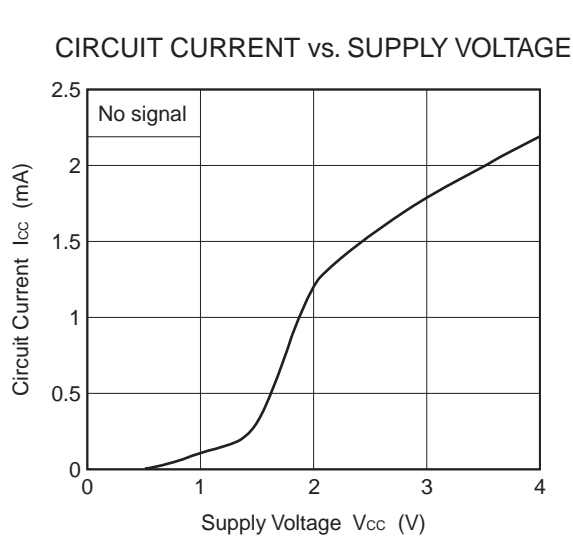

Not recommended for new design

1.0 GHz OUTPUT PORT MATCHING

S-PARAMETERS (monitored at connector on board)

T<sub>A</sub> = +25°C , V<sub>CC</sub> = V<sub>out</sub> = 3.0 V

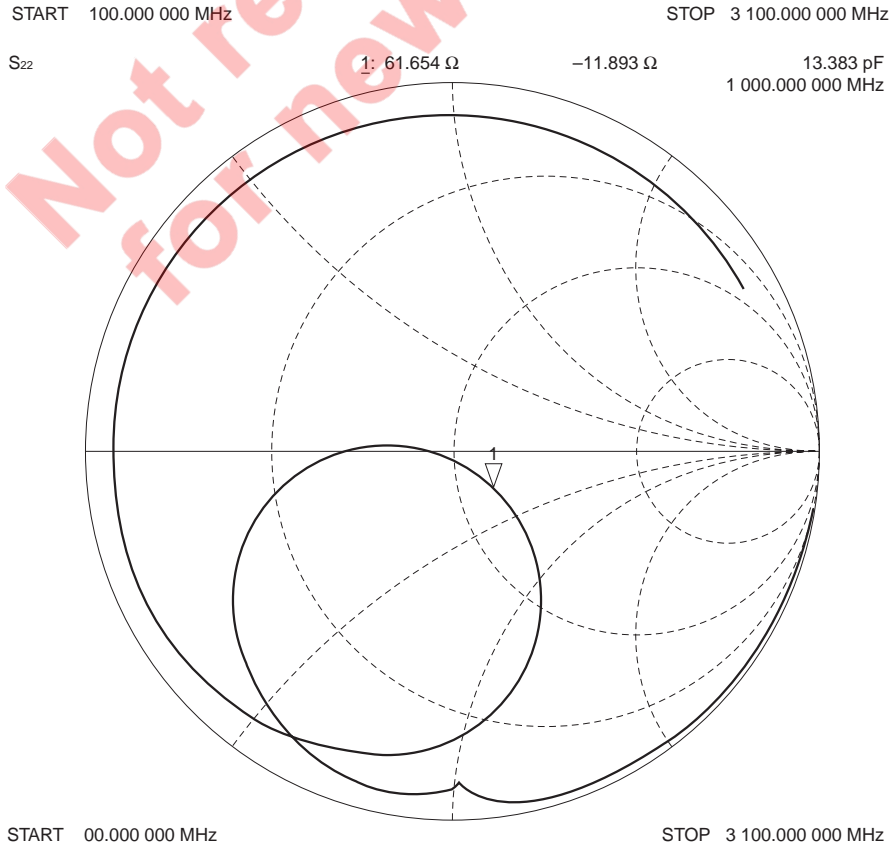
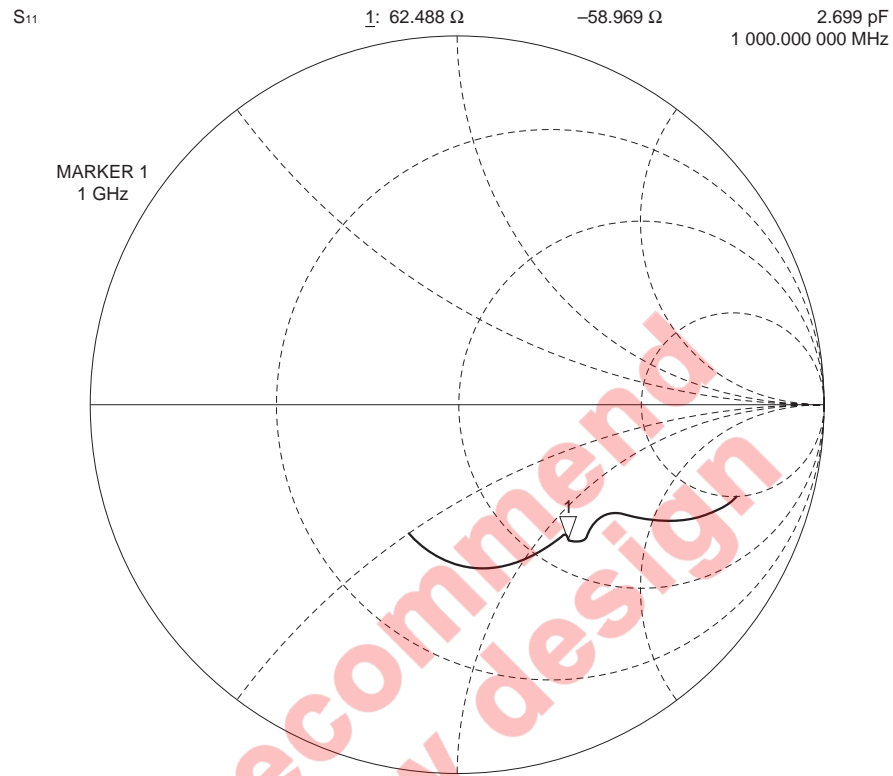

1.0 GHz OUTPUT PORT MATCHING

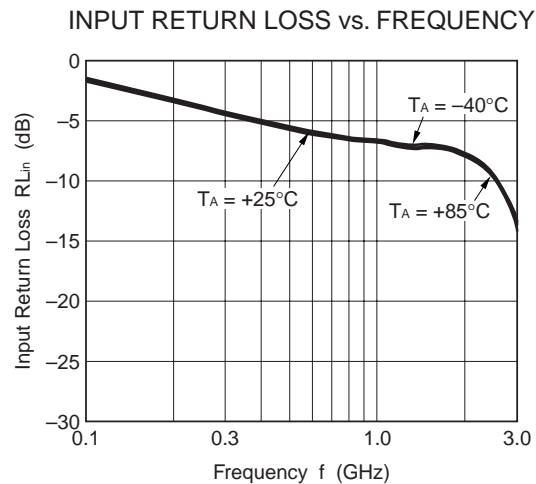
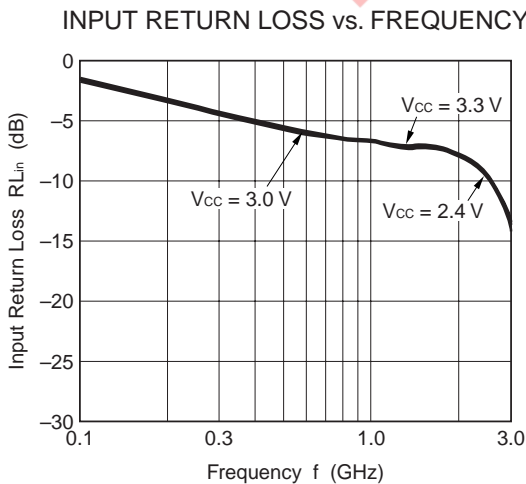
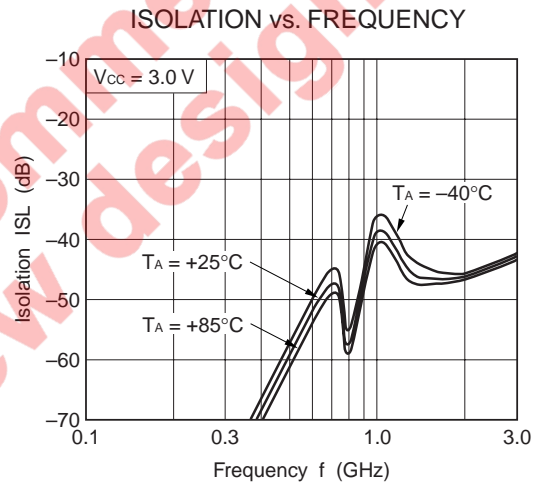
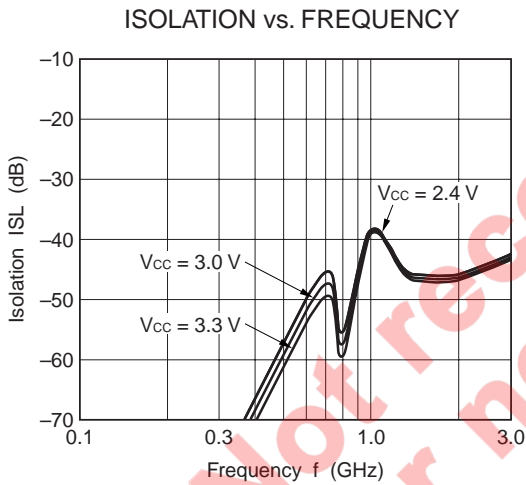
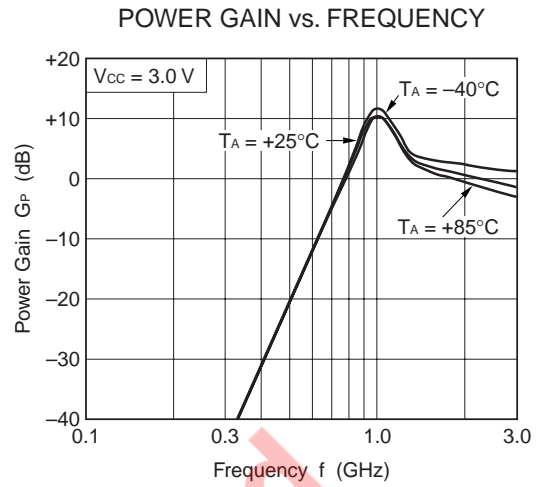
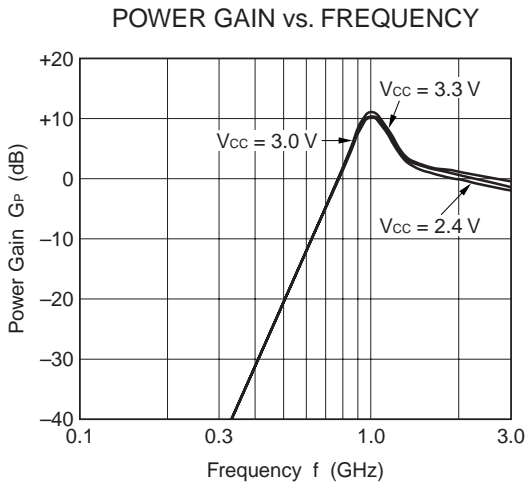

1.0 GHz OUTPUT PORT MATCHING

OUTPUT RETURN LOSS vs. FREQUENCY

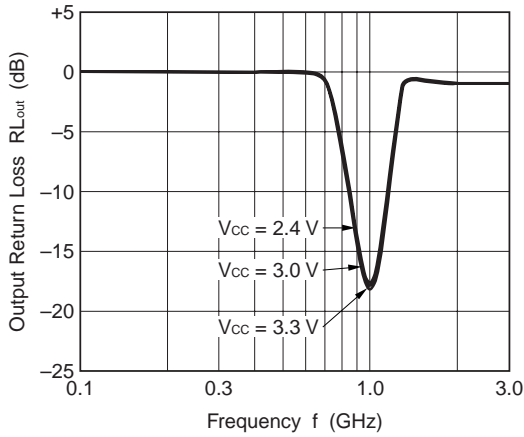

OUTPUT RETURN LOSS vs. FREQUENCY

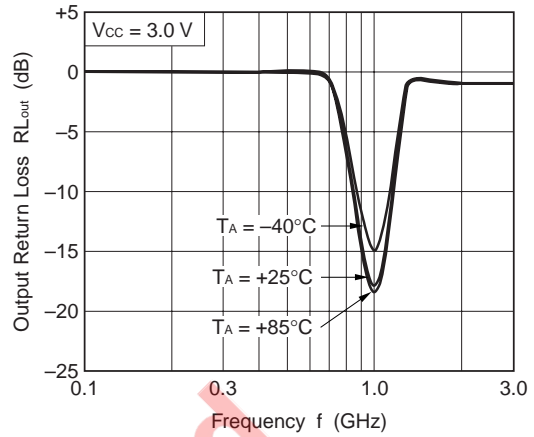

OUTPUT POWER vs. INPUT POWER

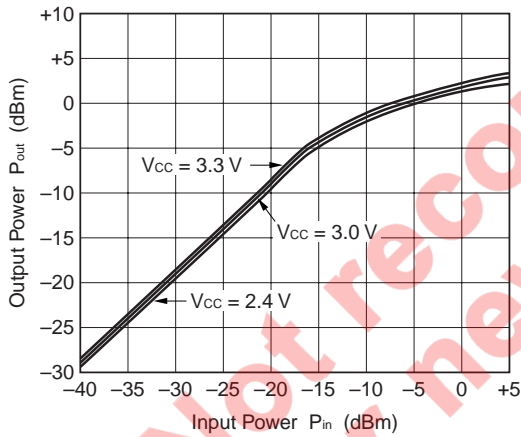

OUTPUT POWER vs. INPUT POWER

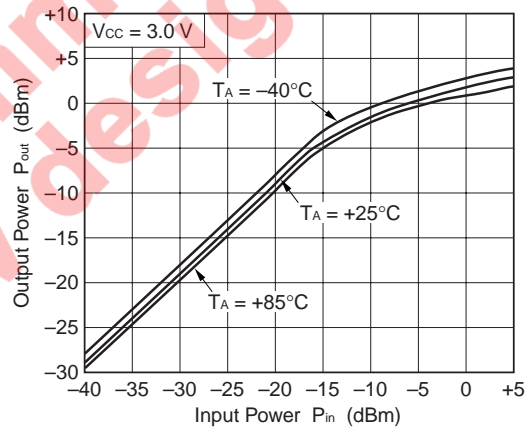

OUTPUT POWER OF EACH TONE, IM<sub>3</sub> vs. INPUT POWER OF EACH TONE

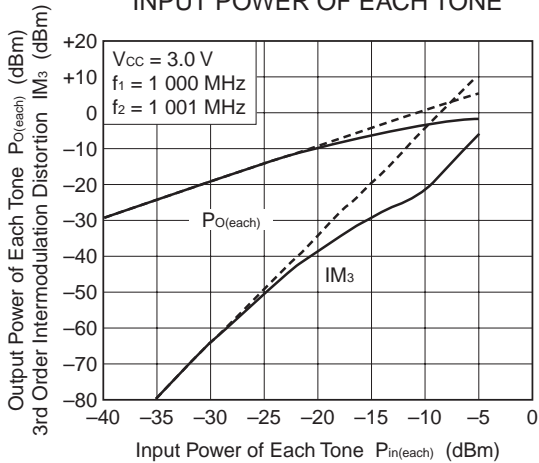

3RD ORDER INTERMODULATION DISTORTION vs. OUTPUT POWER OF EACH TONE

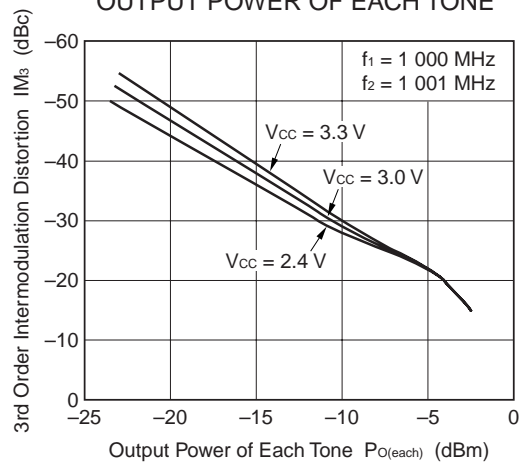

1.0 GHz OUTPUT PORT MATCHING

NOISE FIGURE vs. SUPPLY VOLTAGE

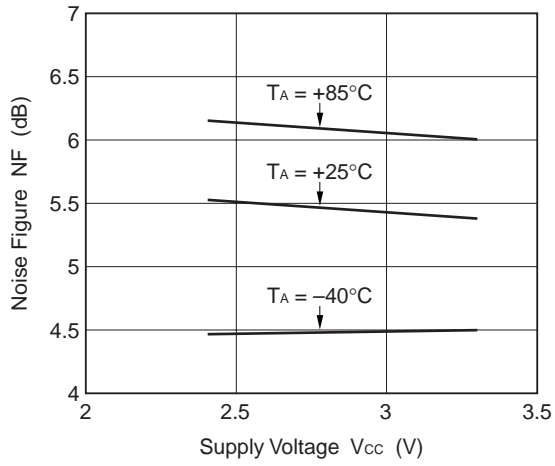

**Not recommend  
for new design**



1.9 GHz OUTPUT PORT MATCHING

S-PARAMETERS (monitored at connector on board)

T<sub>A</sub> = +25°C , V<sub>CC</sub> = V<sub>out</sub> = 3.0 V

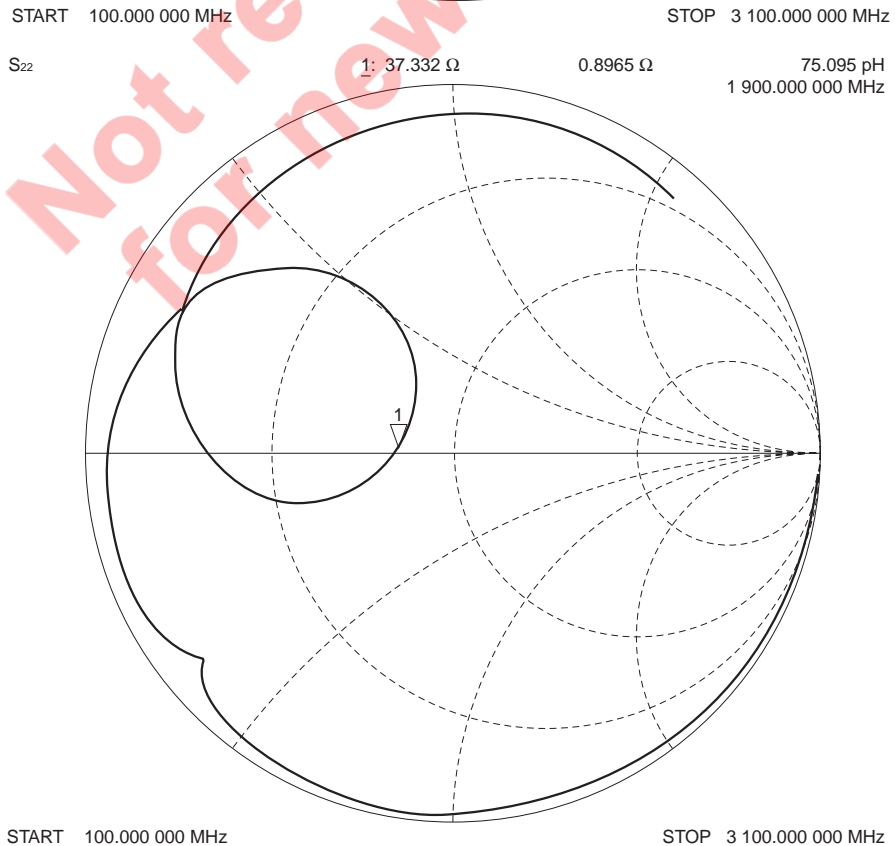
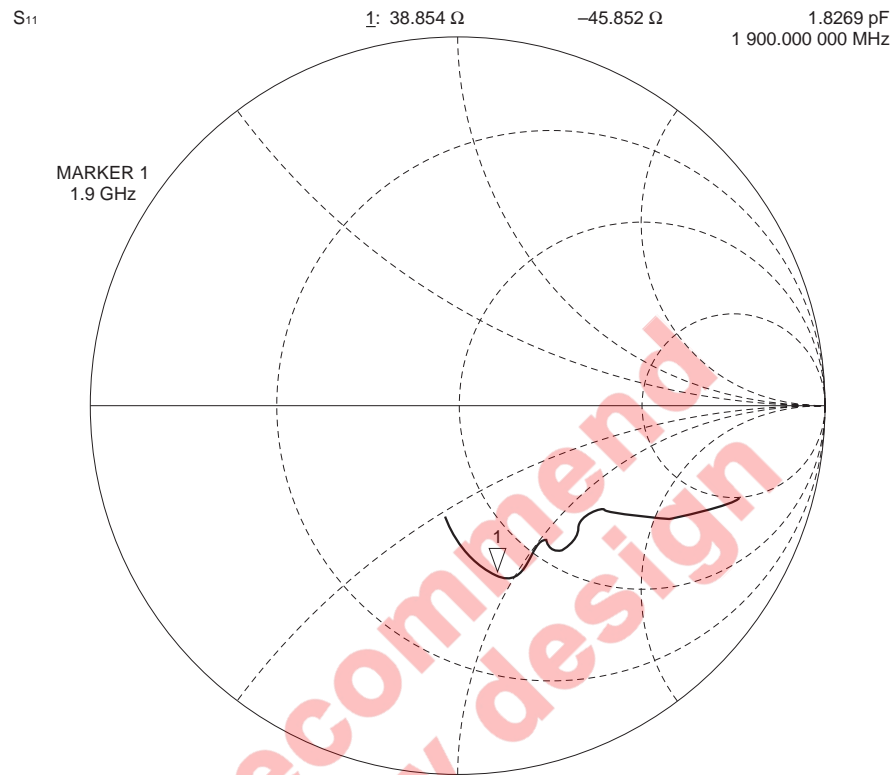

1.9 GHz OUTPUT PORT MATCHING

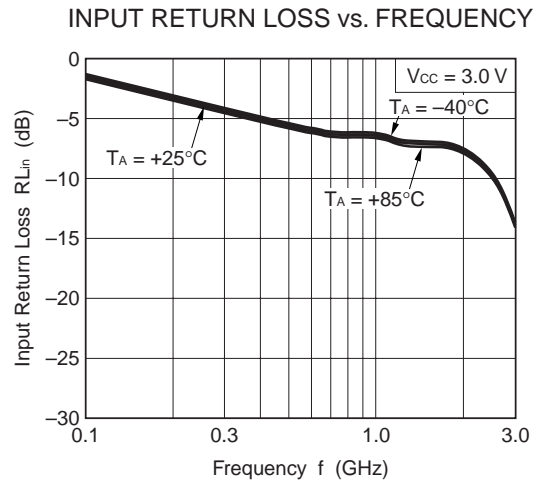
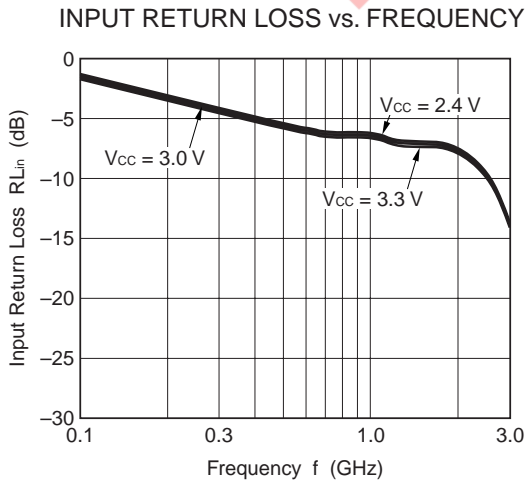
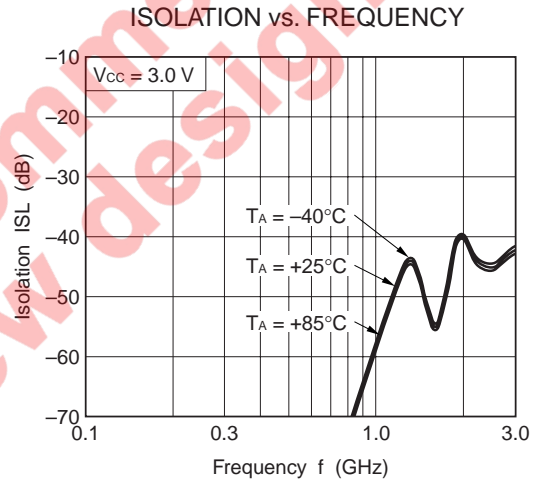
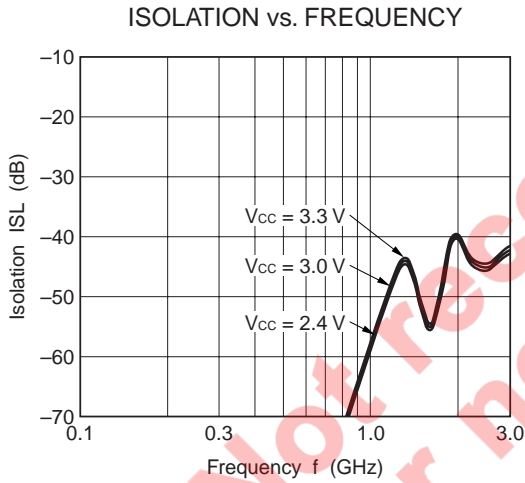
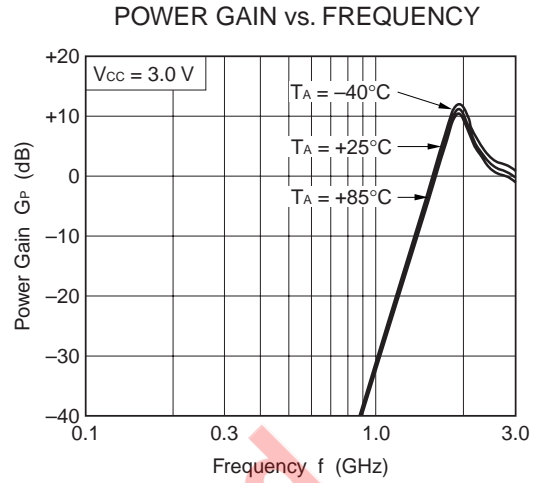
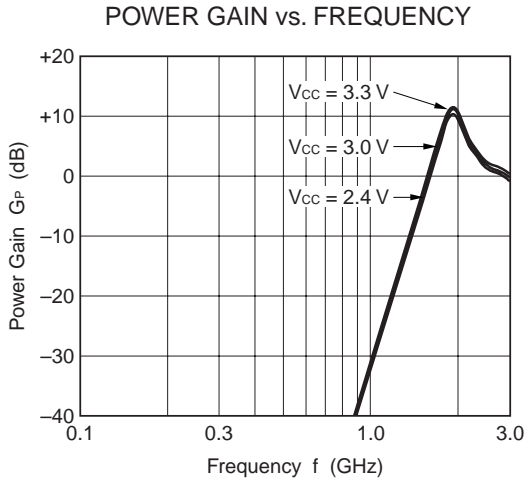

**1.9 GHz OUTPUT PORT MATCHING**

OUTPUT RETURN LOSS vs. FREQUENCY

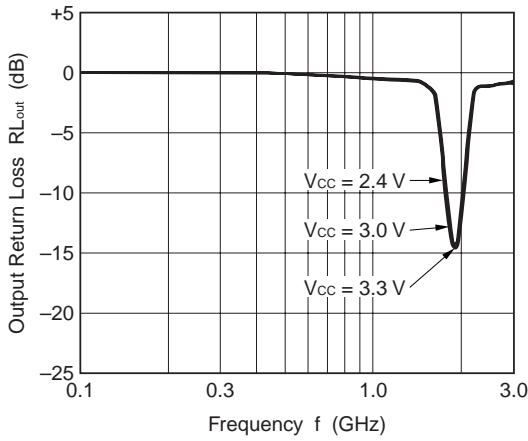

OUTPUT RETURN LOSS vs. FREQUENCY

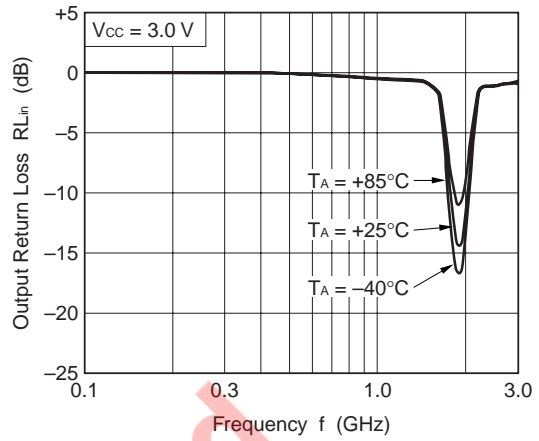

OUTPUT POWER vs. INPUT POWER

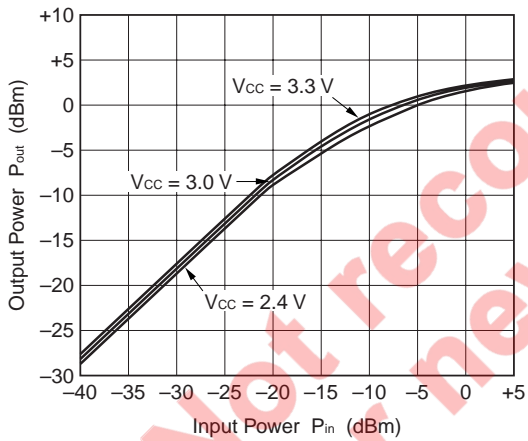

OUTPUT POWER vs. INPUT POWER

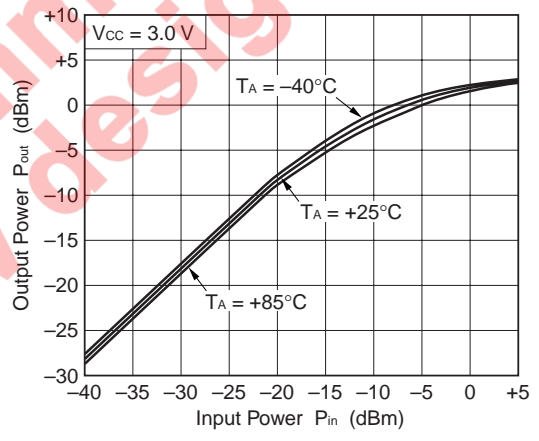

OUTPUT POWER OF EACH TONE, IM<sub>3</sub> vs. INPUT POWER OF EACH TONE

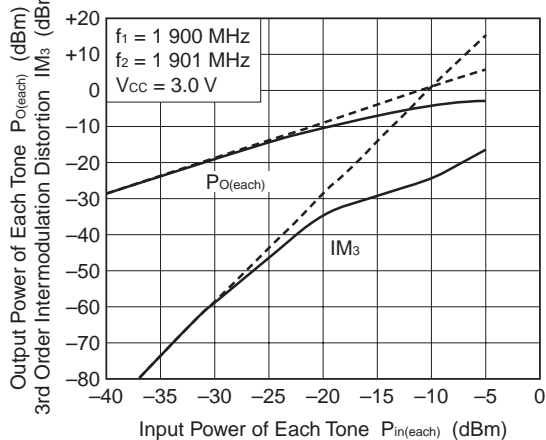

3RD ORDER INTERMODULATION DISTORTION vs. OUTPUT POWER OF EACH TONE

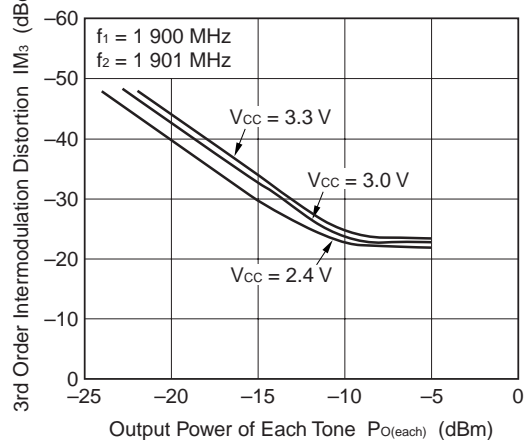

1.9 GHz OUTPUT PORT MATCHING

NOISE FIGURE vs. SUPPLY VOLTAGE

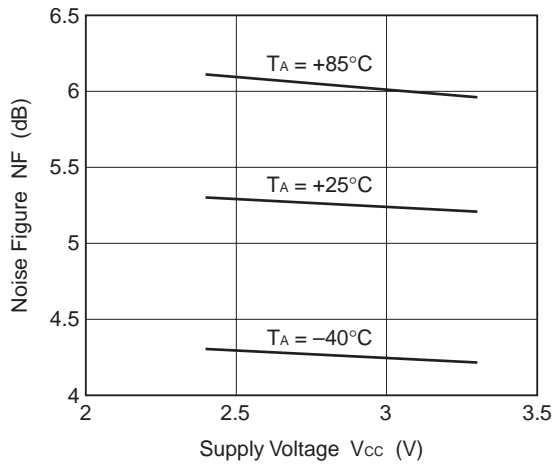

Not recommend  
for new design

### 2.4 GHz OUTPUT PORT MATCHING

**S-PARAMETERS (monitored at connector on board)**

T<sub>A</sub> = +25°C, V<sub>CC</sub> = V<sub>out</sub> = 3.0 V

S<sub>11</sub> 1: 31.873 Ω -33.441 Ω 1.983 pF  
2 400.000 000 MHz

MARKER 1  
2.4 GHz

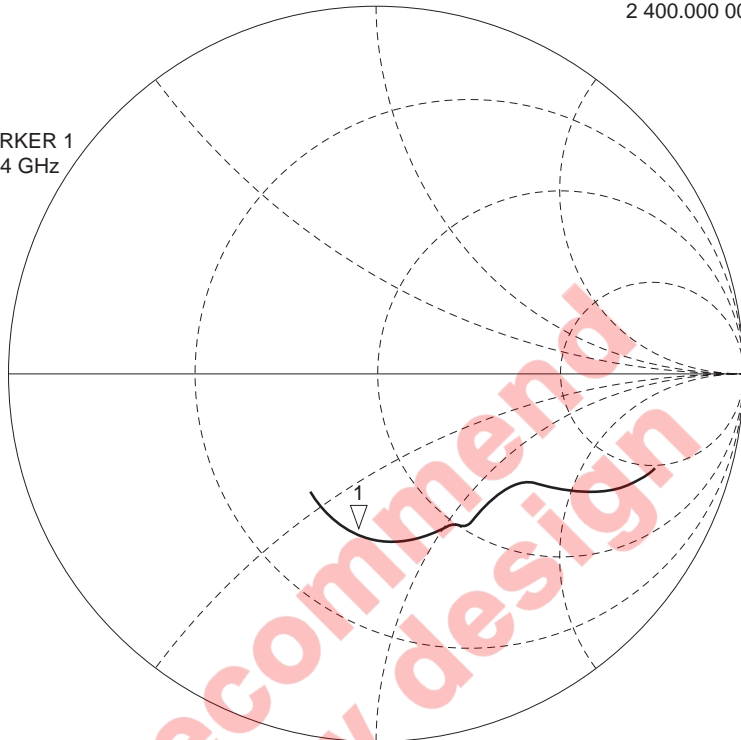

START 100.000 000 MHz STOP 3 100.000 000 MHz

S<sub>22</sub> 1: 41.125 Ω 20.08 Ω 1.3316 nH  
2 400.000 000 MHz

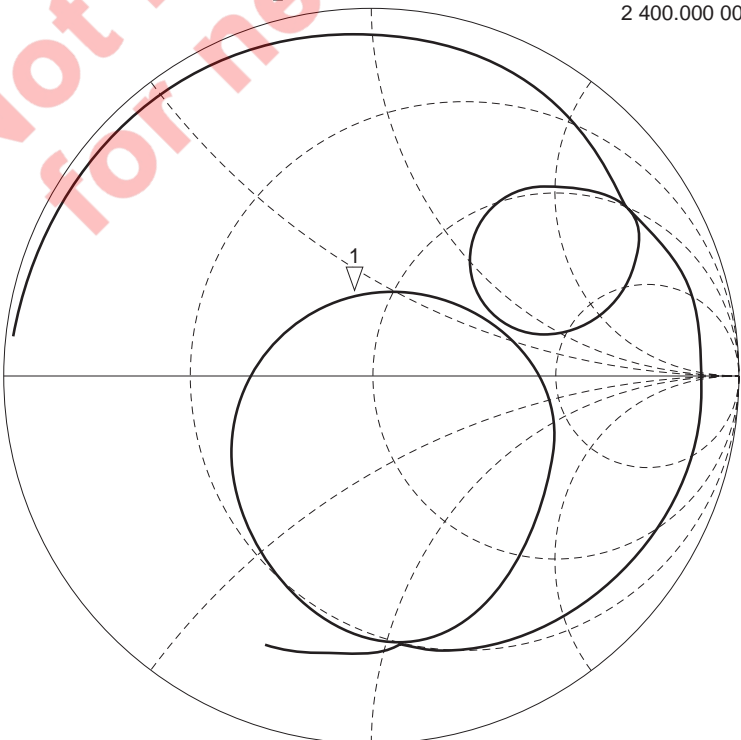

START 100.000 000 MHz STOP 3 100.000 000 MHz

2.4 GHz OUTPUT PORT MATCHING

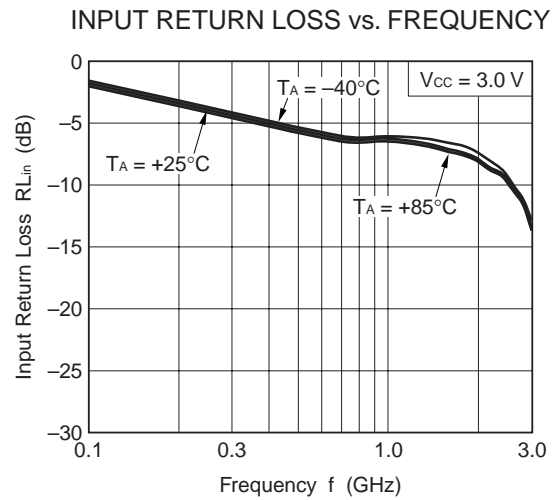
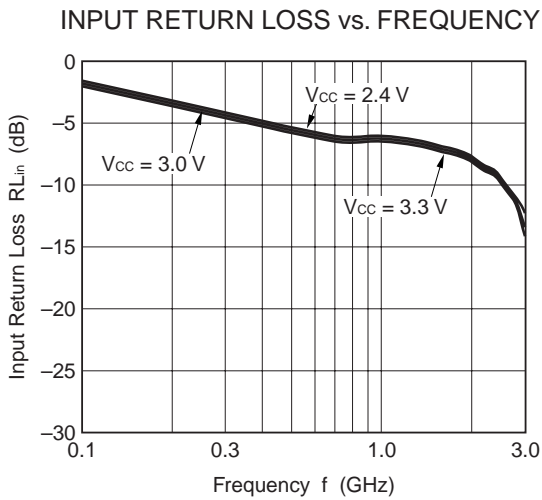
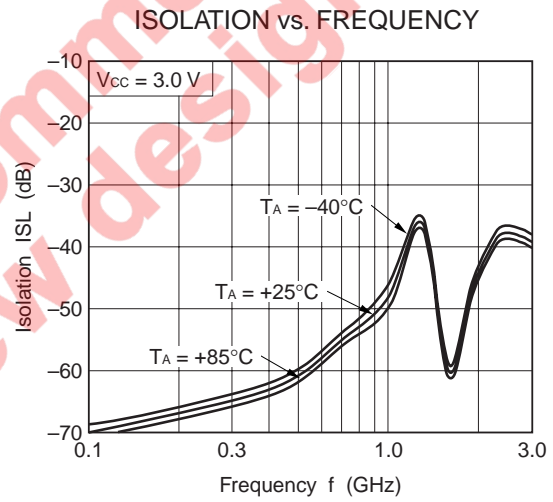
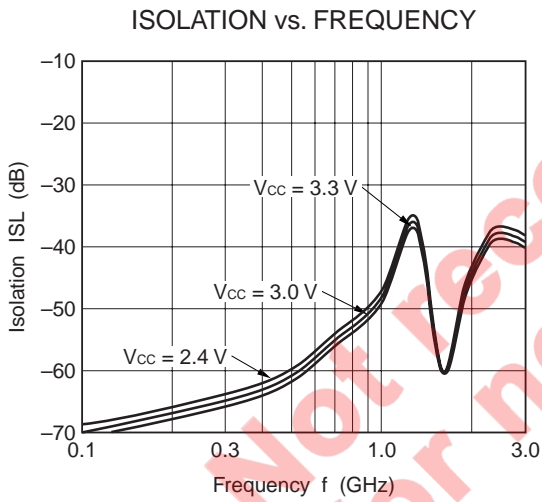
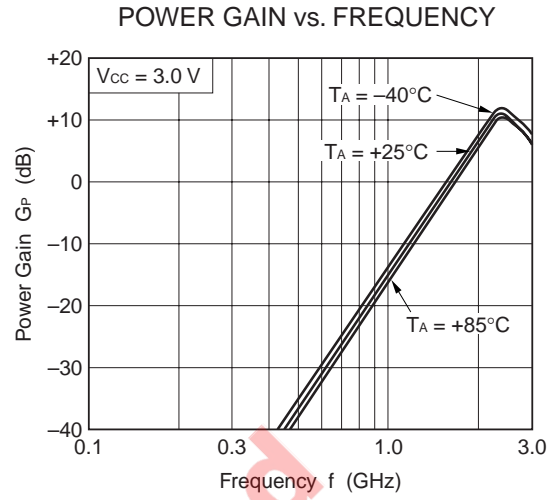
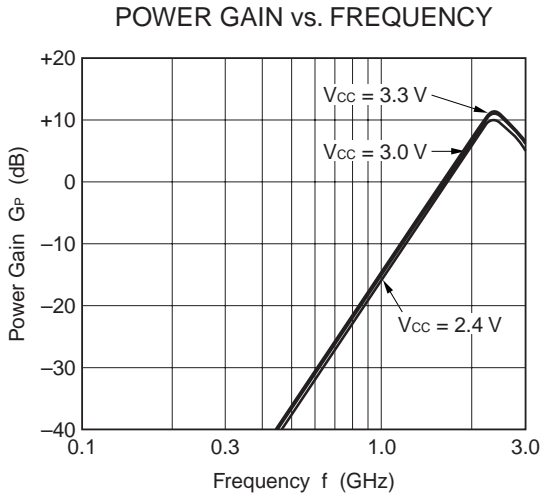

**2.4 GHz OUTPUT PORT MATCHING**

OUTPUT RETURN LOSS vs. FREQUENCY

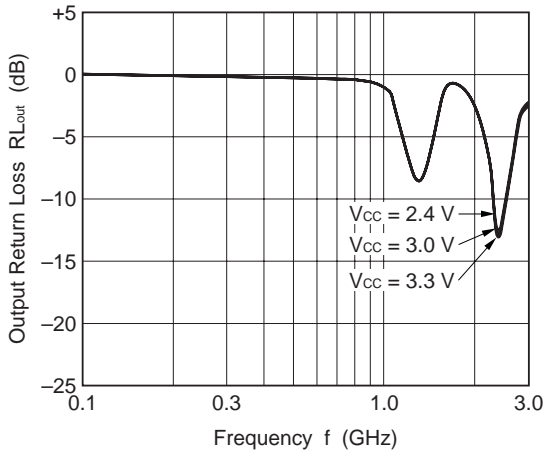

OUTPUT RETURN LOSS vs. FREQUENCY

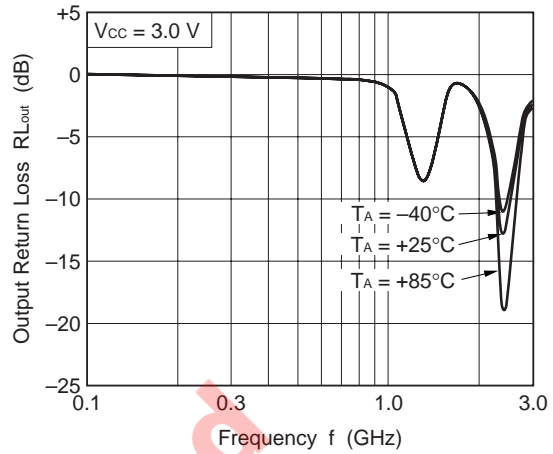

OUTPUT POWER vs. INPUT POWER

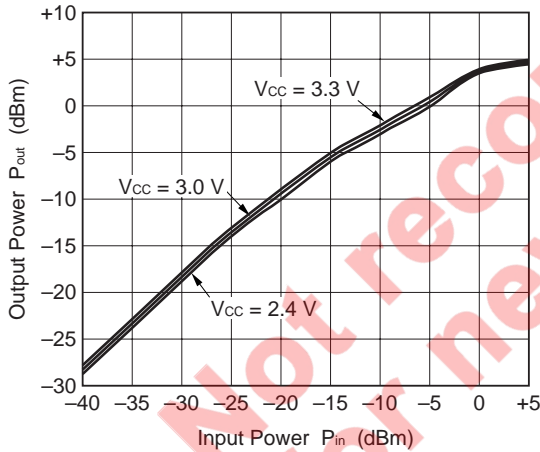

OUTPUT POWER vs. INPUT POWER

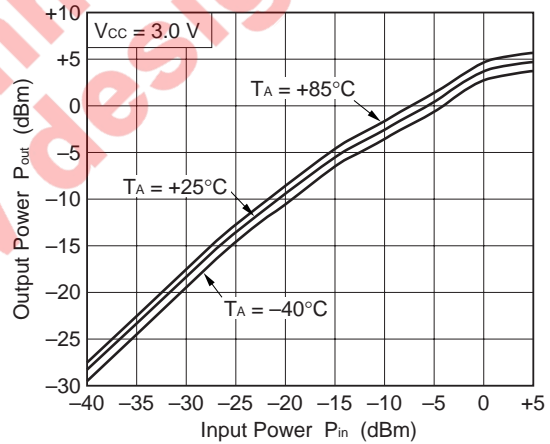

OUTPUT POWER OF EACH TONE, IM<sub>3</sub> vs. INPUT POWER OF EACH TONE

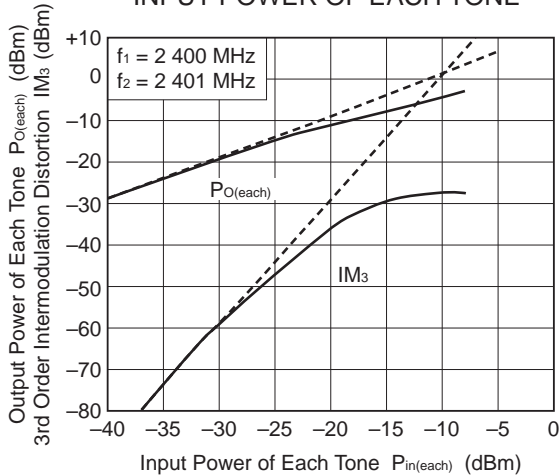

3RD ORDER INTERMODULATION DISTORTION vs. OUTPUT POWER OF EACH TONE

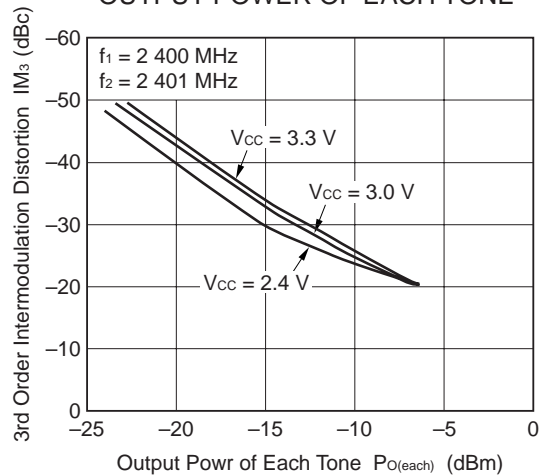

**2.4 GHz OUTPUT PORT MATCHING**

NOISE FIGURE vs. SUPPLY VOLTAGE

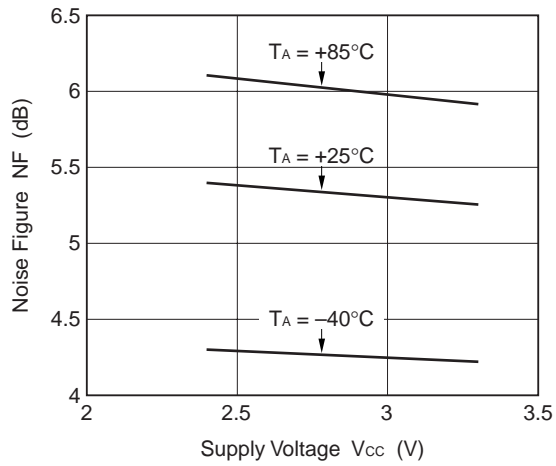

**Remark** The graphs indicate nominal characteristics.

**Not recommend  
for new design**



**S-PARAMETERS ( $V_{CC} = V_{out} = 3.0\text{ V}$ )**

**S<sub>11</sub>-FREQUENCY**

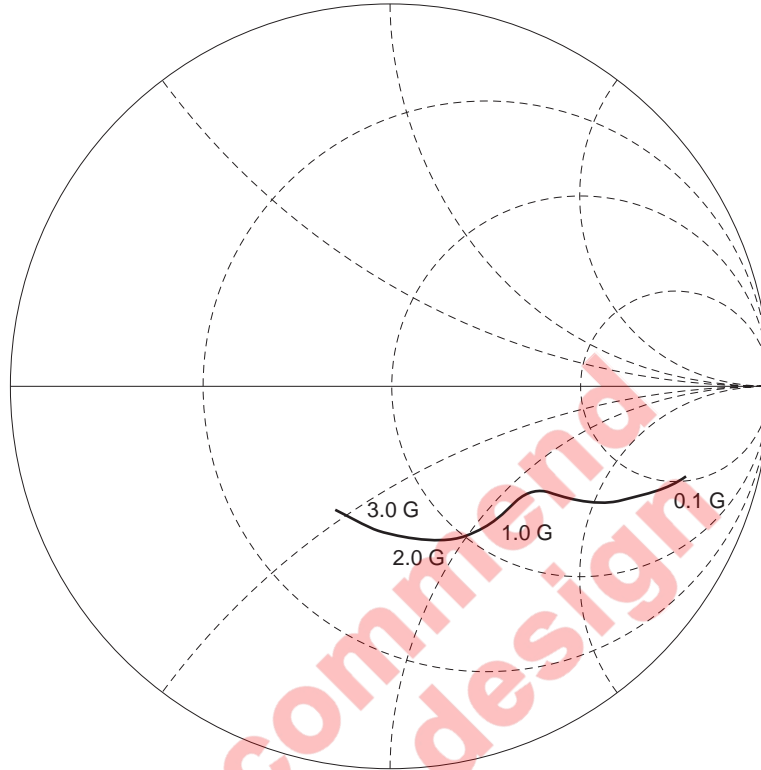

**S<sub>22</sub>-FREQUENCY**

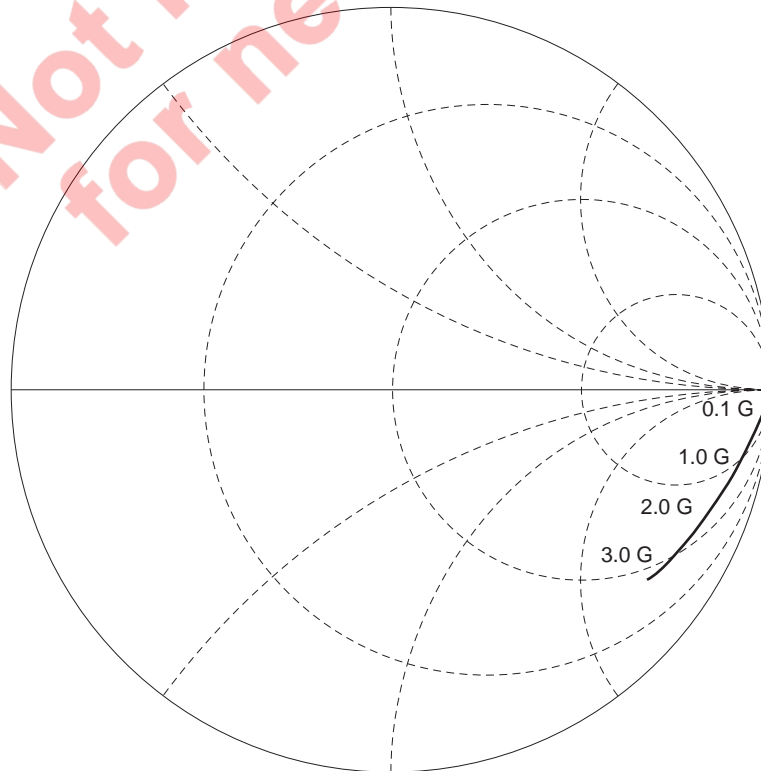

**TYPICAL S-PARAMETER VALUES (TA = +25°C)**

VCC = Vout = 3.0 V, Icc = 1.9 mA

FREQUENCY MHz	S11		S21		S12		S22	
	MAG.	ANG.	MAG.	ANG.	MAG.	ANG.	MAG.	ANG.
100.0000	0.821	-16.9	1.060	180.0	0.002	83.1	0.996	-1.9
200.0000	0.692	-26.0	1.042	-177.2	0.004	57.2	0.994	-3.9
300.0000	0.598	-30.2	1.085	-174.3	0.004	56.5	0.985	-5.4
400.0000	0.540	-31.6	1.164	-172.7	0.004	40.1	0.973	-6.9
500.0000	0.501	-33.1	1.259	-172.3	0.006	36.8	0.958	-8.2
600.0000	0.484	-34.0	1.365	-173.8	0.004	27.3	0.952	-9.7
700.0000	0.477	-35.5	1.516	-176.1	0.005	41.3	0.948	-10.8
800.0000	0.474	-37.4	1.601	-179.4	0.006	47.2	0.946	-11.9
900.0000	0.469	-40.4	1.700	177.2	0.006	41.9	0.942	-13.0
1000.0000	0.466	-42.8	1.791	172.1	0.006	39.8	0.927	-14.4
1100.0000	0.453	-45.2	1.867	167.6	0.006	30.9	0.916	-15.5
1200.0000	0.447	-48.2	1.929	163.2	0.005	27.1	0.915	-16.8
1300.0000	0.442	-51.3	2.030	157.3	0.005	37.0	0.913	-17.8
1400.0000	0.439	-55.1	2.067	152.2	0.006	40.6	0.907	-19.0
1500.0000	0.439	-59.0	2.109	146.4	0.004	52.5	0.902	-19.8
1600.0000	0.439	-62.6	2.118	142.5	0.006	32.5	0.888	-21.1
1700.0000	0.433	-66.0	2.089	137.2	0.005	44.7	0.880	-22.0
1800.0000	0.427	-69.8	2.082	132.7	0.006	52.4	0.882	-23.0
1900.0000	0.416	-73.1	2.034	127.9	0.005	48.6	0.884	-24.1
2000.0000	0.405	-77.4	2.025	124.0	0.006	42.4	0.880	-25.0
2100.0000	0.399	-82.2	1.967	119.6	0.005	57.6	0.872	-26.1
2200.0000	0.395	-86.5	1.992	116.7	0.004	62.3	0.864	-27.2
2300.0000	0.398	-89.4	1.999	113.6	0.005	70.7	0.863	-28.1
2400.0000	0.396	-92.5	2.019	110.7	0.003	105.5	0.862	-29.2
2500.0000	0.394	-95.2	1.963	107.2	0.004	88.3	0.860	-30.4
2600.0000	0.382	-97.5	2.013	103.6	0.005	110.9	0.857	-31.2
2700.0000	0.368	-101.1	1.948	101.4	0.005	107.6	0.849	-32.1
2800.0000	0.360	-104.8	1.934	96.2	0.007	124.4	0.846	-33.2
2900.0000	0.359	-108.7	1.986	94.5	0.005	100.5	0.842	-34.7
3000.0000	0.357	-111.2	1.951	89.5	0.008	128.9	0.844	-35.4
3100.0000	0.355	-113.7	2.049	85.8	0.009	113.3	0.846	-36.7

PACKAGE DIMENSIONS

6-PIN SUPER MINIMOLD (UNIT: mm)

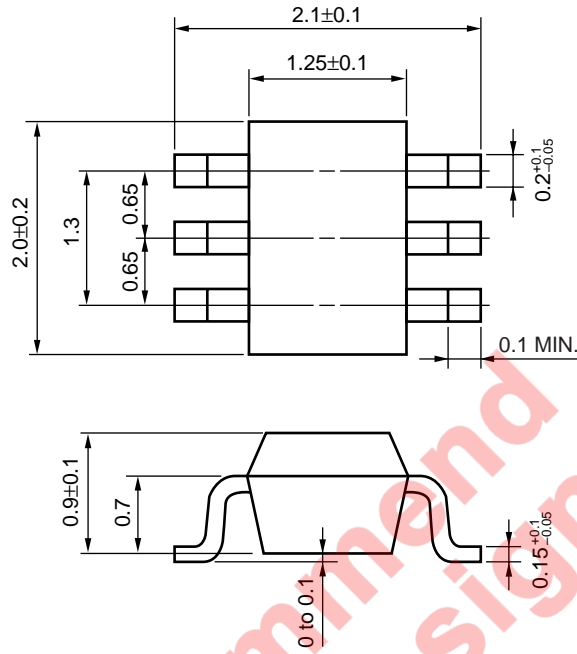

Not recommended for new design

**NOTES ON CORRECT USE**

- (1) Observe precautions for handling because of electro-static sensitive devices.
- (2) Form a ground pattern as widely as possible to minimize ground impedance (to prevent undesired oscillation). All the ground pins must be connected together with wide ground pattern to decrease impedance difference.
- (3) The bypass capacitor should be attached to Vcc line.
- (4) The inductor (L) should be attached between output and Vcc pins. The L and series capacitor (C) values should be adjusted for applied frequency to match impedance to next stage.
- (5) The DC capacitor must be attached to input pin.

**RECOMMENDED SOLDERING CONDITIONS**

This product should be soldered under the following recommended conditions. For soldering methods and conditions other than those recommended below, contact your NEC sales representative.

Soldering Method	Soldering Conditions	Recommended Condition Symbol
Infrared Reflow	Package peak temperature: 235°C or below Time: 30 seconds or less (at 210°C) Count: 3, Exposure limit: None <sup>Note</sup>	IR35-00-3
VPS	Package peak temperature: 215°C or below Time: 40 seconds or less (at 200°C) Count: 3, Exposure limit: None <sup>Note</sup>	VP15-00-3
Wave Soldering	Soldering bath temperature: 260°C or below Time: 10 seconds or less Count: 1, Exposure limit: None <sup>Note</sup>	WS60-00-1
Partial Heating	Pin temperature: 300°C Time: 3 seconds or less (per side of device) Exposure limit: None <sup>Note</sup>	—

**Note** After opening the dry pack, keep it in a place below 25°C and 65% RH for the allowable storage period.

**Caution** Do not use different soldering methods together (except for partial heating).

For details of recommended soldering conditions for surface mounting, refer to information document **SEMICONDUCTOR DEVICE MOUNTING TECHNOLOGY MANUAL (C10535E)**.

[MEMO]

**Not recommend  
for new design**

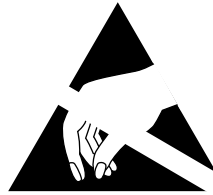

## ATTENTION

OBSERVE PRECAUTIONS  
FOR HANDLING  
ELECTROSTATIC  
SENSITIVE  
DEVICES

- The information in this document is current as of November, 2000. The information is subject to change without notice. For actual design-in, refer to the latest publications of NEC's data sheets or data books, etc., for the most up-to-date specifications of NEC semiconductor products. Not all products and/or types are available in every country. Please check with an NEC sales representative for availability and additional information.
- No part of this document may be copied or reproduced in any form or by any means without prior written consent of NEC. NEC assumes no responsibility for any errors that may appear in this document.
- NEC does not assume any liability for infringement of patents, copyrights or other intellectual property rights of third parties by or arising from the use of NEC semiconductor products listed in this document or any other liability arising from the use of such products. No license, express, implied or otherwise, is granted under any patents, copyrights or other intellectual property rights of NEC or others.
- Descriptions of circuits, software and other related information in this document are provided for illustrative purposes in semiconductor product operation and application examples. The incorporation of these circuits, software and information in the design of customer's equipment shall be done under the full responsibility of customer. NEC assumes no responsibility for any losses incurred by customers or third parties arising from the use of these circuits, software and information.
- While NEC endeavours to enhance the quality, reliability and safety of NEC semiconductor products, customers agree and acknowledge that the possibility of defects thereof cannot be eliminated entirely. To minimize risks of damage to property or injury (including death) to persons arising from defects in NEC semiconductor products, customers must incorporate sufficient safety measures in their design, such as redundancy, fire-containment, and anti-failure features.
- NEC semiconductor products are classified into the following three quality grades: "Standard", "Special" and "Specific". The "Specific" quality grade applies only to semiconductor products developed based on a customer-designated "quality assurance program" for a specific application. The recommended applications of a semiconductor product depend on its quality grade, as indicated below. Customers must check the quality grade of each semiconductor product before using it in a particular application.
  - "Standard": Computers, office equipment, communications equipment, test and measurement equipment, audio and visual equipment, home electronic appliances, machine tools, personal electronic equipment and industrial robots
  - "Special": Transportation equipment (automobiles, trains, ships, etc.), traffic control systems, anti-disaster systems, anti-crime systems, safety equipment and medical equipment (not specifically designed for life support)
  - "Specific": Aircraft, aerospace equipment, submersible repeaters, nuclear reactor control systems, life support systems and medical equipment for life support, etc.

The quality grade of NEC semiconductor products is "Standard" unless otherwise expressly specified in NEC's data sheets or data books, etc. If customers wish to use NEC semiconductor products in applications not intended by NEC, they must contact an NEC sales representative in advance to determine NEC's willingness to support a given application.

(Note)

- (1) "NEC" as used in this statement means NEC Corporation and also includes its majority-owned subsidiaries.
- (2) "NEC semiconductor products" means any semiconductor product developed or manufactured by or for NEC (as defined above).