

To our customers,

Old Company Name in Catalogs and Other Documents

On April 1st, 2010, NEC Electronics Corporation merged with Renesas Technology Corporation, and Renesas Electronics Corporation took over all the business of both companies. Therefore, although the old company name remains in this document, it is a valid Renesas Electronics document. We appreciate your understanding.

Renesas Electronics website: <http://www.renesas.com>

April 1st, 2010
Renesas Electronics Corporation

Issued by: Renesas Electronics Corporation (<http://www.renesas.com>)

Send any inquiries to <http://www.renesas.com/inquiry>.

Not recommended
for new design

Notice

1. All information included in this document is current as of the date this document is issued. Such information, however, is subject to change without any prior notice. Before purchasing or using any Renesas Electronics products listed herein, please confirm the latest product information with a Renesas Electronics sales office. Also, please pay regular and careful attention to additional and different information to be disclosed by Renesas Electronics such as that disclosed through our website.
2. Renesas Electronics does not assume any liability for infringement of patents, copyrights, or other intellectual property rights of third parties by or arising from the use of Renesas Electronics products or technical information described in this document. No license, express, implied or otherwise, is granted hereby under any patents, copyrights or other intellectual property rights of Renesas Electronics or others.
3. You should not alter, modify, copy, or otherwise misappropriate any Renesas Electronics product, whether in whole or in part.
4. Descriptions of circuits, software and other related information in this document are provided only to illustrate the operation of semiconductor products and application examples. You are fully responsible for the incorporation of these circuits, software, and information in the design of your equipment. Renesas Electronics assumes no responsibility for any losses incurred by you or third parties arising from the use of these circuits, software, or information.
5. When exporting the products or technology described in this document, you should comply with the applicable export control laws and regulations and follow the procedures required by such laws and regulations. You should not use Renesas Electronics products or the technology described in this document for any purpose relating to military applications or use by the military, including but not limited to the development of weapons of mass destruction. Renesas Electronics products and technology may not be used for or incorporated into any products or systems whose manufacture, use, or sale is prohibited under any applicable domestic or foreign laws or regulations.
6. Renesas Electronics has used reasonable care in preparing the information included in this document, but Renesas Electronics does not warrant that such information is error free. Renesas Electronics assumes no liability whatsoever for any damages incurred by you resulting from errors in or omissions from the information included herein.
7. Renesas Electronics products are classified according to the following three quality grades: “Standard”, “High Quality”, and “Specific”. The recommended applications for each Renesas Electronics product depends on the product’s quality grade, as indicated below. You must check the quality grade of each Renesas Electronics product before using it in a particular application. You may not use any Renesas Electronics product for any application categorized as “Specific” without the prior written consent of Renesas Electronics. Further, you may not use any Renesas Electronics product for any application for which it is not intended without the prior written consent of Renesas Electronics. Renesas Electronics shall not be in any way liable for any damages or losses incurred by you or third parties arising from the use of any Renesas Electronics product for an application categorized as “Specific” or for which the product is not intended where you have failed to obtain the prior written consent of Renesas Electronics. The quality grade of each Renesas Electronics product is “Standard” unless otherwise expressly specified in a Renesas Electronics data sheets or data books, etc.
 - “Standard”: Computers; office equipment; communications equipment; test and measurement equipment; audio and visual equipment; home electronic appliances; machine tools; personal electronic equipment; and industrial robots.
 - “High Quality”: Transportation equipment (automobiles, trains, ships, etc.); traffic control systems; anti-disaster systems; anti-crime systems; safety equipment; and medical equipment not specifically designed for life support.
 - “Specific”: Aircraft; aerospace equipment; submersible repeaters; nuclear reactor control systems; medical equipment or systems for life support (e.g. artificial life support devices or systems), surgical implantations, or healthcare intervention (e.g. excision, etc.), and any other applications or purposes that pose a direct threat to human life.
8. You should use the Renesas Electronics products described in this document within the range specified by Renesas Electronics, especially with respect to the maximum rating, operating supply voltage range, movement power voltage range, heat radiation characteristics, installation and other product characteristics. Renesas Electronics shall have no liability for malfunctions or damages arising out of the use of Renesas Electronics products beyond such specified ranges.
9. Although Renesas Electronics endeavors to improve the quality and reliability of its products, semiconductor products have specific characteristics such as the occurrence of failure at a certain rate and malfunctions under certain use conditions. Further, Renesas Electronics products are not subject to radiation resistance design. Please be sure to implement safety measures to guard them against the possibility of physical injury, and injury or damage caused by fire in the event of the failure of a Renesas Electronics product, such as safety design for hardware and software including but not limited to redundancy, fire control and malfunction prevention, appropriate treatment for aging degradation or any other appropriate measures. Because the evaluation of microcomputer software alone is very difficult, please evaluate the safety of the final products or system manufactured by you.
10. Please contact a Renesas Electronics sales office for details as to environmental matters such as the environmental compatibility of each Renesas Electronics product. Please use Renesas Electronics products in compliance with all applicable laws and regulations that regulate the inclusion or use of controlled substances, including without limitation, the EU RoHS Directive. Renesas Electronics assumes no liability for damages or losses occurring as a result of your noncompliance with applicable laws and regulations.
11. This document may not be reproduced or duplicated, in any form, in whole or in part, without prior written consent of Renesas Electronics.
12. Please contact a Renesas Electronics sales office if you have any questions regarding the information contained in this document or Renesas Electronics products, or if you have any other inquiries.

(Note 1) “Renesas Electronics” as used in this document means Renesas Electronics Corporation and also includes its majority-owned subsidiaries.

(Note 2) “Renesas Electronics product(s)” means any product developed or manufactured by or for Renesas Electronics.

THREE TERMINAL POSITIVE VOLTAGE REGULATOR

DESCRIPTION

μ PC78N00 series are monolithic three terminal positive regulators which employ internally current limiting, thermal shut down, output transistor safe operating area protection make them essentially indestructible.

They are intended as fixed voltage regulators in a wide range of application including local on card regulation for elimination of distribution problems associated wide single point regulation.

FEATURES

- Output current in excess of 300 mA.
- Built-in some protection circuits.
(over current protection, SOA protection and thermal shut down)
- Small package, TO-126

ORDER INFORMATION

Type Number	Output Voltage	Package	Quality Grade
μ PC78N05H	5 V	TO-126	Standard
μ PC78N08H	8 V		
μ PC78N10H	10 V		
μ PC78N12H	12 V		
μ PC78N15H	15 V		
μ PC78N18H	18 V		
μ PC78N24H	24 V		

Please refer to "Quality grade on NEC Semiconductor Devices" (Document number IEI-1209) published by NEC Corporation to know the specification of quality grade on the devices and its recommended applications.

EQUIVALENT CIRCUIT

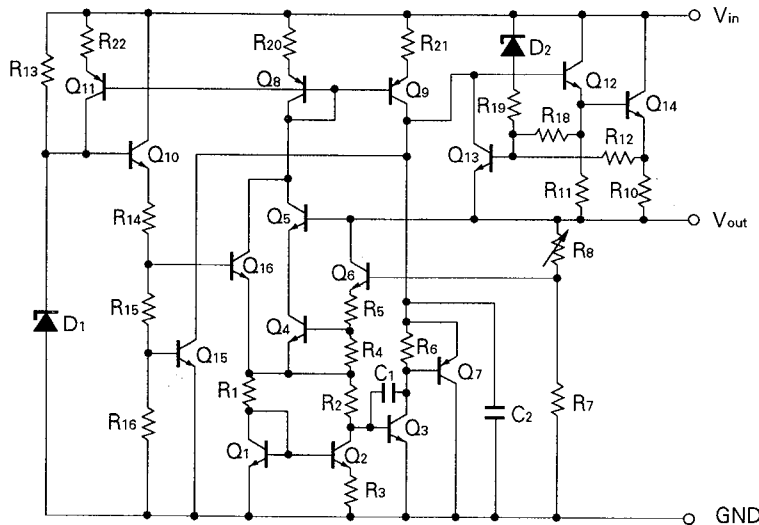

CONNECTION DIAGRAM

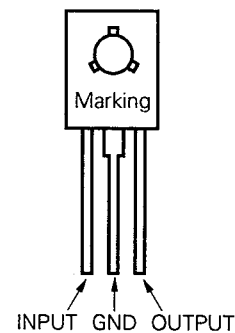

ABSOLUTE MAXIMUM RATINGS (T_a = 25 °C)

CHARACTERISTIC	SYMBOL	RATING	UNIT
Input Voltage	V _{IN}	35/40 (Note1)	V
Internal Power Dissipation	P _T	12.5 (Note2)	W
Operating Ambient Temperature Range	T _{opt}	-20 to +85	°C
Operating Junction Temperature Range	T _{opt (j)}	-20 to +150	°C
Storage Temperature Range	T _{stg}	-55 to +150	°C
Thermal Resistance (junction to case)	R _{th (j-c)}	10	°C/W
Thermal Resistance (junction to ambient)	R _{th (j-a)}	110	°C/W

(Note 1) μPC78N05, 08, 10, 12, 15, 18 : 35 V, μPC78N24 : 40 V

(Note 2) Internally limited

TYPICAL CONNECTION

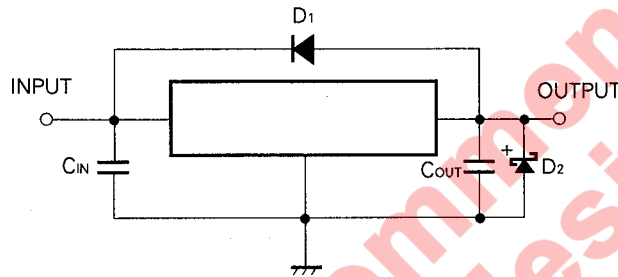

C₁: Required if regulator is located an appreciable distance from power supply filter

C₂: More than 0.1 μF

D₁: Needed for V_{IN} < V_o

D₂: Needed for V_o < GND

RECOMMENDED OPERATING CONDITIONS

CHARACTERISTIC	SYMBOL	TYPE NUMBER	MIN.	TYP.	MAX.	UNIT
Input Voltage	V _{IN}	μPC78N05H	7	10	25	V
		μPC78N08H	10.5	14	25	
		μPC78N10H	12.5	17	30	
		μPC78N12H	14.5	19	30	
		μPC78N15H	17.5	23	30	
		μPC78N18H	21	27	33	
		μPC78N24H	27	33	38	
Output Current	I _o	All	0		300	mA
Operating Temperature Range	T _{opt}	All	-20		+85	°C
Operating Junction Temperature Range	T _{opt (j)}	All	-20		+125	°C

ELECTRICAL CHARACTERISTICS μPC78N05

($V_{IN} = 10\text{ V}$, $I_o = 200\text{ mA}$, $0\text{ }^\circ\text{C} \leq T_j \leq +125\text{ }^\circ\text{C}$, $C_{IN} = 0.33\text{ }\mu\text{F}$, $C_{OUT} = 0.1\text{ }\mu\text{F}$)

CHARACTERISTIC	SYMBOL	TEST CONDITIONS	MIN.	TYP.	MAX.	UNIT
Output Voltage	V_o	$T_j = 25\text{ }^\circ\text{C}$	4.8	5.0	5.2	V
		$7\text{ V} \leq V_{IN} \leq 20\text{ V}$, $5\text{ mA} \leq I_o \leq 200\text{ mA}$	4.75		5.25	
Line Regulation	REG_{IN}	$T_j = 25\text{ }^\circ\text{C}$, $7\text{ V} \leq V_{IN} \leq 25\text{ V}$		15	50	mV
		$T_j = 25\text{ }^\circ\text{C}$, $8\text{ V} \leq V_{IN} \leq 20\text{ V}$		10	25	
Load Regulation	REG_L	$T_j = 25\text{ }^\circ\text{C}$, $1\text{ mA} \leq I_o \leq 300\text{ mA}$		6	100	mV
		$T_j = 25\text{ }^\circ\text{C}$, $5\text{ mA} \leq I_o \leq 200\text{ mA}$		4	50	
Quiescent Current	I_{BIAS}	$T_j = 25\text{ }^\circ\text{C}$		3.5	5.0	mA
Quiescent Current Change	ΔI_{BIAS}	$7\text{ V} \leq V_{IN} \leq 25\text{ V}$			0.8	mA
		$1\text{ mA} \leq I_o \leq 300\text{ mA}$			0.5	
Output Noise Voltage	V_n	$T_j = 25\text{ }^\circ\text{C}$, $10\text{ Hz} \leq f \leq 100\text{ kHz}$		50	120	$\mu\text{V}_{r.m.s.}$
Ripple Rejection	$R \cdot R$	$T_j = 25\text{ }^\circ\text{C}$, $f = 120\text{ Hz}$, $8\text{ V} \leq V_{IN} \leq 18\text{ V}$	62	70		dB
Dropout Voltage	V_{DIF}	$T_j = 25\text{ }^\circ\text{C}$		1.7		V
Short Circuit Current	I_{oshort}	$T_j = 25\text{ }^\circ\text{C}$, $V_{IN} = 25\text{ V}$		170		mA
Peak Output Current	I_{opeak}	$T_j = 25\text{ }^\circ\text{C}$	360	500	640	mA
Temperature coefficient of Output Voltage	$\Delta V_o / \Delta T$	$I_o = 5\text{ mA}$		0.1		mV/°C

ELECTRICAL CHARACTERISTICS μPC78N08

($V_{IN} = 14\text{ V}$, $I_o = 200\text{ mA}$, $0\text{ }^\circ\text{C} \leq T_j \leq +125\text{ }^\circ\text{C}$, $C_{IN} = 0.33\text{ }\mu\text{F}$, $C_{OUT} = 0.1\text{ }\mu\text{F}$)

CHARACTERISTIC	SYMBOL	TEST CONDITIONS	MIN.	TYP.	MAX.	UNIT
Output Voltage	V_o	$T_j = 25\text{ }^\circ\text{C}$	7.7	8.0	8.3	V
		$10.5\text{ V} \leq V_{IN} \leq 23\text{ V}$, $5\text{ mA} \leq I_o \leq 200\text{ mA}$	7.6		8.4	
Line Regulation	REG_{IN}	$T_j = 25\text{ }^\circ\text{C}$, $10.5\text{ V} \leq V_{IN} \leq 25\text{ V}$		18	80	mV
		$T_j = 25\text{ }^\circ\text{C}$, $12\text{ V} \leq V_{IN} \leq 23\text{ V}$		13	40	
Load Regulation	REG_L	$T_j = 25\text{ }^\circ\text{C}$, $1\text{ mA} \leq I_o \leq 300\text{ mA}$		8	160	mV
		$T_j = 25\text{ }^\circ\text{C}$, $5\text{ mA} \leq I_o \leq 200\text{ mA}$		6	80	
Quiescent Current	I_{BIAS}	$T_j = 25\text{ }^\circ\text{C}$		3.5	5.0	mA
Quiescent Current Change	ΔI_{BIAS}	$10.5\text{ V} \leq V_{IN} \leq 25\text{ V}$			0.8	mA
		$1\text{ mA} \leq I_o \leq 300\text{ mA}$			0.5	
Output Noise Voltage	V_n	$T_j = 25\text{ }^\circ\text{C}$, $10\text{ Hz} \leq f \leq 100\text{ kHz}$		65	190	$\mu\text{V}_{r.m.s.}$
Ripple Rejection	$R \cdot R$	$T_j = 25\text{ }^\circ\text{C}$, $f = 120\text{ Hz}$, $11\text{ V} \leq V_{IN} \leq 21\text{ V}$	56	68		dB
Dropout Voltage	V_{DIF}	$T_j = 25\text{ }^\circ\text{C}$		1.7		V
Short Circuit Current	I_{oshort}	$T_j = 25\text{ }^\circ\text{C}$, $V_{IN} = 25\text{ V}$		170		mA
Peak Output Current	I_{opeak}	$T_j = 25\text{ }^\circ\text{C}$	360	490	640	mA
Temperature coefficient of Output Voltage	$\Delta V_o / \Delta T$	$I_o = 5\text{ mA}$		0.2		mV/°C

ELECTRICAL CHARACTERISTICS μPC78N10

($V_{IN} = 17\text{ V}$, $I_o = 200\text{ mA}$, $0\text{ }^\circ\text{C} \leq T_j \leq +125\text{ }^\circ\text{C}$, $C_{IN} = 0.33\text{ }\mu\text{F}$, $C_{OUT} = 0.1\text{ }\mu\text{F}$)

CHARACTERISTIC	SYMBOL	TEST CONDITIONS	MIN.	TYP.	MAX.	UNIT
Output Voltage	V_o	$T_j = 25\text{ }^\circ\text{C}$	9.6	10	10.4	V
		$12.5\text{ V} \leq V_{IN} \leq 25\text{ V}$, $5\text{ mA} \leq I_o \leq 200\text{ mA}$	9.5		10.5	
Line Regulation	REG_{IN}	$T_j = 25\text{ }^\circ\text{C}$, $12.5\text{ V} \leq V_{IN} \leq 30\text{ V}$		25	100	mV
		$T_j = 25\text{ }^\circ\text{C}$, $13\text{ V} \leq V_{IN} \leq 25\text{ V}$		17	50	
Load Regulation	REG_L	$T_j = 25\text{ }^\circ\text{C}$, $1\text{ mA} \leq I_o \leq 300\text{ mA}$		12	200	mV
		$T_j = 25\text{ }^\circ\text{C}$, $5\text{ mA} \leq I_o \leq 200\text{ mA}$		8	100	
Quiescent Current	I_{BIAS}	$T_j = 25\text{ }^\circ\text{C}$		3.6	5.0	mA
Quiescent Current Change	ΔI_{BIAS}	$13\text{ V} \leq V_{IN} \leq 30\text{ V}$			0.8	mA
		$1\text{ mA} \leq I_o \leq 300\text{ mA}$			0.5	
Output Noise Voltage	V_n	$T_j = 25\text{ }^\circ\text{C}$, $10\text{ Hz} \leq f \leq 100\text{ kHz}$		80	230	$\mu\text{V}_{r.m.s.}$
Ripple Rejection	$R \cdot R$	$T_j = 25\text{ }^\circ\text{C}$, $f = 120\text{ Hz}$, $13\text{ V} \leq V_{IN} \leq 23\text{ V}$	56	66		dB
Dropout Voltage	V_{DIF}	$T_j = 25\text{ }^\circ\text{C}$		1.7		V
Short Circuit Current	I_{short}	$T_j = 25\text{ }^\circ\text{C}$, $V_{IN} = 30\text{ V}$		100		mA
Peak Output Current	I_{peak}	$T_j = 25\text{ }^\circ\text{C}$	360	480	640	mA
Temperature coefficient of Output Voltage	$\Delta V_o/\Delta T$	$I_o = 5\text{ mA}$		0.2		$\text{mV}/^\circ\text{C}$

ELECTRICAL CHARACTERISTICS μPC78N12

($V_{IN} = 19\text{ V}$, $I_o = 200\text{ mA}$, $0\text{ }^\circ\text{C} \leq T_j \leq +125\text{ }^\circ\text{C}$, $C_{IN} = 0.33\text{ }\mu\text{F}$, $C_{OUT} = 0.1\text{ }\mu\text{F}$)

CHARACTERISTIC	SYMBOL	TEST CONDITIONS	MIN.	TYP.	MAX.	UNIT
Output Voltage	V_o	$T_j = 25\text{ }^\circ\text{C}$	11.5	12	12.5	V
		$14.5\text{ V} \leq V_{IN} \leq 27\text{ V}$, $5\text{ mA} \leq I_o \leq 200\text{ mA}$	11.4		12.6	
Line Regulation	REG_{IN}	$T_j = 25\text{ }^\circ\text{C}$, $14.5\text{ V} \leq V_{IN} \leq 30\text{ V}$		30	100	mV
		$T_j = 25\text{ }^\circ\text{C}$, $16\text{ V} \leq V_{IN} \leq 27\text{ V}$		20	50	
Load Regulation	REG_L	$T_j = 25\text{ }^\circ\text{C}$, $1\text{ mA} \leq I_o \leq 300\text{ mA}$		18	240	mV
		$T_j = 25\text{ }^\circ\text{C}$, $5\text{ mA} \leq I_o \leq 200\text{ mA}$		12	120	
Quiescent Current	I_{BIAS}	$T_j = 25\text{ }^\circ\text{C}$		3.6	5.0	mA
Quiescent Current Change	ΔI_{BIAS}	$14.5\text{ V} \leq V_{IN} \leq 30\text{ V}$			0.8	mA
		$1\text{ mA} \leq I_o \leq 300\text{ mA}$			0.5	
Output Noise Voltage	V_n	$T_j = 25\text{ }^\circ\text{C}$, $10\text{ Hz} \leq f \leq 100\text{ kHz}$		90	280	$\mu\text{V}_{r.m.s.}$
Ripple Rejection	$R \cdot R$	$T_j = 25\text{ }^\circ\text{C}$, $f = 120\text{ Hz}$, $15\text{ V} \leq V_{IN} \leq 25\text{ V}$	55	64		dB
Dropout Voltage	V_{DIF}	$T_j = 25\text{ }^\circ\text{C}$		1.7		V
Short Circuit Current	I_{short}	$T_j = 25\text{ }^\circ\text{C}$, $V_{IN} = 30\text{ V}$		100		mA
Peak Output Current	I_{peak}	$T_j = 25\text{ }^\circ\text{C}$	360	480	640	mA
Temperature coefficient of Output Voltage	$\Delta V_o/\Delta T$	$I_o = 5\text{ mA}$		0.3		$\text{mV}/^\circ\text{C}$

ELECTRICAL CHARACTERISTICS μPC78N15

($V_{IN} = 23\text{ V}$, $I_o = 200\text{ mA}$, $0\text{ °C} \leq T_j \leq +125\text{ °C}$, $C_{IN} = 0.33\text{ μF}$, $C_{OUT} = 0.1\text{ μF}$)

CHARACTERISTIC	SYMBOL	TEST CONDITIONS	MIN.	TYP.	MAX.	UNIT
Output Voltage	V_o	$T_j = 25\text{ °C}$	14.4	15	15.6	V
		$17.5\text{ V} \leq V_{IN} \leq 30\text{ V}$, $5\text{ mA} \leq I_o \leq 200\text{ mA}$	14.25		15.75	
Line Regulation	REG _{IN}	$T_j = 25\text{ °C}$, $17.5\text{ V} \leq V_{IN} \leq 30\text{ V}$		32	100	mV
		$T_j = 25\text{ °C}$, $20\text{ V} \leq V_{IN} \leq 30\text{ V}$		25	50	
Load Regulation	REG _L	$T_j = 25\text{ °C}$, $1\text{ mA} \leq I_o \leq 300\text{ mA}$		25	300	mV
		$T_j = 25\text{ °C}$, $5\text{ mA} \leq I_o \leq 200\text{ mA}$		16	150	
Quiescent Current	I _{BIAS}	$T_j = 25\text{ °C}$		3.7	5.0	mA
Quiescent Current Change	ΔI_{BIAS}	$17.5\text{ V} \leq V_{IN} \leq 30\text{ V}$			0.8	mA
		$1\text{ mA} \leq I_o \leq 300\text{ mA}$			0.5	
Output Noise Voltage	V_n	$T_j = 25\text{ °C}$, $10\text{ Hz} \leq f \leq 100\text{ kHz}$		100	350	μV _{r.m.s.}
Ripple Rejection	R · R	$T_j = 25\text{ °C}$, $f = 120\text{ Hz}$, $18.5\text{ V} \leq V_{IN} \leq 28.5\text{ V}$	54	62		dB
Dropout Voltage	V _{DIF}	$T_j = 25\text{ °C}$		1.7		V
Short Circuit Current	I _{Oshort}	$T_j = 25\text{ °C}$, $V_{IN} = 30\text{ V}$		100		mA
Peak Output Current	I _{Opeak}	$T_j = 25\text{ °C}$	360	470	640	mA
Temperature coefficient of Output Voltage	$\Delta V_o / \Delta T$	$I_o = 5\text{ mA}$		0.5		mV/°C

ELECTRICAL CHARACTERISTICS μPC78N18

($V_{IN} = 27\text{ V}$, $I_o = 200\text{ mA}$, $0\text{ °C} \leq T_j \leq +125\text{ °C}$, $C_{IN} = 0.33\text{ μF}$, $C_{OUT} = 0.1\text{ μF}$)

CHARACTERISTIC	SYMBOL	TEST CONDITIONS	MIN.	TYP.	MAX.	UNIT
Output Voltage	V_o	$T_j = 25\text{ °C}$	17.3	18	18.7	V
		$21\text{ V} \leq V_{IN} \leq 33\text{ V}$, $5\text{ mA} \leq I_o \leq 200\text{ mA}$	17.1		18.9	
Line Regulation	REG _{IN}	$T_j = 25\text{ °C}$, $21\text{ V} \leq V_{IN} \leq 33\text{ V}$		32	100	mV
		$T_j = 25\text{ °C}$, $22\text{ V} \leq V_{IN} \leq 33\text{ V}$		25	50	
Load Regulation	REG _L	$T_j = 25\text{ °C}$, $1\text{ mA} \leq I_o \leq 300\text{ mA}$		30	360	mV
		$T_j = 25\text{ °C}$, $5\text{ mA} \leq I_o \leq 200\text{ mA}$		20	180	
Quiescent Current	I _{BIAS}	$T_j = 25\text{ °C}$		3.7	5.0	mA
Quiescent Current Change	ΔI_{BIAS}	$21\text{ V} \leq V_{IN} \leq 33\text{ V}$			0.8	mA
		$1\text{ mA} \leq I_o \leq 300\text{ mA}$			0.5	
Output Noise Voltage	V_n	$T_j = 25\text{ °C}$, $10\text{ Hz} \leq f \leq 100\text{ kHz}$		115	420	μV _{r.m.s.}
Ripple Rejection	R · R	$T_j = 25\text{ °C}$, $f = 120\text{ Hz}$, $22\text{ V} \leq V_{IN} \leq 32\text{ V}$	53	60		dB
Dropout Voltage	V _{DIF}	$T_j = 25\text{ °C}$		1.7		V
Short Circuit Current	I _{Oshort}	$T_j = 25\text{ °C}$, $V_{IN} = 33\text{ V}$		60		mA
Peak Output Current	I _{Opeak}	$T_j = 25\text{ °C}$	360	460	640	mA
Temperature coefficient of Output Voltage	$\Delta V_o / \Delta T$	$I_o = 5\text{ mA}$		0.5		mV/°C

ELECTRICAL CHARACTERISTICS μ PC78N24

($V_{IN} = 33\text{ V}$, $I_o = 200\text{ mA}$, $0\text{ }^\circ\text{C} \leq T_j \leq +125\text{ }^\circ\text{C}$, $C_{IN} = 0.33\text{ }\mu\text{F}$, $C_{OUT} = 0.1\text{ }\mu\text{F}$)

CHARACTERISTIC	SYMBOL	TEST CONDITIONS	MIN.	TYP.	MAX.	UNIT
Output Voltage	V_o	$T_j = 25\text{ }^\circ\text{C}$	23	24	25	V
		$27\text{ V} \leq V_{IN} \leq 38\text{ V}$, $5\text{ mA} \leq I_o \leq 200\text{ mA}$	22.8		25.2	
Line Regulation	REG _{IN}	$T_j = 25\text{ }^\circ\text{C}$, $27\text{ V} \leq V_{IN} \leq 38\text{ V}$		40	100	mV
		$T_j = 25\text{ }^\circ\text{C}$, $28\text{ V} \leq V_{IN} \leq 38\text{ V}$		30	50	
Load Regulation	REG _L	$T_j = 25\text{ }^\circ\text{C}$, $1\text{ mA} \leq I_o \leq 300\text{ mA}$		35	480	mV
		$T_j = 25\text{ }^\circ\text{C}$, $5\text{ mA} \leq I_o \leq 200\text{ mA}$		23	240	
Quiescent Current	I _{BIAS}	$T_j = 25\text{ }^\circ\text{C}$		3.7	5.0	mA
Quiescent Current Change	ΔI_{BIAS}	$27\text{ V} \leq V_{IN} \leq 38\text{ V}$			0.8	mA
		$1\text{ mA} \leq I_o \leq 300\text{ mA}$			0.5	
Output Noise Voltage	V_n	$T_j = 25\text{ }^\circ\text{C}$, $10\text{ Hz} \leq f \leq 100\text{ kHz}$		135	560	$\mu\text{V}_{r.m.s.}$
Ripple Rejection	R · R	$T_j = 25\text{ }^\circ\text{C}$, $f = 120\text{ Hz}$, $28\text{ V} \leq V_{IN} \leq 38\text{ V}$	50	57		dB
Dropout Voltage	V _{DIF}	$T_j = 25\text{ }^\circ\text{C}$		1.7		V
Short Circuit Current	I _{Oshort}	$T_j = 25\text{ }^\circ\text{C}$, $V_{IN} = 38\text{ V}$		5		mA
Peak Output Current	I _{Opeak}	$T_j = 25\text{ }^\circ\text{C}$	360	460	640	mA
Temperature coefficient of Output Voltage	$\Delta V_o/\Delta T$	$I_o = 5\text{ mA}$		0.7		mV/°C

Not recommended for new design

TYPICAL CHARACTERISTICS ($T_a = 25^\circ\text{C}$)

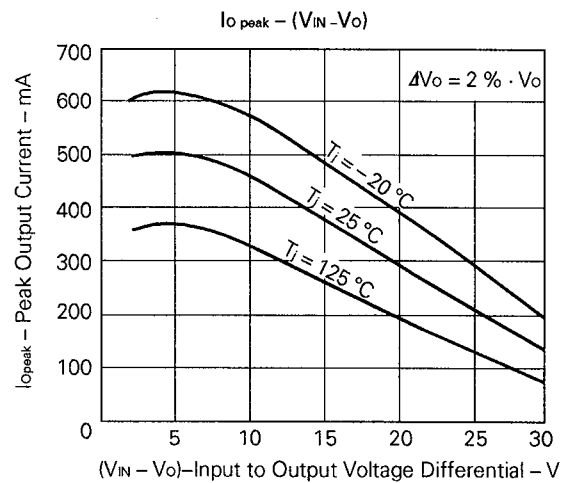
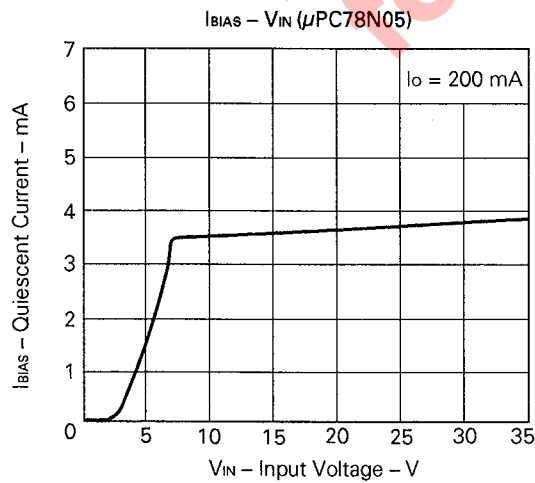
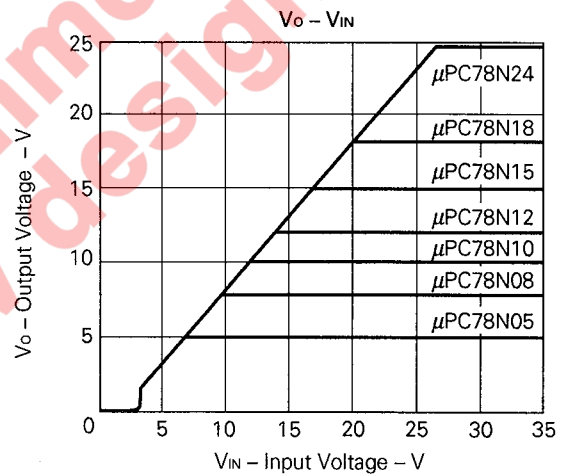
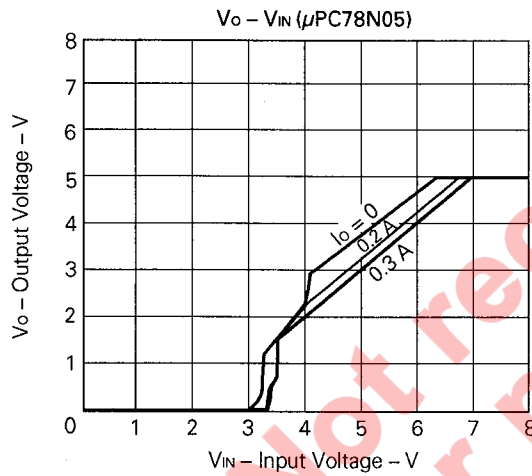
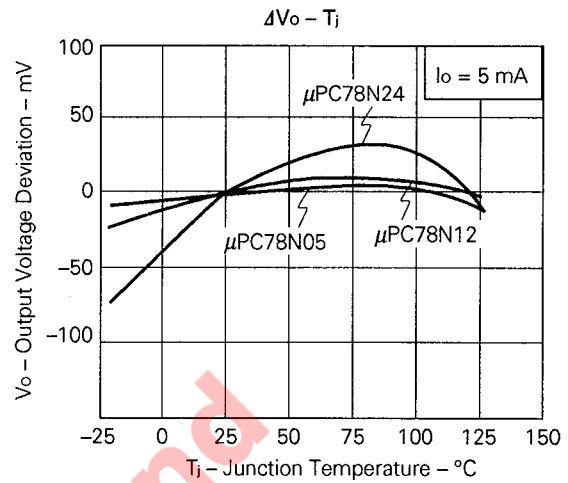
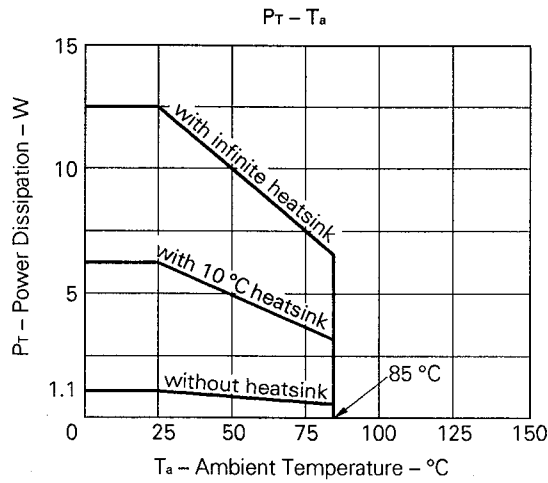

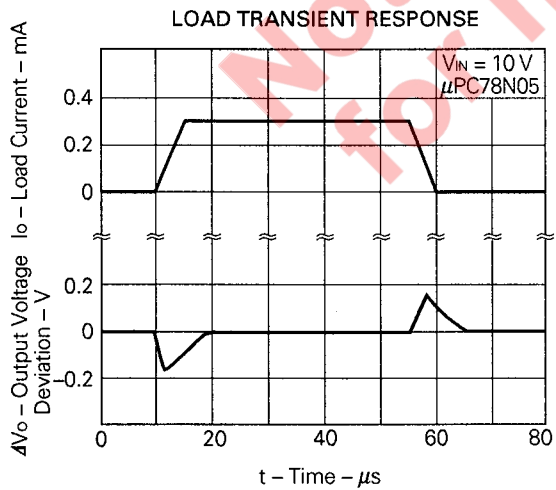
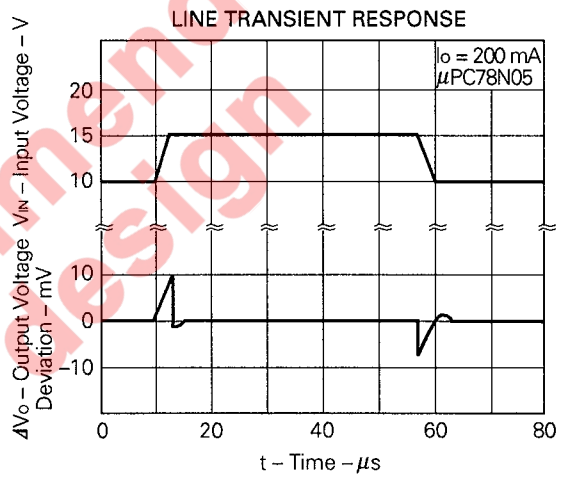
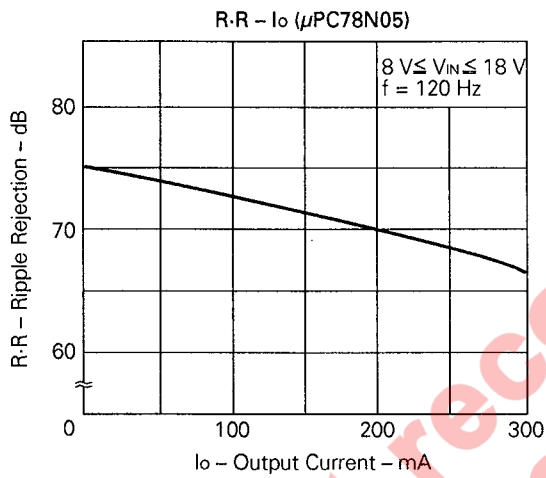
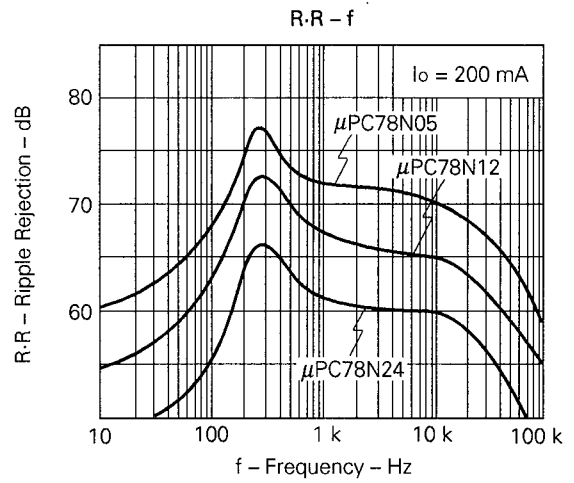
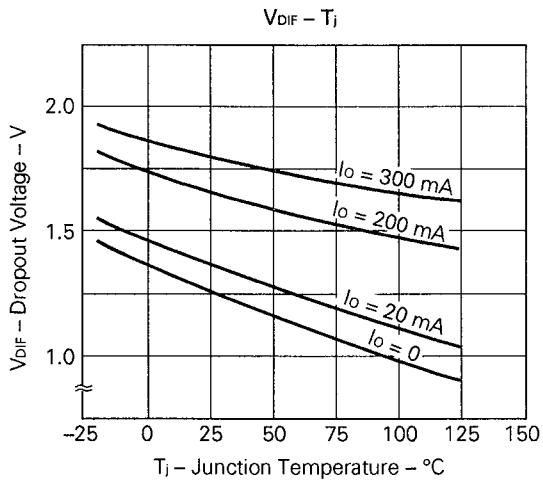

PACKAGE DIMENSIONS (Unit: mm)

μPC78N00H Series

3 PIN PLASTIC SIP (TO-126)

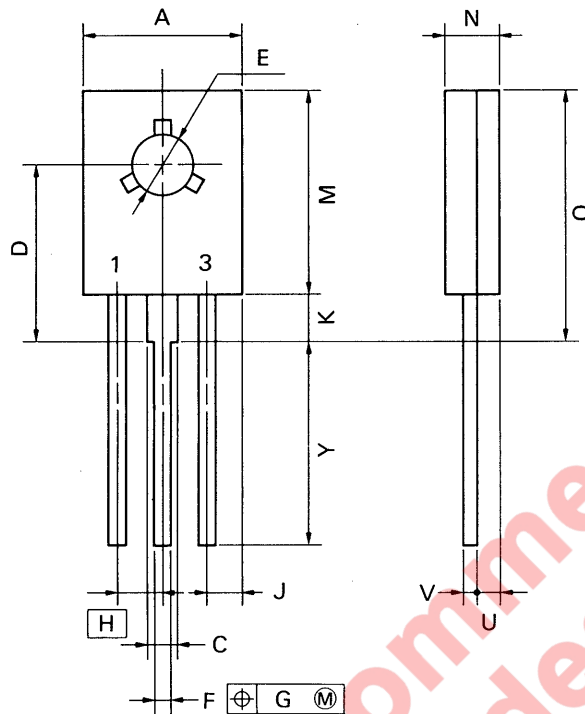

P3HP-230B

NOTE

Each lead centerline is located within 0.23 mm (0.009 inch) of its true position (T.P.) at maximum material condition.

ITEM	MILLIMETERS	INCHES
A	8.5 MAX.	0.335 MAX.
C	1.1 MIN.	0.043 MIN.
D	9.7 ^{±0.3}	0.382 ^{±0.012}
E	φ3.2 ^{±0.1}	φ0.126 ^{±0.004}
F	0.80 ^{±0.1}	0.031 ^{±0.005}
G	0.23	0.009
H	2.3	0.091
J	1.95 MAX.	0.077 MAX.
K	2.3 MIN.	0.09 MIN.
M	11.5 MAX.	0.453 MAX.
N	2.7 ^{±0.2}	0.106 ^{±0.008}
Q	14.5 MAX.	0.571 MAX.
U	1.7 MAX.	0.067 MAX.
V	0.55 ^{±0.1}	0.022 ^{±0.005}
Y	13.5 ^{±0.7}	0.531 ^{±0.028}

RECOMMENDED SOLDERING CONDITIONS

The following conditions (see table below) must be met when soldering this product.

Please consult with our sales offices in case other soldering process is used, or in case soldering is done under different conditions.

<TYPES OF THROUGH HOLE MOUNT DEVICE>

[μPC78N00H Series]

Soldering process	Soldering condition	Symbol
Wave soldering	Solder temperature: 260 °C or below, Flow time: 10 seconds or below	

**Not recommend
for new design**

Reference

Application note name	No.
Quality control of NEC semiconductor devices	TEI-1202
Quality control guide of semiconductors devices	MEI-1202
Assembly manual of semiconductors devices	IEI-1207
NEC semiconductor device reliability/quality control system	IEI-1212

**Not recommend
for new design**

[MEMO]

No part of this document may be copied or reproduced in any form or by any means without the prior written consent of NEC Corporation. NEC Corporation assumes no responsibility for any errors which may appear in this document.

NEC Corporation does not assume any liability for infringement of patents, copyrights or other intellectual property rights of third parties by or arising from use of a device described herein or any other liability arising from use of such device. No license, either express, implied or otherwise, is granted under any patents, copyrights or other intellectual property rights of NEC Corporation or others.

The devices listed in this document are not suitable for use in aerospace equipment, submarine cables, nuclear reactor control systems and life support systems. If customers intend to use NEC devices for above applications or they intend to use "Standard" quality grade NEC devices for applications not intended by NEC, please contact our sales people in advance.

Application examples recommended by NEC Corporation.

Standard: Computer, Office equipment, Communication equipment, Test and Measurement equipment, Machine tools, Industrial robots, Audio and Visual equipment, Other consumer products, etc.

Special: Automotive and Transportation equipment, Traffic control systems, Antidisaster systems, Anticrime systems, etc.