

To our customers,

Old Company Name in Catalogs and Other Documents

On April 1st, 2010, NEC Electronics Corporation merged with Renesas Technology Corporation, and Renesas Electronics Corporation took over all the business of both companies. Therefore, although the old company name remains in this document, it is a valid Renesas Electronics document. We appreciate your understanding.

Renesas Electronics website: <http://www.renesas.com>

April 1st, 2010
Renesas Electronics Corporation

Issued by: Renesas Electronics Corporation (<http://www.renesas.com>)

Send any inquiries to <http://www.renesas.com/inquiry>.

Not recommended
for new design

Notice

1. All information included in this document is current as of the date this document is issued. Such information, however, is subject to change without any prior notice. Before purchasing or using any Renesas Electronics products listed herein, please confirm the latest product information with a Renesas Electronics sales office. Also, please pay regular and careful attention to additional and different information to be disclosed by Renesas Electronics such as that disclosed through our website.
2. Renesas Electronics does not assume any liability for infringement of patents, copyrights, or other intellectual property rights of third parties by or arising from the use of Renesas Electronics products or technical information described in this document. No license, express, implied or otherwise, is granted hereby under any patents, copyrights or other intellectual property rights of Renesas Electronics or others.
3. You should not alter, modify, copy, or otherwise misappropriate any Renesas Electronics product, whether in whole or in part.
4. Descriptions of circuits, software and other related information in this document are provided only to illustrate the operation of semiconductor products and application examples. You are fully responsible for the incorporation of these circuits, software, and information in the design of your equipment. Renesas Electronics assumes no responsibility for any losses incurred by you or third parties arising from the use of these circuits, software, or information.
5. When exporting the products or technology described in this document, you should comply with the applicable export control laws and regulations and follow the procedures required by such laws and regulations. You should not use Renesas Electronics products or the technology described in this document for any purpose relating to military applications or use by the military, including but not limited to the development of weapons of mass destruction. Renesas Electronics products and technology may not be used for or incorporated into any products or systems whose manufacture, use, or sale is prohibited under any applicable domestic or foreign laws or regulations.
6. Renesas Electronics has used reasonable care in preparing the information included in this document, but Renesas Electronics does not warrant that such information is error free. Renesas Electronics assumes no liability whatsoever for any damages incurred by you resulting from errors in or omissions from the information included herein.
7. Renesas Electronics products are classified according to the following three quality grades: “Standard”, “High Quality”, and “Specific”. The recommended applications for each Renesas Electronics product depends on the product’s quality grade, as indicated below. You must check the quality grade of each Renesas Electronics product before using it in a particular application. You may not use any Renesas Electronics product for any application categorized as “Specific” without the prior written consent of Renesas Electronics. Further, you may not use any Renesas Electronics product for any application for which it is not intended without the prior written consent of Renesas Electronics. Renesas Electronics shall not be in any way liable for any damages or losses incurred by you or third parties arising from the use of any Renesas Electronics product for an application categorized as “Specific” or for which the product is not intended where you have failed to obtain the prior written consent of Renesas Electronics. The quality grade of each Renesas Electronics product is “Standard” unless otherwise expressly specified in a Renesas Electronics data sheets or data books, etc.
 - “Standard”: Computers; office equipment; communications equipment; test and measurement equipment; audio and visual equipment; home electronic appliances; machine tools; personal electronic equipment; and industrial robots.
 - “High Quality”: Transportation equipment (automobiles, trains, ships, etc.); traffic control systems; anti-disaster systems; anti-crime systems; safety equipment; and medical equipment not specifically designed for life support.
 - “Specific”: Aircraft; aerospace equipment; submersible repeaters; nuclear reactor control systems; medical equipment or systems for life support (e.g. artificial life support devices or systems), surgical implantations, or healthcare intervention (e.g. excision, etc.), and any other applications or purposes that pose a direct threat to human life.
8. You should use the Renesas Electronics products described in this document within the range specified by Renesas Electronics, especially with respect to the maximum rating, operating supply voltage range, movement power voltage range, heat radiation characteristics, installation and other product characteristics. Renesas Electronics shall have no liability for malfunctions or damages arising out of the use of Renesas Electronics products beyond such specified ranges.
9. Although Renesas Electronics endeavors to improve the quality and reliability of its products, semiconductor products have specific characteristics such as the occurrence of failure at a certain rate and malfunctions under certain use conditions. Further, Renesas Electronics products are not subject to radiation resistance design. Please be sure to implement safety measures to guard them against the possibility of physical injury, and injury or damage caused by fire in the event of the failure of a Renesas Electronics product, such as safety design for hardware and software including but not limited to redundancy, fire control and malfunction prevention, appropriate treatment for aging degradation or any other appropriate measures. Because the evaluation of microcomputer software alone is very difficult, please evaluate the safety of the final products or system manufactured by you.
10. Please contact a Renesas Electronics sales office for details as to environmental matters such as the environmental compatibility of each Renesas Electronics product. Please use Renesas Electronics products in compliance with all applicable laws and regulations that regulate the inclusion or use of controlled substances, including without limitation, the EU RoHS Directive. Renesas Electronics assumes no liability for damages or losses occurring as a result of your noncompliance with applicable laws and regulations.
11. This document may not be reproduced or duplicated, in any form, in whole or in part, without prior written consent of Renesas Electronics.
12. Please contact a Renesas Electronics sales office if you have any questions regarding the information contained in this document or Renesas Electronics products, or if you have any other inquiries.

(Note 1) “Renesas Electronics” as used in this document means Renesas Electronics Corporation and also includes its majority-owned subsidiaries.

(Note 2) “Renesas Electronics product(s)” means any product developed or manufactured by or for Renesas Electronics.

BIPOLAR ANALOG INTEGRATED CIRCUIT
μPC3221GV

GENERAL PURPOSE 5 V 100 MHz AGC AMPLIFIER

DESCRIPTION

The μPC3221GV is a silicon monolithic IC designed for use as AGC amplifier for digital CATV, cable modem systems. This IC consists of gain control amplifier and video amplifier.

The package is 8-pin SSOP suitable for surface mount.

This IC is manufactured using our 10 GHz fr NESAT II AL silicon bipolar process. This process uses silicon nitride passivation film. This material can protect chip surface from external pollution and prevent corrosion/migration. Thus, this IC has excellent performance, uniformity and reliability.

FEATURES

- Low distortion : IM₃ = 56 dBc TYP. @ single-ended output, V_{out} = 0.7 V_{p-p}/tone
- Low noise figure : NF = 4.2 dB TYP.
- Wide AGC dynamic range : GCR = 50 dB TYP. @ input prescribe
- On-chip video amplifier : V_{out} = 1.0 V_{p-p} TYP. @ single-ended output
- Supply voltage : V_{CC} = 5.0 V TYP.
- Packaged in 8-pin SSOP suitable for surface mounting

APPLICATION

- Digital CATV/Cable modem receivers

ORDERING INFORMATION

Part Number	Package	Supplying Form
μPC3221GV-E1	8-pin plastic SSOP (4.45 mm (175))	<ul style="list-style-type: none"> • Embossed tape 8 mm wide • Pin 1 indicates pull-out direction of tape • Qty 1 kpcs/reel

Remark To order evaluation samples, contact your nearby sales office.
 Part number for sample order: μPC3221GV

Caution Observe precautions when handling because these devices are sensitive to electrostatic discharge.

The information in this document is subject to change without notice. Before using this document, please confirm that this is the latest version.
 Not all devices/types available in every country. Please check with local NEC Compound Semiconductor Devices representative for availability and additional information.

INTERNAL BLOCK DIAGRAM AND PIN CONNECTIONS

(Top View)

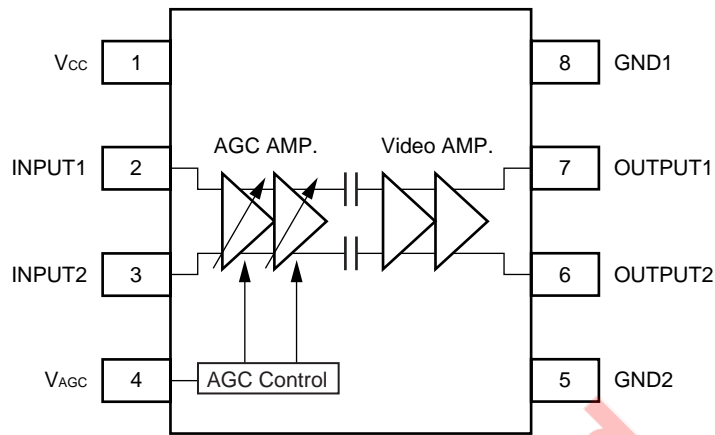

PRODUCT LINE-UP OF 5 V AGC AMPLIFIER

Part Number	I _{CC} (mA)	G _{MAX} (dB)	G _{MIN} (dB)	GCR (dB)	NF (dB)	IM ₃ (dBc) ^{Note}	Package
μ PC3217GV	23	53	0	53	6.5	50	8-pin SSOP (4.45 mm (175))
μ PC3218GV	23	63	10	53	3.5	50	
μ PC3219GV	36.5	42.5	0	42.5	9.0	58	
μ PC3221GV	33	60	10	50	4.2	56	

Note f₁ = 44 MHz, f₂ = 45 MHz, V_{out} = 0.7 V_{p-p}/tone, single-ended output

Not recommended for new design

PIN EXPLANATIONS

Pin No.	Pin Name	Applied Voltage (V)	Pin Voltage (V) ^{Note}	Function and Application	Internal Equivalent Circuit
1	V _{CC}	4.5 to 5.5	—	Power supply pin. This pin should be externally equipped with bypass capacitor to minimize ground impedance.	—
2	INPUT1	—	1.29	Signal input pins to AGC amplifier. This pin should be coupled with capacitor for DC cut.	
3	INPUT2	—	1.29		
4	V _{AGC}	0 to V _{CC}	—	Gain control pin. This pin's bias govern the AGC output level. Minimum Gain at V _{AGC} : 0 to 0.5 V Maximum Gain at V _{AGC} : 3 to 3.5 V Recommended to use AGC voltage with externally resistor (example: 1 kΩ).	
5	GND2	0	—	Ground pin. This pin should be connected to system ground with minimum inductance. Ground pattern on the board should be formed as wide as possible.	—
6	OUTPUT2	—	2.28	Signal output pins of video amplifier. This pin should be coupled with capacitor for DC cut.	
7	OUTPUT1	—	2.28		
8	GND1	0	—	Ground pin. This should be connected to system ground with minimum inductance. Ground pattern on the board should be formed as wide as possible. All ground pins must be connected together with wide ground pattern to decrease impedance difference.	—

Note Pin voltage is measured at V_{CC} = 5.0 V.

ABSOLUTE MAXIMUM RATINGS

Parameter	Symbol	Test Conditions	Ratings	Unit
Supply Voltage	V _{CC}	T _A = +25°C	6.0	V
Gain Control Voltage Range	V _{AGC}	T _A = +25°C	0 to V _{CC}	V
Power Dissipation	P _D	T _A = +85°C Note	250	mW
Operating Ambient Temperature	T _A		-40 to +85	°C
Storage Temperature	T _{stg}		-55 to +150	°C

Note Mounted on double-sided copper-clad 50 × 50 × 1.6 mm epoxy glass PWB

RECOMMENDED OPERATING RANGE

Parameter	Symbol	Test Conditions	MIN.	TYP.	MAX.	Unit
Supply Voltage	V _{CC}		4.5	5.0	5.5	V
Operating Ambient Temperature	T _A	V _{CC} = 4.5 to 5.5 V	-40	+25	+85	°C
Gain Control Voltage Range	V _{AGC}		0	-	3.5	V
Operating Frequency Range	f _{BW}		10	45	100	MHz

Not recommended for new design

ELECTRICAL CHARACTERISTICS

(T_A = +25°C, V_{CC} = 5 V, f = 45 MHz, Z_s = 50 Ω, Z_L = 250 Ω, single-ended output)

Parameter	Symbol	Test Conditions	MIN.	TYP.	MAX.	Unit
DC Characteristics						
Circuit Current	I _{CC}	No input signal Note 1	26	33	41	mA
AGC Pin Current	I _{AGC}	No input signal, V _{AGC} = 3.5 V Note 1	–	16	50	μA
AGC Voltage High Level	V _{AGC (H)}	@ Maximum gain Note 1	3.0	–	3.5	V
AGC Voltage Low Level	V _{AGC (L)}	@ Minimum gain Note 1	0	–	0.5	V
RF Characteristics						
Maximum Voltage Gain	G _{MAX}	V _{AGC} = 3.0 V, P _{in} = –60 dBm Note 1	57	60	63	dB
Middle Voltage Gain 1	G _{MID1}	V _{AGC} = 2.2 V, P _{in} = –60 dBm Note 1	47.5	50.5	53.5	dB
Middle Voltage Gain 2	G _{MID2}	V _{AGC} = 1.2 V, P _{in} = –30 dBm Note 1	18	21	24	dB
Minimum Voltage Gain	G _{MIN}	V _{AGC} = 0.5 V, P _{in} = –30 dBm Note 1	6	10	14	dB
Gain Control Range (input prescribe)	GCR _{in}	V _{AGC} = 0.5 to 3.0 V Note 1	43	50	–	dB
Gain Control Range (output prescribe)	GCR _{out}	V _{out} = 1.0 V _{p-p} Note 1	36	40	–	dB
Gain Slope	G _{slope}	Gain (@ V _{AGC} = 2.2 V) – Gain (@ V _{AGC} = 1.2 V) Note 1	26.5	29.5	32.5	dB/V
Maximum Output Voltage	V _{oclip}	V _{AGC} = 3.0 V (@ Maximum gain) Note 1	2.0	2.8	–	V _{p-p}
Noise Figure	NF	V _{AGC} = 3.0 V (@ Maximum gain) Note 3	–	4.2	5.7	dB
3rd Order Intermodulation Distortion 1	IM ₃₁	f ₁ = 44 MHz, f ₂ = 45 MHz, Z _L = 250 Ω, P _{in} = –30 dBm/tone, V _{out} = 0.7 V _{p-p} /tone (@ single-ended output) Note 1	43	47	–	dBc
3rd Order Intermodulation Distortion 2	IM ₃₂	f ₁ = 44 MHz, f ₂ = 45 MHz, Z _L = 250 Ω, V _{AGC} = 3.0 V (@ Maximum gain), V _{out} = 0.7 V _{p-p} /tone (@ single-ended output) Note 1	50	56	–	dBc
Gain Difference of OUTPUT1 and OUTPUT2	ΔG	V _{AGC} = 3.0 V, P _{in} = –60 dBm, ΔG = G (@ P _{out1}) – G (@ P _{out2}) Note 1, 2	–0.5	0	+0.5	dB

- Notes 1.** By measurement circuit 1
- 2.** By measurement circuit 2
- 3.** By measurement circuit 3

STANDARD CHARACTERISTICS (T_A = +25°C, V_{CC} = 5 V, Z_S = 50 Ω)

Parameter	Symbol	Test Conditions	Reference Value	Unit
Noise Figure 2	NF2	Gain reduction = -10 dBm Note 2	6.0	dB
Noise Figure 3	NF3	Gain reduction = -20 dBm Note 2	9.5	dB
Output Voltage	V _{out}	P _{in} = -56 to -16 dBm Note 1	1.0	V _{P-P}
Input Impedance	Z _{in}	V _{AGC} = 0.5 V, f = 45 MHz Note 3	0.9 k - j1.4 k	Ω
Output Impedance	Z _{out}	V _{AGC} = 0.5 V, f = 45 MHz Note 3	9.0 + j1.9	Ω
Input 3rd Order Distortion Intercept Point	IIP ₃	V _{AGC} = 0.5 V (@ Minimum gain), f ₁ = 44 MHz, f ₂ = 45 MHz, Z _L = 250 Ω (@ single-ended output) Note 1	+2.5	dBm

- Notes 1.** By measurement circuit 1
- 2.** By measurement circuit 3
- 3.** By measurement circuit 4

Not recommend
for new design

MEASUREMENT CIRCUIT 1

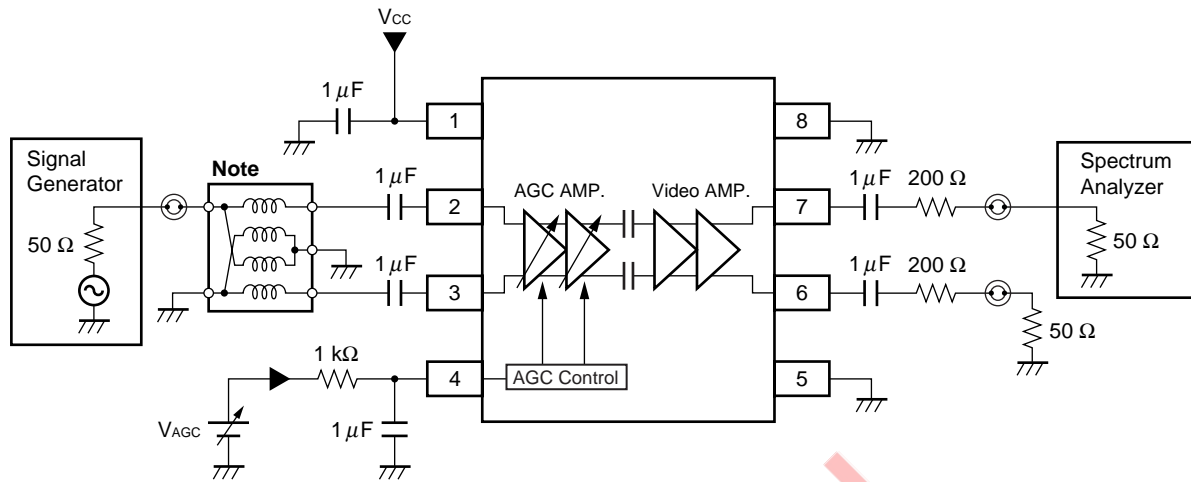

Note Balun Transformer: TOKO 617DB-1010 B4F (Double balanced type)

MEASUREMENT CIRCUIT 2

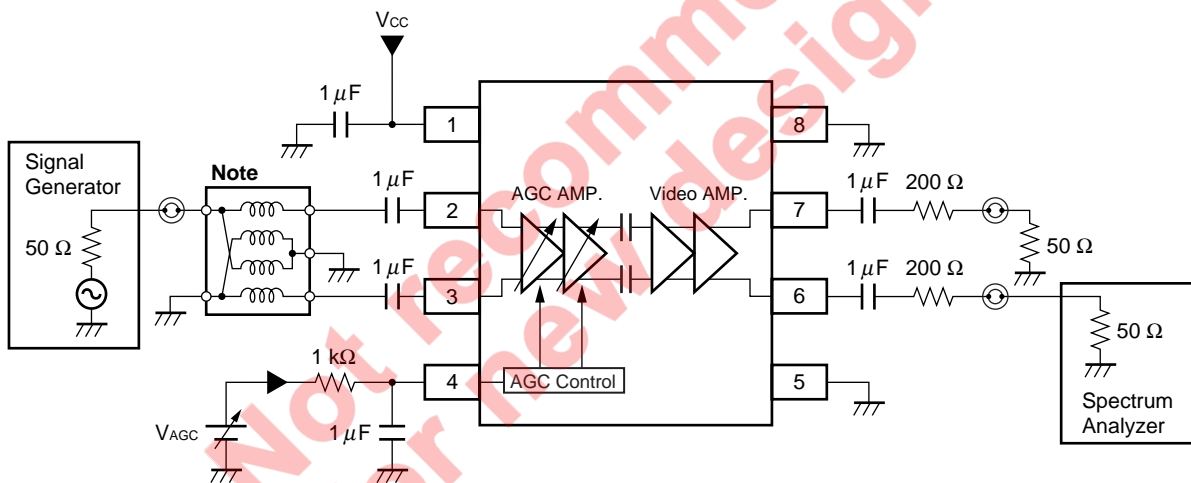

Note Balun Transformer: TOKO 617DB-1010 B4F (Double balanced type)

MEASUREMENT CIRCUIT 3

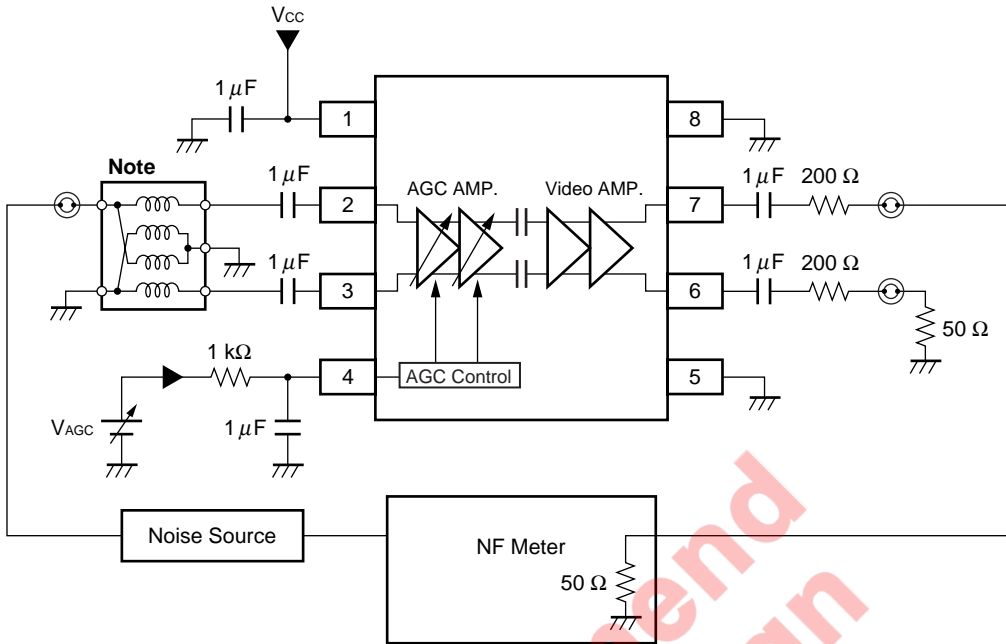

Note Balun Transformer: TOKO 617DB-1010 B4F (Double balanced type)

MEASUREMENT CIRCUIT 4

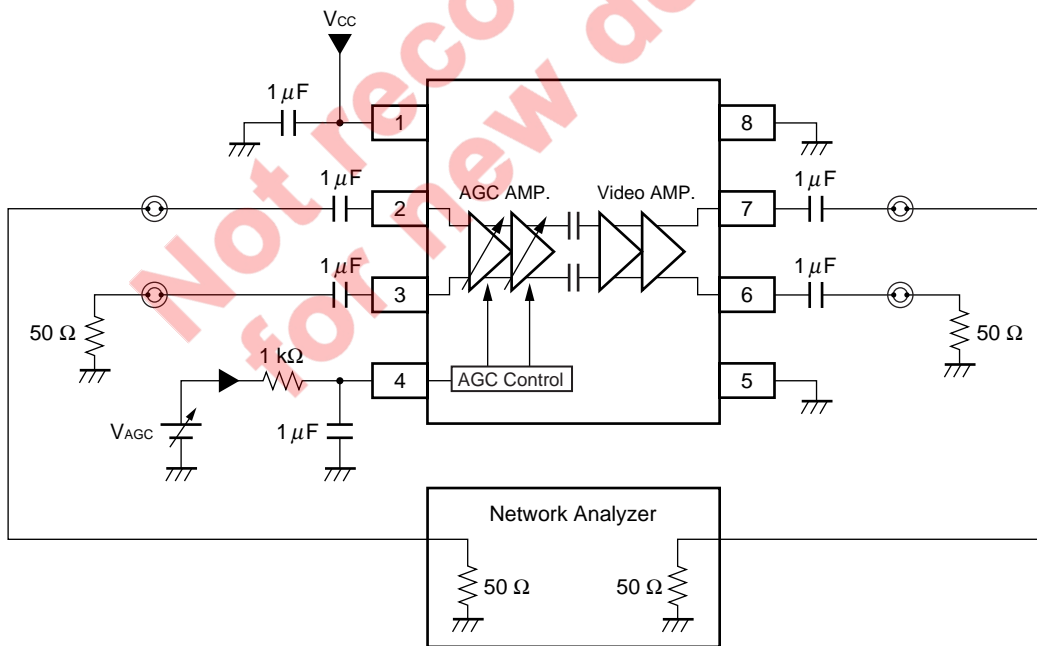

The application circuits and their parameters are for reference only and are not intended for use in actual design-ins.

★ ILLUSTRATION OF THE TEST CIRCUIT ASSEMBLED ON EVALUATION BOARD
(MEASUREMENT CIRCUIT 1)

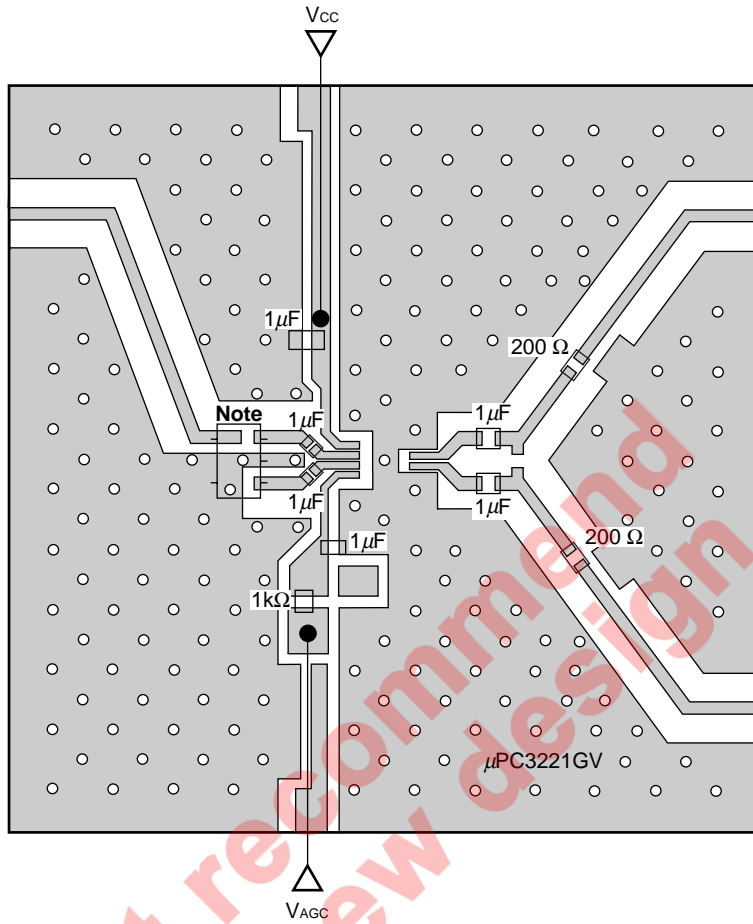

Note Balun Transformer

Remarks

1. Back side: GND pattern
2. Solder plated on pattern
3. o: Through hole

★ TYPICAL CHARACTERISTICS ($T_A = +25^\circ\text{C}$, unless otherwise specified)

CIRCUIT CURRENT vs. SUPPLY VOLTAGE

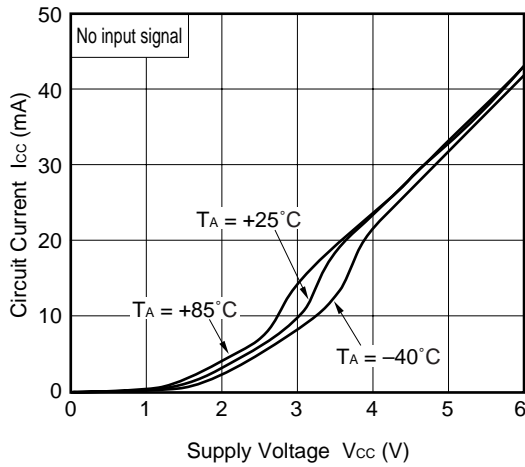

VOLTAGE GAIN vs. FREQUENCY

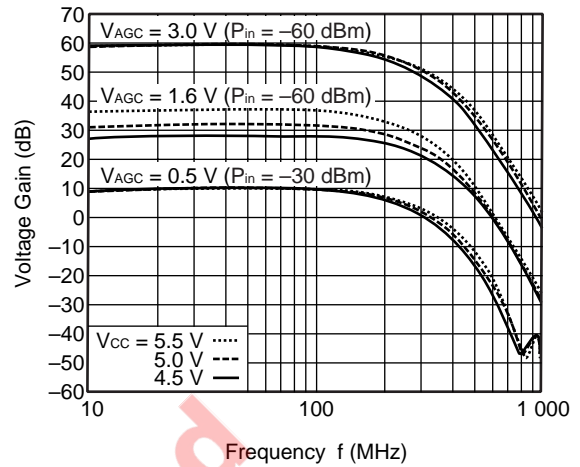

AGC PIN CURRENT vs. GAIN CONTROL VOLTAGE RANGE

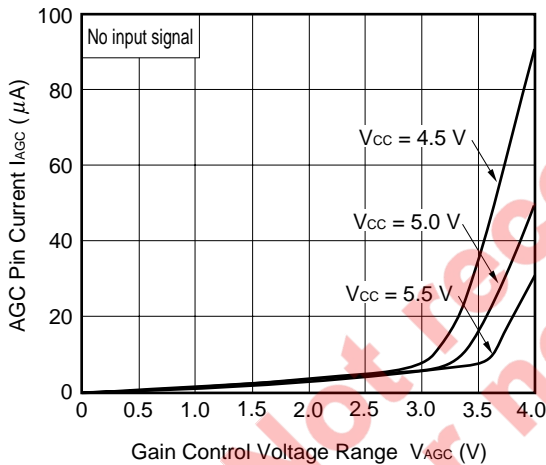

AGC PIN CURRENT vs. GAIN CONTROL VOLTAGE RANGE

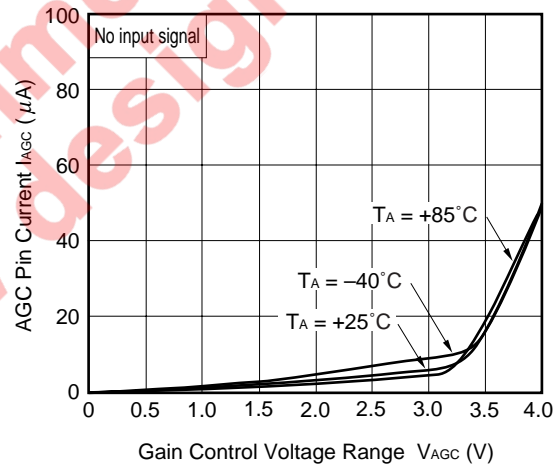

VOLTAGE GAIN vs. GAIN CONTROL VOLTAGE RANGE

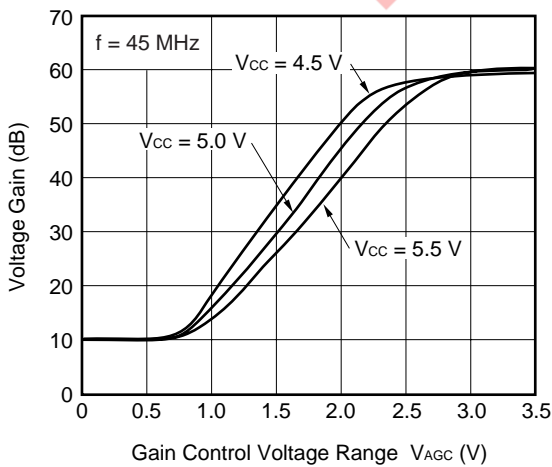

VOLTAGE GAIN vs. GAIN CONTROL VOLTAGE RANGE

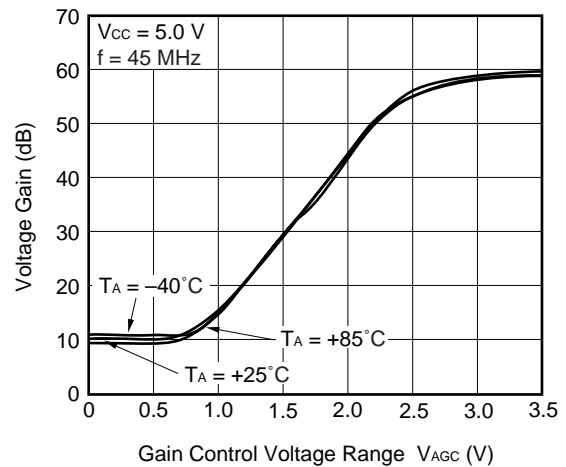

Remark The graphs indicate nominal characteristics.

OUTPUT POWER vs. INPUT POWER

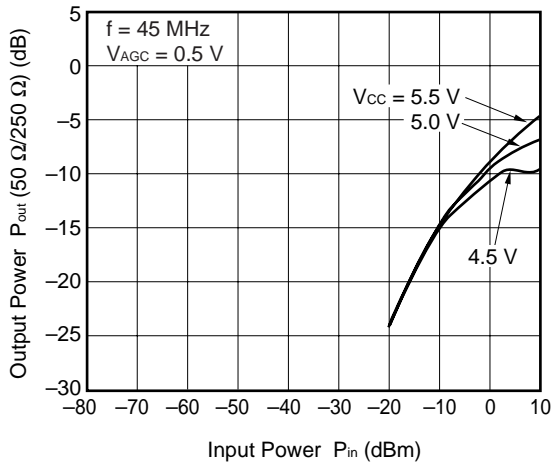

OUTPUT POWER vs. INPUT POWER

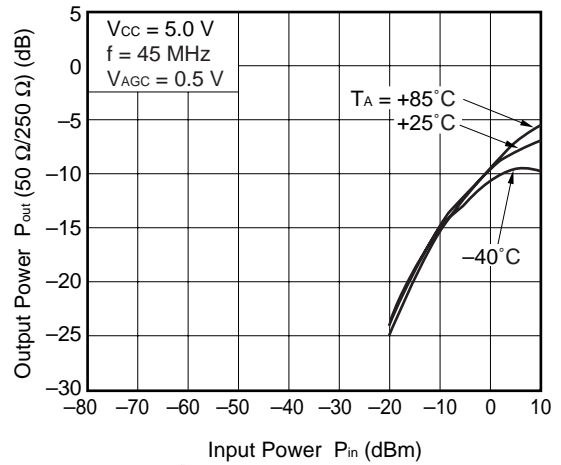

OUTPUT POWER vs. INPUT POWER

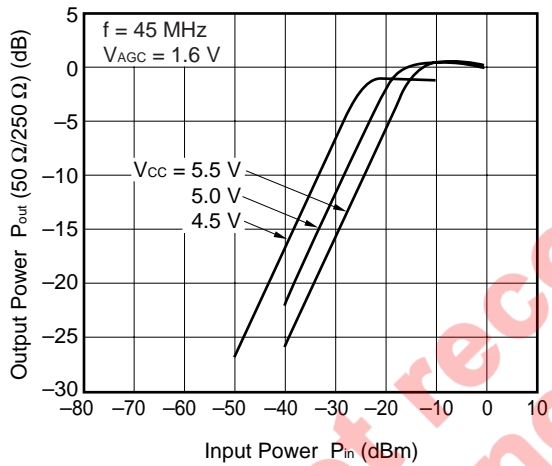

OUTPUT POWER vs. INPUT POWER

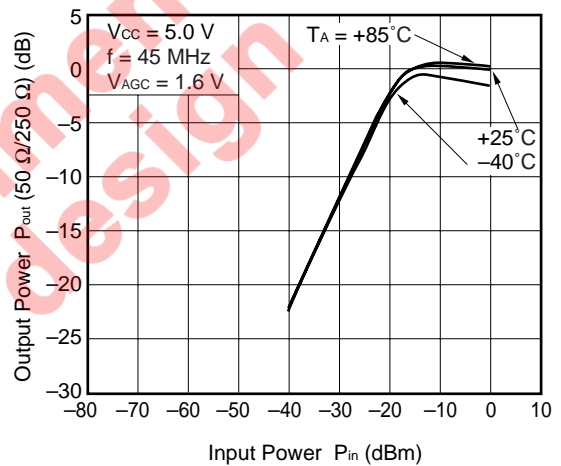

OUTPUT POWER vs. INPUT POWER

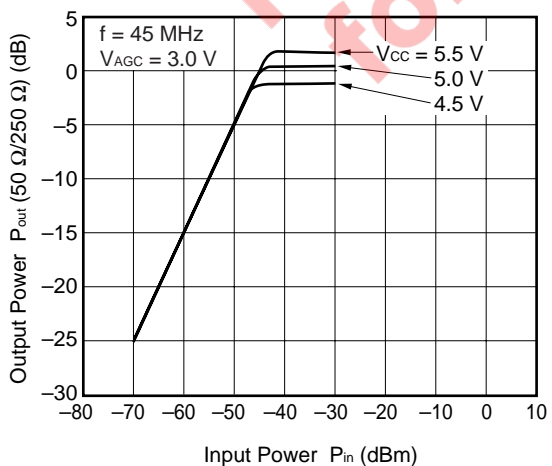

OUTPUT POWER vs. INPUT POWER

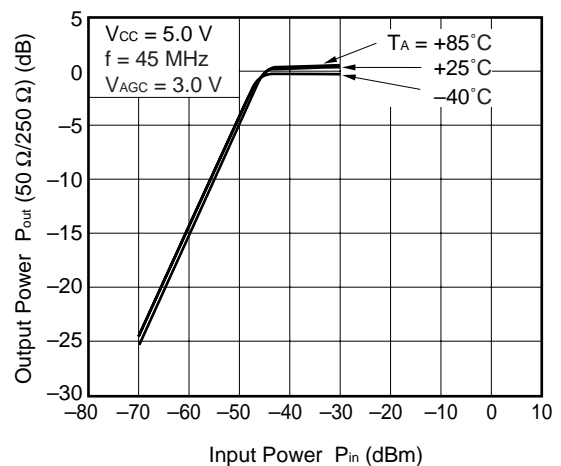

Remark The graphs indicate nominal characteristics.

NOISE FIGURE vs. GAIN CONTROL VOLTAGE RANGE

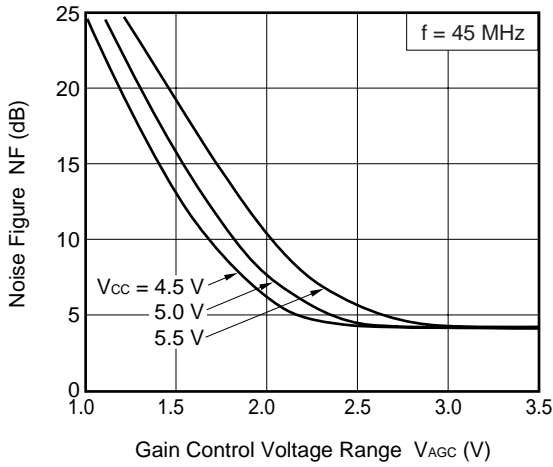

NOISE FIGURE vs. GAIN CONTROL VOLTAGE RANGE

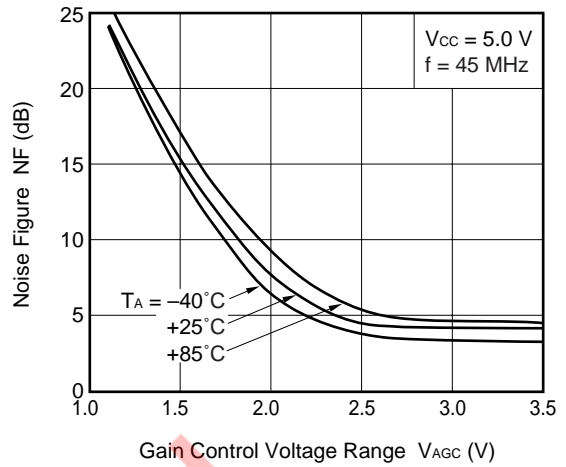

NOISE FIGURE vs. GAIN REDUCTION

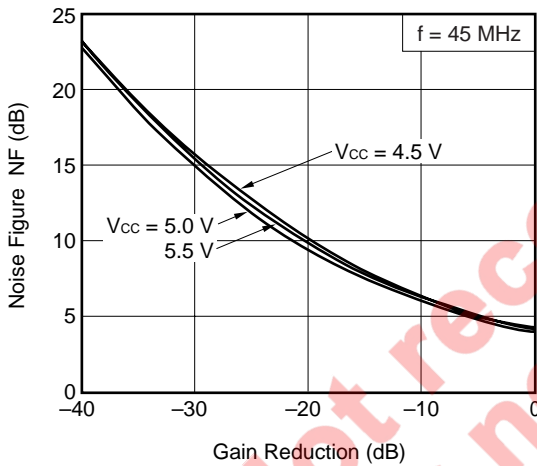

NOISE FIGURE vs. GAIN REDUCTION

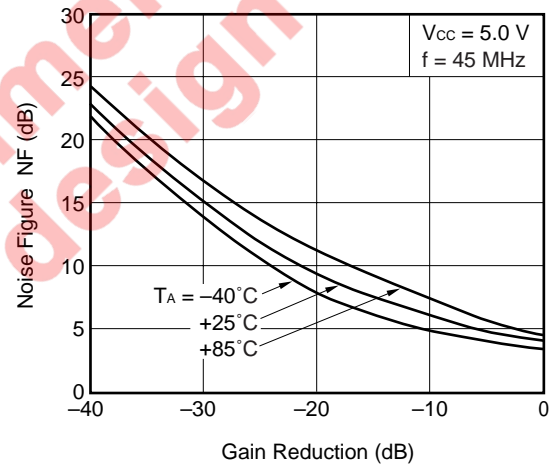

OUTPUT POWER, IM₃ vs. INPUT POWER

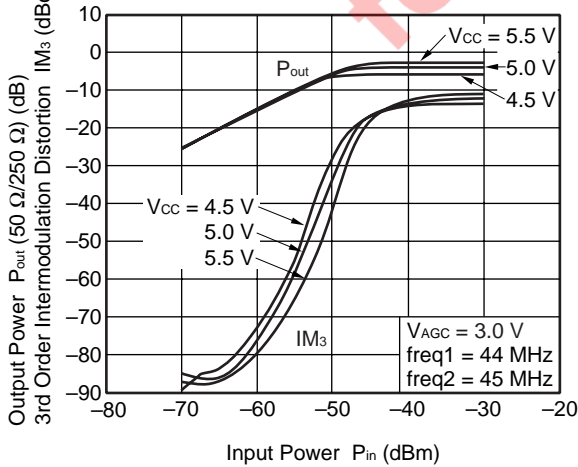

OUTPUT POWER, IM₃ vs. INPUT POWER

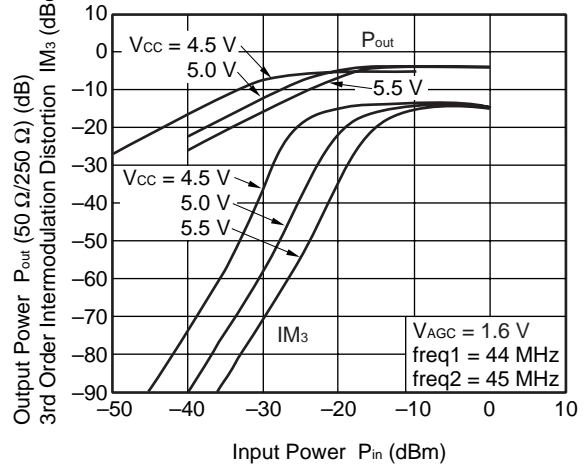

Remark The graphs indicate nominal characteristics.

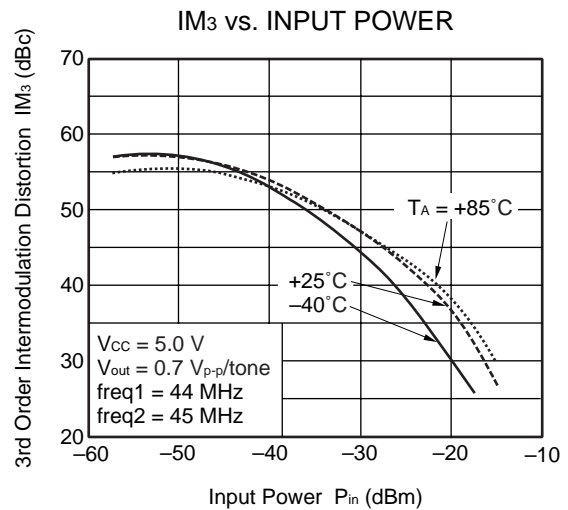
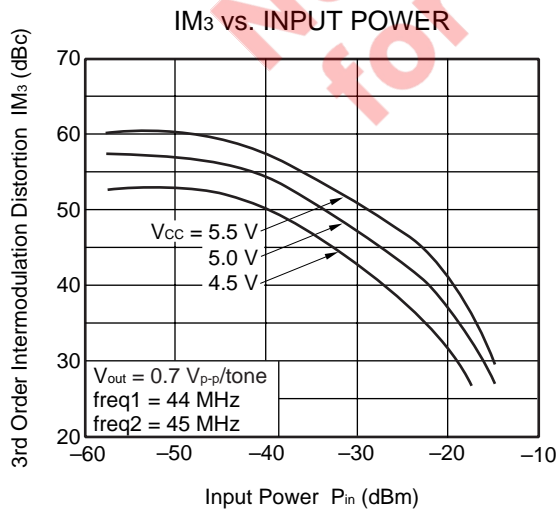
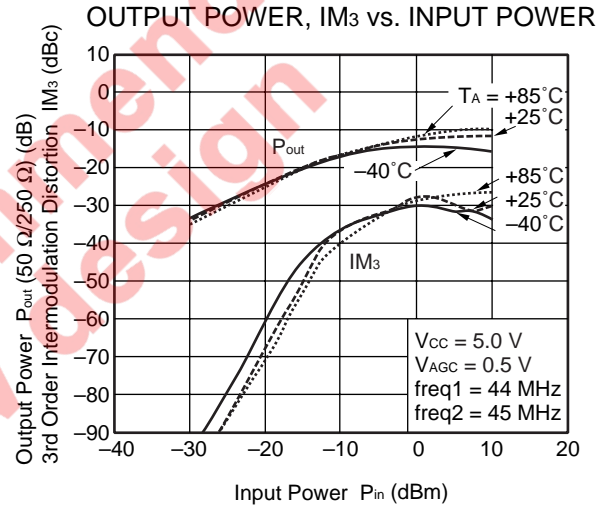
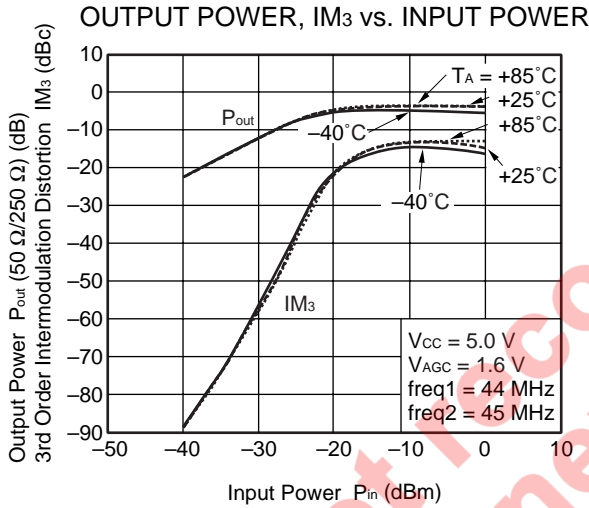
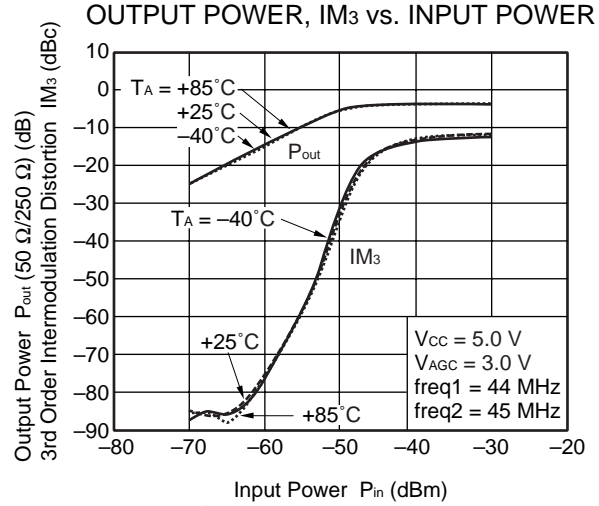
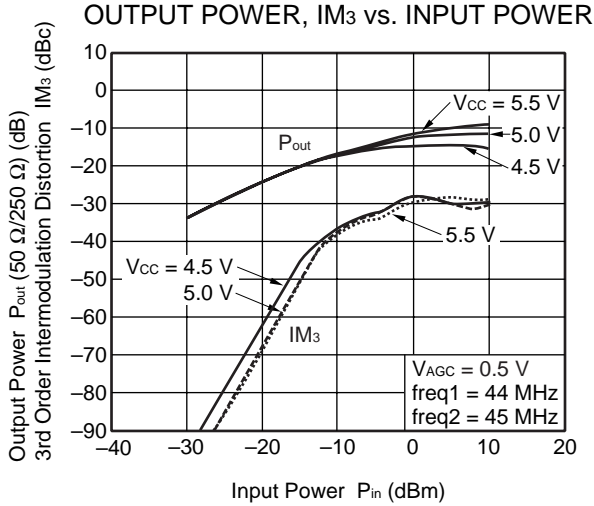

Remark The graphs indicate nominal characteristics.

★ S-PARAMETERS ($T_A = +25^\circ\text{C}$, $V_{CC} = V_{AGC} = 5.0\text{ V}$)

S₁₁-FREQUENCY

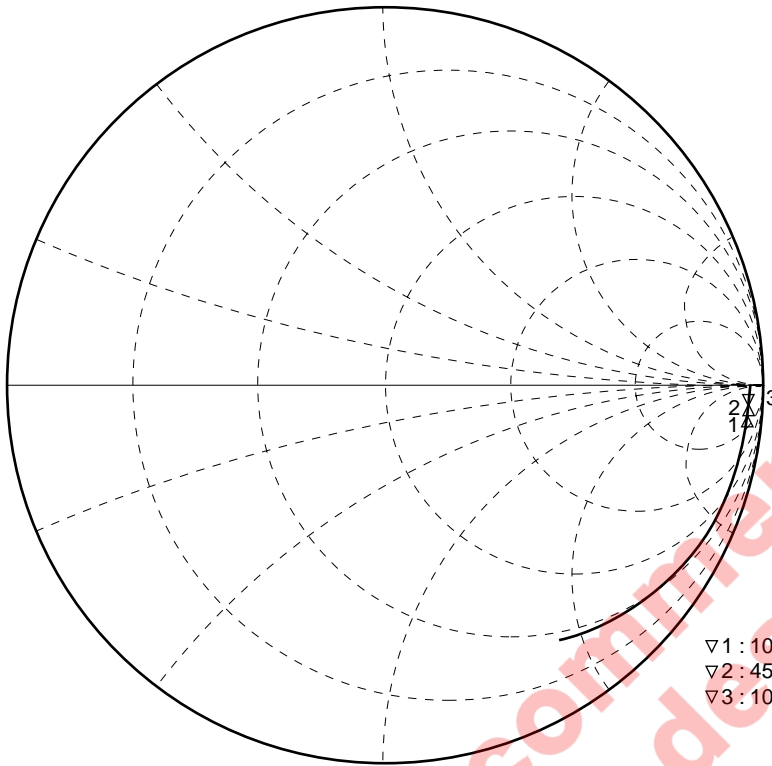

▽1 : 10 MHz	2.889 k Ω	-1.059 k Ω	15.33 pF
▽2 : 45 MHz	864.1 Ω	-1.402 k Ω	2.524 pF
▽3 : 100 MHz	235.0 Ω	-806.9 Ω	1.973 pF

S₂₂-FREQUENCY

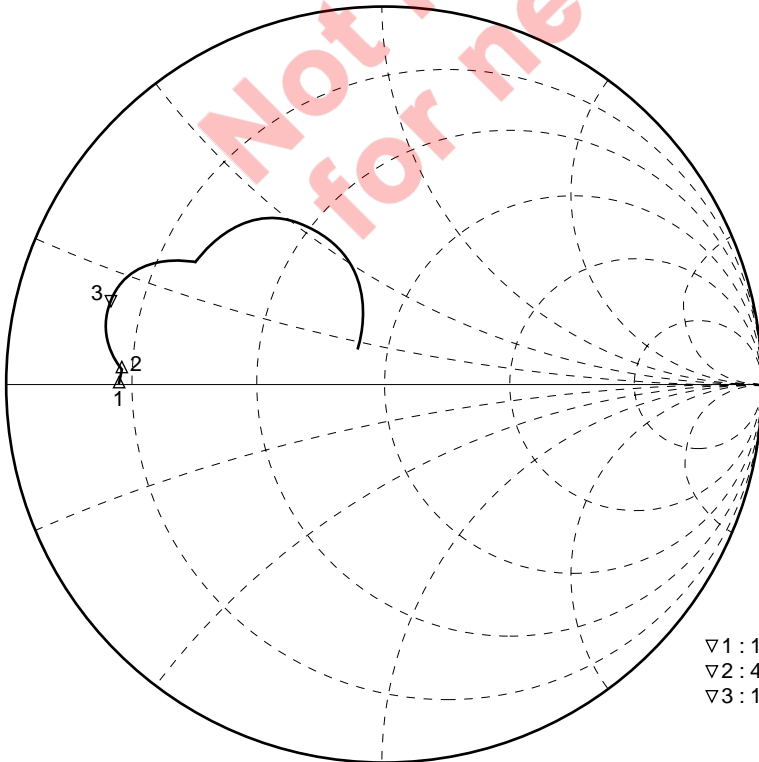

▽1 : 10 MHz	9.032 Ω	466.5 m Ω	7.335 nH
▽2 : 45 MHz	8.998 Ω	1.887 Ω	6.675 nH
▽3 : 100 MHz	7.266 Ω	6.750 Ω	10.74 nH

PACKAGE DIMENSIONS

8-PIN PLASTIC SSOP (4.45 mm (175)) (UNIT: mm)

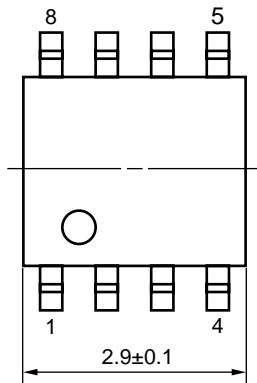

detail of lead end

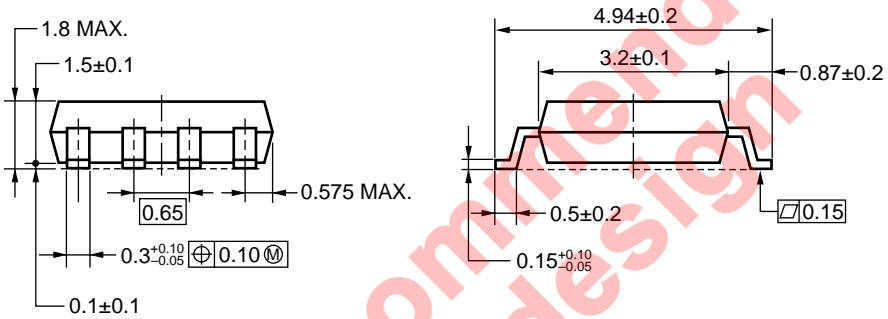
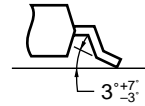

Not recommended for new designs

NOTES ON CORRECT USE

- (1) Observe precautions for handling because of electro-static sensitive devices.
- (2) Form a ground pattern as widely as possible to minimize ground impedance (to prevent undesired oscillation).
All the ground pins must be connected together with wide ground pattern to decrease impedance difference.
- (3) The bypass capacitor should be attached to Vcc line.

RECOMMENDED SOLDERING CONDITIONS

This product should be soldered and mounted under the following recommended conditions. For soldering methods and conditions other than those recommended below, contact your nearby sales office.

Soldering Method	Soldering Conditions	Condition Symbol
Infrared Reflow	Peak temperature (package surface temperature) : 260°C or below Time at peak temperature : 10 seconds or less Time at temperature of 220°C or higher : 60 seconds or less Preheating time at 120 to 180°C : 120±30 seconds Maximum number of reflow processes : 3 times Maximum chlorine content of rosin flux (% mass) : 0.2%(Wt.) or below	IR260
VPS ^{Note}	Peak temperature (package surface temperature) : 215°C or below Time at temperature of 200°C or higher : 25 to 40 seconds Preheating time at 120 to 150°C : 30 to 60 seconds Maximum number of reflow processes : 3 times Maximum chlorine content of rosin flux (% mass) : 0.2%(Wt.) or below	VP215
Wave Soldering	Peak temperature (molten solder temperature) : 260°C or below Time at peak temperature : 10 seconds or less Preheating temperature (package surface temperature) : 120°C or below Maximum number of flow processes : 1 time Maximum chlorine content of rosin flux (% mass) : 0.2%(Wt.) or below	WS260
Partial Heating	Peak temperature (pin temperature) : 350°C or below Soldering time (per side of device) : 3 seconds or less Maximum chlorine content of rosin flux (% mass) : 0.2%(Wt.) or below	HS350

Note Excluding lead-free products

Caution Do not use different soldering methods together (except for partial heating).

- **The information in this document is current as of July, 2004. The information is subject to change without notice. For actual design-in, refer to the latest publications of NEC's data sheets or data books, etc., for the most up-to-date specifications of NEC semiconductor products. Not all products and/or types are available in every country. Please check with an NEC sales representative for availability and additional information.**
- No part of this document may be copied or reproduced in any form or by any means without prior written consent of NEC. NEC assumes no responsibility for any errors that may appear in this document.
- NEC does not assume any liability for infringement of patents, copyrights or other intellectual property rights of third parties by or arising from the use of NEC semiconductor products listed in this document or any other liability arising from the use of such products. No license, express, implied or otherwise, is granted under any patents, copyrights or other intellectual property rights of NEC or others.
- Descriptions of circuits, software and other related information in this document are provided for illustrative purposes in semiconductor product operation and application examples. The incorporation of these circuits, software and information in the design of customer's equipment shall be done under the full responsibility of customer. NEC assumes no responsibility for any losses incurred by customers or third parties arising from the use of these circuits, software and information.
- While NEC endeavours to enhance the quality, reliability and safety of NEC semiconductor products, customers agree and acknowledge that the possibility of defects thereof cannot be eliminated entirely. To minimize risks of damage to property or injury (including death) to persons arising from defects in NEC semiconductor products, customers must incorporate sufficient safety measures in their design, such as redundancy, fire-containment, and anti-failure features.
- NEC semiconductor products are classified into the following three quality grades:
"Standard", "Special" and "Specific". The "Specific" quality grade applies only to semiconductor products developed based on a customer-designated "quality assurance program" for a specific application. The recommended applications of a semiconductor product depend on its quality grade, as indicated below. Customers must check the quality grade of each semiconductor product before using it in a particular application.
"Standard": Computers, office equipment, communications equipment, test and measurement equipment, audio and visual equipment, home electronic appliances, machine tools, personal electronic equipment and industrial robots
"Special": Transportation equipment (automobiles, trains, ships, etc.), traffic control systems, anti-disaster systems, anti-crime systems, safety equipment and medical equipment (not specifically designed for life support)
"Specific": Aircraft, aerospace equipment, submersible repeaters, nuclear reactor control systems, life support systems and medical equipment for life support, etc.
The quality grade of NEC semiconductor products is "Standard" unless otherwise expressly specified in NEC's data sheets or data books, etc. If customers wish to use NEC semiconductor products in applications not intended by NEC, they must contact an NEC sales representative in advance to determine NEC's willingness to support a given application.
(Note)
(1) "NEC" as used in this statement means NEC Corporation, NEC Compound Semiconductor Devices, Ltd. and also includes its majority-owned subsidiaries.
(2) "NEC semiconductor products" means any semiconductor product developed or manufactured by or for NEC (as defined above).

M8E 00.4-0110

Not recommend
for new design

► For further information, please contact

NEC Compound Semiconductor Devices, Ltd. <http://www.ncsd.necel.com/>

E-mail: salesinfo@ml.ncsd.necel.com (sales and general)

techinfo@ml.ncsd.necel.com (technical)

Sales Division TEL: +81-44-435-1588 FAX: +81-44-435-1579

NEC Compound Semiconductor Devices Hong Kong Limited

E-mail: ncsd-hk@elhk.nec.com.hk (sales, technical and general)

Hong Kong Head Office TEL: +852-3107-7303 FAX: +852-3107-7309

Taipei Branch Office TEL: +886-2-8712-0478 FAX: +886-2-2545-3859

Korea Branch Office TEL: +82-2-558-2120 FAX: +82-2-558-5209

NEC Electronics (Europe) GmbH <http://www.ee.nec.de/>

TEL: +49-211-6503-0 FAX: +49-211-6503-1327

California Eastern Laboratories, Inc. <http://www.cel.com/>

TEL: +1-408-988-3500 FAX: +1-408-988-0279