

To our customers,

Old Company Name in Catalogs and Other Documents

On April 1st, 2010, NEC Electronics Corporation merged with Renesas Technology Corporation, and Renesas Electronics Corporation took over all the business of both companies. Therefore, although the old company name remains in this document, it is a valid Renesas Electronics document. We appreciate your understanding.

Renesas Electronics website: <http://www.renesas.com>

April 1st, 2010
Renesas Electronics Corporation

Issued by: Renesas Electronics Corporation (<http://www.renesas.com>)

Send any inquiries to <http://www.renesas.com/inquiry>.

Not recommended
for new design

Notice

1. All information included in this document is current as of the date this document is issued. Such information, however, is subject to change without any prior notice. Before purchasing or using any Renesas Electronics products listed herein, please confirm the latest product information with a Renesas Electronics sales office. Also, please pay regular and careful attention to additional and different information to be disclosed by Renesas Electronics such as that disclosed through our website.
2. Renesas Electronics does not assume any liability for infringement of patents, copyrights, or other intellectual property rights of third parties by or arising from the use of Renesas Electronics products or technical information described in this document. No license, express, implied or otherwise, is granted hereby under any patents, copyrights or other intellectual property rights of Renesas Electronics or others.
3. You should not alter, modify, copy, or otherwise misappropriate any Renesas Electronics product, whether in whole or in part.
4. Descriptions of circuits, software and other related information in this document are provided only to illustrate the operation of semiconductor products and application examples. You are fully responsible for the incorporation of these circuits, software, and information in the design of your equipment. Renesas Electronics assumes no responsibility for any losses incurred by you or third parties arising from the use of these circuits, software, or information.
5. When exporting the products or technology described in this document, you should comply with the applicable export control laws and regulations and follow the procedures required by such laws and regulations. You should not use Renesas Electronics products or the technology described in this document for any purpose relating to military applications or use by the military, including but not limited to the development of weapons of mass destruction. Renesas Electronics products and technology may not be used for or incorporated into any products or systems whose manufacture, use, or sale is prohibited under any applicable domestic or foreign laws or regulations.
6. Renesas Electronics has used reasonable care in preparing the information included in this document, but Renesas Electronics does not warrant that such information is error free. Renesas Electronics assumes no liability whatsoever for any damages incurred by you resulting from errors in or omissions from the information included herein.
7. Renesas Electronics products are classified according to the following three quality grades: “Standard”, “High Quality”, and “Specific”. The recommended applications for each Renesas Electronics product depends on the product’s quality grade, as indicated below. You must check the quality grade of each Renesas Electronics product before using it in a particular application. You may not use any Renesas Electronics product for any application categorized as “Specific” without the prior written consent of Renesas Electronics. Further, you may not use any Renesas Electronics product for any application for which it is not intended without the prior written consent of Renesas Electronics. Renesas Electronics shall not be in any way liable for any damages or losses incurred by you or third parties arising from the use of any Renesas Electronics product for an application categorized as “Specific” or for which the product is not intended where you have failed to obtain the prior written consent of Renesas Electronics. The quality grade of each Renesas Electronics product is “Standard” unless otherwise expressly specified in a Renesas Electronics data sheets or data books, etc.
 - “Standard”: Computers; office equipment; communications equipment; test and measurement equipment; audio and visual equipment; home electronic appliances; machine tools; personal electronic equipment; and industrial robots.
 - “High Quality”: Transportation equipment (automobiles, trains, ships, etc.); traffic control systems; anti-disaster systems; anti-crime systems; safety equipment; and medical equipment not specifically designed for life support.
 - “Specific”: Aircraft; aerospace equipment; submersible repeaters; nuclear reactor control systems; medical equipment or systems for life support (e.g. artificial life support devices or systems), surgical implantations, or healthcare intervention (e.g. excision, etc.), and any other applications or purposes that pose a direct threat to human life.
8. You should use the Renesas Electronics products described in this document within the range specified by Renesas Electronics, especially with respect to the maximum rating, operating supply voltage range, movement power voltage range, heat radiation characteristics, installation and other product characteristics. Renesas Electronics shall have no liability for malfunctions or damages arising out of the use of Renesas Electronics products beyond such specified ranges.
9. Although Renesas Electronics endeavors to improve the quality and reliability of its products, semiconductor products have specific characteristics such as the occurrence of failure at a certain rate and malfunctions under certain use conditions. Further, Renesas Electronics products are not subject to radiation resistance design. Please be sure to implement safety measures to guard them against the possibility of physical injury, and injury or damage caused by fire in the event of the failure of a Renesas Electronics product, such as safety design for hardware and software including but not limited to redundancy, fire control and malfunction prevention, appropriate treatment for aging degradation or any other appropriate measures. Because the evaluation of microcomputer software alone is very difficult, please evaluate the safety of the final products or system manufactured by you.
10. Please contact a Renesas Electronics sales office for details as to environmental matters such as the environmental compatibility of each Renesas Electronics product. Please use Renesas Electronics products in compliance with all applicable laws and regulations that regulate the inclusion or use of controlled substances, including without limitation, the EU RoHS Directive. Renesas Electronics assumes no liability for damages or losses occurring as a result of your noncompliance with applicable laws and regulations.
11. This document may not be reproduced or duplicated, in any form, in whole or in part, without prior written consent of Renesas Electronics.
12. Please contact a Renesas Electronics sales office if you have any questions regarding the information contained in this document or Renesas Electronics products, or if you have any other inquiries.

(Note 1) “Renesas Electronics” as used in this document means Renesas Electronics Corporation and also includes its majority-owned subsidiaries.

(Note 2) “Renesas Electronics product(s)” means any product developed or manufactured by or for Renesas Electronics.

BIPOLAR ANALOG INTEGRATED CIRCUIT
 μ PC3220GR

LOW DISTORTION DOWN-CONVERTER IC FOR DIGITAL CATV

DESCRIPTION

The μ PC3220GR is a silicon monolithic IC designed for use as IF down-converter for digital CATV. This IC consists of AGC amplifier, mixer and video amplifier.

The package is 16-pin SSOP (Shrink Small Outline Package) suitable for surface mount.

This IC is manufactured using our 10 GHz fr NESAT II AL silicon bipolar process.

This process uses silicon nitride passivation film. This material can protect chip surface from external pollution and prevent corrosion/migration. Thus, this IC has excellent performance, uniformly and reliability.

FEATURES

- Low distortion IIP₃ = +1.0 dBm TYP.
- Wide AGC dynamic range GCR_{total} = 45.5 dB TYP.
- On chip video amplifier
- Supply voltage : 5 V
- Packaged in 16-pin SSOP suitable for high-density surface mounting

APPLICATION

- Digital CATV receivers

★ **ORDERING INFORMATION**

Part Number	Order Number	Package	Marking	Supplying Form
μ PC3220GR-E1	μ PC3220GR-E1-A	16-pin plastic SSOP (5.72 mm (225)) (Pb-Free) ^{Note}	C3220	<ul style="list-style-type: none"> • Embossed tape 12 mm wide • Pin 1 indicates pull-out direction of tape • Qty 2.5 kpcs/reel

Note With regards to terminal solder (the solder contains lead) plated products (conventionally plated), contact your nearby sales office.

Remark To order evaluation samples, contact your nearby sales office.
 Part number for sample order: μ PC3220GR

Caution Observe precautions when handling because these devices are sensitive to electrostatic discharge.

The information in this document is subject to change without notice. Before using this document, please confirm that this is the latest version.
 Not all devices/types available in every country. Please check with local NEC Compound Semiconductor Devices representative for availability and additional information.

INTERNAL BLOCK DIAGRAM AND PIN CONFIGURATION

(Top View)

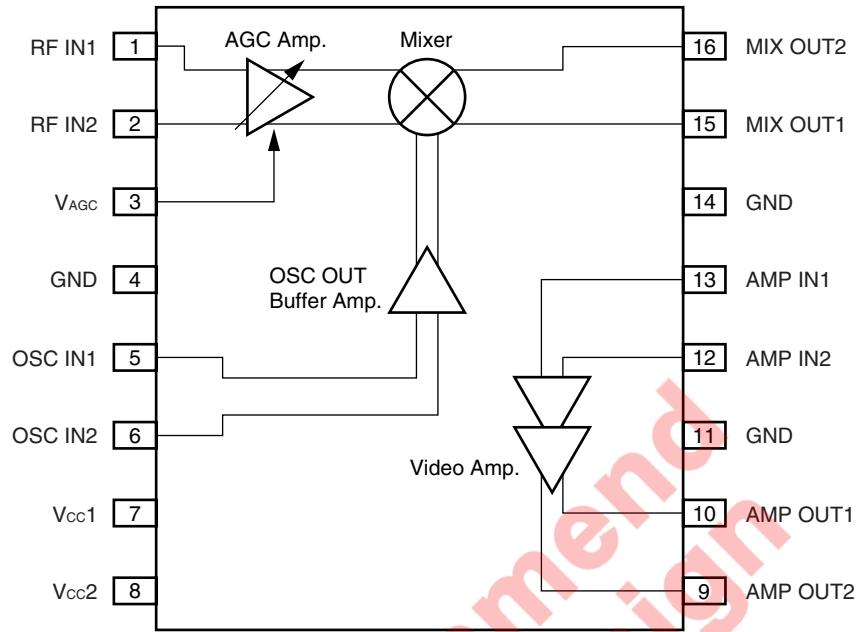

PIN EXPLANATIONS

PIN No.	Symbol	Pin Voltage (V, TYP.)	Explanation	Equivalent Circuit
1	RF IN1	1.46	Input pin of IF signal. 1-pin is same phase and 2-pin is opposite phase at balance input. In case of single input, 1-pin or 2-pin should be grounded through capacitor (example 10 nF).	
2	RF IN2	1.46		
3	V _{AGC}	0 to 3.5	Automatic gain control pin. This pins bias govern the AGC output level. Minimum gain at V _{AGC} = 0 V Maximum gain at V _{AGC} = 3.5 V	
4	GND	0.0	Ground pin. Must be connected to the system ground with minimum inductance. Ground pattern on the board should be formed as wide as possible.	
5	OSC IN1	2.6	Input pin of Oscillator signal. 5-pin is same phase and 6-pin is opposite phase at balance input. In case of single input, 5-pin or 6-pin should be grounded through capacitor (ex. 10 nF).	
6	OSC IN2	2.6		
7	V _{CC1}	5.0	Power supply pin of IF down convertor block. Must be connected bypass capacitor to minimize ground impedance.	
8	V _{CC2}	5.0	Power supply pin of video amplifier. Must be connected bypass capacitor to minimize ground impedance.	

PIN No.	Symbol	Pin Voltage (V, TYP.)	Explanation	Equivalent Circuit
9	AMP OUT2	2.5	Output pin of video amplifier. OUT1 and IN1 are same phase. OUT2 and IN2 are same phase.	
10	AMP OUT1	2.5		
11	GND	0.0	Ground pin. Must be connected to the system ground with minimum inductance. Ground pattern on the board should be formed as wide as possible.	—
12	AMP IN2	1.45	Signal input pin of video amplifier. This pin is high impedance.	
13	AMP IN1	1.45		
14	GND	0.0	Ground pin. Must be connected to the system ground with minimum inductance. Ground pattern on the board should be formed as wide as possible.	—
15	MIX OUT1	3.7	Output pin of mixer. This output pin features low-impedance because of its emitter-follower output port.	
16	MIX OUT2	3.7		

ABSOLUTE MAXIMUM RATINGS

Parameter	Symbol	Conditions	Ratings	Unit
Supply Voltage	V _{CC}	T _A = +25°C	6.0	V
Power Dissipation	P _D	T _A = +85°C Note	433	mW
Operating Ambient Temperature	T _A		-40 to +85	°C
Storage Temperature	T _{stg}		-55 to +150	°C

Note Mounted on double-sided copper-clad 50 × 50 × 1.6 mm epoxy glass PWB

RECOMMENDED OPERATING RANGE

Parameter	Symbol	Conditions	MIN.	TYP.	MAX.	Unit
Supply Voltage	V _{CC}		4.5	5.0	5.5	V
Operating Ambient Temperature	T _A	V _{CC} = 4.5 to 5.5 V	-40	+25	+85	°C
Gain Control Voltage Range	V _{AGC}		0	-	V _{CC}	V

Not recommended for new design

ELECTRICAL CHARACTERISTICS (T_A = +25°C, V_{CC} = 5 V)

Parameter	Symbol	Test Conditions	MIN.	TYP.	MAX.	Unit
DC Characteristics						
Circuit Current 1 (Total Block)	I _{CC1}	No input signal, V _{CC1} = V _{CC2} = 5 V Note 4	33.0	42.0	53.5	mA
Circuit Current 2 (AGC Amplifier Block + Mixer Block)	I _{CC2}	No input signal, V _{CC1} = 5 V Note 4	15.0	20.0	25.5	mA
Circuit Current 3 (Video Amplifier Block)	I _{CC3}	No input signal, V _{CC2} = 5 V Note 4	18.0	22.0	28.0	mA
AGC Voltage High Level	V _{AGC(H)}	@ Maximum gain Note 1	3.0	–	V _{CC}	V
AGC Voltage Low Level	V _{AGC(L)}	@ Minimum gain Note 1	0	–	0.5	V
RF Characteristics (AGC Amplifier Block + Mixer Block: f _{RF} = 84 MHz, f _{LO} = 134 MHz, P _{LO} = –15 dBm, f _{IF} = 50 MHz, Z _S = 50 Ω, Z _L = 1 kΩ)						
RF Input Frequency Range	f _{RF}	f _{IF} = 50 MHz constant Note 1	30	–	250	MHz
IF Output Frequency Range	f _{IF}	f _{RF} = 84 MHz constant Note 1	0.1	–	150	MHz
Maximum Conversion Gain	CG _{MAX}	V _{AGC} = 3.0 V, P _{in} = –50 dBm Note 1	30.5	33.0	35.5	dB
Minimum Conversion Gain	CG _{MIN}	V _{AGC} = 0.5 V, P _{in} = –20 dBm Note 1	–18.0	–12.5	–3.5	dB
AGC Dynamic Range	GCR _{AGC}	V _{AGC} = 0.5 to 3.0 V Note 1	36.0	45.5	–	dB
Noise Figure	NF	DSB, V _{AGC} = 3.0 V (@ Maximum gain) Note 2	–	7.0	8.5	dB
3rd Order Intermodulation Distortion	IM ₃	V _{out} = 0.236 V _{p-p} × 2 tone, (single-ended output), P _{in} = –30 dBm/tone f _{RF1} = 84 MHz, f _{RF2} = 85 MHz Note 1	24.0	26.5	–	dBc
RF Characteristics (Video Amplifier Block: f = 50 MHz, Z_S = 50 Ω, Z_L = 1 kΩ)						
Differential Gain	G _{diff}	P _{in} = –55 dBm Note 3	48.0	50.5	53.5	dB
Maximum Output Voltage 2	V _{oclip2}	P _{in} = –25 dBm Note 3	2.95	3.70	–	V _{p-p}

- Notes 1.** By measurement circuit 1
- 2.** By measurement circuit 2
- 3.** By measurement circuit 4
- 4.** By measurement circuit 6

STANDARD CHARACTERISTICS (T_A = +25°C, V_{CC} = 5 V, Z_S = 50 Ω)

Parameter	Symbol	Test Conditions	Reference Value	Unit
AGC Amplifier Block + Mixer Block (f _{RF} = 84 MHz, f _{LO} = 134 MHz, P _{LO} = -15 dBm, f _{IF} = 50 MHz, Z _S = 50 Ω, Z _L = 1 kΩ)				
Input 3rd Order Distortion Intercept Point	IIP ₃	V _{AGC} = 0.5 V (@ Minimum gain) f _{RF1} = 84 MHz, f _{RF2} = 85 MHz Note 1	+1.0	dBm
Maximum Output Voltage1	V _{oclip1}	V _{AGC} = 3.0 V, P _{in} = -20 dBm Note 1	0.65	V _{p-p}
RF IN Impedance	Z _{RFin}	V _{AGC} = 3.0 V, f = 84 MHz Note 2	440 - j1100	Ω
OSC IN Impedance	Z _{OScin}	V _{AGC} = 3.0 V, f = 134 MHz Note 2	280 - j810	Ω
MIXER OUT Impedance	Z _{MIXout}	V _{AGC} = 3.0 V, f = 50 MHz Note 2	30.2 + j2.5	Ω
Video Amplifier Block (f = 50 MHz, Z _S = 50 Ω, Z _L = 1 kΩ)				
Frequency Range	f _{BW}	P _{in} = -55 dBm, G (f = 10 MHz) -1 dB Note 3	60	MHz
Input Impedance	Z _{AMPin}	f = 50 MHz Note 4	330 - j480	Ω
Output Impedance	Z _{AMPout}	f = 50 MHz Note 4	21.9 + j22.6	Ω
3rd Order Intermodulation Distortion	IM ₃	V _{out} = 0.7 V _{p-p} × 2 tone, f _{in1} = 49 MHz, f _{in2} = 50 MHz Note 3	55.0	dBc
Total Block (f _{RF} = 84 MHz, f _{LO} = 134 MHz, P _{LO} = -15 dBm, f _{IF} = 50 MHz, Z _S = 50 Ω, Z _L = 1 kΩ)				
Maximum Conversion Gain	CG _{MAX}	V _{AGC} = 3.0 V, P _{in} = -70 dBm Note 5	67.5	dB
Minimum Conversion Gain	CG _{MIN}	V _{AGC} = 0.5 V, P _{in} = -40 dBm Note 5	22.0	dB
Total Dynamic Range	GCR	V _{AGC} = 0.5 to 3.0 V Note 5	45.5	dB
Noise Figure	NF	DSB, V _{AGC} = 3.0 V (@ Maximum gain) Note 6	7.0	dB
Maximum Output Voltage	V _{oclip}	V _{AGC} = 3.0 V (@ Minimum gain) Note 5	3.7	V _{p-p}
Input 3rd Order Distortion Intercept Point	IIP _{3total}	V _{AGC} = 0.5 V (@ Minimum gain) f _{RF1} = 84 MHz, f _{RF2} = 85 MHz Note 5	+1.0	dBm
3rd Order Intermodulation Distortion	IM _{3total}	V _{out} = 0.7 V _{p-p} × 2 tone, P _{in} -40 dBm/tone f _{RF1} = 84 MHz, f _{RF2} = 85 MHz Note 5	51.0	dBc

- Notes**
1. By measurement circuit 1
 2. By measurement circuit 3
 3. By measurement circuit 4
 4. By measurement circuit 5
 5. By measurement circuit 6
 6. By measurement circuit 7

MEASUREMENT CIRCUIT 1

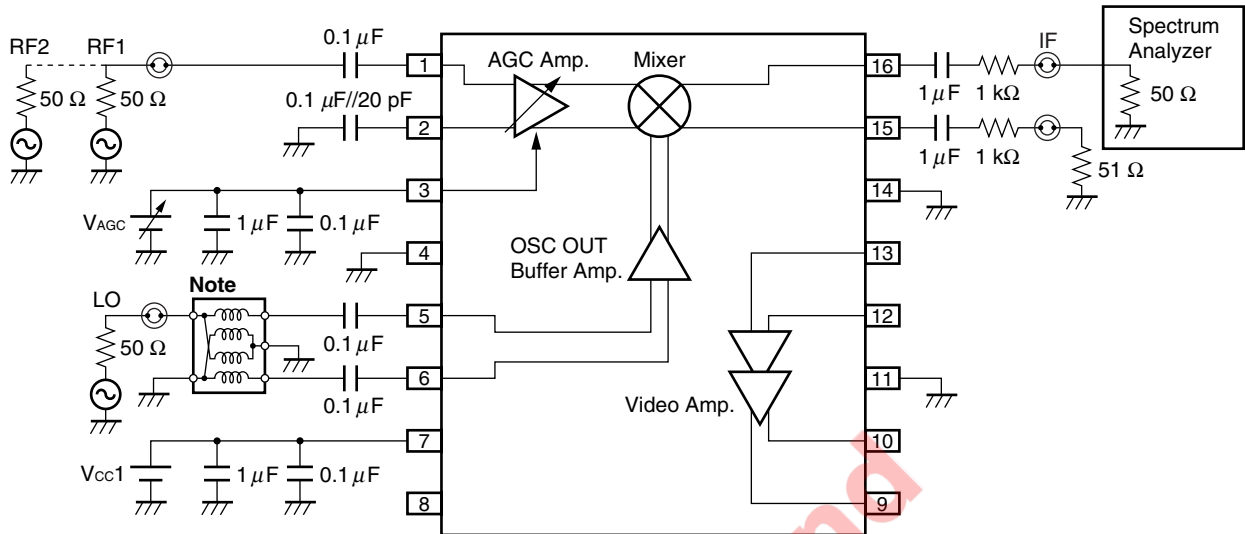

Note Balun Transformer : TOKO 617DB-1010 B4F (Double balanced type)

MEASUREMENT CIRCUIT 2

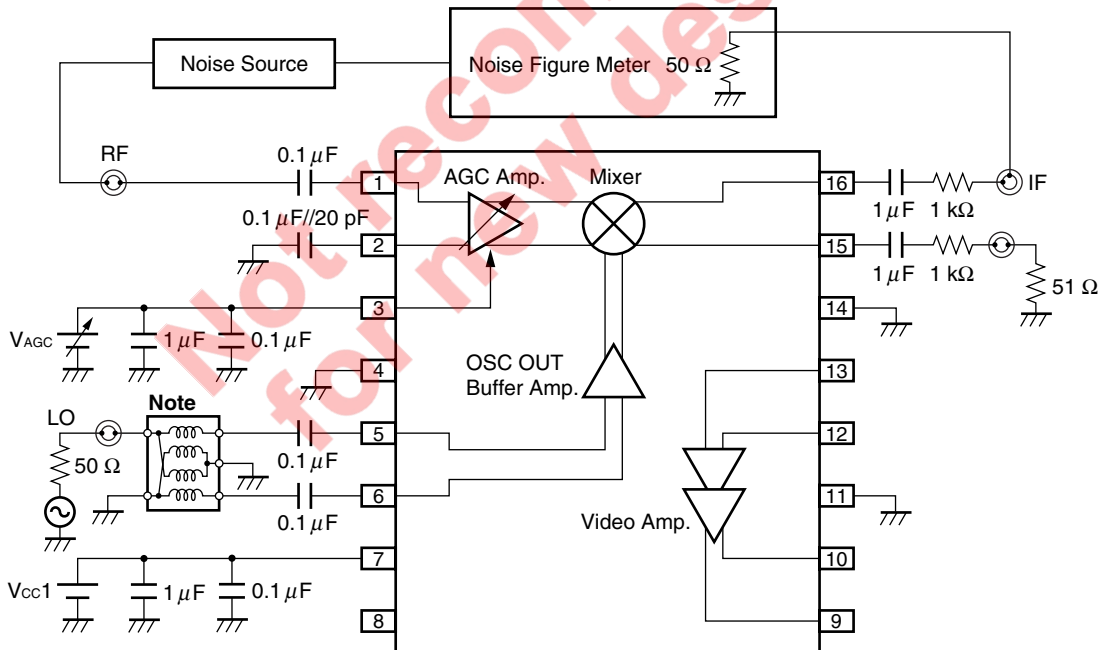

Note Balun Transformer : TOKO 617DB-1010 B4F (Double balanced type)

MEASUREMENT CIRCUIT 3

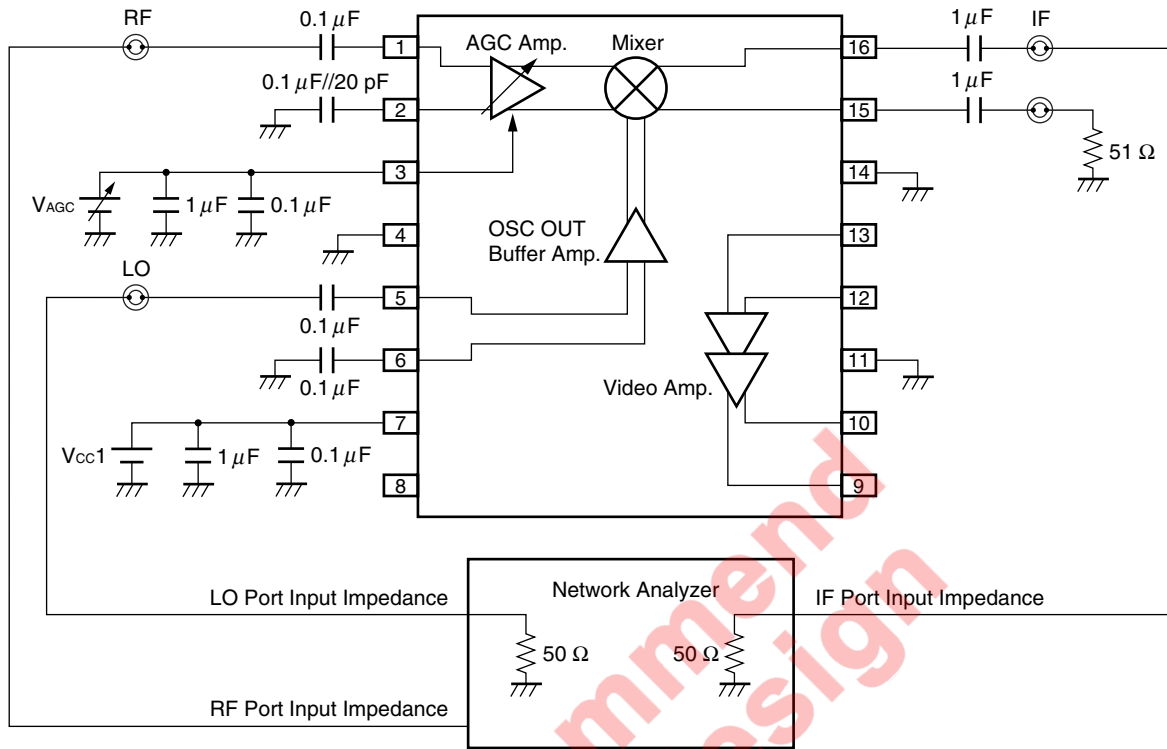

MEASUREMENT CIRCUIT 4

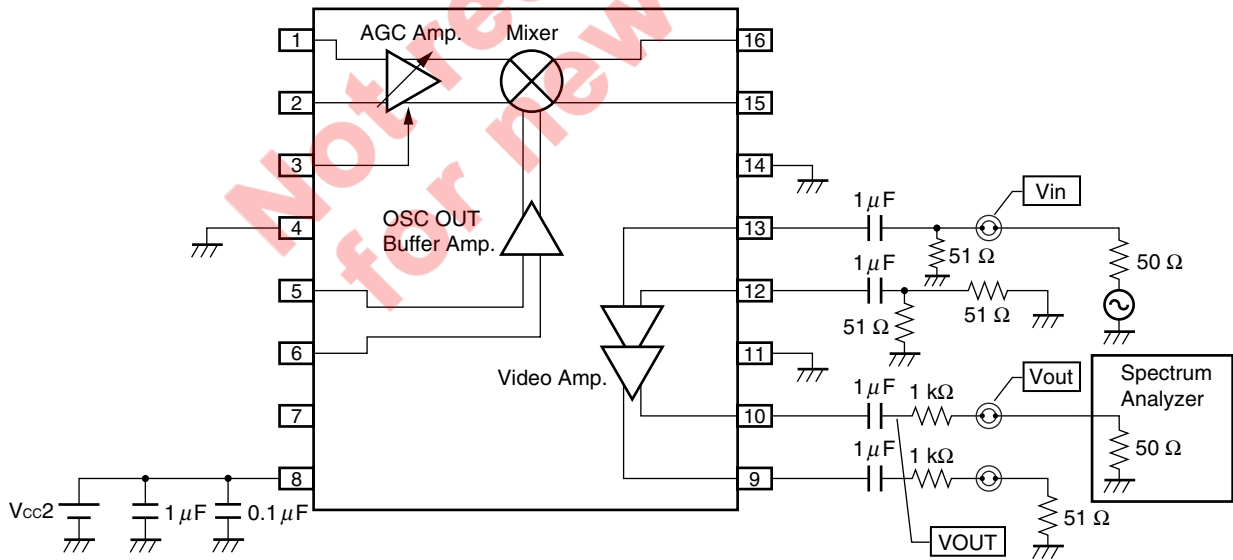

- Remarks 1.** Voltage Gain (Single Ended) = $20 \log (V_{OUT}/V_{in})$ (dB)
2. Differential Gain (Differential-out) = $20 \log (2 \times V_{OUT}/V_{in})$ (dB)
3. $V_{OUT} = V_{out}$ (Measured Value) $\times (1\ 050/50)$

MEASUREMENT CIRCUIT 5

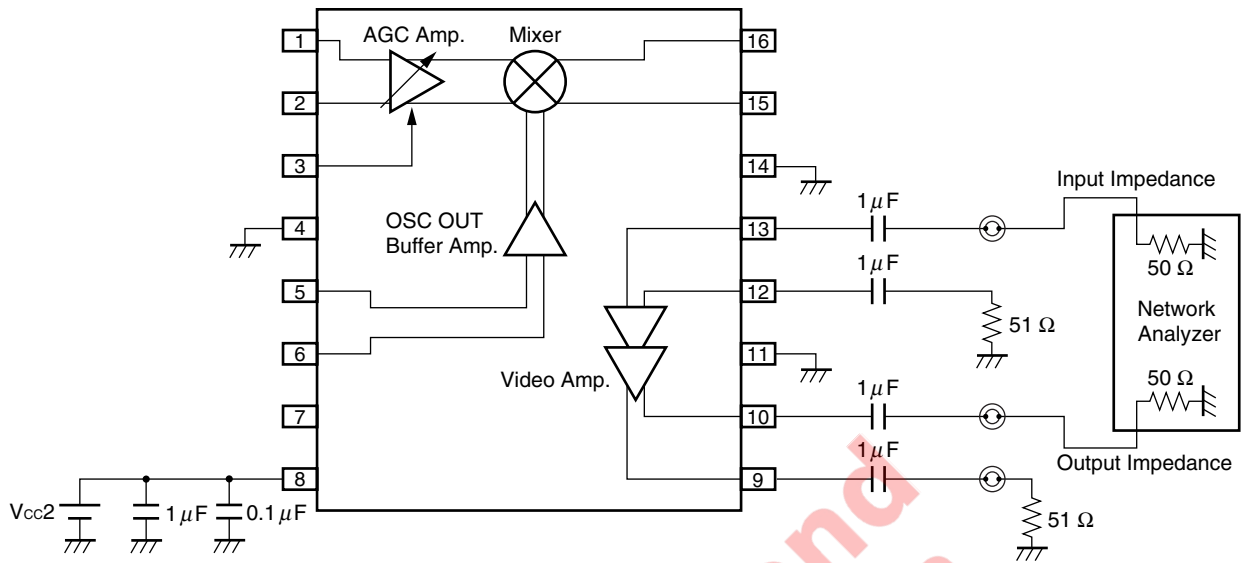

MEASUREMENT CIRCUIT 6

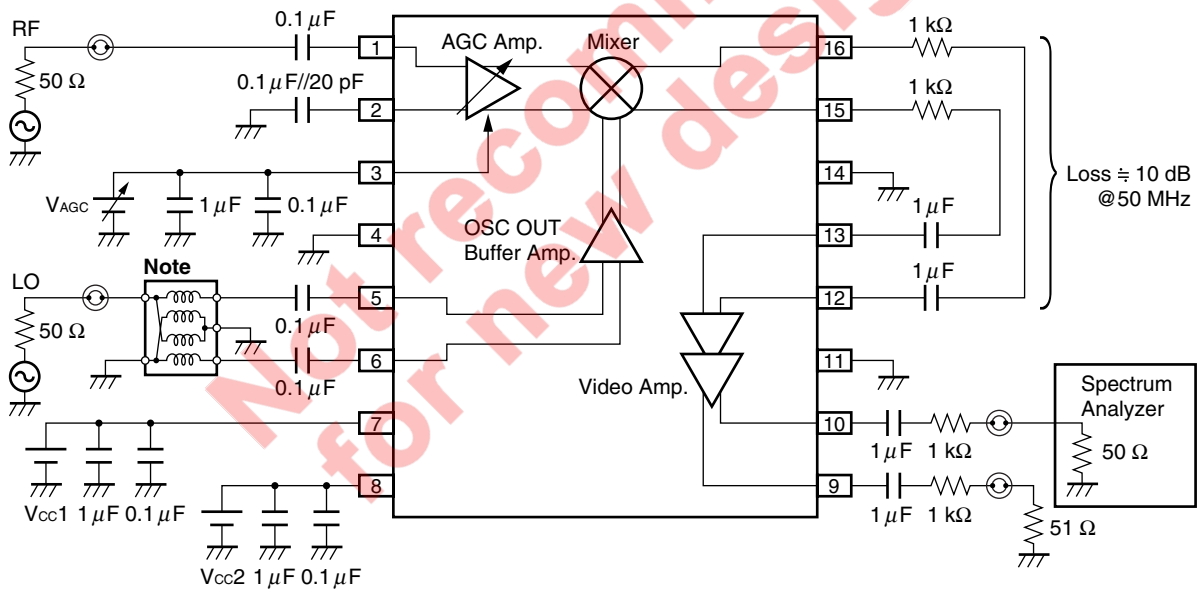

Note Balun Transformer : TOKO 617DB-1010 B4F (Double balanced type)

MEASUREMENT CIRCUIT 7

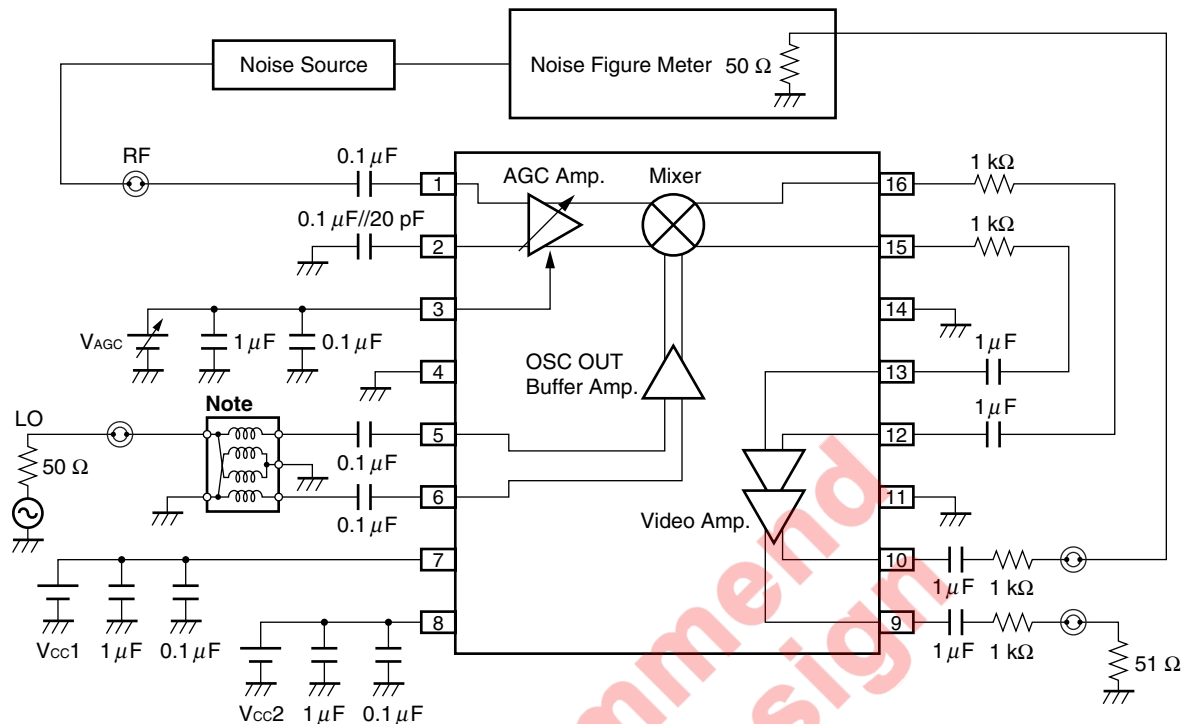

Note Balun Transformer : TOKO 617DB-1010 B4F (Double balanced type)

The application circuits and their parameters are for reference only and are not intended for use in actual design-ins.

Not recommended for new designs

★ ILLUSTRATION OF THE MEASUREMENT CIRCUIT1,2 ASSEMBLED ON EVALUATION BOARD

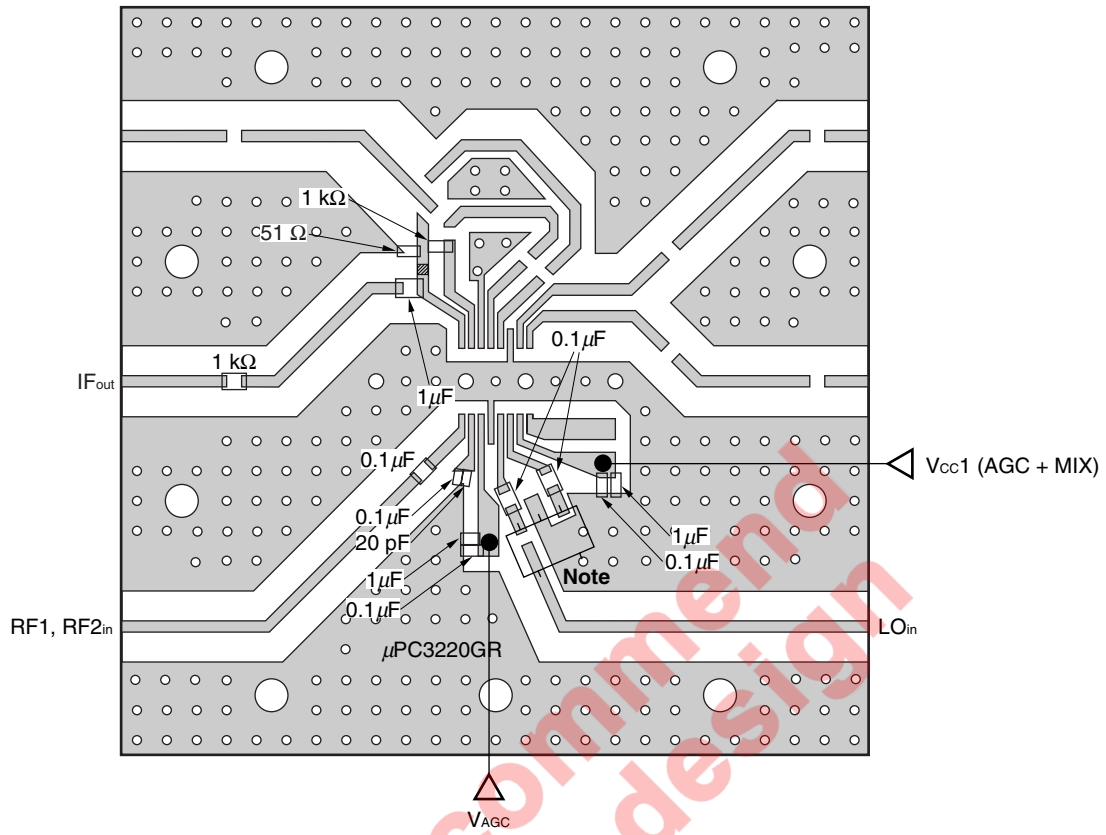

Note Balun Transformer

Remarks

1. Back side: GND pattern
2. Solder plated on pattern
3. ○: Through hole
4. ▨: Represents cutout

★ ILLUSTRATION OF THE MEASUREMENT CIRCUIT3 ASSEMBLED ON EVALUATION BOARD

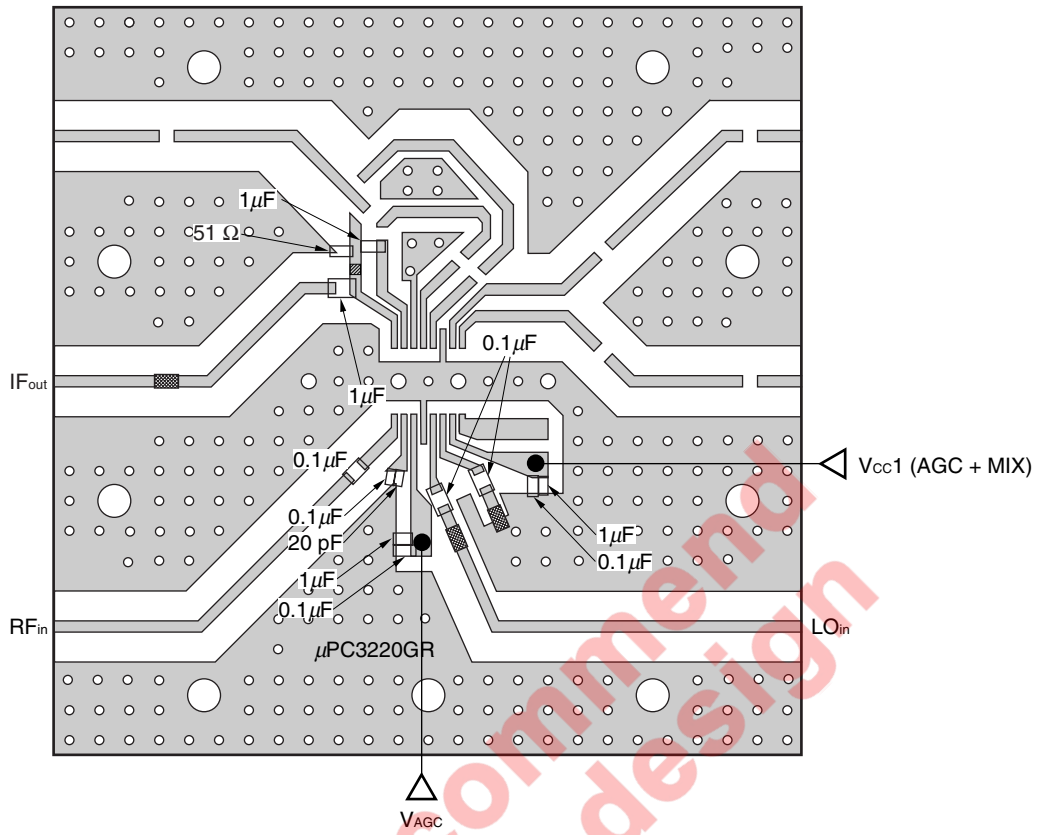

Remarks

1. Back side: GND pattern
2. Solder plated on pattern
3. ○○: Through hole
4. ▨: Represents cutout
5. ▩: Represents short-circuit strip

★ ILLUSTRATION OF THE MEASUREMENT CIRCUIT4 ASSEMBLED ON EVALUATION BOARD

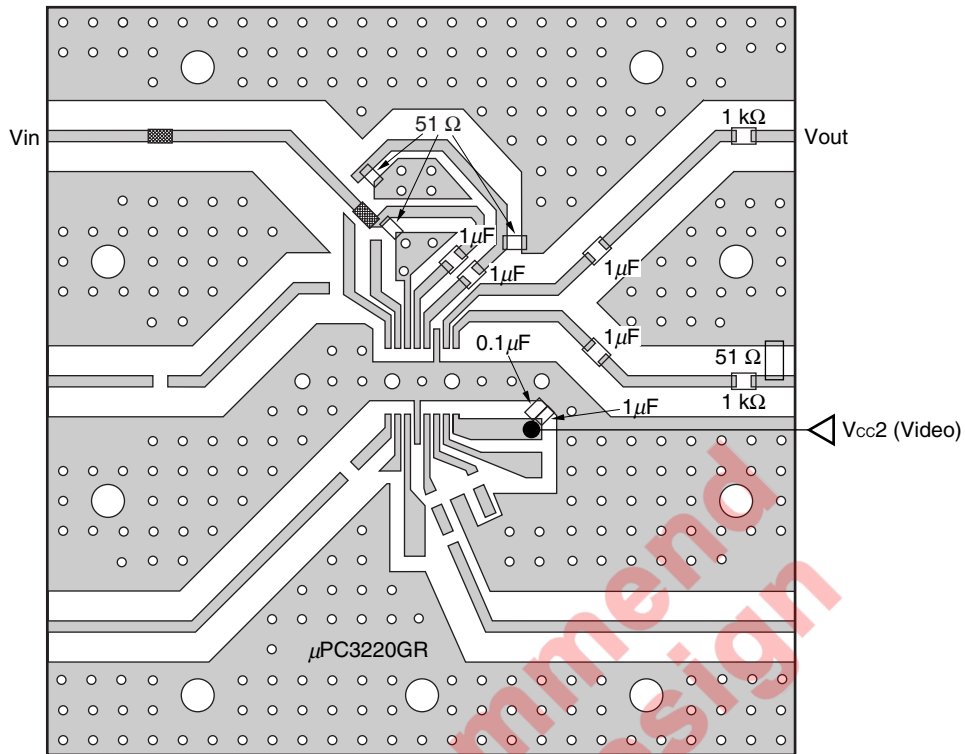

Remarks

1. Back side: GND pattern
2. Solder plated on pattern
3. ○: Through hole
4. ■: Represents short-circuit strip

★ ILLUSTRATION OF THE MEASUREMENT CIRCUIT5 ASSEMBLED ON EVALUATION BOARD

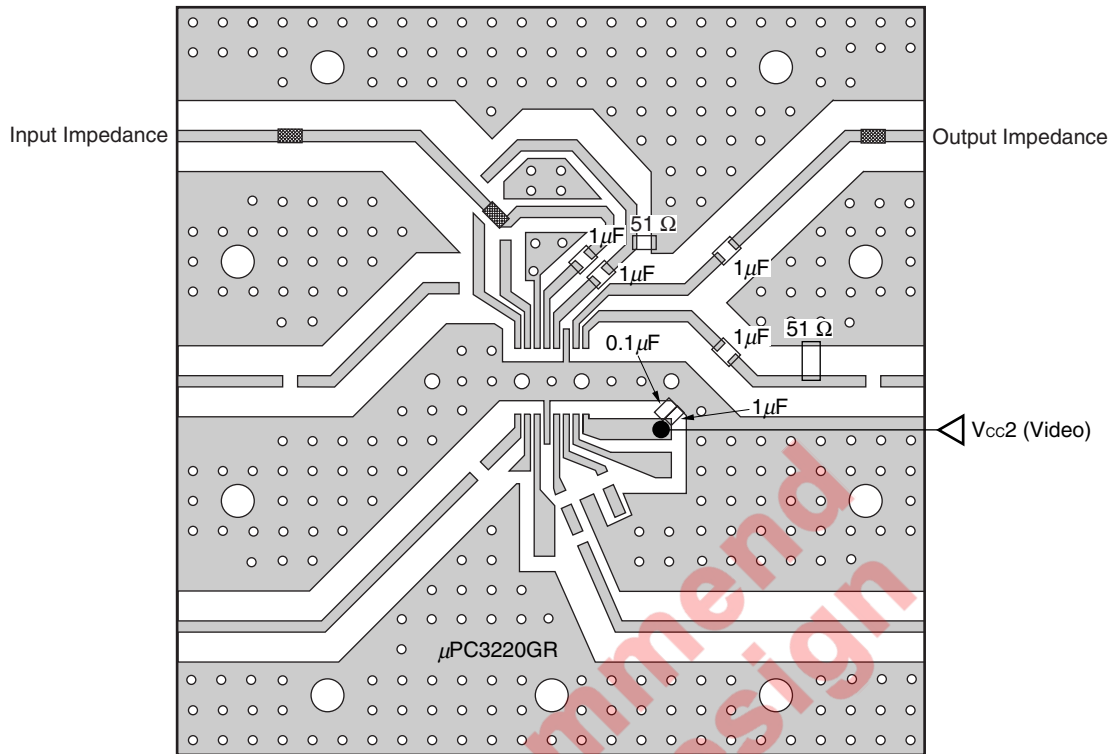

Remarks

1. Back side: GND pattern
2. Solder plated on pattern
3. ○: Through hole
4. ■: Represents short-circuit strip

Not recommended for new design

★ ILLUSTRATION OF THE MEASUREMENT CIRCUIT6,7 ASSEMBLED ON EVALUATION BOARD

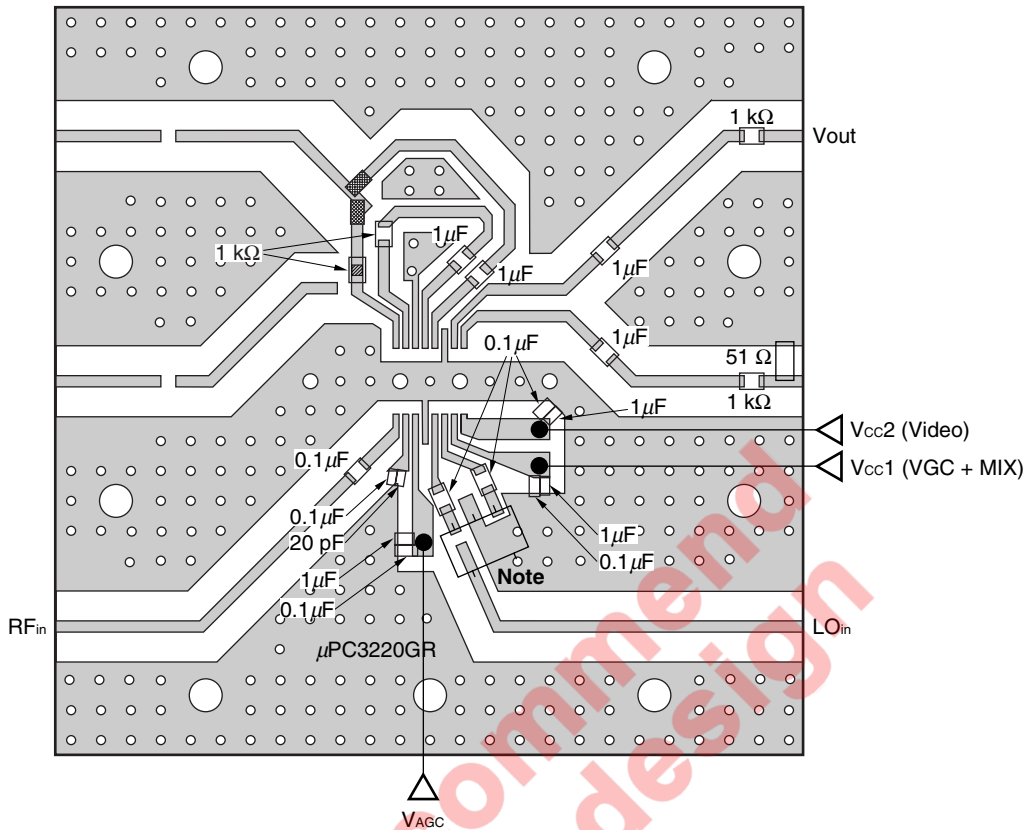

Note Balun Transformer

Remarks

1. Back side: GND pattern
2. Solder plated on pattern
3. ○: Through hole
4. ▨: Represents cutout
5. ▩: Represents short-circuit strip

TYPICAL CHARACTERISTICS ($T_A = +25^\circ\text{C}$, unless otherwise specified)

CIRCUIT CURRENT1 (TOTAL BLOCK) vs. SUPPLY VOLTAGE

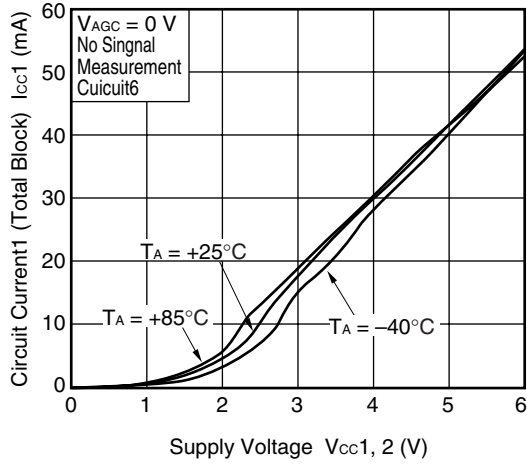

CIRCUIT CURRENT2 (AGC AMPLIFIER + MIXER BLOCK) vs. SUPPLY VOLTAGE

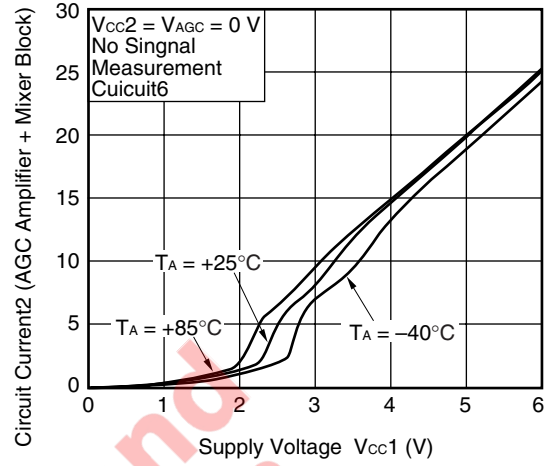

CIRCUIT CURRENT3 (VIDEO AMPLIFIER BLOCK) vs. SUPPLY VOLTAGE

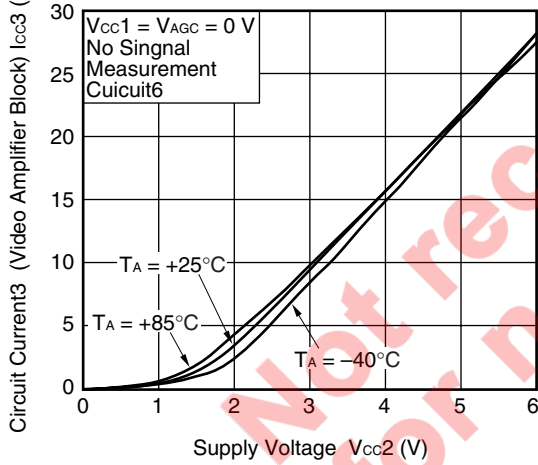

Remark The graphs indicate nominal characteristics.

–AGC Amplifier Block + Mixer Block–

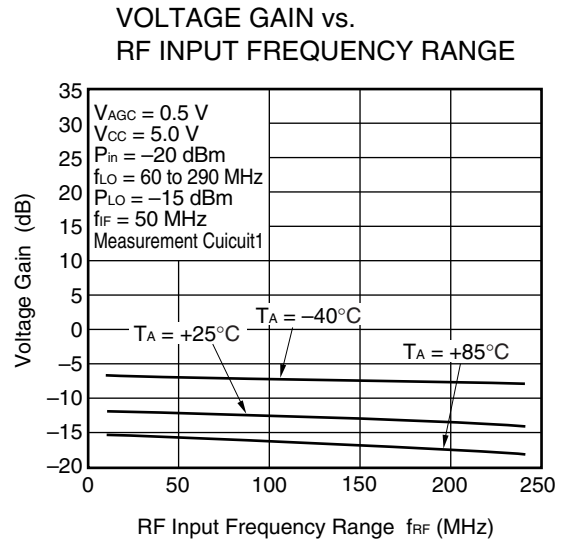
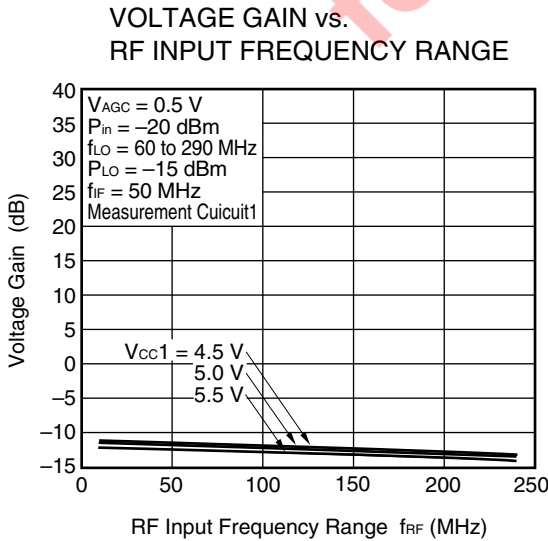
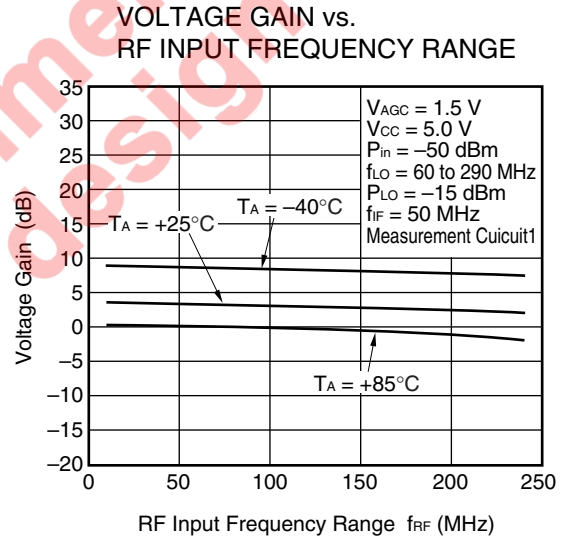
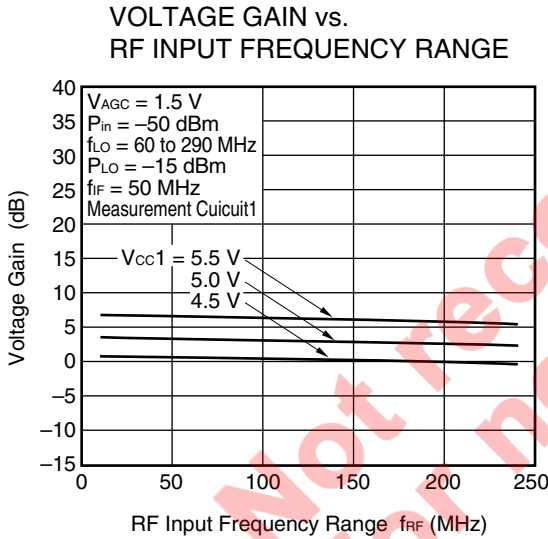
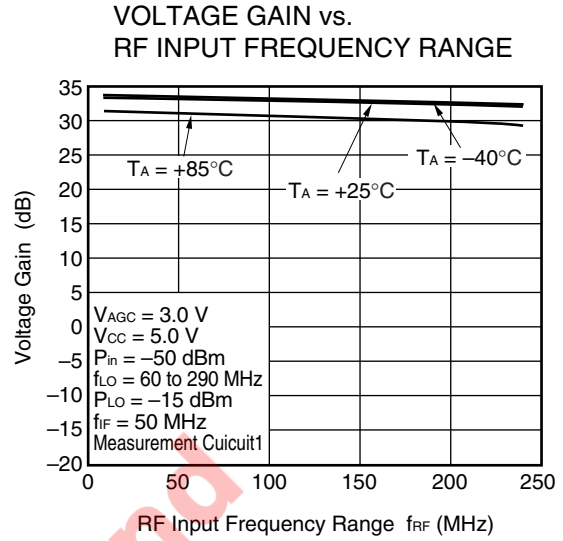
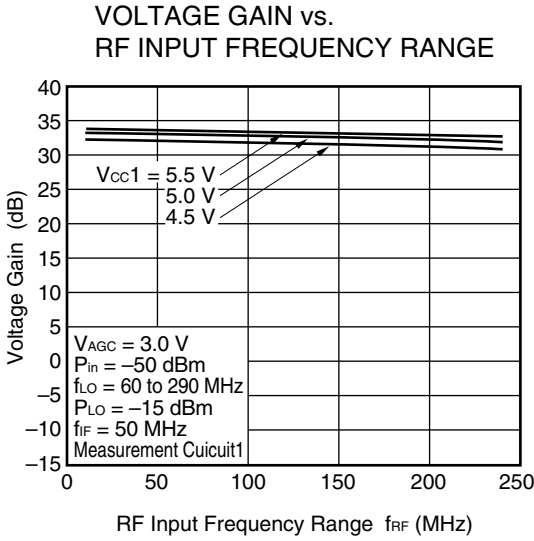

Remark The graphs indicate nominal characteristics.

VOLTAGE GAIN vs.
IF OUTPUT FREQUENCY RANGE

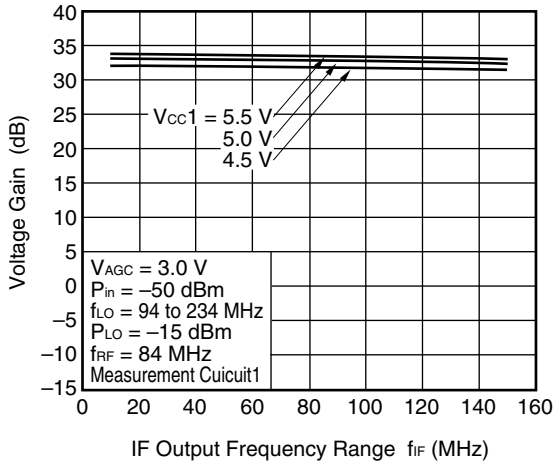

VOLTAGE GAIN vs.
IF OUTPUT FREQUENCY RANGE

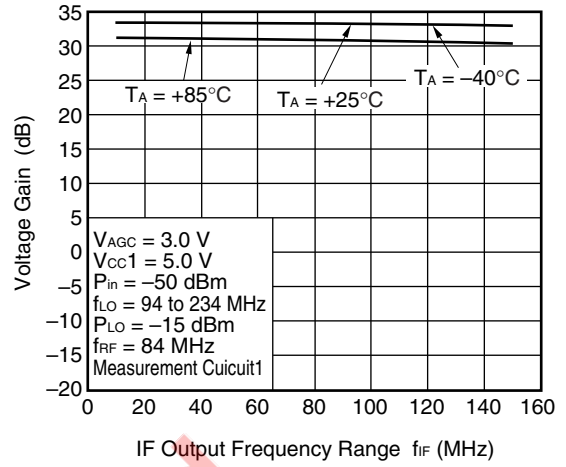

VOLTAGE GAIN vs.
IF OUTPUT FREQUENCY RANGE

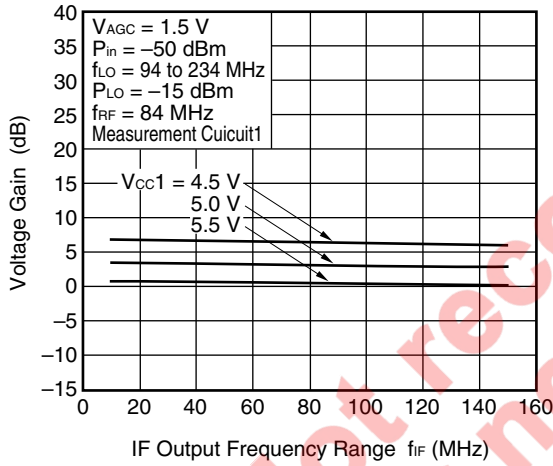

VOLTAGE GAIN vs.
IF OUTPUT FREQUENCY RANGE

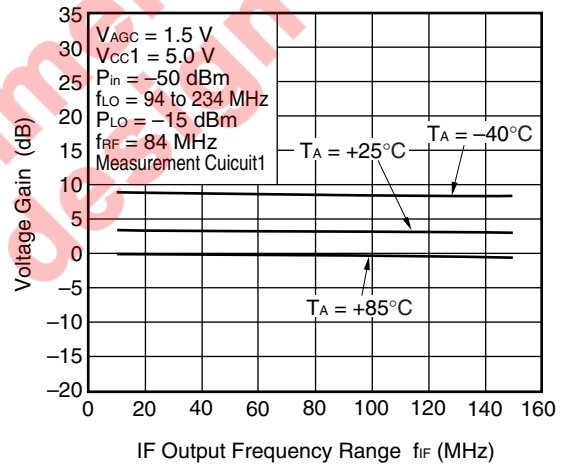

VOLTAGE GAIN vs.
IF OUTPUT FREQUENCY RANGE

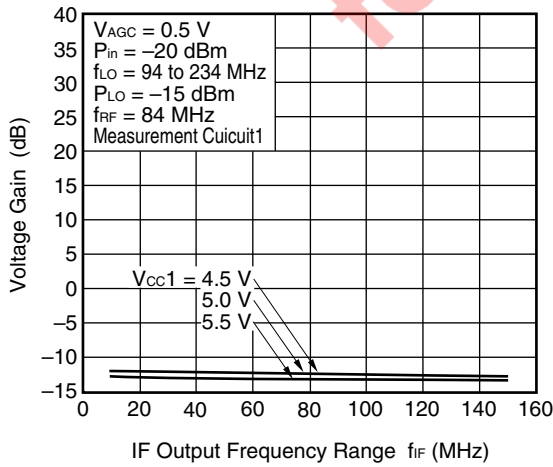

VOLTAGE GAIN vs.
IF OUTPUT FREQUENCY RANGE

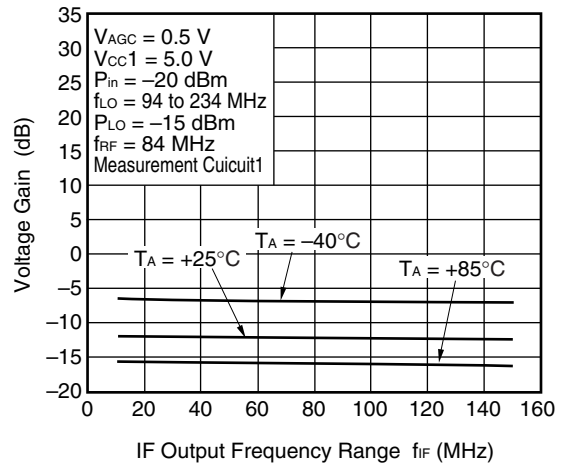

Remark The graphs indicate nominal characteristics.

VOLTAGE GAIN vs.
GAIN CONTROL VOLTAGE RANGE

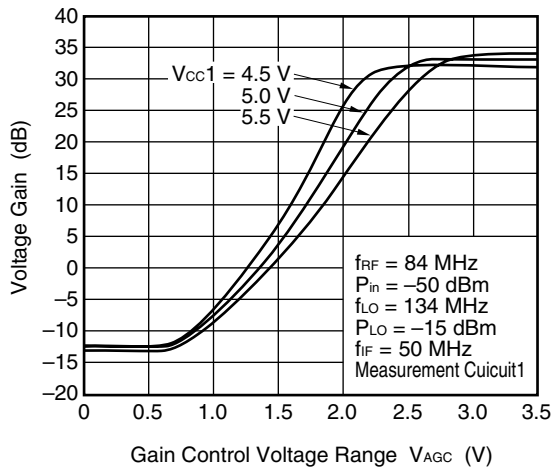

VOLTAGE GAIN vs.
GAIN CONTROL VOLTAGE RANGE

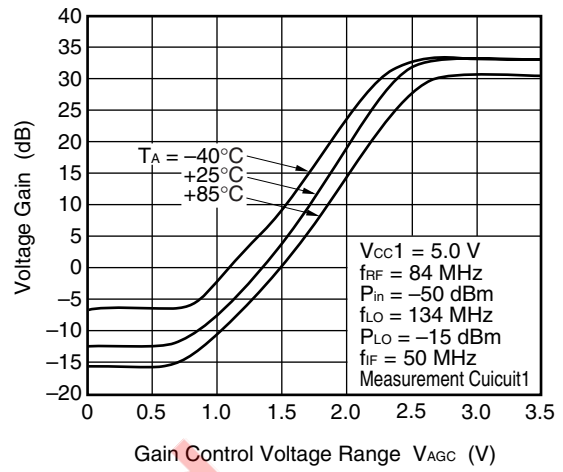

NOISE FIGURE vs.
GAIN CONTROL VOLTAGE RANGE

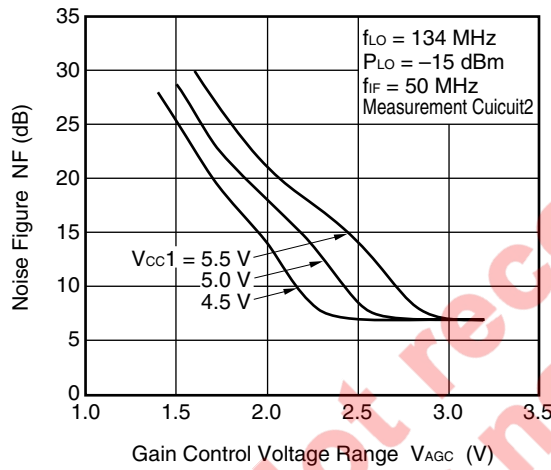

NOISE FIGURE vs.
GAIN CONTROL VOLTAGE RANGE

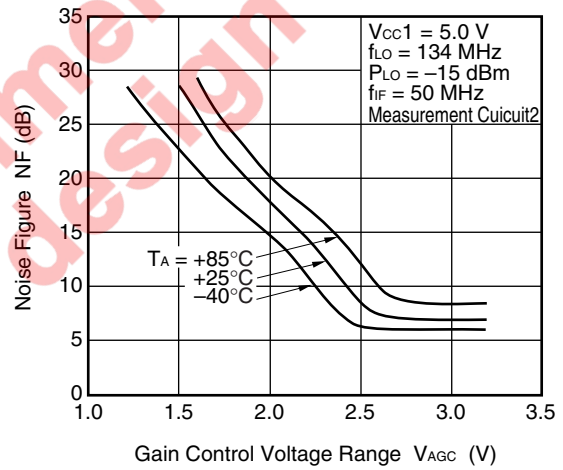

Remark The graphs indicate nominal characteristics.

OUTPUT POWER vs. INPUT POWER

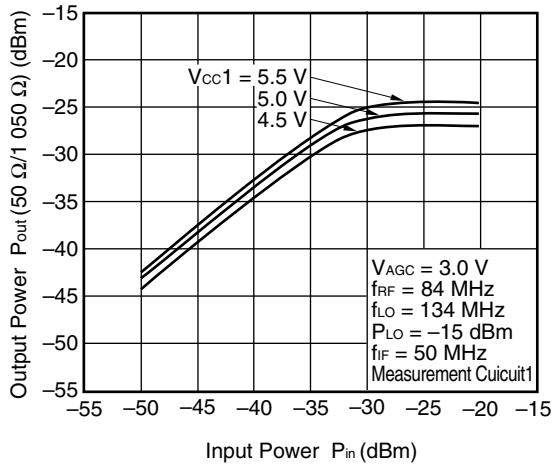

OUTPUT POWER vs. INPUT POWER

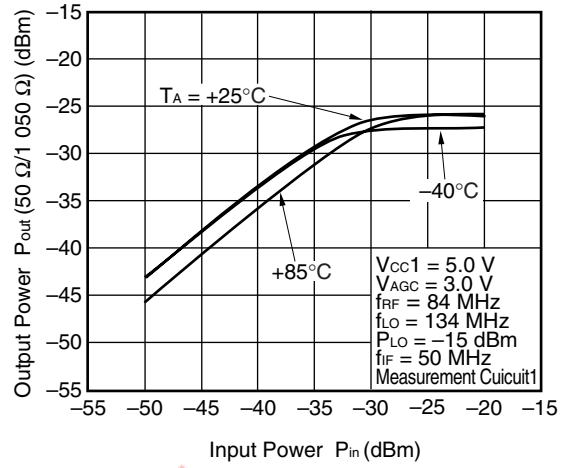

2 TONE OUTPUT POWER vs. INPUT POWER

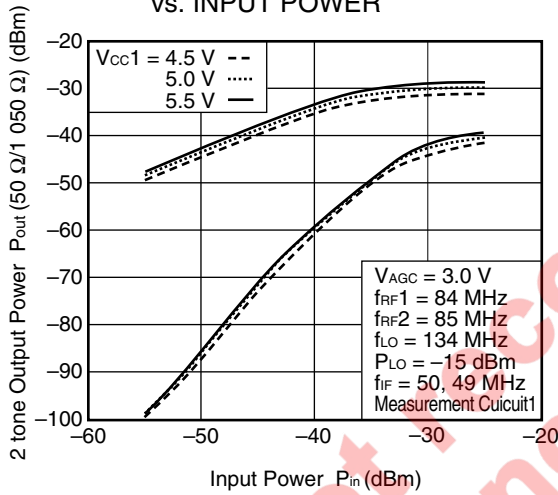

2 TONE OUTPUT POWER vs. INPUT POWER

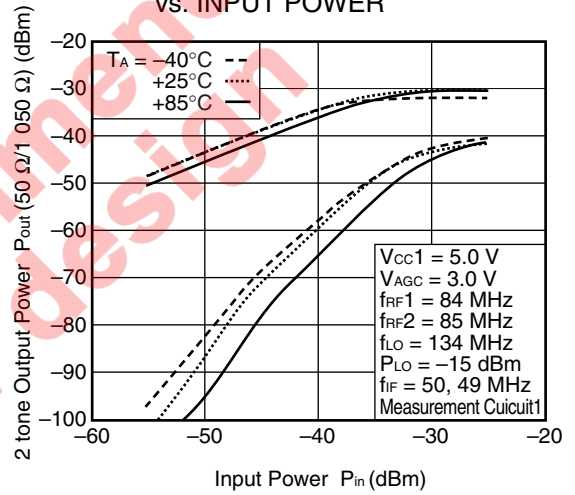

2 TONE OUTPUT POWER vs. INPUT POWER

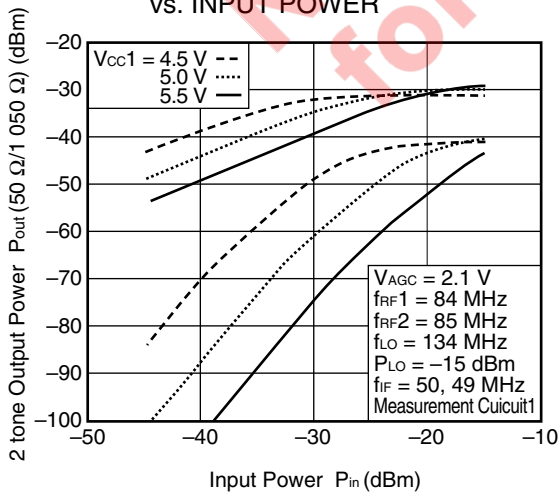

2 TONE OUTPUT POWER vs. INPUT POWER

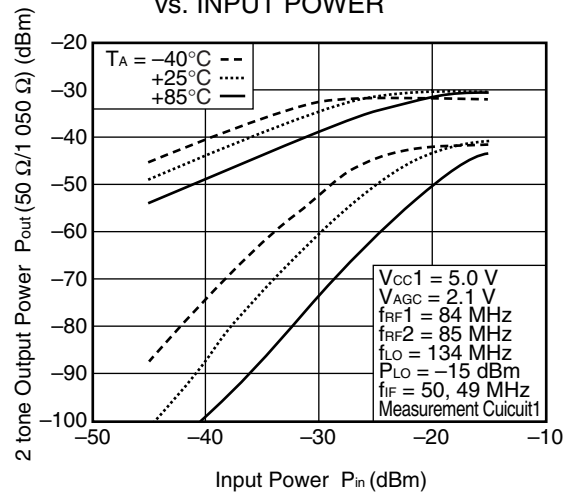

Remark The graphs indicate nominal characteristics.

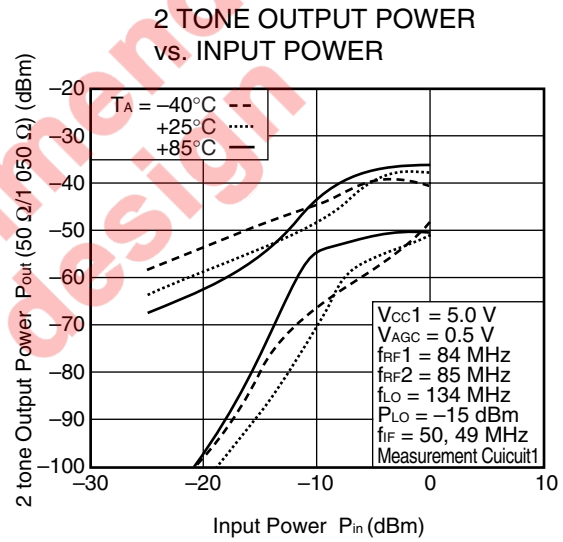
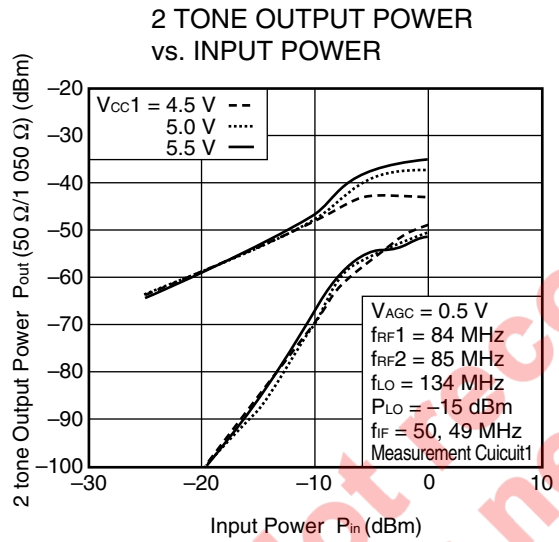
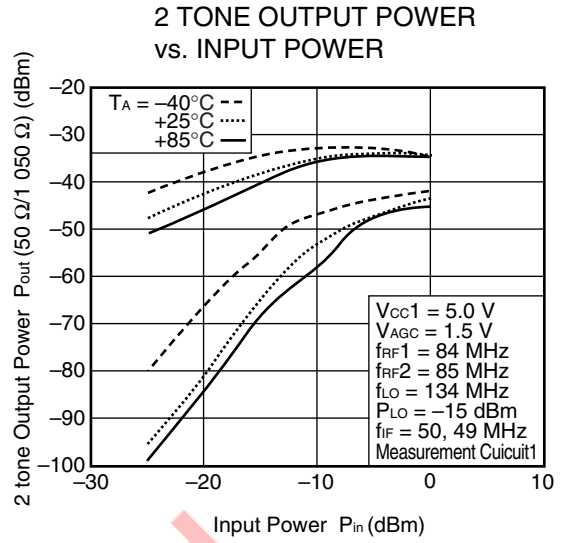
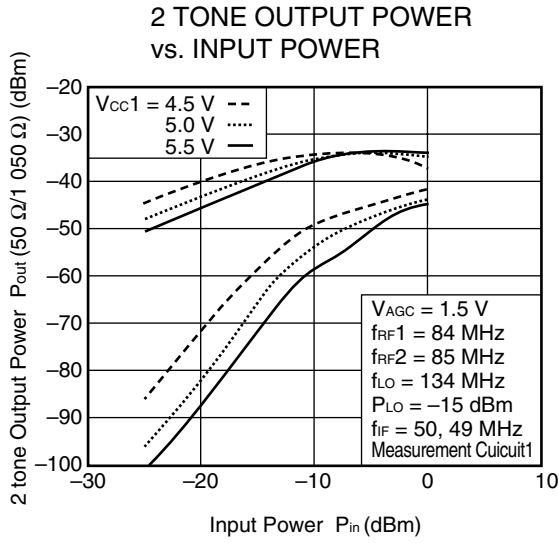

Remark The graphs indicate nominal characteristics.

-Video Amplifier Block-

VOLTAGE GAIN (SINGLE-ENDED)
vs. INPUT FREQUENCY

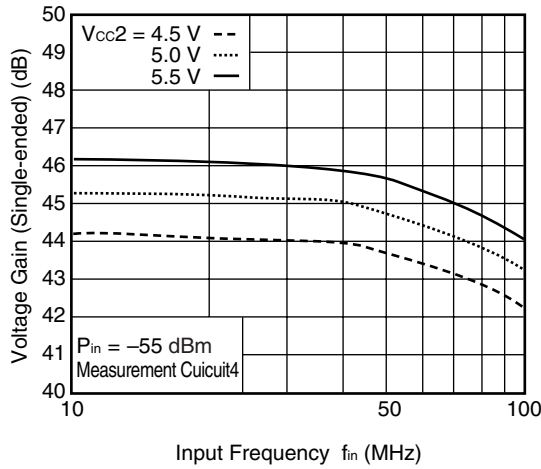

VOLTAGE GAIN (SINGLE-ENDED)
vs. INPUT FREQUENCY

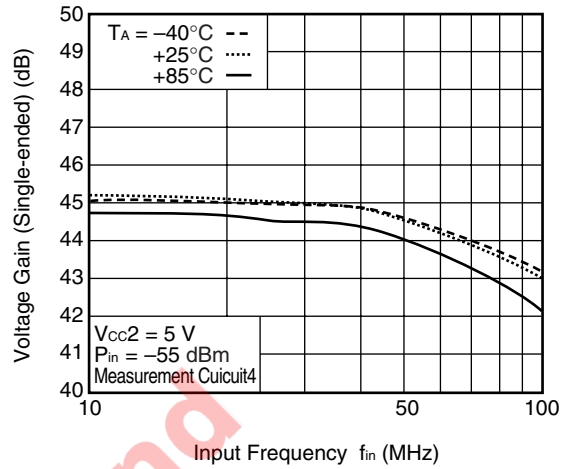

OUTPUT POWER vs. INPUT POWER

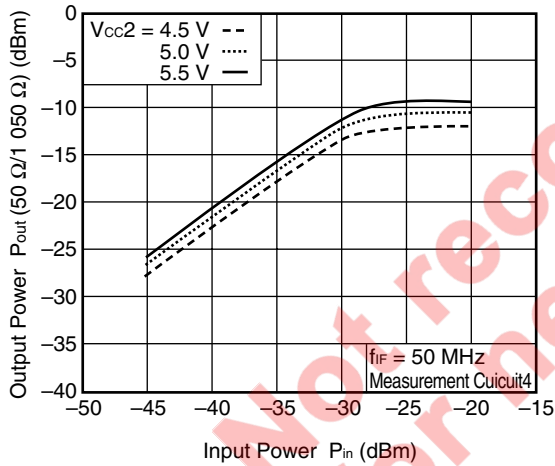

OUTPUT POWER vs. INPUT POWER

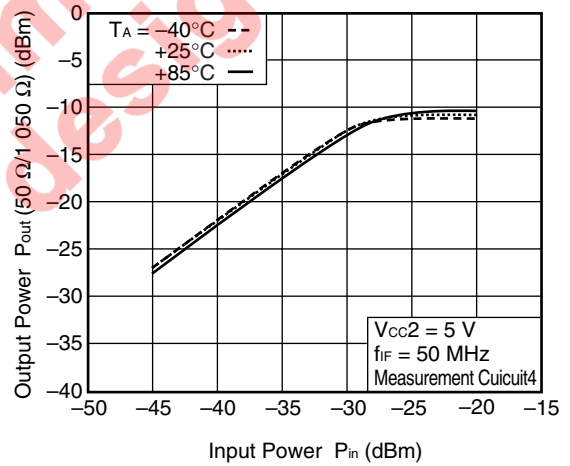

2 TONE OUTPUT POWER
vs. INPUT POWER

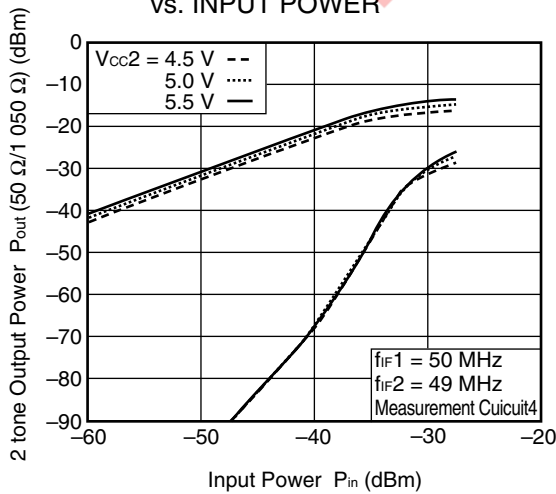

2 TONE OUTPUT POWER
vs. INPUT POWER

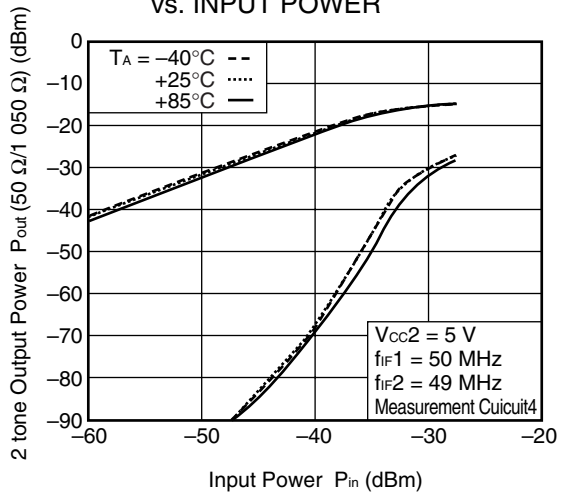

Remark The graphs indicate nominal characteristics.

-Total Block-

VOLTAGE GAIN vs. RF INPUT FREQUENCY RANGE

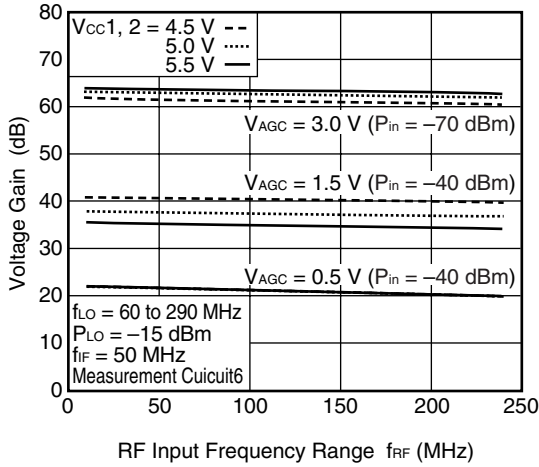

VOLTAGE GAIN vs. RF INPUT FREQUENCY RANGE

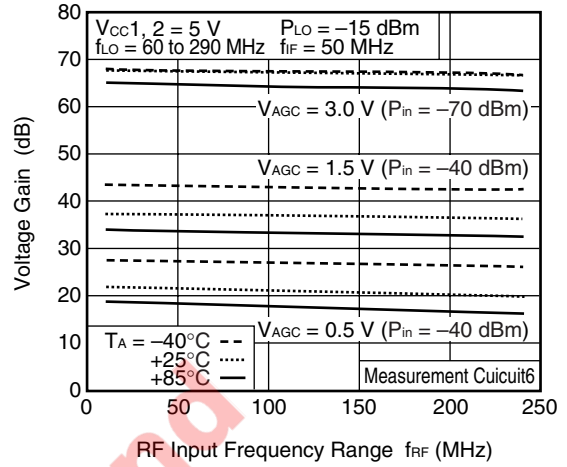

VOLTAGE GAIN vs. IF OUTPUT FREQUENCY RANGE

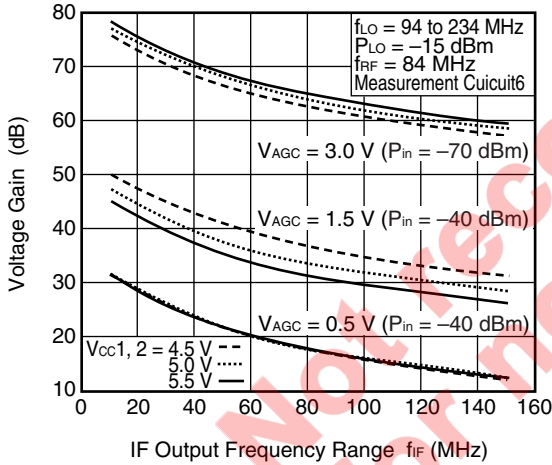

VOLTAGE GAIN vs. IF OUTPUT FREQUENCY RANGE

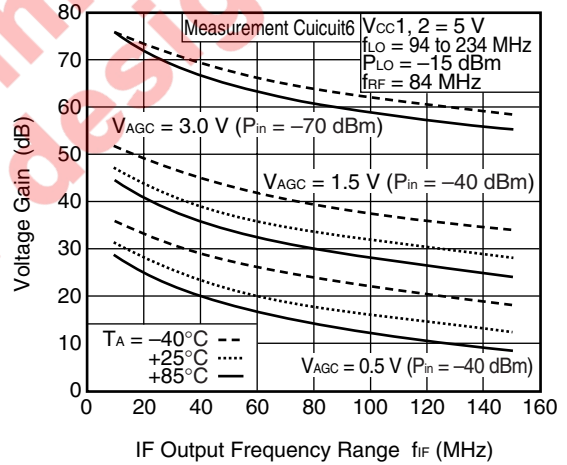

VOLTAGE GAIN vs. GAIN CONTROL VOLTAGE RANGE

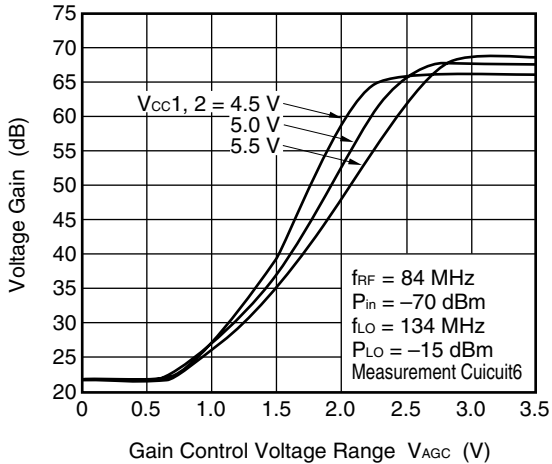

VOLTAGE GAIN vs. GAIN CONTROL VOLTAGE RANGE

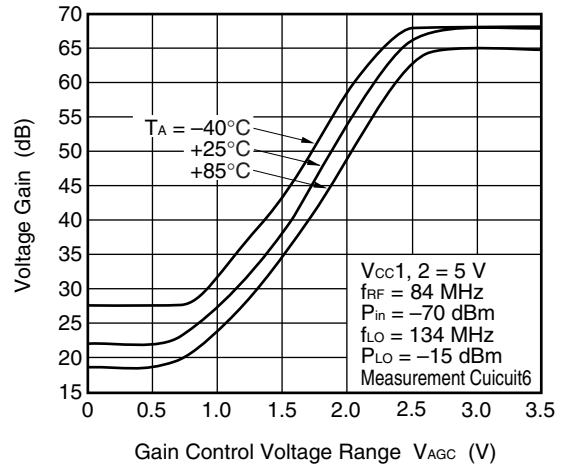

Remark The graphs indicate nominal characteristics.

NOISE FIGURE vs. GAIN CONTROL VOLTAGE RANGE

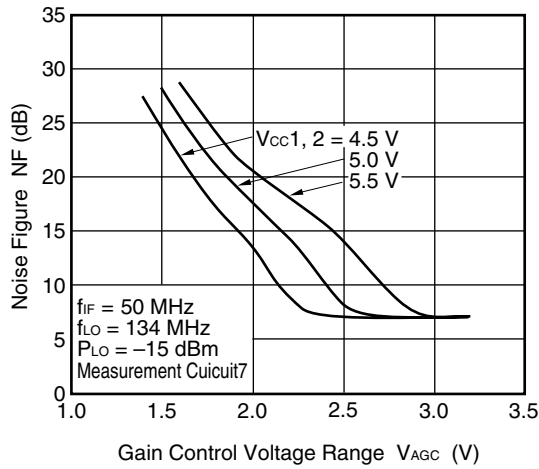

NOISE FIGURE vs. GAIN CONTROL VOLTAGE RANGE

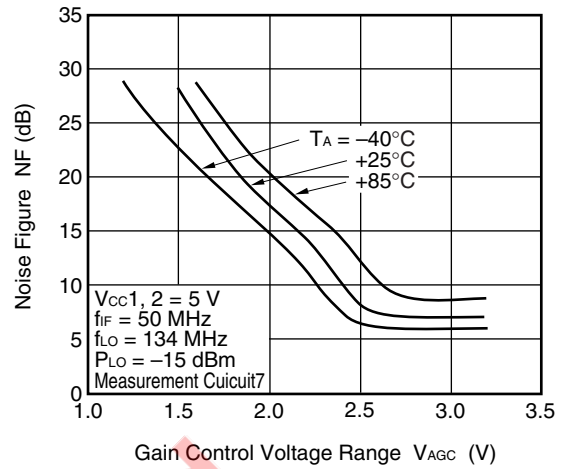

OUTPUT POWER vs. INPUT POWER

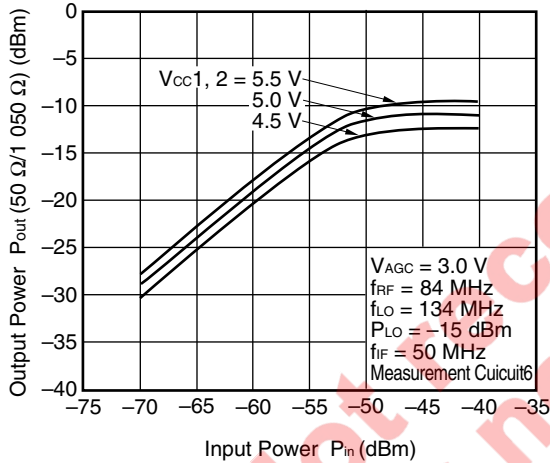

OUTPUT POWER vs. INPUT POWER

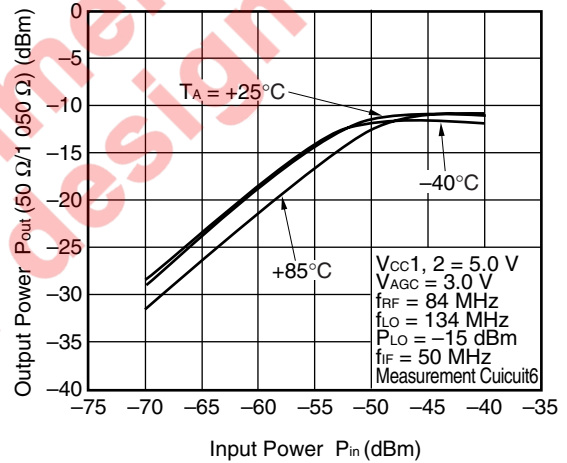

2 TONE OUTPUT POWER vs. INPUT POWER

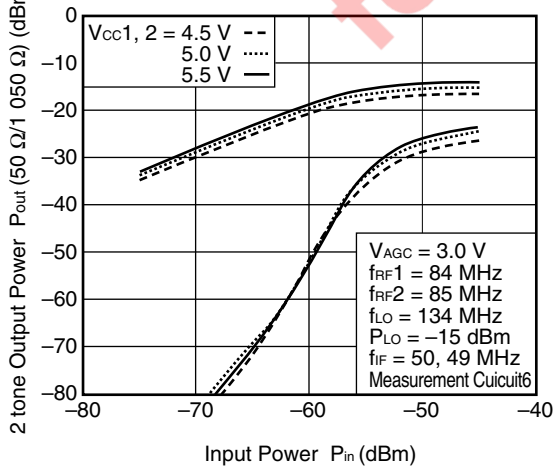

2 TONE OUTPUT POWER vs. INPUT POWER

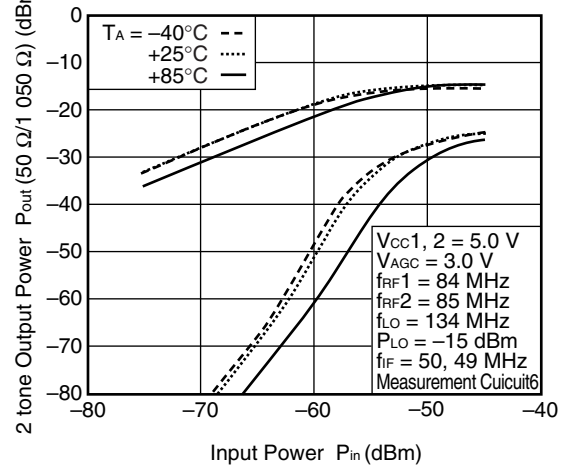

Remark The graphs indicate nominal characteristics.

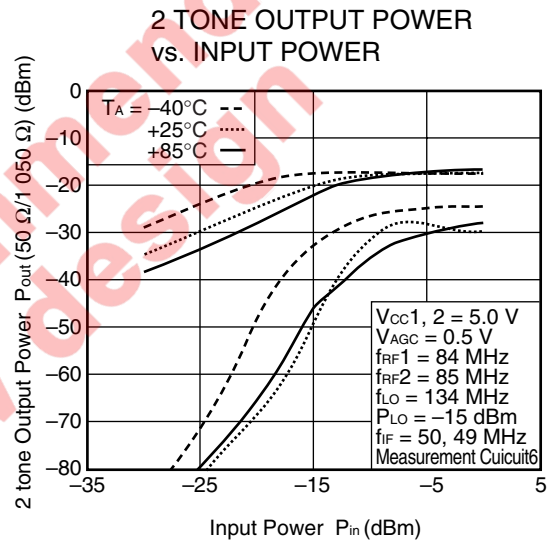
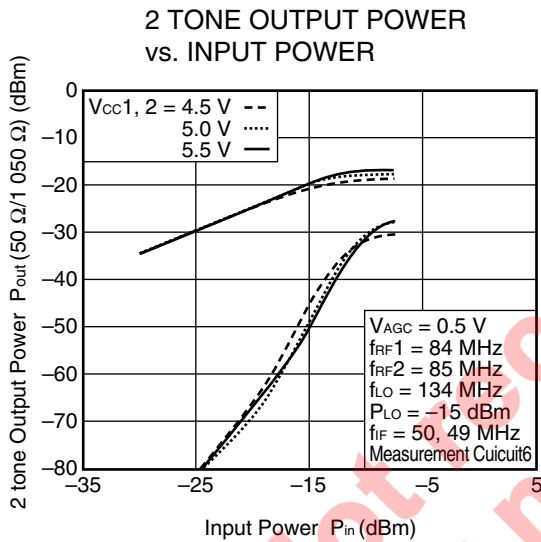
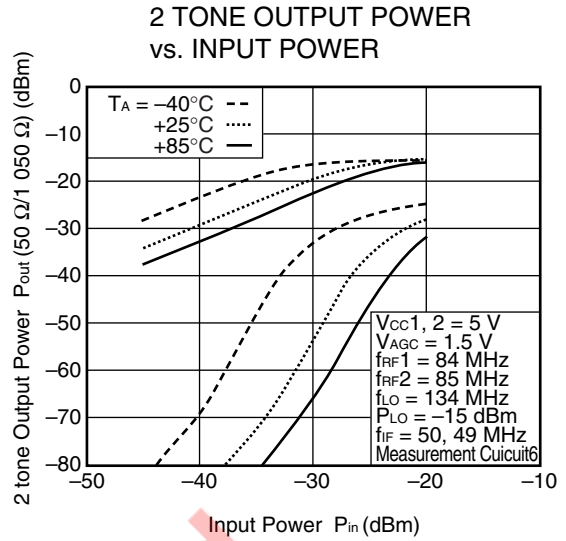
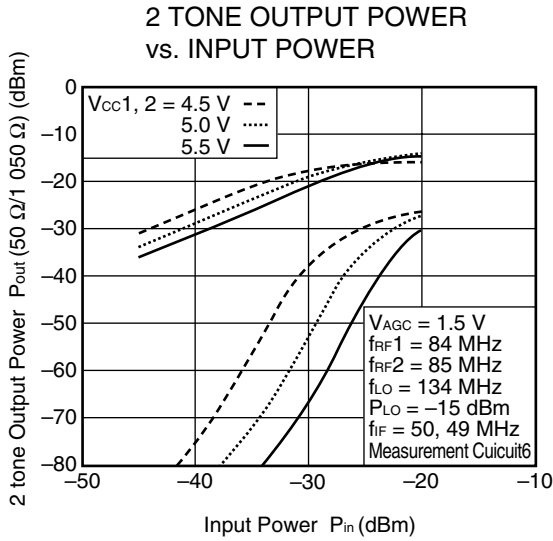

Remark The graphs indicate nominal characteristics.

IM₃, 2 TONE OUTPUT POWER,
GAIN CONTROL VOLTAGE vs. INPUT POWER

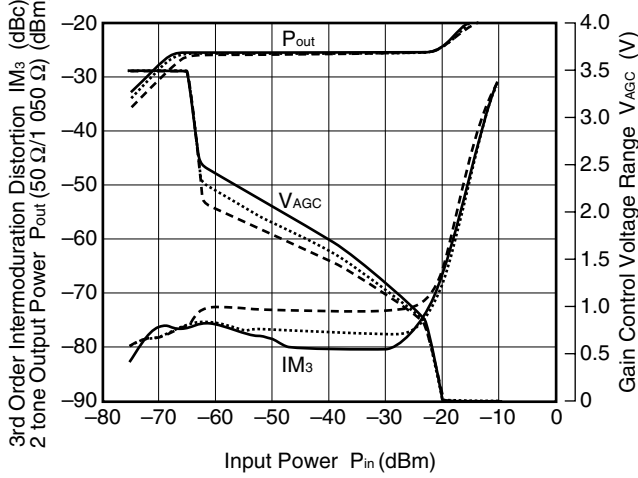

V_{cc1, 2} = 4.5 V --
5.0 V
5.5 V —

Conditions
f_{RF1} = 84 MHz
f_{RF2} = 85 MHz
f_{LO} = 134 MHz
P_{LO} = -15 dBm
f_{IF} = 50, 49 MHz
@V_{out} = 0.7 V_{p-p}/tone
Measurement Cuicuit6

IM₃, 2 TONE OUTPUT POWER,
GAIN CONTROL VOLTAGE vs. INPUT POWER

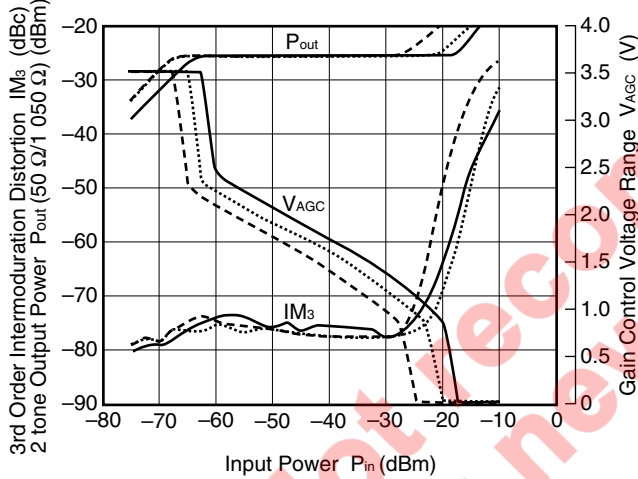

T_A = -40°C --
+25°C
+85°C —

Conditions
f_{RF1} = 84 MHz
f_{RF2} = 85 MHz
f_{LO} = 134 MHz
P_{LO} = -15 dBm
f_{IF} = 50, 49 MHz
@V_{out} = 0.7 V_{p-p}/tone
Measurement Cuicuit6

Remark The graphs indicate nominal characteristics.

S-PARAMETERS

–AGC Amplifier Block + Mixer Block– ($V_{CC1} = 5.0\text{ V}$, $V_{AGC} = 3.0\text{ V}$, by measurement circuit 3)

MIXER RF Input Impedance

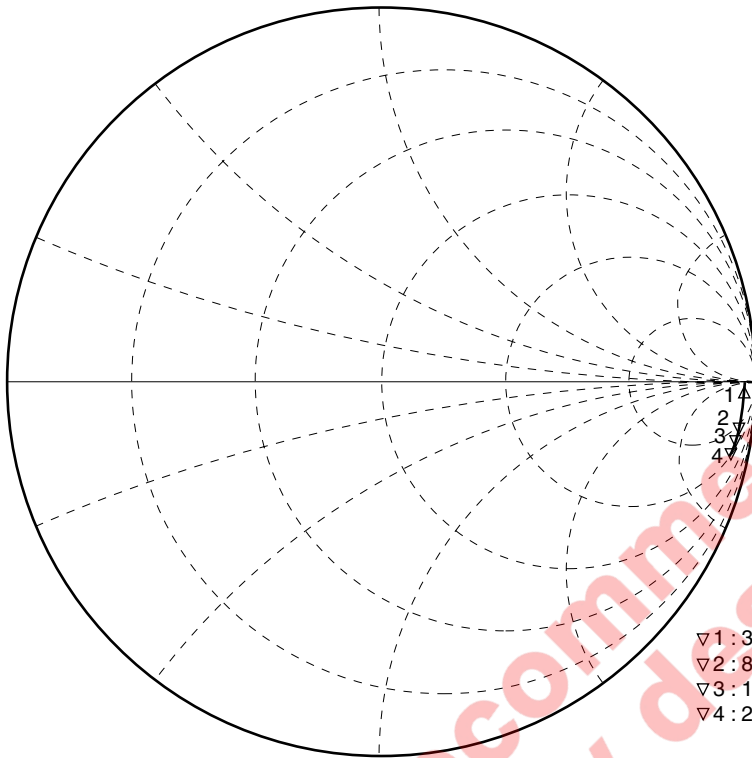

▽1 : 30 MHz	1.830 k Ω	-1.603 k Ω	3.309 pF
▽2 : 84 MHz	443.0 Ω	-1.096 k Ω	1.730 pF
▽3 : 150 MHz	207.4 Ω	-728.7 Ω	1.456 pF
▽4 : 250 MHz	109.7 Ω	-454.1 Ω	1.402 pF

MIXER IF Output Impedance

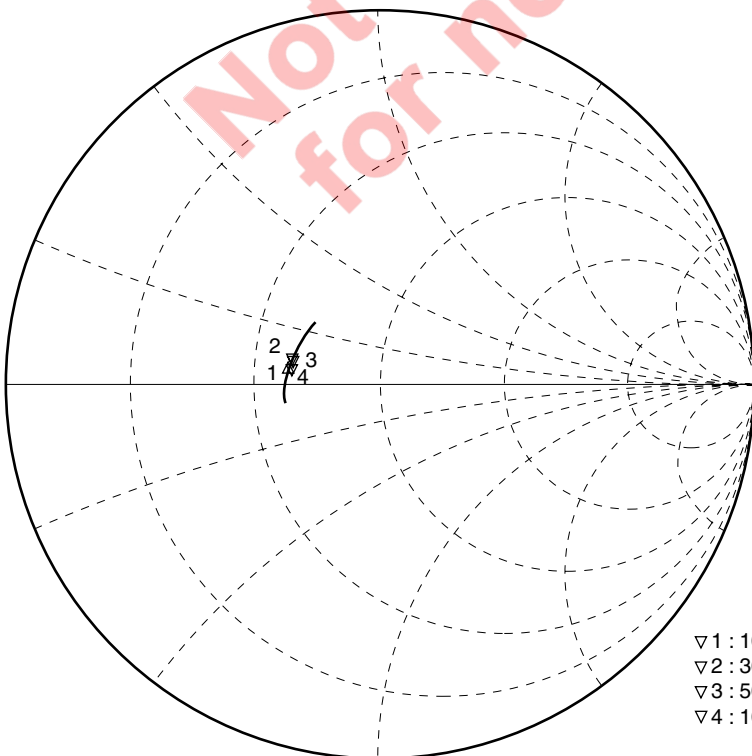

▽1 : 10 MHz	29.48 Ω	634.6 m Ω	10.07 nH
▽2 : 36 MHz	29.98 Ω	1.908 Ω	8.431 nH
▽3 : 50 MHz	30.17 Ω	2.476 Ω	7.884 nH
▽4 : 100 MHz	30.79 Ω	4.171 Ω	6.638 nH

MIXER OSC Input Impedance

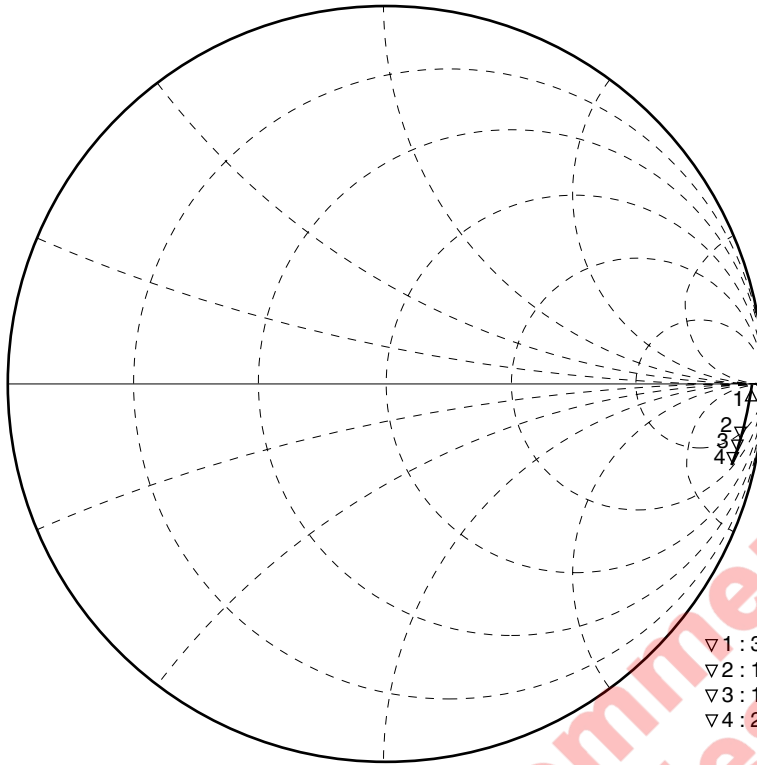

▽1 : 30 MHz	1.820 kΩ	-1.823 kΩ	2.911 pF
▽2 : 100 MHz	415.5 Ω	-1.010 Ω	1.575 pF
▽3 : 134 MHz	284.6 Ω	-813.1 Ω	1.461 pF
▽4 : 250 MHz	133.4 Ω	-487.0 Ω	1.307 pF

Not recommend
for new design

-Video Amplifier Block- ($V_{cc2} = 5.0\text{ V}$, by measurement circuit 5)

Video Amplifier Input Impedance

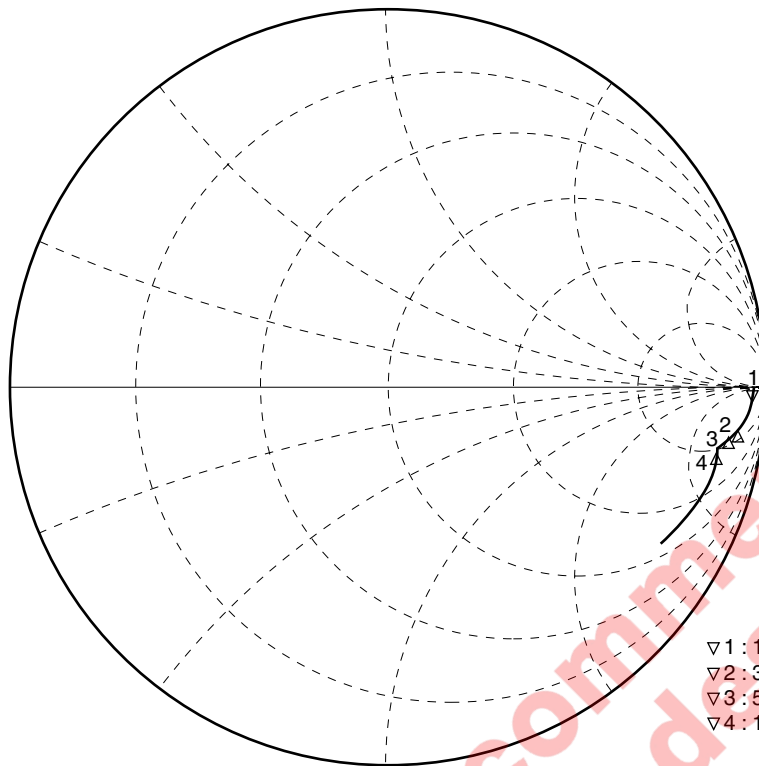

$\nabla 1$: 10 MHz	1.187 k Ω	-1.177 k Ω	13.54 pF
$\nabla 2$: 36 MHz	389.8 Ω	-588.3 Ω	7.516 pF
$\nabla 3$: 50 MHz	333.4 Ω	-481.1 Ω	6.617 pF
$\nabla 4$: 100 MHz	245.5 Ω	-369.7 Ω	4.304 pF

Video Amplifier Output Impedance

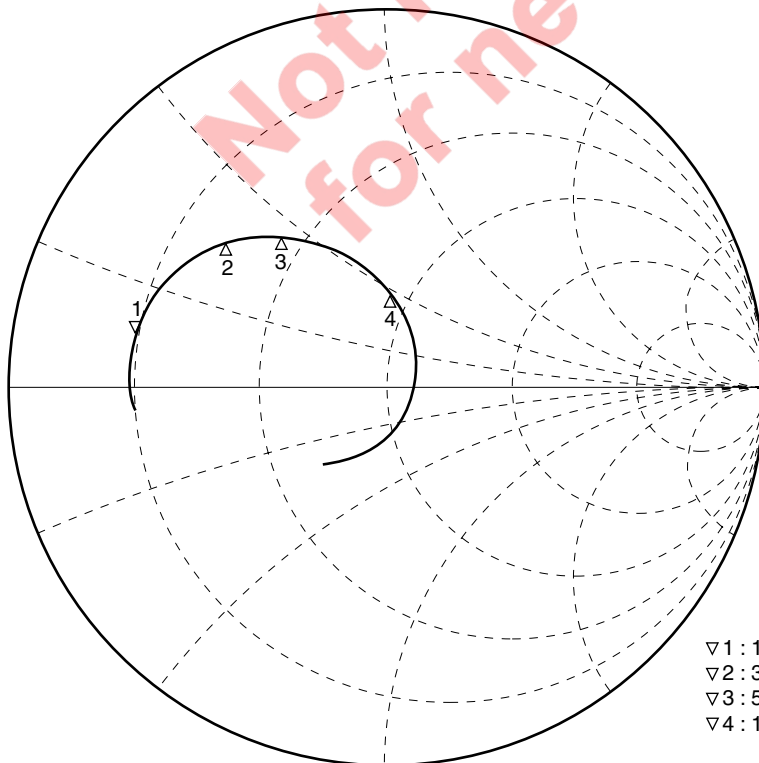

$\nabla 1$: 10 MHz	10.04 Ω	5.225 Ω	83.16 nH
$\nabla 2$: 36 MHz	15.86 Ω	17.70 Ω	78.25 nH
$\nabla 3$: 50 MHz	21.54 Ω	22.61 Ω	71.96 nH
$\nabla 4$: 100 MHz	45.48 Ω	23.89 Ω	38.02 nH

PACKAGE DIMENSIONS

16-PIN PLASTIC SSOP (5.72 mm (225)) (UNIT: mm)

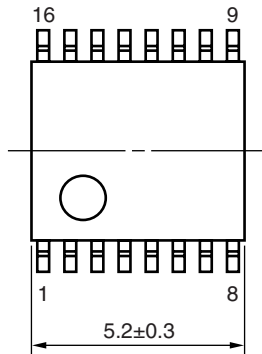

detail of lead end

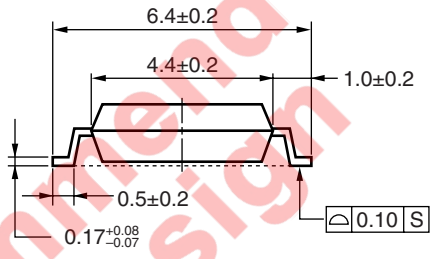
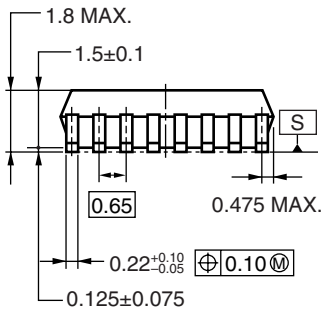
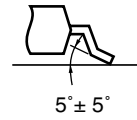

Not recommended for new designs

NOTES ON CORRECT USE

- (1) Observe precautions for handling because of electro-static sensitive devices.
- (2) Form a ground pattern as widely as possible to minimize ground impedance (to prevent undesired oscillation).
All the ground pins must be connected together with wide ground pattern to decrease impedance difference.
- (3) The bypass capacitor should be attached to Vcc line.

RECOMMENDED SOLDERING CONDITIONS

This product should be soldered and mounted under the following recommended conditions. For soldering methods and conditions other than those recommended below, contact your nearby sales office.

Soldering Method	Soldering Conditions	Condition Symbol
Infrared Reflow	Peak temperature (package surface temperature) : 260°C or below Time at peak temperature : 10 seconds or less Time at temperature of 220°C or higher : 60 seconds or less Preheating time at 120 to 180°C : 120±30 seconds Maximum number of reflow processes : 3 times Maximum chlorine content of rosin flux (% mass) : 0.2%(Wt.) or below	IR260
Wave Soldering	Peak temperature (molten solder temperature) : 260°C or below Time at peak temperature : 10 seconds or less Preheating temperature (package surface temperature) : 120°C or below Maximum number of flow processes : 1 time Maximum chlorine content of rosin flux (% mass) : 0.2%(Wt.) or below	WS260
Partial Heating	Peak temperature (pin temperature) : 350°C or below Soldering time (per side of device) : 3 seconds or less Maximum chlorine content of rosin flux (% mass) : 0.2%(Wt.) or below	HS350

Caution Do not use different soldering methods together (except for partial heating).

Not recommended for new design

When the product(s) listed in this document is subject to any applicable import or export control laws and regulation of the authority having competent jurisdiction, such product(s) shall not be imported or exported without obtaining the import or export license.

- **The information in this document is current as of January, 2005. The information is subject to change without notice. For actual design-in, refer to the latest publications of NEC's data sheets or data books, etc., for the most up-to-date specifications of NEC semiconductor products. Not all products and/or types are available in every country. Please check with an NEC sales representative for availability and additional information.**
 - No part of this document may be copied or reproduced in any form or by any means without prior written consent of NEC. NEC assumes no responsibility for any errors that may appear in this document.
 - NEC does not assume any liability for infringement of patents, copyrights or other intellectual property rights of third parties by or arising from the use of NEC semiconductor products listed in this document or any other liability arising from the use of such products. No license, express, implied or otherwise, is granted under any patents, copyrights or other intellectual property rights of NEC or others.
 - Descriptions of circuits, software and other related information in this document are provided for illustrative purposes in semiconductor product operation and application examples. The incorporation of these circuits, software and information in the design of customer's equipment shall be done under the full responsibility of customer. NEC assumes no responsibility for any losses incurred by customers or third parties arising from the use of these circuits, software and information.
 - While NEC endeavours to enhance the quality, reliability and safety of NEC semiconductor products, customers agree and acknowledge that the possibility of defects thereof cannot be eliminated entirely. To minimize risks of damage to property or injury (including death) to persons arising from defects in NEC semiconductor products, customers must incorporate sufficient safety measures in their design, such as redundancy, fire-containment, and anti-failure features.
 - NEC semiconductor products are classified into the following three quality grades:
 "Standard", "Special" and "Specific". The "Specific" quality grade applies only to semiconductor products developed based on a customer-designated "quality assurance program" for a specific application. The recommended applications of a semiconductor product depend on its quality grade, as indicated below. Customers must check the quality grade of each semiconductor product before using it in a particular application.
 "Standard": Computers, office equipment, communications equipment, test and measurement equipment, audio and visual equipment, home electronic appliances, machine tools, personal electronic equipment and industrial robots
 "Special": Transportation equipment (automobiles, trains, ships, etc.), traffic control systems, anti-disaster systems, anti-crime systems, safety equipment and medical equipment (not specifically designed for life support)
 "Specific": Aircraft, aerospace equipment, submersible repeaters, nuclear reactor control systems, life support systems and medical equipment for life support, etc.
- The quality grade of NEC semiconductor products is "Standard" unless otherwise expressly specified in NEC's data sheets or data books, etc. If customers wish to use NEC semiconductor products in applications not intended by NEC, they must contact an NEC sales representative in advance to determine NEC's willingness to support a given application.
- (Note)
- (1) "NEC" as used in this statement means NEC Corporation, NEC Compound Semiconductor Devices, Ltd. and also includes its majority-owned subsidiaries.
 - (2) "NEC semiconductor products" means any semiconductor product developed or manufactured by or for NEC (as defined above).

M8E 00.4-0110

Not recommend
for new design

► For further information, please contact

NEC Compound Semiconductor Devices, Ltd. <http://www.ncsd.necel.com/>

E-mail: salesinfo@ml.ncsd.necel.com (sales and general)

techinfo@ml.ncsd.necel.com (technical)

Sales Division TEL: +81-44-435-1588 FAX: +81-44-435-1579

NEC Compound Semiconductor Devices Hong Kong Limited

E-mail: ncsd-hk@elhk.nec.com.hk (sales, technical and general)

Hong Kong Head Office TEL: +852-3107-7303 FAX: +852-3107-7309

Taipei Branch Office TEL: +886-2-8712-0478 FAX: +886-2-2545-3859

Korea Branch Office TEL: +82-2-558-2120 FAX: +82-2-558-5209

NEC Electronics (Europe) GmbH <http://www.ee.nec.de/>

TEL: +49-211-6503-0 FAX: +49-211-6503-1327

California Eastern Laboratories, Inc. <http://www.cel.com/>

TEL: +1-408-988-3500 FAX: +1-408-988-0279