

DDR 14-Bit Registered Buffer

ICSSSTV16857C

Recommended Applications:

- DDR Memory Modules
- Provides complete DDR DIMM logic solution with ICS93V857 or ICS95V857
- SSTL_2 compatible data registers

Product Features:

- Differential clock signal
- Meets SSTL_2 signal data
- Supports SSTL_2 class I & II specifications
- Low-voltage operation
- $V_{DD} = 2.3V$ to $2.7V$
- 48 pin TSSOP package

Truth Table¹

Inputs				Q Outputs
RESET#	CLK	CLK#	D	Q
L	X or Floating	X or Floating	X or Floating	L
H	↑	↓	H	H
H	↑	↓	L	L
H	L or H	L or H	X	$Q_0^{(2)}$

Notes:

1. H = High Signal Level
L = Low Signal Level
↑ = Transition LOW-to-HIGH
↓ = Transition HIGH -to LOW
X = Irrelevant
2. Output level before the indicated steady state input conditions were established.

Pin Configuration

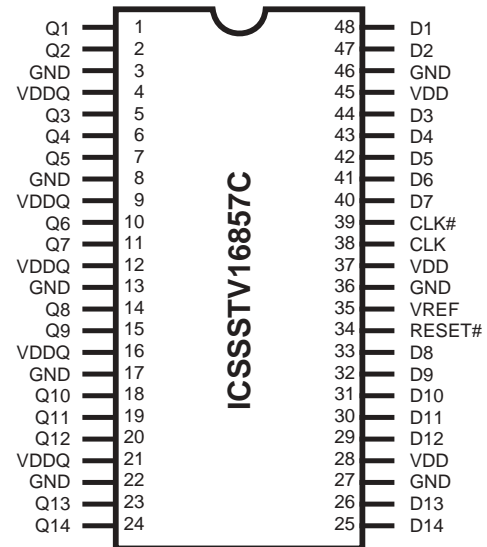

48-Pin TSSOP & TVSOP

6.10 mm. Body, 0.50 mm. pitch = TSSOP
4.40 mm. Body, 0.40 mm. pitch = TSSOP (TVSOP)

Block Diagram

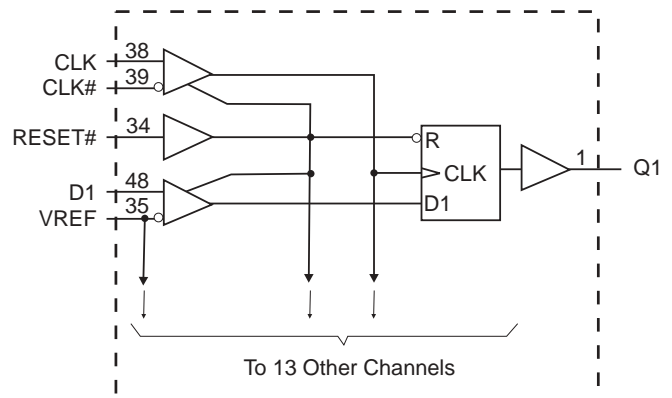

General Description

The 14-bit ICSSSTV16857C is a universal bus driver designed for 2.3V to 2.7V V_{DD} operation and SSTL_2 I/O levels, except for the LVCMOS RESET# input.

Data flow from D to Q is controlled by the differential clock (CLK/CLK#) and a control signal (RESET#). The positive edge of CLK is used to trigger the data flow and CLK# is used to maintain sufficient noise margins where as RESET#, an LVCMOS asynchronous signal, is intended for use at the time of power-up only. ICSSSTV16857C supports low-power standby operation. A logic level "Low" at RESET# assures that all internal registers and outputs (Q) are reset to the logic "Low" state, and all input receivers, data (D) and clock (CLK/CLK#) are switched off. Please note that RESET# must always be supported with LVCMOS levels at a valid logic state because VREF may not be stable during power-up.

To ensure that outputs are at a defined logic state before a stable clock has been supplied, RESET# must be held at a logic "Low" level during power up.

In the DDR DIMM application, RESET# is specified to be completely asynchronous with respect to CLK and CLK#. Therefore, no timing relationship can be guaranteed between the two signals. When entering a low-power standby state, the register will be cleared and the outputs will be driven to a logic "Low" level quickly relative to the time to disable the differential input receivers. This ensures there are no glitches on the output. However, when coming out of low-power standby state, the register will become active quickly relative to the time to enable the differential input receivers. When the data inputs are at a logic level "Low" and the clock is stable during the "Low"-to-"High" transition of RESET# until the input receivers are fully enabled, the design ensures that the outputs will remain at a logic "Low" level.

Pin Configuration

PIN NUMBER	PIN NAME	TYPE	DESCRIPTION
24, 23, 20, 19, 18, 15, 14, 11, 10, 7, 6, 5, 2, 1	Q (14:1)	OUTPUT	Data output
3, 8, 13, 22, 27, 36, 46	GND	PWR	Ground
4, 9, 12, 16, 21	VDDQ	PWR	Output supply voltage
25, 26, 29, 30, 31, 32, 33, 40, 41, 42, 43, 44, 47, 48	D (14:1)	INPUT	Data input
38	CLK	INPUT	Positive clock input
39	CLK#	INPUT	Negative clock input
28, 37, 45	VDD	PWR	Core supply voltage
34	RESET#	INPUT	Reset (active low)
35	VREF	INPUT	Input reference voltage

Absolute Maximum Ratings

Storage Temperature	-65°C to +150°C
Supply Voltage	-0.5 to 3.6V
Input Voltage ¹	-0.5 to V _{DD} +0.5
Output Voltage ^{1,2}	-0.5 to V _{DDQ} +0.5
Input Clamp Current	±50 mA
Output Clamp Current	±50 mA
Continuous Output Current	±50 mA
V _{DD} , V _{DDQ} or GND Current/Pin	±100 mA
Package Thermal Impedance ³	55°C/W

Notes:

1. The input and output negative voltage ratings may be excluded if the input and output clamp ratings are observed.
2. This current will flow only when the output is in the high state level $V_0 > V_{DDQ}$.
3. The package thermal impedance is calculated in accordance with JESD 51.

Stresses above those listed under *Absolute Maximum Ratings* may cause permanent damage to the device. These ratings are stress specifications only and functional operation of the device at these or any other conditions above those listed in the operational sections of the specifications is not implied. Exposure to absolute maximum rating conditions for extended periods may affect product reliability.

Recommended Operating Conditions

PARAMETER	DESCRIPTION	MIN	TYP	MAX	UNITS
V _{DD}	Supply Voltage	2.3	2.5	2.7	V
V _{DDQ}	I/O Supply Voltage	2.3	2.5	2.7	
V _{REF}	Reference Voltage	1.15	1.25	1.35	
V _{TT}	Termination Voltage	V _{REF} - 0.04	V _{REF}	V _{REF} + 0.04	
V _I	Input Voltage	0		V _{DDQ}	
V _{IH(DC)}	DC Input High Voltage	V _{REF} + 0.15			
V _{IH(AC)}	AC Input High Voltage	V _{REF} + 0.31			
V _{IL(DC)}	DC Input Low Voltage			V _{REF} - 0.15	
V _{IL(AC)}	AC Input Low Voltage			V _{REF} - 0.31	
V _{IH}	Input High Voltage Level	1.7			
V _{IL}	Input Low Voltage Level			0.7	
V _{ICR}	Common mode Input Range	0.97		1.53	
V _{ID}	Differential Input Voltage	0.36			
V _{IX}	Cross Point Voltage of Differential Clock Pair	(V _{DDQ} /2) - 0.2		(V _{DDQ} /2) + 0.2	
I _{OH}	High-Level Output Current			-20	
I _{OL}	Low-Level Output Current			20	
T _A	Operating Free-Air Temperature	0		70	°C

¹Guaranteed by design, not 100% tested in production.

Electrical Characteristics - DC

$T_A = 0 - 70^\circ \text{C}$; $V_{DD} = 2.5 \pm 0.2\text{V}$, $V_{DDQ} = 2.5 \pm 0.2\text{V}$; (unless otherwise stated)

SYMBOL	PARAMETERS	CONDITIONS	V_{DDQ}	MIN	TYP	MAX	UNITS			
V_{IK}		$I_I = -18\text{mA}$	2.3V			-1.2	V			
V_{OH}		$I_{OH} = -100\mu\text{A}$	2.3V-2.7V	$V_{DDQ} - 0.2$						
		$I_{OH} = -16\text{mA}$	2.3V	1.95						
V_{OL}		$I_{OL} = 100\mu\text{A}$	2.3V-2.7V			0.2				
		$I_{OL} = 16\text{mA}$	2.3V			0.35				
I_I	All Inputs	$V_I = V_{DD}$ or GND	2.7V			± 5	μA			
I_{DD}	Standby (Static)	RESET# = GND	2.7V		52	0.01	μA			
	Operating (Static)	$V_I = V_{IH(AC)}$ or $V_{IL(AC)}$, RESET# = V_{DD}					mA			
I_{DDD}	Dynamic operating (clock only)	RESET# = V_{DD} , $V_I = V_{IH(AC)}$ or $V_{IL(AC)}$, CLK and CLK# switching 50% duty cycle.				$I_O = 0$	75			$\mu\text{A}/\text{clock MHz}$
	Dynamic Operating (per each data input)	RESET# = V_{DD} , $V_I = V_{IH(AC)}$ or $V_{IL(AC)}$, CLK and CLK# switching 50% duty cycle. One data input switching at half clock frequency, 50% duty cycle								15
r_{OH}	Output High	$I_{OH} = -20\text{mA}$				2.3V-2.7V	7	13.5	20	Ω
r_{OL}	Output Low	$I_{OL} = 20\text{mA}$	2.3V-2.7V	7	13	20	Ω			
$r_{O(D)}$	[$r_{OH} - r_{OL}$] each separate bit	$I_O = 20\text{mA}$, $T_A = 25^\circ \text{C}$	2.5V			4	Ω			
C_i	Data Inputs	$V_I = V_{REF} \pm 350\text{mV}$	2.5V	2.5		3.5	pF			
	CLK and CLK#	$V_{ICR} = 1.25\text{V}$, $V_{I(PP)} = 360\text{mV}$		2.5		3.5				

Notes:

1 - Guaranteed by design, not 100% tested in production.

Timing Requirements¹

(over recommended operating free-air temperature range, unless otherwise noted)

SYMBOL	PARAMETERS		$V_{DDQ} = 2.5 \pm 0.2V$		UNITS
			MIN	MAX	
f_{clock}	Clock frequency			200	MHz
t_{PD}	Clock to output time		1.7	2.5	ns
t_{RST}	Reset to output time			3.5	ns
t_{SL}	Output slew rate		1	4	V/ns
t_s	Setup time, fast slew rate ^{2&4}	Data before CLK \uparrow , CLK# \downarrow	0.4		ns
	Setup time, slow slew rate ^{3&4}		0.5		ns
T_h	Hold time, fast slew rate ^{2&4}	Data after CLK \uparrow , CLK# \downarrow	0.4		ns
	Hold time, slow slew rate ^{3&4}		0.5		ns

- Notes:
- 1 - Guaranteed by design, not 100% tested in production.
 - 2 - For data signal input slew rate $\geq 1V/ns$.
 - 3 - For data signal input slew rate $\geq 0.5V/ns$ and $< 1V/ns$.
 - 4 - CLK, CLK# signals input slew rates are $\geq 1V/ns$.

Switching Characteristics

(over recommended operating free-air temperature range, unless otherwise noted) (see Figure 1)

SYMBOL	From (Input)	To (Output)	$V_{DD} = 2.5V \pm 0.2V$			UNITS
			MIN	TYP	MAX	
f_{max}			200			MHz
t_{PD}	CLK, CLK#	Q	1.7	2.1	2.5	ns
t_{phl}	RESET#	Q			3.5	ns

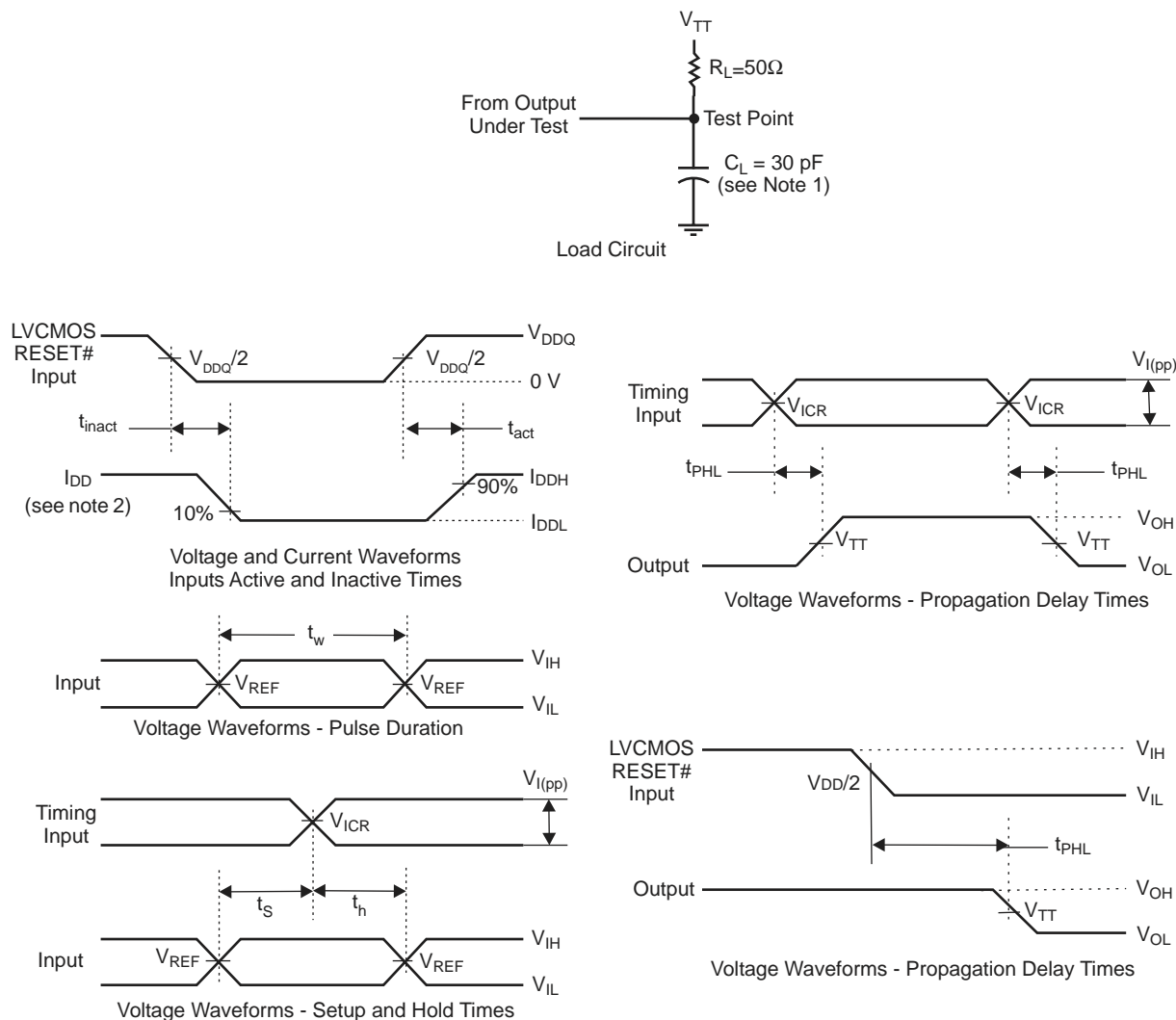
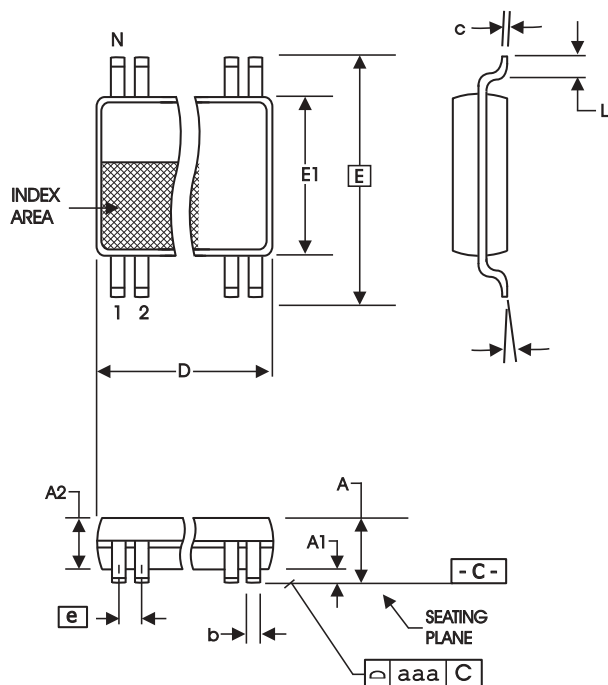

Figure 1 - Parameter Measurement Information ($V_{DDQ} = 2.5V \pm 0.2V$)

- Notes:
1. C_L includes probe and jig capacitance.
 2. I_{DD} tested with clock and data inputs held at V_{DDQ} or GND, and $I_O = 0$ mA.
 3. All input pulses are supplied by generators having the following characteristics: PRR @10 MHz, $Z_o=50\Omega$, input slew rate = 1 V/ns $\pm 20\%$ (unless otherwise specified).
 4. The outputs are measured one at a time with one transition per measurement.
 5. $V_{TT} = V_{REF} = V_{DDQ}/2$
 6. $V_{IH} = V_{REF} + 310$ mV (AC voltage levels) for differential inputs. $V_{IH} = V_{DDQ}$ for LVC MOS input.
 7. $V_{IL} = V_{REF} - 310$ mV (AC voltage levels) for differential inputs. $V_{IL} =$ GND for LVC MOS input.
 8. t_{PLH} and t_{PHL} are the same as t_{pd}



SYMBOL	In Millimeters		In Inches	
	MIN	MAX	MIN	MAX
A	--	1.20	--	.047
A1	0.05	0.15	.002	.006
A2	0.80	1.05	.032	.041
b	0.17	0.27	.007	.011
c	0.09	0.20	.0035	.008
D	SEE VARIATIONS		SEE VARIATIONS	
E	8.10 BASIC		0.319 BASIC	
E1	6.00	6.20	.236	.244
e	0.50 BASIC		0.020 BASIC	
L	0.45	0.75	.018	.030
N	SEE VARIATIONS		SEE VARIATIONS	
α	0°	8°	0°	8°
aaa	--	0.10	--	.004

VARIATIONS

N	D mm.		D (inch)	
	MIN	MAX	MIN	MAX
48	12.40	12.60	.488	.496

Reference Doc.: JEDEC Publication 95, MO-153

10-0039

6.10 mm. Body, 0.50 mm. pitch TSSOP
(240 mil) (0.020 mil)

Ordering Information

ICSSSTV16857CG-T

Example:

ICS XXXX y G - PPP - T

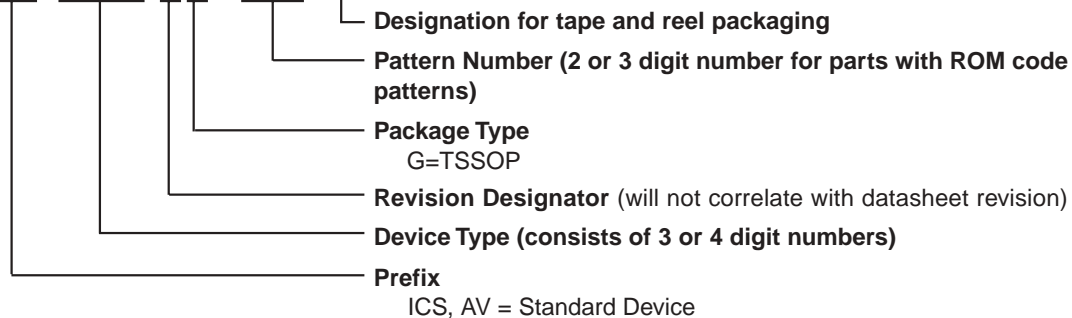

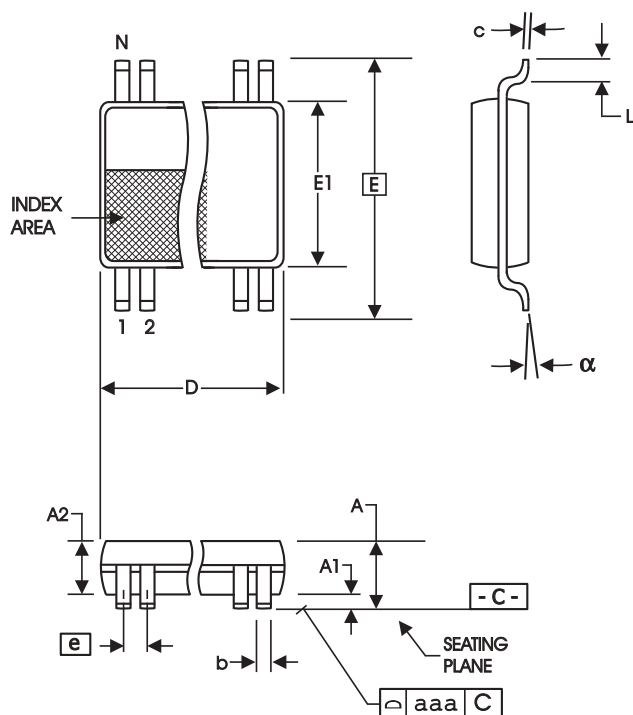

SYMBOL	In Millimeters		In Inches	
	COMMON DIMENSIONS MIN	COMMON DIMENSIONS MAX	COMMON DIMENSIONS MIN	COMMON DIMENSIONS MAX
A	--	1.20	--	.047
A1	0.05	0.15	.002	.006
A2	0.80	1.05	.032	.041
b	0.13	0.23	.005	.009
c	0.09	0.20	.0035	.008
D	SEE VARIATIONS		SEE VARIATIONS	
E	6.40 BASIC		0.252 BASIC	
E1	4.30	4.50	.169	.177
e	0.40 BASIC		0.016 BASIC	
L	0.45	0.75	.018	.030
N	SEE VARIATIONS		SEE VARIATIONS	
alpha	0°	8°	0°	8°
aaa	--	0.08	--	.003

VARIATIONS

N	D mm.		D (inch)	
	MIN	MAX	MIN	MAX
48	9.60	9.80	.378	.386

Reference Doc.: JEDEC Publication 95, M O-153
10-0037

4.40 mm. Body, 0.40 mm. pitch TSSOP
(173 mil) (16 mil)

Ordering Information

ICSSSTV16857CL-T

Example:

ICS XXXX y L - PPP - T

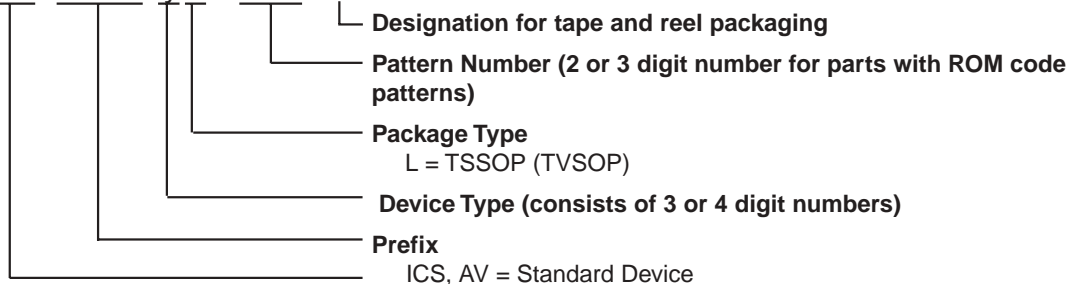

IMPORTANT NOTICE AND DISCLAIMER

RENESAS ELECTRONICS CORPORATION AND ITS SUBSIDIARIES (“RENESAS”) PROVIDES TECHNICAL SPECIFICATIONS AND RELIABILITY DATA (INCLUDING DATASHEETS), DESIGN RESOURCES (INCLUDING REFERENCE DESIGNS), APPLICATION OR OTHER DESIGN ADVICE, WEB TOOLS, SAFETY INFORMATION, AND OTHER RESOURCES “AS IS” AND WITH ALL FAULTS, AND DISCLAIMS ALL WARRANTIES, EXPRESS OR IMPLIED, INCLUDING, WITHOUT LIMITATION, ANY IMPLIED WARRANTIES OF MERCHANTABILITY, FITNESS FOR A PARTICULAR PURPOSE, OR NON-INFRINGEMENT OF THIRD-PARTY INTELLECTUAL PROPERTY RIGHTS.

These resources are intended for developers who are designing with Renesas products. You are solely responsible for (1) selecting the appropriate products for your application, (2) designing, validating, and testing your application, and (3) ensuring your application meets applicable standards, and any other safety, security, or other requirements. These resources are subject to change without notice. Renesas grants you permission to use these resources only to develop an application that uses Renesas products. Other reproduction or use of these resources is strictly prohibited. No license is granted to any other Renesas intellectual property or to any third-party intellectual property. Renesas disclaims responsibility for, and you will fully indemnify Renesas and its representatives against, any claims, damages, costs, losses, or liabilities arising from your use of these resources. Renesas' products are provided only subject to Renesas' Terms and Conditions of Sale or other applicable terms agreed to in writing. No use of any Renesas resources expands or otherwise alters any applicable warranties or warranty disclaimers for these products.

(Disclaimer Rev.1.01 Jan 2024)

Corporate Headquarters

TOYOSU FORESIA, 3-2-24 Toyosu,
Koto-ku, Tokyo 135-0061, Japan
www.renesas.com

Trademarks

Renesas and the Renesas logo are trademarks of Renesas Electronics Corporation. All trademarks and registered trademarks are the property of their respective owners.

Contact Information

For further information on a product, technology, the most up-to-date version of a document, or your nearest sales office, please visit www.renesas.com/contact-us/.