

### General Description

The SLG88103/4 is a wide voltage range, 375 nA Dual/Quad Channel CMOS Input Operational Amplifier capable of rail-to-rail input and output operation. Each Amplifier can be individually powered down.

### Features

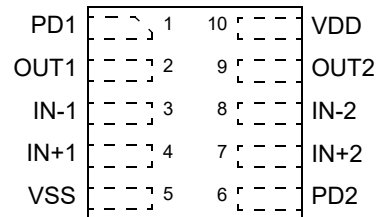
- Low Quiescent Current: 375 nA per Amplifier (typ)
- Low Offset Voltage:  $\pm 200 \mu\text{V}$  (typ)
- Zero-Crossover
- Low Offset Drift:  $1 \mu\text{V}/^\circ\text{C}$  (typ)
- DC Precision:
  - PSRR: 115 dB
  - CMRR: 100 dB
  - $A_{OL}$ : 120 dB
- Gain-Bandwidth Product: 10 kHz (typ)
- Rail to Rail Input/Output
- Supply Voltage: 1.71 V to 5.5 V
- Tiny Package:
  - 10-pin 2 x 2 mm STDFN
  - 20-pin 2 x 3.5 mm STQFN
- Industrial Temperature Range:  $-40^\circ\text{C}$  to  $85^\circ\text{C}$

### Typical Applications

- Battery-Powered Devices
- Portable Devices
- Wearable Products
- Gas Sensors
- Pressure Sensors
- Medical Monitors
- Smoke Detectors
- Active RFID Reader
- Energy Harvester

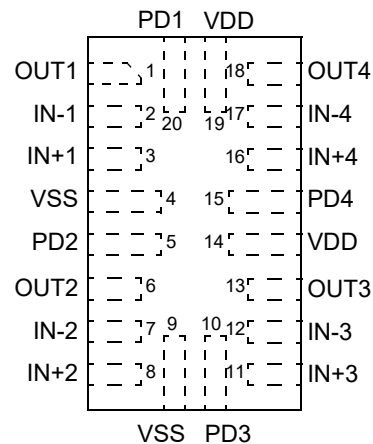
### Pin Configurations

#### SLG88103



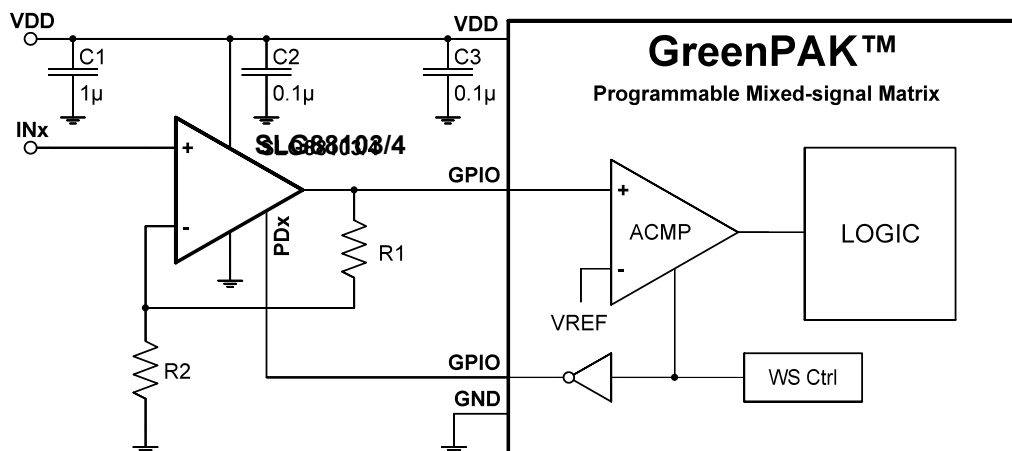
#### 10-pin STDFN (Top View)

#### SLG88104



#### 20-pin STQFN (Top View)

### Example Application Circuit: Non-Inverting Amplifier + GreenPAK with Wake-Sleep Controller



**Pin Description**

| Pin #        |              | Pin Name | Type | Pin Description   |
|--------------|--------------|----------|------|---|
| 20L<br>STQFN | 10L<br>STDFN |          |      |   |
| 1            | 2            | OUT1     | O    | Analog Output (Op Amp 1)  |
| 2            | 3            | IN-1     | I    | Inverting Input (Op Amp 1)  |
| 3            | 4            | IN+1     | I    | Non-inverting Input (Op Amp 1)  |
| 4            | 5            | VSS      | GND  | Negative Power Supply   |
| 5            | 6            | PD2      | I    | Power Down Input (Op Amp 2)<br>When PD pin is high, the respective amplifier is powered down. |
| 6            | 9            | OUT2     | O    | Analog Output (Op Amp 2)  |
| 7            | 8            | IN-2     | I    | Inverting Input (Op Amp 2)  |
| 8            | 7            | IN+2     | I    | Non-inverting Input (Op Amp 2)  |
| 9            | --           | VSS      | GND  | Negative Power Supply   |
| 10           | --           | PD3      | I    | Power Down Input (Op Amp 3)<br>When PD pin is high, the respective amplifier is powered down. |
| 11           | --           | IN+3     | I    | Non-inverting Input (Op Amp 3)  |
| 12           | --           | IN-3     | I    | Inverting Input (Op Amp 3)  |
| 13           | --           | OUT3     | O    | Analog Output (Op Amp 3)  |
| 14           | 10           | VDD      | PWR  | Power Supply  |
| 15           | --           | PD4      | I    | Power Down Input (Op Amp 4)<br>When PD pin is high, the respective amplifier is powered down. |
| 16           | --           | IN+4     | I    | Non-inverting Input (Op Amp 4)  |
| 17           | --           | IN-4     | I    | Inverting Input (Op Amp 4)  |
| 18           | --           | OUT4     | O    | Analog Output (Op Amp 4)  |
| 19           | --           | VDD      | PWR  | Power Supply  |
| 20           | 1            | PD1      | I    | Power Down Input (Op Amp 1)<br>When PD pin is high, the respective amplifier is powered down. |

**Ordering Information**

| Part Number | Type                         | Production Flow             |
|-------------|------------------------------|-----------------------------|
| SLG88103V   | 10-pin STDFN                 | Industrial, -40 °C to 85 °C |
| SLG88103VTR | 10-pin STDFN (Tape and Reel) | Industrial, -40 °C to 85 °C |
| SLG88104V   | 20-pin STQFN                 | Industrial, -40 °C to 85 °C |
| SLG88104VTR | 20-pin STQFN (Tape and Reel) | Industrial, -40 °C to 85 °C |

**Absolute Maximum Ratings**

| Parameter          | Description                           | Min. | Typ. | Max. | Unit |
|--------------------|---------------------------------------|------|------|------|------|
| V <sub>DD</sub>    | Voltage on VDD pin relative to GND    | -0.3 | --   | 6.0  | V    |
| T <sub>A</sub>     | Operating Range                       | -40  | --   | 85   | °C   |
| θ <sub>JA</sub>    | Thermal Resistance                    | --   | 80   | --   | °C/W |
| T <sub>S</sub>     | Storage Temperature                   | -65  | --   | 150  | °C   |
| T <sub>J</sub>     | Junction Temperature                  | --   | --   | 150  | °C   |
| ESD <sub>HBM</sub> | ESD Protection (Human Body Model)     | 2000 | --   | --   | V    |
| ESD <sub>CDM</sub> | ESD Protection (Charged Device Model) | 500  | --   | --   | V    |
| MSL                | Moisture Sensitivity Level            | 1    |      |      |      |

Note: Stresses greater than those listed under "Absolute Maximum Ratings" may cause permanent damage to the device. This is a stress rating only and functional operation of the device at these or any other conditions above those indicated in the operational sections of this specification is not implied. Exposure to absolute maximum rating conditions for extended periods may affect reliability.

**Electrical Characteristics**

T<sub>A</sub> = 25 °C, V<sub>DD</sub> = 1.71 V to 5.5 V, V<sub>SS</sub> = GND, V<sub>CM</sub> = V<sub>DD</sub>/2, V<sub>OUT</sub> = V<sub>DD</sub>/2, V<sub>L</sub> = V<sub>DD</sub>/2, R<sub>L</sub> = 1 MΩ to V<sub>L</sub>, unless otherwise stated.

| Symbol                                  | Description                     | Conditions  | Min             | Typ  | Max             | Unit  |
|---|---------------------------------|---|-----------------|------|-----------------|-------|
| <b>Input Offset</b>                     |                                 |   |                 |      |                 |       |
| V <sub>OS</sub>                         | Input Offset Voltage            | V <sub>CM</sub> = V <sub>DD</sub> /2  | -1000           | ±200 | 1000            | μV    |
|   |                                 | V <sub>CM</sub> = V <sub>DD</sub> /2;<br>T <sub>A</sub> = -40 °C to 85 °C   | -1100           | ±250 | 1100            | μV    |
|   |                                 | V <sub>CM</sub> = V <sub>SS</sub> ;<br>T <sub>A</sub> = -40 °C to 85 °C   | -2400           | ±350 | 2400            | μV    |
| dV <sub>OS</sub> /dT                    | Offset Drift with Temperature   | V <sub>CM</sub> = V <sub>DD</sub> /2;<br>T <sub>A</sub> = -40 °C to 85 °C   | -4              | ±1   | 4               | μV/°C |
|   |                                 | V <sub>CM</sub> = V <sub>SS</sub> ;<br>T <sub>A</sub> = -40 °C to 85 °C   | -10             | ±2   | 10              | μV/°C |
| dV <sub>OS</sub> /Time                  | 10 Year Offset Drift            | T <sub>A</sub> = 85 °C; V <sub>DD</sub> = 3.3 V   | -30             | --   | +30             | μV    |
|   |                                 | T <sub>A</sub> = 85 °C; V <sub>DD</sub> = 5.0 V   | -40             | --   | +40             | μV    |
| PSRR                                    | Power Supply Rejection Ratio    | V <sub>CM</sub> = V <sub>DD</sub> /2<br>T <sub>A</sub> = -40 °C to 85 °C  | 95              | 115  | --              | dB    |
|   |                                 | V <sub>CM</sub> = V <sub>SS</sub><br>T <sub>A</sub> = -40 °C to 85 °C   | 85              | 100  | --              | dB    |
| CS                                      | Channel Separation              | V <sub>DD</sub> = 5 V, f = 10 Hz  | --              | 120  | --              | dB    |
|   |                                 | V <sub>DD</sub> = 5 V, f = 1 kHz  | --              | 95   | --              | dB    |
| <b>Input Voltage Range</b>              |                                 |   |                 |      |                 |       |
| V <sub>CMR</sub>                        | Input Common-Mode Voltage Range | T <sub>A</sub> = -40 °C to 85 °C  | V <sub>SS</sub> | --   | V <sub>DD</sub> | V     |
| CMRR                                    | Common-Mode Rejection Ratio     | V <sub>SS</sub> + 0.8 V < V <sub>CM</sub> < V <sub>DD</sub> - 0.8 V,<br>T <sub>A</sub> = -40 °C to 85 °C  | 65              | 100  | --              | dB    |
|   |                                 | V <sub>SS</sub> < V <sub>CM</sub> < V <sub>SS</sub> + 0.8 V,<br>V <sub>DD</sub> - 0.8 V < V <sub>CM</sub> < V <sub>DD</sub> ,<br>T <sub>A</sub> = -40 °C to 85 °C | 50              | 75   | --              | dB    |
| <b>Input Bias Current and Impedance</b> |                                 |   |                 |      |                 |       |
| I <sub>B</sub>                          | Input Bias Current <sup>1</sup> |   | --              | 2    | --              | pA    |
|   |                                 | T <sub>A</sub> = 85 °C  | --              | 320  | 500             | pA    |

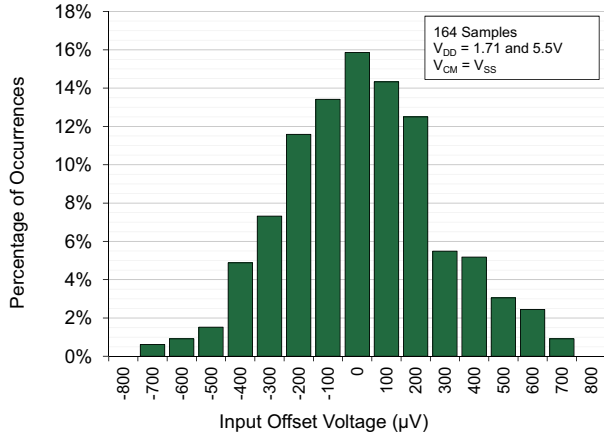
**Electrical Characteristics** (continued)

 $T_A = 25\text{ }^\circ\text{C}$ ,  $V_{DD} = 1.71\text{ V to }5.5\text{ V}$ ,  $V_{SS} = \text{GND}$ ,  $V_{CM} = V_{DD}/2$ ,  $V_{OUT} = V_{DD}/2$ ,  $V_L = V_{DD}/2$ ,  $R_L = 1\text{ M}\Omega$  to  $V_L$ , unless otherwise stated.

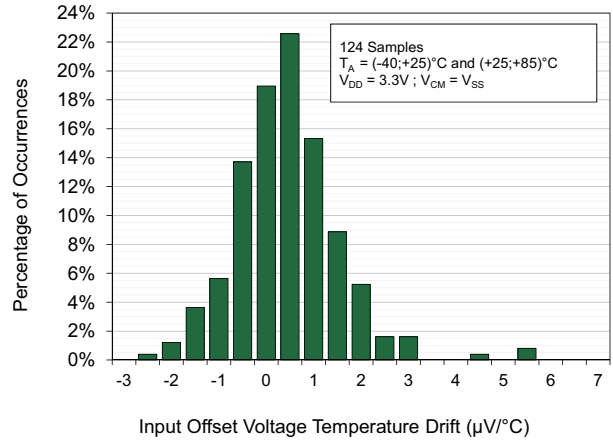
| Symbol  | Description                       | Conditions  | Min                            | Typ       | Max            | Unit                         |
|---|-----------------------------------|---|--------------------------------|-----------|----------------|------------------------------|
| $I_{OS}$  | Input Offset Current <sup>2</sup> |   | --                             | $\pm 0.3$ | --             | pA                           |
|   |                                   | $T_A = 85\text{ }^\circ\text{C}$  | --                             | $\pm 20$  | --             | pA                           |
| $R_{CM}$  | Common Mode Input Resistance      |   | --                             | $10^{13}$ | --             | $\Omega$                     |
| $R_{DIFF}$  | Differential Input Resistance     |   | --                             | $10^{13}$ | --             | $\Omega$                     |
| $C_{CM}$  | Input Capacitance Common-Mode     |   | --                             | 4.3       | --             | pF                           |
| $C_{DIFF}$  | Input Capacitance Differential    |   | --                             | 6         | --             | pF                           |
| <b>Open-Loop Gain</b>   |                                   |   |                                |           |                |                              |
| $A_{OL}$  | DC Open Loop Voltage Gain         | $R_L = 1\text{ M}\Omega$ ;<br>$V_{SS} + 0.1\text{ V} \leq V_{OUT} \leq V_{DD} - 0.1\text{ V}$                                     | 100                            | 120       | --             | dB                           |
|   |                                   | $R_L = 50\text{ k}\Omega$ ;<br>$V_{SS} + 0.5\text{ V} \leq V_{OUT} \leq V_{DD} - 0.5\text{ V}$                                    | 100                            | 120       | --             | dB                           |
|   |                                   | $R_L = 50\text{ k}\Omega$ ; $T_A = 85\text{ }^\circ\text{C}$ ;<br>$V_{SS} + 0.1\text{ V} \leq V_{OUT} \leq V_{DD} - 0.1\text{ V}$ | 80                             | 100       | --             | dB                           |
| <b>Output</b>   |                                   |   |                                |           |                |                              |
| $V_{OH}, V_{OL}$  | Maximum Voltage Swing             | $R_L = 50\text{ k}\Omega$   | $V_{SS} + 5$                   | --        | $V_{DD} - 5$   | mV                           |
| $V_{OSR}$   | Linear Output Swing Range         | $V_{OVR}$ from Rail   | $V_{SS} + 100$                 | --        | $V_{DD} - 100$ | mV                           |
| $I_{SC}$  | Short-circuit Current             | $V_{DD} = 1.71\text{ V}$  | 3.8                            | 4.5       | --             | mA                           |
|   |                                   | $V_{DD} = 3.0\text{ V to }5.5\text{ V}$   | 8.5                            | 10        | --             | mA                           |
| $C_{LOAD}$  | Capacitive Load Drive             |   | See Typical Performance Charts |           |                |                              |
| <b>Power Supply</b>   |                                   |   |                                |           |                |                              |
| $V_{DD}$  | Supply Voltage                    | Guaranteed by PSRR Test   | 1.71                           | --        | 5.5            | V                            |
| $I_Q$   | Quiescent Current (Per Amplifier) |   | --                             | 0.38      | 0.55           | $\mu\text{A}$                |
|   |                                   | $T_A = -40\text{ }^\circ\text{C to }85\text{ }^\circ\text{C}$   | --                             | 0.4       | 0.8            | $\mu\text{A}$                |
|   |                                   | $PDx = V_{DD}$  | --                             | 1         | --             | nA                           |
| <b>Frequency Response</b>   |                                   |   |                                |           |                |                              |
| GBW   | Gain Bandwidth Product            | $G = +1\text{ V/V}$   | --                             | 10        | --             | kHz                          |
| PM  | Phase Margin                      | $G = +1\text{ V/V}$   | --                             | 54        | --             | $^\circ$                     |
| SR  | Slew Rate                         | $R_L = 50\text{ k}\Omega$   | 2.4                            | 5.0       | --             | V/ms                         |
| $t_{OR}$  | Overload Recovery Time            | $T_A = -40\text{ }^\circ\text{C to }85\text{ }^\circ\text{C}$ ; $R_L = 50\text{ k}\Omega$   | --                             | 350       | --             | $\mu\text{s}$                |
| <b>Noise</b>  |                                   |   |                                |           |                |                              |
| $e_n$   | Input Voltage Noise               | $f = 0.1\text{ to }10\text{ Hz}$  | --                             | 6.5       | --             | $\mu\text{V}_{P-P}$          |
| $V_n$   | Input Voltage Noise Density       | $f = 1\text{ kHz}$  | --                             | 195       | --             | $\text{nV}/\sqrt{\text{Hz}}$ |
| $I_n$   | Input Current Noise Density       | $f = 1\text{ kHz}$  | --                             | < 10      | --             | $\text{fA}/\sqrt{\text{Hz}}$ |
| Note:   |                                   |   |                                |           |                |                              |
| 1. Part is measured to be less than 1 $\mu\text{A}$ during production test. |                                   |   |                                |           |                |                              |
| 2. Guaranteed by design, not tested in production.                          |                                   |   |                                |           |                |                              |

Typical Performance Charts

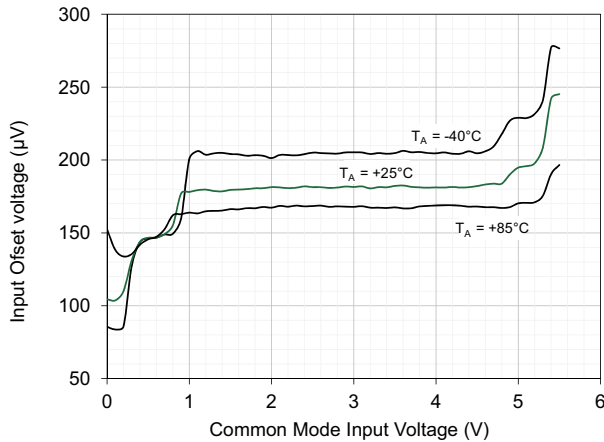
$T_A = 25^\circ\text{C}$ ,  $V_{DD} = 5.0\text{ V}$ ,  $V_{SS} = \text{GND}$ ,  $V_{CM} = V_{DD}/2$ ,  $V_{OUT} = V_{DD}/2$ ,  $V_L = V_{DD}/2$ ,  $R_L = 1\text{ M}\Omega$  to  $V_L$ ,  $C_L = 80\text{ pF}$ , unless otherwise stated.



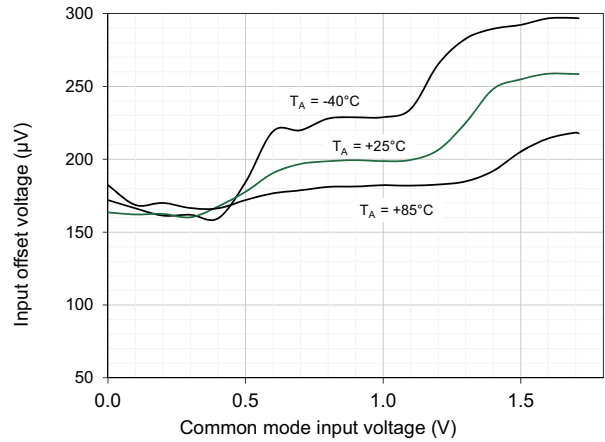
**Fig 1. Input Offset Voltage Drift Distribution**  
 $V_{CM} = V_{SS}$ ;  $V_{DD} = 1.71\text{ V}$  and  $5.5\text{ V}$ ;  $T_A = 25^\circ\text{C}$ .



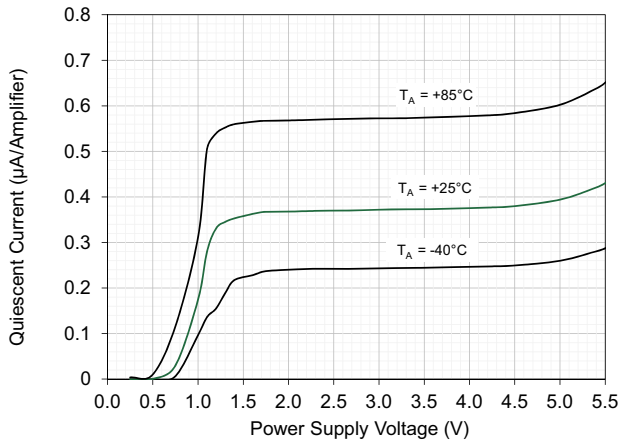
**Fig 4. Input Offset Voltage Temperature Drift Distribution**  
 $V_{CM} = V_{SS}$ ;  $V_{DD} = 3.3\text{ V}$ ;  $T_A = -40^\circ\text{C}$  to  $85^\circ\text{C}$ .



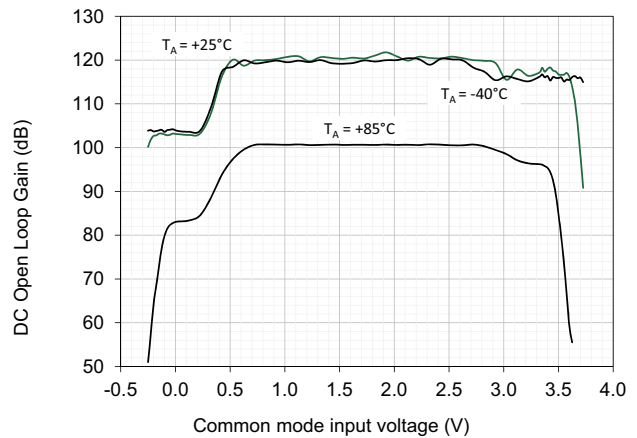
**Fig 2. Input Offset Voltage vs. Common Mode Input Voltage**  
 $V_{DD} = 5.5\text{ V}$ .



**Fig 5. Input Offset Voltage vs. Common Mode Input Voltage**  
 $V_{DD} = 1.71\text{ V}$ .

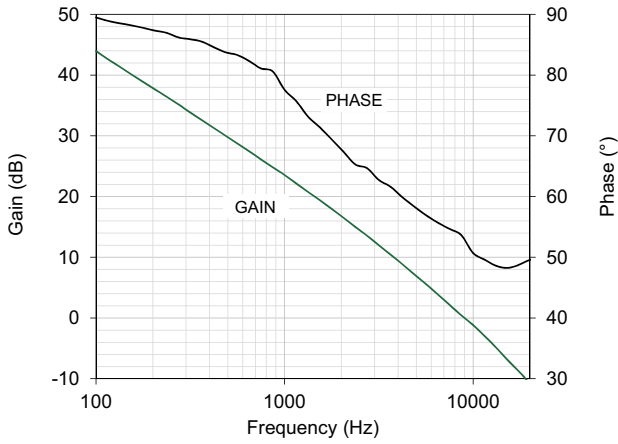


**Fig 3. Quiescent Current vs. Power Supply Voltage**

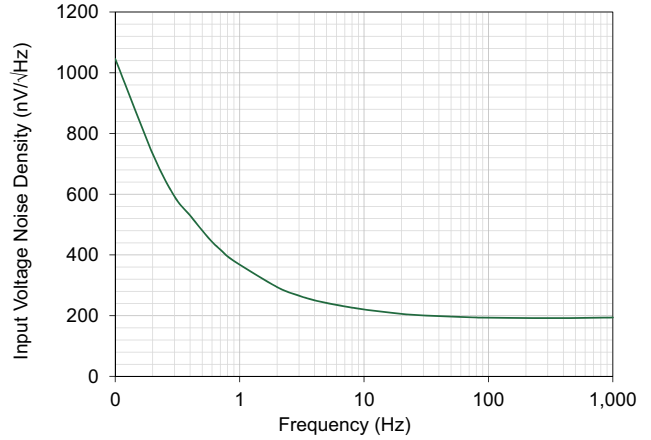


**Fig 6. DC Open Loop Gain vs. Common Mode Input Voltage**  
 $V_{DD} = 3.3\text{ V}$ .

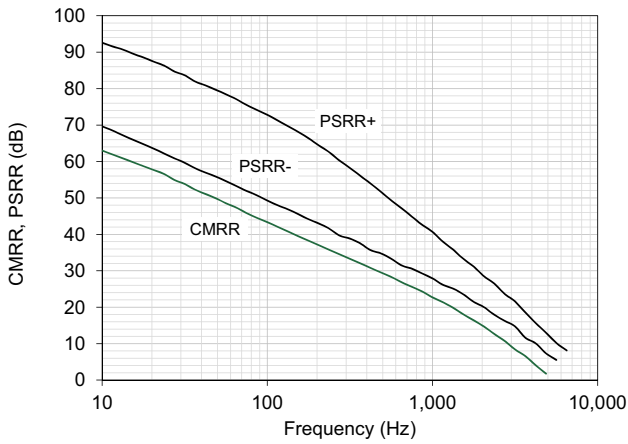
$T_A = 25\text{ }^\circ\text{C}$ ,  $V_{DD} = 5.0\text{ V}$ ,  $V_{SS} = \text{GND}$ ,  $V_{CM} = V_{DD}/2$ ,  $V_{OUT} = V_{DD}/2$ ,  $V_L = V_{DD}/2$ ,  $R_L = 1\text{ M}\Omega$  to  $V_L$ ,  $C_L = 80\text{ pF}$ , unless otherwise stated.



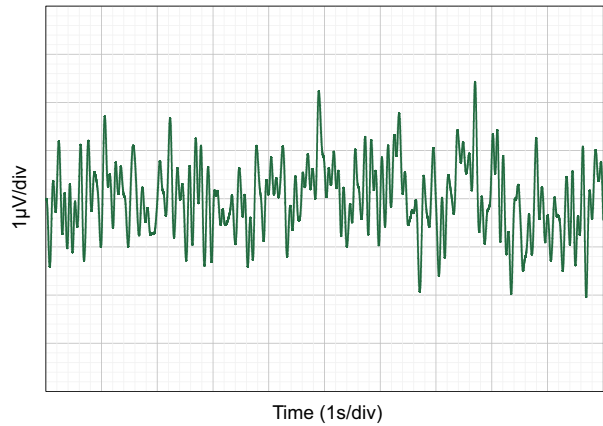
**Fig 7. Open Loop Gain and Phase vs. Frequency**  
 $V_{DD} = 3.3\text{ V}$ .



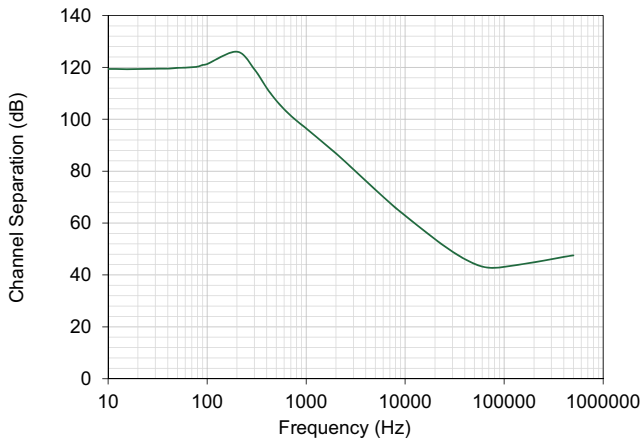
**Fig 10. Input Noise Voltage Density vs. Frequency**



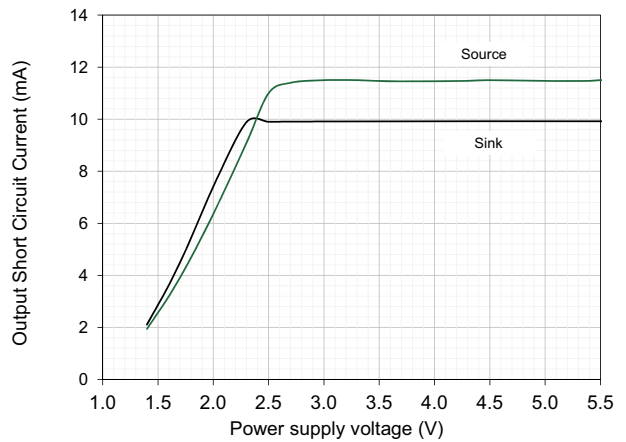
**Fig 8. CMRR, PSRR vs. Frequency**  
 $V_{DD} = 3.3\text{ V}$ .



**Fig 11. 0.1 Hz to 10 Hz Noise**

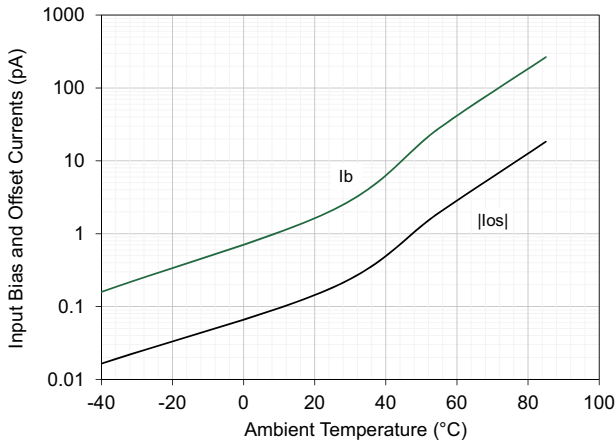


**Fig 9. Channel Separation vs. Frequency**

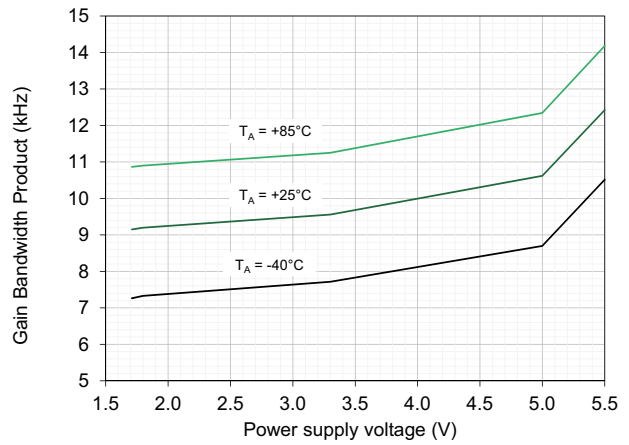


**Fig 12. Output Short Circuit Current vs.  $V_{DD}$**

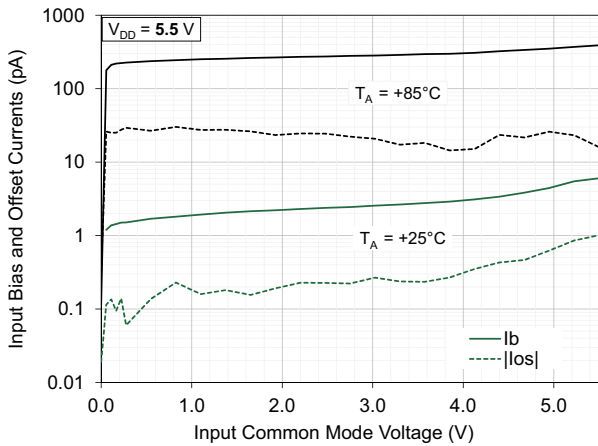
$T_A = 25\text{ }^\circ\text{C}$ ,  $V_{DD} = 5.0\text{ V}$ ,  $V_{SS} = \text{GND}$ ,  $V_{CM} = V_{DD}/2$ ,  $V_{OUT} = V_{DD}/2$ ,  $V_L = V_{DD}/2$ ,  $R_L = 1\text{ M}\Omega$  to  $V_L$ ,  $C_L = 80\text{ pF}$ , unless otherwise stated.



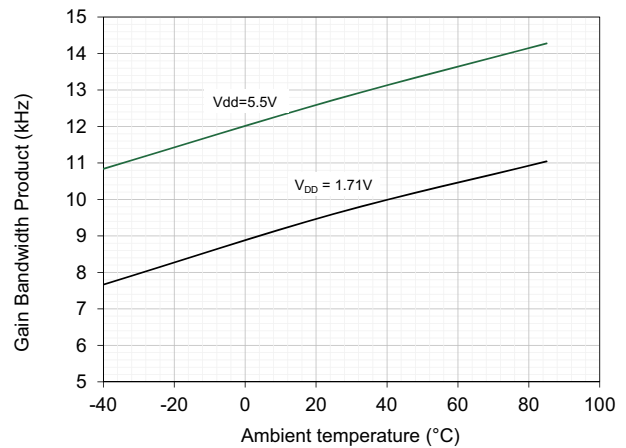
**Fig 13. Input Bias, Offset Currents vs.  $T_A$**   
 $V_{DD} = 3.3\text{ V}$ .



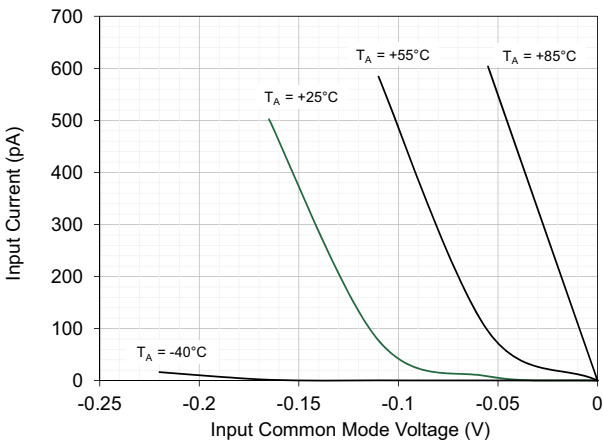
**Fig 16. Gain Bandwidth Product vs. Power Supply Voltage**



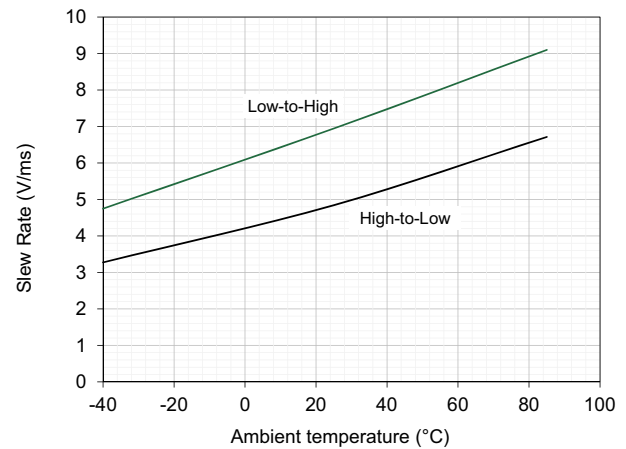
**Fig 14. Input Bias, Offset Currents vs.  $V_{CM}$**   
 $V_{DD} = 5.5\text{ V}$ .



**Fig 17. Gain Bandwidth Product vs. Ambient Temperature**

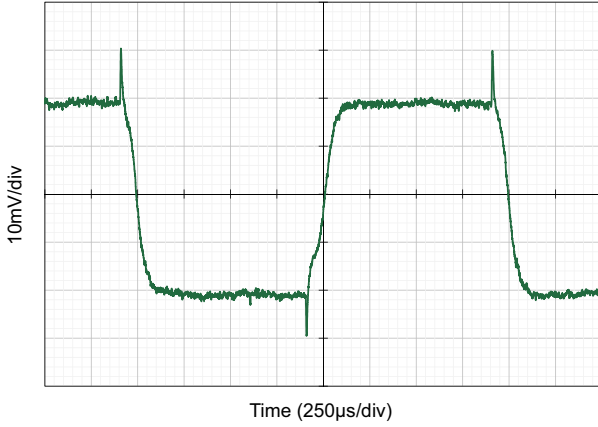


**Fig 15. Input Current vs.  $V_{CM}$  (below  $V_{SS}$ )**  
 $V_{DD} = 5.5\text{ V}$ .

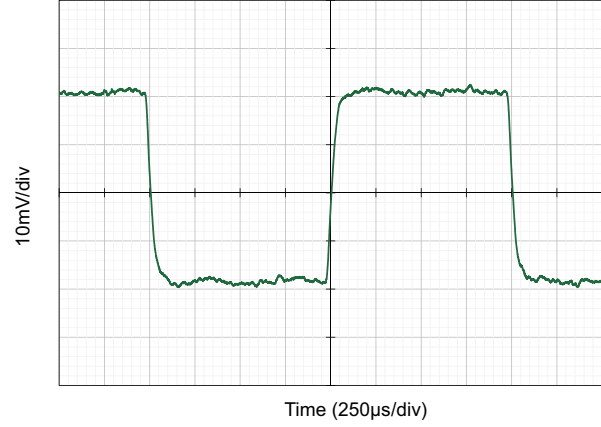


**Fig 18. Slew Rate vs. Ambient Temperature**  
 $G = 1\text{ V/V}$ ;  $R_L = 50\text{ k}\Omega$

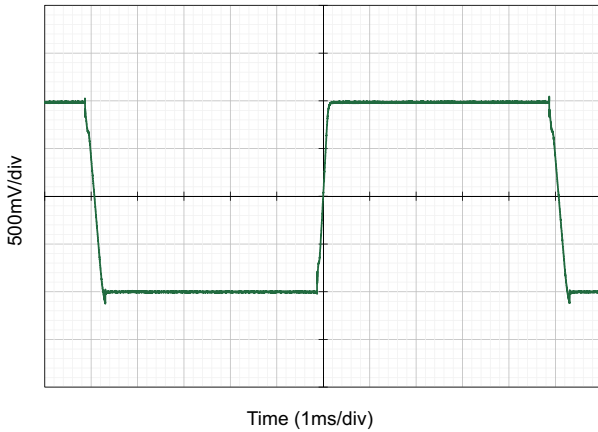
$T_A = 25\text{ }^\circ\text{C}$ ,  $V_{DD} = 5.0\text{ V}$ ,  $V_{SS} = \text{GND}$ ,  $V_{CM} = V_{DD}/2$ ,  $V_{OUT} = V_{DD}/2$ ,  $V_L = V_{DD}/2$ ,  $R_L = 1\text{ M}\Omega$  to  $V_L$ ,  $C_L = 80\text{ pF}$ , unless otherwise stated.



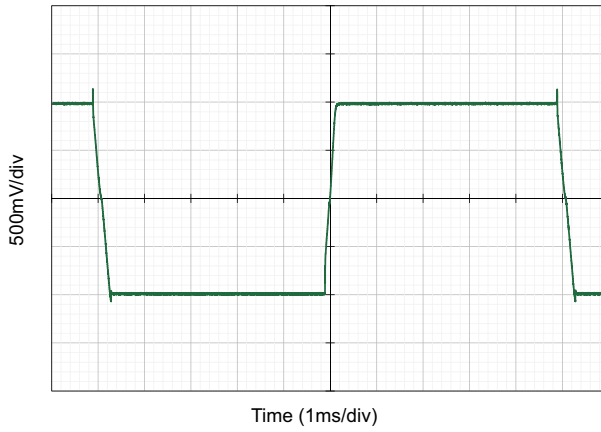
**Fig 19. Small Signal Inverting Step Response**  
 $G = -1\text{ V/V}$ ;  $R_L = 50\text{ k}\Omega$ ;  $C_L = 60\text{ pF}$ .



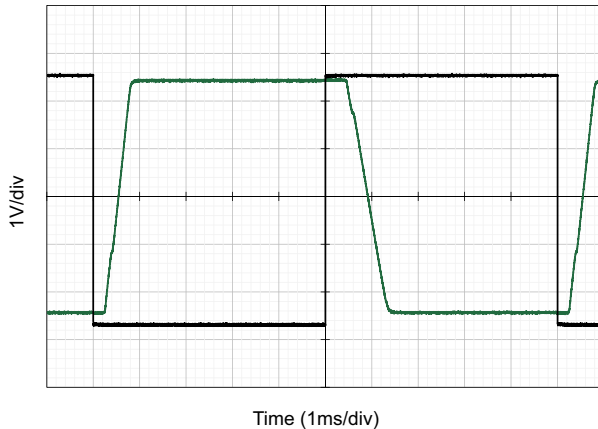
**Fig 22. Small Signal Non-inverting Step Response**  
 $G = 1\text{ V/V}$ ;  $R_L = 50\text{ k}\Omega$ ;  $C_L = 60\text{ pF}$ .



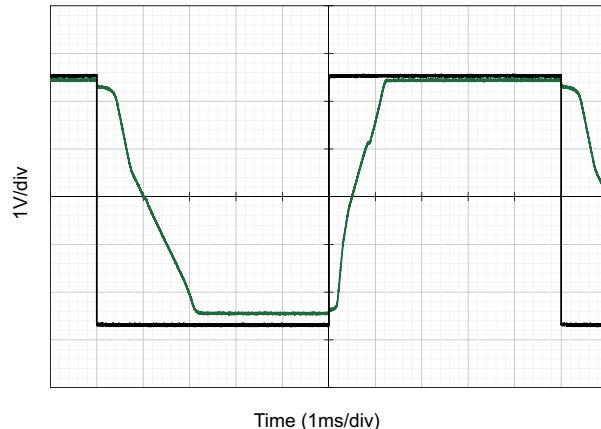
**Fig 20. Large Signal Inverting Step Response**  
 $G = -1\text{ V/V}$ ;  $R_L = 50\text{ k}\Omega$ ;  $C_L = 80\text{ pF}$ .



**Fig 23. Large Signal Non-inverting Step Response**  
 $G = 1\text{ V/V}$ ;  $R_L = 50\text{ k}\Omega$ ;  $C_L = 60\text{ pF}$ .



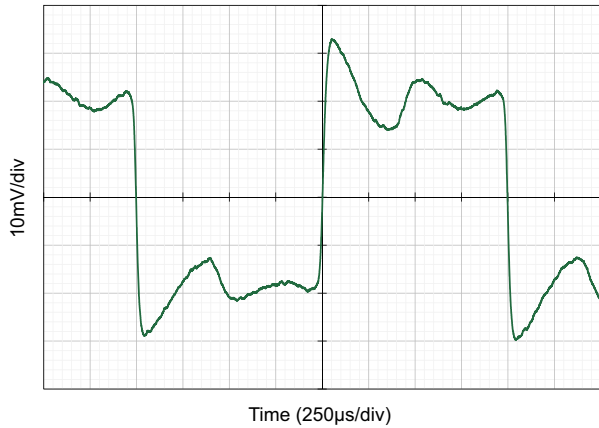
**Fig 21. Inverting Overload Recovery**  
 $G = -1\text{ V/V}$ ;  $R_L = 50\text{ k}\Omega$ ;  $C_L = 60\text{ pF}$ .



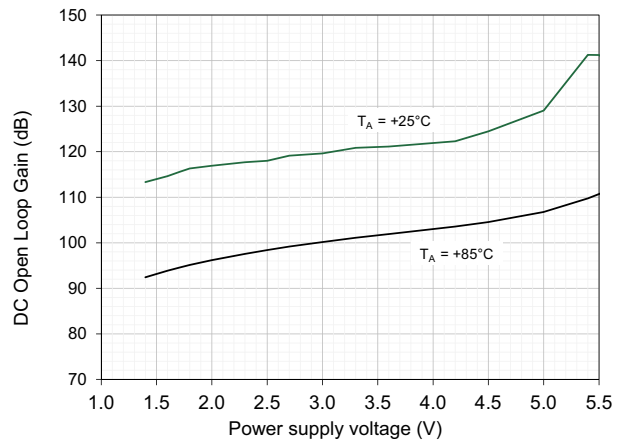
**Fig 24. Non-Inverting Overload Recovery**  
 $G = 1\text{ V/V}$ ;  $R_L = 50\text{ k}\Omega$ ;  $C_L = 60\text{ pF}$ .



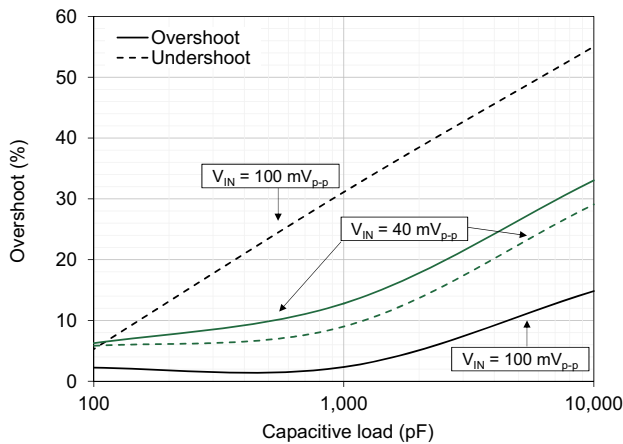
$T_A = 25^\circ\text{C}$ ,  $V_{DD} = 5.0\text{ V}$ ,  $V_{SS} = \text{GND}$ ,  $V_{CM} = V_{DD}/2$ ,  $V_{OUT} = V_{DD}/2$ ,  $V_L = V_{DD}/2$ ,  $R_L = 1\text{ M}\Omega$  to  $V_L$ ,  $C_L = 80\text{ pF}$ , unless otherwise stated.



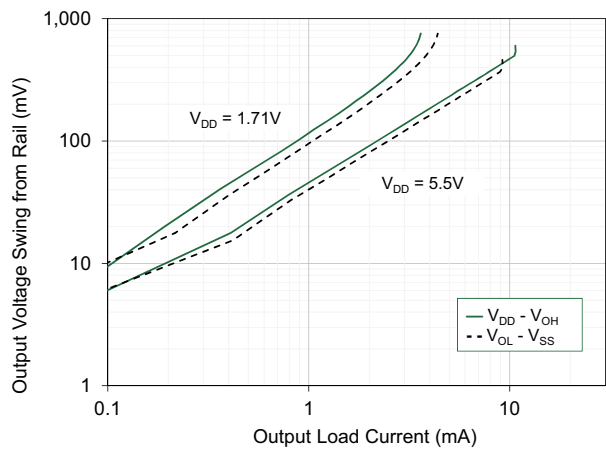
**Fig 25. Small Signal Non-inverting Step Response**  
 $G = 1\text{ V/V}$ ;  $R_L = 50\text{ k}\Omega$ ;  $C_L = 10\text{ nF}$ .



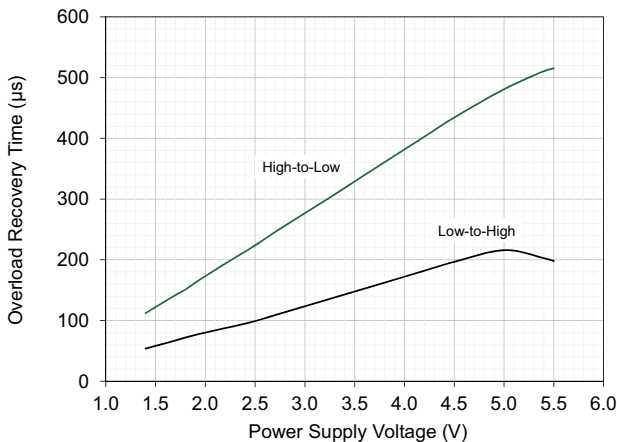
**Fig 28. DC Open Loop Gain vs. Power Supply Voltage**  
 $R_L = 50\text{ k}\Omega$



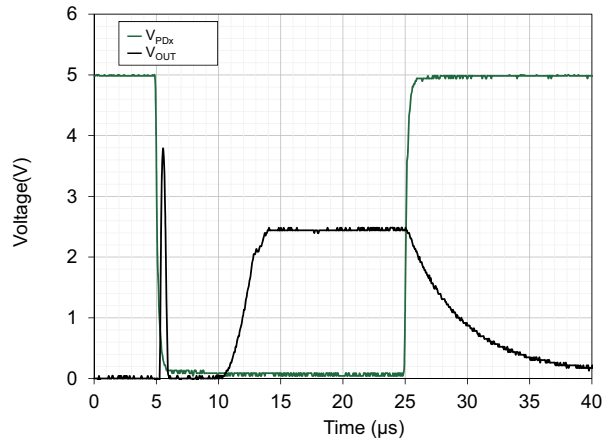
**Fig 26. Small Signal Overshoot vs. Capacitive Load**  
 $V_{DD} = 3.3\text{ V}$ ;  $V_{IN} = 40$  and  $100\text{ mV}_{p-p}$ ;  $G = 1\text{ V/V}$ .



**Fig 29. Output Voltage Swing from Rail vs.  $I_{OUT}$**   
 $V_{DD} = 1.71\text{ V}$  and  $5.5\text{ V}$ .



**Fig 27. Overload Recovery Time vs. Power Supply Voltage**  
 $R_L = 50\text{ k}\Omega$ ;  $G = 1\text{ V/V}$ .



**Fig 30. Output Response to Power Down Signal**  
 $G = 1\text{ V/V}$ ;  $R_L = 50\text{ k}\Omega$ ;  $C_L = 20\text{ pF}$ ;  $V_{IN} = V_S/2$ .

**Applications Information**

The SLG88103/4 operates on a 1.71 V to 5.5 V power supply over a wide industrial temperature range from -40 °C to 85 °C. This dual/quad op amp chip has two/four active low enable pins used to individually power-up / power-down each op amp. Its common-mode range extends from 0 to  $V_{DD}$  and its output swings from rail-to-rail.

**Input Protection**

Voltage spikes need to be controlled at the inputs of each operational amplifier in order to avoid damaging the device. Electrical events like electrostatic discharge can produce large voltages at these nodes. The SLG88103/4 has internal circuitry to protect the device from these events. If  $V_{IN}$  exceeds  $V_{DD}$  or drops below  $V_{SS}$ , additional currents will flow through the internal ESD diodes and can damage the device even if the supplies are turned off.

In this case we recommend placing a resistor in series to the input to limit current through the internal ESD diodes to 5 mA (or preferably less).

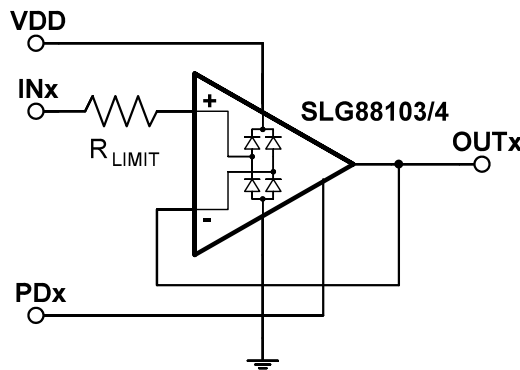


Fig 31. ESD Protection .

**Driving Capacitive Loads**

Capacitive loads degrade circuit stability by decreasing the phase margin and bandwidth of the operational amplifier circuit. The SLG88103/4 can drive capacitive loads up to 10 nF at low loads. The amplifier's output impedance and the capacitive load add phase lag to the system. This phase lag creates gain peaking in the frequency response and peaking/ringing in the output's transient response. When large capacitive loads need to be driven, isolation resistors need to be used to increase the phase margin. This is done by increasing the output load impedance at higher frequencies. After selecting an isolation resistor value, verify that the frequency peaking and transient overshoot and ringing have been reduced.

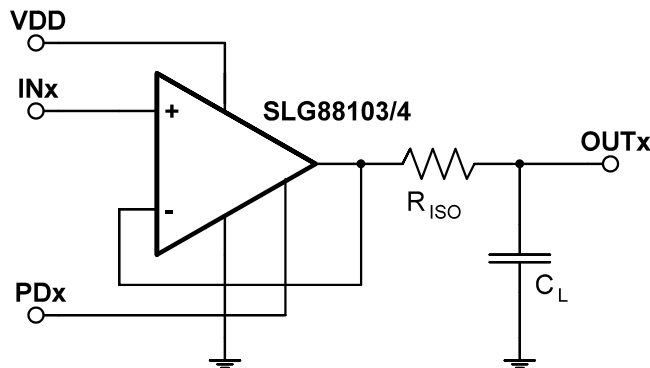


Fig 32. Capacitive Load Test Circuit.

**Low Power Considerations**

The SLG88103/4 features low quiescent current at 375 nA per amplifier, as well as extremely high-impedance CMOS inputs. To take most advantage of such low power features, high impedance external components should be used. We recommend using low-leakage capacitors (such as ceramic). Other types of capacitors (such as aluminum dielectric) can leak at uA levels and consume more quiescent power than the op-amp itself! High value resistors are needed to keep power consumption low, as well as to avoid gain loss and non-linearities due to loading effects on the ultra-low power-stage of the op amp. On the other hand, higher resistances increase thermal noise and sensitivity to external interference. We recommend impedances between 100 kΩ and 500 kΩ in gain/feedback networks to achieve balanced performance given the ultra-low power characteristics of SLG88103/4.

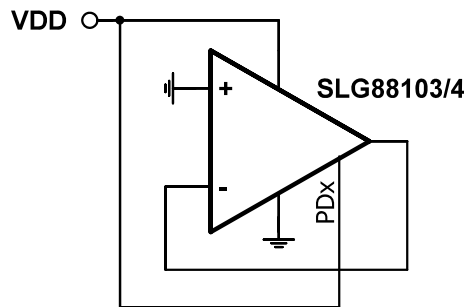
**PCB Layout**

For proper PCB layout, place a 100 nF decoupling capacitor close to the VDD pin of the SLG88103/4. To improve sensitive system performance, keep trace lengths similar on the positive and negative inputs of the op amp. Keep feedback resistors as close to the op amp and as short as possible. In addition, remove the PCB ground plane from under the inputs and outputs of the op amp.

For low current applications, board leakage currents on sensitive, high impedance inputs can degrade signal integrity. To maximize system performance, use guard rings / shields around these high impedance op amp inputs. For non-inverting op amps, IN+ should have a guard ring driven to the voltage of IN- by a low impedance source. Similarly, the guard ring around IN- should be driven to IN+ for an inverting amplifier. The IN- and IN+ nodes for non-inverting and inverting amplifiers respectively can be used as low impedance voltage sources. This is because these nodes are effectively low impedance nodes due to op amp feedback properties. For a non-inverting amplifier, leakage current on IN+ will produce a voltage on the input that will be amplified to the op amp's output. On the other hand, the op amp will fight changes in voltage on IN- to match the voltage potential at IN+. These guard rings should be used on both sides of the PCB to help sink stray currents on the PCB before the currents can reach the input pins of the op amp and to minimize stray capacitance.

**Proper Setup for Unused Op Amps**

For an unused op amp on the SLG88103/4, connect the op amp as a voltage follower with the input tied to ground and it's enable pin tied to VDD. An example circuit using one of the op amps is shown below.



**Fig 33. Unused Op Amp Setup.**

**Application Examples**

The SLG88103/4 excels in low-power applications that operate at low frequencies. Please see the “Application Notes” section of this datasheet for application examples which use the SLG88103/4.

**Design Resources**

**1. Spice Macro Model**

The most recent SPICE model is available on the Renesas website. This model is intended for simulation purposes only and shouldn't be used in place of hardware testing to verify proper functionality in a full system.

**2. Application Notes**

For more information on the topics discussed in this datasheet and applications of this device, please see the following applications notes available online at our Application Notes page. New Application Notes are added regularly.

AN-1106 Custom Instrumentation Amplifier Design

**3. Design Support**

Please contact a Renesas Representative at our Contact page for more information on the SLG88103/4. They will be happy to assist you by answering additional questions and by offering design support for projects relating to the SLG88103/4 and Renesas's GreenPAK devices.

**4. Op Amp + GreenPAK EVB**

The OP AMP+GreenPAK EVB provides convenient breakout access for various IC's in Renesas's Op Amp and GreenPAK product families. Please see the OP AMP+EVB Layout Guide for more information on which GreenPAK devices and op amps can be placed on this PCB.

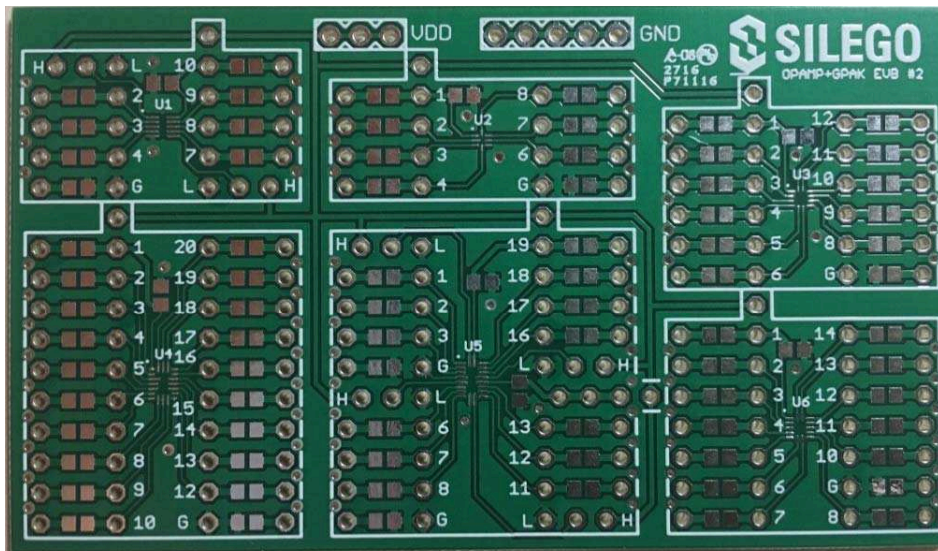
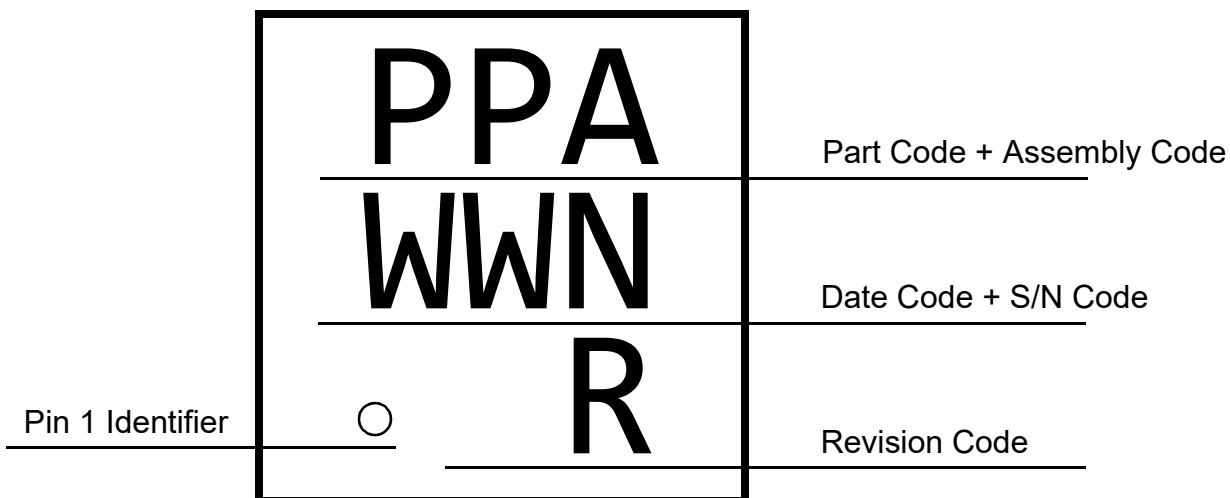


Fig 34. Op Amp + GreenPAK EVB.

Package Top Marking System Definition - SLG88103

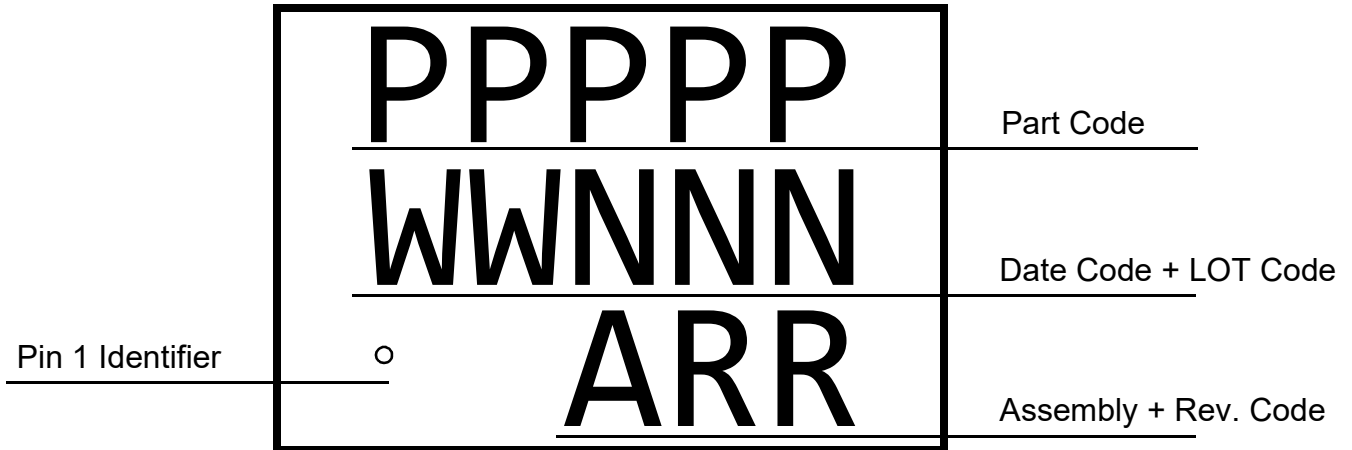


- PP - Part ID Field
- WW - Date Code Field<sup>1</sup>
- N - Lot Traceability Code Field<sup>1</sup>
- A - Assembly Site Code Field<sup>2</sup>
- R - Part Revision Code Field<sup>2</sup>

Note 1: Each character in code field can be alphanumeric A-Z and 0-9

Note 2: Character in code field can be alphabetic A-Z

Package Top Marking System Definition - SLG88104



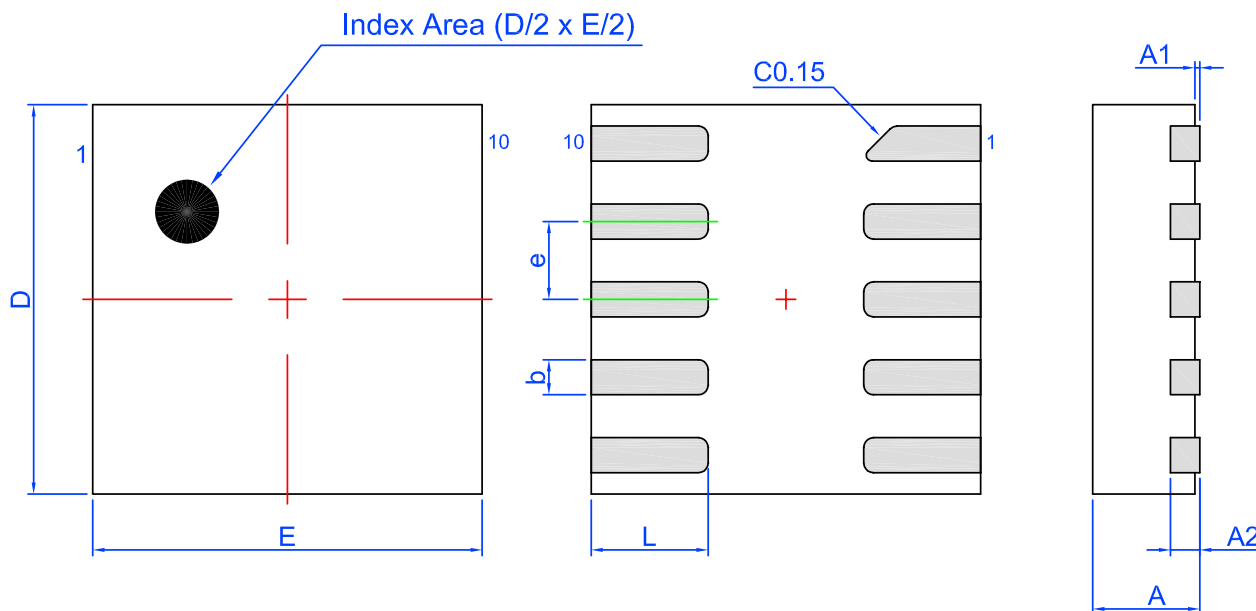
- PPPPP - Part ID Field
- WW - Date Code Field<sup>1</sup>
- NNN - Lot Traceability Code Field<sup>1</sup>
- A - Assembly Site Code Field<sup>2</sup>
- RR - Part Revision Code Field<sup>2</sup>

Note 1: Each character in code field can be alphanumeric A-Z and 0-9

Note 2: Character in code field can be alphabetic A-Z

Package Drawing and Dimensions - SLG88103

10 Lead STDFN Package  
JEDEC MO-252

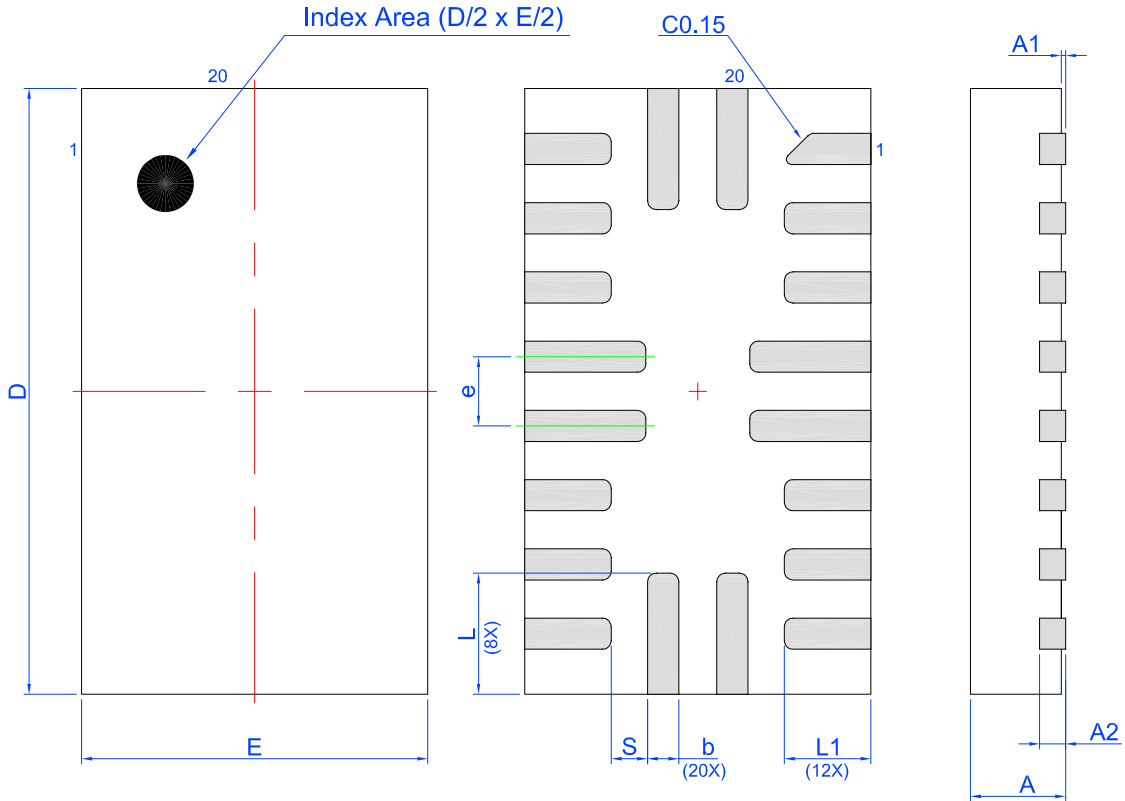


Unit: mm

| Symbol | Min      | Nom. | Max   | Symbol | Min      | Nom. | Max  |
|--------|----------|------|-------|--------|----------|------|------|
| A      | 0.50     | 0.55 | 0.60  | D      | 1.95     | 2.00 | 2.05 |
| A1     | 0.005    | -    | 0.050 | E      | 1.95     | 2.00 | 2.05 |
| A2     | 0.10     | 0.15 | 0.20  | L      | 0.55     | 0.60 | 0.65 |
| b      | 0.13     | 0.18 | 0.23  | C      | 0.15 REF |      |      |
| e      | 0.40 BSC |      |       |        |          |      |      |

Package Drawing and Dimensions - SLG88104

20 Lead STQFN Package

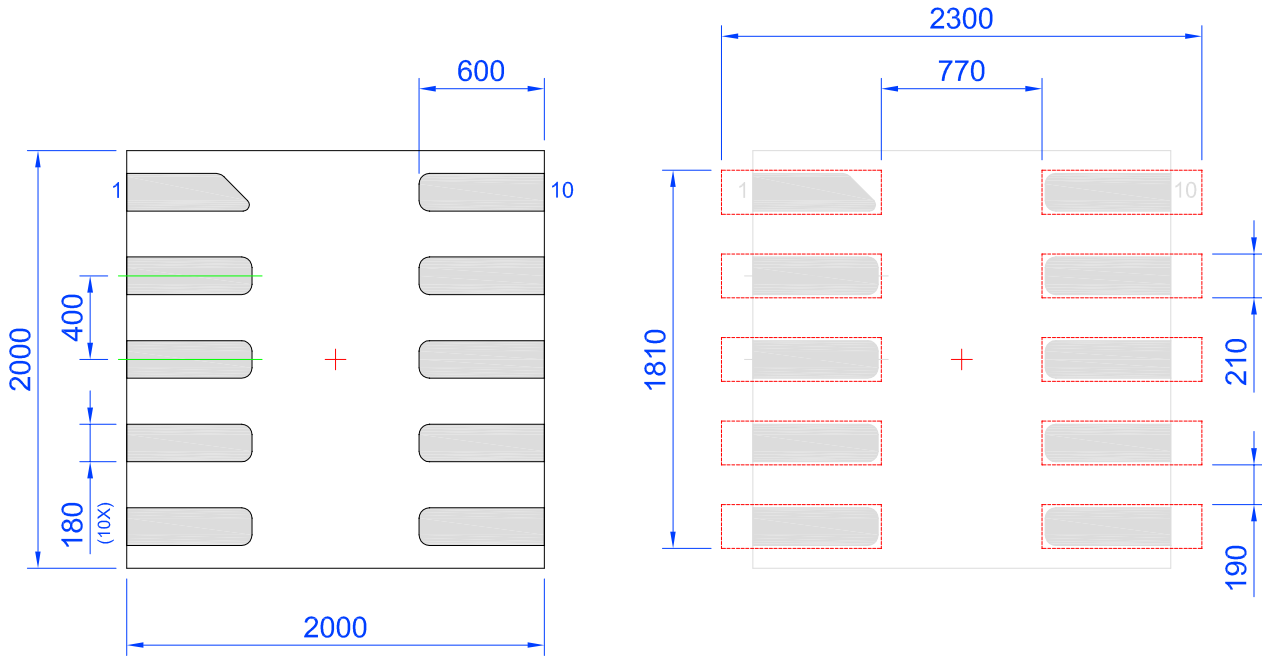


Unit: mm

| Symbol | Min      | Nom. | Max   | Symbol | Min      | Nom. | Max  |
|--------|----------|------|-------|--------|----------|------|------|
| A      | 0.50     | 0.55 | 0.60  | D      | 3.45     | 3.50 | 3.55 |
| A1     | 0.005    | -    | 0.050 | E      | 1.95     | 2.00 | 2.05 |
| A2     | 0.10     | 0.15 | 0.20  | L      | 0.65     | 0.70 | 0.75 |
| b      | 0.13     | 0.18 | 0.23  | L1     | 0.45     | 0.50 | 0.55 |
| e      | 0.40 BSC |      |       | C      | 0.15 REF |      |      |
| S      | 0.21 REF |      |       |        |          |      |      |



Recommended Land Pattern - SLG88103



Unit: um

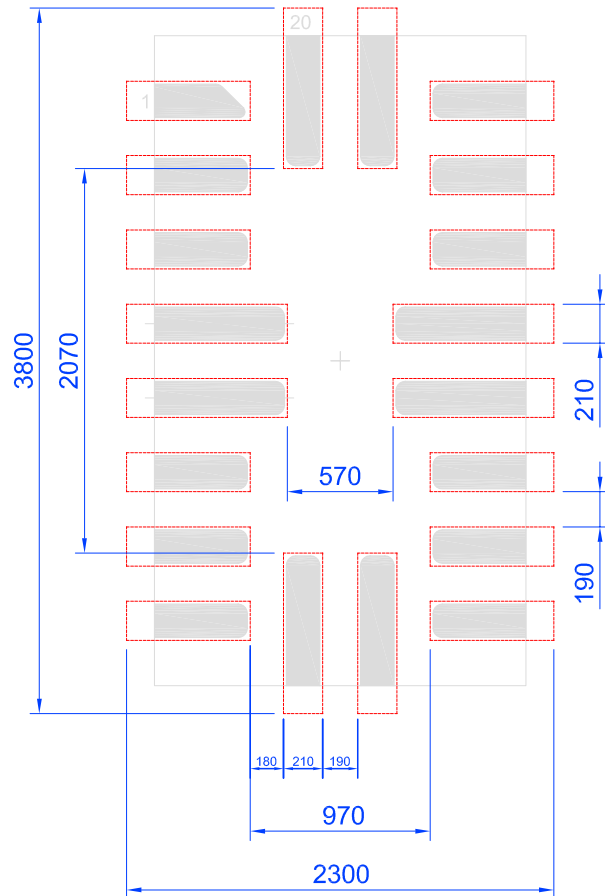
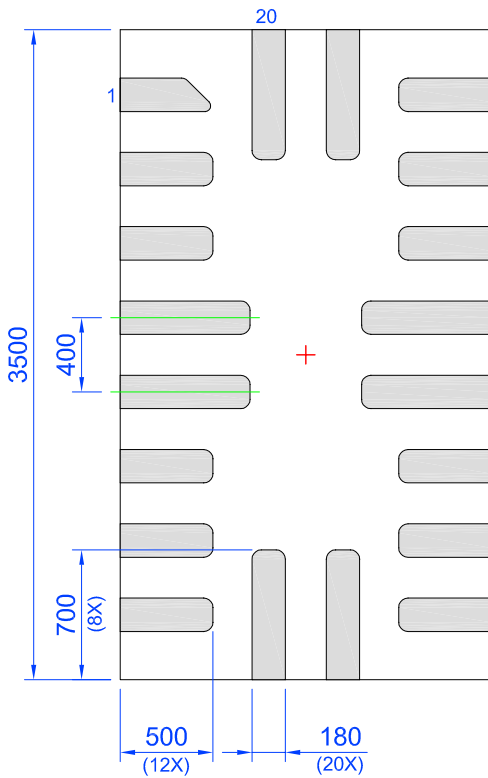
Recommended Reflow Soldering Profile

Please see IPC/JEDEC J-STD-020: latest revision for reflow profile based on package volume of 2.2 mm<sup>3</sup> (nominal). More information can be found at [www.jedec.org](http://www.jedec.org).

Recommended Land Pattern - SLG88104

Exposed Pad  
(PKG face down)

Recommended Land Pattern  
(PKG face down)



Unit: um

Recommended Reflow Soldering Profile

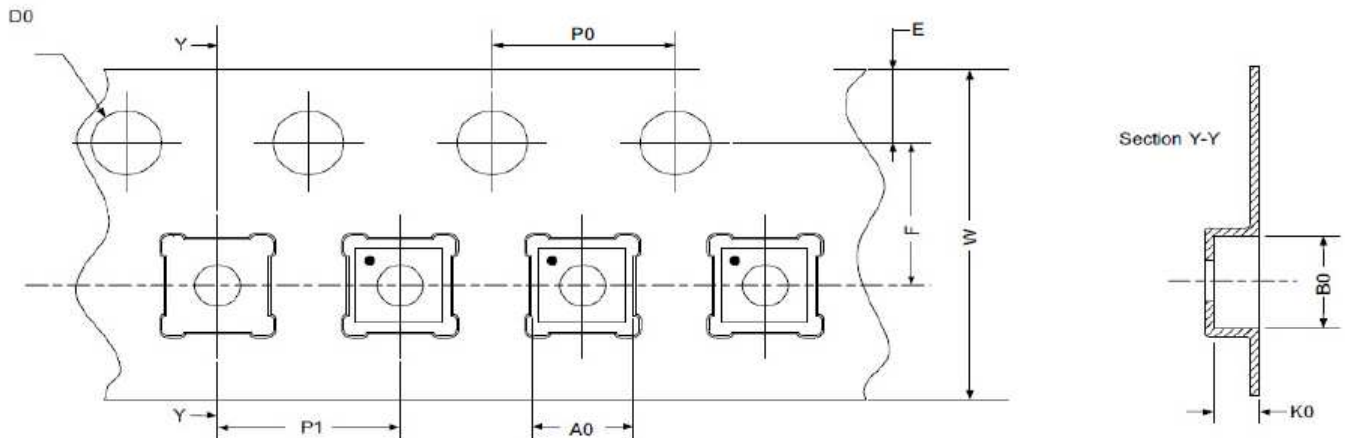
Please see IPC/JEDEC J-STD-020: latest revision for reflow profile based on package volume of 3.85 mm<sup>3</sup> (nominal). More information can be found at [www.jedec.org](http://www.jedec.org).

Tape and Reel Specifications

| Package Type                            | # of Pins | Nominal Package Size [mm] | Max Units |         | Reel & Hub Size [mm] | Leader (min) |             | Trailer (min) |             | Tape Width [mm] | Part Pitch [mm] |
|---|-----------|---------------------------|-----------|---------|----------------------|--------------|-------------|---------------|-------------|-----------------|-----------------|
|   |           |                           | per Reel  | per Box |                      | Pockets      | Length [mm] | Pockets       | Length [mm] |                 |                 |
| STDFN 10L<br>2x2mm<br>0.4P COL<br>Green | 10        | 2 x 2 x 0.55              | 3000      | 3000    | 178 / 60             | 100          | 400         | 100           | 400         | 8               | 4               |
| STQFN 20L<br>2x3.5mm<br>0.4P<br>Green   | 20        | 2 x 3.5 x 0.55            | 5000      | 10000   | 330 / 100            | 42           | 336         | 42            | 336         | 12              | 8               |

Carrier Tape Drawing and Dimensions - SLG88103

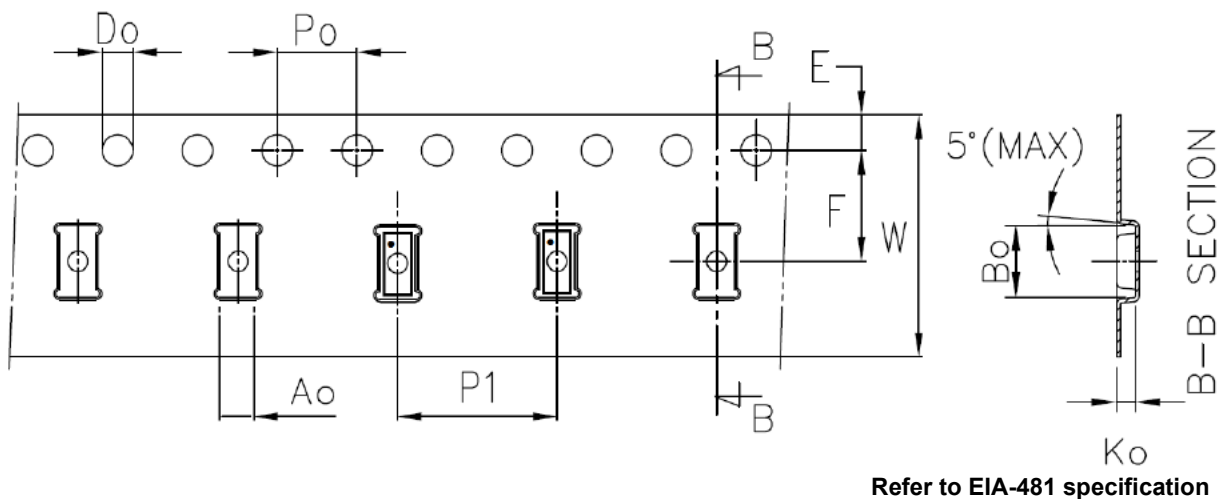
| Package Type                         | Pocket BTM Length | Pocket BTM Width | Pocket Depth | Index Hole Pitch | Pocket Pitch | Index Hole Diameter | Index Hole to Tape Edge | Index Hole to Pocket Center | Tape Width |
|--------------------------------------|-------------------|------------------|--------------|------------------|--------------|---------------------|-------------------------|-----------------------------|------------|
|                                      | A0                | B0               | K0           | P0               | P1           | D0                  | E                       | F                           | W          |
| STDFN 10L<br>2x2mm 0.4P<br>COL Green | 2.2               | 2.2              | 0.83         | 4                | 4            | 1.55                | 1.75                    | 3.5                         | 8          |



Refer to EIA-481 specification

Carrier Tape Drawing and Dimensions Dimensions - SLG88104

| Package Type                       | PocketBTM Length | PocketBTM Width | Pocket Depth | Index Hole Pitch | Pocket Pitch | Index Hole Diameter | Index Hole to Tape Edge | Index Hole to Pocket Center | Tape Width |
|------------------------------------|------------------|-----------------|--------------|------------------|--------------|---------------------|-------------------------|-----------------------------|------------|
|                                    | A0               | B0              | K0           | P0               | P1           | D0                  | E                       | F                           | W          |
| STQFN 20L<br>2x3.5mm<br>0.4P Green | 2.2              | 3.8             | 0.8          | 4                | 8            | 1.5                 | 1.75                    | 5.5                         | 12         |



**Revision History**

| Date      | Version | Change   |
|-----------|---------|--|
| 2/17/2022 | 1.03    | Renesas rebranding<br>Fixed typos  |
| 4/25/2017 | 1.02    | Replaced Input Current vs. $V_{CM}$ Chart  |
| 3/13/2017 | 1.01    | Replaced Slew Rate vs. Ambient Temperature Chart<br>Fixed Chart formatting for some charts.<br>Fixed typos |
| 3/1/2017  | 1.00    | Production Release   |

## IMPORTANT NOTICE AND DISCLAIMER

RENESAS ELECTRONICS CORPORATION AND ITS SUBSIDIARIES (“RENESAS”) PROVIDES TECHNICAL SPECIFICATIONS AND RELIABILITY DATA (INCLUDING DATASHEETS), DESIGN RESOURCES (INCLUDING REFERENCE DESIGNS), APPLICATION OR OTHER DESIGN ADVICE, WEB TOOLS, SAFETY INFORMATION, AND OTHER RESOURCES “AS IS” AND WITH ALL FAULTS, AND DISCLAIMS ALL WARRANTIES, EXPRESS OR IMPLIED, INCLUDING, WITHOUT LIMITATION, ANY IMPLIED WARRANTIES OF MERCHANTABILITY, FITNESS FOR A PARTICULAR PURPOSE, OR NON-INFRINGEMENT OF THIRD-PARTY INTELLECTUAL PROPERTY RIGHTS.

These resources are intended for developers who are designing with Renesas products. You are solely responsible for (1) selecting the appropriate products for your application, (2) designing, validating, and testing your application, and (3) ensuring your application meets applicable standards, and any other safety, security, or other requirements. These resources are subject to change without notice. Renesas grants you permission to use these resources only to develop an application that uses Renesas products. Other reproduction or use of these resources is strictly prohibited. No license is granted to any other Renesas intellectual property or to any third-party intellectual property. Renesas disclaims responsibility for, and you will fully indemnify Renesas and its representatives against, any claims, damages, costs, losses, or liabilities arising from your use of these resources. Renesas' products are provided only subject to Renesas' Terms and Conditions of Sale or other applicable terms agreed to in writing. No use of any Renesas resources expands or otherwise alters any applicable warranties or warranty disclaimers for these products.

(Disclaimer Rev.1.01)

### Corporate Headquarters

TOYOSU FORESIA, 3-2-24 Toyosu,  
Koto-ku, Tokyo 135-0061, Japan  
[www.renesas.com](http://www.renesas.com)

### Trademarks

Renesas and the Renesas logo are trademarks of Renesas Electronics Corporation. All trademarks and registered trademarks are the property of their respective owners.

### Contact Information

For further information on a product, technology, the most up-to-date version of a document, or your nearest sales office, please visit [www.renesas.com/contact-us/](http://www.renesas.com/contact-us/).