

To our customers,

Old Company Name in Catalogs and Other Documents

On April 1st, 2010, NEC Electronics Corporation merged with Renesas Technology Corporation, and Renesas Electronics Corporation took over all the business of both companies. Therefore, although the old company name remains in this document, it is a valid Renesas Electronics document. We appreciate your understanding.

Renesas Electronics website: <http://www.renesas.com>

April 1st, 2010
Renesas Electronics Corporation

Issued by: Renesas Electronics Corporation (<http://www.renesas.com>)

Send any inquiries to <http://www.renesas.com/inquiry>.

Not recommended
for new design

Notice

1. All information included in this document is current as of the date this document is issued. Such information, however, is subject to change without any prior notice. Before purchasing or using any Renesas Electronics products listed herein, please confirm the latest product information with a Renesas Electronics sales office. Also, please pay regular and careful attention to additional and different information to be disclosed by Renesas Electronics such as that disclosed through our website.
2. Renesas Electronics does not assume any liability for infringement of patents, copyrights, or other intellectual property rights of third parties by or arising from the use of Renesas Electronics products or technical information described in this document. No license, express, implied or otherwise, is granted hereby under any patents, copyrights or other intellectual property rights of Renesas Electronics or others.
3. You should not alter, modify, copy, or otherwise misappropriate any Renesas Electronics product, whether in whole or in part.
4. Descriptions of circuits, software and other related information in this document are provided only to illustrate the operation of semiconductor products and application examples. You are fully responsible for the incorporation of these circuits, software, and information in the design of your equipment. Renesas Electronics assumes no responsibility for any losses incurred by you or third parties arising from the use of these circuits, software, or information.
5. When exporting the products or technology described in this document, you should comply with the applicable export control laws and regulations and follow the procedures required by such laws and regulations. You should not use Renesas Electronics products or the technology described in this document for any purpose relating to military applications or use by the military, including but not limited to the development of weapons of mass destruction. Renesas Electronics products and technology may not be used for or incorporated into any products or systems whose manufacture, use, or sale is prohibited under any applicable domestic or foreign laws or regulations.
6. Renesas Electronics has used reasonable care in preparing the information included in this document, but Renesas Electronics does not warrant that such information is error free. Renesas Electronics assumes no liability whatsoever for any damages incurred by you resulting from errors in or omissions from the information included herein.
7. Renesas Electronics products are classified according to the following three quality grades: "Standard", "High Quality", and "Specific". The recommended applications for each Renesas Electronics product depends on the product's quality grade, as indicated below. You must check the quality grade of each Renesas Electronics product before using it in a particular application. You may not use any Renesas Electronics product for any application categorized as "Specific" without the prior written consent of Renesas Electronics. Further, you may not use any Renesas Electronics product for any application for which it is not intended without the prior written consent of Renesas Electronics. Renesas Electronics shall not be in any way liable for any damages or losses incurred by you or third parties arising from the use of any Renesas Electronics product for an application categorized as "Specific" or for which the product is not intended where you have failed to obtain the prior written consent of Renesas Electronics. The quality grade of each Renesas Electronics product is "Standard" unless otherwise expressly specified in a Renesas Electronics data sheets or data books, etc.
 - "Standard": Computers; office equipment; communications equipment; test and measurement equipment; audio and visual equipment; home electronic appliances; machine tools; personal electronic equipment; and industrial robots.
 - "High Quality": Transportation equipment (automobiles, trains, ships, etc.); traffic control systems; anti-disaster systems; anti-crime systems; safety equipment; and medical equipment not specifically designed for life support.
 - "Specific": Aircraft; aerospace equipment; submersible repeaters; nuclear reactor control systems; medical equipment or systems for life support (e.g. artificial life support devices or systems), surgical implantations, or healthcare intervention (e.g. excision, etc.), and any other applications or purposes that pose a direct threat to human life.
8. You should use the Renesas Electronics products described in this document within the range specified by Renesas Electronics, especially with respect to the maximum rating, operating supply voltage range, movement power voltage range, heat radiation characteristics, installation and other product characteristics. Renesas Electronics shall have no liability for malfunctions or damages arising out of the use of Renesas Electronics products beyond such specified ranges.
9. Although Renesas Electronics endeavors to improve the quality and reliability of its products, semiconductor products have specific characteristics such as the occurrence of failure at a certain rate and malfunctions under certain use conditions. Further, Renesas Electronics products are not subject to radiation resistance design. Please be sure to implement safety measures to guard them against the possibility of physical injury, and injury or damage caused by fire in the event of the failure of a Renesas Electronics product, such as safety design for hardware and software including but not limited to redundancy, fire control and malfunction prevention, appropriate treatment for aging degradation or any other appropriate measures. Because the evaluation of microcomputer software alone is very difficult, please evaluate the safety of the final products or system manufactured by you.
10. Please contact a Renesas Electronics sales office for details as to environmental matters such as the environmental compatibility of each Renesas Electronics product. Please use Renesas Electronics products in compliance with all applicable laws and regulations that regulate the inclusion or use of controlled substances, including without limitation, the EU RoHS Directive. Renesas Electronics assumes no liability for damages or losses occurring as a result of your noncompliance with applicable laws and regulations.
11. This document may not be reproduced or duplicated, in any form, in whole or in part, without prior written consent of Renesas Electronics.
12. Please contact a Renesas Electronics sales office if you have any questions regarding the information contained in this document or Renesas Electronics products, or if you have any other inquiries.

(Note 1) "Renesas Electronics" as used in this document means Renesas Electronics Corporation and also includes its majority-owned subsidiaries.

(Note 2) "Renesas Electronics product(s)" means any product developed or manufactured by or for Renesas Electronics.

RQG2001URAQF

NPN Silicon Germanium Transistor
High Frequency Medium Power Amplifier

REJ03G1554-0100

Rev.1.00

Aug 10, 2007

Features

- Ideal for 2 GHz Band applications. e.g 2.4 GHz WLAN, Digital cordless phone.
- Low Distortion and Excellent Linearity
IP3 at output = +30 dBm typ., P1dB at output = +19 dBm typ., f = 1.8 GHz
- High Transition Frequency
 $f_T = 20$ GHz typ.
- High Collector to Emitter Voltage
 $V_{CEO} = 5$ V

Outline

RENESAS Package code: PTSP0004ZA-A
(Package name: CMPAK-4)

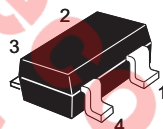

1. Emitter
2. Collector
3. Emitter
4. Base

Note: Marking is "UR-".

Absolute Maximum Ratings

($T_a = 25^\circ\text{C}$)

Item	Symbol	Ratings	Unit
Collector to base voltage	V_{CBO}	13	V
Collector to emitter voltage	V_{CEO}	5	V
Emitter to base voltage	V_{EBO}	1.5	V
Collector current	I_C	100	mA
Collector power dissipation	P_C	450 ^{note1}	mW
Junction temperature	T_j	150	$^\circ\text{C}$
Storage temperature	T_{stg}	-55 to +150	$^\circ\text{C}$

Notes: 1. Value on PCB (FR-4 : 20 x 20 x 1.0 mm double side)

Electrical Characteristics

(Ta = 25°C)

Item	Symbol	Min.	Typ	Max.	Unit	Test Conditions
DC current transfer ratio	h_{FE}	100	150	200	—	$V_{CE} = 2\text{ V}$, $I_C = 50\text{ mA}$
Collector output capacitance	C_{ob}	—	0.95	1.2	pF	$V_{CB} = 2\text{ V}$, $I_E = 0$, $f = 1\text{ MHz}$
Reverse Transfer Capacitance	C_{re}	—	0.5	—	pF	$V_{CB} = 2\text{ V}$, $I_E = 0$, $f = 1\text{ MHz}$, emitter grounded
Transition Frequency	f_T	—	21	—	GHz	$V_{CE} = 3\text{ V}$, $I_C = 60\text{ mA}$, $f = 1\text{ GHz}$
		—	18	—		$V_{CE} = 3\text{ V}$, $I_C = 40\text{ mA}$, $f = 1\text{ GHz}$
Maximum Available Gain	MAG	—	15	—	dB	$V_{CE} = 3\text{ V}$, $I_C = 40\text{ mA}$, $f = 1.8\text{ GHz}$
Power Gain	PG	—	12	—	dB	$V_{CE} = 3\text{ V}$, $I_{Cq} = 40\text{ mA}$, $f = 1.8\text{ GHz}$, $P_{in} = +7\text{ dBm}$
Noise Figure	1.8 GHz	NF	—	0.9	dB	$V_{CE} = 3\text{ V}$, $I_C = 10\text{ mA}$
	2.4 GHz		—	1.1		
1dB Compression Point at output	1.8 GHz	P1dB	—	+19	dBm	$V_{CE} = 3\text{ V}$, $I_{Cq} = 40\text{ mA}$
	2.4 GHz		—	+20		$V_{CE} = 3.6\text{ V}$, $I_{Cq} = 40\text{ mA}$
Third Order Intercept Point at output	1.8 GHz	OIP3	—	+30	dBm	$V_{CE} = 3\text{ V}$, $I_{Cq} = 40\text{ mA}$, $\Delta f = 1\text{ MHz}$
	2.4 GHz		—	+31		$V_{CE} = 3.6\text{ V}$, $I_{Cq} = 40\text{ mA}$, $\Delta f = 1\text{ MHz}$
Saturation Output Power	1.8 GHz	$P_{o(sat)}$	—	+23	dBm	$V_{CE} = 3\text{ V}$, $I_{Cq} = 40\text{ mA}$, $P_{in} = +18\text{ dBm}$
	2.4 GHz		—	+23		$V_{CE} = 3.6\text{ V}$, $I_{Cq} = 40\text{ mA}$, $P_{in} = +18\text{ dBm}$

Main Characteristics

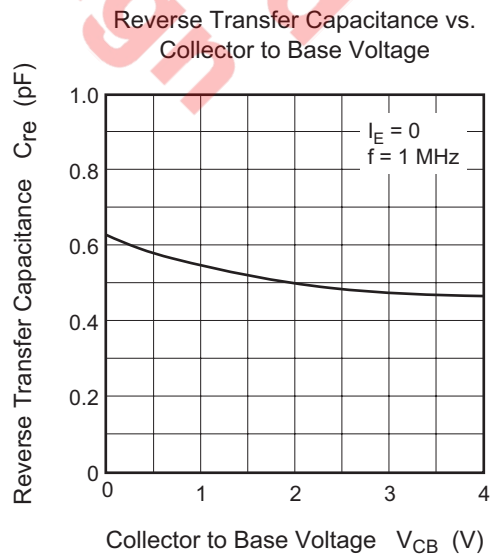
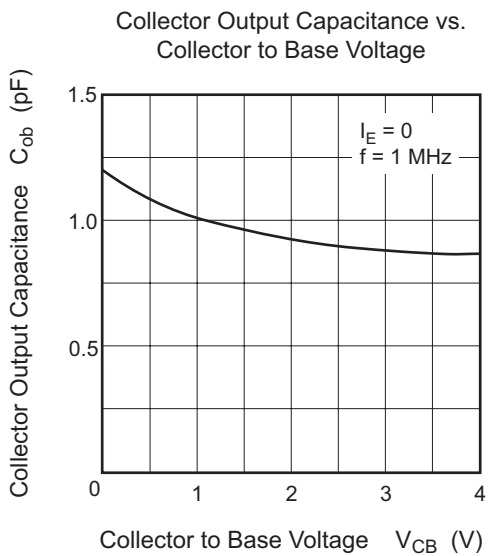
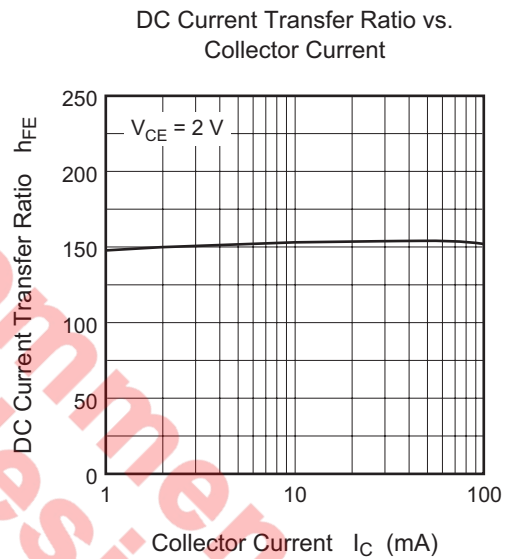
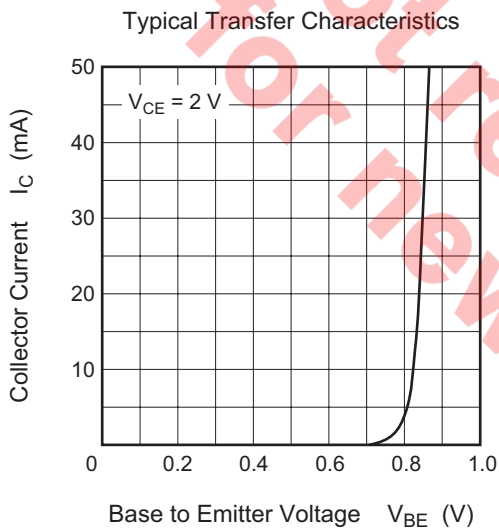
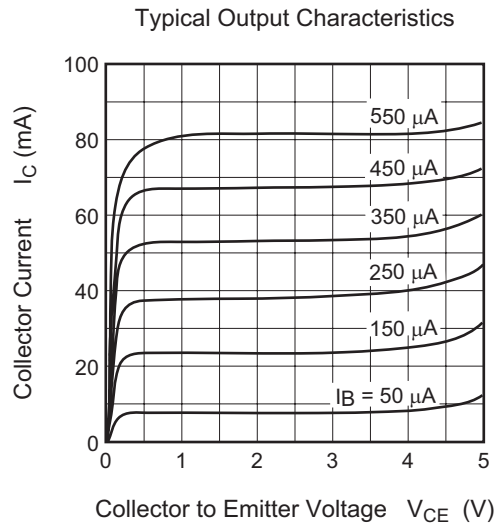
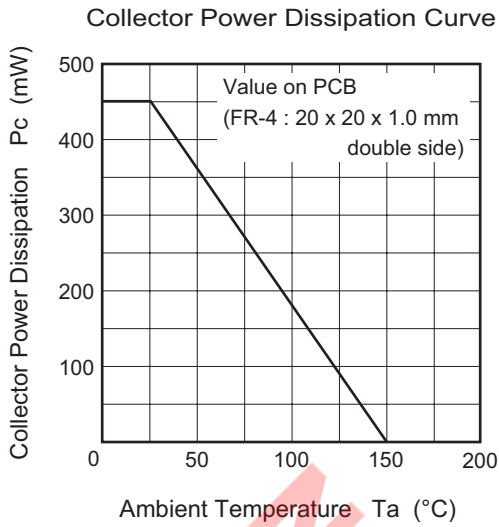

Transition Frequency vs. Collector Current

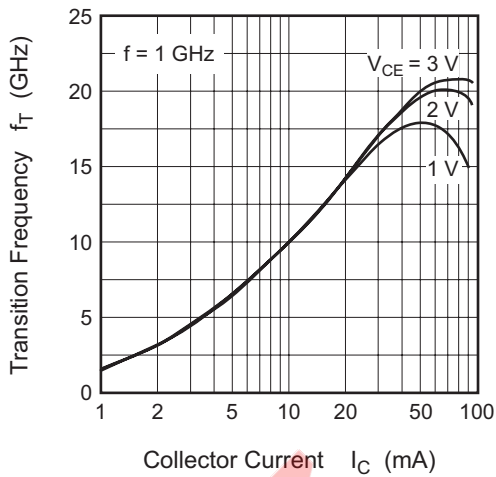

S_{21} Parameter, Maximum Available Gain, Maximum Stable Gain vs. Frequency

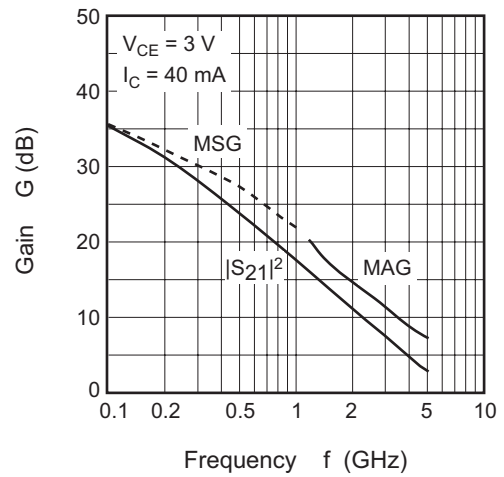

Maximum Available Gain, Maximum Stable Gain vs. Collector Current

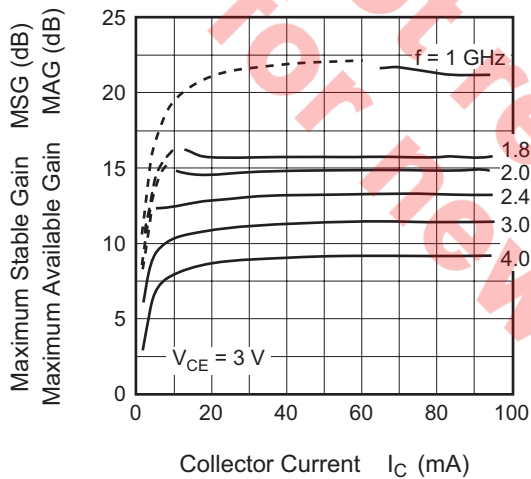

Noise Figure vs. Collector Current

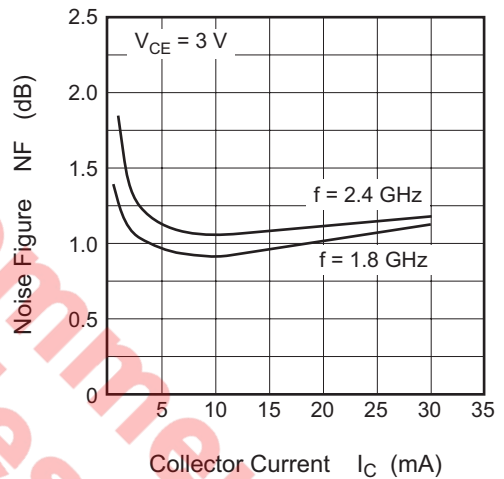

1.8 GHz Characteristics

Evaluation Board Circuit

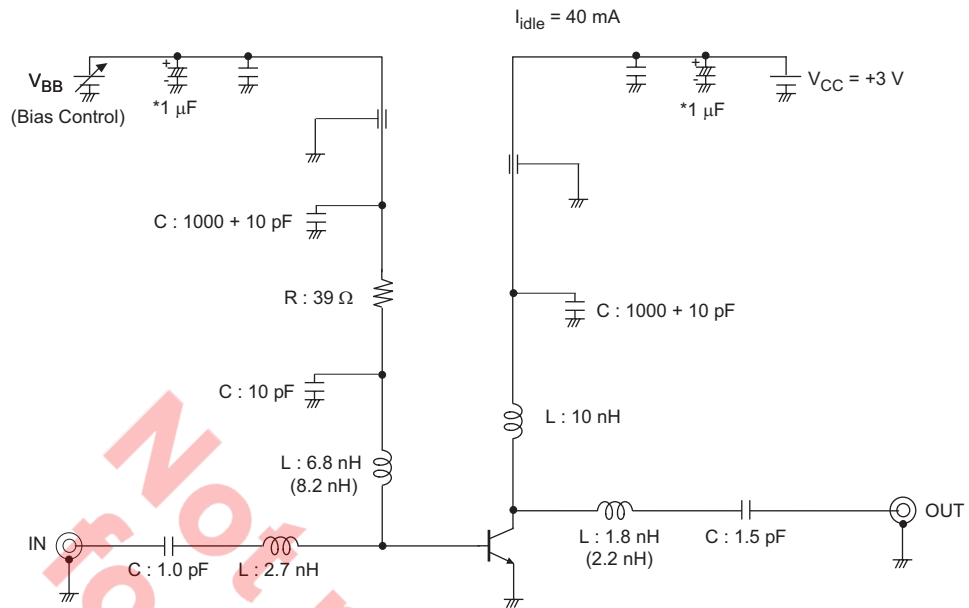

Pin - Pout Characteristics

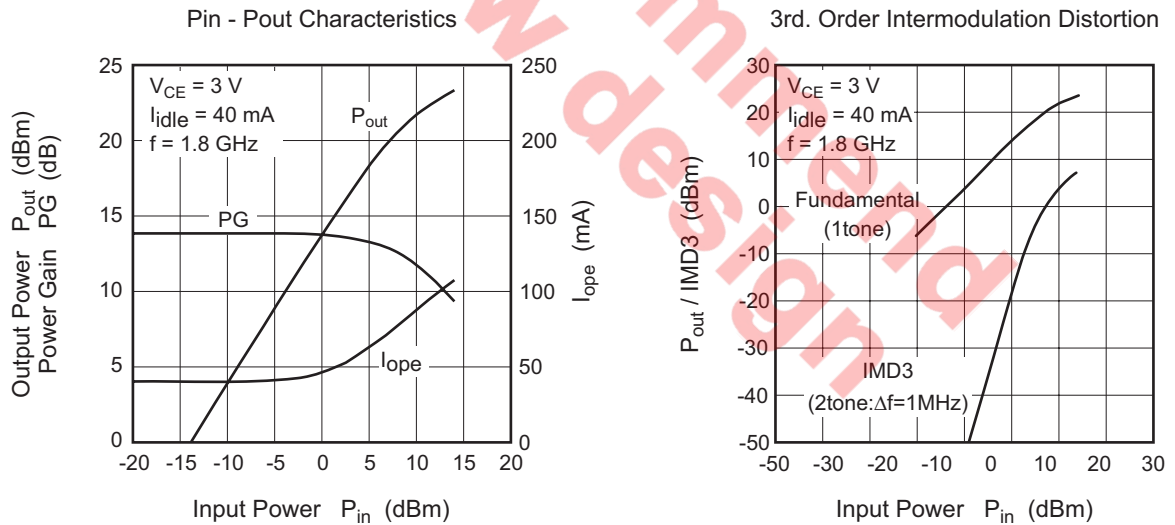

2.4 GHz Characteristics

Evaluation Board Circuit

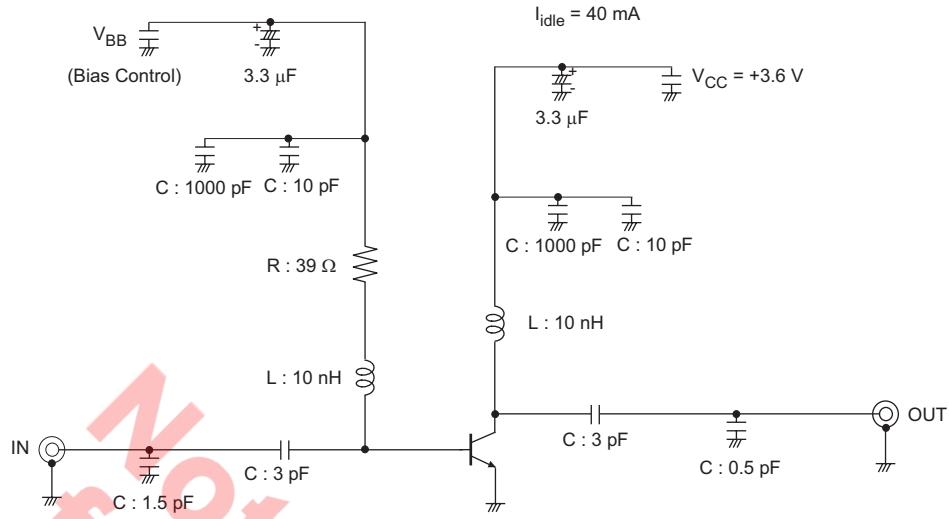

Pin - Pout Characteristics

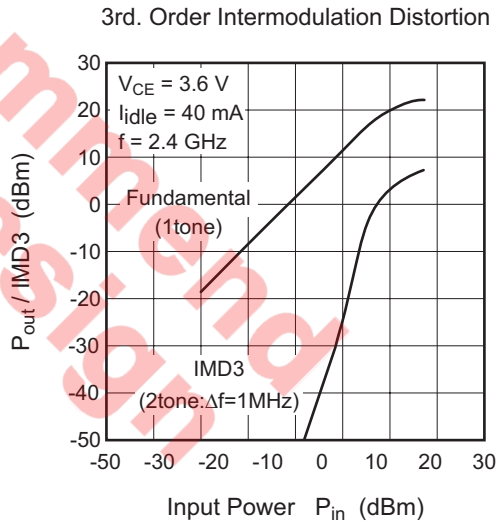
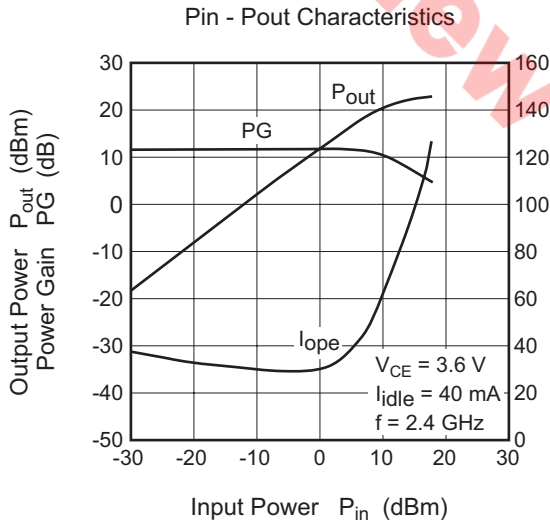

S₁₁ Parameter vs. Frequency

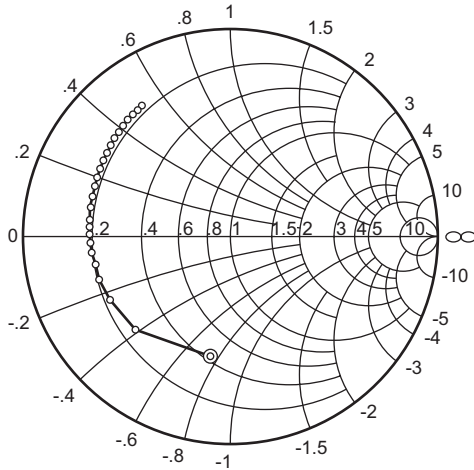

Condition: $V_{CE} = 3\text{ V}$, $I_C = 40\text{ mA}$, $Z_O = 50\ \Omega$
 100 to 1000 MHz (100 MHz Step)
 1000 to 4000 MHz (200 MHz Step)

S₂₁ Parameter vs. Frequency

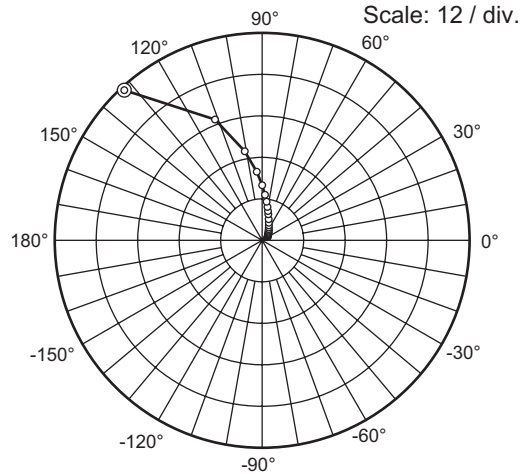

Condition: $V_{CE} = 3\text{ V}$, $I_C = 40\text{ mA}$, $Z_O = 50\ \Omega$
 100 to 1000 MHz (100 MHz Step)
 1000 to 4000 MHz (200 MHz Step)

S₁₂ Parameter vs. Frequency

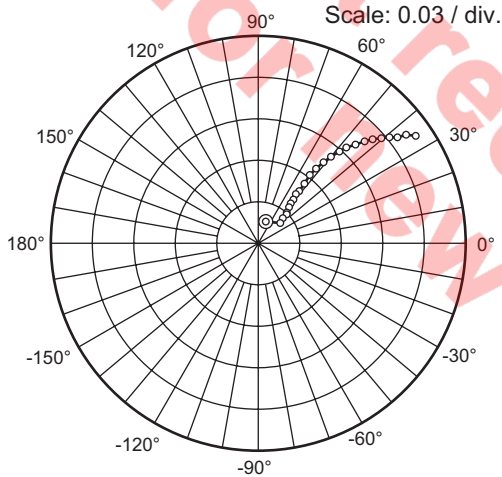

Condition: $V_{CE} = 3\text{ V}$, $I_C = 40\text{ mA}$, $Z_O = 50\ \Omega$
 100 to 1000 MHz (100 MHz Step)
 1000 to 4000 MHz (200 MHz Step)

S₂₂ Parameter vs. Frequency

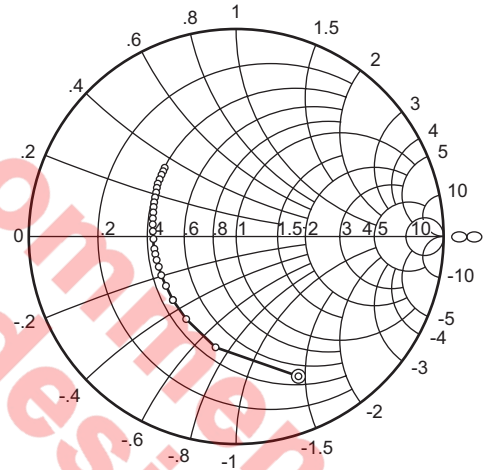

Condition: $V_{CE} = 3\text{ V}$, $I_C = 40\text{ mA}$, $Z_O = 50\ \Omega$
 100 to 1000 MHz (100 MHz Step)
 1000 to 4000 MHz (200 MHz Step)

Noise Parameter

 $(V_{CE} = 3\text{ V}, I_C = 1\text{ mA})$

f (GHz)	NF min (dB)	Zs opt		Rn/50 (-)
		MAG(-)	ANG(deg)	
0.80	0.90	0.643	91.8	0.263
0.90	0.93	0.644	100.2	0.247
1.00	0.96	0.646	108.1	0.229
1.50	1.20	0.678	140.4	0.141
1.80	1.38	0.707	155.0	0.093
1.90	1.45	0.718	159.2	0.080
2.40	1.84	0.768	176.6	0.037
2.90	2.33	0.800	-169.8	0.057

 $(V_{CE} = 3\text{ V}, I_C = 2\text{ mA})$

f (GHz)	NF min (dB)	Zs opt		Rn/50 (-)
		MAG(-)	ANG(deg)	
0.80	0.80	0.526	94.3	0.149
0.90	0.83	0.533	102.9	0.143
1.00	0.87	0.541	111.0	0.136
1.50	1.05	0.595	143.5	0.090
1.80	1.18	0.633	157.8	0.064
1.90	1.23	0.647	161.8	0.057
2.40	1.47	0.710	178.4	0.035
2.90	1.75	0.758	-168.7	0.047

 $(V_{CE} = 3\text{ V}, I_C = 3\text{ mA})$

f (GHz)	NF min (dB)	Zs opt		Rn/50 (-)
		MAG(-)	ANG(deg)	
0.80	0.72	0.448	97.3	0.112
0.90	0.75	0.460	106.0	0.108
1.00	0.79	0.471	114.0	0.103
1.50	0.95	0.537	146.3	0.072
1.80	1.06	0.581	160.2	0.055
1.90	1.09	0.596	164.2	0.050
2.40	1.28	0.672	-179.8	0.034
2.90	1.47	0.744	-167.1	0.042

 $(V_{CE} = 3\text{ V}, I_C = 5\text{ mA})$

f (GHz)	NF min (dB)	Zs opt		Rn/50 (-)
		MAG(-)	ANG(deg)	
0.80	0.73	0.348	105.7	0.084
0.90	0.76	0.364	113.8	0.081
1.00	0.78	0.380	121.3	0.079
1.50	0.90	0.467	151.4	0.059
1.80	0.98	0.521	164.4	0.048
1.90	1.01	0.539	168.1	0.045
2.40	1.15	0.623	-177.2	0.035
2.90	1.30	0.693	-166.0	0.043

 $(V_{CE} = 3\text{ V}, I_C = 7\text{ mA})$

f (GHz)	NF min (dB)	Zs opt		Rn/50 (-)
		MAG(-)	ANG(deg)	
0.80	0.77	0.292	115.8	0.072
0.90	0.78	0.311	123.0	0.071
1.00	0.80	0.330	129.8	0.068
1.50	0.88	0.428	156.8	0.054
1.80	0.94	0.486	168.5	0.045
1.90	0.96	0.505	171.8	0.043
2.40	1.08	0.595	-174.8	0.037
2.90	1.23	0.671	-164.6	0.042

 $(V_{CE} = 3\text{ V}, I_C = 10\text{ mA})$

f (GHz)	NF min (dB)	Zs opt		Rn/50 (-)
		MAG(-)	ANG(deg)	
0.80	0.83	0.249	132.3	0.064
0.90	0.83	0.271	137.8	0.063
1.00	0.83	0.293	143.0	0.061
1.50	0.88	0.397	164.4	0.051
1.80	0.93	0.455	174.1	0.045
1.90	0.95	0.473	176.9	0.044
2.40	1.06	0.559	-171.3	0.041
2.90	1.21	0.634	-162.0	0.048

 $(V_{CE} = 3\text{ V}, I_C = 20\text{ mA})$

f (GHz)	NF min (dB)	Zs opt		Rn/50 (-)
		MAG(-)	ANG(deg)	
0.80	0.95	0.288	167.4	0.055
0.90	0.95	0.302	169.5	0.054
1.00	0.95	0.316	171.5	0.054
1.50	0.99	0.393	-178.7	0.050
1.80	1.02	0.441	-173.1	0.048
1.90	1.03	0.457	-171.3	0.048
2.40	1.11	0.534	-163.3	0.049
2.90	1.21	0.599	-156.9	0.057

 $(V_{CE} = 3\text{ V}, I_C = 30\text{ mA})$

f (GHz)	NF min (dB)	Zs opt		Rn/50 (-)
		MAG(-)	ANG(deg)	
0.80	1.11	0.354	179.3	0.054
0.90	1.10	0.362	-179.1	0.054
1.00	1.10	0.370	-177.6	0.054
1.50	1.09	0.424	-170.2	0.053
1.80	1.11	0.461	-166.0	0.053
1.90	1.11	0.474	-164.6	0.054
2.40	1.17	0.539	-158.0	0.058
2.90	1.27	0.596	-152.0	0.069

S Parameter

 $(V_{CE} = 2\text{ V}, I_C = 5\text{ mA}, Z_O = 50\ \Omega)$

f (MHz)	S11		S21		S12		S22	
	MAG	ANG(deg.)	MAG	ANG(deg.)	MAG	ANG(deg.)	MAG	ANG(deg.)
100	0.891	-30.4	14.63	159.8	0.0325	86.4	0.958	-20.2
200	0.867	-58.0	13.32	143.3	0.0528	57.8	0.856	-37.3
300	0.826	-81.5	11.68	129.8	0.0681	48.0	0.747	-51.4
400	0.802	-100.4	10.17	119.1	0.0774	38.7	0.646	-62.9
500	0.784	-115.3	8.83	110.6	0.0839	33.0	0.564	-72.1
600	0.767	-127.2	7.69	103.7	0.0873	28.8	0.498	-80.2
700	0.758	-136.8	6.77	98.0	0.0903	24.8	0.446	-86.7
800	0.751	-145.0	6.02	93.1	0.0919	21.6	0.406	-93.0
900	0.745	-151.7	5.41	89.0	0.0935	19.3	0.373	-98.4
1000	0.742	-157.6	4.90	85.4	0.0950	17.6	0.347	-103.5
1100	0.741	-162.8	4.46	81.9	0.0946	16.4	0.324	-108.1
1200	0.741	-167.4	4.10	78.8	0.0953	15.2	0.306	-112.8
1300	0.740	-171.5	3.79	75.9	0.0948	13.9	0.291	-117.2
1400	0.741	-175.3	3.52	73.1	0.0954	12.8	0.279	-121.2
1500	0.741	-178.9	3.28	70.5	0.0949	12.3	0.270	-125.2
1600	0.742	-177.7	3.08	68.0	0.0950	11.8	0.262	-129.0
1700	0.742	-174.7	2.89	65.6	0.0948	11.0	0.257	-132.5
1800	0.746	-171.9	2.73	63.3	0.0954	10.9	0.252	-135.9
1900	0.747	-169.2	2.59	60.9	0.0946	10.8	0.249	-139.5
2000	0.749	-166.6	2.45	58.7	0.0949	10.3	0.246	-142.7
2100	0.751	-164.0	2.33	56.5	0.0942	10.5	0.245	-145.8
2200	0.755	-161.7	2.23	54.4	0.0948	10.6	0.244	-148.9
2300	0.758	-159.4	2.12	52.3	0.0943	10.2	0.246	-151.6
2400	0.759	-157.3	2.03	50.2	0.0934	10.4	0.247	-154.3
2500	0.761	-155.2	1.95	48.2	0.0946	10.6	0.249	-156.6
2600	0.765	-153.0	1.87	46.2	0.0943	10.6	0.249	-159.3
2700	0.769	-151.2	1.80	44.3	0.0939	10.6	0.252	-161.7
2800	0.772	-149.2	1.74	42.3	0.0949	11.4	0.255	-164.4
2900	0.773	-147.4	1.66	40.4	0.0947	10.5	0.258	-166.9
3000	0.775	-145.6	1.61	38.5	0.0948	11.8	0.263	-169.0
3100	0.780	-143.9	1.55	36.7	0.0945	12.0	0.268	-170.9
3200	0.783	-142.2	1.50	34.8	0.0955	12.2	0.273	-172.9
3300	0.785	-140.5	1.45	33.0	0.0956	12.1	0.276	-174.8
3400	0.789	-138.8	1.41	31.1	0.0958	13.1	0.280	-176.8
3500	0.790	-137.3	1.36	29.5	0.0965	12.9	0.284	-178.5
3600	0.791	-135.6	1.32	27.6	0.0963	13.5	0.290	-179.2
3700	0.793	-134.3	1.28	26.1	0.0975	14.2	0.294	-177.5
3800	0.794	-132.8	1.24	24.5	0.0985	14.9	0.300	-176.0
3900	0.799	-131.5	1.21	22.9	0.1000	15.7	0.306	-174.6
4000	0.801	-130.1	1.18	21.2	0.1014	15.7	0.312	-173.0

S Parameter

(V_{CE} = 2 V, I_C = 10 mA, Z_O = 50 Ω)

f (MHz)	S11		S21		S12		S22	
	MAG	ANG(deg.)	MAG	ANG(deg.)	MAG	ANG(deg.)	MAG	ANG(deg.)
100	0.810	-45.2	26.15	152.2	0.0281	70.6	0.911	-32.6
200	0.778	-82.0	21.88	132.2	0.0428	49.1	0.745	-57.6
300	0.744	-108.1	17.60	118.1	0.0525	40.0	0.615	-76.1
400	0.733	-126.0	14.33	108.2	0.0565	34.8	0.520	-90.2
500	0.725	-138.6	11.90	101.0	0.0586	31.5	0.457	-101.9
600	0.718	-148.1	10.06	95.5	0.0608	29.1	0.412	-111.7
700	0.715	-155.6	8.69	90.9	0.0633	28.7	0.380	-119.8
800	0.714	-161.9	7.62	87.1	0.0651	26.6	0.359	-127.2
900	0.712	-167.0	6.77	83.8	0.0659	27.2	0.342	-133.7
1000	0.712	-171.4	6.09	80.9	0.0689	25.4	0.330	-139.5
1100	0.714	-175.5	5.53	78.1	0.0691	26.8	0.321	-144.7
1200	0.714	-179.1	5.06	75.6	0.0712	26.8	0.313	-149.6
1300	0.715	177.7	4.65	73.2	0.0722	26.2	0.309	-154.0
1400	0.717	174.6	4.31	70.9	0.0739	26.9	0.306	-158.0
1500	0.718	171.8	4.02	68.8	0.0744	27.2	0.304	-161.8
1600	0.721	169.0	3.76	66.7	0.0766	27.6	0.303	-165.2
1700	0.722	166.6	3.53	64.7	0.0783	26.9	0.303	-168.3
1800	0.726	164.3	3.33	62.6	0.0798	27.4	0.303	-171.2
1900	0.727	161.9	3.15	60.6	0.0812	27.6	0.304	-174.0
2000	0.730	159.8	2.98	58.7	0.0828	27.9	0.306	-176.9
2100	0.733	157.5	2.84	56.8	0.0849	27.9	0.308	-179.3
2200	0.736	155.6	2.70	55.0	0.0874	28.2	0.311	178.1
2300	0.739	153.6	2.58	53.2	0.0880	27.7	0.313	176.3
2400	0.741	151.8	2.47	51.2	0.0894	28.3	0.315	174.2
2500	0.743	149.9	2.36	49.5	0.0930	28.0	0.318	172.3
2600	0.748	148.0	2.27	47.7	0.0934	27.8	0.321	170.1
2700	0.751	146.4	2.18	46.0	0.0952	27.9	0.324	168.5
2800	0.755	144.6	2.10	44.2	0.0976	27.8	0.328	166.4
2900	0.755	143.0	2.02	42.6	0.0983	27.0	0.332	164.5
3000	0.757	141.4	1.95	40.8	0.1000	27.2	0.337	163.0
3100	0.762	139.9	1.88	39.2	0.1016	27.4	0.341	161.7
3200	0.765	138.3	1.82	37.5	0.1044	26.8	0.345	160.1
3300	0.768	136.7	1.76	35.8	0.1061	26.8	0.349	158.6
3400	0.770	135.2	1.70	34.2	0.1069	26.6	0.352	156.9
3500	0.773	133.8	1.65	32.7	0.1084	26.2	0.355	155.4
3600	0.773	132.3	1.60	30.9	0.1100	25.8	0.360	153.8
3700	0.775	131.1	1.55	29.6	0.1125	25.9	0.363	152.4
3800	0.776	129.7	1.51	28.1	0.1147	26.0	0.367	151.4
3900	0.781	128.5	1.47	26.6	0.1166	25.6	0.371	150.3
4000	0.783	127.2	1.43	25.1	0.1192	25.0	0.377	149.1

S Parameter

(V_{CE} = 2 V, I_C = 20 mA, Z_O = 50 Ω)

f (MHz)	S11		S21		S12		S22	
	MAG	ANG(deg.)	MAG	ANG(deg.)	MAG	ANG(deg.)	MAG	ANG(deg.)
100	0.697	-70.9	42.28	141.9	0.0166	71.6	0.832	-51.4
200	0.694	-112.5	30.58	119.5	0.0330	40.5	0.625	-83.0
300	0.689	-135.3	22.43	107.2	0.0360	38.5	0.518	-104.0
400	0.690	-148.6	17.38	99.2	0.0386	34.5	0.458	-119.4
500	0.692	-157.5	14.05	93.7	0.0410	35.8	0.423	-130.8
600	0.692	-164.3	11.71	89.4	0.0428	37.4	0.406	-139.8
700	0.693	-169.7	10.01	85.8	0.0456	38.6	0.393	-147.0
800	0.696	-174.2	8.72	82.8	0.0484	37.4	0.387	-153.1
900	0.696	-178.0	7.72	80.2	0.0504	39.6	0.382	-158.4
1000	0.698	178.6	6.93	77.9	0.0538	39.4	0.379	-162.9
1100	0.700	175.5	6.27	75.6	0.0569	41.0	0.377	-167.0
1200	0.703	172.6	5.72	73.5	0.0592	41.1	0.377	-170.9
1300	0.704	170.0	5.26	71.4	0.0620	41.6	0.377	-174.1
1400	0.706	167.6	4.87	69.5	0.0652	41.6	0.378	-177.3
1500	0.707	165.2	4.54	67.6	0.0676	42.1	0.379	-180.0
1600	0.711	162.9	4.24	65.8	0.0702	42.6	0.381	177.3
1700	0.712	160.8	3.98	64.0	0.0732	42.1	0.383	175.0
1800	0.716	158.9	3.75	62.2	0.0762	41.8	0.385	172.7
1900	0.718	156.9	3.55	60.4	0.0787	41.9	0.387	170.5
2000	0.720	155.0	3.36	58.7	0.0821	41.4	0.390	168.3
2100	0.723	152.9	3.20	57.0	0.0843	40.9	0.392	166.3
2200	0.727	151.3	3.04	55.4	0.0881	41.1	0.396	164.4
2300	0.730	149.6	2.90	53.7	0.0899	40.2	0.399	162.7
2400	0.731	147.9	2.78	52.0	0.0924	40.2	0.402	161.0
2500	0.734	146.2	2.66	50.4	0.0965	39.4	0.406	159.6
2600	0.738	144.5	2.55	48.8	0.0985	39.3	0.408	157.7
2700	0.742	143.0	2.45	47.2	0.1006	38.6	0.411	156.1
2800	0.745	141.4	2.36	45.6	0.1035	38.0	0.415	154.5
2900	0.747	139.9	2.27	44.1	0.1058	36.5	0.420	152.9
3000	0.748	138.4	2.19	42.5	0.1087	36.6	0.424	151.5
3100	0.753	137.0	2.12	40.9	0.1106	36.1	0.428	150.2
3200	0.755	135.5	2.05	39.3	0.1135	35.3	0.432	148.8
3300	0.759	134.1	1.98	37.8	0.1151	34.7	0.434	147.4
3400	0.762	132.6	1.92	36.3	0.1178	34.1	0.437	145.9
3500	0.764	131.4	1.85	34.9	0.1198	33.2	0.440	144.6
3600	0.765	129.9	1.80	33.3	0.1214	33.1	0.444	143.1
3700	0.766	128.8	1.74	32.0	0.1247	32.5	0.447	141.8
3800	0.766	127.5	1.69	30.7	0.1271	32.0	0.451	140.7
3900	0.771	126.4	1.65	29.3	0.1300	31.1	0.453	139.7
4000	0.773	125.1	1.61	27.8	0.1326	30.4	0.458	138.6

S Parameter

(V_{CE} = 2 V, I_C = 30 mA, Z_O = 50 Ω)

f (MHz)	S11		S21		S12		S22	
	MAG	ANG(deg.)	MAG	ANG(deg.)	MAG	ANG(deg.)	MAG	ANG(deg.)
100	0.637	-89.4	52.04	135.0	0.0169	60.8	0.774	-63.1
200	0.667	-129.0	34.31	113.2	0.0263	41.9	0.570	-97.5
300	0.675	-147.9	24.27	102.4	0.0288	40.2	0.487	-118.8
400	0.681	-158.4	18.50	95.5	0.0316	40.4	0.450	-132.9
500	0.684	-165.5	14.85	90.7	0.0338	41.4	0.430	-143.3
600	0.686	-171.0	12.32	87.0	0.0371	44.7	0.421	-151.1
700	0.688	-175.5	10.50	83.9	0.0406	46.2	0.413	-157.3
800	0.691	-179.2	9.14	81.2	0.0435	46.3	0.413	-162.4
900	0.691	177.6	8.08	78.9	0.0469	47.6	0.411	-166.9
1000	0.694	174.6	7.24	76.7	0.0499	47.0	0.409	-170.7
1100	0.696	171.8	6.55	74.6	0.0537	48.5	0.410	-174.3
1200	0.699	169.3	5.98	72.7	0.0567	48.7	0.411	-177.6
1300	0.700	167.0	5.50	70.8	0.0598	48.4	0.413	179.7
1400	0.703	164.8	5.09	69.0	0.0631	49.0	0.414	176.9
1500	0.704	162.6	4.74	67.2	0.0667	49.0	0.416	174.5
1600	0.707	160.4	4.43	65.5	0.0695	48.6	0.418	172.1
1700	0.710	158.5	4.16	63.9	0.0725	48.0	0.421	170.1
1800	0.713	156.8	3.92	62.1	0.0762	48.0	0.424	168.1
1900	0.715	154.9	3.70	60.4	0.0790	47.4	0.426	166.1
2000	0.718	153.1	3.51	58.8	0.0822	46.9	0.429	164.1
2100	0.720	151.1	3.34	57.2	0.0860	46.4	0.432	162.2
2200	0.725	149.6	3.18	55.6	0.0897	45.7	0.435	160.4
2300	0.728	147.9	3.03	54.0	0.0920	45.2	0.439	159.0
2400	0.729	146.3	2.90	52.3	0.0944	44.9	0.442	157.4
2500	0.732	144.7	2.77	50.8	0.0987	43.6	0.445	155.9
2600	0.736	143.1	2.67	49.3	0.1013	43.2	0.448	154.2
2700	0.740	141.6	2.56	47.7	0.1032	42.3	0.450	152.7
2800	0.743	140.1	2.47	46.1	0.1062	41.5	0.455	151.1
2900	0.744	138.7	2.37	44.7	0.1086	40.3	0.459	149.6
3000	0.746	137.3	2.29	43.1	0.1120	39.9	0.463	148.3
3100	0.751	135.8	2.21	41.7	0.1145	39.3	0.467	147.1
3200	0.753	134.4	2.14	40.1	0.1174	38.4	0.471	145.7
3300	0.756	133.1	2.06	38.7	0.1197	37.5	0.473	144.3
3400	0.759	131.6	2.00	37.1	0.1218	36.9	0.477	142.9
3500	0.761	130.4	1.94	35.8	0.1242	36.0	0.478	141.5
3600	0.762	128.9	1.87	34.2	0.1259	35.1	0.483	140.1
3700	0.764	127.8	1.82	33.0	0.1296	34.8	0.486	138.8
3800	0.764	126.5	1.77	31.7	0.1321	34.0	0.489	137.8
3900	0.769	125.5	1.72	30.3	0.1348	33.3	0.491	136.7
4000	0.770	124.3	1.68	28.9	0.1377	32.4	0.495	135.6

S Parameter

(V_{CE} = 2 V, I_C = 40 mA, Z_O = 50 Ω)

f (MHz)	S11		S21		S12		S22	
	MAG	ANG(deg.)	MAG	ANG(deg.)	MAG	ANG(deg.)	MAG	ANG(deg.)
100	0.604	-104.5	57.90	130.3	0.0147	73.4	0.728	-72.0
200	0.656	-139.3	36.17	109.5	0.0215	44.1	0.546	-106.9
300	0.668	-154.9	25.16	99.7	0.0241	47.4	0.478	-127.4
400	0.677	-163.8	19.03	93.5	0.0276	44.0	0.451	-140.5
500	0.681	-169.9	15.22	89.1	0.0305	47.8	0.437	-149.8
600	0.684	-174.8	12.60	85.7	0.0340	49.5	0.432	-156.8
700	0.686	-178.6	10.74	82.8	0.0379	51.2	0.428	-162.5
800	0.689	178.0	9.34	80.4	0.0413	50.7	0.428	-167.1
900	0.691	175.1	8.25	78.2	0.0449	52.4	0.428	-171.0
1000	0.693	172.3	7.40	76.2	0.0483	52.5	0.428	-174.5
1100	0.696	169.8	6.69	74.2	0.0522	53.1	0.429	-177.8
1200	0.698	167.5	6.11	72.3	0.0556	52.9	0.430	179.2
1300	0.699	165.3	5.62	70.5	0.0596	52.8	0.432	176.6
1400	0.702	163.2	5.20	68.8	0.0630	52.6	0.434	174.2
1500	0.704	161.2	4.84	67.1	0.0656	52.2	0.437	171.9
1600	0.707	159.1	4.53	65.4	0.0700	52.1	0.439	169.7
1700	0.709	157.3	4.25	63.8	0.0731	51.5	0.442	167.8
1800	0.712	155.6	4.00	62.1	0.0764	50.9	0.445	165.8
1900	0.714	153.8	3.78	60.4	0.0798	50.6	0.447	164.0
2000	0.717	152.0	3.59	58.8	0.0834	49.6	0.450	162.0
2100	0.720	150.2	3.41	57.3	0.0866	49.2	0.453	160.2
2200	0.724	148.7	3.24	55.7	0.0907	48.2	0.456	158.6
2300	0.727	147.0	3.10	54.2	0.0934	47.4	0.460	157.2
2400	0.728	145.5	2.96	52.5	0.0957	46.9	0.463	155.6
2500	0.730	143.8	2.83	51.1	0.1013	46.2	0.466	154.2
2600	0.734	142.3	2.72	49.5	0.1027	45.1	0.469	152.5
2700	0.739	140.9	2.61	48.0	0.1055	44.3	0.471	151.1
2800	0.742	139.4	2.52	46.4	0.1089	43.7	0.476	149.6
2900	0.744	138.1	2.42	45.0	0.1110	41.9	0.481	148.0
3000	0.745	136.6	2.34	43.5	0.1141	41.7	0.485	146.8
3100	0.750	135.2	2.26	42.1	0.1168	41.0	0.488	145.6
3200	0.752	133.8	2.18	40.5	0.1202	39.8	0.492	144.3
3300	0.756	132.5	2.11	39.1	0.1222	39.1	0.495	142.9
3400	0.759	131.0	2.04	37.6	0.1248	38.4	0.498	141.4
3500	0.760	129.8	1.98	36.3	0.1264	37.1	0.500	140.2
3600	0.761	128.4	1.91	34.7	0.1289	36.3	0.504	138.7
3700	0.763	127.3	1.86	33.6	0.1321	35.9	0.507	137.5
3800	0.763	126.0	1.80	32.2	0.1357	35.3	0.510	136.4
3900	0.768	125.0	1.76	30.9	0.1382	34.2	0.512	135.4
4000	0.769	123.8	1.71	29.5	0.1407	33.3	0.516	134.2

S Parameter

(V_{CE} = 3 V, I_C = 5 mA, Z_O = 50 Ω)

f (MHz)	S11		S21		S12		S22	
	MAG	ANG(deg.)	MAG	ANG(deg.)	MAG	ANG(deg.)	MAG	ANG(deg.)
100	0.898	-29.3	14.63	160.4	0.0246	80.5	0.961	-18.9
200	0.872	-56.3	13.41	144.4	0.0492	56.9	0.864	-35.1
300	0.831	-79.3	11.86	131.1	0.0640	48.7	0.760	-48.4
400	0.806	-98.2	10.39	120.3	0.0741	39.4	0.659	-59.2
500	0.786	-113.2	9.07	111.8	0.0795	33.9	0.576	-67.8
600	0.770	-125.2	7.92	104.8	0.0852	29.3	0.511	-75.4
700	0.759	-135.0	6.99	98.9	0.0868	26.1	0.457	-81.5
800	0.751	-143.4	6.23	93.9	0.0895	22.3	0.416	-87.5
900	0.745	-150.2	5.60	89.8	0.0910	20.6	0.381	-92.5
1000	0.741	-156.2	5.07	86.0	0.0917	18.2	0.353	-97.4
1100	0.740	-161.6	4.62	82.5	0.0912	17.3	0.329	-101.5
1200	0.739	-166.3	4.25	79.4	0.0924	15.9	0.308	-105.8
1300	0.738	-170.5	3.92	76.4	0.0924	14.5	0.292	-110.0
1400	0.738	-174.4	3.64	73.7	0.0925	14.0	0.279	-113.7
1500	0.739	-178.0	3.40	71.1	0.0917	13.2	0.268	-117.7
1600	0.739	-178.6	3.19	68.5	0.0921	12.7	0.259	-121.4
1700	0.740	-175.5	3.00	66.2	0.0918	11.7	0.253	-124.8
1800	0.743	-172.7	2.83	63.8	0.0922	11.8	0.246	-128.2
1900	0.745	-169.8	2.68	61.4	0.0913	11.4	0.242	-131.5
2000	0.747	-167.2	2.54	59.3	0.0919	11.3	0.238	-134.9
2100	0.749	-164.6	2.42	57.1	0.0911	11.3	0.235	-138.0
2200	0.752	-162.3	2.30	54.9	0.0919	11.2	0.234	-141.1
2300	0.755	-160.0	2.20	52.9	0.0917	11.2	0.234	-143.8
2400	0.756	-157.8	2.10	50.7	0.0907	11.2	0.235	-146.7
2500	0.759	-155.6	2.01	48.8	0.0918	11.6	0.235	-149.3
2600	0.763	-153.5	1.94	46.8	0.0914	11.6	0.235	-151.9
2700	0.766	-151.6	1.86	44.9	0.0905	11.3	0.237	-154.4
2800	0.769	-149.6	1.79	42.9	0.0919	12.3	0.239	-157.1
2900	0.770	-147.8	1.72	41.0	0.0916	12.3	0.242	-159.9
3000	0.772	-146.0	1.66	39.1	0.0916	12.6	0.246	-162.1
3100	0.778	-144.3	1.61	37.2	0.0917	13.3	0.250	-164.1
3200	0.780	-142.5	1.55	35.4	0.0920	13.2	0.254	-166.4
3300	0.783	-140.8	1.50	33.6	0.0932	13.8	0.257	-168.3
3400	0.786	-139.1	1.45	31.8	0.0928	14.1	0.261	-170.4
3500	0.788	-137.6	1.41	30.1	0.0929	14.2	0.264	-172.4
3600	0.788	-135.9	1.36	28.3	0.0942	14.7	0.268	-174.8
3700	0.790	-134.6	1.32	26.7	0.0945	15.4	0.273	-176.6
3800	0.791	-133.1	1.28	25.1	0.0960	16.6	0.278	-178.1
3900	0.796	-131.8	1.25	23.5	0.0967	16.8	0.284	-179.5
4000	0.798	-130.4	1.21	21.9	0.0982	17.3	0.290	-178.7

S Parameter

(V_{CE} = 3 V, I_C = 10 mA, Z_O = 50 Ω)

f (MHz)	S11		S21		S12		S22	
	MAG	ANG(deg.)	MAG	ANG(deg.)	MAG	ANG(deg.)	MAG	ANG(deg.)
100	0.813	-43.6	26.20	153.3	0.0243	78.8	0.914	-30.8
200	0.779	-79.2	22.18	133.6	0.0409	51.3	0.754	-53.9
300	0.746	-105.1	18.02	119.5	0.0508	41.3	0.625	-71.4
400	0.731	-123.4	14.78	109.4	0.0546	35.9	0.527	-85.0
500	0.723	-136.3	12.32	102.1	0.0568	32.0	0.457	-96.0
600	0.715	-146.1	10.44	96.4	0.0594	30.1	0.410	-105.5
700	0.711	-153.8	9.03	91.7	0.0618	29.2	0.373	-113.5
800	0.709	-160.3	7.93	87.8	0.0633	27.6	0.350	-120.8
900	0.708	-165.5	7.05	84.4	0.0650	27.2	0.330	-127.4
1000	0.708	-170.3	6.34	81.5	0.0672	26.8	0.316	-133.0
1100	0.709	-174.3	5.75	78.6	0.0678	27.1	0.304	-138.5
1200	0.710	-178.1	5.26	76.1	0.0694	26.5	0.296	-143.5
1300	0.710	178.6	4.84	73.6	0.0703	27.0	0.290	-148.2
1400	0.712	175.5	4.49	71.4	0.0720	27.2	0.285	-152.5
1500	0.713	172.6	4.18	69.2	0.0737	27.5	0.283	-156.3
1600	0.715	169.7	3.91	67.1	0.0748	28.2	0.281	-160.0
1700	0.717	167.3	3.67	65.1	0.0761	27.4	0.280	-163.2
1800	0.720	165.0	3.46	63.0	0.0779	27.9	0.279	-166.3
1900	0.722	162.6	3.27	61.0	0.0794	28.3	0.280	-169.3
2000	0.725	160.3	3.10	59.1	0.0818	28.2	0.280	-172.3
2100	0.727	158.1	2.95	57.2	0.0830	28.1	0.281	-175.0
2200	0.731	156.1	2.81	55.4	0.0847	28.7	0.284	-177.6
2300	0.735	154.1	2.68	53.6	0.0862	28.4	0.286	-179.6
2400	0.735	152.3	2.56	51.7	0.0873	28.7	0.289	178.3
2500	0.738	150.3	2.45	50.0	0.0899	29.1	0.291	176.1
2600	0.742	148.5	2.36	48.2	0.0907	28.3	0.293	174.0
2700	0.746	146.9	2.26	46.5	0.0929	28.5	0.295	172.1
2800	0.750	145.0	2.18	44.7	0.0952	28.4	0.299	170.1
2900	0.751	143.4	2.09	43.0	0.0962	27.9	0.303	168.0
3000	0.753	141.8	2.02	41.3	0.0978	28.0	0.307	166.5
3100	0.757	140.2	1.95	39.7	0.0995	27.9	0.312	165.0
3200	0.760	138.7	1.89	37.9	0.1019	27.5	0.315	163.5
3300	0.763	137.1	1.82	36.3	0.1035	27.3	0.318	161.9
3400	0.766	135.5	1.77	34.7	0.1048	27.4	0.322	160.2
3500	0.768	134.1	1.71	33.2	0.1059	27.1	0.325	158.7
3600	0.769	132.6	1.66	31.5	0.1076	26.7	0.329	156.9
3700	0.771	131.4	1.61	30.1	0.1094	26.9	0.332	155.6
3800	0.771	130.0	1.56	28.6	0.1119	27.2	0.336	154.5
3900	0.776	128.9	1.52	27.1	0.1141	26.6	0.340	153.5
4000	0.778	127.6	1.48	25.6	0.1160	26.3	0.345	152.3

S Parameter

(V_{CE} = 3 V, I_C = 20 mA, Z_O = 50 Ω)

f (MHz)	S11		S21		S12		S22	
	MAG	ANG(deg.)	MAG	ANG(deg.)	MAG	ANG(deg.)	MAG	ANG(deg.)
100	0.687	-67.3	42.60	143.4	0.0221	72.9	0.831	-47.4
200	0.688	-108.9	31.35	121.2	0.0305	44.2	0.632	-77.6
300	0.681	-132.2	23.21	108.6	0.0368	38.0	0.516	-98.4
400	0.684	-146.2	18.07	100.4	0.0380	36.4	0.450	-113.3
500	0.685	-155.6	14.65	94.6	0.0407	37.3	0.410	-124.9
600	0.685	-162.7	12.21	90.2	0.0422	38.1	0.388	-134.4
700	0.686	-168.2	10.45	86.5	0.0453	38.4	0.372	-141.9
800	0.687	-172.9	9.11	83.4	0.0481	38.3	0.364	-148.2
900	0.688	-176.8	8.06	80.7	0.0504	40.8	0.358	-153.7
1000	0.690	179.6	7.23	78.4	0.0529	39.4	0.353	-158.7
1100	0.692	176.4	6.54	76.0	0.0560	40.7	0.351	-163.1
1200	0.694	173.4	5.97	73.9	0.0574	41.4	0.349	-167.2
1300	0.695	170.8	5.49	71.8	0.0613	41.7	0.349	-170.6
1400	0.698	168.3	5.09	69.9	0.0626	42.1	0.349	-174.0
1500	0.700	165.9	4.74	68.0	0.0660	42.6	0.351	-176.9
1600	0.702	163.5	4.43	66.2	0.0686	42.6	0.351	-179.7
1700	0.705	161.4	4.15	64.4	0.0714	41.9	0.353	177.8
1800	0.707	159.4	3.91	62.6	0.0743	42.5	0.356	175.4
1900	0.710	157.4	3.70	60.8	0.0770	42.3	0.357	173.1
2000	0.713	155.5	3.50	59.1	0.0803	41.7	0.359	170.7
2100	0.715	153.5	3.33	57.4	0.0818	41.5	0.362	168.6
2200	0.719	151.8	3.17	55.8	0.0860	41.4	0.365	166.7
2300	0.723	150.0	3.03	54.2	0.0878	40.9	0.368	165.0
2400	0.724	148.4	2.89	52.4	0.0902	40.4	0.371	163.3
2500	0.727	146.6	2.77	50.9	0.0931	40.1	0.374	161.7
2600	0.731	144.9	2.66	49.2	0.0957	39.6	0.377	159.8
2700	0.735	143.4	2.55	47.7	0.0980	39.4	0.379	158.1
2800	0.738	141.7	2.46	46.0	0.1017	38.6	0.383	156.5
2900	0.739	140.3	2.36	44.5	0.1034	37.1	0.388	154.9
3000	0.742	138.8	2.28	42.9	0.1057	37.3	0.392	153.4
3100	0.746	137.3	2.20	41.4	0.1077	36.8	0.395	152.1
3200	0.749	135.9	2.13	39.8	0.1114	35.9	0.399	150.7
3300	0.752	134.4	2.06	38.3	0.1133	35.5	0.402	149.4
3400	0.755	133.0	1.99	36.7	0.1152	34.9	0.405	147.9
3500	0.757	131.7	1.93	35.4	0.1169	33.9	0.407	146.5
3600	0.758	130.2	1.87	33.8	0.1184	33.5	0.411	145.0
3700	0.760	129.1	1.81	32.5	0.1221	33.1	0.414	143.7
3800	0.760	127.7	1.76	31.2	0.1244	32.8	0.417	142.6
3900	0.765	126.7	1.72	29.8	0.1271	31.8	0.420	141.6
4000	0.767	125.5	1.67	28.3	0.1295	31.3	0.424	140.5

S Parameter

(V_{CE} = 3 V, I_C = 30 mA, Z_O = 50 Ω)

f (MHz)	S11		S21		S12		S22	
	MAG	ANG(deg.)	MAG	ANG(deg.)	MAG	ANG(deg.)	MAG	ANG(deg.)
100	0.626	-85.1	52.71	136.9	0.0168	56.1	0.782	-58.0
200	0.656	-125.4	35.41	114.9	0.0258	44.2	0.574	-91.6
300	0.663	-145.0	25.24	103.7	0.0283	41.0	0.480	-112.6
400	0.672	-156.2	19.30	96.6	0.0315	42.4	0.435	-127.1
500	0.675	-163.7	15.52	91.6	0.0321	41.6	0.409	-137.9
600	0.676	-169.5	12.87	87.7	0.0369	44.4	0.398	-146.3
700	0.678	-174.2	10.99	84.5	0.0397	46.3	0.388	-153.0
800	0.681	-178.1	9.56	81.8	0.0429	46.0	0.385	-158.5
900	0.683	178.6	8.45	79.4	0.0461	47.8	0.383	-163.3
1000	0.685	175.5	7.58	77.2	0.0496	47.5	0.382	-167.4
1100	0.687	172.7	6.85	75.1	0.0524	48.9	0.381	-171.2
1200	0.690	170.1	6.26	73.2	0.0557	48.7	0.382	-174.7
1300	0.690	167.7	5.75	71.2	0.0585	48.2	0.383	-177.6
1400	0.694	165.4	5.32	69.4	0.0616	48.4	0.384	179.5
1500	0.696	163.2	4.96	67.7	0.0655	48.9	0.385	176.9
1600	0.698	161.0	4.63	65.9	0.0683	49.0	0.387	174.5
1700	0.701	159.1	4.35	64.3	0.0708	48.4	0.390	172.3
1800	0.704	157.3	4.10	62.6	0.0747	48.1	0.392	170.2
1900	0.706	155.4	3.87	60.8	0.0774	47.5	0.394	168.1
2000	0.709	153.6	3.67	59.2	0.0804	47.3	0.397	165.9
2100	0.712	151.6	3.49	57.6	0.0840	46.9	0.399	164.0
2200	0.716	150.1	3.32	56.0	0.0875	46.1	0.403	162.2
2300	0.719	148.3	3.17	54.5	0.0902	45.4	0.406	160.7
2400	0.721	146.8	3.03	52.8	0.0928	45.0	0.409	159.1
2500	0.723	145.1	2.90	51.3	0.0967	44.4	0.412	157.6
2600	0.728	143.5	2.79	49.7	0.0991	43.7	0.415	155.8
2700	0.731	142.1	2.67	48.2	0.1014	42.8	0.417	154.4
2800	0.735	140.4	2.58	46.6	0.1043	42.1	0.421	152.7
2900	0.736	139.1	2.47	45.2	0.1069	41.0	0.426	151.3
3000	0.738	137.6	2.39	43.6	0.1100	40.7	0.429	149.9
3100	0.743	136.1	2.31	42.2	0.1122	39.8	0.433	148.6
3200	0.745	134.7	2.23	40.7	0.1150	39.1	0.437	147.4
3300	0.749	133.4	2.15	39.2	0.1173	38.0	0.440	146.0
3400	0.752	131.9	2.09	37.7	0.1194	37.5	0.442	144.5
3500	0.754	130.6	2.02	36.3	0.1218	36.6	0.445	143.2
3600	0.755	129.2	1.96	34.8	0.1241	36.1	0.449	141.7
3700	0.756	128.1	1.90	33.6	0.1267	35.5	0.451	140.5
3800	0.757	126.8	1.84	32.3	0.1297	35.0	0.454	139.4
3900	0.761	125.8	1.80	30.9	0.1318	33.9	0.456	138.4
4000	0.763	124.6	1.75	29.5	0.1351	33.2	0.459	137.4

S Parameter

(V_{CE} = 3 V, I_C = 40 mA, Z_O = 50 Ω)

f (MHz)	S11		S21		S12		S22	
	MAG	ANG(deg.)	MAG	ANG(deg.)	MAG	ANG(deg.)	MAG	ANG(deg.)
100	0.585	-99.5	58.96	132.6	0.0166	70.9	0.738	-66.0
200	0.641	-135.6	37.50	111.3	0.0216	42.6	0.543	-100.6
300	0.656	-152.3	26.24	101.1	0.0254	45.6	0.465	-121.2
400	0.666	-161.8	19.90	94.5	0.0293	45.5	0.432	-134.9
500	0.670	-168.3	15.93	90.0	0.0303	47.2	0.414	-144.9
600	0.673	-173.4	13.19	86.5	0.0343	49.5	0.407	-152.7
700	0.676	-177.4	11.25	83.5	0.0372	50.9	0.401	-158.7
800	0.679	179.1	9.78	81.0	0.0406	51.2	0.400	-163.6
900	0.681	176.1	8.65	78.7	0.0448	52.6	0.399	-167.8
1000	0.683	173.2	7.75	76.7	0.0479	51.9	0.399	-171.5
1100	0.685	170.6	7.01	74.7	0.0515	53.7	0.398	-175.0
1200	0.688	168.2	6.40	72.9	0.0545	52.2	0.399	-178.3
1300	0.689	166.0	5.88	71.0	0.0579	52.7	0.401	179.0
1400	0.692	163.8	5.45	69.3	0.0619	53.0	0.403	176.4
1500	0.693	161.8	5.07	67.6	0.0650	52.7	0.405	174.0
1600	0.697	159.6	4.74	65.9	0.0682	52.2	0.407	171.7
1700	0.700	157.8	4.45	64.3	0.0716	51.4	0.409	169.7
1800	0.703	156.1	4.19	62.6	0.0752	51.1	0.411	167.7
1900	0.705	154.3	3.96	61.0	0.0782	50.7	0.414	165.9
2000	0.708	152.5	3.75	59.4	0.0817	50.0	0.416	163.8
2100	0.710	150.6	3.57	57.8	0.0847	49.4	0.419	162.0
2200	0.714	149.1	3.40	56.3	0.0886	48.5	0.423	160.3
2300	0.718	147.4	3.24	54.8	0.0913	47.7	0.426	158.9
2400	0.719	145.9	3.10	53.1	0.0941	47.4	0.429	157.4
2500	0.722	144.2	2.97	51.6	0.0982	46.3	0.432	156.0
2600	0.726	142.7	2.85	50.1	0.1002	45.4	0.434	154.2
2700	0.729	141.3	2.73	48.6	0.1033	44.9	0.436	152.8
2800	0.733	139.7	2.64	47.1	0.1065	43.8	0.441	151.2
2900	0.735	138.3	2.53	45.6	0.1087	42.6	0.445	149.7
3000	0.737	136.9	2.44	44.1	0.1118	42.3	0.449	148.5
3100	0.742	135.5	2.36	42.7	0.1138	41.4	0.452	147.3
3200	0.744	134.1	2.28	41.2	0.1170	40.5	0.456	146.0
3300	0.747	132.8	2.21	39.8	0.1195	39.6	0.458	144.7
3400	0.751	131.3	2.14	38.3	0.1220	38.9	0.461	143.2
3500	0.753	130.1	2.07	37.0	0.1242	38.0	0.463	142.0
3600	0.753	128.6	2.00	35.4	0.1265	37.3	0.467	140.4
3700	0.755	127.6	1.94	34.3	0.1292	36.7	0.469	139.2
3800	0.756	126.3	1.89	33.0	0.1326	36.3	0.472	138.2
3900	0.760	125.2	1.84	31.7	0.1349	35.3	0.474	137.3
4000	0.762	124.1	1.79	30.3	0.1379	34.3	0.478	136.1

S Parameter

(V_{CE} = 3 V, I_C = 50 mA, Z_O = 50 Ω)

f (MHz)	S11		S21		S12		S22	
	MAG	ANG(deg.)	MAG	ANG(deg.)	MAG	ANG(deg.)	MAG	ANG(deg.)
100	0.574	-109.4	62.90	129.6	0.0101	70.7	0.715	-72.1
200	0.636	-142.3	38.70	109.0	0.0179	43.7	0.526	-106.4
300	0.653	-157.0	26.78	99.4	0.0226	46.7	0.460	-126.8
400	0.664	-165.3	20.21	93.2	0.0267	50.1	0.432	-139.7
500	0.669	-171.2	16.15	89.0	0.0288	51.8	0.418	-149.2
600	0.672	-175.8	13.36	85.7	0.0326	52.8	0.414	-156.3
700	0.674	-179.5	11.38	82.9	0.0359	54.0	0.409	-162.0
800	0.678	177.3	9.90	80.5	0.0396	55.4	0.409	-166.6
900	0.679	174.5	8.75	78.4	0.0435	55.2	0.409	-170.6
1000	0.683	171.8	7.84	76.5	0.0471	54.8	0.409	-174.0
1100	0.685	169.4	7.10	74.5	0.0505	55.6	0.408	-177.2
1200	0.687	167.0	6.48	72.7	0.0541	55.1	0.411	179.7
1300	0.688	164.9	5.96	70.9	0.0576	56.3	0.412	177.2
1400	0.691	162.9	5.52	69.2	0.0617	55.1	0.414	174.7
1500	0.694	160.8	5.14	67.6	0.0651	55.4	0.415	172.5
1600	0.696	158.8	4.80	65.9	0.0680	54.6	0.417	170.3
1700	0.699	157.0	4.51	64.4	0.0717	53.5	0.420	168.4
1800	0.702	155.3	4.25	62.7	0.0757	53.2	0.422	166.5
1900	0.704	153.5	4.01	61.1	0.0784	52.5	0.425	164.7
2000	0.707	151.8	3.81	59.5	0.0822	51.6	0.428	162.7
2100	0.710	149.9	3.62	58.0	0.0853	50.9	0.430	161.0
2200	0.713	148.4	3.44	56.5	0.0892	50.3	0.434	159.3
2300	0.718	146.8	3.29	55.0	0.0923	49.5	0.436	158.0
2400	0.719	145.3	3.14	53.3	0.0946	48.7	0.439	156.6
2500	0.721	143.7	3.01	51.9	0.0991	47.6	0.443	155.2
2600	0.725	142.1	2.89	50.4	0.1012	47.1	0.445	153.5
2700	0.729	140.8	2.77	49.0	0.1045	46.5	0.447	152.1
2800	0.733	139.2	2.68	47.4	0.1077	45.4	0.452	150.6
2900	0.735	137.8	2.57	46.0	0.1096	43.7	0.455	149.2
3000	0.736	136.4	2.48	44.5	0.1132	43.3	0.460	147.9
3100	0.741	135.1	2.39	43.1	0.1158	42.7	0.463	146.8
3200	0.744	133.7	2.31	41.6	0.1191	41.5	0.467	145.5
3300	0.747	132.3	2.24	40.2	0.1217	40.8	0.469	144.2
3400	0.750	130.9	2.17	38.7	0.1233	40.0	0.471	142.8
3500	0.752	129.7	2.10	37.4	0.1254	39.0	0.473	141.5
3600	0.753	128.3	2.03	36.0	0.1282	38.4	0.477	140.1
3700	0.754	127.2	1.97	34.8	0.1309	37.6	0.480	138.8
3800	0.755	125.9	1.91	33.5	0.1343	37.1	0.483	137.9
3900	0.759	124.9	1.87	32.2	0.1369	36.0	0.485	136.9
4000	0.761	123.7	1.82	30.8	0.1395	35.1	0.489	135.9

S Parameter

(V_{CE} = 3 V, I_C = 60 mA, Z_O = 50 Ω)

f (MHz)	S11		S21		S12		S22	
	MAG	ANG(deg.)	MAG	ANG(deg.)	MAG	ANG(deg.)	MAG	ANG(deg.)
100	0.553	-117.5	65.48	127.4	0.0146	71.6	0.688	-75.4
200	0.634	-147.0	39.39	107.4	0.0186	44.2	0.515	-110.6
300	0.652	-160.3	27.07	98.2	0.0205	51.7	0.456	-130.5
400	0.663	-167.9	20.37	92.4	0.0244	50.3	0.433	-143.1
500	0.668	-173.1	16.25	88.3	0.0278	53.2	0.421	-152.2
600	0.671	-177.4	13.43	85.2	0.0315	56.2	0.417	-158.8
700	0.674	179.1	11.44	82.5	0.0353	56.7	0.414	-164.1
800	0.678	176.0	9.95	80.3	0.0389	56.9	0.414	-168.4
900	0.679	173.4	8.80	78.2	0.0430	57.6	0.415	-172.3
1000	0.682	170.8	7.89	76.3	0.0469	57.9	0.414	-175.5
1100	0.685	168.5	7.14	74.4	0.0508	57.6	0.415	-178.6
1200	0.688	166.2	6.52	72.7	0.0540	57.6	0.417	178.5
1300	0.688	164.2	6.00	70.9	0.0574	57.4	0.419	176.0
1400	0.692	162.1	5.55	69.3	0.0610	56.8	0.420	173.6
1500	0.694	160.2	5.17	67.6	0.0648	56.3	0.422	171.5
1600	0.697	158.2	4.84	66.0	0.0690	55.8	0.424	169.4
1700	0.699	156.4	4.54	64.5	0.0716	54.9	0.426	167.6
1800	0.702	154.8	4.28	62.8	0.0755	54.7	0.429	165.7
1900	0.704	153.0	4.04	61.2	0.0790	54.1	0.432	163.9
2000	0.707	151.3	3.83	59.7	0.0829	53.0	0.434	162.1
2100	0.710	149.5	3.65	58.1	0.0859	52.2	0.437	160.5
2200	0.714	148.0	3.47	56.6	0.0899	51.3	0.440	158.8
2300	0.718	146.4	3.31	55.2	0.0924	50.3	0.443	157.5
2400	0.718	144.9	3.17	53.5	0.0953	49.9	0.446	156.1
2500	0.721	143.3	3.03	52.1	0.1001	48.8	0.449	154.7
2600	0.725	141.8	2.91	50.6	0.1015	47.8	0.451	153.2
2700	0.730	140.5	2.79	49.2	0.1049	46.9	0.454	151.7
2800	0.732	138.8	2.70	47.6	0.1086	46.2	0.458	150.2
2900	0.734	137.5	2.59	46.3	0.1102	44.9	0.462	148.8
3000	0.737	136.2	2.50	44.8	0.1136	44.3	0.466	147.6
3100	0.741	134.7	2.41	43.4	0.1168	43.4	0.469	146.5
3200	0.743	133.4	2.33	41.9	0.1193	42.5	0.473	145.3
3300	0.746	132.1	2.26	40.5	0.1224	41.3	0.475	144.0
3400	0.749	130.6	2.19	39.0	0.1245	40.7	0.478	142.6
3500	0.752	129.4	2.12	37.7	0.1268	39.6	0.480	141.3
3600	0.752	128.0	2.05	36.2	0.1291	38.9	0.484	139.9
3700	0.754	126.9	1.99	35.1	0.1322	38.2	0.486	138.7
3800	0.754	125.7	1.93	33.8	0.1356	37.6	0.489	137.7
3900	0.758	124.7	1.88	32.5	0.1381	36.7	0.491	136.8
4000	0.761	123.5	1.83	31.2	0.1412	35.6	0.495	135.7

S Parameter

 $(V_{CE} = 4 \text{ V}, I_C = 5 \text{ mA}, Z_O = 50 \Omega)$

f (MHz)	S11		S21		S12		S22	
	MAG	ANG(deg.)	MAG	ANG(deg.)	MAG	ANG(deg.)	MAG	ANG(deg.)
100	0.904	-28.4	14.33	161.0	0.0287	87.5	0.956	-17.9
200	0.879	-54.6	13.25	145.3	0.0470	58.6	0.864	-33.4
300	0.839	-77.4	11.82	132.0	0.0646	49.3	0.764	-46.3
400	0.811	-96.4	10.43	121.2	0.0723	41.0	0.666	-56.6
500	0.792	-111.4	9.14	112.7	0.0775	34.4	0.585	-65.0
600	0.773	-123.6	8.02	105.6	0.0824	29.7	0.519	-72.2
700	0.761	-133.6	7.09	99.6	0.0850	26.5	0.464	-78.0
800	0.753	-142.1	6.33	94.6	0.0874	23.1	0.423	-83.6
900	0.745	-149.1	5.69	90.4	0.0889	21.2	0.387	-88.3
1000	0.742	-155.2	5.16	86.6	0.0896	18.9	0.357	-92.9
1100	0.739	-160.6	4.70	83.1	0.0903	17.5	0.333	-96.7
1200	0.739	-165.4	4.33	79.9	0.0910	16.2	0.312	-100.9
1300	0.737	-169.7	4.00	76.9	0.0907	14.9	0.295	-104.7
1400	0.737	-173.7	3.71	74.2	0.0911	14.1	0.281	-108.4
1500	0.737	-177.3	3.46	71.6	0.0907	13.7	0.269	-112.0
1600	0.738	-179.2	3.25	69.0	0.0902	12.9	0.259	-115.4
1700	0.739	-176.1	3.05	66.6	0.0903	12.3	0.252	-118.7
1800	0.741	-173.2	2.88	64.3	0.0900	12.0	0.245	-121.8
1900	0.743	-170.5	2.73	61.9	0.0904	12.0	0.240	-125.0
2000	0.745	-167.7	2.59	59.8	0.0903	11.6	0.235	-128.2
2100	0.747	-165.1	2.46	57.6	0.0901	11.5	0.232	-131.3
2200	0.749	-162.8	2.34	55.5	0.0905	11.9	0.231	-134.4
2300	0.753	-160.4	2.24	53.4	0.0898	11.4	0.230	-137.2
2400	0.754	-158.3	2.14	51.3	0.0892	11.7	0.230	-139.8
2500	0.757	-156.0	2.05	49.4	0.0897	12.2	0.230	-142.4
2600	0.761	-153.9	1.97	47.4	0.0891	12.3	0.230	-145.0
2700	0.764	-152.0	1.89	45.5	0.0893	12.5	0.231	-147.5
2800	0.767	-150.0	1.83	43.5	0.0896	12.8	0.233	-150.3
2900	0.768	-148.2	1.75	41.7	0.0903	12.4	0.235	-152.9
3000	0.770	-146.4	1.69	39.8	0.0902	13.4	0.238	-155.2
3100	0.775	-144.6	1.64	37.9	0.0899	13.7	0.242	-157.4
3200	0.778	-142.8	1.58	36.1	0.0917	14.3	0.247	-159.6
3300	0.781	-141.1	1.53	34.3	0.0910	14.2	0.249	-161.6
3400	0.783	-139.4	1.48	32.5	0.0913	15.0	0.252	-163.7
3500	0.786	-137.9	1.43	30.8	0.0915	15.2	0.256	-165.7
3600	0.787	-136.2	1.39	29.0	0.0921	15.7	0.260	-168.0
3700	0.788	-134.8	1.35	27.5	0.0928	16.4	0.264	-170.0
3800	0.789	-133.4	1.31	25.9	0.0939	17.5	0.270	-171.7
3900	0.794	-132.1	1.27	24.3	0.0948	18.2	0.275	-173.1
4000	0.797	-130.6	1.24	22.7	0.0967	18.4	0.282	-174.9

S Parameter

(V_{CE} = 4 V, I_C = 10 mA, Z_O = 50 Ω)

f (MHz)	S11		S21		S12		S22	
	MAG	ANG(deg.)	MAG	ANG(deg.)	MAG	ANG(deg.)	MAG	ANG(deg.)
100	0.816	-41.7	25.68	154.3	0.0259	81.0	0.901	-29.3
200	0.785	-76.7	22.06	134.8	0.0400	48.7	0.754	-51.5
300	0.749	-102.8	18.13	120.7	0.0499	41.6	0.624	-68.5
400	0.732	-121.3	14.96	110.4	0.0537	36.1	0.525	-81.5
500	0.722	-134.5	12.52	103.0	0.0569	32.5	0.456	-92.1
600	0.714	-144.6	10.64	97.1	0.0587	30.0	0.406	-101.3
700	0.710	-152.5	9.21	92.4	0.0610	29.6	0.368	-109.0
800	0.707	-159.1	8.09	88.3	0.0628	27.4	0.343	-116.1
900	0.705	-164.5	7.19	85.0	0.0644	27.8	0.322	-122.5
1000	0.704	-169.2	6.48	82.0	0.0653	27.2	0.306	-128.3
1100	0.705	-173.5	5.87	79.1	0.0674	26.9	0.293	-133.6
1200	0.707	-177.3	5.37	76.6	0.0687	27.0	0.284	-138.7
1300	0.707	179.3	4.95	74.1	0.0695	27.2	0.277	-143.5
1400	0.709	176.2	4.58	71.8	0.0710	27.4	0.271	-147.7
1500	0.710	173.2	4.27	69.7	0.0727	28.1	0.268	-151.6
1600	0.712	170.3	3.99	67.5	0.0738	28.2	0.265	-155.4
1700	0.713	167.8	3.75	65.5	0.0752	27.6	0.264	-158.6
1800	0.717	165.4	3.53	63.5	0.0764	28.3	0.263	-161.7
1900	0.718	163.1	3.34	61.5	0.0780	28.6	0.263	-164.9
2000	0.721	160.8	3.17	59.6	0.0802	28.3	0.263	-167.9
2100	0.723	158.5	3.01	57.7	0.0813	28.5	0.264	-170.6
2200	0.727	156.5	2.87	55.9	0.0836	29.0	0.266	-173.0
2300	0.730	154.5	2.74	54.1	0.0845	28.9	0.268	-175.2
2400	0.731	152.6	2.62	52.2	0.0863	29.2	0.270	-177.5
2500	0.734	150.7	2.50	50.5	0.0887	28.6	0.272	-179.4
2600	0.738	148.8	2.41	48.8	0.0897	29.2	0.274	178.3
2700	0.741	147.1	2.31	47.0	0.0915	29.0	0.276	176.5
2800	0.746	145.4	2.23	45.3	0.0938	28.8	0.280	174.2
2900	0.747	143.8	2.14	43.6	0.0945	28.4	0.284	172.4
3000	0.749	142.1	2.07	41.9	0.0963	28.7	0.289	170.7
3100	0.753	140.5	2.00	40.3	0.0978	28.9	0.293	169.3
3200	0.756	139.0	1.93	38.6	0.1005	28.3	0.297	167.7
3300	0.759	137.4	1.87	37.0	0.1015	28.2	0.299	166.2
3400	0.762	135.8	1.81	35.3	0.1029	28.2	0.302	164.5
3500	0.764	134.4	1.75	33.8	0.1043	28.1	0.305	163.1
3600	0.765	132.8	1.70	32.2	0.1056	27.7	0.310	161.3
3700	0.767	131.6	1.65	30.8	0.1083	28.1	0.313	159.9
3800	0.768	130.3	1.60	29.3	0.1102	27.8	0.317	158.8
3900	0.772	129.1	1.56	27.9	0.1125	27.5	0.322	157.8
4000	0.775	127.8	1.52	26.3	0.1147	27.4	0.326	156.7

S Parameter

(V_{CE} = 4 V, I_C = 20 mA, Z_O = 50 Ω)

f (MHz)	S11		S21		S12		S22	
	MAG	ANG(deg.)	MAG	ANG(deg.)	MAG	ANG(deg.)	MAG	ANG(deg.)
100	0.681	-64.8	42.08	144.8	0.0195	77.2	0.809	-45.2
200	0.683	-106.2	31.49	122.7	0.0300	41.6	0.619	-74.2
300	0.675	-129.9	23.52	109.9	0.0343	41.1	0.504	-94.3
400	0.679	-144.4	18.39	101.4	0.0375	37.7	0.438	-109.3
500	0.680	-154.1	14.95	95.5	0.0398	36.7	0.397	-121.2
600	0.679	-161.5	12.47	91.0	0.0424	37.5	0.373	-130.6
700	0.681	-167.2	10.68	87.2	0.0444	38.7	0.356	-138.2
800	0.682	-172.0	9.32	84.1	0.0472	38.1	0.347	-144.9
900	0.683	-176.0	8.25	81.3	0.0500	39.8	0.340	-150.6
1000	0.685	-179.7	7.40	78.9	0.0523	39.6	0.335	-155.5
1100	0.687	177.1	6.69	76.6	0.0548	40.7	0.331	-160.1
1200	0.690	174.0	6.11	74.5	0.0572	40.7	0.329	-164.3
1300	0.691	171.4	5.62	72.3	0.0596	41.6	0.329	-167.8
1400	0.693	168.8	5.20	70.4	0.0627	41.9	0.328	-171.1
1500	0.695	166.4	4.84	68.5	0.0649	42.8	0.329	-174.2
1600	0.698	163.9	4.53	66.7	0.0680	42.6	0.330	-177.1
1700	0.699	161.8	4.25	65.0	0.0702	42.5	0.332	-179.6
1800	0.703	159.8	4.01	63.1	0.0732	42.4	0.333	177.9
1900	0.705	157.8	3.78	61.4	0.0762	41.9	0.336	175.7
2000	0.708	155.8	3.59	59.7	0.0789	41.8	0.337	173.3
2100	0.710	153.8	3.41	58.0	0.0811	41.9	0.340	171.2
2200	0.714	152.1	3.25	56.3	0.0845	41.8	0.343	169.2
2300	0.718	150.3	3.10	54.7	0.0866	41.0	0.346	167.6
2400	0.719	148.6	2.96	53.0	0.0892	40.7	0.349	166.0
2500	0.722	146.9	2.83	51.5	0.0929	40.2	0.352	164.3
2600	0.726	145.2	2.73	49.8	0.0938	40.4	0.354	162.4
2700	0.730	143.7	2.61	48.3	0.0970	39.5	0.356	160.9
2800	0.733	142.0	2.52	46.6	0.0998	39.1	0.361	159.2
2900	0.735	140.5	2.42	45.1	0.1016	37.7	0.365	157.5
3000	0.737	139.0	2.34	43.6	0.1037	38.0	0.369	156.2
3100	0.741	137.5	2.26	42.1	0.1064	37.4	0.373	154.9
3200	0.744	136.1	2.18	40.5	0.1089	36.9	0.377	153.6
3300	0.748	134.7	2.11	39.0	0.1115	36.2	0.380	152.2
3400	0.750	133.2	2.05	37.4	0.1136	35.5	0.382	150.6
3500	0.752	131.9	1.98	36.0	0.1155	35.0	0.385	149.4
3600	0.754	130.4	1.92	34.5	0.1170	34.4	0.389	147.8
3700	0.755	129.3	1.86	33.2	0.1197	34.1	0.391	146.7
3800	0.755	128.0	1.81	31.9	0.1230	33.7	0.395	145.6
3900	0.760	126.9	1.76	30.5	0.1256	32.9	0.398	144.7
4000	0.762	125.6	1.72	29.1	0.1278	32.3	0.402	143.6

S Parameter

(V_{CE} = 4 V, I_C = 30 mA, Z_O = 50 Ω)

f (MHz)	S11		S21		S12		S22	
	MAG	ANG(deg.)	MAG	ANG(deg.)	MAG	ANG(deg.)	MAG	ANG(deg.)
100	0.600	-83.3	52.11	138.7	0.0144	70.8	0.747	-55.2
200	0.640	-123.1	35.64	116.7	0.0257	41.7	0.557	-87.4
300	0.653	-143.0	25.62	105.2	0.0286	42.6	0.466	-108.6
400	0.664	-154.7	19.67	97.7	0.0321	42.2	0.419	-123.3
500	0.667	-162.5	15.84	92.6	0.0332	43.3	0.392	-134.6
600	0.669	-168.5	13.15	88.6	0.0362	44.3	0.379	-143.2
700	0.672	-173.3	11.23	85.3	0.0396	45.5	0.368	-150.0
800	0.675	-177.3	9.78	82.5	0.0424	45.9	0.366	-155.8
900	0.676	179.2	8.64	80.0	0.0459	47.9	0.362	-160.7
1000	0.679	176.0	7.75	77.9	0.0479	47.0	0.361	-164.9
1100	0.681	173.2	7.01	75.7	0.0523	48.8	0.360	-168.8
1200	0.684	170.5	6.40	73.8	0.0549	48.6	0.359	-172.5
1300	0.685	168.1	5.89	71.8	0.0578	48.6	0.361	-175.5
1400	0.688	165.9	5.45	70.0	0.0616	48.6	0.362	-178.4
1500	0.689	163.6	5.07	68.3	0.0644	49.0	0.364	179.0
1600	0.693	161.4	4.74	66.5	0.0673	48.6	0.365	176.5
1700	0.695	159.4	4.45	64.9	0.0700	48.4	0.367	174.4
1800	0.699	157.6	4.20	63.1	0.0735	48.3	0.369	172.2
1900	0.701	155.7	3.96	61.4	0.0764	47.8	0.371	170.2
2000	0.704	153.8	3.76	59.8	0.0800	47.4	0.374	168.0
2100	0.706	151.9	3.57	58.2	0.0829	47.0	0.377	166.2
2200	0.710	150.3	3.40	56.6	0.0860	46.4	0.380	164.4
2300	0.714	148.6	3.25	55.1	0.0888	45.6	0.383	162.9
2400	0.715	147.0	3.11	53.4	0.0913	45.7	0.386	161.3
2500	0.718	145.3	2.97	52.0	0.0953	44.3	0.389	159.9
2600	0.722	143.7	2.86	50.4	0.0972	44.2	0.391	158.0
2700	0.725	142.2	2.74	48.9	0.1001	43.4	0.394	156.6
2800	0.730	140.6	2.65	47.3	0.1042	42.6	0.398	155.0
2900	0.730	139.2	2.54	45.8	0.1045	41.5	0.403	153.4
3000	0.733	137.8	2.45	44.3	0.1080	41.4	0.406	152.2
3100	0.737	136.4	2.37	42.9	0.1104	40.4	0.410	151.0
3200	0.740	135.0	2.29	41.3	0.1140	39.7	0.414	149.8
3300	0.744	133.6	2.21	39.9	0.1162	38.9	0.417	148.4
3400	0.747	132.0	2.15	38.4	0.1183	38.2	0.420	146.9
3500	0.748	130.9	2.08	37.0	0.1202	37.4	0.422	145.7
3600	0.750	129.3	2.01	35.5	0.1222	36.8	0.426	144.2
3700	0.751	128.2	1.95	34.3	0.1254	36.2	0.428	143.0
3800	0.752	127.0	1.90	33.0	0.1284	35.8	0.432	142.0
3900	0.756	125.9	1.85	31.6	0.1311	35.1	0.434	141.0
4000	0.758	124.7	1.80	30.2	0.1337	34.0	0.438	140.0

S Parameter

(V_{CE} = 4 V, I_C = 40 mA, Z_O = 50 Ω)

f (MHz)	S11		S21		S12		S22	
	MAG	ANG(deg.)	MAG	ANG(deg.)	MAG	ANG(deg.)	MAG	ANG(deg.)
100	0.549	-97.4	58.13	134.8	0.0162	71.1	0.700	-61.8
200	0.625	-133.5	37.78	113.4	0.0207	43.2	0.526	-96.1
300	0.644	-150.6	26.64	102.6	0.0247	44.4	0.449	-117.2
400	0.656	-160.4	20.28	95.8	0.0279	44.8	0.414	-131.4
500	0.663	-167.1	16.26	91.0	0.0307	46.1	0.396	-141.7
600	0.666	-172.4	13.48	87.4	0.0341	49.6	0.387	-149.8
700	0.669	-176.7	11.49	84.3	0.0365	50.6	0.380	-156.1
800	0.672	179.7	10.00	81.7	0.0405	51.1	0.379	-161.2
900	0.673	176.7	8.84	79.4	0.0436	52.2	0.378	-165.6
1000	0.677	173.8	7.93	77.4	0.0466	51.3	0.376	-169.6
1100	0.679	171.1	7.17	75.4	0.0513	52.4	0.377	-173.1
1200	0.682	168.6	6.55	73.5	0.0544	52.8	0.377	-176.3
1300	0.683	166.4	6.02	71.6	0.0572	53.2	0.379	-179.1
1400	0.686	164.2	5.58	69.9	0.0605	52.3	0.380	178.2
1500	0.688	162.1	5.19	68.2	0.0644	52.4	0.382	175.8
1600	0.691	160.0	4.86	66.5	0.0675	52.2	0.384	173.5
1700	0.694	158.1	4.56	64.9	0.0706	52.0	0.386	171.5
1800	0.697	156.3	4.30	63.2	0.0737	51.2	0.388	169.5
1900	0.699	154.5	4.06	61.6	0.0772	50.8	0.391	167.5
2000	0.702	152.7	3.85	60.0	0.0809	50.2	0.393	165.5
2100	0.705	150.8	3.66	58.4	0.0838	49.9	0.396	163.8
2200	0.708	149.3	3.48	56.9	0.0877	48.7	0.400	162.0
2300	0.712	147.6	3.33	55.4	0.0894	48.0	0.403	160.7
2400	0.713	146.1	3.18	53.7	0.0927	48.0	0.405	159.1
2500	0.716	144.5	3.04	52.3	0.0966	46.5	0.409	157.8
2600	0.720	142.9	2.93	50.7	0.0982	46.1	0.412	156.1
2700	0.724	141.5	2.81	49.2	0.1020	45.3	0.414	154.6
2800	0.728	139.9	2.71	47.7	0.1056	44.3	0.418	153.1
2900	0.730	138.5	2.60	46.2	0.1069	42.9	0.423	151.6
3000	0.731	137.1	2.51	44.8	0.1106	43.0	0.426	150.4
3100	0.736	135.6	2.43	43.3	0.1129	42.0	0.429	149.3
3200	0.738	134.3	2.35	41.8	0.1162	41.1	0.434	148.0
3300	0.741	133.0	2.27	40.4	0.1182	40.2	0.437	146.7
3400	0.745	131.5	2.20	38.9	0.1208	39.6	0.439	145.3
3500	0.747	130.2	2.13	37.6	0.1223	38.6	0.441	143.9
3600	0.748	128.8	2.06	36.0	0.1250	38.0	0.446	142.5
3700	0.750	127.8	2.00	34.8	0.1282	37.5	0.448	141.3
3800	0.750	126.5	1.94	33.6	0.1313	36.9	0.451	140.3
3900	0.754	125.4	1.89	32.2	0.1338	35.9	0.454	139.4
4000	0.756	124.3	1.84	30.8	0.1364	35.0	0.458	138.3

Package Dimensions

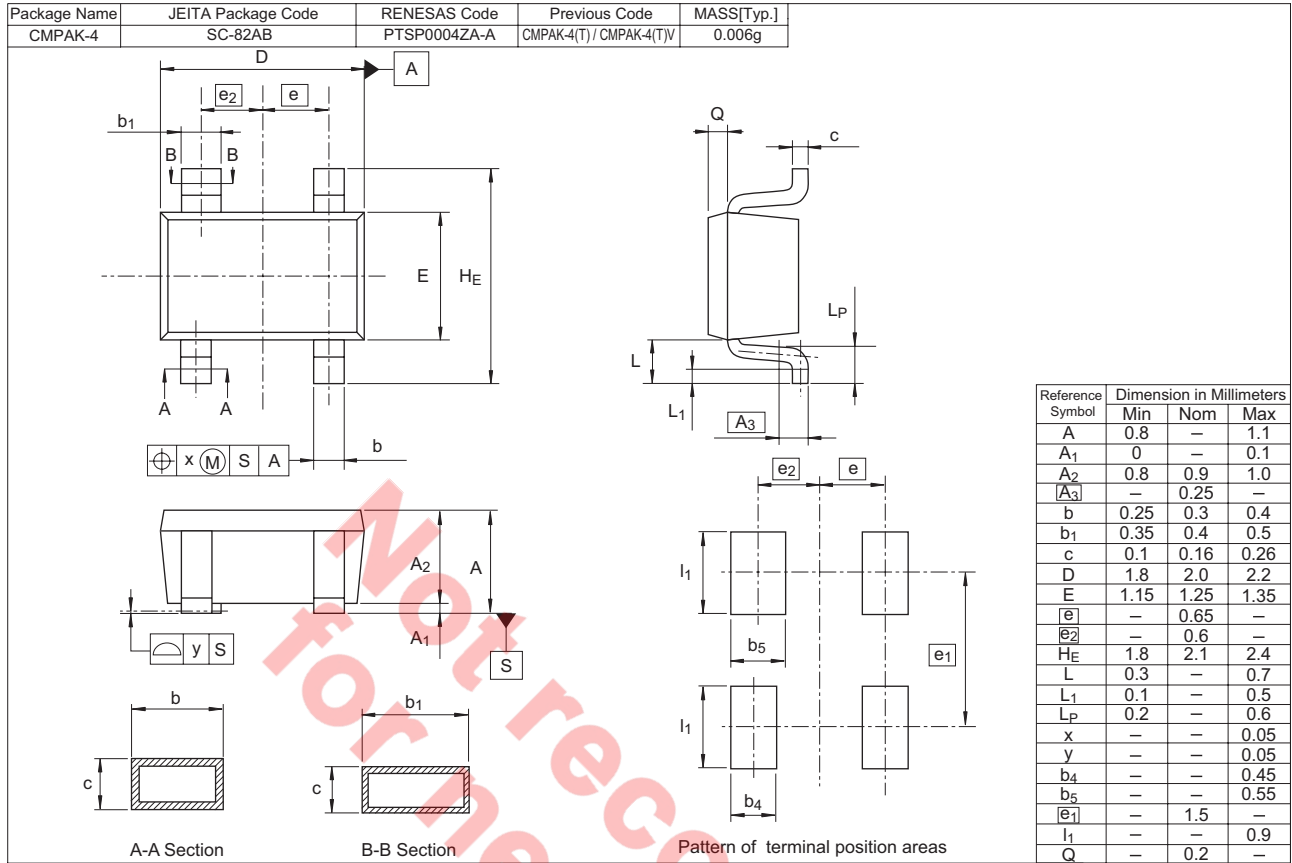

Ordering Information

Part No.	Quantity	Shipping Container
RQG2001UR-TL-E	3000 pcs	φ178 mm reel, 8 mm emboss taping

Note: For some grades, production may be terminated. Please contact the Renesas sales office to check the state of production before ordering the product.

Notes:

1. This document is provided for reference purposes only so that Renesas customers may select the appropriate Renesas products for their use. Renesas neither makes warranties or representations with respect to the accuracy or completeness of the information contained in this document nor grants any license to any intellectual property rights or any other rights of Renesas or any third party with respect to the information in this document.
2. Renesas shall have no liability for damages or infringement of any intellectual property or other rights arising out of the use of any information in this document, including, but not limited to, product data, diagrams, charts, programs, algorithms, and application circuit examples.
3. You should not use the products or the technology described in this document for the purpose of military applications such as the development of weapons of mass destruction or for the purpose of any other military use. When exporting the products or technology described herein, you should follow the applicable export control laws and regulations, and procedures required by such laws and regulations.
4. All information included in this document such as product data, diagrams, charts, programs, algorithms, and application circuit examples, is current as of the date this document is issued. Such information, however, is subject to change without any prior notice. Before purchasing or using any Renesas products listed in this document, please confirm the latest product information with a Renesas sales office. Also, please pay regular and careful attention to additional and different information to be disclosed by Renesas such as that disclosed through our website. (<http://www.renesas.com>)
5. Renesas has used reasonable care in compiling the information included in this document, but Renesas assumes no liability whatsoever for any damages incurred as a result of errors or omissions in the information included in this document.
6. When using or otherwise relying on the information in this document, you should evaluate the information in light of the total system before deciding about the applicability of such information to the intended application. Renesas makes no representations, warranties or guarantees regarding the suitability of its products for any particular application and specifically disclaims any liability arising out of the application and use of the information in this document or Renesas products.
7. With the exception of products specified by Renesas as suitable for automobile applications, Renesas products are not designed, manufactured or tested for applications or otherwise in systems the failure or malfunction of which may cause a direct threat to human life or create a risk of human injury or which require especially high quality and reliability such as safety systems, or equipment or systems for transportation and traffic, healthcare, combustion control, aerospace and aeronautics, nuclear power, or undersea communication transmission. If you are considering the use of our products for such purposes, please contact a Renesas sales office beforehand. Renesas shall have no liability for damages arising out of the uses set forth above.
8. Notwithstanding the preceding paragraph, you should not use Renesas products for the purposes listed below:
 - (1) artificial life support devices or systems
 - (2) surgical implantations
 - (3) healthcare intervention (e.g., excision, administration of medication, etc.)
 - (4) any other purposes that pose a direct threat to human lifeRenesas shall have no liability for damages arising out of the uses set forth in the above and purchasers who elect to use Renesas products in any of the foregoing applications shall indemnify and hold harmless Renesas Technology Corp., its affiliated companies and their officers, directors, and employees against any and all damages arising out of such applications.
9. You should use the products described herein within the range specified by Renesas, especially with respect to the maximum rating, operating supply voltage range, movement power voltage range, heat radiation characteristics, installation and other product characteristics. Renesas shall have no liability for malfunctions or damages arising out of the use of Renesas products beyond such specified ranges.
10. Although Renesas endeavors to improve the quality and reliability of its products, IC products have specific characteristics such as the occurrence of failure at a certain rate and malfunctions under certain use conditions. Please be sure to implement safety measures to guard against the possibility of physical injury, and injury or damage caused by fire in the event of the failure of a Renesas product, such as safety design for hardware and software including but not limited to redundancy, fire control and malfunction prevention, appropriate treatment for aging degradation or any other applicable measures. Among others, since the evaluation of microcomputer software alone is very difficult, please evaluate the safety of the final products or system manufactured by you.
11. In case Renesas products listed in this document are detached from the products to which the Renesas products are attached or affixed, the risk of accident such as swallowing by infants and small children is very high. You should implement safety measures so that Renesas products may not be easily detached from your products. Renesas shall have no liability for damages arising out of such detachment.
12. This document may not be reproduced or duplicated, in any form, in whole or in part, without prior written approval from Renesas.
13. Please contact a Renesas sales office if you have any questions regarding the information contained in this document, Renesas semiconductor products, or if you have any other inquiries.



RENESAS SALES OFFICES

<http://www.renesas.com>

Refer to "<http://www.renesas.com/en/network>" for the latest and detailed information.

Renesas Technology America, Inc.
450 Holger Way, San Jose, CA 95134-1368, U.S.A
Tel: <1> (408) 382-7500, Fax: <1> (408) 382-7501

Renesas Technology Europe Limited
Dukes Meadow, Millboard Road, Bourne End, Buckinghamshire, SL8 5FH, U.K.
Tel: <44> (1628) 585-100, Fax: <44> (1628) 585-900

Renesas Technology (Shanghai) Co., Ltd.
Unit 204, 205, AZIACenter, No.1233 Lujiazui Ring Rd, Pudong District, Shanghai, China 200120
Tel: <86> (21) 5877-1818, Fax: <86> (21) 6887-7898

Renesas Technology Hong Kong Ltd.
7th Floor, North Tower, World Finance Centre, Harbour City, 1 Canton Road, Tsimshatsui, Kowloon, Hong Kong
Tel: <852> 2265-6688, Fax: <852> 2730-6071

Renesas Technology Taiwan Co., Ltd.
10th Floor, No.99, Fushing North Road, Taipei, Taiwan
Tel: <886> (2) 2715-2888, Fax: <886> (2) 2713-2999

Renesas Technology Singapore Pte. Ltd.
1 Harbour Front Avenue, #06-10, Keppel Bay Tower, Singapore 098632
Tel: <65> 6213-0200, Fax: <65> 6278-8001

Renesas Technology Korea Co., Ltd.
Kukje Center Bldg. 18th Fl., 191, 2-ka, Hangang-ro, Yongsan-ku, Seoul 140-702, Korea
Tel: <82> (2) 796-3115, Fax: <82> (2) 796-2145

Renesas Technology Malaysia Sdn. Bhd
Unit 906, Block B, Menara Amcorp, Amcorp Trade Centre, No.18, Jalan Persiaran Barat, 46050 Petaling Jaya, Selangor Darul Ehsan, Malaysia
Tel: <603> 7955-9390, Fax: <603> 7955-9510