

To our customers,

Old Company Name in Catalogs and Other Documents

On April 1st, 2010, NEC Electronics Corporation merged with Renesas Technology Corporation, and Renesas Electronics Corporation took over all the business of both companies. Therefore, although the old company name remains in this document, it is a valid Renesas Electronics document. We appreciate your understanding.

Renesas Electronics website: <http://www.renesas.com>

April 1st, 2010
Renesas Electronics Corporation

Issued by: Renesas Electronics Corporation (<http://www.renesas.com>)

Send any inquiries to <http://www.renesas.com/inquiry>.

Notice

1. All information included in this document is current as of the date this document is issued. Such information, however, is subject to change without any prior notice. Before purchasing or using any Renesas Electronics products listed herein, please confirm the latest product information with a Renesas Electronics sales office. Also, please pay regular and careful attention to additional and different information to be disclosed by Renesas Electronics such as that disclosed through our website.
2. Renesas Electronics does not assume any liability for infringement of patents, copyrights, or other intellectual property rights of third parties by or arising from the use of Renesas Electronics products or technical information described in this document. No license, express, implied or otherwise, is granted hereby under any patents, copyrights or other intellectual property rights of Renesas Electronics or others.
3. You should not alter, modify, copy, or otherwise misappropriate any Renesas Electronics product, whether in whole or in part.
4. Descriptions of circuits, software and other related information in this document are provided only to illustrate the operation of semiconductor products and application examples. You are fully responsible for the incorporation of these circuits, software, and information in the design of your equipment. Renesas Electronics assumes no responsibility for any losses incurred by you or third parties arising from the use of these circuits, software, or information.
5. When exporting the products or technology described in this document, you should comply with the applicable export control laws and regulations and follow the procedures required by such laws and regulations. You should not use Renesas Electronics products or the technology described in this document for any purpose relating to military applications or use by the military, including but not limited to the development of weapons of mass destruction. Renesas Electronics products and technology may not be used for or incorporated into any products or systems whose manufacture, use, or sale is prohibited under any applicable domestic or foreign laws or regulations.
6. Renesas Electronics has used reasonable care in preparing the information included in this document, but Renesas Electronics does not warrant that such information is error free. Renesas Electronics assumes no liability whatsoever for any damages incurred by you resulting from errors in or omissions from the information included herein.
7. Renesas Electronics products are classified according to the following three quality grades: “Standard”, “High Quality”, and “Specific”. The recommended applications for each Renesas Electronics product depends on the product’s quality grade, as indicated below. You must check the quality grade of each Renesas Electronics product before using it in a particular application. You may not use any Renesas Electronics product for any application categorized as “Specific” without the prior written consent of Renesas Electronics. Further, you may not use any Renesas Electronics product for any application for which it is not intended without the prior written consent of Renesas Electronics. Renesas Electronics shall not be in any way liable for any damages or losses incurred by you or third parties arising from the use of any Renesas Electronics product for an application categorized as “Specific” or for which the product is not intended where you have failed to obtain the prior written consent of Renesas Electronics. The quality grade of each Renesas Electronics product is “Standard” unless otherwise expressly specified in a Renesas Electronics data sheets or data books, etc.
 - “Standard”: Computers; office equipment; communications equipment; test and measurement equipment; audio and visual equipment; home electronic appliances; machine tools; personal electronic equipment; and industrial robots.
 - “High Quality”: Transportation equipment (automobiles, trains, ships, etc.); traffic control systems; anti-disaster systems; anti-crime systems; safety equipment; and medical equipment not specifically designed for life support.
 - “Specific”: Aircraft; aerospace equipment; submersible repeaters; nuclear reactor control systems; medical equipment or systems for life support (e.g. artificial life support devices or systems), surgical implantations, or healthcare intervention (e.g. excision, etc.), and any other applications or purposes that pose a direct threat to human life.
8. You should use the Renesas Electronics products described in this document within the range specified by Renesas Electronics, especially with respect to the maximum rating, operating supply voltage range, movement power voltage range, heat radiation characteristics, installation and other product characteristics. Renesas Electronics shall have no liability for malfunctions or damages arising out of the use of Renesas Electronics products beyond such specified ranges.
9. Although Renesas Electronics endeavors to improve the quality and reliability of its products, semiconductor products have specific characteristics such as the occurrence of failure at a certain rate and malfunctions under certain use conditions. Further, Renesas Electronics products are not subject to radiation resistance design. Please be sure to implement safety measures to guard them against the possibility of physical injury, and injury or damage caused by fire in the event of the failure of a Renesas Electronics product, such as safety design for hardware and software including but not limited to redundancy, fire control and malfunction prevention, appropriate treatment for aging degradation or any other appropriate measures. Because the evaluation of microcomputer software alone is very difficult, please evaluate the safety of the final products or system manufactured by you.
10. Please contact a Renesas Electronics sales office for details as to environmental matters such as the environmental compatibility of each Renesas Electronics product. Please use Renesas Electronics products in compliance with all applicable laws and regulations that regulate the inclusion or use of controlled substances, including without limitation, the EU RoHS Directive. Renesas Electronics assumes no liability for damages or losses occurring as a result of your noncompliance with applicable laws and regulations.
11. This document may not be reproduced or duplicated, in any form, in whole or in part, without prior written consent of Renesas Electronics.
12. Please contact a Renesas Electronics sales office if you have any questions regarding the information contained in this document or Renesas Electronics products, or if you have any other inquiries.

(Note 1) “Renesas Electronics” as used in this document means Renesas Electronics Corporation and also includes its majority-owned subsidiaries.

(Note 2) “Renesas Electronics product(s)” means any product developed or manufactured by or for Renesas Electronics.

LASER DIODE
NX8564/8565/8566LE Series

**EA MODULATOR INTEGRATED
 1 550 nm MQW-DFB LASER DIODE MODULE FOR
 2.5 Gb/s DWDM ULTRALONG-REACH 360 km, 600 km, 240 km APPLICATIONS**

DESCRIPTION

The NX8564/8565/8566LE Series is an Electro-Absorption (EA) modulator integrated, 1 550 nm Multiple Quantum Well (MQW) structured Distributed Feed-Back (DFB) laser diode. The module is capable of 2.5 Gb/s applications of over 360 km, 600 km, 240 km ultralong-reach and available for Dense Wavelength Division Multiplexing (DWDM) wavelengths based on ITU-T recommendations, enabling a wide range of applications.

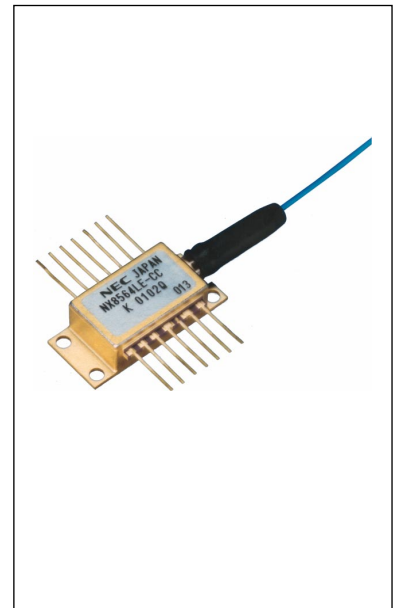

FEATURES

- Integrated electroabsorption modulator
- Very low dispersion penalty (over 360 km (6480 ps/nm), NX8564LE-BC/CC)
 (over 600 km (10800 ps/nm), NX8565LE-BC/CC)
 (over 240 km (4320 ps/nm), NX8566LE-BC/CC)
- Low modulation voltage
- Available for DWDM wavelengths based on ITU-T recommendations (100 GHz grid, refer to **ORDERING INFORMATION**)

The information in this document is subject to change without notice. Before using this document, please confirm that this is the latest version.
 Not all devices/types available in every country. Please check with local NEC Compound Semiconductor Devices representative for availability and additional information.

★ PACKAGE DIMENSIONS (UNIT: mm, unless otherwise specified ±0.2 mm)

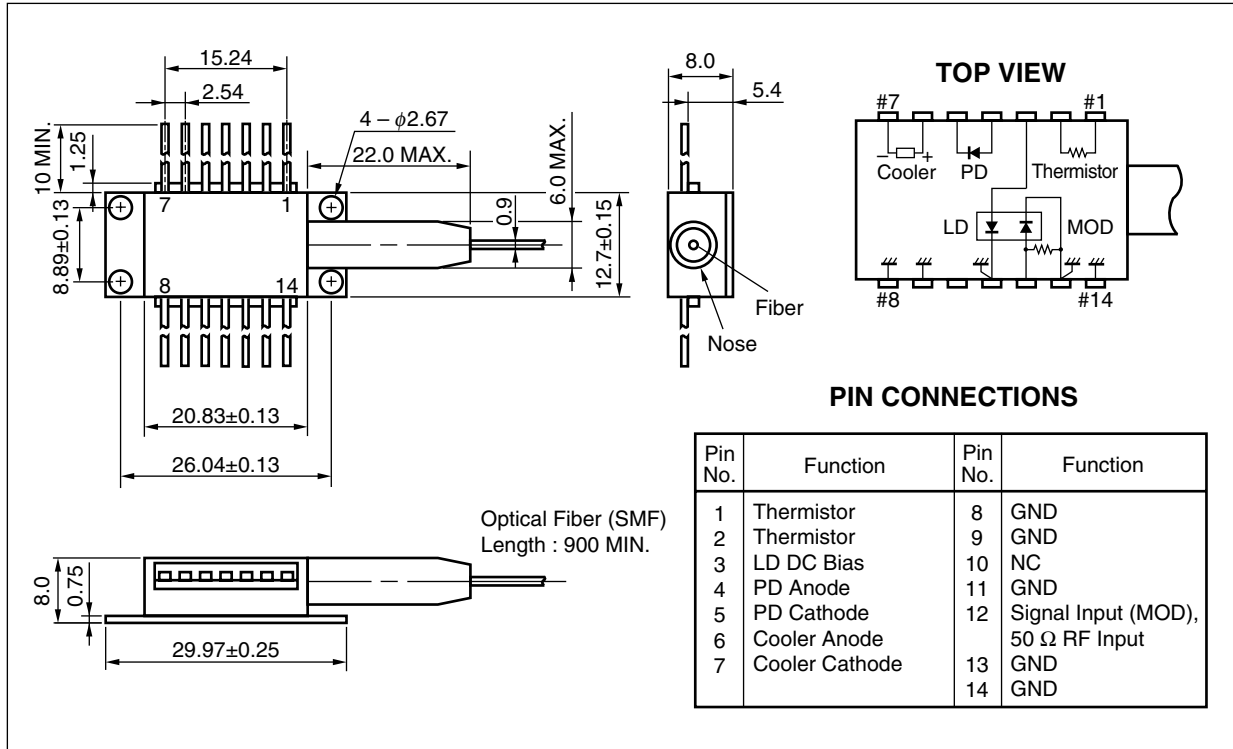

OPTICAL FIBER CHARACTERISTICS

Parameter	Specification	Unit
Mode Field Diameter	9.3±0.5	μm
Cladding Diameter	125±1	μm
Tight Buffer Diameter	900±100	μm
Cut-off Wavelength	< 1 270	nm
Attenuation 1 525 to 1 575 nm	< 0.3	dB/km
Minimum Fiber Bending Radius	30	mm
★ Fiber Length	900 MIN.	mm
Flammability	UL1581 VW-1	

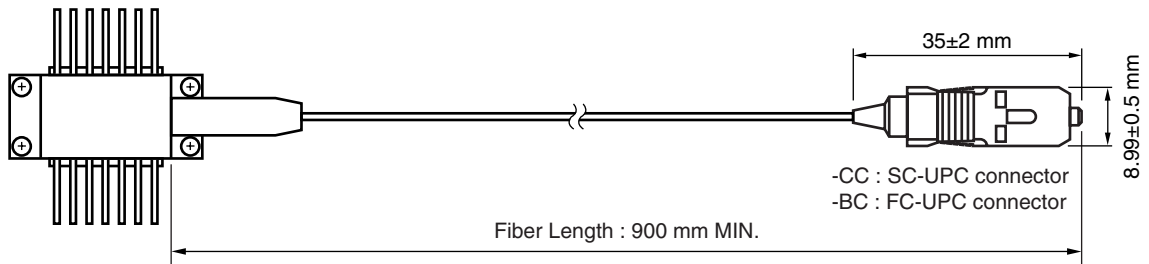

ORDERING INFORMATION

NX856□LE□□□-□□

- CC : SC-UPC connector
- BC : FC-UPC connector (option)
- Without wavelength code : Wavelength is a certain point between 1528 to 1565 nm, 1579 to 1609 nm
- With wavelength code : Refer to **Table A**
- 4 : 360 km (6480 ps/nm)
- 5 : 600 km (10800 ps/nm)
- 6 : 240 km (4320 ps/nm)

Table A: DWDM wavelengths based on ITU-T recommendations (@T_{LD} = T_{set}) (1/2)

Wavelength Code	ITU-T Wavelength ^{*1} (nm)	Frequency (THz)	Wavelength Code	ITU-T Wavelength ^{*1} (nm)	Frequency (THz)
287	1528.77	196.10	485	1548.51	193.60
295	1529.55	196.00	493	1549.31	193.50
303	1530.33	195.90	501	1550.11	193.40
311	1531.11	195.80	509	1550.91	193.30
318	1531.89	195.70	517	1551.72	193.20
326	1532.68	195.60	525	1552.52	193.10
334	1533.46	195.50	533	1553.32	193.00
342	1534.25	195.40	541	1554.13	192.90
350	1535.03	195.30	549	1554.94	192.80
358	1535.82	195.20	557	1555.74	192.70
366	1536.60	195.10	565	1556.55	192.60
373	1537.39	195.00	573	1557.36	192.50
381	1538.18	194.90	581	1558.17	192.40
389	1538.97	194.80	589	1558.98	192.30
397	1539.76	194.70	597	1559.79	192.20
405	1540.55	194.60	606	1560.60	192.10
413	1541.34	194.50	614	1561.41	192.00
421	1542.14	194.40	622	1562.23	191.90
429	1542.93	194.30	630	1563.04	191.80
437	1543.73	194.20	745	1574.54	190.40
445	1544.52	194.10	753	1575.36	190.30
453	1545.32	194.00	761	1576.19	190.20
461	1546.11	193.90	770	1577.02	190.10
469	1546.91	193.80	778	1577.85	190.00
477	1547.71	193.70	786	1578.68	189.90

*1 The value which omitted and computed the 3rd place below the decimal point

Table A: DWDM wavelengths based on ITU-T recommendations (@T_{LD} = T_{set}) (2/2)

Wavelength Code	ITU-T Wavelength ^{*1} (nm)	Frequency (THz)	Wavelength Code	ITU-T Wavelength ^{*1} (nm)	Frequency (THz)
795	1579.51	189.80	946	1594.64	188.00
803	1580.35	189.70	954	1595.48	187.90
811	1581.18	189.60	963	1596.33	187.80
820	1582.01	189.50	971	1597.18	187.70
828	1582.85	189.40	980	1598.04	187.60
836	1583.69	189.30	988	1598.89	187.50
845	1584.52	189.20	997	1599.74	187.40
853	1585.36	189.10	6006	1600.60	187.30
862	1586.20	189.00	6014	1601.45	187.20
870	1587.04	188.90	6023	1602.31	187.10
878	1587.88	188.80	6031	1603.16	187.00
887	1588.72	188.70	6040	1604.02	186.90
895	1589.56	188.60	6048	1604.88	186.80
904	1590.41	188.50	6057	1605.74	186.70
912	1591.25	188.40	6066	1606.60	186.60
921	1592.10	188.30	6074	1607.46	186.50
929	1592.94	188.20	6083	1608.32	186.40
937	1593.79	188.10			

*1 The value which omitted and computed the 3rd place below the decimal point

ABSOLUTE MAXIMUM RATINGS

Parameter	Symbol	Ratings	Unit
Optical Output Power from Fiber	P_f	10	mW
Forward Current of LD	I_{FLD}	150	mA
Reverse Voltage of LD	V_{RLD}	2.0	V
Forward Voltage of Modulator	V_{FEA}	1	V
Reverse Voltage of Modulator	V_{REA}	5	V
Forward Current of PD	I_{FPD}	1	mA
Reverse Voltage of PD	V_{RPD}	10	V
Cooler Current	I_c	1.5	A
Cooler Voltage	V_c	2.5	V
Operating Case Temperature	T_c	-20 to +70	°C
Storage Temperature	T_{stg}	-40 to +85	°C
Lead Soldering Temperature	T_{sld}	260 (10 sec.)	°C

ELECTRO-OPTICAL CHARACTERISTICS (T_{LD} = T_{set}, T_c = -20 to +70°C, unless otherwise specified)

Parameter	Symbol	Conditions	MIN.	TYP.	MAX.	Unit
Laser Set Temperature	T _{set}	*1	20		35	°C
Operating Current	I _{op}		50	60	80	mA
Modulation Center Voltage	V _{center}	Under modulation ²	-1.5	-1.2	-0.5	V
Modulation Voltage	V _{mod}	Under modulation ²		2	3	V
Forward Voltage of LD	V _{FLD}	I _{FLD} = I _{op}		1.6	2.0	V
Threshold Current	I _{th}			7	20	mA
Optical Output Power from Fiber	P _f	I _{FLD} = I _{op} , Under modulation ² (NX8564/65LE Series)	-5	-2		dBm
		I _{FLD} = I _{op} , Under modulation ² (NX8566LE Series)	0	1		
Peak Emission Wavelength	λ _p	I _{FLD} = I _{op} , V _{EA} = 0 V	1 528	ITU-T ³	1 565	nm
			1 574		1 609	
Side Mode Suppression Ratio	SMSR	I _{FLD} = I _{op} , V _{EA} = 0 V	30	> 37		dB
Extinction Ratio	ER	I _{FLD} = I _{op} , Under modulation ²	10	> 11		dB
Rise Time	t _r	I _{FLD} = I _{op} , 20-80%, Under modulation ²		70	125	ps
Fall Time	t _f	I _{FLD} = I _{op} , 80-20%, Under modulation ²		70	125	ps
Dispersion Penalty	DP	I _{FLD} = I _{op} , Under modulation ^{2,4}		< 1.5	2.0	dB
Isolation	I _s		23			dB
Relative Intensity Noise	RIN	10 MHz to 10 GHz, V _{EA} = 0 V, I _{FLD} = I _{op}		< -135	-130	dB/Hz
Input Return Loss	S ₁₁	I _{FLD} = I _{op} , V _{EA} = -1 V, 50 Ω, f = 130 MHz to 2 GHz			-8	dB
		I _{FLD} = I _{op} , V _{EA} = -1 V, 50 Ω, f = 2 to 2.5 GHz			-5	

- *1 NX8564/65/66LE Series : T_{set} is a certain point between 20 and 35°C
 NX8564/65/66LE××× Series : T_{set} is set at a certain point between 20 and 35°C for ITU-T grid wavelength
- *2 NX8564LE : C-band 360 km, L-band 288 km (6480 ps/nm) SMF under modulation
 NX8565LE : C-band 600 km, L-band 480 km (10800 ps/nm) SMF under modulation
 NX8566LE : C-band 240 km, L-band 192 km (4320 ps/nm) SMF under modulation
 2.48832 Gb/s, PRBS 2²³-1, V_{EA} = V_{center} ± 1/2V_{mod}, I_{FLD} = I_{op}, T_{LD} = T_{set}, NEC Test System
 V_{center} : a certain point between -1.5 and -0.5 V
 V_{mod} : a certain point 3 V or below
 I_{op} : a certain point between 50 and 80 mA
- *3 Available for DWDM wavelengths based on ITU-T recommendations (100 GHz grid).
 Please refer to **ORDERING INFORMATION**.
- *4 BER = 10⁻¹⁰

ELECTRO-OPTICAL CHARACTERISTICS (Applicable to Monitor PD: $T_{LD} = T_{set}$, $T_c = -20$ to $+70^\circ\text{C}$)

Parameter	Symbol	Conditions	MIN.	TYP.	MAX.	Unit
Monitor Current	I_m	$V_{RPD} = 5\text{ V}$, $I_{FLD} = I_{op}$, $V_{EA} = 0\text{ V}$	20	100	1 000	μA
Dark Current	I_D	$V_{RPD} = 5\text{ V}$, $V_{EA} = 0\text{ V}$			10	nA
Terminal Capacitance	C_t	$V_{RPD} = 5\text{ V}$, $f = 1\text{ MHz}$			15	pF
Tracking Error	γ^*	$I_m = \text{const.}$			0.5	dB

*1 Tracking Error: γ

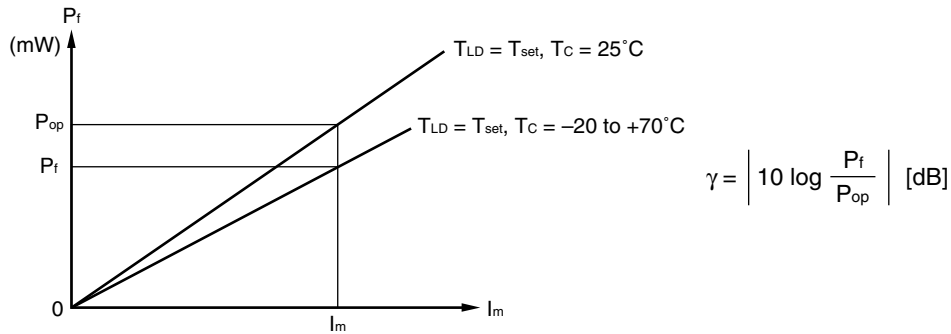

★ **ELECTRO-OPTICAL CHARACTERISTICS (Applicable to Thermistor and TEC: $T_c = -20$ to $+70^\circ\text{C}$)**

Parameter	Symbol	Conditions	MIN.	TYP.	MAX.	Unit
Thermistor Resistance	R	$T_{LD} = 25^\circ\text{C}$	9.5	10.0	10.5	$\text{k}\Omega$
B Constant	B		3 350	3 450	3 550	K
TEC Current	I_c	$T_{LD} = T_{set}$			1.2	A
TEC Voltage	V_c	$T_{LD} = T_{set}$			2.4	V

TYPICAL CHARACTERISTICS ($T_{LD} = T_{set}$, $T_c = 25^\circ\text{C}$, unless otherwise specified)

OPTICAL OUTPUT POWER FROM FIBER (CW) vs. FORWARD CURRENT

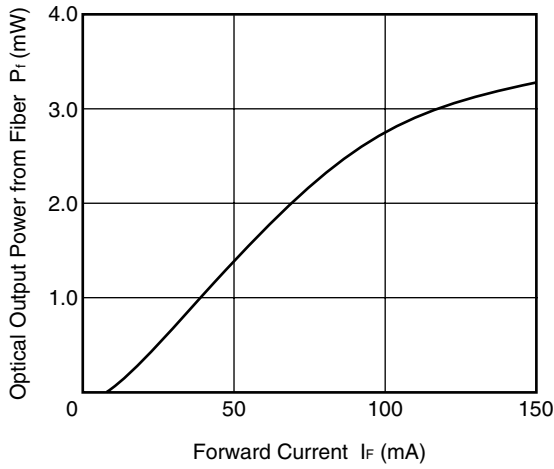

FORWARD CURRENT vs. FORWARD VOLTAGE

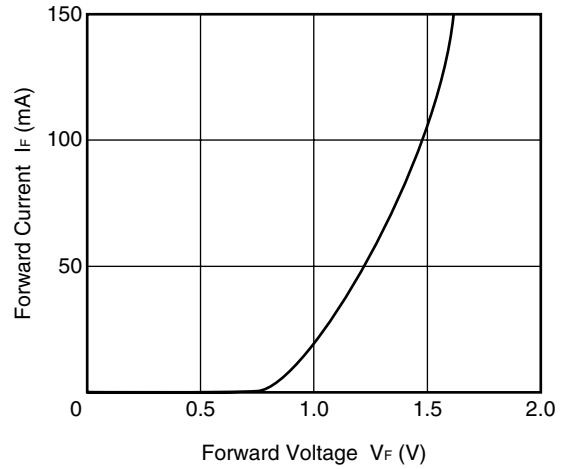

EXTINCTION RATIO vs. MODULATOR VOLTAGE

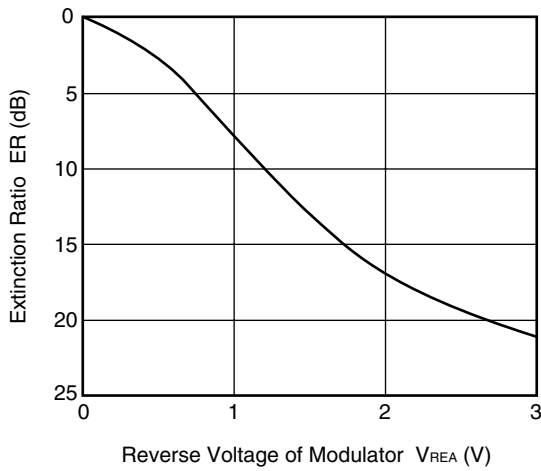

SPECTRUM

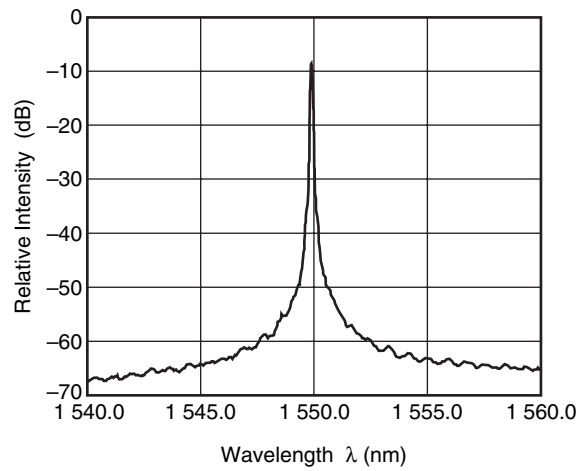

THERMISTOR RESISTANCE vs. AMBIENT TEMPERATURE

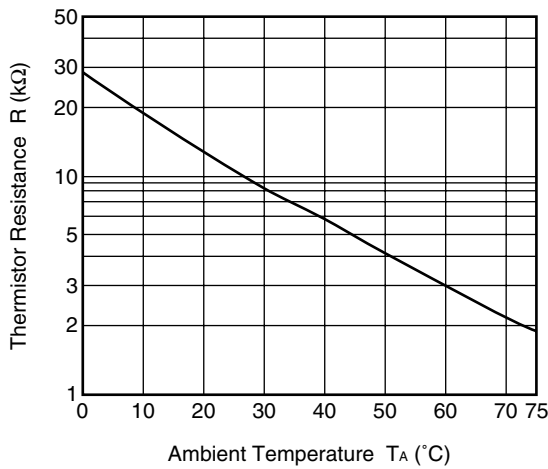

Remark The graphs indicate nominal characteristics.

600 km STANDARD FIBER TRANSMISSION EXAMPLE (NX8565LE Series)

Test Setup

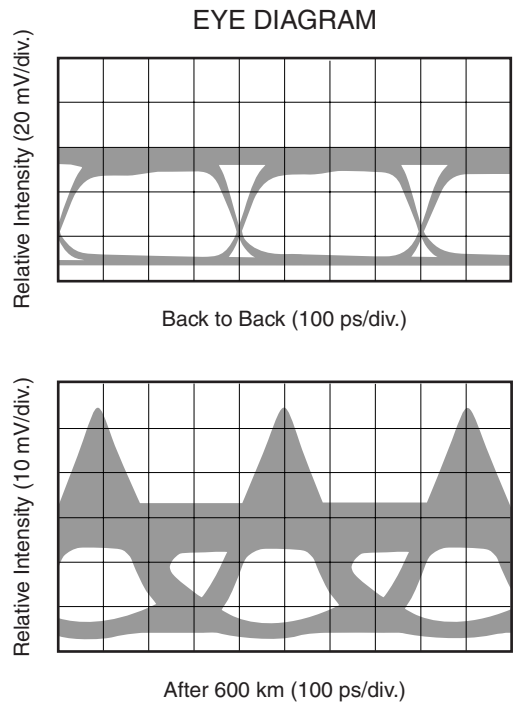
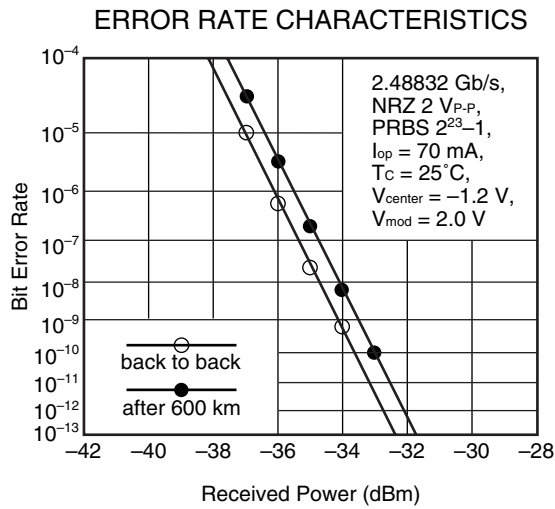
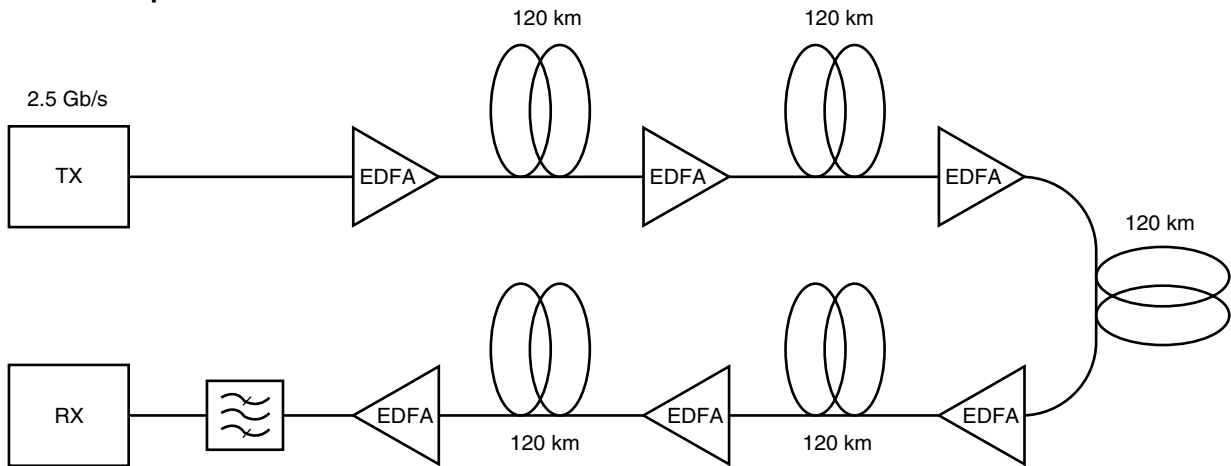

Remark The graphs indicate nominal characteristics.

EA MODULATOR INTEGRATED DFB-LD FAMILY

Part Number	Absolute Maximum Ratings		Electro-Optical Characteristics		Application	Package
	T _c (°C)	T _{stg} (°C)	P _{r1} [*] (mW)	λ _p (nm)		
			MIN.	TYP.		
★ NX8560LJ Series	-20 to +70	-40 to +85	-3 dBm	1 550 ^{*2}	10 Gb/s: STM-64	BFY with GPO™
			-1 dBm	1 550		
NX8560MC Series	0 to +75	-40 to +85	-1 dBm	1 550	10 Gb/s: STM-64	19-pin mini BFY
NX8560MCS Series	0 to +75	-40 to +85	-5 dBm	1 550	10 Gb/s: STM-64	19-pin mini BFY
NX8560SJ Series	-5 to +70	-40 to +85	-3 dBm	1 550 ^{*2}	10 Gb/s: STM-64 with λ monitoring PD	BFY with GPO
NX8564LE Series	-20 to +70	-40 to +85	-5 dBm	1 550 ^{*2}	2.5 Gb/s: STM-16, 360 km	BFY
NX8565LE Series	-20 to +70	-40 to +85	-5 dBm	1 550 ^{*2}	2.5 Gb/s: STM-16, 600 km	BFY
NX8566LE Series	-20 to +70	-40 to +85	0 dBm	1 550 ^{*2}	2.5 Gb/s: STM-16, 240 km	BFY
NX8567SA Series	-5 to +70	-40 to +85	-5 dBm	1 550 ^{*2}	2.5 Gb/s: STM-16, 600 km with λ monitoring PD	BFY
NX8567SAM Series	-5 to +70	-40 to +85	-5 dBm	1 550 ^{*2}	2.5 Gb/s: STM-16, 360 km with λ monitoring PD	BFY
NX8567SAS Series	-5 to +70	-40 to +85	0 dBm	1 550 ^{*2}	2.5 Gb/s: STM-16, 240 km with λ monitoring PD	BFY

*1 Under modulation

*2 Available for DWDM Wavelengths based on ITU-T recommendations

REFERENCE

Document Name	Document No.
OPTICAL SEMICONDUCTOR DEVICES FOR FIBEROPTIC COMMUNICATIONS SELECTION GUIDE	PL10161E
Opto-Electronics Devices Pamphlet	PX10160E

- **PATENT**
 USP 4,826,295
 CA 1,286,848
 EP 143 000

- **GPO is a trademark of Gilbert Engineering Co., Inc.**

- **The information in this document is current as of January, 2004. The information is subject to change without notice. For actual design-in, refer to the latest publications of NEC's data sheets or data books, etc., for the most up-to-date specifications of NEC semiconductor products. Not all products and/or types are available in every country. Please check with an NEC sales representative for availability and additional information.**
- No part of this document may be copied or reproduced in any form or by any means without prior written consent of NEC. NEC assumes no responsibility for any errors that may appear in this document.
- NEC does not assume any liability for infringement of patents, copyrights or other intellectual property rights of third parties by or arising from the use of NEC semiconductor products listed in this document or any other liability arising from the use of such products. No license, express, implied or otherwise, is granted under any patents, copyrights or other intellectual property rights of NEC or others.
- Descriptions of circuits, software and other related information in this document are provided for illustrative purposes in semiconductor product operation and application examples. The incorporation of these circuits, software and information in the design of customer's equipment shall be done under the full responsibility of customer. NEC assumes no responsibility for any losses incurred by customers or third parties arising from the use of these circuits, software and information.
- While NEC endeavours to enhance the quality, reliability and safety of NEC semiconductor products, customers agree and acknowledge that the possibility of defects thereof cannot be eliminated entirely. To minimize risks of damage to property or injury (including death) to persons arising from defects in NEC semiconductor products, customers must incorporate sufficient safety measures in their design, such as redundancy, fire-containment, and anti-failure features.
- NEC semiconductor products are classified into the following three quality grades:
 "Standard", "Special" and "Specific". The "Specific" quality grade applies only to semiconductor products developed based on a customer-designated "quality assurance program" for a specific application. The recommended applications of a semiconductor product depend on its quality grade, as indicated below. Customers must check the quality grade of each semiconductor product before using it in a particular application.
 "Standard": Computers, office equipment, communications equipment, test and measurement equipment, audio and visual equipment, home electronic appliances, machine tools, personal electronic equipment and industrial robots
 "Special": Transportation equipment (automobiles, trains, ships, etc.), traffic control systems, anti-disaster systems, anti-crime systems, safety equipment and medical equipment (not specifically designed for life support)
 "Specific": Aircraft, aerospace equipment, submersible repeaters, nuclear reactor control systems, life support systems and medical equipment for life support, etc.

The quality grade of NEC semiconductor products is "Standard" unless otherwise expressly specified in NEC's data sheets or data books, etc. If customers wish to use NEC semiconductor products in applications not intended by NEC, they must contact an NEC sales representative in advance to determine NEC's willingness to support a given application.

(Note)

- (1) "NEC" as used in this statement means NEC Corporation, NEC Compound Semiconductor Devices, Ltd. and also includes its majority-owned subsidiaries.
- (2) "NEC semiconductor products" means any semiconductor product developed or manufactured by or for NEC (as defined above).

M8E 00.4-0110

SAFETY INFORMATION ON THIS PRODUCT

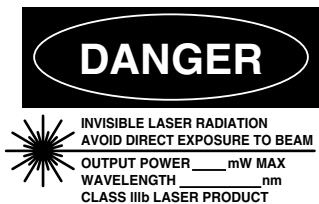

SEMICONDUCTOR LASER

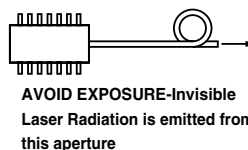

<p>Warning Laser Beam</p>	<p>A laser beam is emitted from this diode during operation. The laser beam, visible or invisible, directly or indirectly, may cause injury to the eye or loss of eyesight.</p> <ul style="list-style-type: none"> • Do not look directly into the laser beam. • Avoid exposure to the laser beam, any reflected or collimated beam.
<p>Caution GaAs Products</p>	<p>This product uses gallium arsenide (GaAs). GaAs vapor and powder are hazardous to human health if inhaled or ingested, so please observe the following points.</p> <ul style="list-style-type: none"> • Follow related laws and ordinances when disposing of the product. If there are no applicable laws and/or ordinances, dispose of the product as recommended below. <ol style="list-style-type: none"> 1. Commission a disposal company able to (with a license to) collect, transport and dispose of materials that contain arsenic and other such industrial waste materials. 2. Exclude the product from general industrial waste and household garbage, and ensure that the product is controlled (as industrial waste subject to special control) up until final disposal. • Do not burn, destroy, cut, crush, or chemically dissolve the product. • Do not lick the product or in any way allow it to enter the mouth.
<p>Caution Optical Fiber</p>	<p>A glass-fiber is attached on the product. Handle with care.</p> <ul style="list-style-type: none"> • When the fiber is broken or damaged, handle carefully to avoid injury from the damaged part or fragments.

► For further information, please contact

NEC Compound Semiconductor Devices, Ltd. <http://www.ncsd.necel.com/>
 E-mail: salesinfo@ml.ncsd.necel.com (sales and general)
 techinfo@ml.ncsd.necel.com (technical)
 5th Sales Group, Sales Division TEL: +81-44-435-1588 FAX: +81-44-435-1579

NEC Compound Semiconductor Devices Hong Kong Limited
 E-mail: ncsd-hk@elhk.nec.com.hk (sales, technical and general)
 Hong Kong Head Office TEL: +852-3107-7303 FAX: +852-3107-7309
 Taipei Branch Office TEL: +886-2-8712-0478 FAX: +886-2-2545-3859
 Korea Branch Office TEL: +82-2-558-2120 FAX: +82-2-558-5209

NEC Electronics (Europe) GmbH <http://www.ee.nec.de/>
 TEL: +49-211-6503-01 FAX: +49-211-6503-487

California Eastern Laboratories, Inc. <http://www.cel.com/>
 TEL: +1-408-988-3500 FAX: +1-408-988-0279