

N0201R

R07DS0718EJ0100

Rev.1.00

PNP SILICON EPITAXIAL TRANSISTOR

Mar 30, 2012

FEATURES

- Complements to N0201S.
- $V_{CE0} = -25\text{ V}$
- $I_{C(DC)} = -1.0\text{ A}$
- Miniature package SOT-23F (2SB798: Package variation of 3pPoMM)

PRODUCT LINEUP

Part Number	Packing	Package Name	Package Code	Mass [TYP.]
N0201R-T1-AT	Tape 3000p/reel	SOT-23F	PVSF0003ZA-A	0.0126g

ABSOLUTE MAXIMUM RATINGS ($T_a = 25^\circ\text{C}$)

Parameter	Symbol	Ratings	Unit
Collector to Base Voltage	V_{CBO}	-30	V
Collector to Emitter Voltage	V_{CEO}	-25	V
Emitter to Base Voltage	V_{EBO}	-5.0	V
Collector Current (DC)	$I_{C(DC)}$	-1.0	A
Collector Current (pulse) *1	$I_{C(pulse)}$	-1.5	A
Total Power Dissipation	P_{T1}	0.2	W
Total Power Dissipation *2	P_{T2}	1.0	W
Junction Temperature	T_j	150	$^\circ\text{C}$
Storage Temperature	T_{stg}	-55 to +150	$^\circ\text{C}$

 Note *1. $PW \leq 10\text{ ms}$, Duty Cycle $\leq 50\%$

 *2. FR-4 board size $2500\text{ mm}^2 \times 1.6\text{ mm}$, $t \leq 5\text{ sec}$

ELECTRICAL CHARACTERISTICS ($T_a = 25^\circ\text{C}$)

Parameter	Symbol	Condition	MIN.	TYP.	MAX.	Unit
Collector Cutoff Current	I_{CBO}	$V_{CB} = -30\text{ V}$, $I_E = 0$			-100	nA
Emitter Cutoff Current	I_{EBO}	$V_{EB} = -5.0\text{ V}$, $I_C = 0$			-100	nA
DC Current Gain	h_{FE1}^{*1}	$V_{CE} = -1.0\text{ V}$, $I_C = -100\text{ mA}$	90	200	400	
DC Current Gain	h_{FE2}^{*1}	$V_{CE} = -1.0\text{ V}$, $I_C = -1.0\text{ A}$	50	100		
Collector Saturation Voltage	$V_{CE(sat)}^{*1}$	$I_C = -1.0\text{ A}$, $I_B = -100\text{ mA}$		-0.25	-0.4	V
Base Saturation Voltage	$V_{BE(sat)}^{*1}$	$I_C = -1.0\text{ A}$, $I_B = -100\text{ mA}$		-1.0	-1.2	V
Base to Emitter Voltage	V_{BE}^{*1}	$V_{CE} = -6.0\text{ V}$, $I_C = -10\text{ mA}$	-600	-640	-700	mV
Gain Bandwidth Product	f_T	$V_{CE} = -6.0\text{ V}$, $I_E = 10\text{ mA}$		90		MHz
Output Capacitance	C_{ob}	$V_{CB} = -10.0\text{ V}$, $I_E = 0$, $f = 1.0\text{ MHz}$		27		pF

Note *1. Pulsed

h_{FE} Classification

Marking	DM	DL	DK
h_{FE1}	90 to 180	135 to 270	200 to 400

TYPICAL CHARACTERISTICS ($T_a = 25^\circ\text{C}$)

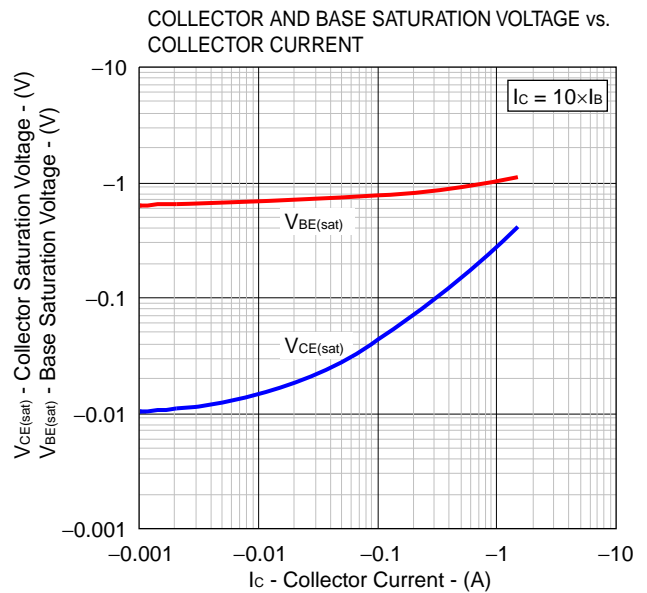
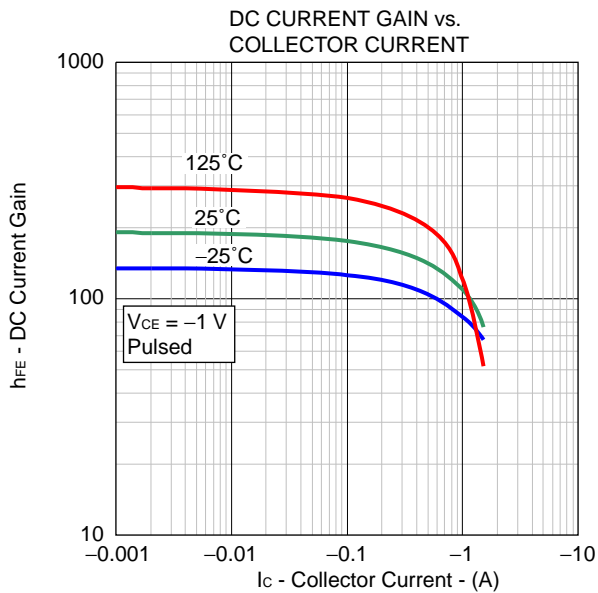
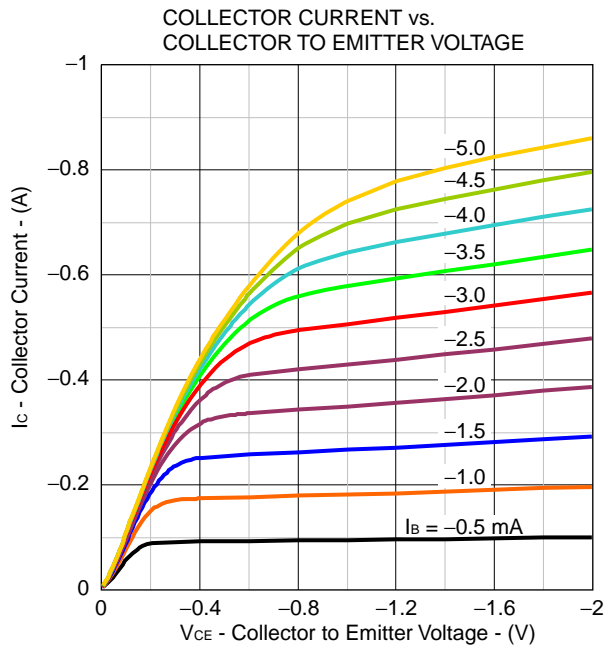
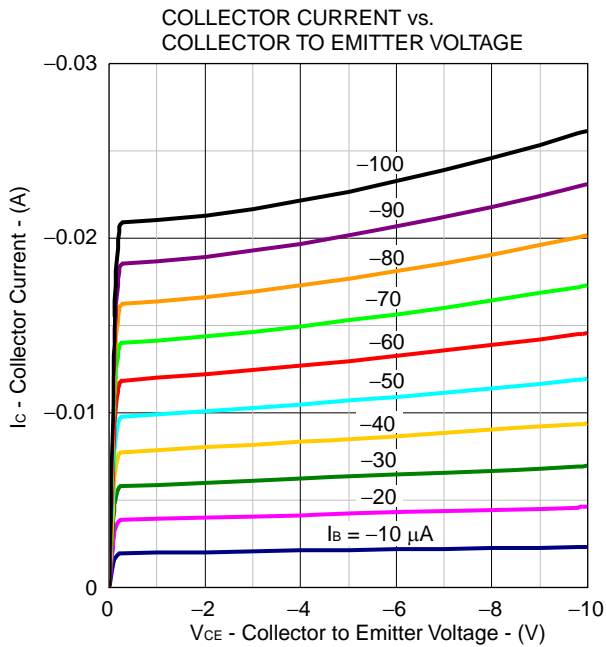
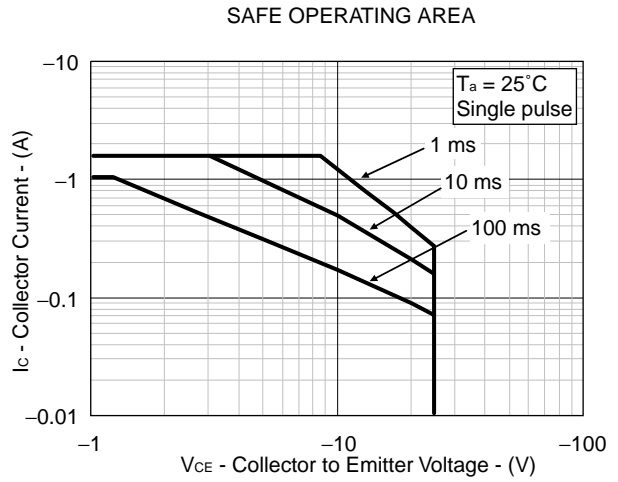
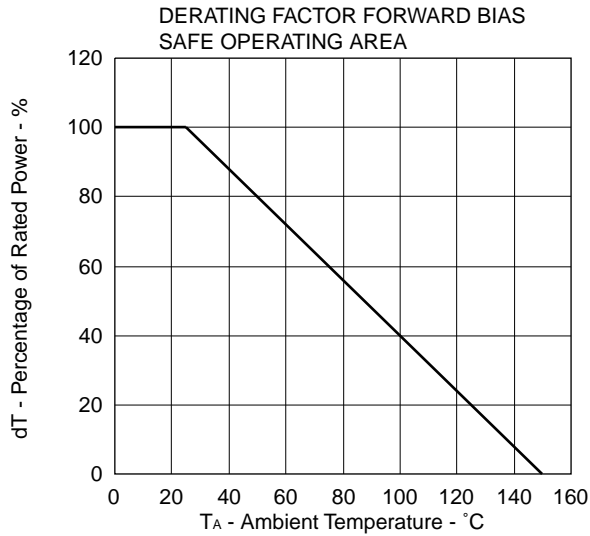

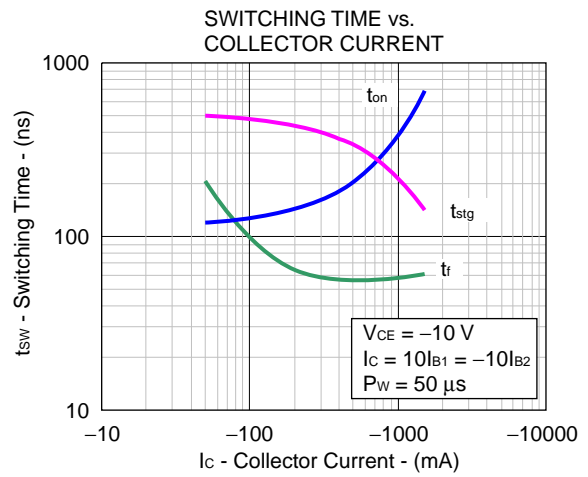
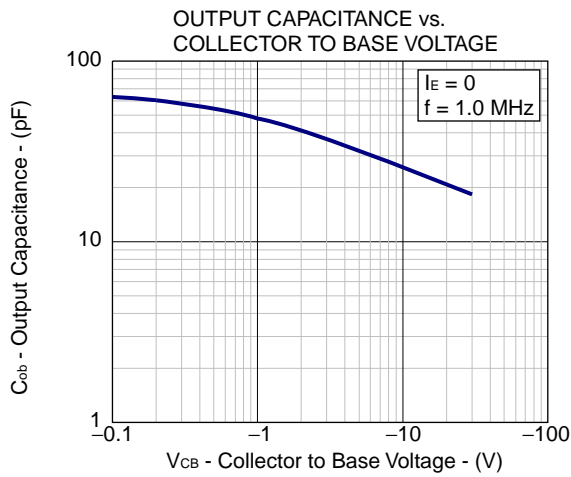
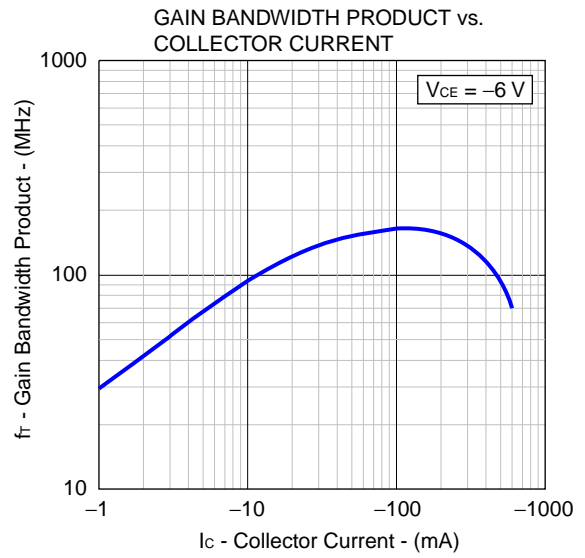
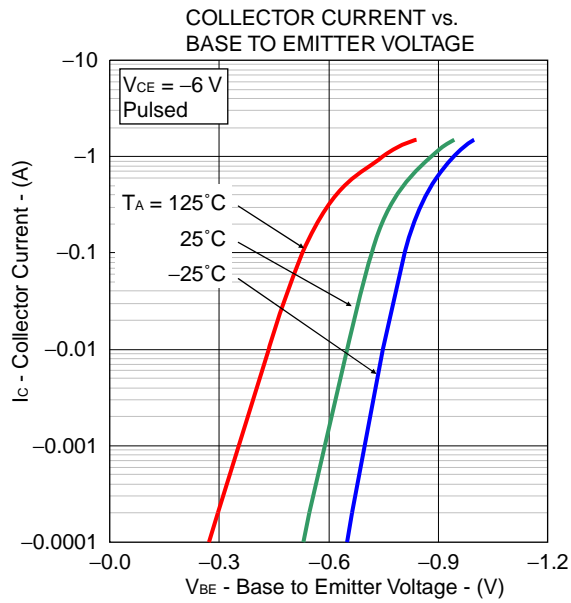

PACKAGE DRAWING (Unit: mm)

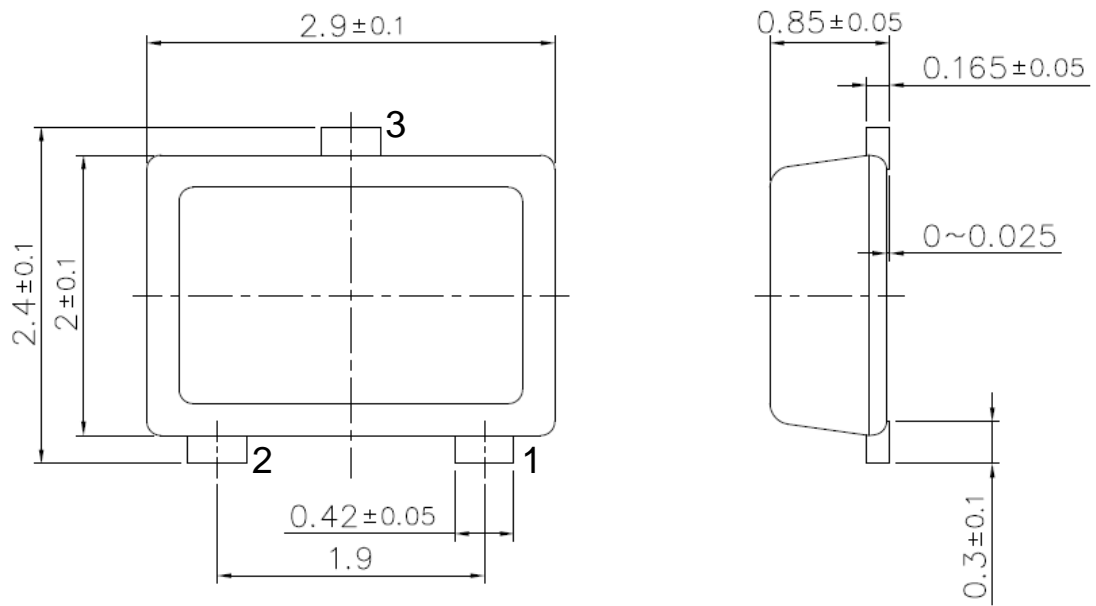

- 1: Emitter
- 2: Base
- 3: Collector

Notice

- All information included in this document is current as of the date this document is issued. Such information, however, is subject to change without any prior notice. Before purchasing or using any Renesas Electronics products listed herein, please confirm the latest product information with a Renesas Electronics sales office. Also, please pay regular and careful attention to additional and different information to be disclosed by Renesas Electronics such as that disclosed through our website.
- Renesas Electronics does not assume any liability for infringement of patents, copyrights, or other intellectual property rights of third parties by or arising from the use of Renesas Electronics products or technical information described in this document. No license, express, implied or otherwise, is granted hereby under any patents, copyrights or other intellectual property rights of Renesas Electronics or others.
- You should not alter, modify, copy, or otherwise misappropriate any Renesas Electronics product, whether in whole or in part.
- Descriptions of circuits, software and other related information in this document are provided only to illustrate the operation of semiconductor products and application examples. You are fully responsible for the incorporation of these circuits, software, and information in the design of your equipment. Renesas Electronics assumes no responsibility for any losses incurred by you or third parties arising from the use of these circuits, software, or information.
- When exporting the products or technology described in this document, you should comply with the applicable export control laws and regulations and follow the procedures required by such laws and regulations. You should not use Renesas Electronics products or the technology described in this document for any purpose relating to military applications or use by the military, including but not limited to the development of weapons of mass destruction. Renesas Electronics products and technology may not be used for or incorporated into any products or systems whose manufacture, use, or sale is prohibited under any applicable domestic or foreign laws or regulations.
- Renesas Electronics has used reasonable care in preparing the information included in this document, but Renesas Electronics does not warrant that such information is error free. Renesas Electronics assumes no liability whatsoever for any damages incurred by you resulting from errors in or omissions from the information included herein.
- Renesas Electronics products are classified according to the following three quality grades: "Standard", "High Quality", and "Specific". The recommended applications for each Renesas Electronics product depends on the product's quality grade, as indicated below. You must check the quality grade of each Renesas Electronics product before using it in a particular application. You may not use any Renesas Electronics product for any application categorized as "Specific" without the prior written consent of Renesas Electronics. Further, you may not use any Renesas Electronics product for any application for which it is not intended without the prior written consent of Renesas Electronics. Renesas Electronics shall not be in any way liable for any damages or losses incurred by you or third parties arising from the use of any Renesas Electronics product for an application categorized as "Specific" or for which the product is not intended where you have failed to obtain the prior written consent of Renesas Electronics. The quality grade of each Renesas Electronics product is "Standard" unless otherwise expressly specified in a Renesas Electronics data sheets or data books, etc.
"Standard": Computers; office equipment; communications equipment; test and measurement equipment; audio and visual equipment; home electronic appliances; machine tools; personal electronic equipment; and industrial robots.
"High Quality": Transportation equipment (automobiles, trains, ships, etc.); traffic control systems; anti-disaster systems; anti-crime systems; safety equipment; and medical equipment not specifically designed for life support.
"Specific": Aircraft; aerospace equipment; submersible repeaters; nuclear reactor control systems; medical equipment or systems for life support (e.g. artificial life support devices or systems), surgical implantations, or healthcare intervention (e.g. excision, etc.), and any other applications or purposes that pose a direct threat to human life.
- You should use the Renesas Electronics products described in this document within the range specified by Renesas Electronics, especially with respect to the maximum rating, operating supply voltage range, movement power voltage range, heat radiation characteristics, installation and other product characteristics. Renesas Electronics shall have no liability for malfunctions or damages arising out of the use of Renesas Electronics products beyond such specified ranges.
- Although Renesas Electronics endeavors to improve the quality and reliability of its products, semiconductor products have specific characteristics such as the occurrence of failure at a certain rate and malfunctions under certain use conditions. Further, Renesas Electronics products are not subject to radiation resistance design. Please be sure to implement safety measures to guard them against the possibility of physical injury, and injury or damage caused by fire in the event of the failure of a Renesas Electronics product, such as safety design for hardware and software including but not limited to redundancy, fire control and malfunction prevention, appropriate treatment for aging degradation or any other appropriate measures. Because the evaluation of microcomputer software alone is very difficult, please evaluate the safety of the final products or system manufactured by you.
- Please contact a Renesas Electronics sales office for details as to environmental matters such as the environmental compatibility of each Renesas Electronics product. Please use Renesas Electronics products in compliance with all applicable laws and regulations that regulate the inclusion or use of controlled substances, including without limitation, the EU RoHS Directive. Renesas Electronics assumes no liability for damages or losses occurring as a result of your noncompliance with applicable laws and regulations.
- This document may not be reproduced or duplicated, in any form, in whole or in part, without prior written consent of Renesas Electronics.
- Please contact a Renesas Electronics sales office if you have any questions regarding the information contained in this document or Renesas Electronics products, or if you have any other inquiries.
(Note 1) "Renesas Electronics" as used in this document means Renesas Electronics Corporation and also includes its majority-owned subsidiaries.
(Note 2) "Renesas Electronics product(s)" means any product developed or manufactured by or for Renesas Electronics.



SALES OFFICES

Renesas Electronics Corporation

<http://www.renesas.com>

Refer to "<http://www.renesas.com/>" for the latest and detailed information.

Renesas Electronics America Inc.
2880 Scott Boulevard Santa Clara, CA 95050-2554, U.S.A.
Tel: +1-408-588-6000, Fax: +1-408-588-6130

Renesas Electronics Canada Limited
1101 Nicholson Road, Newmarket, Ontario L3Y 9C3, Canada
Tel: +1-905-898-5441, Fax: +1-905-898-3220

Renesas Electronics Europe Limited
Dukes Meadow, Millboard Road, Bourne End, Buckinghamshire, SL8 5FH, U.K.
Tel: +44-1628-585-100, Fax: +44-1628-585-900

Renesas Electronics Europe GmbH
Arcadiastrasse 10, 40472 Düsseldorf, Germany
Tel: +49-211-65030, Fax: +49-211-6503-1327

Renesas Electronics (China) Co., Ltd.
7th Floor, Quantum Plaza, No.27 ZhiChunLu Haidian District, Beijing 100083, P.R.China
Tel: +86-10-8235-1155, Fax: +86-10-8235-7679

Renesas Electronics (Shanghai) Co., Ltd.
Unit 204, 205, AZIA Center, No.1233 Lujiazui Ring Rd., Pudong District, Shanghai 200120, China
Tel: +86-21-5877-1818, Fax: +86-21-6887-7858 / -7898

Renesas Electronics Hong Kong Limited
Unit 1601-1613, 16/F., Tower 2, Grand Century Place, 193 Prince Edward Road West, Mongkok, Kowloon, Hong Kong
Tel: +852-2886-9318, Fax: +852 2886-9022/9044

Renesas Electronics Taiwan Co., Ltd.
13F, No. 363, Fu Shing North Road, Taipei, Taiwan
Tel: +886-2-8175-9600, Fax: +886 2-8175-9670

Renesas Electronics Singapore Pte. Ltd.
1 HarbourFront Avenue, #06-10, Keppel Bay Tower, Singapore 098632
Tel: +65-6213-0200, Fax: +65-6278-8001

Renesas Electronics Malaysia Sdn.Bhd.
Unit 906, Block B, Menara Amcorp, Amcorp Trade Centre, No. 18, Jln Persiaran Barat, 46050 Petaling Jaya, Selangor Darul Ehsan, Malaysia
Tel: +60-3-7955-9390, Fax: +60-3-7955-9510

Renesas Electronics Korea Co., Ltd.
11F., Samik Lavied' or Bldg., 720-2 Yeoksam-Dong, Kangnam-Ku, Seoul 135-080, Korea
Tel: +82-2-558-3737, Fax: +82-2-558-5141