

To our customers,

---

## Old Company Name in Catalogs and Other Documents

---

On April 1<sup>st</sup>, 2010, NEC Electronics Corporation merged with Renesas Technology Corporation, and Renesas Electronics Corporation took over all the business of both companies. Therefore, although the old company name remains in this document, it is a valid Renesas Electronics document. We appreciate your understanding.

Renesas Electronics website: <http://www.renesas.com>

April 1<sup>st</sup>, 2010  
Renesas Electronics Corporation

Issued by: Renesas Electronics Corporation (<http://www.renesas.com>)

Send any inquiries to <http://www.renesas.com/inquiry>.

## Notice

1. All information included in this document is current as of the date this document is issued. Such information, however, is subject to change without any prior notice. Before purchasing or using any Renesas Electronics products listed herein, please confirm the latest product information with a Renesas Electronics sales office. Also, please pay regular and careful attention to additional and different information to be disclosed by Renesas Electronics such as that disclosed through our website.
2. Renesas Electronics does not assume any liability for infringement of patents, copyrights, or other intellectual property rights of third parties by or arising from the use of Renesas Electronics products or technical information described in this document. No license, express, implied or otherwise, is granted hereby under any patents, copyrights or other intellectual property rights of Renesas Electronics or others.
3. You should not alter, modify, copy, or otherwise misappropriate any Renesas Electronics product, whether in whole or in part.
4. Descriptions of circuits, software and other related information in this document are provided only to illustrate the operation of semiconductor products and application examples. You are fully responsible for the incorporation of these circuits, software, and information in the design of your equipment. Renesas Electronics assumes no responsibility for any losses incurred by you or third parties arising from the use of these circuits, software, or information.
5. When exporting the products or technology described in this document, you should comply with the applicable export control laws and regulations and follow the procedures required by such laws and regulations. You should not use Renesas Electronics products or the technology described in this document for any purpose relating to military applications or use by the military, including but not limited to the development of weapons of mass destruction. Renesas Electronics products and technology may not be used for or incorporated into any products or systems whose manufacture, use, or sale is prohibited under any applicable domestic or foreign laws or regulations.
6. Renesas Electronics has used reasonable care in preparing the information included in this document, but Renesas Electronics does not warrant that such information is error free. Renesas Electronics assumes no liability whatsoever for any damages incurred by you resulting from errors in or omissions from the information included herein.
7. Renesas Electronics products are classified according to the following three quality grades: “Standard”, “High Quality”, and “Specific”. The recommended applications for each Renesas Electronics product depends on the product’s quality grade, as indicated below. You must check the quality grade of each Renesas Electronics product before using it in a particular application. You may not use any Renesas Electronics product for any application categorized as “Specific” without the prior written consent of Renesas Electronics. Further, you may not use any Renesas Electronics product for any application for which it is not intended without the prior written consent of Renesas Electronics. Renesas Electronics shall not be in any way liable for any damages or losses incurred by you or third parties arising from the use of any Renesas Electronics product for an application categorized as “Specific” or for which the product is not intended where you have failed to obtain the prior written consent of Renesas Electronics. The quality grade of each Renesas Electronics product is “Standard” unless otherwise expressly specified in a Renesas Electronics data sheets or data books, etc.
  - “Standard”: Computers; office equipment; communications equipment; test and measurement equipment; audio and visual equipment; home electronic appliances; machine tools; personal electronic equipment; and industrial robots.
  - “High Quality”: Transportation equipment (automobiles, trains, ships, etc.); traffic control systems; anti-disaster systems; anti-crime systems; safety equipment; and medical equipment not specifically designed for life support.
  - “Specific”: Aircraft; aerospace equipment; submersible repeaters; nuclear reactor control systems; medical equipment or systems for life support (e.g. artificial life support devices or systems), surgical implantations, or healthcare intervention (e.g. excision, etc.), and any other applications or purposes that pose a direct threat to human life.
8. You should use the Renesas Electronics products described in this document within the range specified by Renesas Electronics, especially with respect to the maximum rating, operating supply voltage range, movement power voltage range, heat radiation characteristics, installation and other product characteristics. Renesas Electronics shall have no liability for malfunctions or damages arising out of the use of Renesas Electronics products beyond such specified ranges.
9. Although Renesas Electronics endeavors to improve the quality and reliability of its products, semiconductor products have specific characteristics such as the occurrence of failure at a certain rate and malfunctions under certain use conditions. Further, Renesas Electronics products are not subject to radiation resistance design. Please be sure to implement safety measures to guard them against the possibility of physical injury, and injury or damage caused by fire in the event of the failure of a Renesas Electronics product, such as safety design for hardware and software including but not limited to redundancy, fire control and malfunction prevention, appropriate treatment for aging degradation or any other appropriate measures. Because the evaluation of microcomputer software alone is very difficult, please evaluate the safety of the final products or system manufactured by you.
10. Please contact a Renesas Electronics sales office for details as to environmental matters such as the environmental compatibility of each Renesas Electronics product. Please use Renesas Electronics products in compliance with all applicable laws and regulations that regulate the inclusion or use of controlled substances, including without limitation, the EU RoHS Directive. Renesas Electronics assumes no liability for damages or losses occurring as a result of your noncompliance with applicable laws and regulations.
11. This document may not be reproduced or duplicated, in any form, in whole or in part, without prior written consent of Renesas Electronics.
12. Please contact a Renesas Electronics sales office if you have any questions regarding the information contained in this document or Renesas Electronics products, or if you have any other inquiries.

(Note 1) “Renesas Electronics” as used in this document means Renesas Electronics Corporation and also includes its majority-owned subsidiaries.

(Note 2) “Renesas Electronics product(s)” means any product developed or manufactured by or for Renesas Electronics.

To all our customers

---

## **Regarding the change of names mentioned in the document, such as Mitsubishi Electric and Mitsubishi XX, to Renesas Technology Corp.**

---

The semiconductor operations of Hitachi and Mitsubishi Electric were transferred to Renesas Technology Corporation on April 1st 2003. These operations include microcomputer, logic, analog and discrete devices, and memory chips other than DRAMs (flash memory, SRAMs etc.) Accordingly, although Mitsubishi Electric, Mitsubishi Electric Corporation, Mitsubishi Semiconductors, and other Mitsubishi brand names are mentioned in the document, these names have in fact all been changed to Renesas Technology Corp. Thank you for your understanding. Except for our corporate trademark, logo and corporate statement, no changes whatsoever have been made to the contents of the document, and these changes do not constitute any alteration to the contents of the document itself.

Note : Mitsubishi Electric will continue the business operations of high frequency & optical devices and power devices.

Renesas Technology Corp.  
Customer Support Dept.  
April 1, 2003

# M66240P/FP

## 4-CH 16-BIT PWM GENERATOR

### DESCRIPTION

The M66240 is a programmable channel PWM generator produced using the silicon gate CMOS process. The M66240 can connect directly to the MPU data bus and consists of a 16-bit prescaler and a PWM counter. The pulse output includes three kinds of modes, allowing the independent control of each channel. Combining the A-D function and the timer function of the one-chip micro-computer provides a software servo system.

### FEATURES

- 4-channel independent control possible
- Three pulse output modes incorporated.
- PWM repetitive frequency : 50kHz (max.)  
(Mode 0, 8-bit resolution,  $f_{in}/255$  at prescaler setting=0)
- Output polarity selection possible
- External triggering possible
- The output after reset is in the high impedance state.
- Change of mode setting becomes effective after the current cycle.
- The RESET incorporates a negative-going noise eliminator and the TRG1-4 incorporates a positive-going noise eliminator.
- High output current :  $I_{OH} = \pm 24mA$

### APPLICATION

Control of DC motors and stepping motors, heater phase controllers, software servos for office automation equipment, and industrial equipment.

### PIN CONFIGURATION (TOP VIEW)

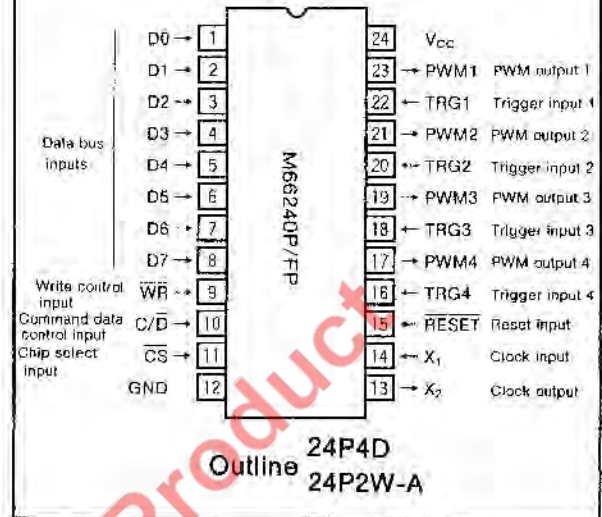

### FUNCTION

Four separate 16-bit prescalers and 16-bit PWM counters can be separately programmed by the control instruction from the MPU.

The output is made in one of three modes (Mode 0, Mode 1, and Mode 2).

In Mode 0, setting only the value of H width repeatedly outputs the set pulse width.

In Mode 1, setting only the value of H width outputs one shot of the pulse width set by trigger input.

In Mode 2, setting both H width and L width repeatedly outputs the set pulse width.

### BLOCK DIAGRAM

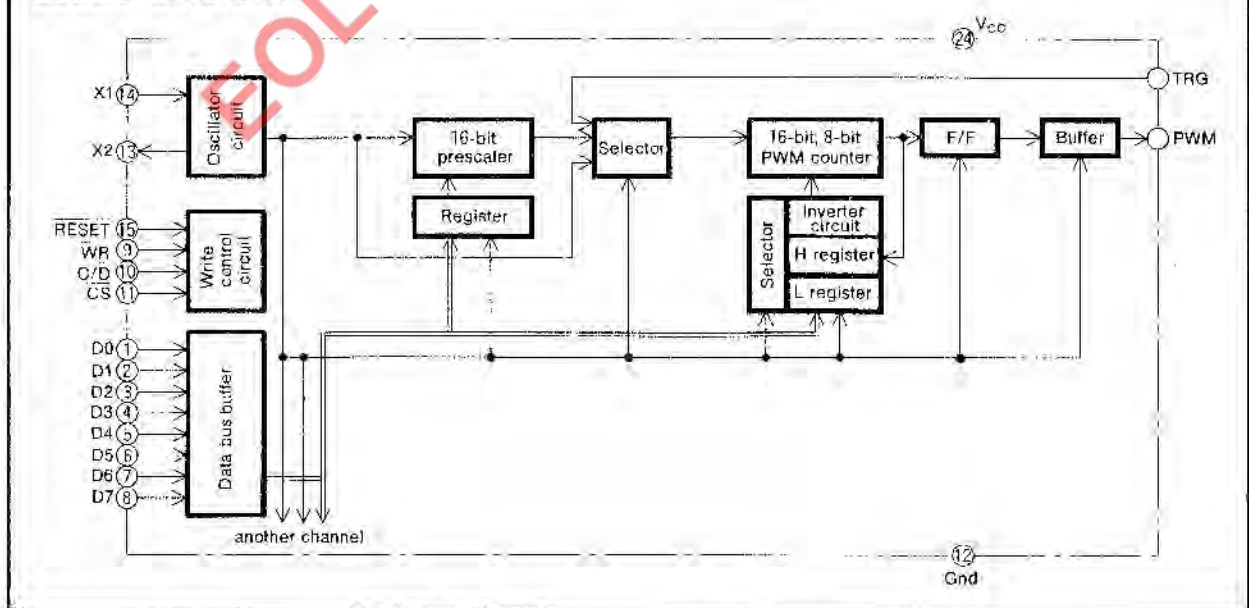

**4-CH 16-BIT PWM GENERATOR**

**PIN DESCRIPTIONS**

Pin name	Description	I/O	Function
RESET	Reset input	Input	Clears the command register and the flip-flop at "L"
D0~D7	Data bus input	Input	Inputs the data from MPU over the 8-bit data bus.
WR	Write input	Input	Writes the data bus data to the control register or data register when the state changes from "L" to "H".
C/D	Command/data input	Input	Data at the data bus is regarded as a command at high level and as data at low level.
$\overline{CS}$	Chip select input	Input	Communication with MPU is enabled at low-level. Any control from MPU is ignored at high level.
X <sub>1</sub>	Clock input	Input	I/O to the built-in clock generator circuit. Providing a crystal resonator between X <sub>1</sub> and X <sub>2</sub> sets the frequency. To make external clock input, connect the clock source to X <sub>1</sub> pin and leave X <sub>2</sub> pin open.
X <sub>2</sub>	Clock output	Output	
TRG1~TRG4	Trigger input	Input	This is used when external trigger is selected in mode setting. Set to low level when not in use.
PWM1~PWM4	PWM output	Output	PWM output pins. Outputs become the high-impedance state after reset or after disable is specified by command 3. D0 of command 1 allows the selection of output polarity.

**OPERATION**

**Commands**

The information on data bus inputs D0 through D7 is loaded as command when command data control input  $C/\overline{D}=1$  and as data when  $C/\overline{D}=0$ .

There are three kinds of commands. (See Figure 1.)

Command 1 selects the output mode and external trigger input of each channel and sets the output polarity of H width. Command 2 specifies, on a byte basis, to which 16-bit register of the prescaler and PWM counter of each channel data is to be written.

The second and subsequent bytes of command 2 write prescaler value and PWM value. Depending on the location specified by command 2, the data of the second and subsequent bytes must be written in the order shown in Figure 2.

Command 3 is used to start or stop the prescaler and PWM counter operation.

**Data input**

At initialization, all 16 bits of the prescaler value must be written.

In mode 0 or 1, the PWM value must be written to all 16 bits of H register (In mode 0 at 8-bit resolution, only the lower byte of the H register is used.); In mode 2, the value must be written to all 16 bits of H and L registers.

To change the values of all 16 bits in the prescaler or the PWM counter during operation, values should be written to the upper byte first and then to the lower byte. To change the values of the lower byte only, the values of only the lower byte should be written.

To change the values of the upper byte, the values of all 16 bits should be written. To change the values of H register in Mode 2, the H register value should be written followed by the L register value.

When values are written to the lower byte (lower byte of L register in Mode 2), the write cycle of data register is completed.

If the data register value is changed during a PWM signal output operation (exactly, after the end of the write operation), the PWM output is updated starting with the cycle next to the current output cycle.

To change the mode (i.e., to execute command 1), disable the output first (i.e., execute command 3).

Figure 3 shows the flow chart of the basic operation. (The order of the prescaler's and PWM counter's data setting is not fixed.)

4-CH 16-BIT PWM GENERATOR

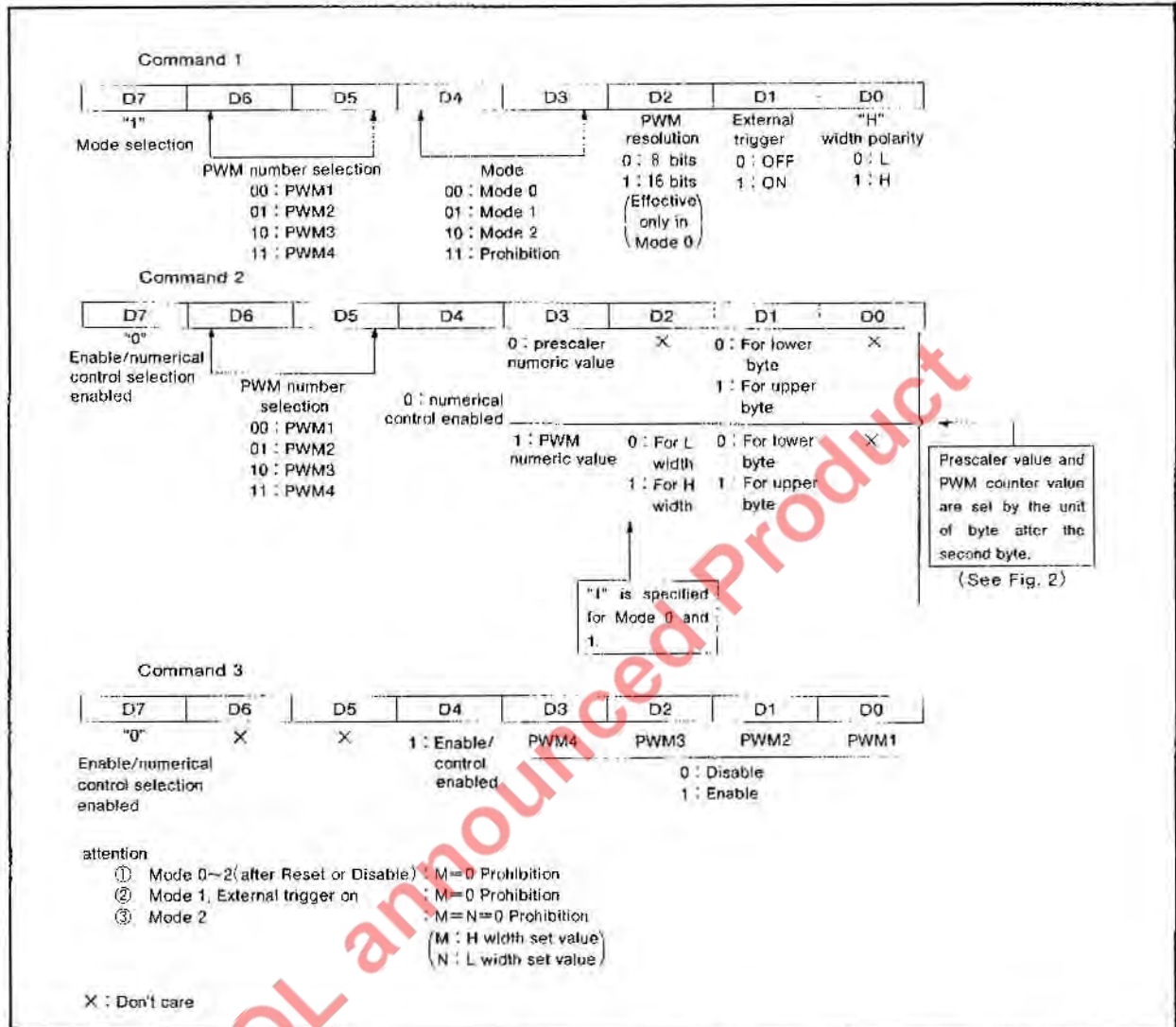

Fig. 1 Commands

First byte (command 2)			Second byte	Third byte	Fourth byte	Fifth byte	Remark
D3	D2	D1					
1	1	1	Upper byte for PWM H register	Lower byte for PWM H register	-	-	When Mode 0 or 1
1	1	0	Lower byte for PWM H register	-	-	-	
1	1	1	Upper byte for PWM H register	Lower byte for PWM H register	Upper byte for PWM L register	Lower byte for PWM L register	When Mode 2
1	1	0	Lower byte for PWM H register	Upper byte for PWM L register	Lower byte for PWM L register	-	
1	0	1	Upper byte for PWM L register	Lower byte for PWM L register	-	-	
1	0	0	Lower byte for PWM L register	-	-	-	
0	X	1	Upper byte for prescaler register	Lower byte for prescaler register	-	-	
0	X	0	Lower byte for prescaler register	-	-	-	

Fig. 2 Data-setting sequence for registers

4-CH 16-BIT PWM GENERATOR

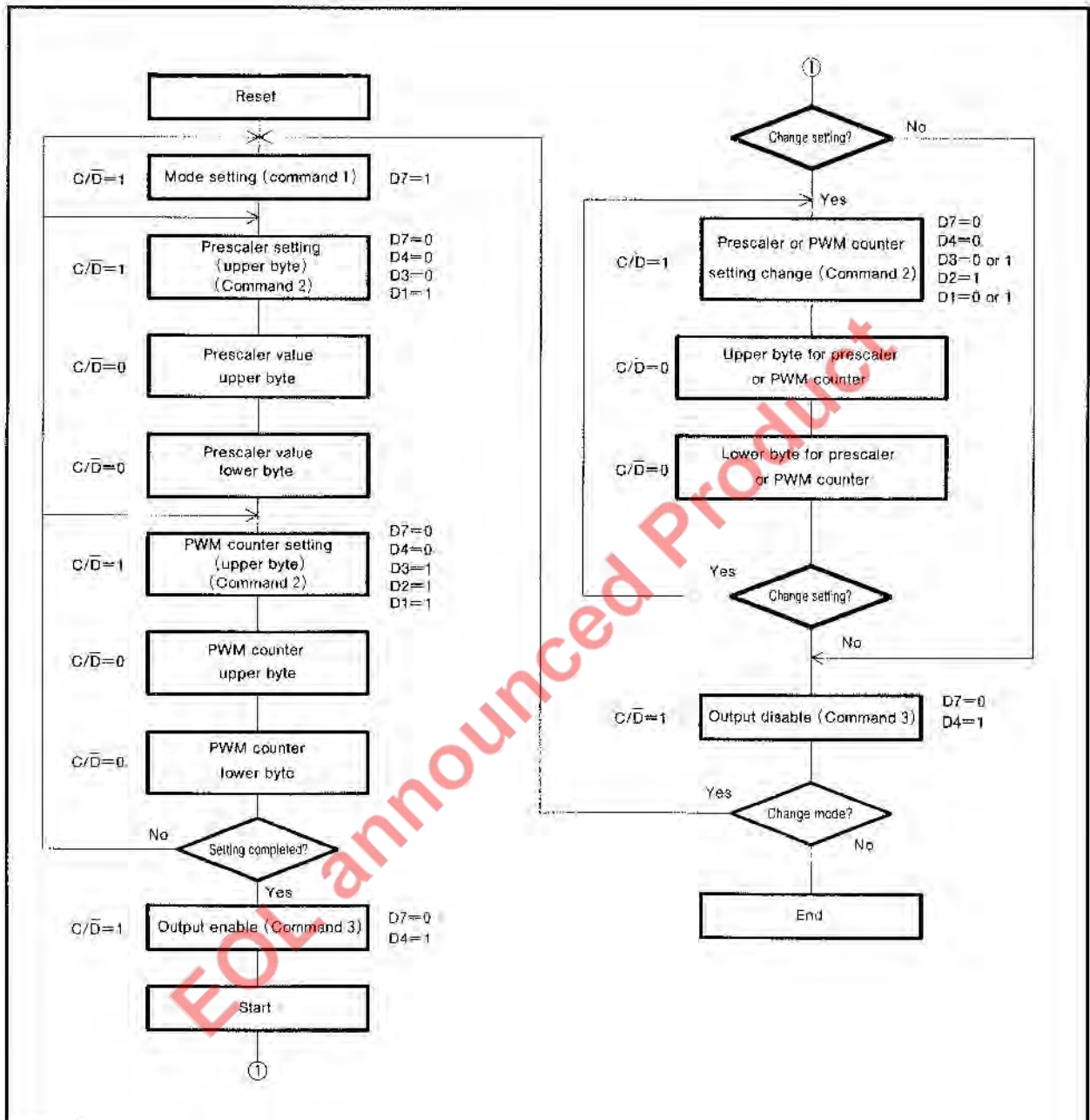

Fig. 3 Flow chart In Mode 0 or 1 (for one channel)

4-CH 16-BIT PWM GENERATOR

**PWM waveform output**

The M66240 has a built-in 16-bit prescaler and a PWM counter. The duty cycle of output pulse can be freely specified by changing the values of the prescaler and the PWM counter. The output is made in one of three modes (Mode 0, Mode 1, and Mode 2). The description of these modes is given below.

(1) Mode 0

This mode is selected by writing "0" to D4 and D3 in command 1.

Figure 9 shows the block diagram (for one channel) in this mode.

The 16-bit PWM counter can be used as an 8-bit PWM counter only in this mode (command 1 : D2=0). The setting with PWM resolution=8 bits must be written to the lower 8 bytes of H register. In this mode, the H output pulse width is determined by the prescaler register value L and PWM register value M. The PWM output cycle time is determined by the prescaler register value L, irrespective of the PWM register value M. (See Fig. 4)

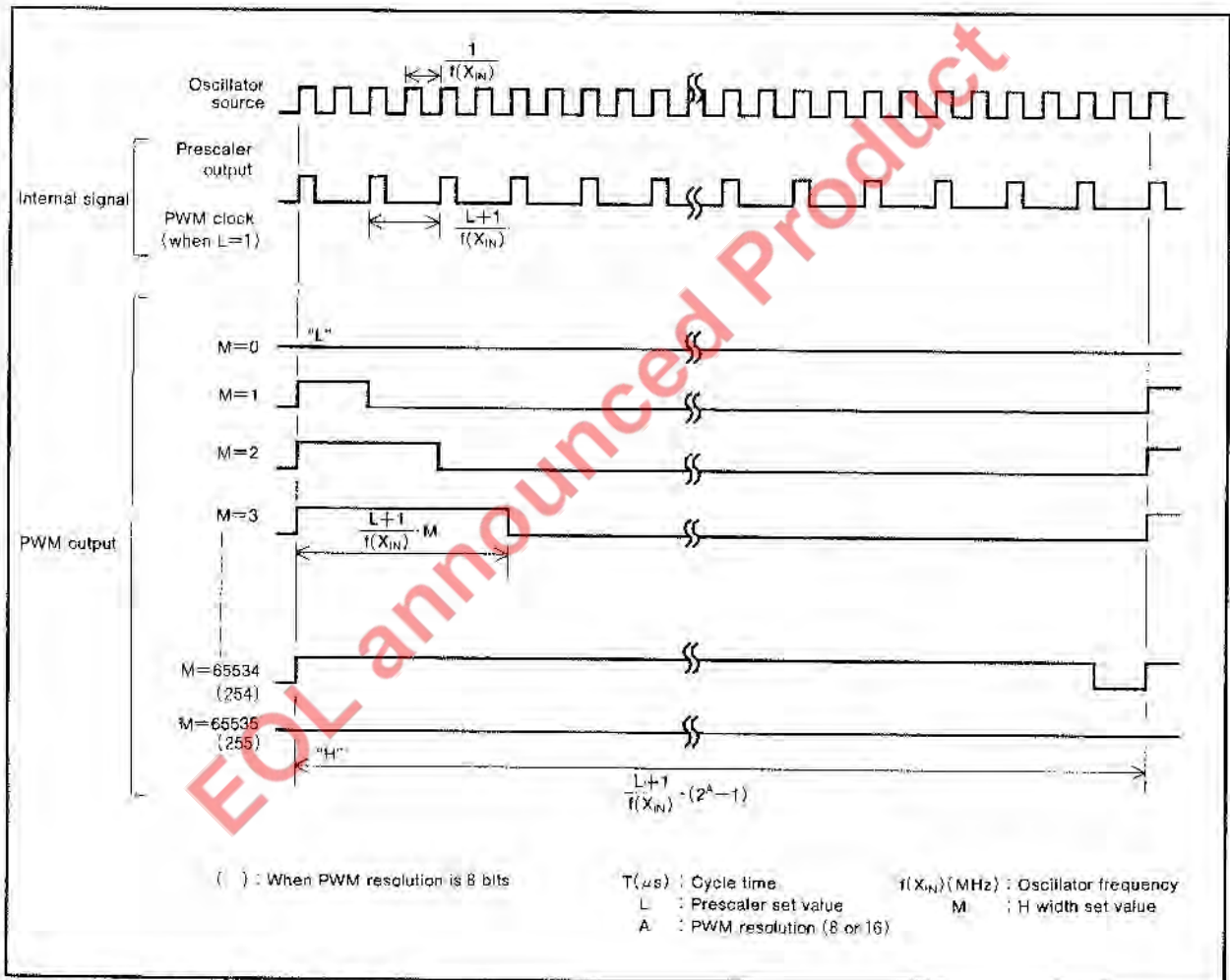

Fig. 4 (When H width polarity is "H")



4-CH 16-BIT PWM GENERATOR

(2) Mode 1

This mode is selected by setting D4=0 and D3=1 in command 1.

Figure 10 shows the block diagram in this mode (for one channel).

This mode outputs, on the trigger signal, one shot of the pulse determined by value M of PWM register. The type of this output operation is determined by whether the external trigger signal or the internal trigger signal is used. Operation varies according to the choice of external and internal trigger signals.

① External trigger selected (D1=1 in command 1): This mode outputs, when a trigger pulse is applied to trigger input TRG, one shot of output pulse. Therefore, cycle time T becomes cycle time  $f_{IN}$  of the trigger pulse to be applied to trigger input TRG.

The output pulse width is determined by the prescaler register value L and PWM register value M. (See Fig. 5)

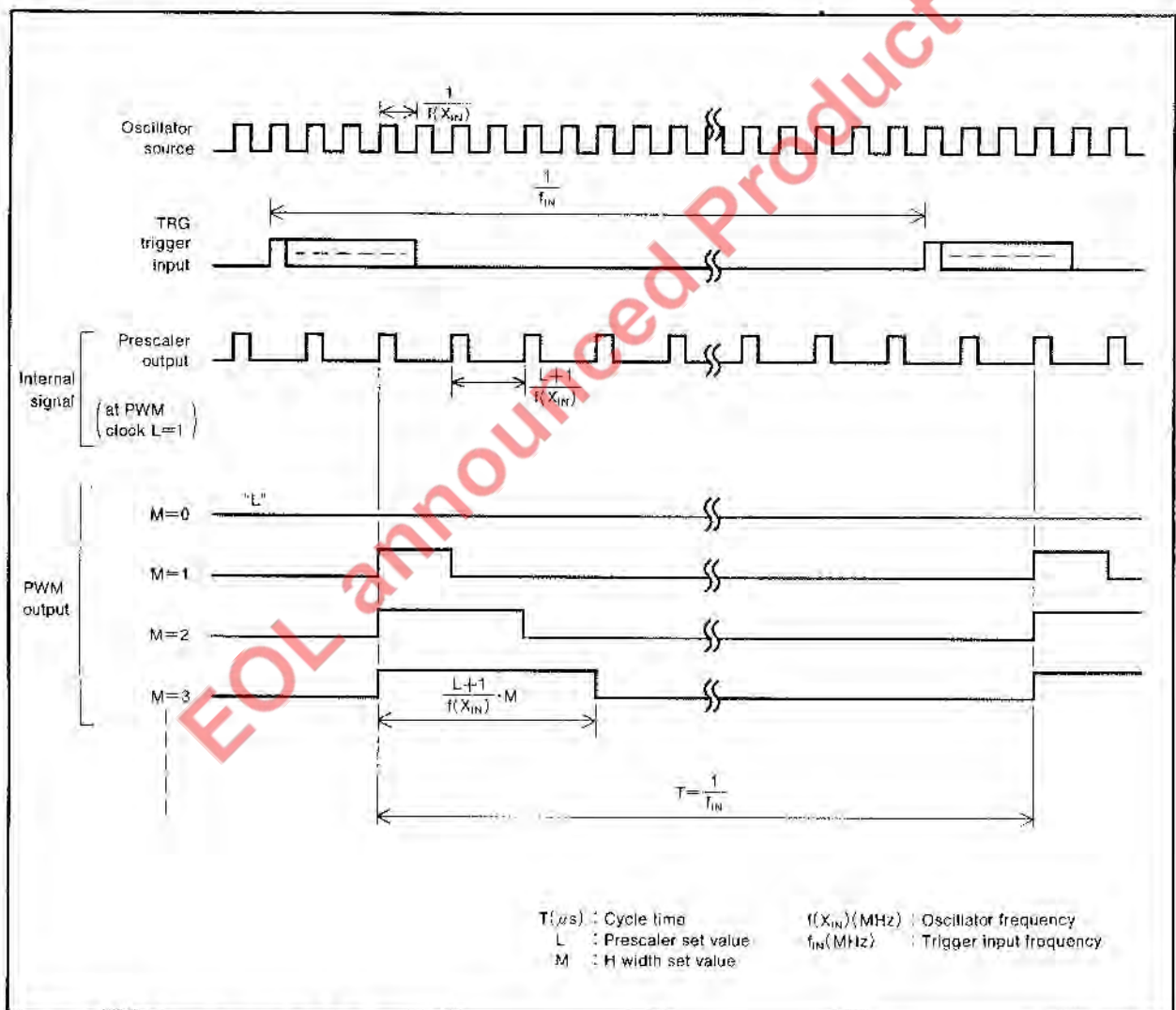

Fig. 5 (When H width polarity is "H")

**4-CH 16-BIT PWM GENERATOR**

② Internal trigger selected (D1≠0 in command 1):  
 In this mode, the trigger signal is generated by the prescaler. Therefore, the cycle time  $T$  of output pulse is determined by the prescaler register value  $L$ . In this case, the

oscillator source becomes the PWM counter clock and the output pulse width is determined by the PWM register value  $M$ . (See Fig. 6)

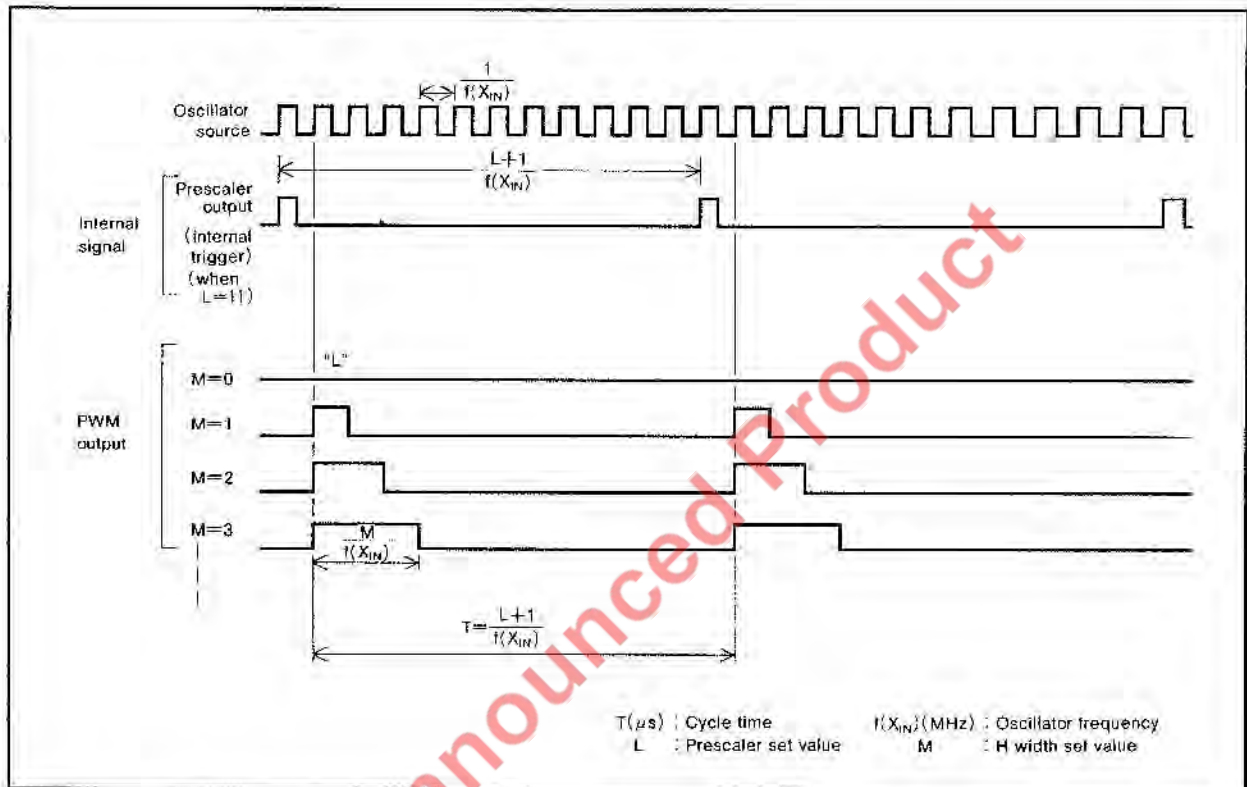

Fig. 6 (When H width polarity is "H")

In Mode 1, the retrigger state is caused when the cycle time of trigger pulse gets smaller than value  $M$  of PWM register.

**4-CH 16-BIT PWM GENERATOR**

(3) Mode 2

This mode is selected by writing D4=1 and D3=0 in command 1. Fig. 11 shows the block diagram of this mode (for one channel).

The high-level pulse value M is set to the H register of PWM and the low-level pulse value N is set to the L register of PWM. In Modes 0 and 1, but, in this mode, the high-level

pulse value M is set to the H register of PWM and the low-level pulse value N is set to the L register of PWM. Therefore, the pulse width and cycle time T of PWM output are determined by value L of the prescaler register and values M and N of H and L registers of PWM (see Fig. 7).

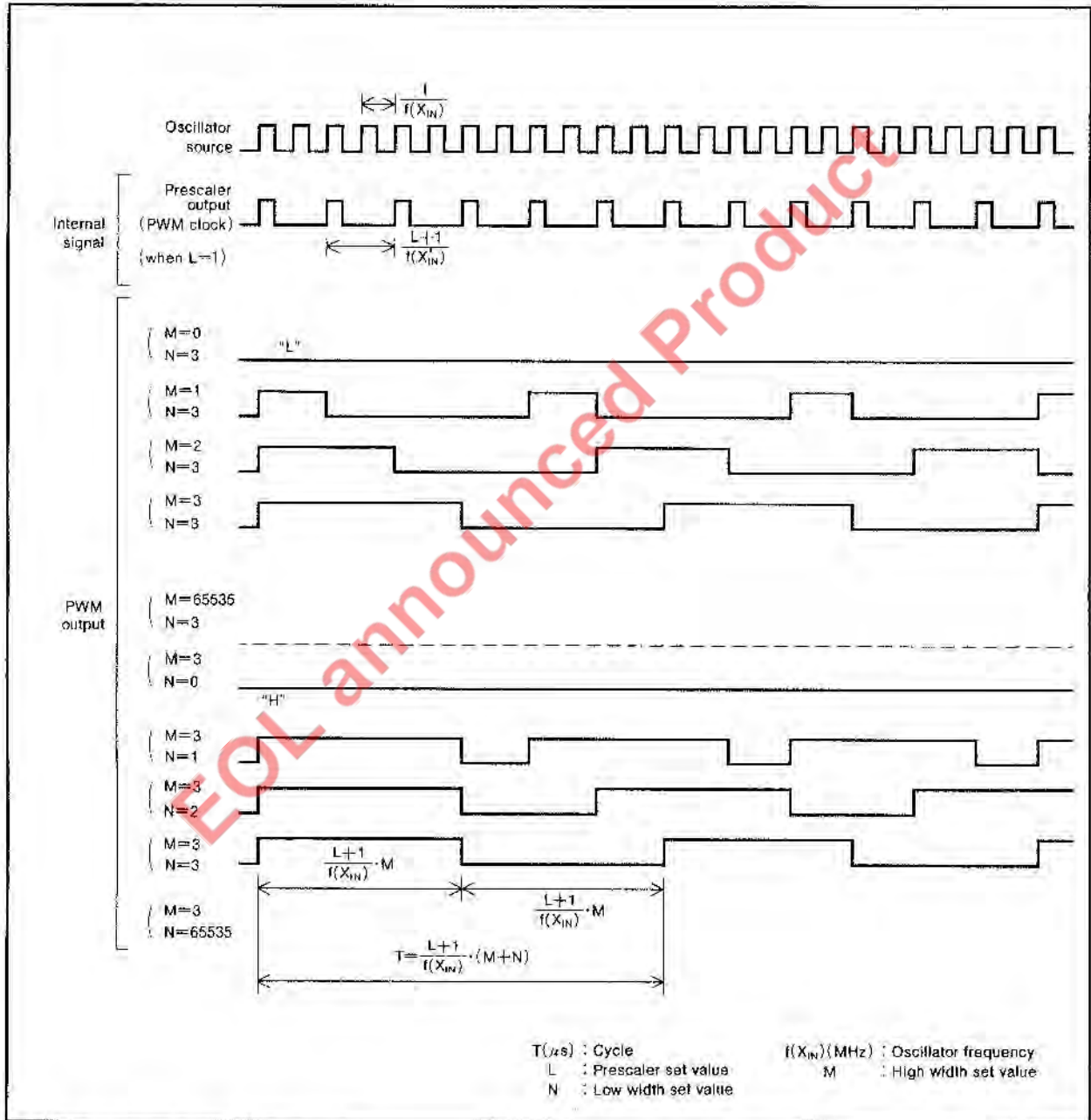

Fig. 7 (When H width polarity is "H")

4-CH 16-BIT PWM GENERATOR

**Initial state**

When external trigger ON is selected in D1 in the case of Command 1, starting the operation of the internal circuit by writing enable by Command 3 does not output a pulse to PWM output, which is held in the high impedance state. The pulse can be output to PWM output by entering H level

in TRG input for Mode 0 or Mode 2 or H pulse in TRG input in Mode 1 (see Fig. 8).

Putting TRG input to L level during PWM output in Mode 0 or Mode 2 makes PWM output keep its state. Putting TRG input back to H level starts the operation from that point.

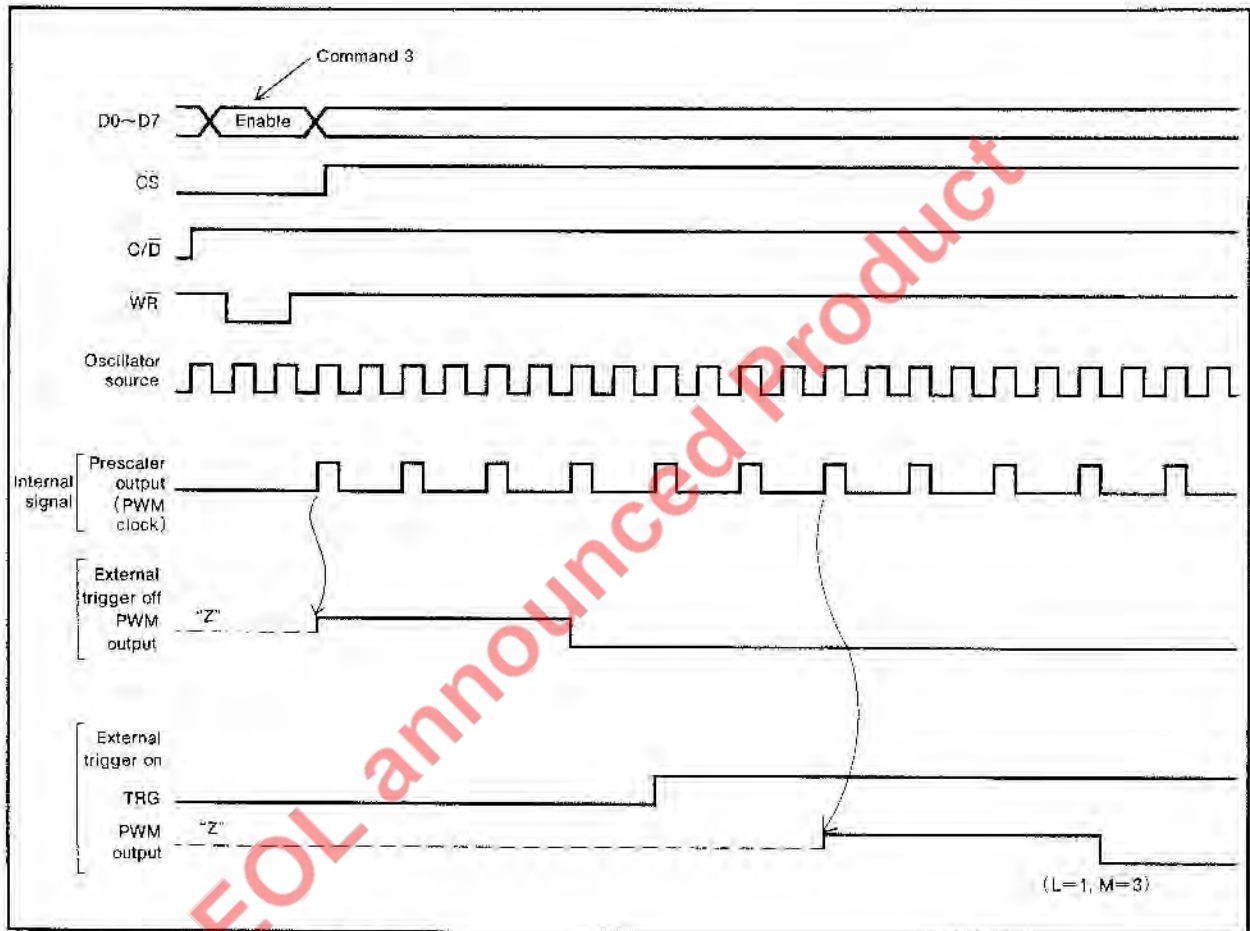

Fig. 8 (When H width polarity is "H")

**4-CH 16-BIT PWM GENERATOR**

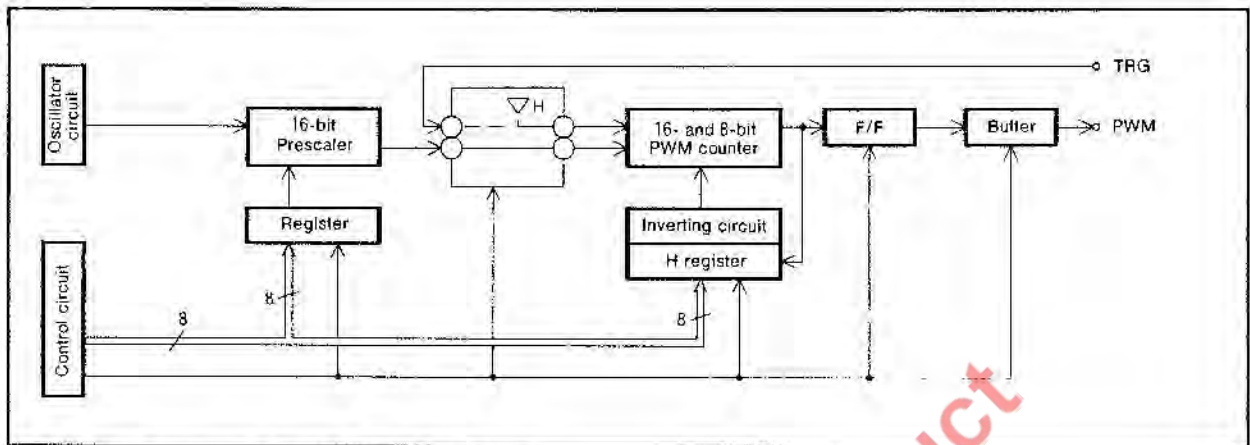

Fig. 9 Block diagram in Mode 0 (for one channel)

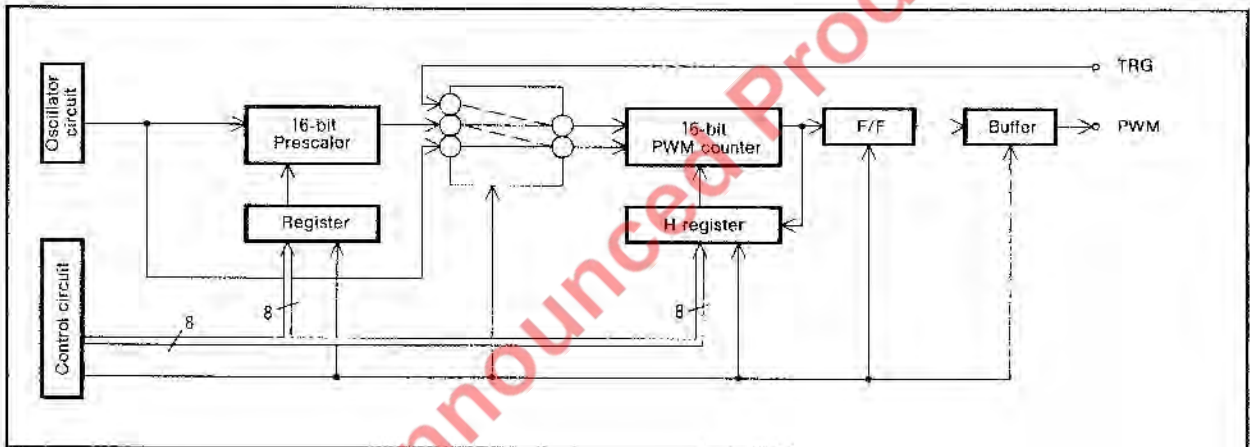

Fig. 10 Block diagram in Mode 1 (for one channel)

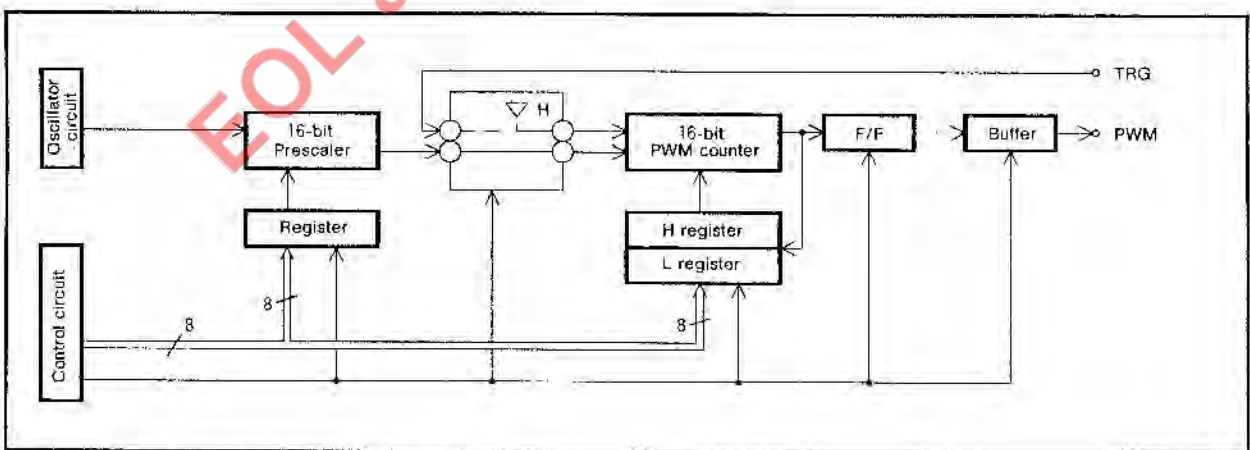

Fig. 11 Block diagram in Mode 2 (for one channel)

**ABSOLUTE MAXIMUM RATINGS**

Symbol	Parameter	Conditions	Rating	Unit
$V_{CC}$	Power voltage		-0.5~+7.0	V
$V_I$	Input voltage		-0.5~ $V_{CC}+0.5$	V
$V_O$	Output voltage		-0.5~ $V_{CC}+0.5$	V
$I_{IK}$	Input protect diode current	$V_I < 0V$ $V_I > V_{CC}$	-20 +20	mA
$I_{OK}$	Output parasitic diode current	$V_O < 0V$ $V_O > V_{CC}$	-20 +20	mA
$I_O$	Output current		±50	mA
$I_{CC}$	Power/GND current	$V_{CC}$ GND	±200	mA
$P_d$	Power dissipation		500	mW
$T_{stg}$	Storage temperature		-65~+150	°C

**RECOMMENDED OPERATING CONDITIONS**

Symbol	Parameter	Limits			Unit
		Min.	Typ.	Max.	
$V_{CC}$	Power voltage	4.5	5.0	5.5	V
GND	Power voltage		0		V
$V_I$	Input voltage	0		$V_{CC}$	V
$V_O$	Output voltage	0		$V_{CC}$	V
$T_{opr}$	Ambient operating temperature	-40		85	°C

**ELECTRICAL CHARACTERISTICS** ( $T_a = -40 \sim 85^\circ C$ ,  $V_{CC} = 5V \pm 10\%$ )

Symbol	Parameter	Test conditions	Limits			Unit
			Min.	Typ.	Max.	
$V_{T+}$	Positive going threshold voltage	$V_O = 0.1$ , $V_{CC} = 0.1V$ , $I_O = 20\mu A$ RESET, TRG1~4			2.4	V
$V_{T-}$	Negative going threshold voltage	$V_O = 0.1$ , $V_{CC} = 0.1V$ , $I_O = 20\mu A$ RESET, TRG1~4	0.6			V
$V_H$	Hysteresis width	$V_O = 0.1$ , $V_{CC} = 0.1V$ , $I_O = 20\mu A$ RESET, TRG1~4	0.2			V
$V_{IH}$	"H" input voltage	$V_O = 0.1$ , $V_{CC} = 0.1V$ , $I_O = 20\mu A$ $D_0 \sim D_7$ , CS, WR, C/D	2.0			V
$V_{IL}$	"L" input voltage	$V_O = 0.1$ , $V_{CC} = 0.1V$ , $I_O = 20\mu A$ $D_0 \sim D_7$ , CS, WR, C/D			0.8	V
$V_{IH}$	"H" input voltage	$V_O = 0.1$ , $V_{CC} = 0.1V$ , $I_O = 20\mu A$ X1	$V_{CC} \times 0.8$			V
$V_{IL}$	"L" input voltage	$V_O = 0.1$ , $V_{CC} = 0.1V$ , $I_O = 20\mu A$ X1			$V_{CC} \times 0.2$	V
$V_{OH}$	"H" output voltage	$V_I = V_{IH}$ , $V_{IL}$ , $I_{OH} = -24mA$ PWM1~PWM4	$V_{CC} - 0.8$			V
$V_{OL}$	"L" output voltage	$V_I = V_{IH}$ , $V_{IL}$ , $I_{OL} = 24mA$ PWM1~PWM4			0.55	V
$I_{IH}$	"H" input current	$V_I = V_{CC}$			1.0	μA
$I_{IL}$	"L" input current	$V_I = GND$			-1.0	μA
$I_{OZH}$	Off-state "H" output current	$V_O = V_{CC}$			5.0	μA
$I_{OZL}$	Off-state "L" output current	$V_O = GND$			-5.0	μA
$I_{CC}$	Quiescent current consumption	$V_I = V_{CC}$ , GND, $I_O = 0\mu A$			100	μA
$\Delta I_{CC}$	Max. quiescent current consumption	$V_I = 2.4V, 0.4V$ (Note 1)			2.9	mA

Note 1 : Set only one input to this value; fix other inputs to  $V_{CC}$  or GND.

4-CH 16-BIT PWM GENERATOR

SWITCHING CHARACTERISTICS (T<sub>a</sub> = -40~85°C, V<sub>CC</sub> = 5 V ± 10%)

Symbol	Parameter	Test conditions	Limits			Unit
			Min.	Typ.	Max.	
t <sub>PZL(W-PWM)</sub>	Output enable time after write (Mode 0, 2, external trigger OFF)	C <sub>L</sub> = 50pF		$\frac{L+2}{f} + 44$	$\frac{L+2}{f} + 110$	ns
t <sub>PZH(W-PWM)</sub>	Output enable time after write (Mode 0, 2, external trigger OFF)			$\frac{L+2}{f} + 43$	$\frac{L+2}{f} + 110$	ns
t <sub>PZL(T-PWM)</sub>	Output enable time after write (Mode 1, external trigger OFF)			$\frac{L+3}{f} + 34$	$\frac{L+3}{f} + 110$	ns
t <sub>PZH(T-PWM)</sub>	Output enable time after write (Mode 1, external trigger OFF)			$\frac{L+3}{f} + 33$	$\frac{L+3}{f} + 110$	ns
t <sub>PZL(T-PWM)</sub>	Output enable time after trigger (Mode 0, 2, external trigger ON)			$\frac{2(L+1)}{f} + 44$	$\frac{2(L+1)}{f} + 110$	ns
t <sub>PZH(T-PWM)</sub>	Output enable time after trigger (Mode 0, 2, external trigger ON)			$\frac{2(L+1)}{f} + 38$	$\frac{2(L+1)}{f} + 110$	ns
t <sub>PZL(T-PWM)</sub>	Output enable time after trigger (Mode 1, external trigger ON)			$\frac{2(L+1)}{f} + 44$	$\frac{2(L+1)}{f} + 110$	ns
t <sub>PZH(T-PWM)</sub>	Output enable time after trigger (Mode 1, external trigger ON)			$\frac{2(L+1)}{f} + 39$	$\frac{2(L+1)}{f} + 110$	ns
t <sub>PLHX(W-PWM)</sub>	Output propagation time after clock (all modes)			41	110	ns
t <sub>PLHX(T-PWM)</sub>	Output propagation time after clock (all modes)			44	110	ns
t <sub>PLH(T-PWM)</sub>	Output propagation time after trigger (Mode 1, external trigger ON)			$\frac{2(L+1)}{f} + 40$	$\frac{2(L+1)}{f} + 110$	ns
t <sub>PLH(T-PWM)</sub>	Output propagation time after trigger (Mode 1, external trigger ON)			$\frac{2(L+1)}{f} + 42$	$\frac{2(L+1)}{f} + 110$	ns
t <sub>PLZ(R-PWM)</sub>	Output disable time after reset			58	150	ns
t <sub>PHZ(R-PWM)</sub>	Output disable time after reset			60	150	ns
t <sub>PLZ(W-PWM)</sub>	Output disable time after write			32	150	ns
t <sub>PHZ(W-PWM)</sub>	Output disable time after write			30	150	ns

f (MHz) : Clock input frequency  
L : Prescaler setting

TIMING CONDITIONS (T<sub>a</sub> = -40~85°C, V<sub>CC</sub> = 5 V ± 10%)

Symbol	Parameter	Test conditions	Limits			Unit
			Min.	Typ.	Max.	
t <sub>C(X1)</sub>	Clock cycle		78.5			ns
t <sub>WH(X1)</sub>	Clock "H" pulse width		35	9		ns
t <sub>WL(X1)</sub>	Clock "L" pulse width		35	12		ns
t <sub>R(X1)</sub>	Clock rise time				20	ns
t <sub>F(X1)</sub>	Clock fall time				20	ns
t <sub>SU(A-W)</sub>	Address setup time before write (CS, C/D)		0	-11		ns
t <sub>H(W-A)</sub>	Address hold time after write (CS, C/D)		0	-11		ns
t <sub>SU(D-W)</sub>	Data setup time before write		100	55		ns
t <sub>H(W-D)</sub>	Data hold time after write		0	28		ns
t <sub>W(W)</sub>	Write pulse width		100	12		ns
t <sub>REC(W)</sub>	Write recovery time		100	12		ns
t <sub>W(T)</sub>	Trigger pulse width		100	23		ns
t <sub>W(R)</sub>	Reset pulse width		100	30		ns
t <sub>REC(S-W)</sub>	Recovery time before write		100			ns

**TIMING CHART**

(1) MCU Interface

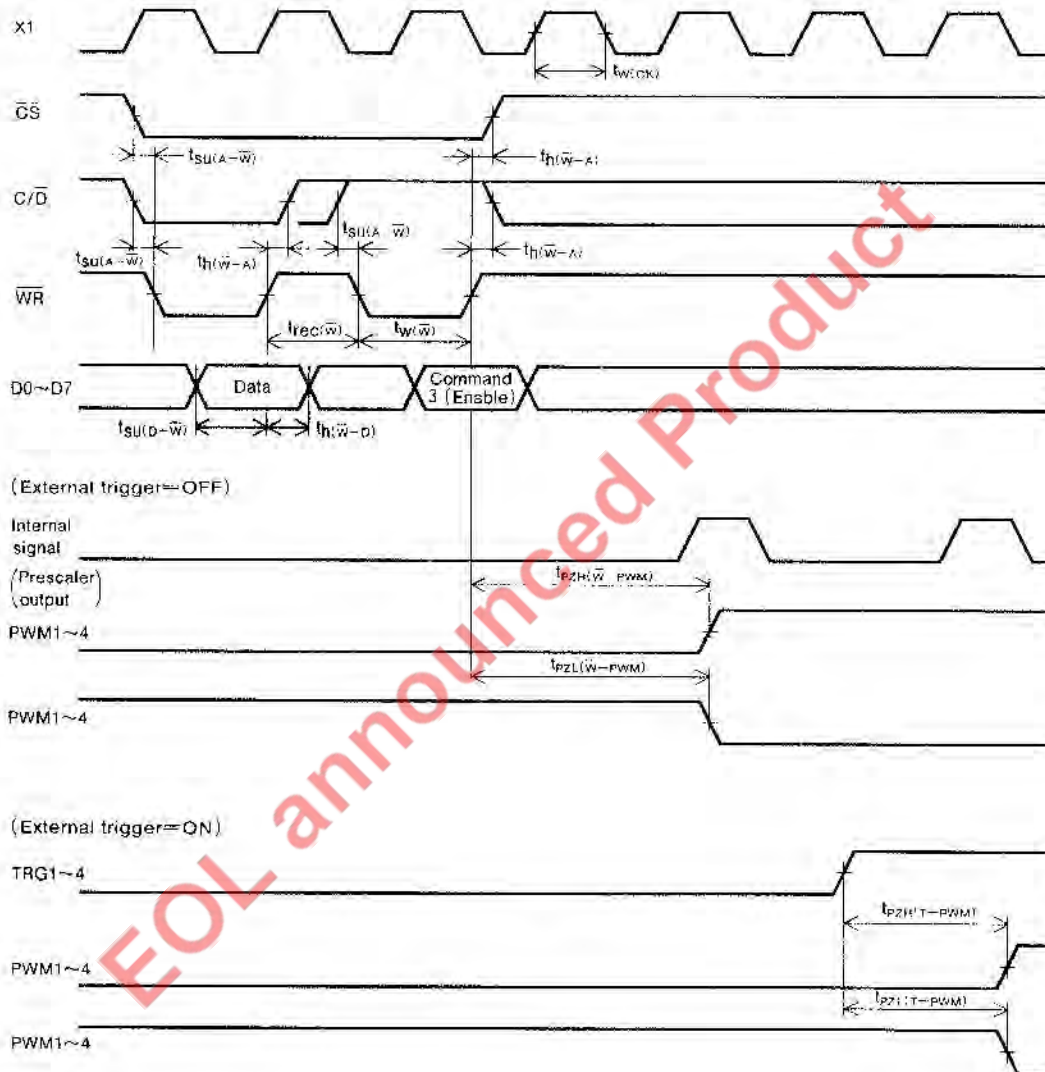



4-CH 16-BIT PWM GENERATOR

(2) In operation

Mode 0, 2 (external trigger ON, OFF)

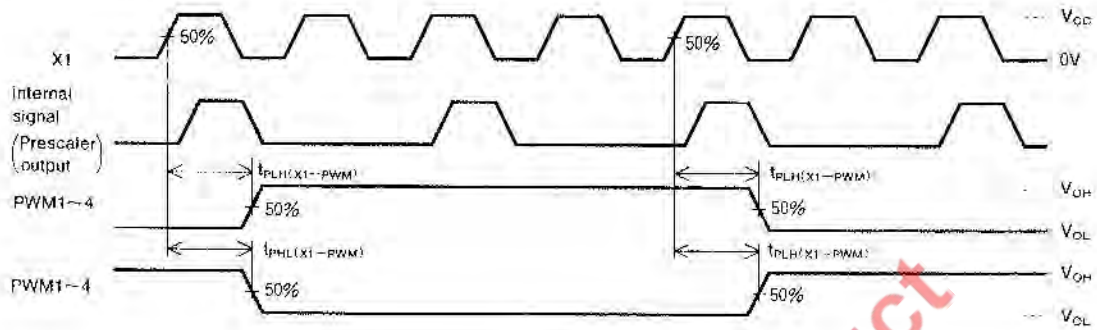

Mode 1 (external trigger ON)

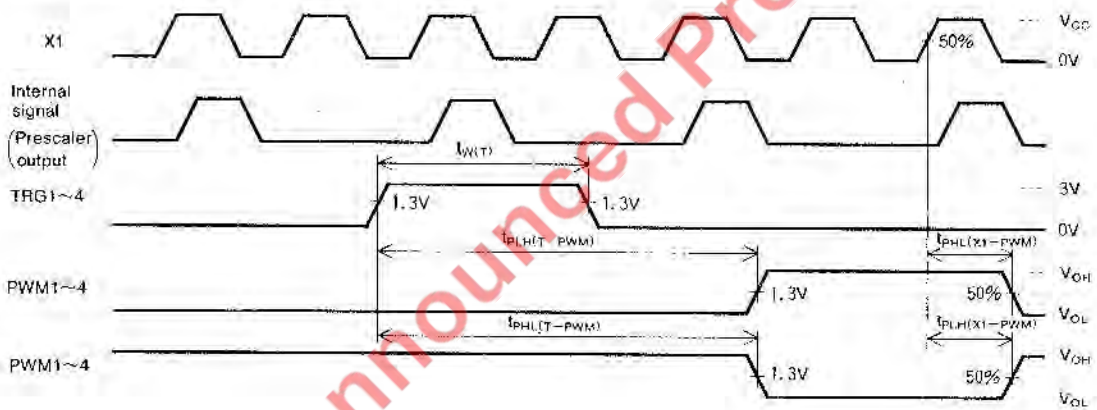

Mode 1 (external trigger OFF)

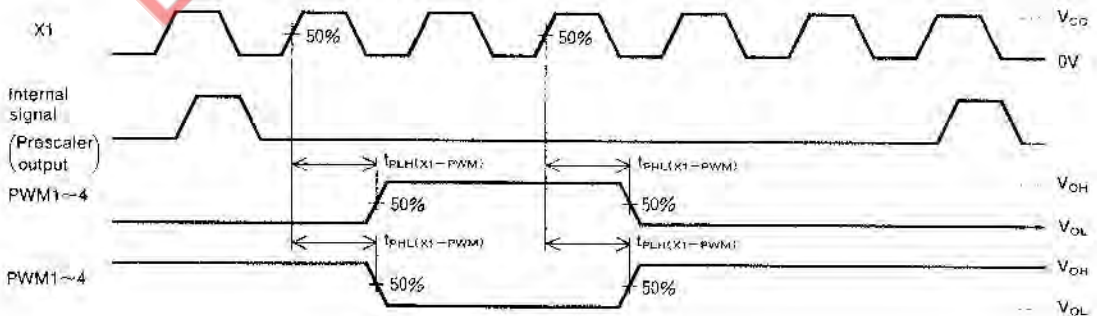

**4-CH 16-BIT PWM GENERATOR**

(3) At reset

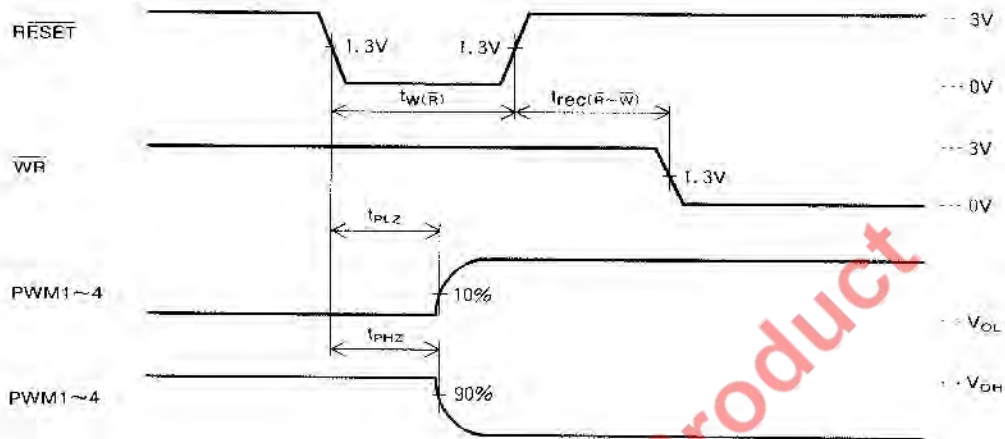

(4) At disable

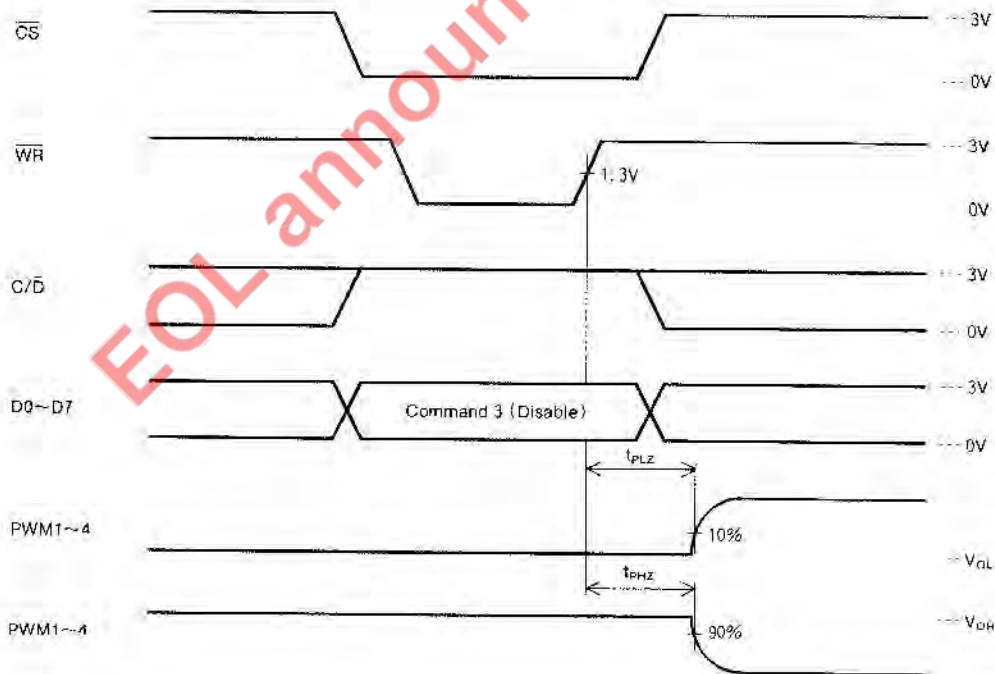

**4-CH 16-BIT PWM GENERATOR**

**Measuring circuit**

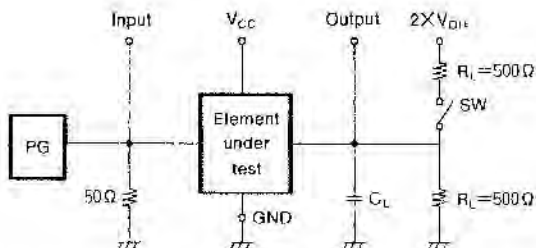

Parameter	SW
$t_{TOH}, t_{THL}$	Open
$t_{PLH}, t_{PHL}$	Closed
$t_{PLZ}$	Open
$t_{PHZ}$	Closed
$t_{PZL}$	Closed
$t_{PZH}$	Open

(1) Characteristics of pulse generator (PG) (10%~90%)  
 $t_r=3ns, t_f=3ns$

(2)  $C_L$  includes stray probe and wiring capacitance.

**APPLICATION EXAMPLE**

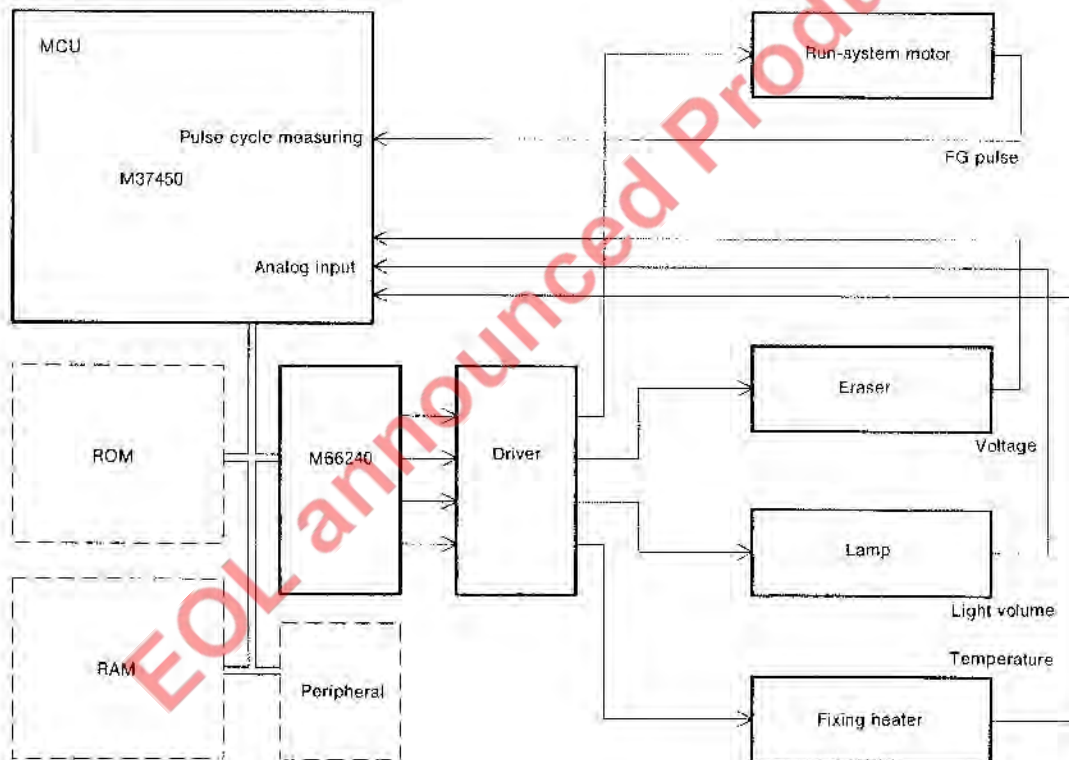

Note) M37450 : ROM 4KB~16KB  
 RAM 128B~384B  
 Timer Multifunctional 16-bit type with pulse cycle measuring mode X3  
 A-D 8-bits, 8 channels  
 PWM 20kHz cycle, 1 channel  
 UART Clock sync and async, 1 channel