

To our customers,

Old Company Name in Catalogs and Other Documents

On April 1st, 2010, NEC Electronics Corporation merged with Renesas Technology Corporation, and Renesas Electronics Corporation took over all the business of both companies. Therefore, although the old company name remains in this document, it is a valid Renesas Electronics document. We appreciate your understanding.

Renesas Electronics website: <http://www.renesas.com>

April 1st, 2010
Renesas Electronics Corporation

Issued by: Renesas Electronics Corporation (<http://www.renesas.com>)

Send any inquiries to <http://www.renesas.com/inquiry>.

Not recommended
for new design

Notice

1. All information included in this document is current as of the date this document is issued. Such information, however, is subject to change without any prior notice. Before purchasing or using any Renesas Electronics products listed herein, please confirm the latest product information with a Renesas Electronics sales office. Also, please pay regular and careful attention to additional and different information to be disclosed by Renesas Electronics such as that disclosed through our website.
2. Renesas Electronics does not assume any liability for infringement of patents, copyrights, or other intellectual property rights of third parties by or arising from the use of Renesas Electronics products or technical information described in this document. No license, express, implied or otherwise, is granted hereby under any patents, copyrights or other intellectual property rights of Renesas Electronics or others.
3. You should not alter, modify, copy, or otherwise misappropriate any Renesas Electronics product, whether in whole or in part.
4. Descriptions of circuits, software and other related information in this document are provided only to illustrate the operation of semiconductor products and application examples. You are fully responsible for the incorporation of these circuits, software, and information in the design of your equipment. Renesas Electronics assumes no responsibility for any losses incurred by you or third parties arising from the use of these circuits, software, or information.
5. When exporting the products or technology described in this document, you should comply with the applicable export control laws and regulations and follow the procedures required by such laws and regulations. You should not use Renesas Electronics products or the technology described in this document for any purpose relating to military applications or use by the military, including but not limited to the development of weapons of mass destruction. Renesas Electronics products and technology may not be used for or incorporated into any products or systems whose manufacture, use, or sale is prohibited under any applicable domestic or foreign laws or regulations.
6. Renesas Electronics has used reasonable care in preparing the information included in this document, but Renesas Electronics does not warrant that such information is error free. Renesas Electronics assumes no liability whatsoever for any damages incurred by you resulting from errors in or omissions from the information included herein.
7. Renesas Electronics products are classified according to the following three quality grades: "Standard", "High Quality", and "Specific". The recommended applications for each Renesas Electronics product depends on the product's quality grade, as indicated below. You must check the quality grade of each Renesas Electronics product before using it in a particular application. You may not use any Renesas Electronics product for any application categorized as "Specific" without the prior written consent of Renesas Electronics. Further, you may not use any Renesas Electronics product for any application for which it is not intended without the prior written consent of Renesas Electronics. Renesas Electronics shall not be in any way liable for any damages or losses incurred by you or third parties arising from the use of any Renesas Electronics product for an application categorized as "Specific" or for which the product is not intended where you have failed to obtain the prior written consent of Renesas Electronics. The quality grade of each Renesas Electronics product is "Standard" unless otherwise expressly specified in a Renesas Electronics data sheets or data books, etc.
 - "Standard": Computers; office equipment; communications equipment; test and measurement equipment; audio and visual equipment; home electronic appliances; machine tools; personal electronic equipment; and industrial robots.
 - "High Quality": Transportation equipment (automobiles, trains, ships, etc.); traffic control systems; anti-disaster systems; anti-crime systems; safety equipment; and medical equipment not specifically designed for life support.
 - "Specific": Aircraft; aerospace equipment; submersible repeaters; nuclear reactor control systems; medical equipment or systems for life support (e.g. artificial life support devices or systems), surgical implantations, or healthcare intervention (e.g. excision, etc.), and any other applications or purposes that pose a direct threat to human life.
8. You should use the Renesas Electronics products described in this document within the range specified by Renesas Electronics, especially with respect to the maximum rating, operating supply voltage range, movement power voltage range, heat radiation characteristics, installation and other product characteristics. Renesas Electronics shall have no liability for malfunctions or damages arising out of the use of Renesas Electronics products beyond such specified ranges.
9. Although Renesas Electronics endeavors to improve the quality and reliability of its products, semiconductor products have specific characteristics such as the occurrence of failure at a certain rate and malfunctions under certain use conditions. Further, Renesas Electronics products are not subject to radiation resistance design. Please be sure to implement safety measures to guard them against the possibility of physical injury, and injury or damage caused by fire in the event of the failure of a Renesas Electronics product, such as safety design for hardware and software including but not limited to redundancy, fire control and malfunction prevention, appropriate treatment for aging degradation or any other appropriate measures. Because the evaluation of microcomputer software alone is very difficult, please evaluate the safety of the final products or system manufactured by you.
10. Please contact a Renesas Electronics sales office for details as to environmental matters such as the environmental compatibility of each Renesas Electronics product. Please use Renesas Electronics products in compliance with all applicable laws and regulations that regulate the inclusion or use of controlled substances, including without limitation, the EU RoHS Directive. Renesas Electronics assumes no liability for damages or losses occurring as a result of your noncompliance with applicable laws and regulations.
11. This document may not be reproduced or duplicated, in any form, in whole or in part, without prior written consent of Renesas Electronics.
12. Please contact a Renesas Electronics sales office if you have any questions regarding the information contained in this document or Renesas Electronics products, or if you have any other inquiries.

(Note 1) "Renesas Electronics" as used in this document means Renesas Electronics Corporation and also includes its majority-owned subsidiaries.

(Note 2) "Renesas Electronics product(s)" means any product developed or manufactured by or for Renesas Electronics.

M62021L/P/FP

System Reset IC with Switch for Memory Backup

REJ03D0784-0200
Rev.2.00
Jun 15, 2007

Description

The M62021 is a system IC that controls the memory backup function of microcomputer (internal RAM).

The IC outputs reset signals ($\overline{\text{RES}}/\overline{\text{RES}}$) to a microcomputer at power-down and power failure. It also shifts the power supply to RAM from main to backup, outputs a signal ($\overline{\text{CS}}$) that invokes standby mode, and alters RAM to backup circuit mode.

The M62021 contains, in a single chip, power supply monitor and RAM backup functions needed for a microcomputer system, so that the IC makes it possible to construct a system easily and with fewer components compared with a conventional case that uses individual ICs and discrete components.

Features

- Built-in switch for selection between main power supply and backup power supply to RAM.
- Small difference between input and output voltage ($I_{\text{OUT}} = 80 \text{ mA}$, $V_{\text{IN}} = 5 \text{ V}$) 0.2 V Typ
- Detection voltage (power supply monitor voltage) $4.40 \text{ V} \pm 0.2 \text{ V}$
- Chip select signal output ($\overline{\text{CS}}$)
- Two channels of reset outputs ($\overline{\text{RES}}/\overline{\text{RES}}$)
- Power on reset circuit built-in
- Delay time variable by an external capacitance connected to Ct pin
- Facilitates to form backup function with a few number of components

Application

- Power supply control systems for memory backup of microcomputer system and SRAM boards with built-in backup function that require switching between external power supply and battery.

Block Diagram

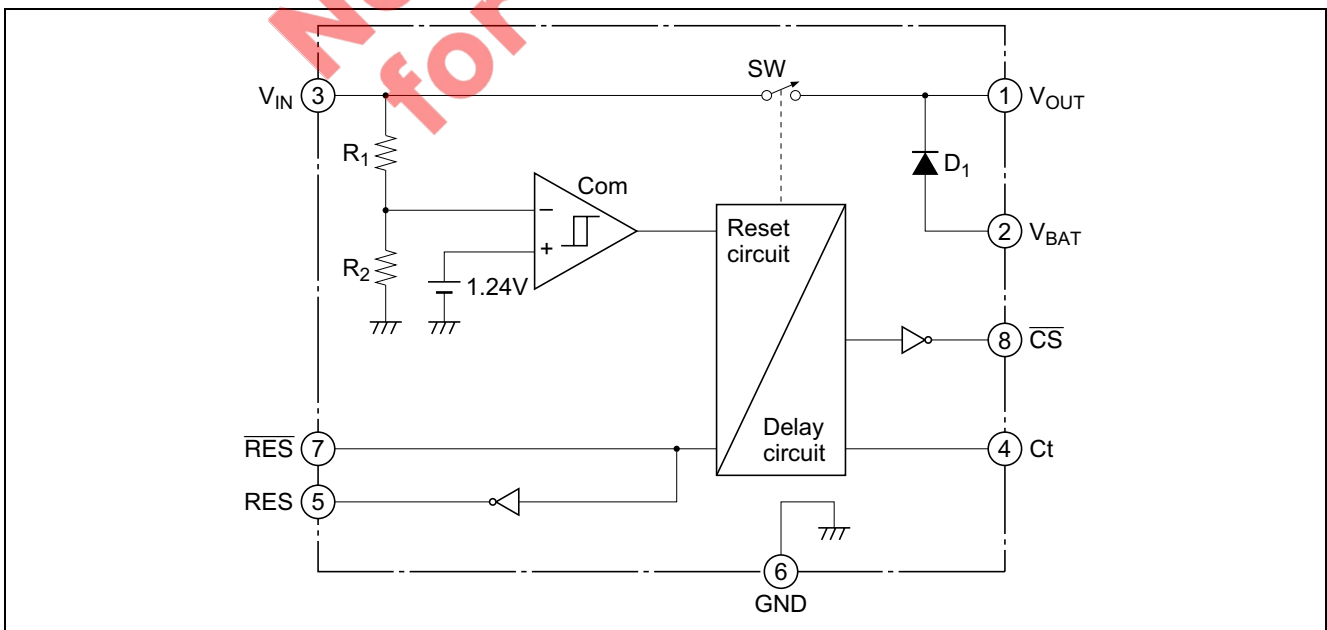

Pin Arrangement

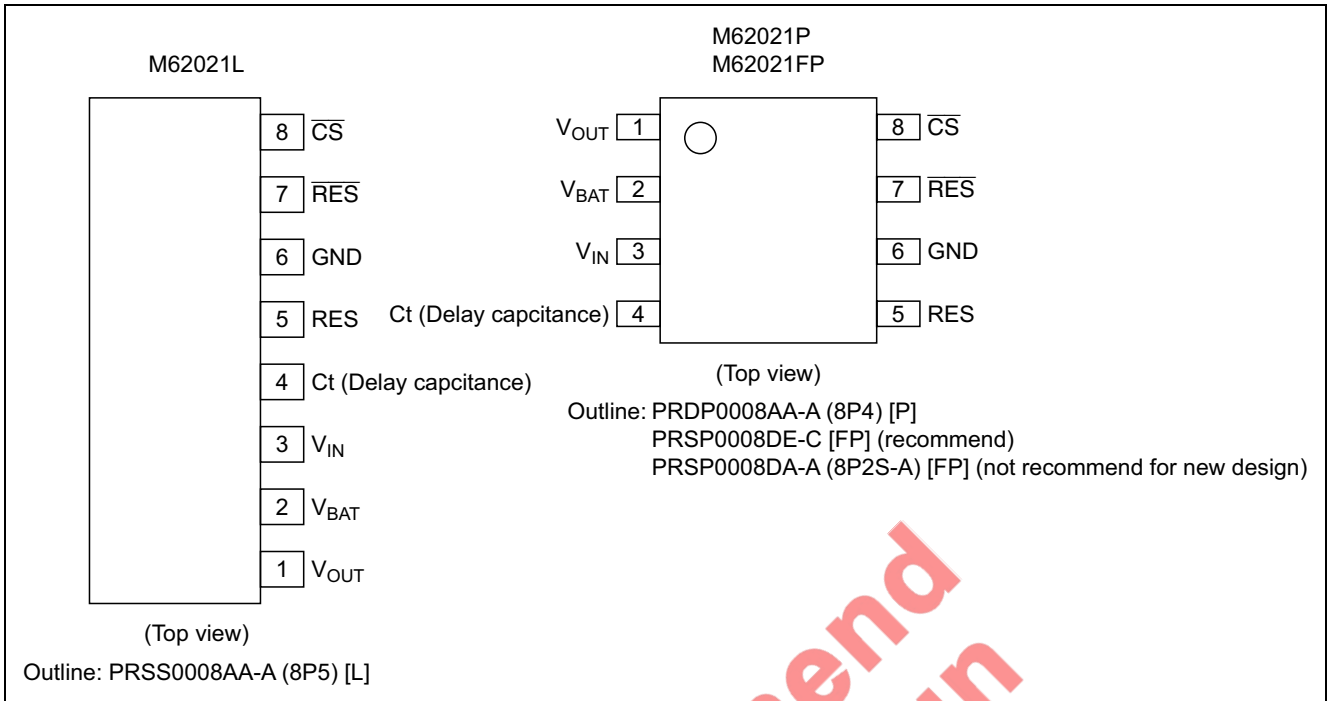

Not recommend
for new design

Absolute Maximum Ratings

(Ta = 25°C, unless otherwise noted)

Item	Symbol	Ratings	Unit	Conditions	
Input voltage	V _{IN}	7	V		
Output current	I _{OUT}	100	mA		
Power dissipation	Pd	800	mW	8-pin SIP	
		625		8-pin DIP	
		440		8-pin SOP	
Thermal derating	Kθ	8	mW/°C	Ta ≥ 25°C	8-pin SIP
		6.25			8-pin DIP
		4.4			8-pin SOP
Operating temperature	Topr	-20 to +75	°C		
Storage temperature	Tstg	-40 to +125	°C		

Electrical Characteristics

(Ta = 25°C, unless otherwise noted)

Item	Symbol	Min	Typ	Max	Unit	Test Conditions	
Detection voltage	V _S	4.2	4.4	4.6	V	V _{IN} (at the change from H→L)	
Hysteresis voltage	ΔV _S	50	100	200	mV	ΔV _S = V _{SH} - V _{SL}	
Temperature coefficient of detection voltage	V _S /ΔT	—	0.005	—	%/°C		
Circuit current	I _{CC}	—	2.0	4.0	mA	I _{OUT} = 0mA	V _{IN} = 4V
		—	7.5	12.0			V _{IN} = 5V
Difference between input and output voltage	V _{DROP}	—	0.125	0.25	V	V _{IN} = 5V	I _{OUT} = 50mA
		—	0.2	0.4			I _{OUT} = 80mA
Ct output voltage (high level)	V _{OH(Ct)}	4.5	5.0	—	V	V _{IN} = 5V *1	
Ct output voltage (low level)	V _{OL(Ct)}	—	0.02	0.1	V	V _{IN} = 4V *1	
RES output voltage (high level)	V _{OH(RES)}	3.5	4.0	—	V	V _{IN} = 4V *1	
RES output voltage (low level)	V _{OL(RES)}	—	0.02	—	V	V _{IN} = 5V	*1
		—	0.05	0.2			I _{sink} = 1mA
RES output voltage (high level)	V _{OH(RES)}	4.5	5.0	—	V	V _{IN} = 5V *1	
RES output voltage (low level)	V _{OL(RES)}	—	0.02	—	V	V _{IN} = 4V	*1
		—	0.05	0.2			I _{sink} = 1mA
CS output voltage (high level)	V _{OH(CS)}	3.50	3.57	—	V	V _{IN} = 4V *2	
		2.40	2.47	—		V _{IN} = 0V, V _{BAT} = 3V *2	
CS output voltage (low level)	V _{OL(CS)}	—	0.08	—	V	V _{IN} = 5V	*1
		—	0.1	0.3			I _{sink} = 1mA
Backup diode leakage current	I _R	—	—	±0.5	μA	V _{BAT} = 3V	V _{IN} = 5V
		—	—	±0.5			V _{IN} = 0V
Backup diode forward direction voltage	V _F	—	0.54	0.6	V	I _F = 10μA	
Delay time	t _{pd}	10	27	55	ms	V _{IN} = 0V→5V, Ct = 4.7μF	
Response time	t _d	—	5.0	25.0	μs	V _{IN} = 5V→4V	
RES limit voltage of operation	V _{OPL(RES)}	—	0.65	—	V	*3	

Notes: 1. Regarding conditions to measure V_{OH} and V_{OL}, voltage values are to be generated by internal resistance only and no external resistor is used.

2. These values are produced inserting an external resistor, R_{C \bar{S}} = 1 MΩ, between the C \bar{S} pin and GND.

3. With no external resistor (10 kΩ internal resistance only)

Test Circuit

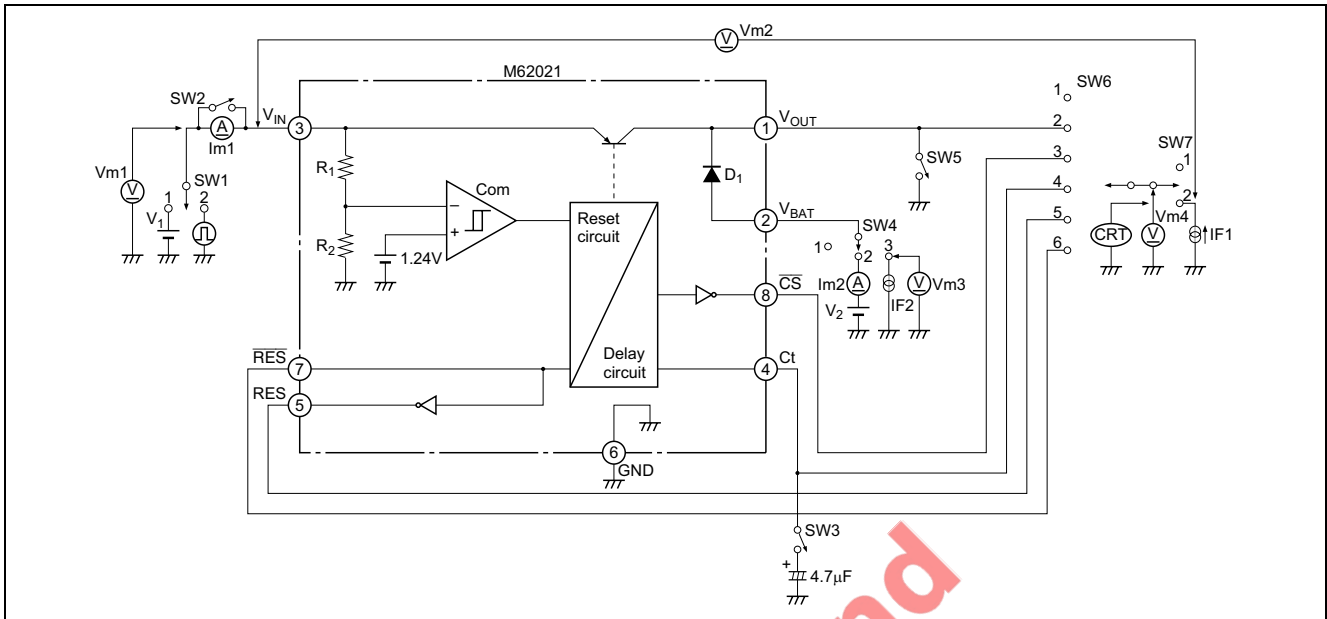

Figure 1 Test Circuit

Switch Matrix

Item	Symbol	V1	V2	IF1	IF2	SW							Measuring Instrument			
						1	2	3	4	5	6	7				
Circuit current	I_{CC}	4V	—	—	—	1	ON	OFF	1	OFF	1	1	Im1			
		5V				1	ON	OFF	1	OFF	1	1				
Detection voltage (V_{IN} negative-going)	V_{OUT}	Decrease from 5V	—	—	—	1	ON	OFF	1	OFF	2	1	*2 Vm4 CRT Vm1			
	CS										3					
	Ct										4					
	RES										5					
	RES										6					
Difference between input and output voltage	V_{DROP}	5V	—	-50mA	—	1	ON	OFF	1	OFF	2	2	Vm2			
Ct output voltage (high level)	$V_{OH(Ct)}$	5V	—	—	—	1	ON	OFF	1	OFF	4	1	Vm4			
Ct output voltage (low level)	$V_{OL(Ct)}$	4V	—	—	—	1	ON	OFF	1	OFF	4	1	Vm4			
RES output voltage (high level)	$V_{OH(RES)}$	4V	—	—	—	1	ON	OFF	1	OFF	5	1	Vm4			
RES output voltage (low level)	$V_{OL(RES)}$	5V	—	—	—	1	ON	OFF	1	OFF	5	2				
RES output voltage (high level)	$V_{OH(RES)}$	5V	—	—	—	1	ON	OFF	1	OFF	6	1	Vm4			
RES output voltage (low level)	$V_{OL(RES)}$	4V	—	—	—	1	ON	OFF	1	OFF	6	2				
CS output voltage (high level) *1	$V_{OH(CS)}$	4V	—	—	—	1	ON	OFF	1	OFF	3	1	Vm4			
CS output voltage (low level)	$V_{OL(CS)}$	0V	3V	—	—											
Backup diode leakage current	I_R	5V	3V	—	—	1	ON	OFF	2	OFF	1	1	Im2			
Backup diode forward direction voltage	V_F	0V												—	—	10µA
Delay time Response time	V_{OUT}	—	—	—	—	2	*3	ON	ON	*4	1	OFF	1	CRT		
	CS														t_{pd}	2
	RES														t_d	3
	RES														t_d	5
											6					

Notes: 1. To measure $V_{OH(CS)}$, insert a 1 MΩ resistor between the CS pin and GND.

2. While monitoring each output by Vm4 or CRT, measure the input voltage Vm1 when the output goes from H to L and L to H. Regarding V_{SH} , raise V_{IN} from 4 V and measure the input voltage Vm1 when the output goes from H to L and L to H. ΔV_S is $V_{SH} - V_{SL}$.

3. To measure delay time, change V_{IN} from 0 V to 5 V and compare, with respect to each pin, the positive-going edge observed on a monitor with that of V_{IN} . To measure response time, change V_{IN} from 5 V to 4 V and compare, with respect to each pin, the negative-going edge observed on a monitor with that of V_{IN} .

4. Set the switch to OFF when measuring response time.

Pin Description

Pin No.	Pin Name	Symbol	Function
1	Power supply output	V_{OUT}	V_{IN} and V_{BAT} are controlled by means of an internal switch and output through V_{OUT} . The pin is capable of outputting up to 100 mA. Use it as V_{DD} of CMOS RAM and the like.
2	Backup power supply input	V_{BAT}	Backup power supply is connected to this pin. If a lithium battery is used, insert a resistor in series for safety purposes.
3	Power supply input	V_{IN}	+5 V input pin. Connect to a logic power supply.
4	Delay capacitor connection pin	C_t	A delay capacitor is connected to this pin. By connecting a capacitor, it is possible to delay each output.
5	Positive reset output	RES	Connect to the positive reset input of a microcomputer. The pin is capable of flowing 1 mA sink current.
6	Ground	GND	Reference for all signals.
7	Negative reset output	\overline{RES}	Connect to the negative reset input of a microcomputer. The pin is capable of flowing 1 mA sink current.
8	Chip select output	\overline{CS}	Connect to the chip select of RAM. The CS output is at low level in normal state thereby letting RAM be active. Under failure or backup condition, the CS output is set to high level, then RAM enters standby state disabling read/write function. The pin is capable of flowing a 1 mA sink current.

Application Example

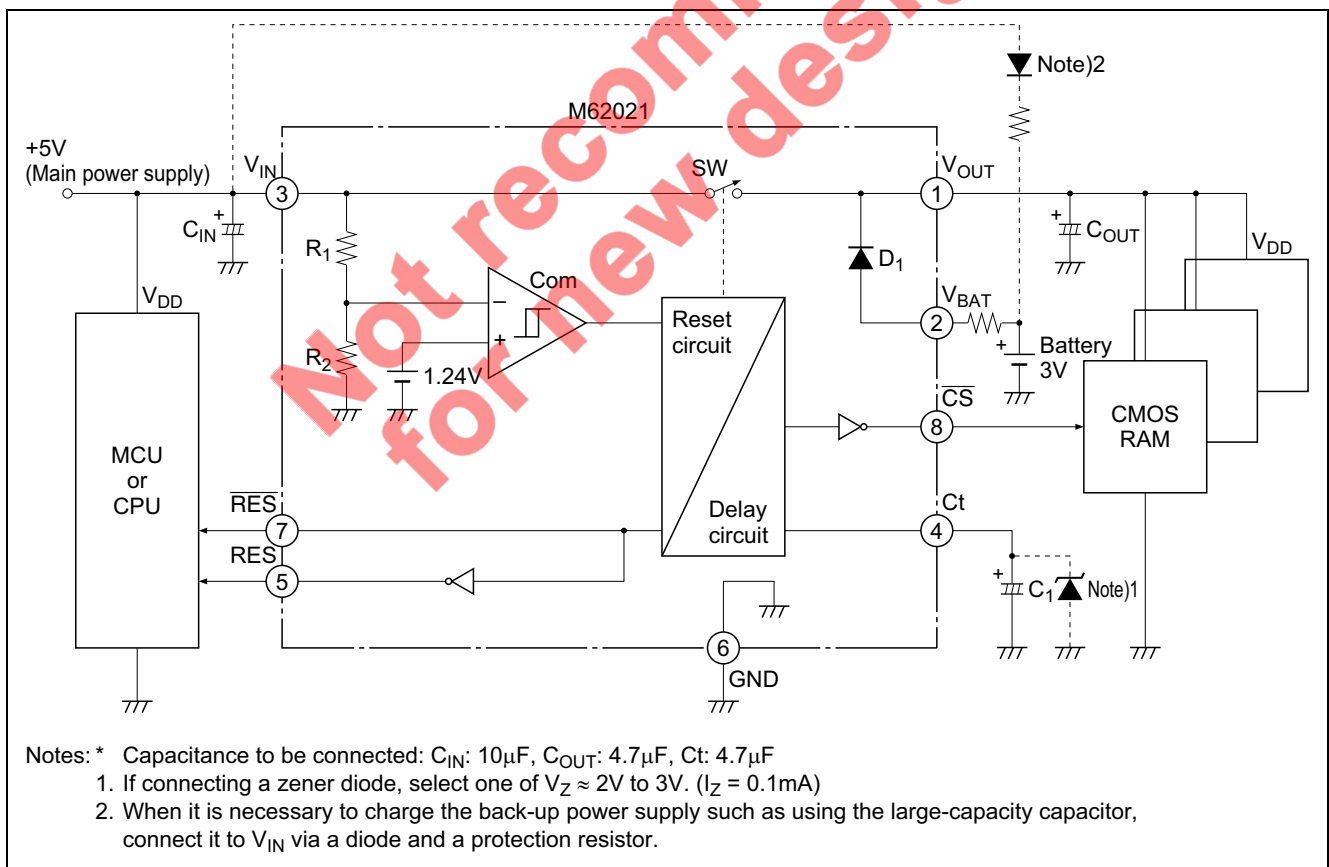

Figure 2 Application Example

Configuration

Power Supply Detection

The internal reference voltage V_{ref} is compared by means of a comparator with resistor-divided voltage V_R (resistor-divided voltage produced by R_1 and R_2 from V_{IN}).

If the input voltage is 5 V, V_R is set to 1.24 V or higher, so the comparator output is at low level and the Ct output (Q_1 collector output) is set to high level. If the input voltage drops to below 4.4 V in an abnormal condition, V_R becomes below 1.24 V, so the comparator output goes from low to high level and the Ct output, from high to low. The input voltage at this point is called V_{SL} . Next, when the input voltage, restored from abnormal state, has a rise, the comparator output goes from high to low level and the Ct output, from low to high.

The comparator used for detection has 100 mV hysteresis (ΔV_S), so that malfunctioning is prevented in case that the input voltage slowly drops or V_R nearly equals V_{ref} .

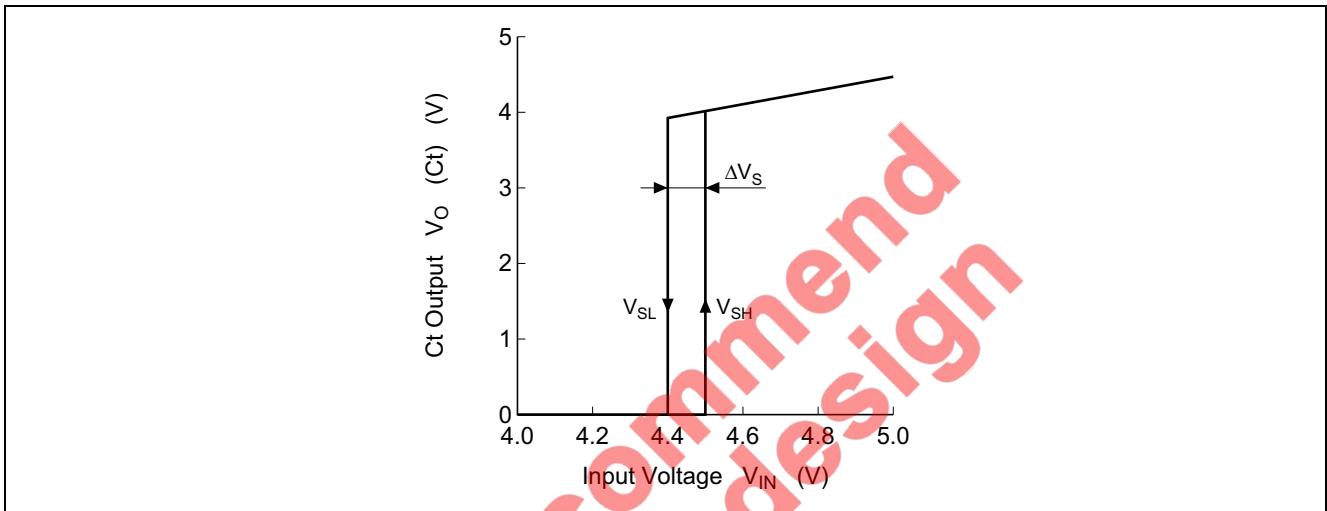

Figure 3

Delay Circuit

Connecting an external capacitor to the Ct pin lets \overline{RES} , \overline{RES} , \overline{CS} , and V_{OUT} be delayed due to RC transient phenomenon (electric charge).

Delay time is determined as follows.

$$\begin{aligned} \text{Delay time } (t_{pd}) &= C_1 \times (R_3 + R_4) \times 1n \frac{[V_{OH}(Ct) - V_{OL}(Ct)]}{[V_{OH}(Ct) - INV1(V_{TH})]} \\ &= C_1 \times 22k\Omega \times 0.2614 \\ &\approx 5.75 \times 10^3 \times C_1 \end{aligned}$$

* C is an external capacitance.

Taking into consideration the time taken by the oscillator of microcomputer to be stable, connect a 4.7 μF capacitor to the Ct pin. (As the response time of detection can be slowed due to internal structure depending in the rising rate of power supply, avoid connecting a too large capacitance.)

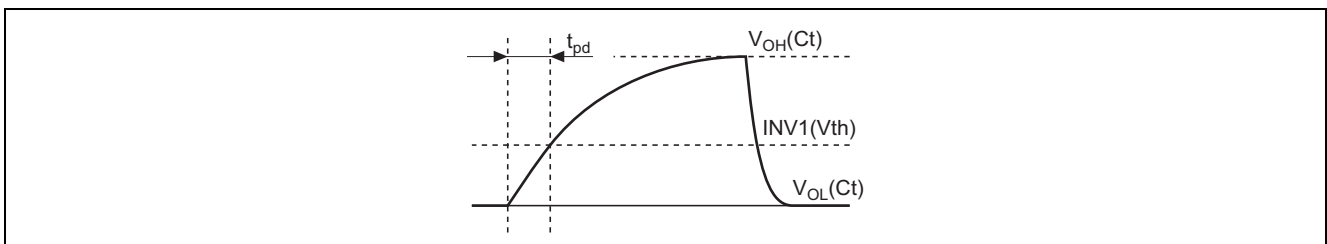

Figure 4 Delayed Output Waveforms of Ct

Schmitt Trigger Circuit

Since waveforms show a gentle rise due to the RC delay circuit, INV1, INV2, R5, and R6 constitute a Schmitt trigger circuit to produce hysteresis so as to prevent each output from chattering.

Internal Circuit

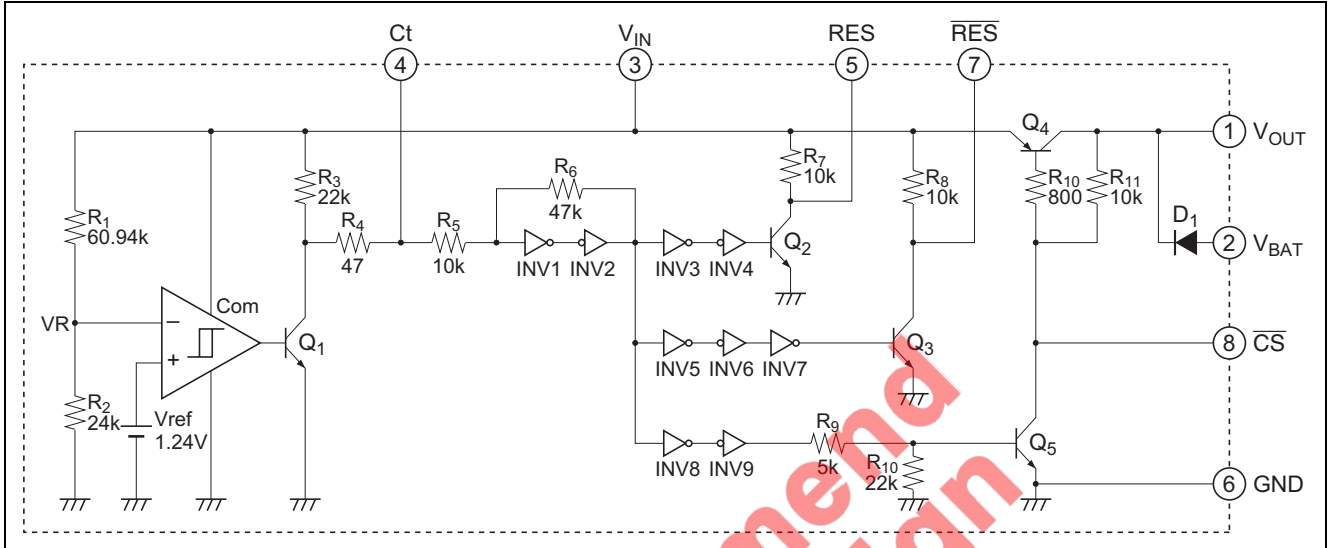

Figure 5 Internal Circuit

Not recommended for new design

Timing Chart

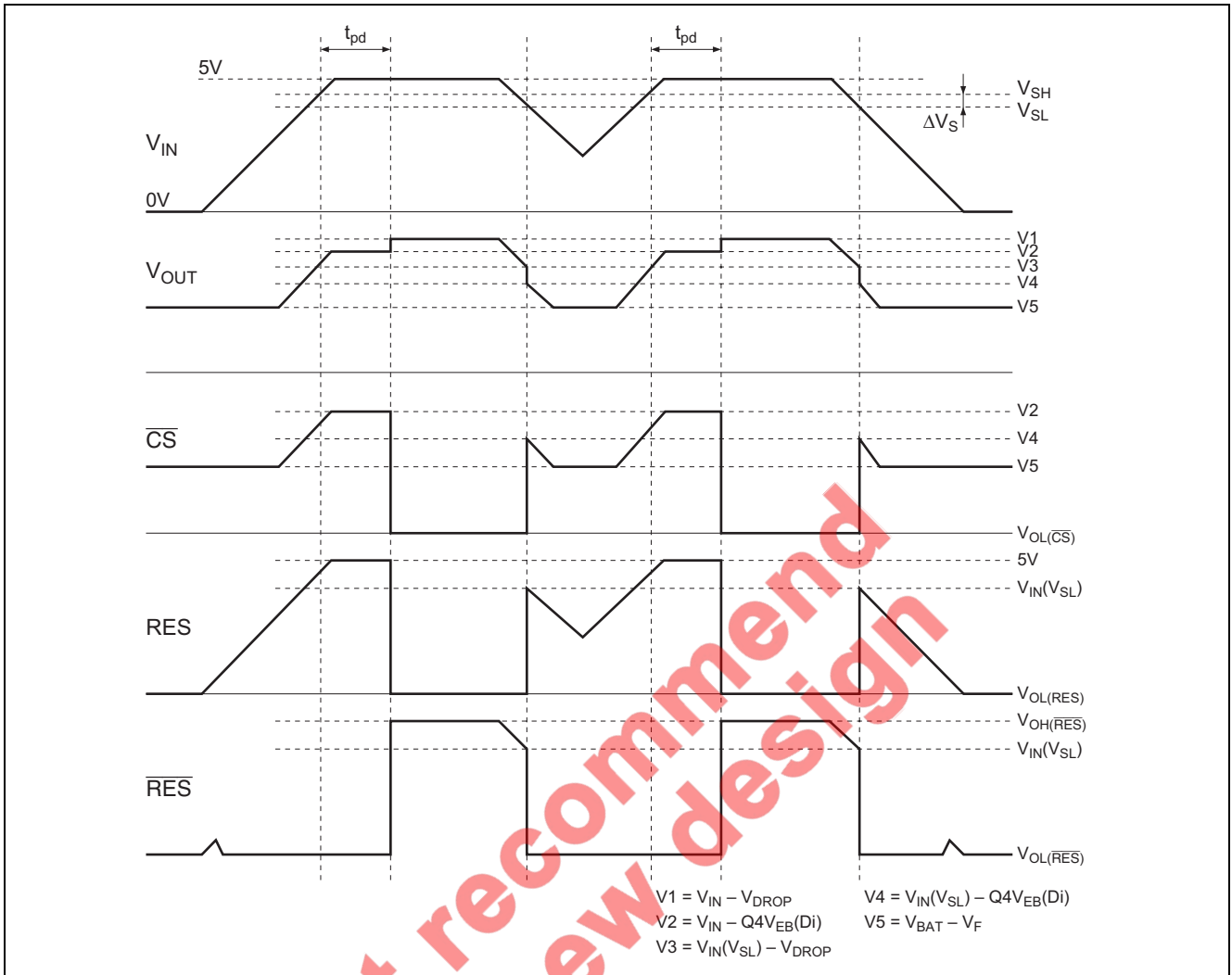
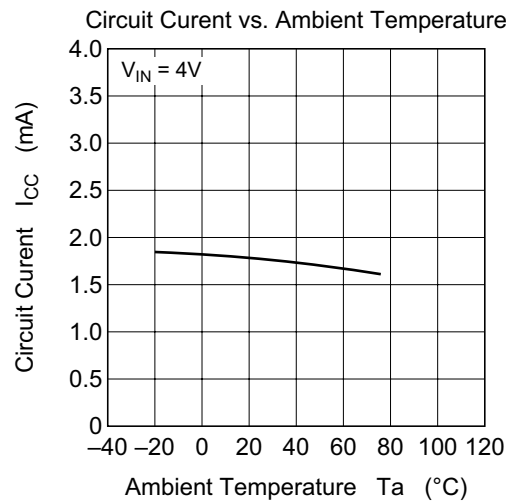
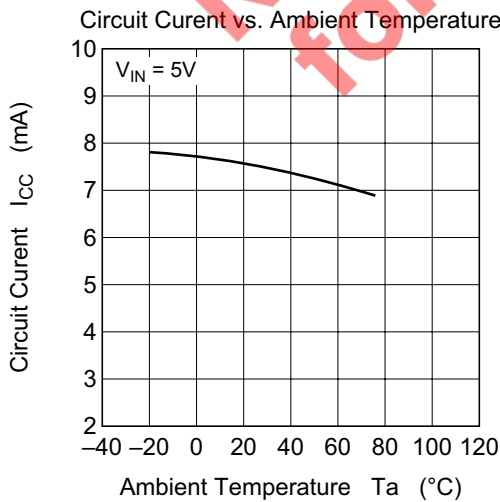
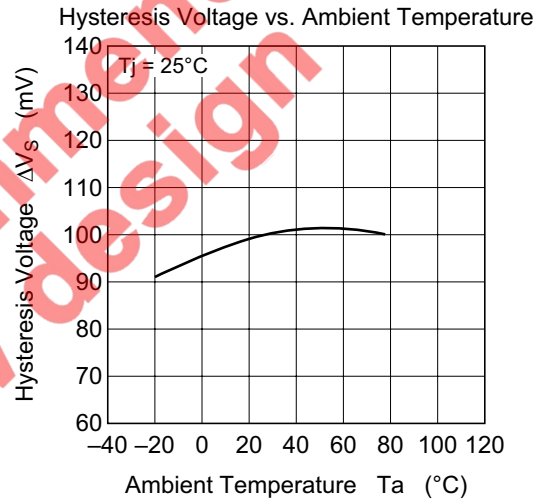
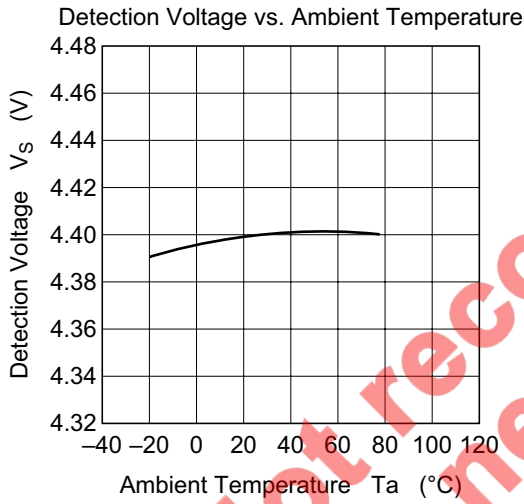
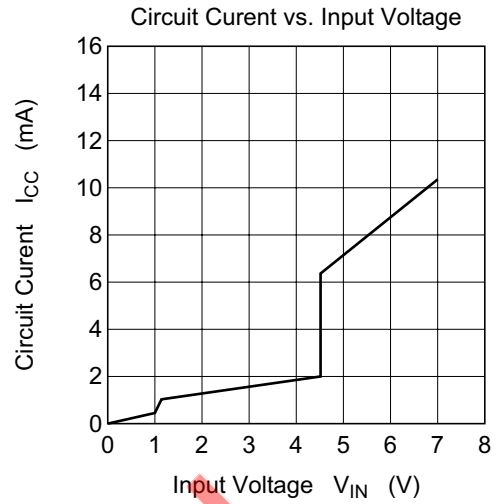
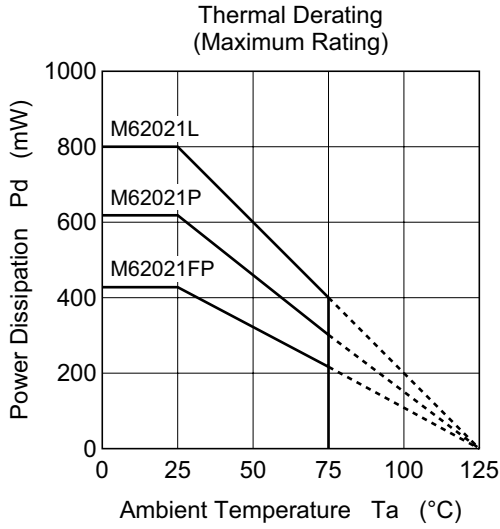
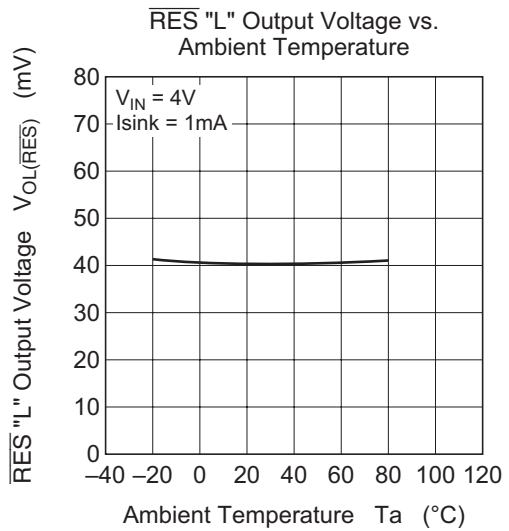
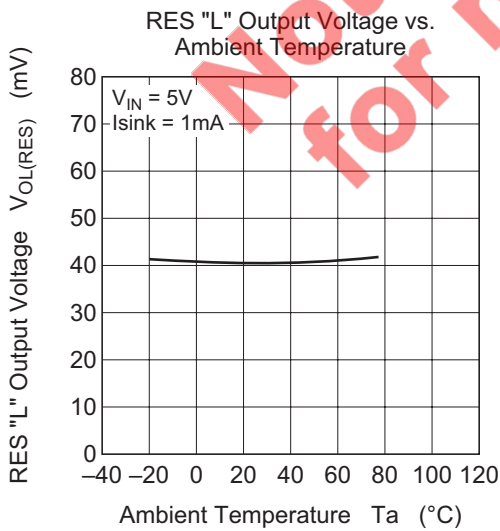
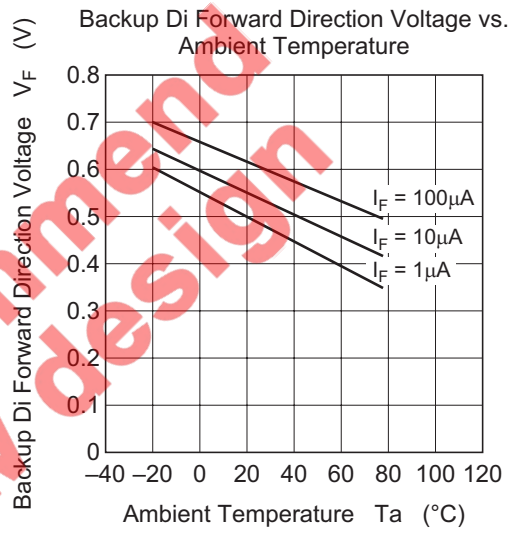
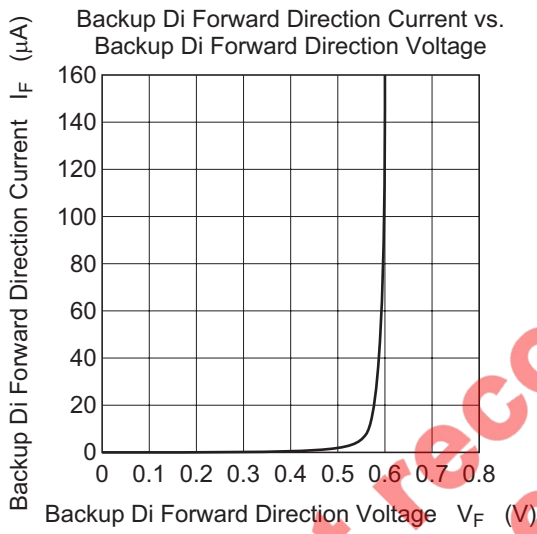
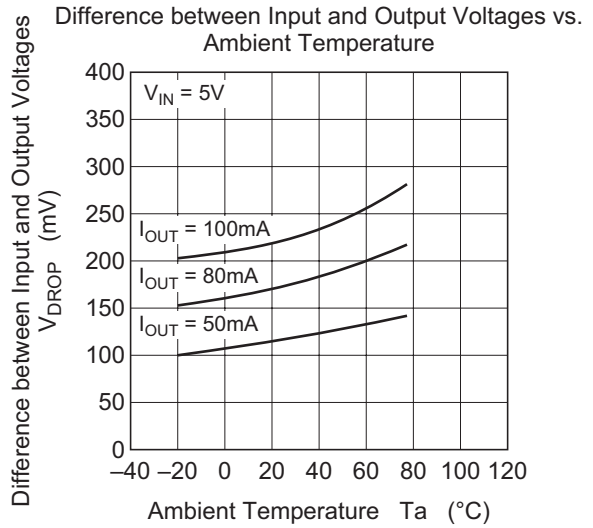
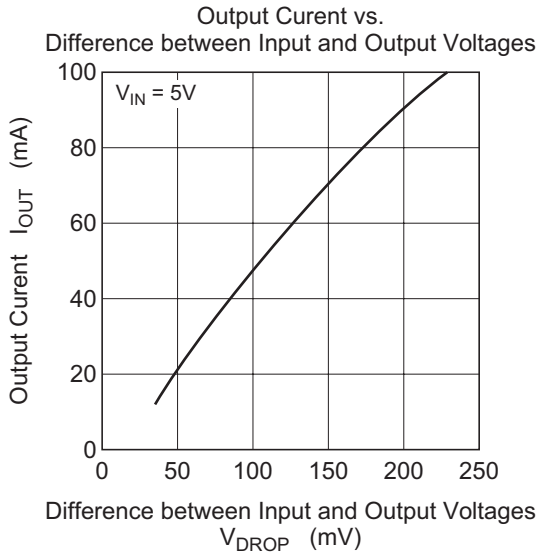

Figure 6 Timing Chart

Input Voltage / Output Pin	In Normal Operation	In Failure (Instantaneous Drop)	Restoration from Failure (Instantaneous Drop)	In Backup State
		Input voltage: 5V	Input voltage: 5V→4V Each output varies if the input voltage drops to V_{SL} or under	Input voltage: 4V→5V If the input voltage goes higher than V_{SL} by 100mV, each output varies after delay produced by the delay circuit
V_{OUT}	With Q4 set to ON, a voltage ($V_{IN} - V_{DROD}$) is output	Q4 is turned OFF. A voltage ($V_{IN} - Q4V_{EB}(Di)$) is output by the diode between E and B of Q4.	Q4 is turned ON after delay and a voltage ($V_{IN} - V_{DROD}$) is output.	$V_{BAT} - V_F$
RES	The output level is $V_{OL}(\overline{RES})$ with a logic low	As the state shifts from a logic low to logic high, the output level becomes approximately equal to the input voltage.	A logic high is maintained, and then shifts to a logic high.	—
\overline{RES}	The output level is $V_{OH}(\overline{RES})$ with a logic low	As the state shifts from a logic high to logic low, the output level becomes $V_{OL}(\overline{RES})$.	A logic low is held, and then shifts to a logic high.	—
\overline{CS}	The output level is $V_{OL}(\overline{CS})$ with a logic low	As the state shifts from a logic low to logic high, the output level becomes the voltage $V_{IN} - Q4V_{EB}(Di)$.	A logic high is maintained, and then shifts to a logic high.	The output is a logic high and the output level is $V_{BAT} - V_F$

Typical Characteristics





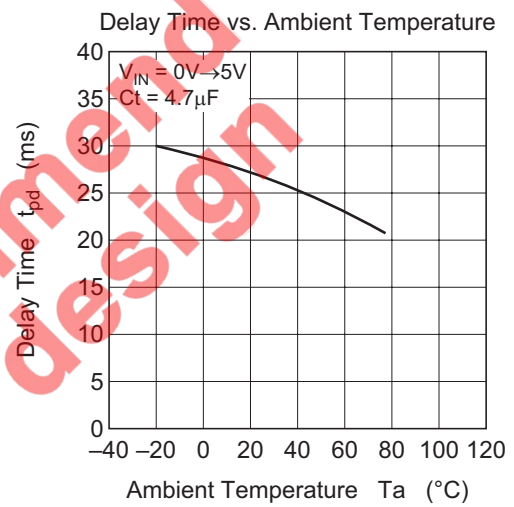
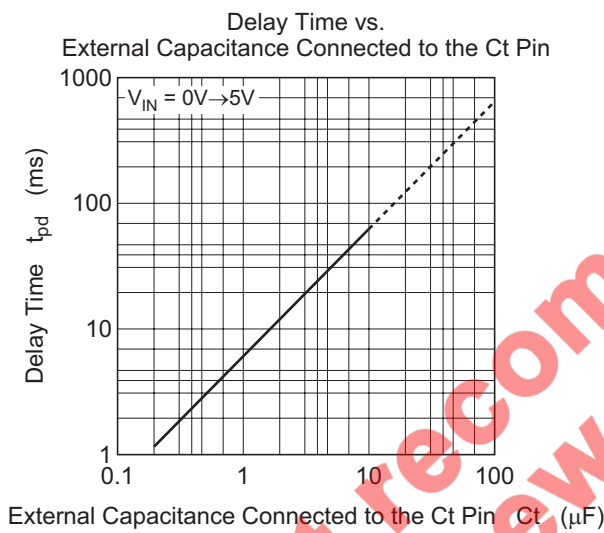
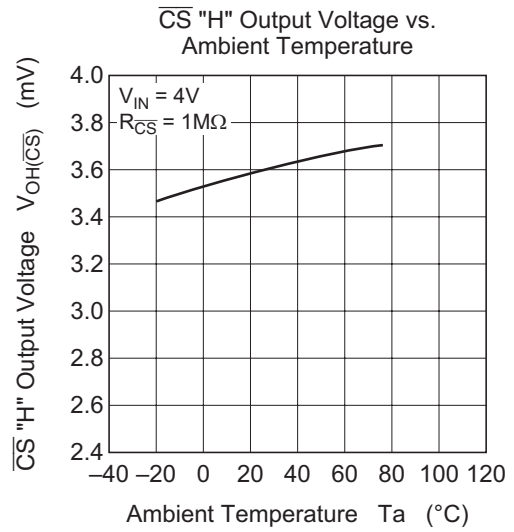
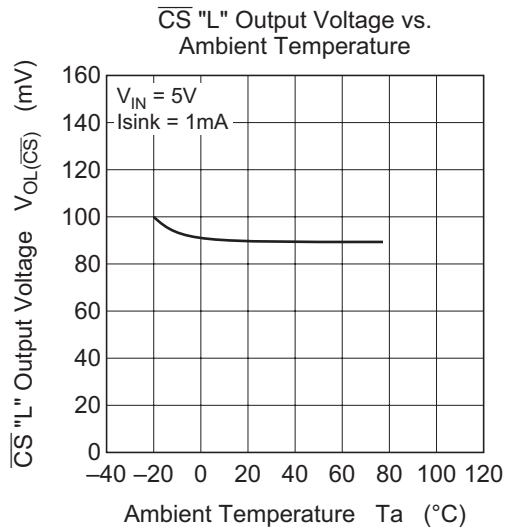

Not recommended for new design

Package Dimensions

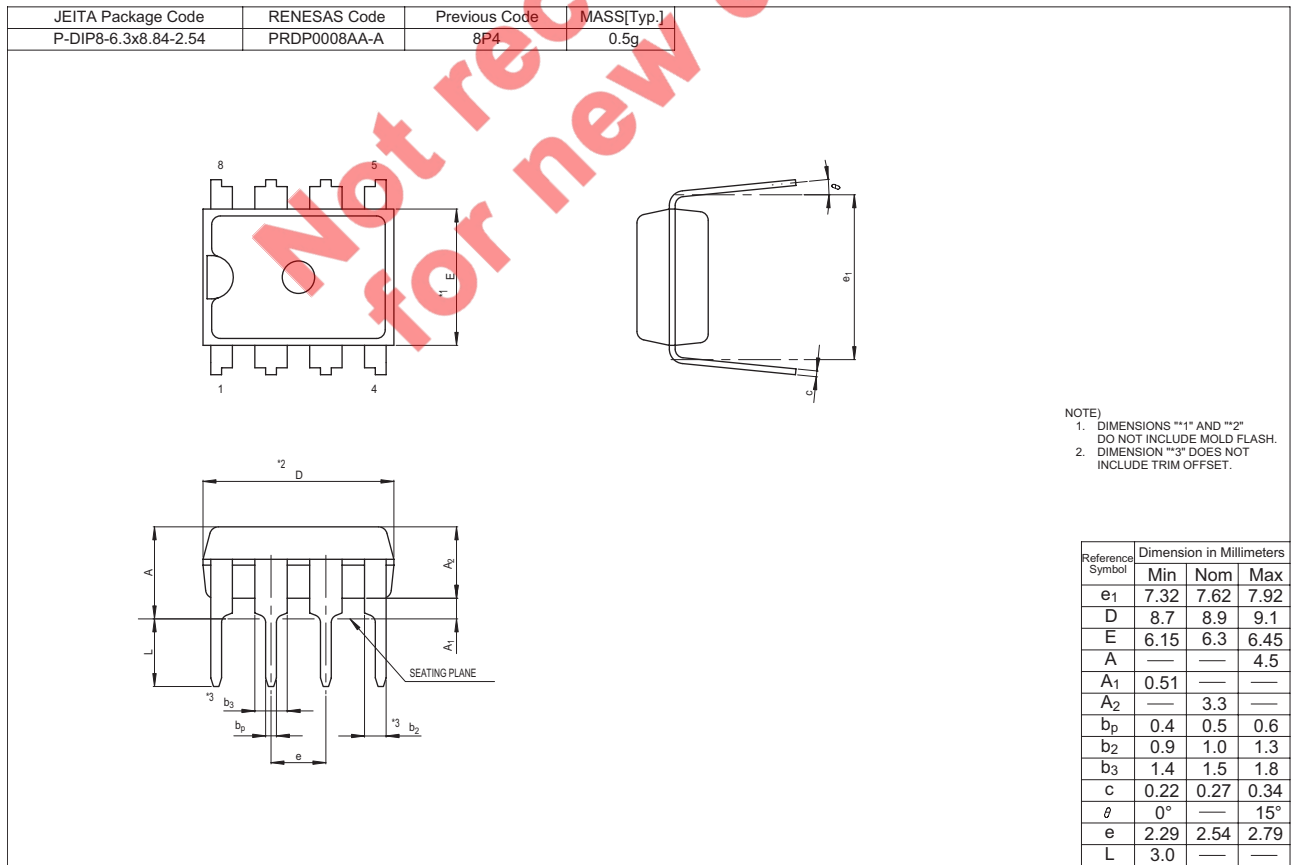
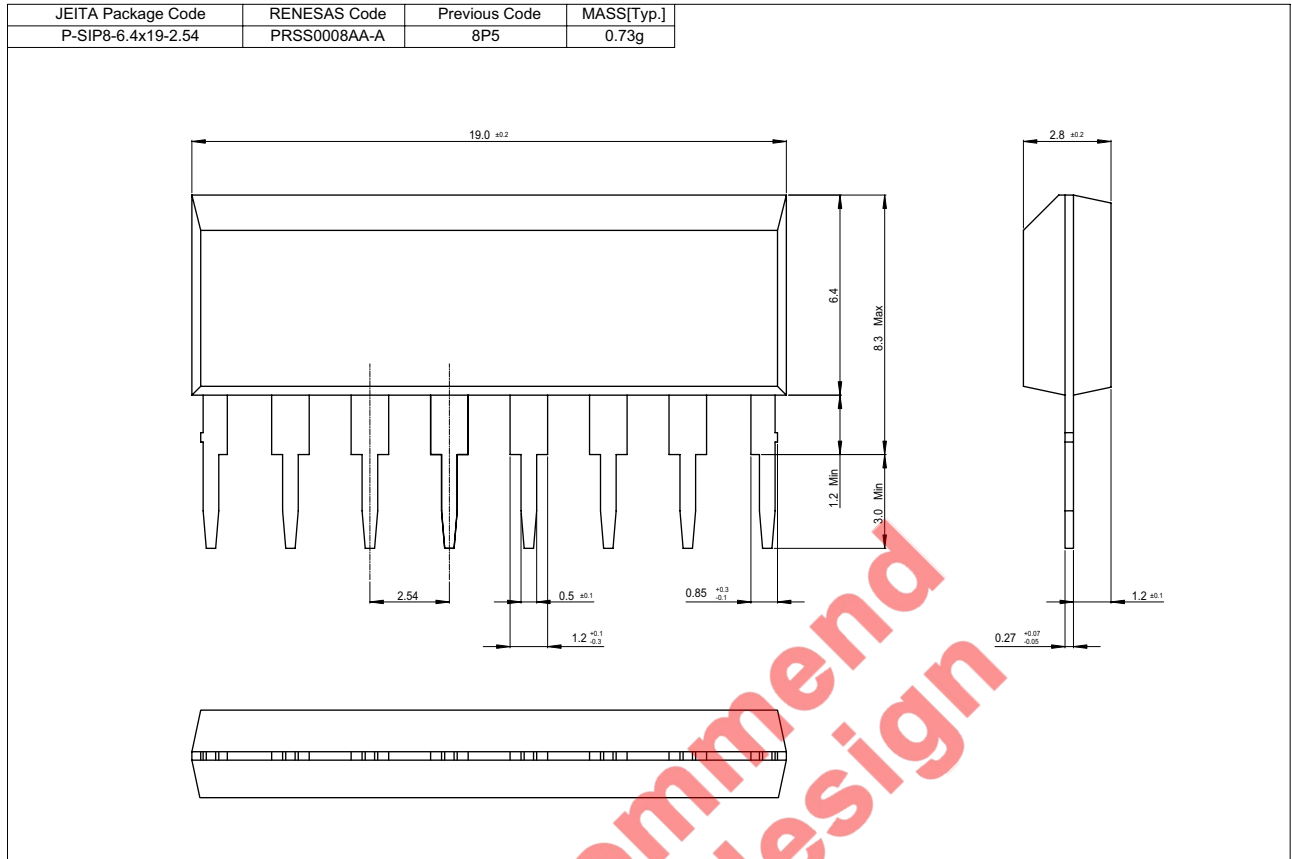

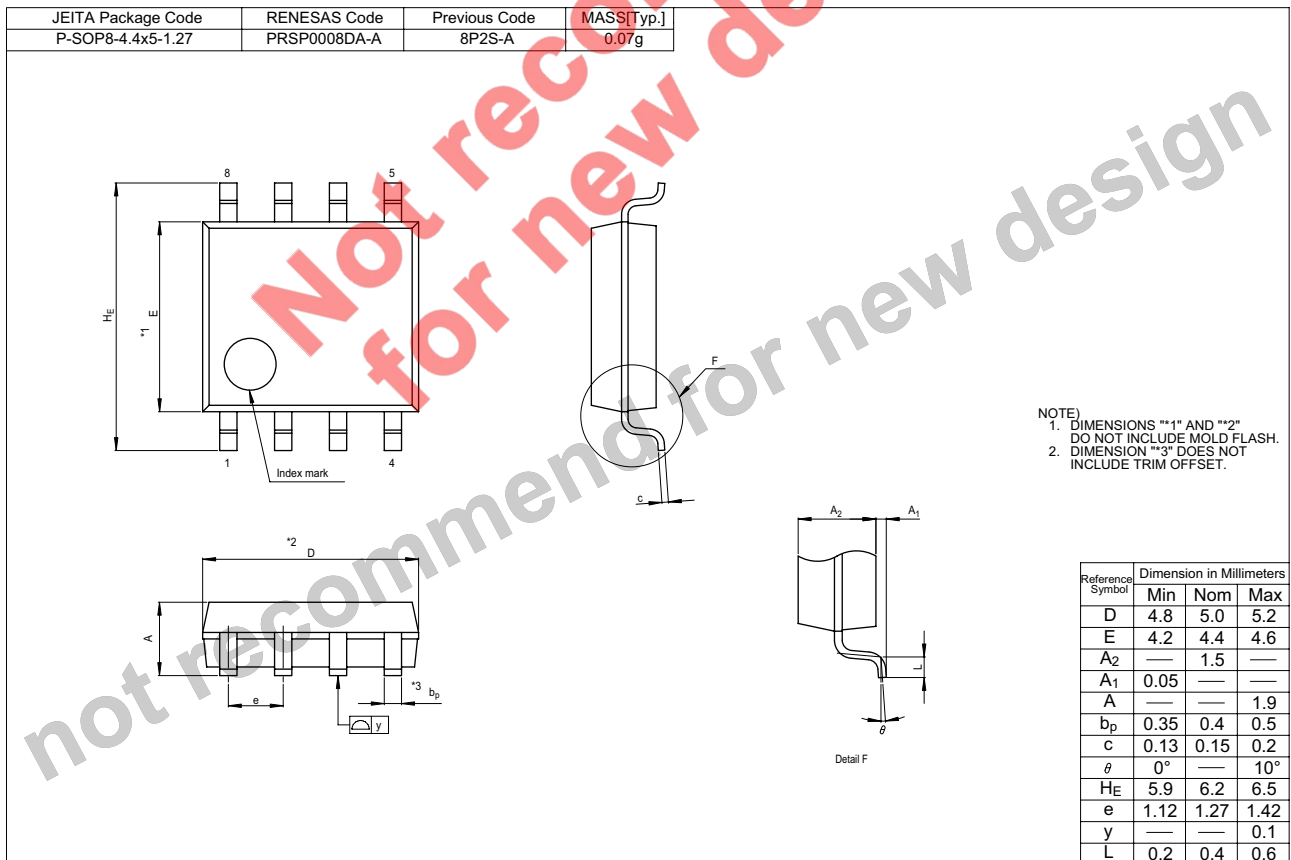
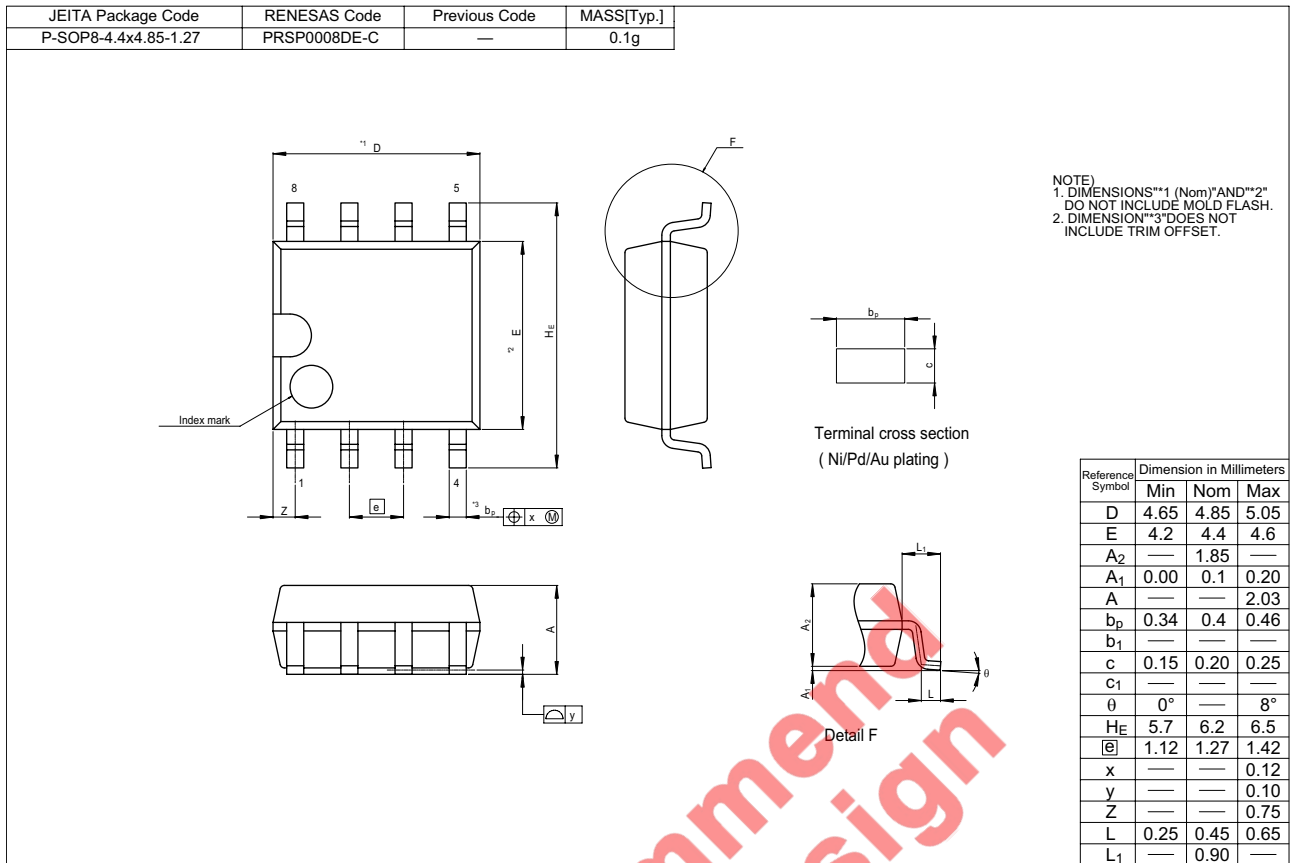

Notes:

1. This document is provided for reference purposes only so that Renesas customers may select the appropriate Renesas products for their use. Renesas neither makes warranties or representations with respect to the accuracy or completeness of the information contained in this document nor grants any license to any intellectual property rights or any other rights of Renesas or any third party with respect to the information in this document.
2. Renesas shall have no liability for damages or infringement of any intellectual property or other rights arising out of the use of any information in this document, including, but not limited to, product data, diagrams, charts, programs, algorithms, and application circuit examples.
3. You should not use the products or the technology described in this document for the purpose of military applications such as the development of weapons of mass destruction or for the purpose of any other military use. When exporting the products or technology described herein, you should follow the applicable export control laws and regulations, and procedures required by such laws and regulations.
4. All information included in this document such as product data, diagrams, charts, programs, algorithms, and application circuit examples, is current as of the date this document is issued. Such information, however, is subject to change without any prior notice. Before purchasing or using any Renesas products listed in this document, please confirm the latest product information with a Renesas sales office. Also, please pay regular and careful attention to additional and different information to be disclosed by Renesas such as that disclosed through our website. (<http://www.renesas.com>)
5. Renesas has used reasonable care in compiling the information included in this document, but Renesas assumes no liability whatsoever for any damages incurred as a result of errors or omissions in the information included in this document.
6. When using or otherwise relying on the information in this document, you should evaluate the information in light of the total system before deciding about the applicability of such information to the intended application. Renesas makes no representations, warranties or guaranties regarding the suitability of its products for any particular application and specifically disclaims any liability arising out of the application and use of the information in this document or Renesas products.
7. With the exception of products specified by Renesas as suitable for automobile applications, Renesas products are not designed, manufactured or tested for applications or otherwise in systems the failure or malfunction of which may cause a direct threat to human life or create a risk of human injury or which require especially high quality and reliability such as safety systems, or equipment or systems for transportation and traffic, healthcare, combustion control, aerospace and aeronautics, nuclear power, or undersea communication transmission. If you are considering the use of our products for such purposes, please contact a Renesas sales office beforehand. Renesas shall have no liability for damages arising out of the uses set forth above.
8. Notwithstanding the preceding paragraph, you should not use Renesas products for the purposes listed below:
 - (1) artificial life support devices or systems
 - (2) surgical implantations
 - (3) healthcare intervention (e.g., excision, administration of medication, etc.)
 - (4) any other purposes that pose a direct threat to human lifeRenesas shall have no liability for damages arising out of the uses set forth in the above and purchasers who elect to use Renesas products in any of the foregoing applications shall indemnify and hold harmless Renesas Technology Corp., its affiliated companies and their officers, directors, and employees against any and all damages arising out of such applications.
9. You should use the products described herein within the range specified by Renesas, especially with respect to the maximum rating, operating supply voltage range, movement power voltage range, heat radiation characteristics, installation and other product characteristics. Renesas shall have no liability for malfunctions or damages arising out of the use of Renesas products beyond such specified ranges.
10. Although Renesas endeavors to improve the quality and reliability of its products, IC products have specific characteristics such as the occurrence of failure at a certain rate and malfunctions under certain use conditions. Please be sure to implement safety measures to guard against the possibility of physical injury, and injury or damage caused by fire in the event of the failure of a Renesas product, such as safety design for hardware and software including but not limited to redundancy, fire control and malfunction prevention, appropriate treatment for aging degradation or any other applicable measures. Among others, since the evaluation of microcomputer software alone is very difficult, please evaluate the safety of the final products or system manufactured by you.
11. In case Renesas products listed in this document are detached from the products to which the Renesas products are attached or affixed, the risk of accident such as swallowing by infants and small children is very high. You should implement safety measures so that Renesas products may not be easily detached from your products. Renesas shall have no liability for damages arising out of such detachment.
12. This document may not be reproduced or duplicated, in any form, in whole or in part, without prior written approval from Renesas.
13. Please contact a Renesas sales office if you have any questions regarding the information contained in this document, Renesas semiconductor products, or if you have any other inquiries.



RENESAS SALES OFFICES

<http://www.renesas.com>

Refer to "<http://www.renesas.com/en/network>" for the latest and detailed information.

Renesas Technology America, Inc.

450 Holger Way, San Jose, CA 95134-1368, U.S.A
Tel: <1> (408) 382-7500, Fax: <1> (408) 382-7501

Renesas Technology Europe Limited

Dukes Meadow, Millboard Road, Bourne End, Buckinghamshire, SL8 5FH, U.K.
Tel: <44> (1628) 585-100, Fax: <44> (1628) 585-900

Renesas Technology (Shanghai) Co., Ltd.

Unit 204, 205, AZIACenter, No.1233 Lujiazui Ring Rd, Pudong District, Shanghai, China 200120
Tel: <86> (21) 5877-1818, Fax: <86> (21) 6887-7898

Renesas Technology Hong Kong Ltd.

7th Floor, North Tower, World Finance Centre, Harbour City, 1 Canton Road, Tsimshatsui, Kowloon, Hong Kong
Tel: <852> 2265-6688, Fax: <852> 2730-6071

Renesas Technology Taiwan Co., Ltd.

10th Floor, No.99, Fushing North Road, Taipei, Taiwan
Tel: <886> (2) 2715-2888, Fax: <886> (2) 2713-2999

Renesas Technology Singapore Pte. Ltd.

1 Harbour Front Avenue, #06-10, Keppel Bay Tower, Singapore 098632
Tel: <65> 6213-0200, Fax: <65> 6278-8001

Renesas Technology Korea Co., Ltd.

Kukje Center Bldg. 18th Fl., 191, 2-ka, Hangang-ro, Yongsan-ku, Seoul 140-702, Korea
Tel: <82> (2) 796-3115, Fax: <82> (2) 796-2145

Renesas Technology Malaysia Sdn. Bhd

Unit 906, Block B, Menara Amcorp, Amcorp Trade Centre, No.18, Jalan Persiaran Barat, 46050 Petaling Jaya, Selangor Darul Ehsan, Malaysia
Tel: <603> 7955-9390, Fax: <603> 7955-9510