

To our customers,

Old Company Name in Catalogs and Other Documents

On April 1st, 2010, NEC Electronics Corporation merged with Renesas Technology Corporation, and Renesas Electronics Corporation took over all the business of both companies. Therefore, although the old company name remains in this document, it is a valid Renesas Electronics document. We appreciate your understanding.

Renesas Electronics website: <http://www.renesas.com>

April 1st, 2010
Renesas Electronics Corporation

Issued by: Renesas Electronics Corporation (<http://www.renesas.com>)

Send any inquiries to <http://www.renesas.com/inquiry>.

Not recommended
for new design

Notice

1. All information included in this document is current as of the date this document is issued. Such information, however, is subject to change without any prior notice. Before purchasing or using any Renesas Electronics products listed herein, please confirm the latest product information with a Renesas Electronics sales office. Also, please pay regular and careful attention to additional and different information to be disclosed by Renesas Electronics such as that disclosed through our website.
2. Renesas Electronics does not assume any liability for infringement of patents, copyrights, or other intellectual property rights of third parties by or arising from the use of Renesas Electronics products or technical information described in this document. No license, express, implied or otherwise, is granted hereby under any patents, copyrights or other intellectual property rights of Renesas Electronics or others.
3. You should not alter, modify, copy, or otherwise misappropriate any Renesas Electronics product, whether in whole or in part.
4. Descriptions of circuits, software and other related information in this document are provided only to illustrate the operation of semiconductor products and application examples. You are fully responsible for the incorporation of these circuits, software, and information in the design of your equipment. Renesas Electronics assumes no responsibility for any losses incurred by you or third parties arising from the use of these circuits, software, or information.
5. When exporting the products or technology described in this document, you should comply with the applicable export control laws and regulations and follow the procedures required by such laws and regulations. You should not use Renesas Electronics products or the technology described in this document for any purpose relating to military applications or use by the military, including but not limited to the development of weapons of mass destruction. Renesas Electronics products and technology may not be used for or incorporated into any products or systems whose manufacture, use, or sale is prohibited under any applicable domestic or foreign laws or regulations.
6. Renesas Electronics has used reasonable care in preparing the information included in this document, but Renesas Electronics does not warrant that such information is error free. Renesas Electronics assumes no liability whatsoever for any damages incurred by you resulting from errors in or omissions from the information included herein.
7. Renesas Electronics products are classified according to the following three quality grades: “Standard”, “High Quality”, and “Specific”. The recommended applications for each Renesas Electronics product depends on the product’s quality grade, as indicated below. You must check the quality grade of each Renesas Electronics product before using it in a particular application. You may not use any Renesas Electronics product for any application categorized as “Specific” without the prior written consent of Renesas Electronics. Further, you may not use any Renesas Electronics product for any application for which it is not intended without the prior written consent of Renesas Electronics. Renesas Electronics shall not be in any way liable for any damages or losses incurred by you or third parties arising from the use of any Renesas Electronics product for an application categorized as “Specific” or for which the product is not intended where you have failed to obtain the prior written consent of Renesas Electronics. The quality grade of each Renesas Electronics product is “Standard” unless otherwise expressly specified in a Renesas Electronics data sheets or data books, etc.
 - “Standard”: Computers; office equipment; communications equipment; test and measurement equipment; audio and visual equipment; home electronic appliances; machine tools; personal electronic equipment; and industrial robots.
 - “High Quality”: Transportation equipment (automobiles, trains, ships, etc.); traffic control systems; anti-disaster systems; anti-crime systems; safety equipment; and medical equipment not specifically designed for life support.
 - “Specific”: Aircraft; aerospace equipment; submersible repeaters; nuclear reactor control systems; medical equipment or systems for life support (e.g. artificial life support devices or systems), surgical implantations, or healthcare intervention (e.g. excision, etc.), and any other applications or purposes that pose a direct threat to human life.
8. You should use the Renesas Electronics products described in this document within the range specified by Renesas Electronics, especially with respect to the maximum rating, operating supply voltage range, movement power voltage range, heat radiation characteristics, installation and other product characteristics. Renesas Electronics shall have no liability for malfunctions or damages arising out of the use of Renesas Electronics products beyond such specified ranges.
9. Although Renesas Electronics endeavors to improve the quality and reliability of its products, semiconductor products have specific characteristics such as the occurrence of failure at a certain rate and malfunctions under certain use conditions. Further, Renesas Electronics products are not subject to radiation resistance design. Please be sure to implement safety measures to guard them against the possibility of physical injury, and injury or damage caused by fire in the event of the failure of a Renesas Electronics product, such as safety design for hardware and software including but not limited to redundancy, fire control and malfunction prevention, appropriate treatment for aging degradation or any other appropriate measures. Because the evaluation of microcomputer software alone is very difficult, please evaluate the safety of the final products or system manufactured by you.
10. Please contact a Renesas Electronics sales office for details as to environmental matters such as the environmental compatibility of each Renesas Electronics product. Please use Renesas Electronics products in compliance with all applicable laws and regulations that regulate the inclusion or use of controlled substances, including without limitation, the EU RoHS Directive. Renesas Electronics assumes no liability for damages or losses occurring as a result of your noncompliance with applicable laws and regulations.
11. This document may not be reproduced or duplicated, in any form, in whole or in part, without prior written consent of Renesas Electronics.
12. Please contact a Renesas Electronics sales office if you have any questions regarding the information contained in this document or Renesas Electronics products, or if you have any other inquiries.

(Note 1) “Renesas Electronics” as used in this document means Renesas Electronics Corporation and also includes its majority-owned subsidiaries.

(Note 2) “Renesas Electronics product(s)” means any product developed or manufactured by or for Renesas Electronics.

M52347SP/FP

Sync Signal Processor

REJ03F0190-0201

Rev.2.01

Mar 31, 2008

Description

The M52347 automatically selects three types of synchronous signals containing separate sync (positive and negative polarities of 0.5 to 2.5 V_{P-P}), composite sync (positive and negative polarities of 0.5 to 2.5 V_{P-P}) and sync-on-video (sync negative polarity), and performs waveform shaping. The IC is optimum to synchronous signal processing for multi-scan type display monitor.

Features

- Low power consumption with supply voltage of 5 V
- Capable of obtaining output information on whether to input synchronous signal, and on polarity
- Output of clamp pulse
- Equipped with V TIME GATE SW that enables selecting whether or not VD portion pulse is output from pin 14/15.
- Equipped with CLAMP SW that enables switching the clamp pulse output position.

Application

Display monitor

Recommended Operating Condition

Supply voltage range: $V_{CC} = 4.5$ to 5.5 V

Rated supply voltage: $V_{CC} = 5$ V

Block Diagram

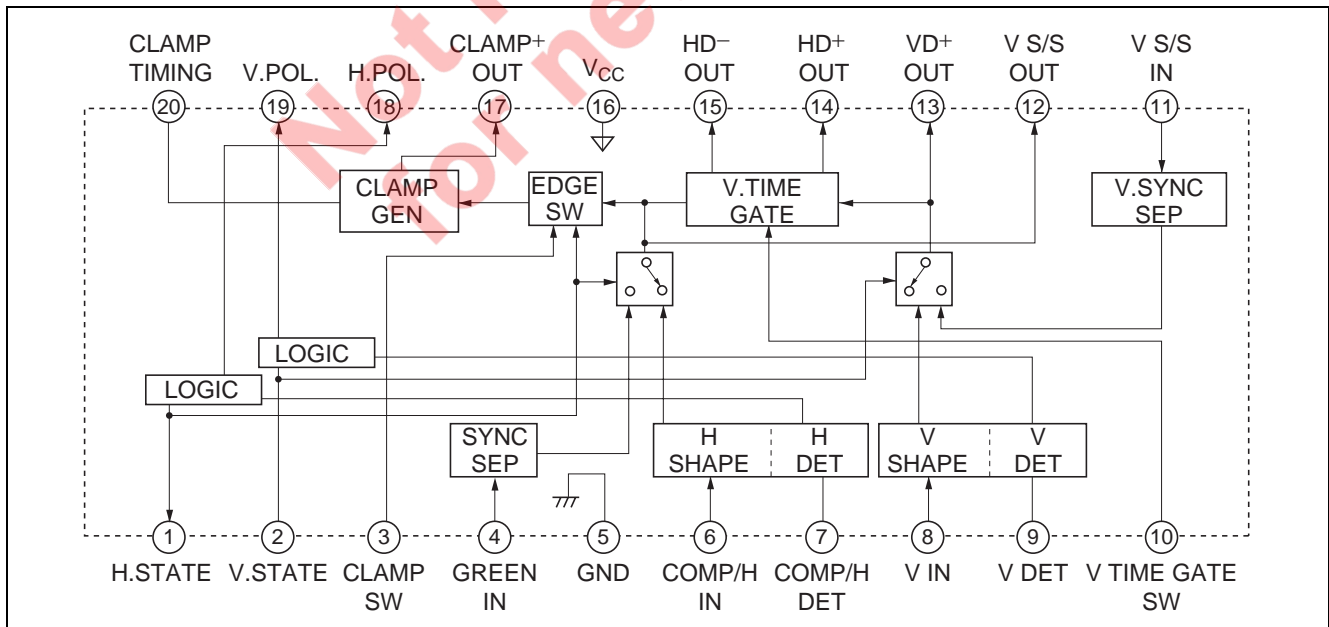

Pin Arrangement

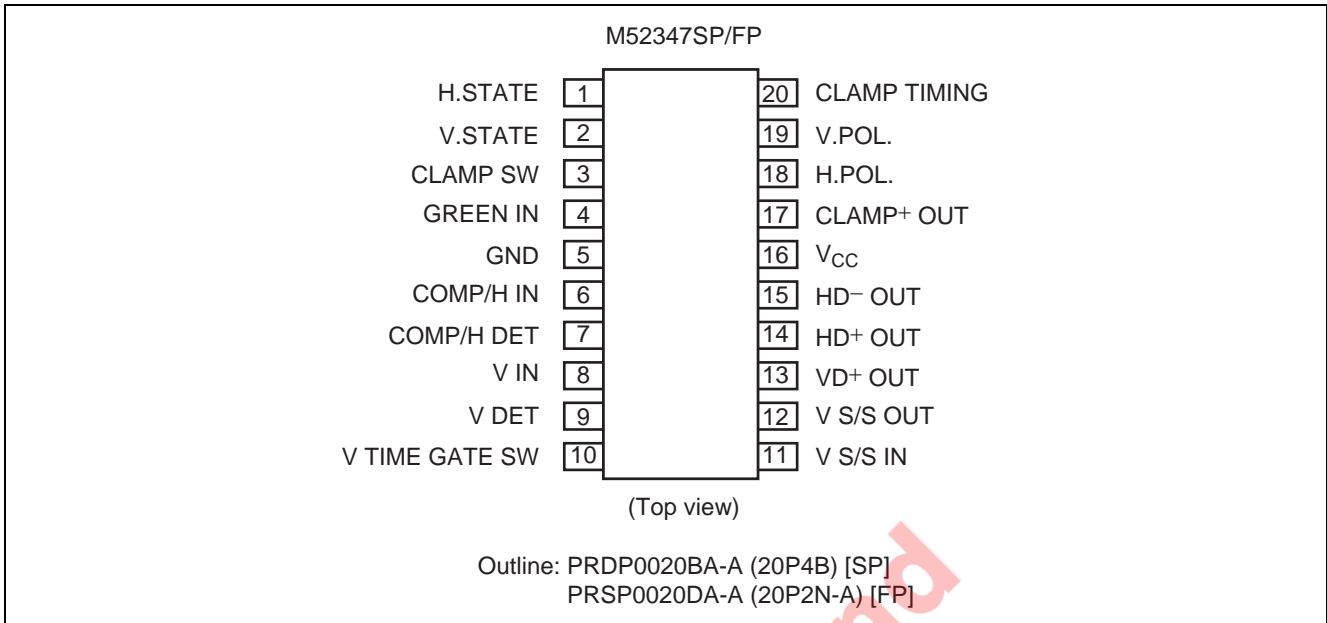

Not recommended
for new design





















Absolute Maximum Ratings

(Ta = 25°C, unless otherwise noted)

Item	Symbol	Ratings	Unit
Supply voltage	V _{CC}	6.0	V
Power dissipation	P _d	1237.6 (SP), 827.8 (FP)	mW
Electrostatic discharge	Surge	±200	V
Operating temperature	Topr	-20 to +85	°C
Storage temperature	Tstg	-40 to +150	°C

Electrical Characteristics

(Ta = 25°C, V_{CC} = 12 V, unless otherwise noted)

Item	Symbol	Limits			Unit	Relay Condition				TP Condition		Input Pin	Input Condition	Output pin	Output waveform	Note
		Min.	Typ.	Max.		4	6	8	16	3	10					
Circuit current	I _{CC}	40	53	66	mA	2	2	2	2	5 V	5 V	16	—	A	—	
Pin 1 output Hi level	1 OH	4.0	5.0	5.0	V	2	1	1	1	0 V 2.5 V 5 V	5 V	6 8	 50 kHz 1 μs 1 V _{P-P}  50 kHz 1 μs 1 V _{P-P}	1	DC	*1
Pin 1 output Low level	1 OL	0	0.04	0.5	V	2	1	1	1	0 V 2.5 V 5 V	5 V	6 8	 50 kHz 1 μs 0.2 V _{P-P}  50 kHz 1 μs 1.0 V _{P-P}	1	DC	*1, *2
Pin 2 output Hi level	2 OH	4.0	5.0	5.0	V	2	1	1	1	0 V 2.5 V 5 V	5 V	6 8	 50 kHz 1 μs 1 V _{P-P}  50 kHz 1 μs 1 V _{P-P}	2	DC	*1
Pin 2 output Low level	2 OL	0	0.04	0.5	V	2	1	1	1	0 V 2.5 V 5 V	5 V	6 8	 50 kHz 1 μs 1.0 V _{P-P}  50 kHz 1 μs 0.2 V _{P-P}	2	DC	*1, *2
Pin 18 output Hi level	18 OH	4.0	5.0	5.0	V	2	1	1	1	0 V 2.5 V 5 V	5 V	6 8	 50 kHz 1 μs 1 V _{P-P}  50 kHz 1 μs 1 V _{P-P}	18	DC	*1
Pin 18 output Low level	18 OL	0	0.04	0.5	V	2	1	1	1	0 V 2.5 V 5 V	5 V	6 8	 50 kHz 1 μs 1 V _{P-P}  50 kHz 1 μs 1 V _{P-P}	18	DC	*1
Pin 19 output Hi level	19 OH	4.0	5.0	5.0	V	2	1	1	1	0 V 2.5 V 5 V	5 V	6 8	 50 kHz 1 μs 1 V _{P-P}  50 kHz 1 μs 1 V _{P-P}	19	DC	*1
Pin 19 output Low level	19 OL	0	0.04	0.5	V	2	1	1	1	0 V 2.5 V 5 V	5 V	6 8	 50 kHz 1 μs 1 V _{P-P}  50 kHz 1 μs 1 V _{P-P}	19	DC	*1
Pin 14 output Hi level	14 OH	4.0	5.0	5.0	V	1	1	2	1	0 V 2.5 V 5 V	5 V	4 6	 50 kHz 1 μs 0.6 V _{P-P}  50 kHz 1 μs 2 V _{P-P}	14	 V Meas	
Pin 14 output Low level	14 OL	0	0.25	0.5	V	1	1	2	1	0 V 2.5 V 5 V	5 V	4 6	 50 kHz 1 μs 0.6 V _{P-P}  50 kHz 1 μs 2 V _{P-P}	14	 V Meas	

- Notes: 1. The true value table depends on Table 1
 2. 0.2 V_{P-P} of input signal is equivalent to NON SYNC.

Electrical Characteristics (cont.)

Item	Symbol	Limits			Unit	Relay Condition				TP Condition		Input Pin	Input Condition	Output pin	Output waveform	Note
		Min.	Typ.	Max.		4	6	8	16	3	10					
Pin 15 output Hi level	15 OH	4.0	5.0	5.0	V	1	1	2	1	0 V 2.5 V 5 V	5 V	4 6	50 kHz 1 μs 0.6 V _{P-P} 50 kHz 1 μs 2 V _{P-P}	15	V Meas	
Pin 15 output Low level	15 OL	0	0.25	0.5	V	1	1	2	1	0 V 2.5 V 5 V	5 V	4 6	50 kHz 1 μs 0.6 V _{P-P} 50 kHz 1 μs 2 V _{P-P}	15	V Meas	
Pin 17 output Hi level	17 OH	4.0	5.0	5.0	V	1	1	2	1	0 V 2.5 V 5 V	5 V	4 6	50 kHz 1 μs 0.6 V _{P-P} 50 kHz 1 μs 2 V _{P-P}	17	V Meas	
Pin 17 output Low level	17 OL	0	0.25	0.5	V	1	1	2	1	0 V 2.5 V 5 V	5 V	4 6	50 kHz 1 μs 0.6 V _{P-P} 50 kHz 1 μs 2 V _{P-P}	17	V Meas	
Pin 13 output Hi level	13 OH	4.0	5.0	5.0	V	2	2	1	1	0 V 2.5 V 5 V	5 V	8	50 kHz 1 μs 2 V _{P-P}	13	V Meas	
Pin 13 output Low level	13 OL	0	0.25	0.5	V	2	2	1	1	0 V 2.5 V 5 V	5 V	8	50 kHz 1 μs 2 V _{P-P}	13	V Meas	
Pin 12 output Hi level	12 OH	4.0	5.0	5.0	V	1	1	2	1	0 V 2.5 V 5 V	5 V	4 6	50 kHz 1 μs 0.6 V _{P-P} 50 kHz 1 μs 2 V _{P-P}	12	V Meas	
Pin 12 output Low level	12 OL	0	0.25	0.5	V	1	1	2	1	0 V 2.5 V 5 V	5 V	4 6	50 kHz 1 μs 0.6 V _{P-P} 50 kHz 1 μs 2 V _{P-P}	12	V Meas	
Sync-Sep Sync input signal Max. noise amplitude voltage	SS-NV	—	—	0.05	V _{P-P}	1	2	2	1	0 V 2.5 V 5 V	5 V	4	50 kHz 1 μs 0.05 V _{P-P}	14 15 17	No pulse must be output.	*3
Sync-Sep Sync input signal Min. amplitude voltage	SS-LV	0.2	—	—	V _{P-P}	1	2	2	1	0 V 2.5 V 5 V	5 V	4	50 kHz 1 μs 0.2 V _{P-P}	14 17	50 kHz No pulse must be output in this portion.	*4
CLAMP SW threshold voltage H	V3H	2.8	3.1	3.4	V	2	1	2	1	Variable	5 V	3 6	DC voltage must be applied. 50 kHz 1 μs 2 V _{P-P}	14, 17 15	V Meas	*5
CLAMP SW threshold voltage H variable	V3L	1.0	1.3	1.6	V	2	1	2	1	Variable	5 V	3 6	DC voltage must be applied. 50 kHz 1 μs 2 V _{P-P}	14, 17 15	V Meas	*6
V TIME GATE SW threshold voltage variable	V10	2.0	2.5	3.0	V	2	1	1	1	0 V 5 V	Variable	6 8 10	50 kHz 1 μs 2 V _{P-P} 50 kHz 1 μs 2 V _{P-P} DC voltage must be applied.	14 15	V Meas	*7

Notes: 3. Must not operate when input amplitude is 0.05 V_{P-P} or less. (Pseudo noise signal)

4. Must operate when the input amplitude is 0.2 V_{P-P} or more.

5. Checking output pulse for output with a voltage of 5 VDC applied, decrease the DC voltage and then measure the voltage when the output pulse is not output.

6. Checking output pulse for output with a voltage of 0 VDC applied, increase the DC voltage and then measure the voltage when the output pulse is not output.

7. Checking output pulse for output with a voltage of 5 VDC applied, decrease the DC voltage and then measure the voltage when the output pulse becomes narrow.

Electrical Characteristics (cont.)

Item	Symbol	Limits			Unit	Relay Condition				TP Condition		Input Pin	Input Condition	Output pin	Output waveform	Note
		Min.	Typ.	Max.		4	6	8	16	3	10					
HD ⁺ -delay time (A)	HD ⁺ -DA	—	120	350	ns	1	1	2	1	0 V	5 V	4		14	Input 6 (50%) Output 14 (50%)	
HD ⁺ -delay time (B)	HD ⁺ -DB	—	80	350	ns	1	1	2	1	0 V	5 V	4		14	Input 6 (50%) Output 14 (50%)	
HD ⁺ -delay time (C)	HD ⁺ -DC	—	140	350	ns	1	1	2	1	2.5 V	5 V	4		14	Input 4 (50%) Output 14 (50%)	
HD ⁺ -delay time (D)	HD ⁺ -DD	—	120	350	ns	1	1	2	1	2.5 V	5 V	4		14	Input 4 (50%) Output 14 (50%)	
HD ⁻ -delay time (A)	HD ⁻ -DA	—	70	350	ns	1	1	2	1	0 V	5 V	4		15	Input 6 (50%) Output 15 (50%)	
HD ⁻ -delay time (B)	HD ⁻ -DB	—	120	350	ns	1	1	2	1	0 V	5 V	4		15	Input 6 (50%) Output 15 (50%)	
HD ⁻ -delay time (C)	HD ⁻ -DC	—	100	350	ns	1	1	2	1	2.5 V	5 V	4		15	Input 4 (50%) Output 15 (50%)	
HD ⁻ -delay time (D)	HD ⁻ -DD	—	150	350	ns	1	1	2	1	2.5 V	5 V	4		15	Input 4 (50%) Output 15 (50%)	
CP ⁺ -delay time (A)	CP ⁺ -DA	—	90	350	ns	1	1	2	1	0 V	5 V	4		17	Input 6 (50%) Output 17 (50%)	
CP ⁺ -delay time (B)	CP ⁺ -DB	—	130	350	ns	1	1	2	1	2.5 V	5 V	4		17	Input 4 (50%) Output 17 (50%)	
CP ⁺ -delay time (C)	CP ⁺ -DC	—	90	350	ns	1	1	2	1	5 V	5 V	4		17	Input 6 (50%) Output 17 (50%)	
CP ⁺ -PULSE-WIDTH	CP ⁺ -PW	250	400	550	ns	1	1	2	1	0 V	5 V	4		17	Output 17 (50%)	
VD ⁺ -delay time (A)	VD ⁺ -DA	—	100	350	ns	2	2	1	1	0 V	5 V	8		13	Input 8 (50%) Output 13 (50%)	
VD ⁺ -delay time (B)	VD ⁺ -DB	—	70	350	ns	2	2	1	1	0 V	5 V	8		13	Input 8 (50%) Output 13 (50%)	
V Sync-Sep threshold voltage H	V11H	3.0	3.5	4.0	V	2	1	2	1	0 V	5 V	6		14		*8
										5 V	5 V	11	DC voltage must be applied.	15		
V Sync-Sep threshold voltage L	V11L	1.3	1.8	2.3	V	2	1	2	1	0 V	5 V	6		14		*9
										5 V	5 V	11	DC voltage must be applied.	15		

Notes: 8. Checking output pulse for output with a voltage of 0 VDC applied, increase the DC voltage and then measure the voltage when the output pulse is not output.

9. Checking output pulse for output with a voltage of 5 VDC applied, decrease the DC voltage and then measure the voltage when the output pulse is output.

Test Circuit

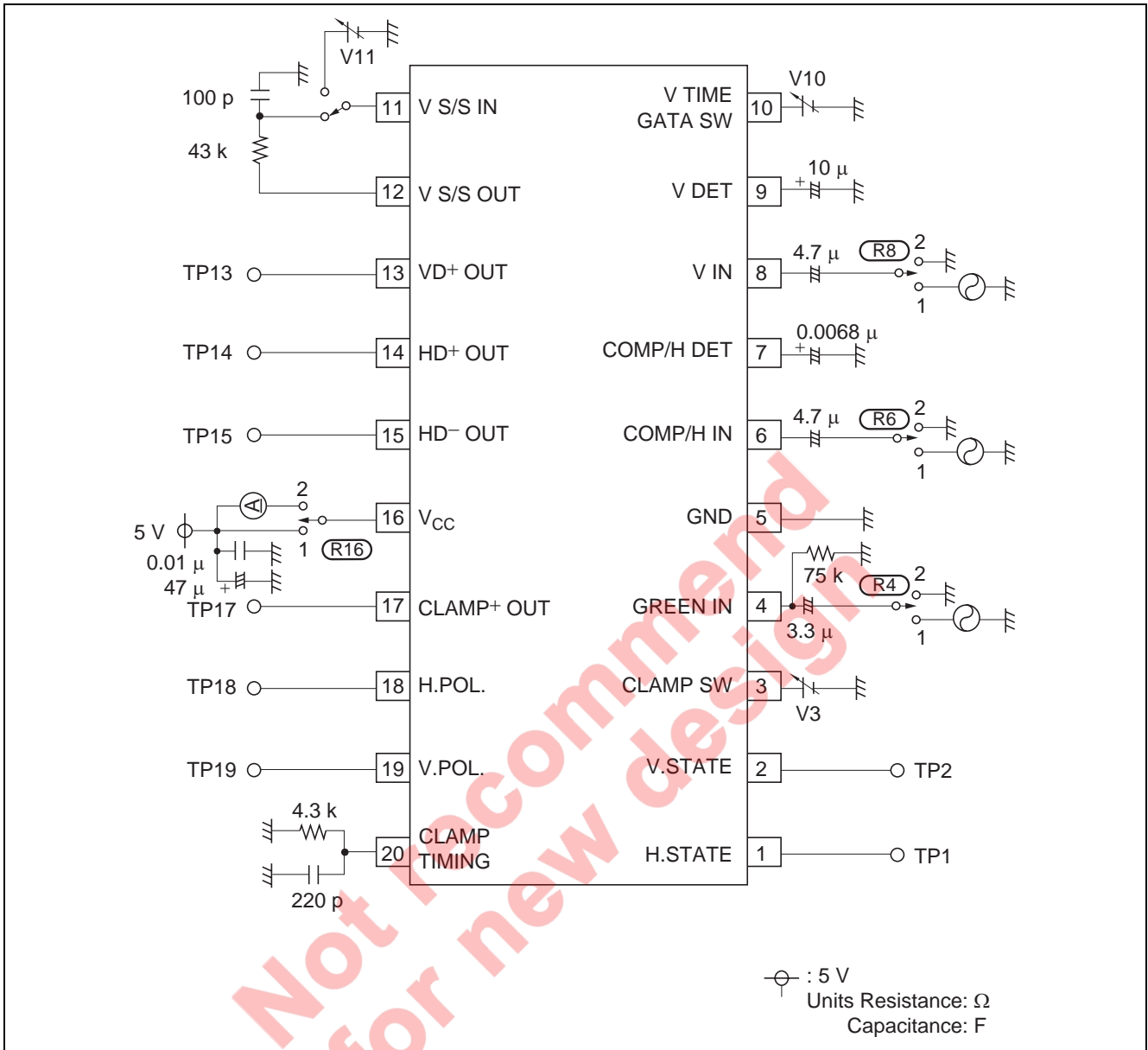

Pin Description

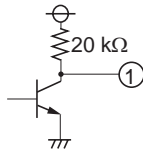
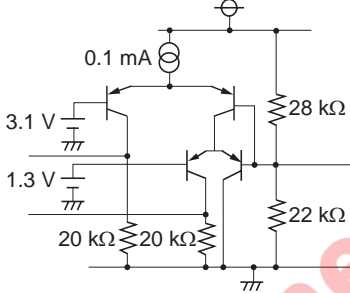
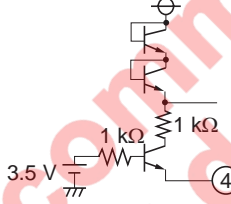
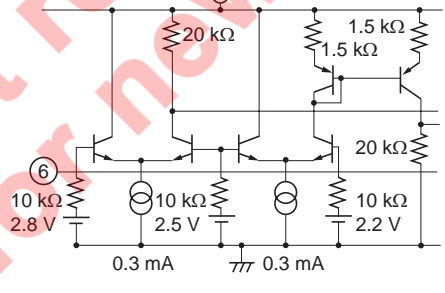
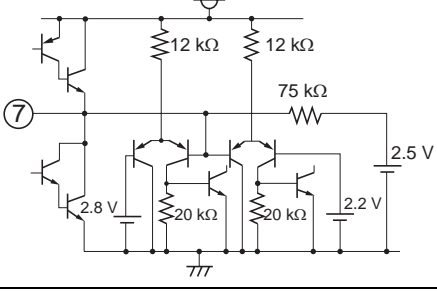
Pin No.	Name	DC Voltage (V)	Peripheral Circuit	Function
1	H.STATE	0 V _{DC} or 5 V _{DC}		Logic output pin for horizontal synchronous signal When pin 6 input signal is POSI, outputs "H"; when NON, outputs "L"; and when NEG, outputs "H".
2	V.STATE	0 V _{DC} or 5 V _{DC}	Same as pin 1	Logic output pin for vertical synchronous signal When pin 8 input signal is POSI, outputs "H"; when NON, outputs "L"; and when NEG, outputs "H".
3	CLAMP SW	2.2 V when open		This SW is available to change the generating position of clamp pulse for input signal. (See Table 2.) V _{TH L} = 0 to 1 V V _{TH M} = 1.6 to 2.8 V V _{TH H} = 3.4 to 5 V
4	GREEN IN	2.8 V when open		GREEN (SYNC ON VIDEO) input pin Input with negative sync. Comparison of pin 4 input signal and reference voltage within the IC performs synchronous separation.
5	GND	—	—	Grounding
6	COMP/H IN	2.5 V when open		Composite sync/H sync input pin. Bias is approx. 2.5 V and impedance is 10 kΩ. The internal double threshold comparator is used for shaping waveform and detecting polarity. Optimum input amplitude is 0.6 V _{P-P} at pin 6. Up to approx. 50% of duty, waveform shaping and polarity detection can be done.
7	COMP/H DET	2.5 V when open (no signal)		External capacitance is required as a filter pin for detecting polarity and detecting non-input. As the value is larger, the ripple is smaller and less malfunction occurs. However, this lowers the response speed of detection.
8	V IN	2.5 V when open	Same as pin 6	V sync input pin Same as pin 6
9	V DET	2.5 V when open (no signal)	Same as pin 7	Same as pin 7

Pin Description (cont.)

Pin No.	Name	DC Voltage (V)	Peripheral Circuit	Function
10	V.TIME GATE SW	3.2 V when open		V TIME GATE SW pin Can select whether to output the pulse of VD portion from pin 14, 15 output pulse. The threshold voltage is approx. 2.5 V. $V_{TH L} = 0$ to 2 V $V_{TH H} = 3$ to 5 V
11	V S/S IN	—		V S/S IN pin Inputs a signal of having externally integrated composite sync for V sync separation.
12	V S/S OUT	—		V S/S pulse output pin No problem occurs when current of approx. 6 mA flows to internal part of the IC. To improve the rising speed, connect a resistance between power supplies.
13	VD ⁺ OUT	—	Same as pin 12	VD ⁺ pulse output pin Same as pin 12
14	HD ⁺ OUT	—	Same as pin 12	HD ⁺ pulse output pin Same as pin 12
15	HD ⁻ OUT	—	Same as pin 12	HD ⁻ pulse output pin Same as pin 12
16	V _{CC}	5 V	—	Power supply
17	CLAMP ⁺ OUT	—	Same as pin 12	CLAMP ⁺ pulse output pin Same as pin 12
18	H.POL.	0 V _{DC} or 5 V _{DC}	Same as pin 1	Logic output pin for horizontal synchronous signal When pin 6 input signal is POSI, outputs "L"; when NON, outputs "L"; and when NEG, outputs "H".
19	V.POL.	0 V _{DC} or 5 V _{DC}	Same as pin 1	Logic output pin for vertical synchronous signal When pin 8 input signal is POSI, outputs "L"; when NON, outputs "L"; and when NEG, outputs "H".
20	CLAMP TIMING			CLAMP TIMING pin The clamp pulse width is determined depending on the external resistance and capacitance. As the resistance value and capacitance value are larger, the clamp pulse width is wider.

Table 1 Decoder Logic Output

Pin 6 Input COMP/H	Pin 8 Input V	Output Pin			
		1	2	18	19
POSI.	NON	H	L	L	L
	POSI.	H	H	L	L
	NEG.	H	H	L	H
NEG.	NON	H	L	H	L
	POSI.	H	H	H	L
	NEG.	H	H	H	H
NON.	NON	L	L	L	L
	POSI.	L	H	L	L
	NEG.	L	H	L	H

Table 2 Clamp Pulse Position

Input Signal		Pin 17 Output Signal		
Pin 4	Pin 6	Pin 3 "H"	Pin 3 "M"	Pin 3 "L"
O	X	4 trailing edge	4 trailing edge	4 trailing edge
O	O	6 leading edge	4 trailing edge	6 trailing edge
X	O	6 leading edge	X	6 trailing edge

Table 3 Output Priority Order

Input Signal			Output Signal			
			Pin 3 "H" "L"		Pin 3 "M"	
Pin 4	Pin 6	Pin 8	Pins 12, 14, 15, 17	Pin 13	Pins 12, 14, 15, 17	Pin 13
O	X	X	4	11	4	11
O	O	X	6	11	4	11
O	X	O	4	8	4	8
O	O	O	6	8	4	8
X	X	X	X	X	X	X
X	O	X	6	11	X	X
X	X	O	X	8	X	8
X	O	O	6	8	X	8

Table 4 Allowable Input Amplitude Voltage

Pin 4 input amplitude	<p>V_V 0 to 2.1 (V_{P-P}) V_S 0.2 to 0.6 (V_{P-P}) $f_H = 10$ Hz to 200 kHz $f_V = 10$ Hz to 200 Hz</p>
Pin 6 input amplitude	<p>V_S 0.5 to 2.5 (V_{P-P}) $f_H = 10$ Hz to 200 kHz</p>
Pin 8 input amplitude	<p>V_S 0.5 to 2.5 (V_{P-P}) $f_V = 10$ Hz to 200 Hz</p>

Application Method

1. Input Block

1) GREEN (SYNC ON VIDEO) IN (Pin 4)

Input with sync negative polarity.

Comparison of pin 4 input signal and the reference voltage of the inside of the IC performs the synchronous separation. When the input at pin 4 is less than or equal to the reference voltage (2.8 V) and the flowing current is more than or equal to the input sensitivity current (200 μ A or more), the signal is separated.

When only a synchronous signal is input into pin 4, the operatable amplitude and the duty are as shown in Figure 1. If the IC does not operate normally with the video signal input, change the value of external resistance R to make the current optimum.

But, when capacity value is too big, output response becomes bad.

2) COMP/H IN, VIN (pins 6 and 8)

The composite sync input is connected to pin 6. H and V of the separate sync input are connected to pins 6 and 8, respectively. For each of pins 6 and 8, the bias is 2.5 V and the impedance is 10 k Ω . The internal double threshold converter is used for shaping waveform and for detecting polarity.

Average DC voltage of input signal is 2.5 V. Each threshold voltage is set at a voltage 0.3 V away from this voltage. If the duty ratio at pin 6 is small as shown in Figure 2, the optimum value is approx. 0.3 V_{P-P}. If the duty ratio is large, the optimum value is approx. 0.6 V_{P-P}. Figure 3 shows the allowable input amplitude and the reference value of duty test.

Only 5 V TTL input, decrease the amplitude by resistor splitting.

In addition, Figure 4 shows an example for improving the capability of the allowable duty when the input amplitude is 0.7 V_{P-P} or more.

To use the IC out of the standard value, remove the filter from pins 7 and 9, observe the waveform and check for a match with the waveform shown in Figure 5.

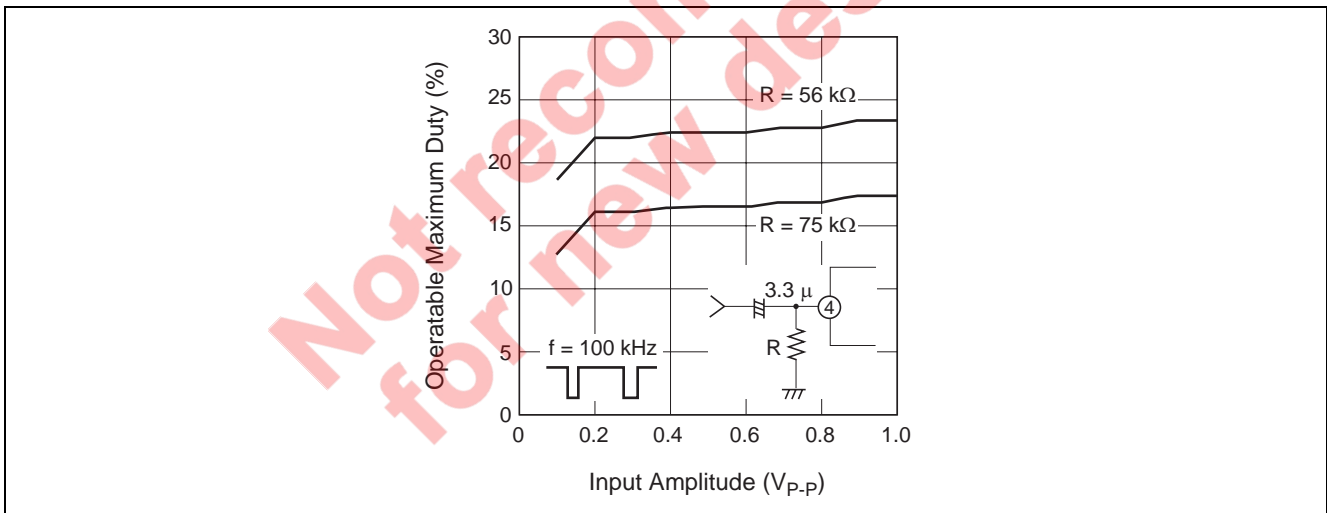

Figure 1

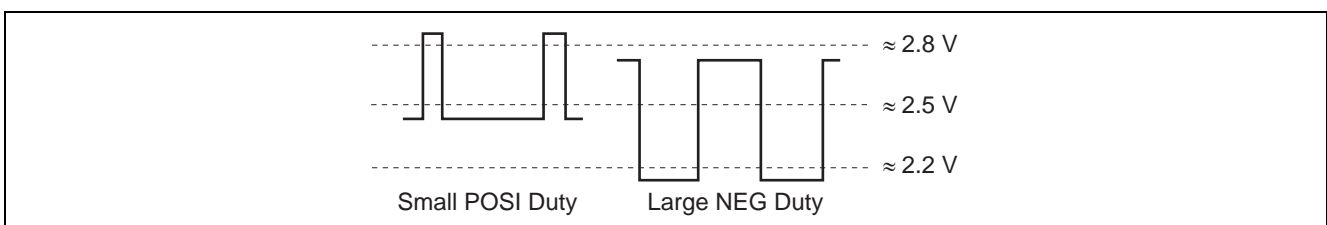

Figure 2

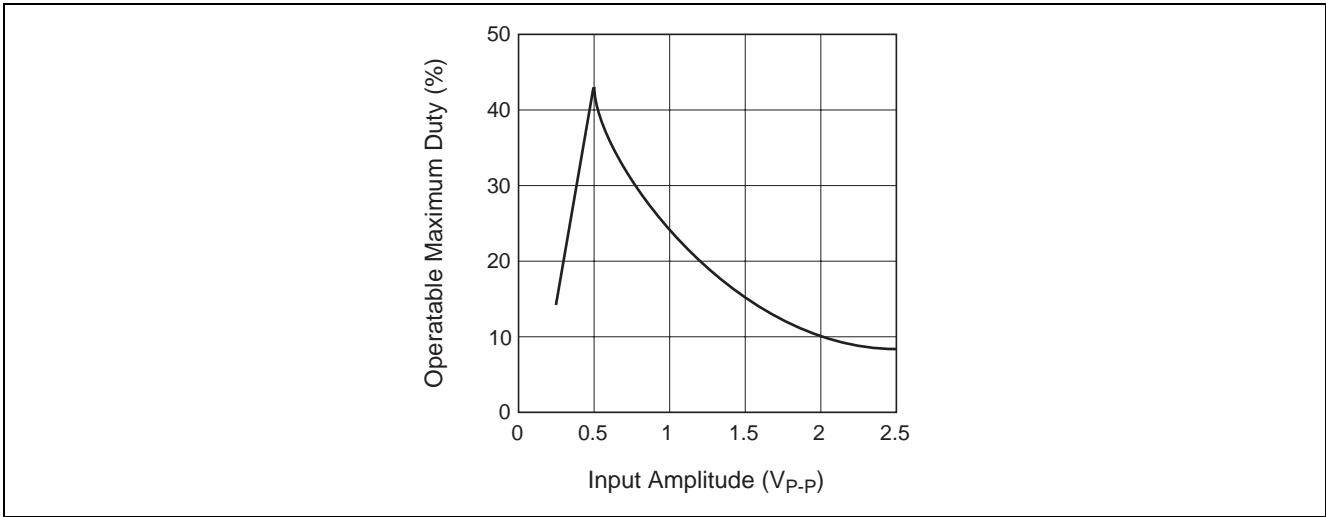

Figure 3

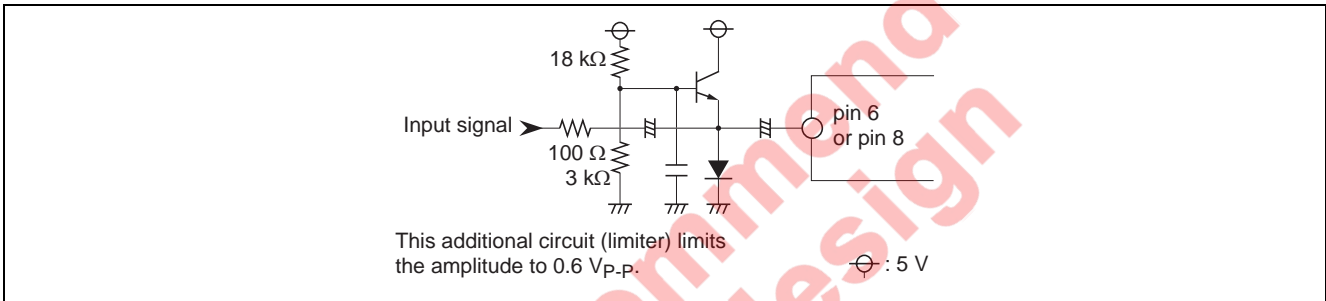

Figure 4

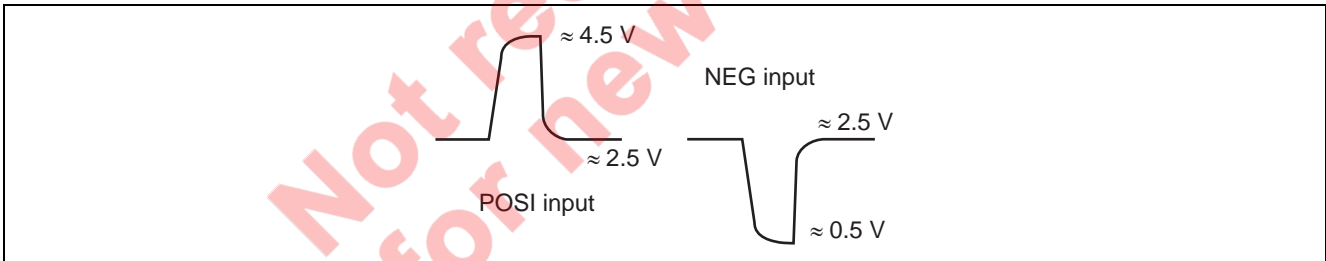

Figure 5

3) Polarity detection and non-input detection (pins 7 and 8)

External capacitance is required as a filter pin to detect polarity and non-input. As the value is larger, the ripple is smaller and less malfunction occurs. However, the response speed for detection is lower. A sufficient external capacitance is 0.05 μF with input of 15 kHz and 10 μF with input of 60 kHz. However, check the frequency of the input signal in use and the filter pin waveform with the duty ratio conditions, and then check that the value is 3.1 V or more (2.8 V in capability) with positive polarity input and 1.9 V or less (2.2 V in capability) with negative polarity input.

4) V S/S IN (pin 11)

Input a signal of having externally integrated composite sync for V sync separation.

Composite sync input into pin 6 is output to pin 12. Output at 12 is externally integrated and is input into pin 11 for V sync separation. With the waveform at pin 11, check that the H element has been fully dropped.

The threshold levels of sync separation, given hysteresis, are 3.5 V and 1.8 V.

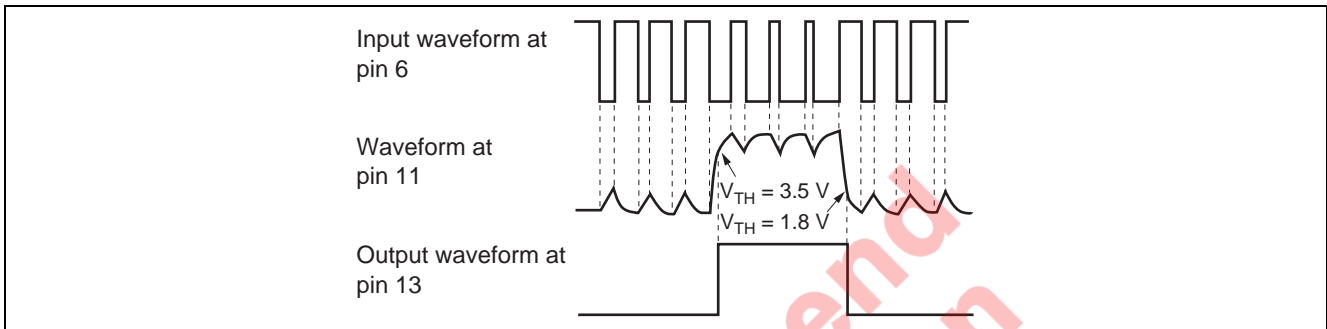

2. Clamp Pulse

1) Clamp pulse width

CLAMP TIMING (Pin 20)

The clamp pulse width is determined by the external resistance and the capacitance. As the resistance value and capacitance value are larger, the clamp pulse width is wider.

The time constant is determined by the current flowing out of pin 20 and the capacitance value of the timing pin.

The flow current at pin 20 is determined by the pin voltage and external resistance value. When the external resistance is 4.3 k Ω (that is 700 μA) and the external capacitance is 220 pF, the pulse width is 0.4 μs .

2) Clamp pulse position

CLAMP SW (pin 3)

When pin 3 is "M" or "L", fixing a higher-priority signal to the trailing edge results in occurrence of a clamp pulse.

When pin 3 is "H", and only GREEN is input, clamp pulse occurs at the trailing edge. A clamp pulse also occurs at the leading edge when COMP/H only is input or when both COMP/H and GREEN are input.

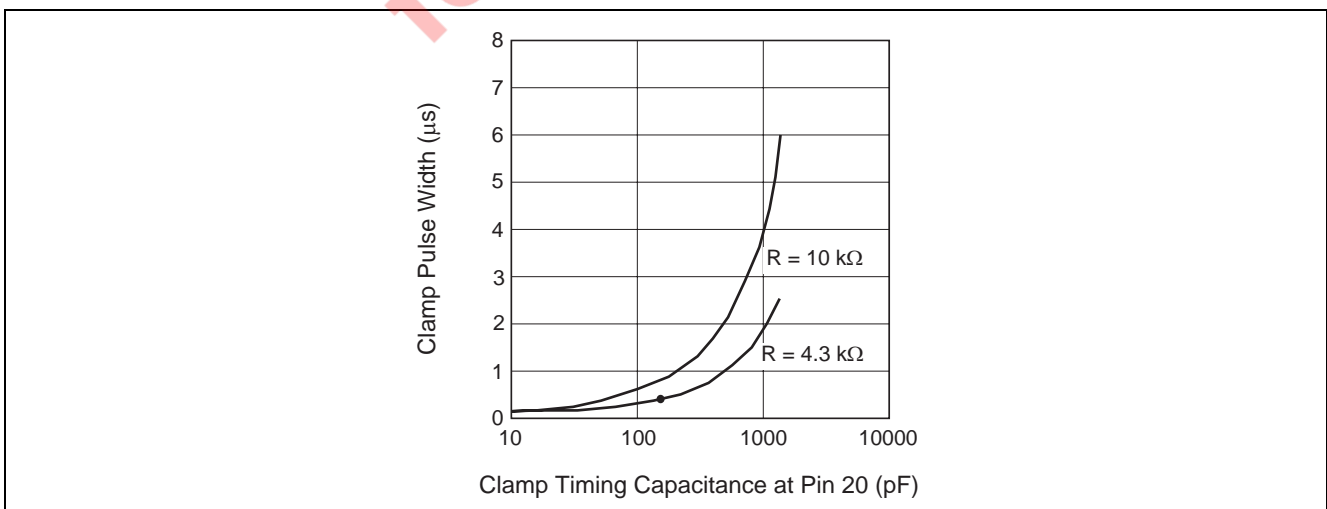

3. Sampling Pulse from VD Portion

V TIME GATE SW (Pin 10)

Whether to output the pulse of VD portion from pins 14 and 15 can be selected. When pin 10 is "H" or OPEN, pulse of the VD portion is output. When pin 10 is "L", the pulse of the VD portion is not output.

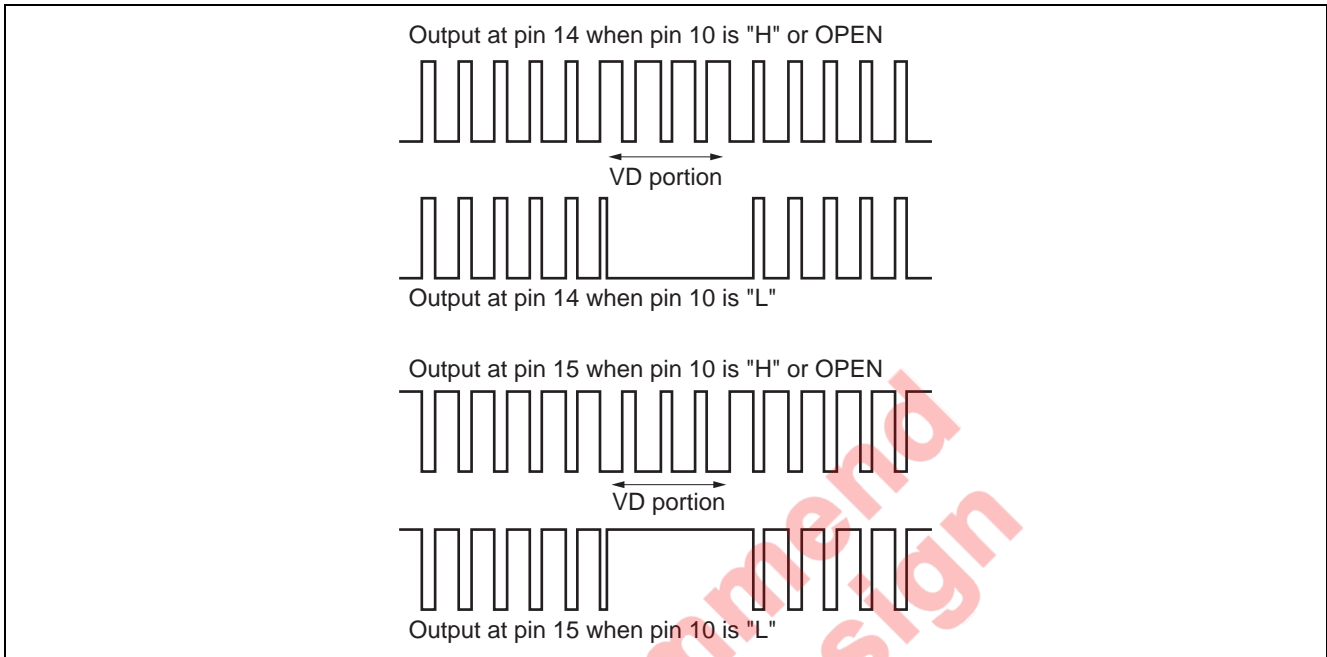

4. Output Stage

1) Logic output (pins 1, 2, 18 and 19)

The output format is as shown in the diagram below.

When the internal load resistance of the IC is 20 k Ω , a current of approx. 3 mA flows to the inside of the IC, no problem will occur.

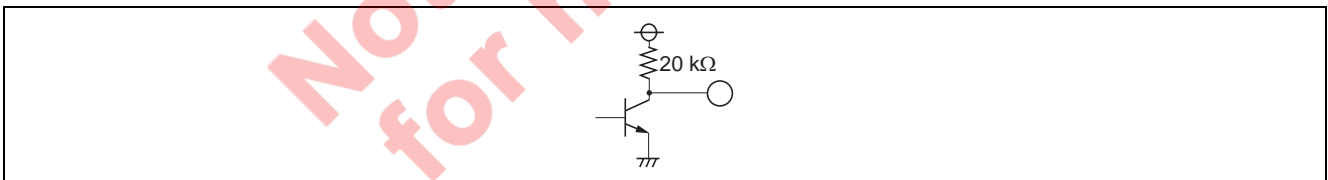

2) Pulse output (pins 12, 13, 14, 15 and 17)

The output format is as shown in the diagram below.

When the internal load resistance of the IC is 1 k Ω , a current of approx. 6 mA flows to the inside of the IC, no problem will occur.

To improve the rising speed, connect a resistance between power supplies. Note that the low level of the output pulse goes up.

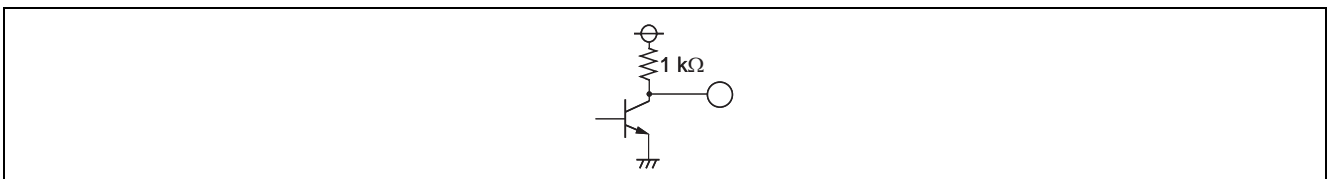

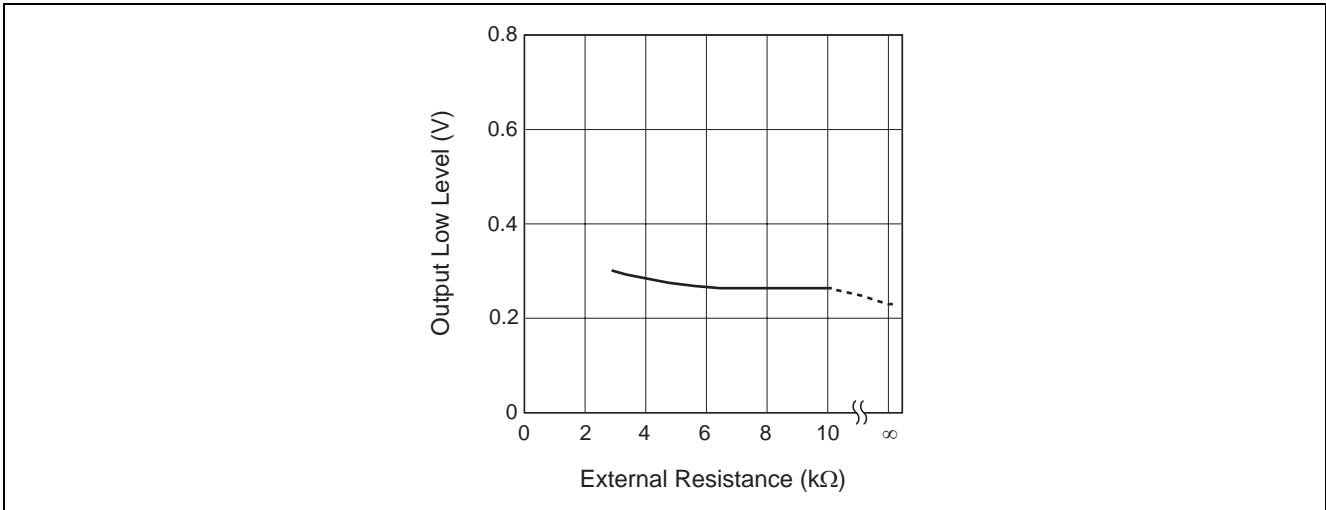

Typical Characteristics

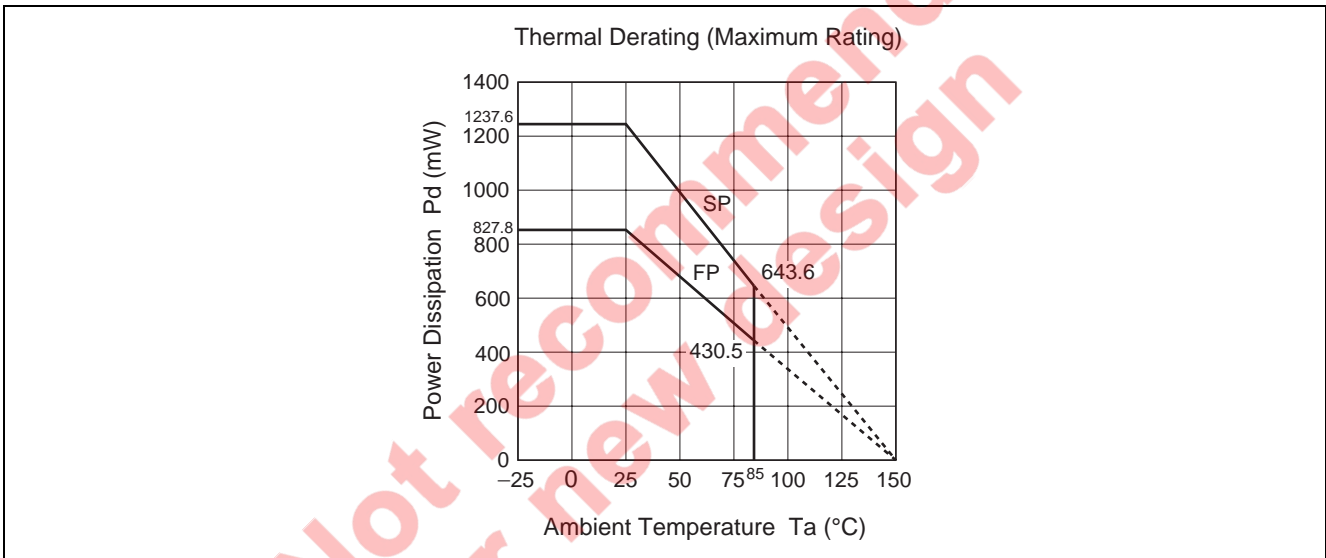

Application Example ($f_H = 50 \text{ kHz}$, $f_V = 80 \text{ Hz}$)

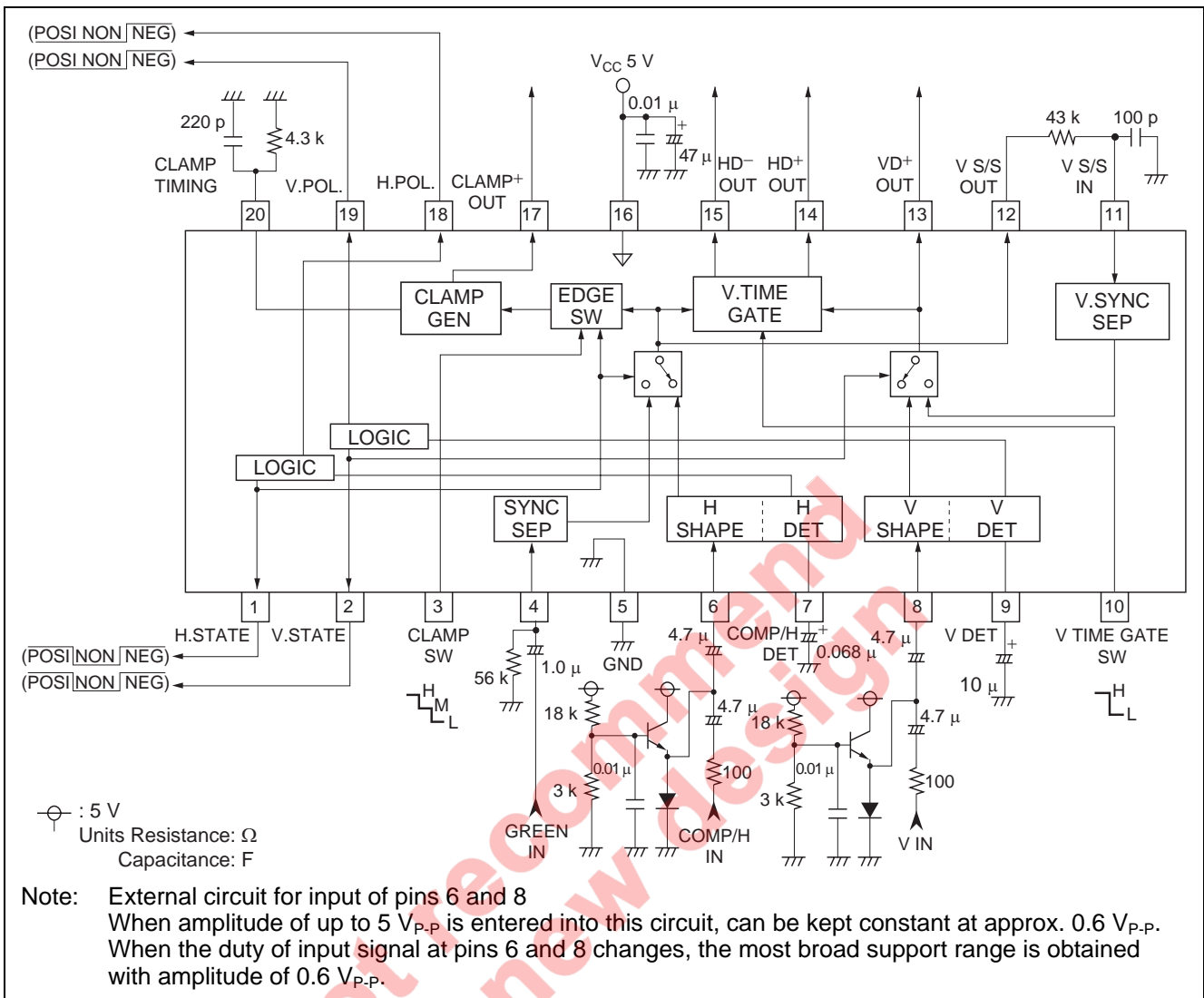

Package Dimensions

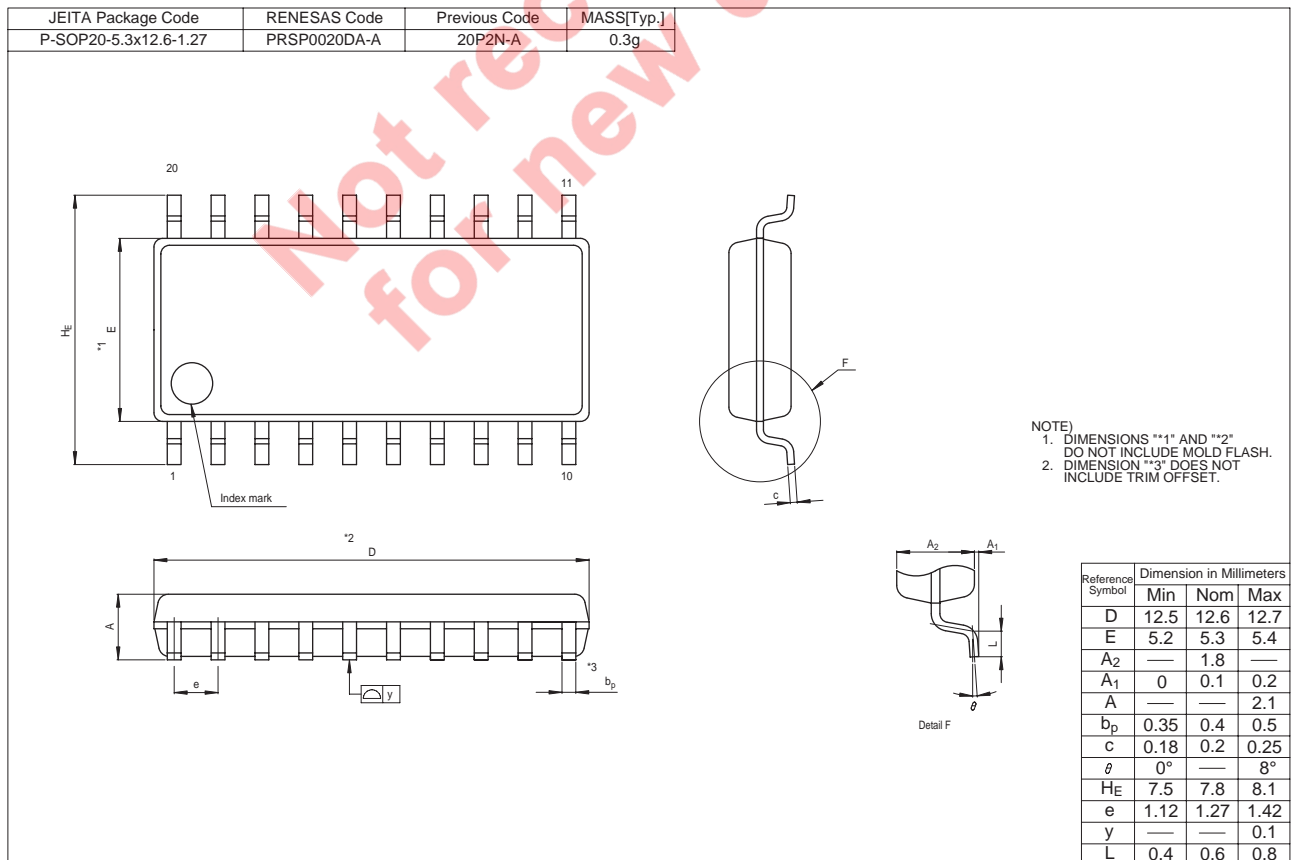
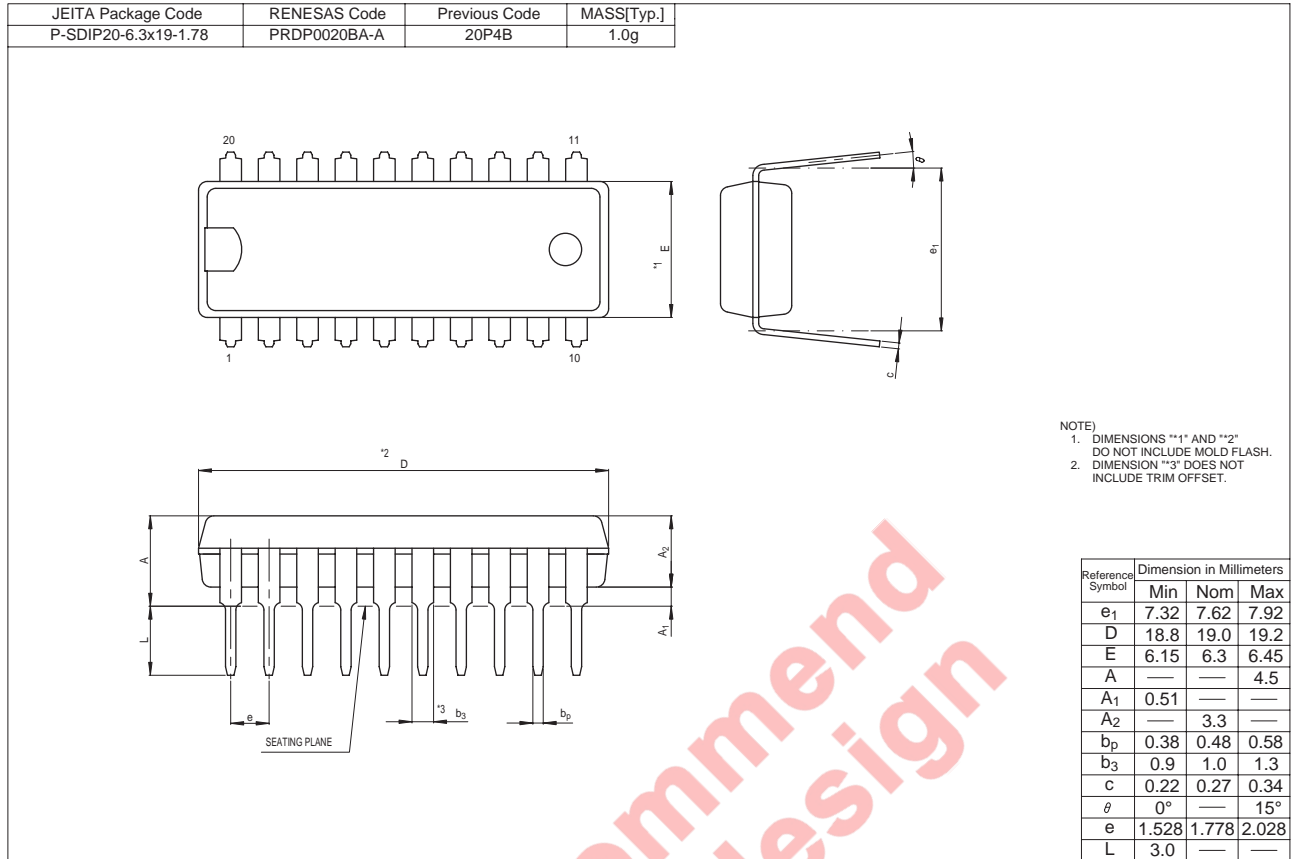

Notes:

1. This document is provided for reference purposes only so that Renesas customers may select the appropriate Renesas products for their use. Renesas neither makes warranties or representations with respect to the accuracy or completeness of the information contained in this document nor grants any license to any intellectual property rights or any other rights of Renesas or any third party with respect to the information in this document.
2. Renesas shall have no liability for damages or infringement of any intellectual property or other rights arising out of the use of any information in this document, including, but not limited to, product data, diagrams, charts, programs, algorithms, and application circuit examples.
3. You should not use the products or the technology described in this document for the purpose of military applications such as the development of weapons of mass destruction or for the purpose of any other military use. When exporting the products or technology described herein, you should follow the applicable export control laws and regulations, and procedures required by such laws and regulations.
4. All information included in this document such as product data, diagrams, charts, programs, algorithms, and application circuit examples, is current as of the date this document is issued. Such information, however, is subject to change without any prior notice. Before purchasing or using any Renesas products listed in this document, please confirm the latest product information with a Renesas sales office. Also, please pay regular and careful attention to additional and different information to be disclosed by Renesas such as that disclosed through our website. (<http://www.renesas.com>)
5. Renesas has used reasonable care in compiling the information included in this document, but Renesas assumes no liability whatsoever for any damages incurred as a result of errors or omissions in the information included in this document.
6. When using or otherwise relying on the information in this document, you should evaluate the information in light of the total system before deciding about the applicability of such information to the intended application. Renesas makes no representations, warranties or guarantees regarding the suitability of its products for any particular application and specifically disclaims any liability arising out of the application and use of the information in this document or Renesas products.
7. With the exception of products specified by Renesas as suitable for automobile applications, Renesas products are not designed, manufactured or tested for applications or otherwise in systems the failure or malfunction of which may cause a direct threat to human life or create a risk of human injury or which require especially high quality and reliability such as safety systems, or equipment or systems for transportation and traffic, healthcare, combustion control, aerospace and aeronautics, nuclear power, or undersea communication transmission. If you are considering the use of our products for such purposes, please contact a Renesas sales office beforehand. Renesas shall have no liability for damages arising out of the uses set forth above.
8. Notwithstanding the preceding paragraph, you should not use Renesas products for the purposes listed below:
 - (1) artificial life support devices or systems
 - (2) surgical implantations
 - (3) healthcare intervention (e.g., excision, administration of medication, etc.)
 - (4) any other purposes that pose a direct threat to human lifeRenesas shall have no liability for damages arising out of the uses set forth in the above and purchasers who elect to use Renesas products in any of the foregoing applications shall indemnify and hold harmless Renesas Technology Corp., its affiliated companies and their officers, directors, and employees against any and all damages arising out of such applications.
9. You should use the products described herein within the range specified by Renesas, especially with respect to the maximum rating, operating supply voltage range, movement power voltage range, heat radiation characteristics, installation and other product characteristics. Renesas shall have no liability for malfunctions or damages arising out of the use of Renesas products beyond such specified ranges.
10. Although Renesas endeavors to improve the quality and reliability of its products, IC products have specific characteristics such as the occurrence of failure at a certain rate and malfunctions under certain use conditions. Please be sure to implement safety measures to guard against the possibility of physical injury, and injury or damage caused by fire in the event of the failure of a Renesas product, such as safety design for hardware and software including but not limited to redundancy, fire control and malfunction prevention, appropriate treatment for aging degradation or any other applicable measures. Among others, since the evaluation of microcomputer software alone is very difficult, please evaluate the safety of the final products or system manufactured by you.
11. In case Renesas products listed in this document are detached from the products to which the Renesas products are attached or affixed, the risk of accident such as swallowing by infants and small children is very high. You should implement safety measures so that Renesas products may not be easily detached from your products. Renesas shall have no liability for damages arising out of such detachment.
12. This document may not be reproduced or duplicated, in any form, in whole or in part, without prior written approval from Renesas.
13. Please contact a Renesas sales office if you have any questions regarding the information contained in this document, Renesas semiconductor products, or if you have any other inquiries.



RENESAS SALES OFFICES

<http://www.renesas.com>

Refer to "<http://www.renesas.com/en/network>" for the latest and detailed information.

Renesas Technology America, Inc.
450 Holger Way, San Jose, CA 95134-1368, U.S.A
Tel: <1> (408) 382-7500, Fax: <1> (408) 382-7501

Renesas Technology Europe Limited
Dukes Meadow, Millboard Road, Bourne End, Buckinghamshire, SL8 5FH, U.K.
Tel: <44> (1628) 585-100, Fax: <44> (1628) 585-900

Renesas Technology (Shanghai) Co., Ltd.
Unit 204, 205, AZIACenter, No.1233 Lujiazui Ring Rd, Pudong District, Shanghai, China 200120
Tel: <86> (21) 5877-1818, Fax: <86> (21) 6887-7858/7898

Renesas Technology Hong Kong Ltd.
7th Floor, North Tower, World Finance Centre, Harbour City, Canton Road, Tsimshatsui, Kowloon, Hong Kong
Tel: <852> 2265-6688, Fax: <852> 2377-3473

Renesas Technology Taiwan Co., Ltd.
10th Floor, No.99, Fushing North Road, Taipei, Taiwan
Tel: <886> (2) 2715-2888, Fax: <886> (2) 3518-3399

Renesas Technology Singapore Pte. Ltd.
1 Harbour Front Avenue, #06-10, Keppel Bay Tower, Singapore 098632
Tel: <65> 6213-0200, Fax: <65> 6278-8001

Renesas Technology Korea Co., Ltd.
Kukje Center Bldg. 18th Fl., 191, 2-ka, Hangang-ro, Yongsan-ku, Seoul 140-702, Korea
Tel: <82> (2) 796-3115, Fax: <82> (2) 796-2145

Renesas Technology Malaysia Sdn. Bhd
Unit 906, Block B, Menara Amcorp, Amcorp Trade Centre, No.18, Jln Persiaran Barat, 46050 Petaling Jaya, Selangor Darul Ehsan, Malaysia
Tel: <603> 7955-9390, Fax: <603> 7955-9510