

ISL71710M

Radiation Tolerant Active-Input High Speed Digital Isolator

Description

The **ISL71710M** is an active input digital signal isolator with CMOS output, using Giant Magnetoresistive (GMR) technology for small size, high speed, and low power. The ISL71710M is the fastest isolator of its type, with a 150Mbps typical data rate. The symmetric magnetic coupling barrier provides a typical propagation delay of only 10ns and a pulse-width distortion as low as 0.3ns, achieving the best specifications of any isolator.

The ISL71710M has unsurpassed common-mode transient immunity of 50kV/μs. It is ideal for isolating applications such as PROFIBUS, RS-485, and RS-422.

The ISL71710M is offered in an 8 Ld 5mmx4mm SOIC package and is fully specified across the military ambient temperature range of -55°C to +125°C.

Applications

- Isolated power
- RS-485 and RS-422
- CAN bus/device net
- Multiplexed data transmission
- Data interfaces
- Board-to-board communication
- Ground loop elimination
- Peripheral interfaces
- Serial communication
- Logic level shifting

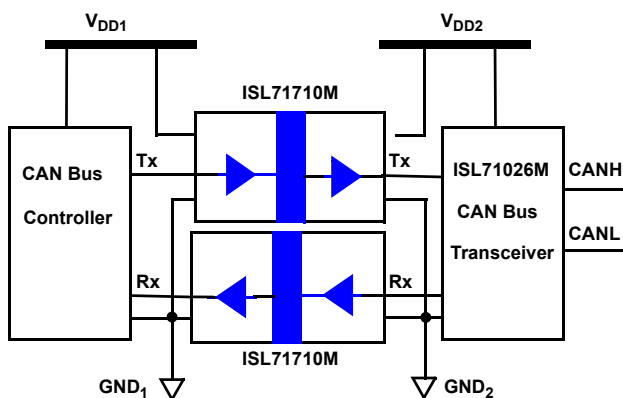

Figure 1. Typical CAN Bus Application

Features

- Qualified to Renesas Rad Tolerant Screening and QCI Flow ([R34TB0004EU](#))
- Barrier Voltage Endurance
 - 2.5kV_{RMS} for 1 minute, 600VRMS continuous (VDE V 0884-10 certified: file 5022321-4880-0001)
 - 1.5kV_{DC} continuous
 - 500V_{DC} at 43MeV•cm²/mg SEDR
- UL 1577 recognized: file reference E483309
- 5V/3.3V CMOS/TTL compatible
- High speed: 150Mbps typical
- 10ns typical propagation delay
- 300ps typical pulse-width distortion
- 4ns typical propagation delay skew
- 50kV/μs typical common-mode transient immunity
- Low EMI/RFI emissions
- Excellent magnetic immunity
- Passes NASA low outgassing specifications
- NiPdAu-Ag leadframes (Pb-free, Sn-free)
- Full military temperature range operation
 - T_A = -55°C to +125°C
 - T_J = -55°C to +150°C
- TID Radiation Lot Acceptance Testing (RLAT) (LDR: <0.01rad(Si)/s)
 - ISL71710M30BZ: 30krad(Si)
 - ISL71710M50BZ: 50krad(Si)
- SEE characterization
 - No DSEE for V_{DD} = 7V at LET = 43MeV•cm²/mg

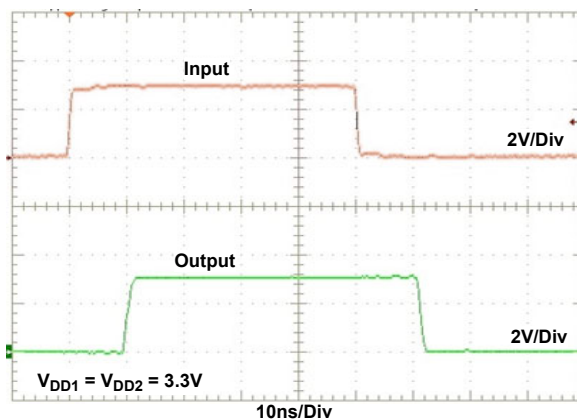

Figure 2. 10MHz Input and Output Waveforms

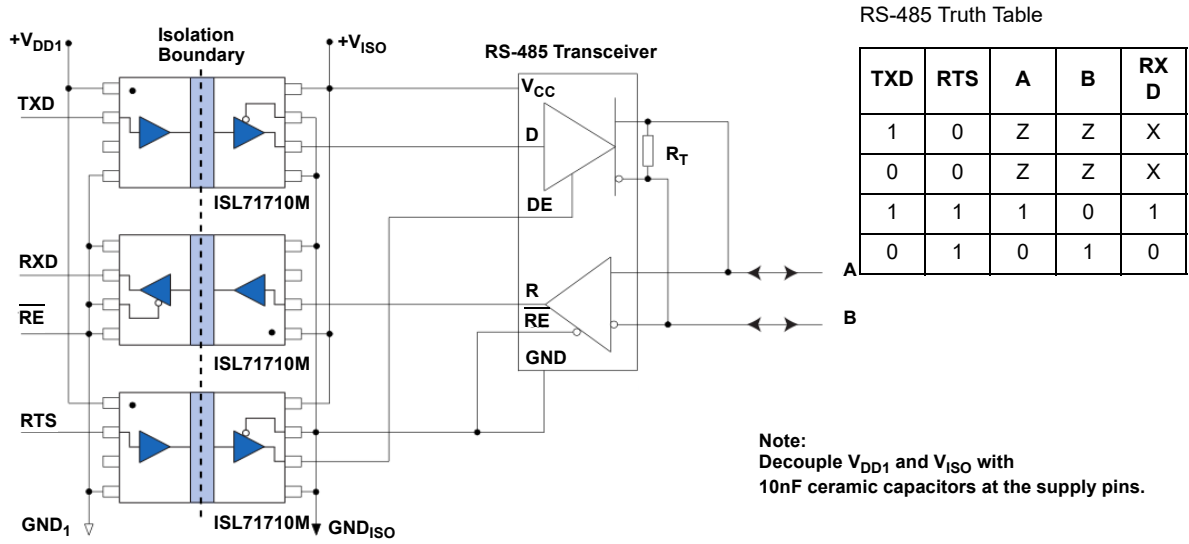

Figure 3. RS-485 Multi-Chip Isolated Transceiver Application Schematic

Contents

1. Overview	4
1.1 Functional Block Diagram	4
2. Pin Information	4
2.1 Pin Assignments	4
2.2 Pin Descriptions	4
2.3 Timing Diagram	5
3. Specifications	6
3.1 Absolute Maximum Ratings	6
3.2 Outgas Testing	6
3.3 Thermal Information	6
3.4 Recommended Operating Conditions	7
3.5 Insulation Specifications	7
3.6 Safety and Approvals	7
3.7 Electrical Specifications	8
4. Typical Performance Curves	10
5. Device Information	13
5.1 Electrostatic Discharge Sensitivity	13
5.2 Electromagnetic Compatibility	13
5.3 Dynamic Power Consumption	13
5.4 Power Supply Decoupling	14
5.5 Signal Status on Start-Up and Shutdown	14
5.6 Data Transmission Rates	14
6. Radiation Tolerance	14
6.1 Total Ionizing Dose (TID) Testing	15
6.1.1 Results	15
6.1.2 Conclusion	18
6.2 Single Event Effects Testing	19
6.2.1 SEE Test Facility	19
6.2.2 Scope of the ISL71710M SEE Testing	19
6.2.3 Testing Set Up	20
6.2.4 Isolation Barrier SEDR Testing	20
6.2.5 SEB and SEL Testing	20
6.2.6 SET Testing	20
6.2.7 Summary	22
7. Package Outline Drawing	23
8. Ordering Information	24
9. Revision History	24

1. Overview

1.1 Functional Block Diagram

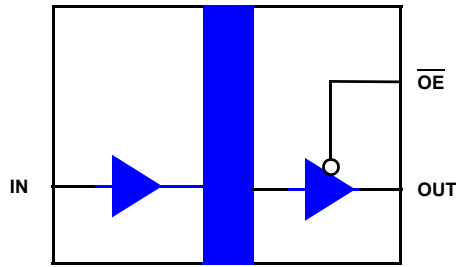

Figure 4. ISL71710M Block Diagram

2. Pin Information

2.1 Pin Assignments

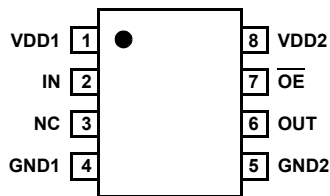
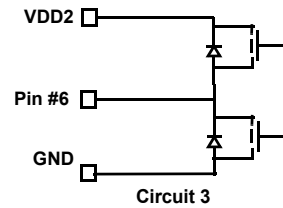
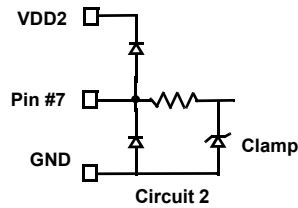
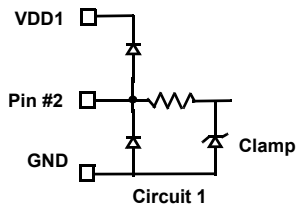

Figure 5. Pin Assignments - Top View

2.2 Pin Descriptions

Pin Number	Pin Name	ESD Circuit	Description
1	VDD1	N/A	Supply voltage
2	IN	1	Data in
3	NC	N/A	No internal connection. Leave this pin floating or connect it to VDD1 or GND1.
4	GND1	N/A	Ground return for VDD1
5	GND2	N/A	Ground return for VDD2
6	OUT	3	Data output
7	\overline{OE}	2	Output enable, active low. Internally pulled low with 100kΩ to enable the output when this pin is not connected.
8	VDD2	N/A	Supply voltage



2.3 Timing Diagram

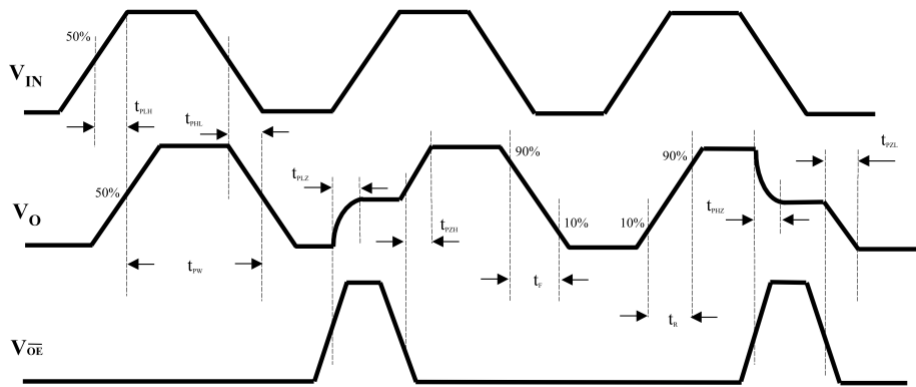

Legend

t_{PLH}	Propagation Delay, Low-to-High
t_{PHL}	Propagation Delay, High-to-Low
t_{PW}	Minimum Pulse Width
t_{PLZ}	Propagation Delay, Low-to-High Impedance
t_{PZH}	Propagation Delay, High Impedance-to-High
t_{PHZ}	Propagation Delay, High-to-High Impedance
t_{PZL}	Propagation Delay, High Impedance-to-Low
t_R	Rise Time
t_F	Fall Time

Figure 6. Timing Diagram

3. Specifications

3.1 Absolute Maximum Ratings

Caution: Do not operate at or near the maximum ratings listed for extended periods of time. Exposure to such conditions can adversely impact product reliability and result in failures not covered by warranty.

Parameter	Minimum	Maximum	Unit
Maximum Supply Voltage, VDD1 to GND1	-0.5	+7	V
Maximum Supply Voltage, VDD2 to GND2	-0.5	+7	V
In-Beam Maximum Supply Voltage VDD1 to GND1	-0.5	+7	V
In-Beam Maximum Supply Voltage VDD2 to GND2	-0.5	+7	V
IN Voltage	-0.5	$V_{DD1} + 0.5$	V
OE Voltage	-0.5	$V_{DD2} + 0.5$	V
OUT Voltage	-0.5	$V_{DD2} + 0.5$	V
Output Current Drive	-	10	mA
Human Body Model (Tested per AEC-Q100-002)	-	1.2	kV
Charge Device Model (Tested per AEC-Q100-011)	-	1.5	kV
Latch-up (Tested per JESD-78E; Class 2, Level A) at +125°C	-	100	mA

3.2 Outgas Testing

Specification (Tested per ASTM E 595, 1.5)	Value	Unit
Total Mass Lost ^[1]	0.06	%
Collected Volatile Condensable Material ^[1]	<0.01	%
Water Vapor Recovered	0.03	%

1. Results meet NASA low outgassing requirements of "Total Mass Loss" of <1% and "Collected Volatile Condensable Material" of <0.1%.

3.3 Thermal Information

Parameter	Package	Symbol	Conditions	Typical Value	Unit
Thermal Resistance	8 Ld SOIC Package	θ_{JA} ^[1]	Junction to ambient	60	°C/W
		Ψ_{JT} ^[2]	Junction to case	10	°C/W

1. θ_{JA} is measured with the component soldered to double-sided board; free air.

2. For Ψ_{JT} characterization parameter, the package top temperature is measured at the top center of the mounted package. See [TB379](#).

Parameter	Minimum	Maximum	Unit
Power Dissipation, P_D	-	675	mW
Maximum Junction Temperature	-	+150	°C
Storage Temperature Range	-65	+150	°C
Pb-Free Reflow Profile	See TB493		

3.4 Recommended Operating Conditions

Parameter	Minimum	Maximum	Unit
Ambient Operating Temperature	-55	+125	°C
Supply Voltage V_{DD1} , V_{DD2}	3.0	5.5	V
IN Logic High Voltage	2.4	V_{DD1}	V
IN Logic Low Voltage	0	0.8	V
\overline{OE} Logic High Voltage	2.4	V_{DD2}	V
\overline{OE} Logic Low Voltage	0	0.8	V
Input Signal Rise and Fall Time	-	1	μ s

3.5 Insulation Specifications

Parameter	Symbol	Test Conditions	Min	Typ	Max	Unit
Creepage Distance (external)	-	-	4.03	-	-	mm
Total Barrier Thickness (internal)	-	-	12	13	-	μ m
Leakage Current ^[1]	-	240V _{RMS} , 60Hz	-	200	-	nA
Barrier Resistance ^[1]	R_{IO}	500V _{DC}	-	$>10^{14}$	-	Ω
Barrier Capacitance ^[1]	C_{IO}	1MHz	-	1.1	-	pF
Comparative Tracking Index	CTI	Per IEC:60112	≥ 175	-	-	V
Working Voltage	V_{IORM}	Per VDE V 0884-10, V084-11 pending	600	-	-	V _{RMS}
Barrier Life	-	100°C, 1000V _{RMS} , 60% Confidence Level activation energy	-	44000	-	Years

1. Device is considered a two terminal device: Pins 1-4 shorted and Pins 5-8 shorted.

3.6 Safety and Approvals

- VDE V 0884-10 (VDE V 0884-11 pending) (Basic Isolation; VDE File Number 5022321-4880-0001)
 - Working voltage (V_{IORM}): 600V_{RMS} (848V_{PK}); basic insulation; pollution degree 2
 - Isolation voltage (V_{ISO}): 2500V_{RMS}
 - Transient overvoltage (V_{IOTM}): 4000V_{PK}
 - Surge rating: 4000V
 - Each part tested at 1590V_{PK} for 1s, 5pC partial discharge limit
 - Samples tested at 4000V_{PK} for 60s; then 1358V_{PK} for 10s with 5pC partial discharge limit

Safety-Limiting Values	Symbol	Value	Unit
Safety Rating Ambient Temperature	T_S	+180	°C
Safety Rating Power	P_S	270	mW
Supply Current Safety Rating (Total of Supplies)	I_S	54	mA

- UL 1577 (Component Recognition Program File Number E483309)
 - Each part tested at 3000V_{RMS} (4240V_{PK}) for 1s; each lot sample tested at 2500V_{RMS} (3530V_{PK}) for 1min

3.7 Electrical Specifications

Unless otherwise noted, V_{DD1} $V_{DD2} = 3V - 5.5V$; OUT and \overline{OE} are open, V_{DD1} and V_{DD2} are bypassed to GND with a 47nF X7R capacitor; $T_A = T_J = +25^\circ C$. Limits apply across the operating temperature range, $-55^\circ C$ to $+125^\circ C$ unless otherwise stated.

Parameter	Symbol	Test Conditions	Min ^[1]	Typ	Max ^[1]	Unit
3.3V Electrical Specifications						
Input Quiescent Supply Current (Figure 13)	I_{DD1}	-	-	8	40	μA
Output Quiescent Supply Current (Figure 14)	I_{DD2}	-	-	1.2	1.75	mA
Logic Input Current	I_I	-	-10	-	10	μA
Logic High Output Voltage (Figure 21)	V_{OH}	$I_O = -20\mu A, V_I = V_{IH}$	$V_{DD} - 0.1$	V_{DD}	-	V
		$I_O = -4mA, V_I = V_{IH}$	$0.8 \times V_{DD}$	$0.9 \times V_{DD}$	-	V
Logic Low Output Voltage (Figure 22)	V_{OL}	$I_O = 20\mu A, V_I = V_{IL}$	-	0	0.1	V
		$I_O = 4mA, V_I = V_{IL}$	-	0.5	0.8	V
Switching Specifications ($V_{DD} = 3.3V$)						
Maximum Data Rate		$C_L = 15pF$	130	140	-	Mbps
Pulse Width ^[2]	PW	50% Points, V_O	10	7.5	-	ns
Propagation Delay Input to Output (High-to-Low) (Figure 15)	t_{PHL}	$C_L = 15pF$	-	12	18	ns
Propagation Delay Input to Output (Low-to-High) (Figure 16)	t_{PLH}	$C_L = 15pF$	-	12	18	ns
Propagation Delay Enable to Output (High-to-High Impedance) (Figure 23)	t_{PHZ}	$C_L = 15pF$	-	3	7	ns
Propagation Delay Enable to Output (Low-to-High Impedance) (Figure 24)	t_{PLZ}	$C_L = 15pF$	-	3	7	ns
Propagation Delay Enable to Output (High Impedance-to-High) (Figure 25)	t_{PZH}	$C_L = 15pF$	-	3	7	ns
Propagation Delay Enable to Output (High Impedance-to-Low) (Figure 26)	t_{PZL}	$C_L = 15pF$	-	3	7	ns
Pulse-Width Distortion ^[3] (Figure 19)	PWD	$C_L = 15pF$	-	1	4	ns
Pulse Jitter ^[4]	t_J	$C_L = 15pF$	-	100	-	ps
Propagation Delay Skew ^[5]	t_{PSK}	$C_L = 15pF$	-	4	6	ns
Output Rise Time (10% to 90%) (Figure 17)	t_R	$C_L = 15pF$	-	2	5	ns
Output Fall Time (10% to 90%) (Figure 18)	t_F	$C_L = 15pF$	-	2	5	ns
Common-Mode Transient Immunity (Output Logic High or Logic Low) ^[6]	$ CM_H , CM_L $	$V_{CM} = 1500V_{DC}, t_{TRANSIENT} = 25ns$	30	50	-	kV/ μs
Dynamic Power Consumption ^[7] (Figure 20)	-	-	-	140	240	$\mu A/Mbps$
Magnetic Field Immunity^[8] ($V_{DD2} = 3V, 3V < V_{DD1} < 5.5V$)						
Power Frequency Magnetic Immunity	H_{PF}	50Hz/60Hz	1000	1500	-	A/m
Pulse Magnetic Field Immunity	H_{PM}	$t_p = 8\mu s$	1800	2000	-	A/m
Damped Oscillatory Magnetic Field	H_{OSC}	0.1Hz - 1MHz	1800	2000	-	A/m
Cross-Axis Immunity Multiplier ^[9]	K_X	-	-	2.5	-	-
5V Electrical Specifications						
Input Quiescent Supply Current (Figure 13)	I_{DD1}	-	-	10	75	μA
Output Quiescent Supply Current (Figure 14)	I_{DD2}	-	-	1.8	2.5	mA

Unless otherwise noted, V_{DD1} $V_{DD2} = 3V - 5.5V$; OUT and \overline{OE} are open, V_{DD1} and V_{DD2} are bypassed to GND with a 47nF X7R capacitor; $T_A = T_J = +25^\circ C$. Limits apply across the operating temperature range, $-55^\circ C$ to $+125^\circ C$ unless otherwise stated. (Cont.)

Parameter	Symbol	Test Conditions	Min ^[1]	Typ	Max ^[1]	Unit
Logic Input Current	I_I	-	-10	-	10	μA
Logic High Output Voltage (Figure 21)	V_{OH}	$I_O = -20\mu A, V_I = V_{IH}$	$V_{DD} - 0.1$	V_{DD}	-	V
		$I_O = -4mA, V_I = V_{IH}$	$0.8 \times V_{DD}$	$0.9 \times V_{DD}$	-	V
Logic Low Output Voltage (Figure 22)	V_{OL}	$I_O = 20\mu A, V_I = V_{IL}$	-	0	0.1	V
		$I_O = 4mA, V_I = V_{IL}$	-	0.5	0.8	V
Switching Specifications ($V_{DD} = 5V$)						
Maximum Data Rate	-	$C_L = 15pF$	130	150	-	Mbps
Pulse Width ^[2]	PW	50% Points, V_O	10	7.5	-	ns
Propagation Delay Input to Output (High-to-Low) (Figure 15)	t_{PHL}	$C_L = 15pF$	-	10	16	ns
Propagation Delay Input to Output (Low-to-High) (Figure 16)	t_{PLH}	$C_L = 15pF$	-	10	16	ns
Propagation Delay Enable to Output (High-to-High Impedance) (Figure 23)	t_{PHZ}	$C_L = 15pF$	-	3	7	ns
Propagation Delay Enable to Output (Low-to-High Impedance) (Figure 24)	t_{PLZ}	$C_L = 15pF$	-	3	7	ns
Propagation Delay Enable to Output (High Impedance-to-High) (Figure 25)	t_{PZH}	$C_L = 15pF$	-	3	7	ns
Propagation Delay Enable to Output (High Impedance-to-Low) (Figure 26)	t_{PZL}	$C_L = 15pF$	-	3	7	ns
Pulse-Width Distortion ^[3] (Figure 19)	PWD	$C_L = 15pF$	-	0.3	4	ns
Propagation Delay Skew ^[5]	t_{PSK}	$C_L = 15pF$	-	4	6	ns
Output Rise Time (10% to 90%) (Figure 17)	t_R	$C_L = 15pF$	-	1	4	ns
Output Fall Time (10% to 90%) (Figure 18)	t_F	$C_L = 15pF$	-	1	4	ns
Common Mode Transient Immunity (Output Logic High or Logic Low) ^[6]	$ CM_H , CM_L $	$V_{CM} = 1500V_{DC}, t_{TRANSIENT} = 25ns$	30	50	-	kV/ μs
Dynamic Power Consumption ^[7] (Figure 20)	-	-	-	200	340	$\mu A/Mbps$
Magnetic Field Immunity^[8] ($V_{DD2} = 5V, 3V < V_{DD1} < 5.5V$)						
Power Frequency Magnetic Immunity	H_{PF}	50Hz/60Hz	2800	3500	-	A/m
Pulse Magnetic Field Immunity	H_{PM}	$t_P = 8\mu s$	4000	4500	-	A/m
Damped Oscillatory Magnetic Field	H_{OSC}	0.1Hz - 1MHz	4000	4500	-	A/m
Cross-axis Immunity Multiplier ^[9]	K_X	-	-	2.5	-	-

1. Compliance to datasheet limits is assured by one or more methods: production test, characterization, and/or design.
2. Minimum pulse width is the minimum value at which specified PWD is ensured.
3. PWD is defined as $|t_{PHL} - t_{PLH}|$. %PWD is equal to PWD divided by pulse width.
4. 66535-bit pseudo-random binary signal (PRBS) NRZ bit pattern with no more than five consecutive 1s or 0s; 800ps transition time.
5. t_{PSK} is the magnitude of the worst-case difference in t_{PHL} and/or t_{PLH} between devices at $+25^\circ C$.
6. CM_H is the maximum common-mode voltage slew rate that can be sustained while maintaining $V_O > 0.8 V_{DD2}$. CM_L is the maximum common-mode input voltage that can be sustained while maintaining $V_O < 0.8V$. The common-mode voltage slew rate apply to both rising and falling common-mode voltage edges.
7. Dynamic power consumption is calculated per channel and is supplied by the channel's input side power supply.
8. The relevant test and measurement methods are given in [Electromagnetic Compatibility](#).
9. External magnetic field immunity is improved by this factor if the field direction is "end-to-end" rather than to "pin-to-pin" (see [Figure 27](#)).

4. Typical Performance Curves

$T_A = +25^\circ\text{C}$, unless otherwise specified.

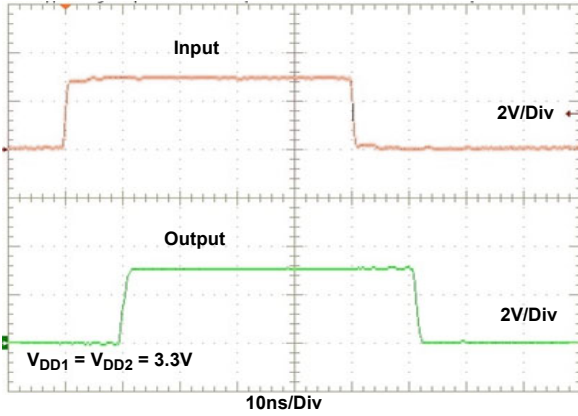

Figure 7. 10MHz Input and Output Waveforms

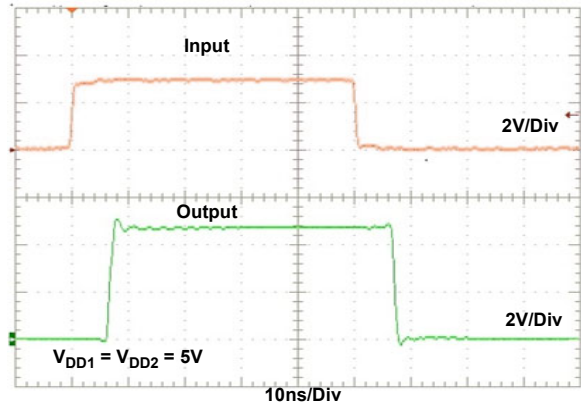

Figure 8. 10MHz Input and Output Waveforms

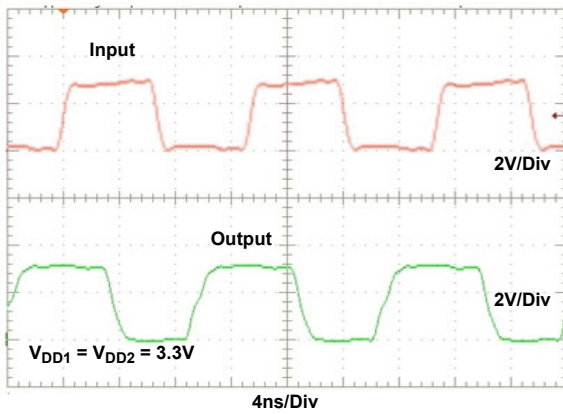

Figure 9. 75MHz Input and Output Waveforms

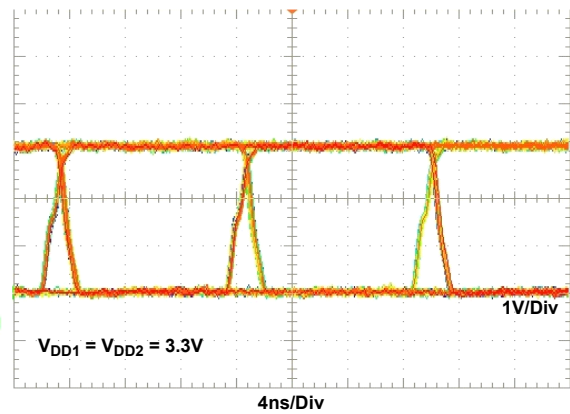

Figure 10. 75Mbps Eye Diagram

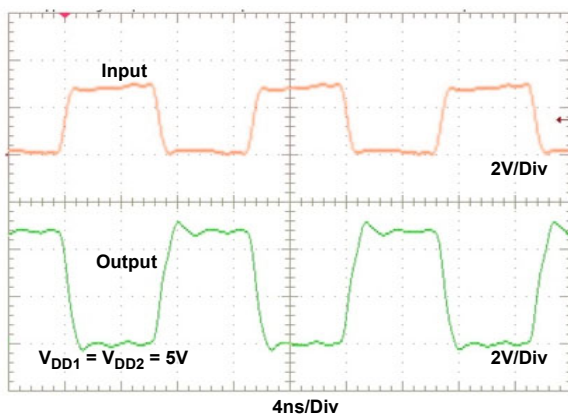

Figure 11. 75MHz Input and Output Waveforms

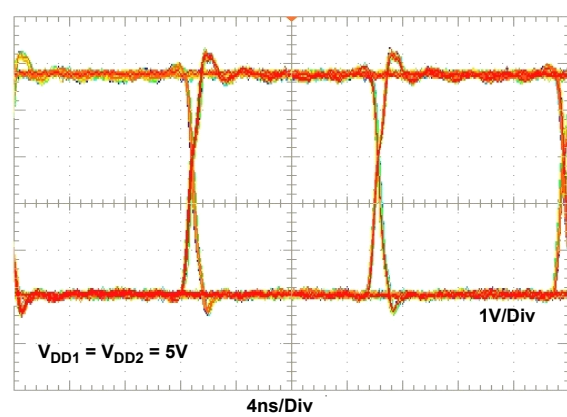

Figure 12. 75Mbps Eye Diagram

$T_A = +25^\circ\text{C}$, unless otherwise specified. (Cont.)

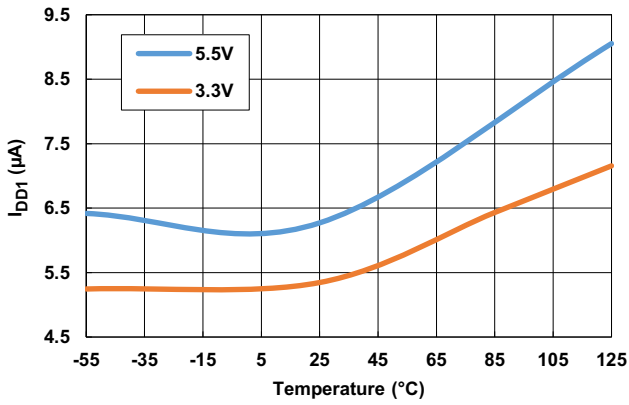

Figure 13. Input Quiescent Supply Current vs Temperature vs V_{DD1} Voltage

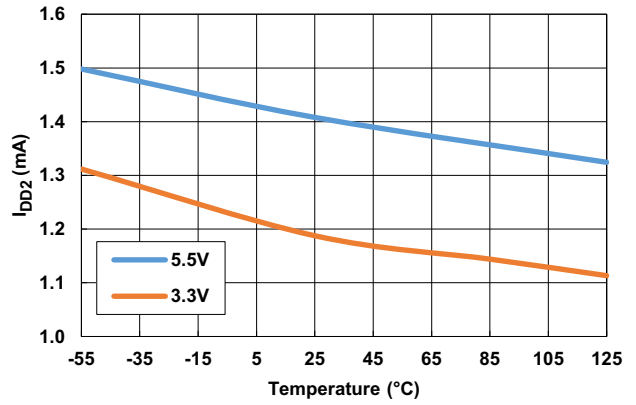

Figure 14. Output Quiescent Supply Current vs Temperature vs V_{DD2} Voltage

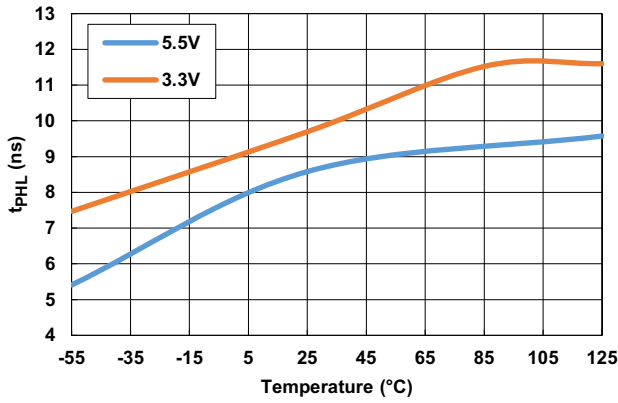

Figure 15. Propagation Delay (High-to-Low) vs Temperature vs V_{DD} Voltage

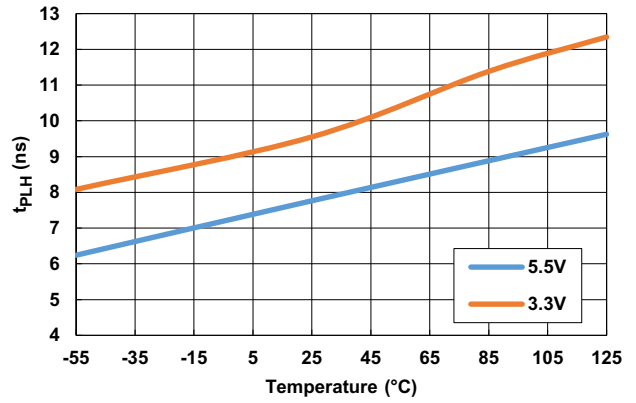

Figure 16. Propagation Delay (Low-to-High) vs Temperature vs V_{DD} Voltage

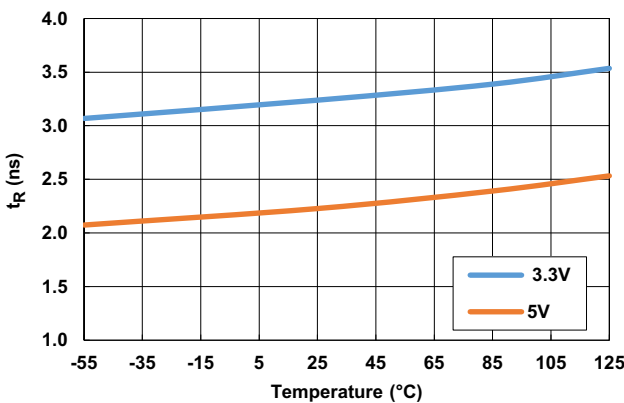

Figure 17. Output Rise Time vs Temperature vs V_{DD} Voltage

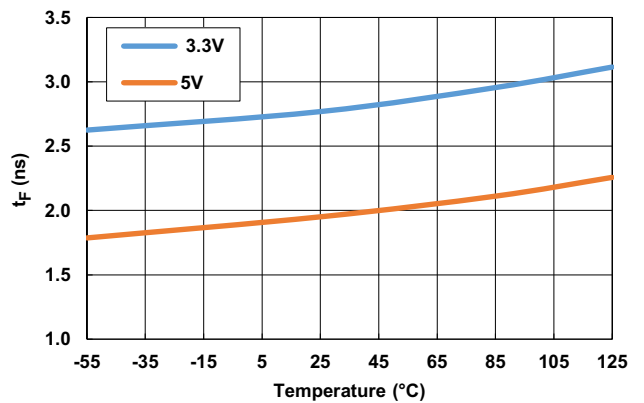

Figure 18. Output Fall Time vs Temperature vs V_{DD} Voltage

T_A = +25°C, unless otherwise specified. (Cont.)

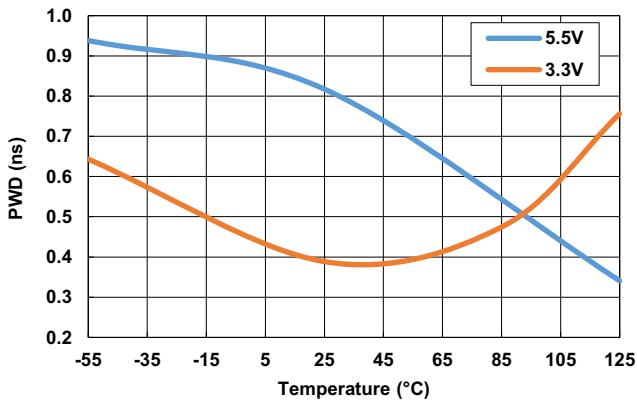

Figure 19. 5.5V Pulse-Width Distortion vs Temperature vs V_{DD} Voltage

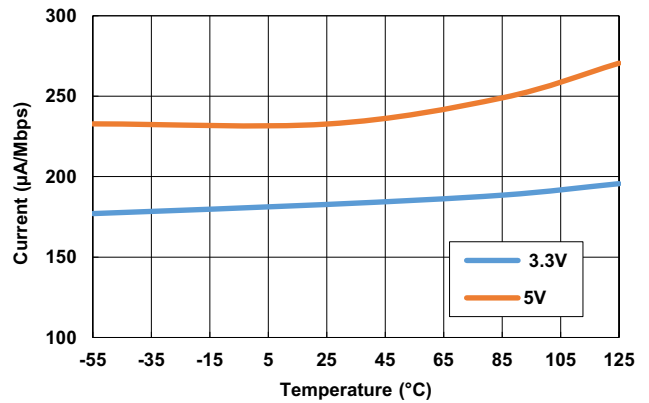

Figure 20. Dynamic Power Consumption vs Temperature

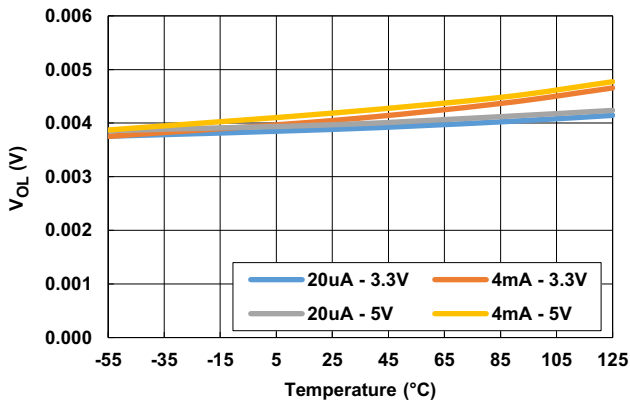

Figure 21. Logic Low Output Voltage vs Temperature

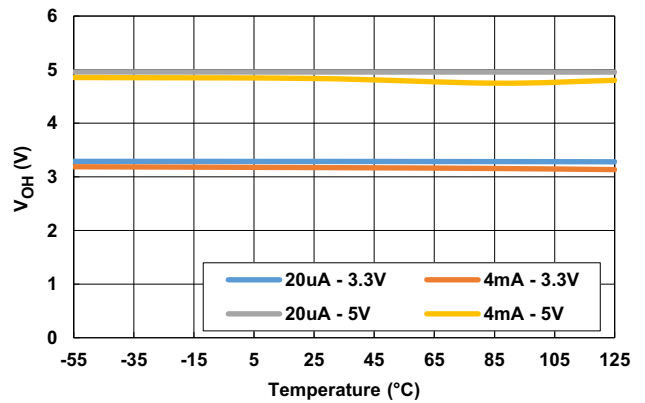

Figure 22. Logic High Output Voltage vs Temperature

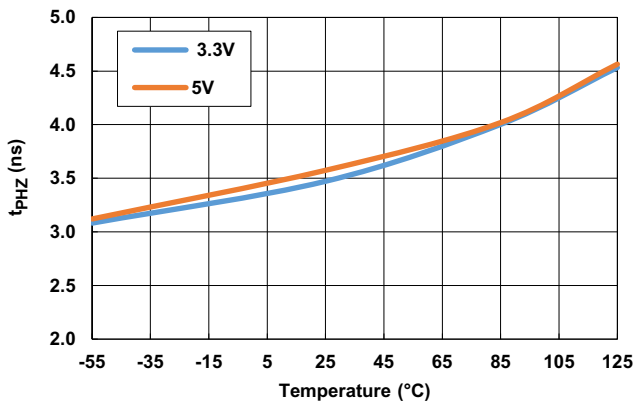

Figure 23. Propagation Delay Enable to Output (High-to-High Impedance) vs Temperature

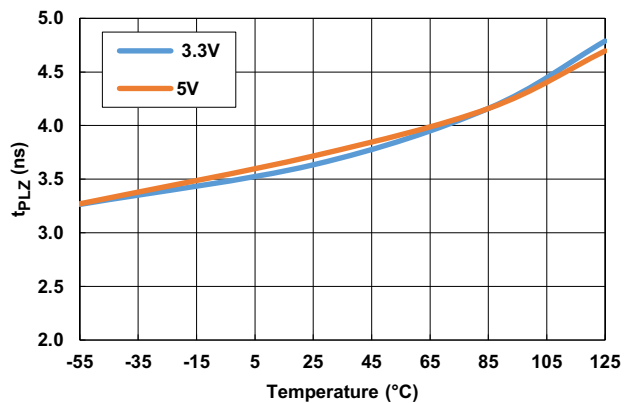

Figure 24. Propagation Delay Enable to Output (Low-to-High Impedance) vs Temperature

T_A = +25°C, unless otherwise specified. (Cont.)

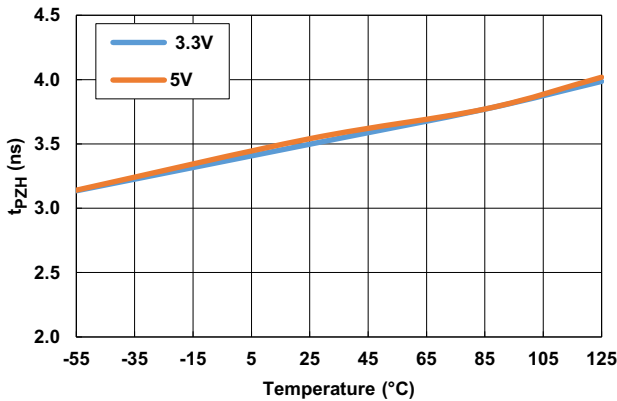

Figure 25. Propagation Delay Enable to Output (High Impedance-to-High) vs Temperature

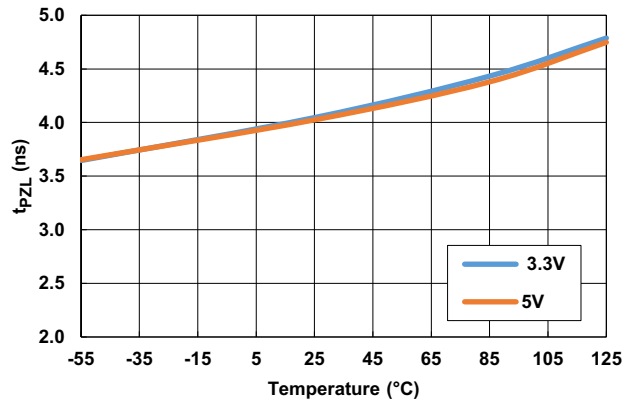

Figure 26. Propagation Delay Enable to Output (High Impedance-to-Low) vs Temperature

5. Device Information

5.1 Electrostatic Discharge Sensitivity

This product has been tested for electrostatic sensitivity to the limits stated in [Absolute Maximum Ratings](#). However, Renesas recommends that all integrated circuits are handled with appropriate care to avoid damage. Damage caused by inappropriate handling or storage could range from performance degradation to complete failure.

5.2 Electromagnetic Compatibility

The ISL71710M has the lowest EMC footprint of any isolation technology. Its Wheatstone bridge configuration and differential magnetic field signaling ensure excellent EMC performance against all relevant standards.

Immunity to external magnetic fields is even higher if the field direction is “end-to-end” rather than to “pin-to-pin” as shown in [Figure 27](#).

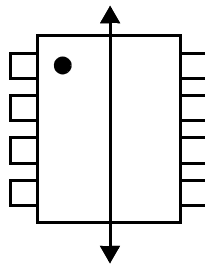

Figure 27. Cross-Axis Field Direction

5.3 Dynamic Power Consumption

The ISL71710M achieves its low power consumption from the way it transmits data across the isolation barrier. By detecting the edge transitions of the input logic signal and converting these to narrow current pulses, a magnetic field is created around the GMR Wheatstone bridge. Depending on the direction of the magnetic field, the bridge causes the output comparator to switch following the input logic signal. The power consumption is independent of mark-to-space ratio and solely dependent on frequency, because the current pulses are narrow, about 2.5ns. This has obvious advantages over optocouplers, which have power consumption heavily dependent on mark-to-space ratio.

5.4 Power Supply Decoupling

Both power supplies to these devices should be decoupled with low ESR 47nF ceramic capacitors. Ground planes for both GND1 and GND2 are highly recommended for data rates above 10Mbps. Capacitors must be located as close as possible to the VDD pins.

5.5 Signal Status on Start-Up and Shutdown

To minimize power dissipation, input signals are differentiated and then latched on the output side of the isolation barrier to reconstruct the signal. This could result in an indeterminate output state depending on power up, shutdown, and power loss sequencing. Therefore, consider including an initialization signal in the start-up circuit. Initialization consists of toggling the input either high then low, or low then high.

Complete the following supply sequencing steps to ensure the output starts in a known output state:

1. Start with the V_{DD1} , V_{DD2} , IN, and \overline{OE} pins all at 0V.
2. Ramp the V_{DD1} power supply ON.
3. Turn the IN signal source ON.
4. Toggle the IN input from High to Low to put the part in the Low state or toggle it from Low to High to put the part in the High state.
5. Ramp the V_{DD2} power supply ON. It starts in the state set in Step 4.

5.6 Data Transmission Rates

The reliability of a transmission system is directly related to the accuracy and quality of the transmitted digital information. For a digital system, parameters that determine the limits of the data transmission are pulse-width distortion and propagation delay skew.

Propagation delay is the time taken for the signal to travel through the device. This is usually different when sending a low-to-high than when sending a high-to-low signal. This difference, or error, is called Pulse-Width Distortion (PWD) and is usually in nanoseconds. It may also be expressed as a percentage:

- $PWD\% = [\text{Maximum Pulse-Width Distortion (ns)}/\text{Signal Pulse Width (ns)}] \times 100\%$

For example, with data rates of 12.5Mbps:

- $PWD\% = [3\text{ns}/80\text{ns}] \times 100\% = 3.75\%$

This figure is almost three times better than any available optocoupler with the same temperature range, and two times better than any optocoupler regardless of published temperature range. The ISL71710M exceeds the 10% maximum PWD recommended by PROFIBUS, and runs to nearly 35Mbps within the 10% limit.

Propagation delay skew is the signal propagation difference between two or more channels. This becomes significant in clocked systems because it is undesirable for the clock pulse to arrive before the data has settled. Short propagation delay skew is therefore especially critical in high data rate parallel systems for establishing and maintaining accuracy and repeatability. Worst-case channel-to-channel skew in an ISL71710M isolator is only 4ns, which is ten times better than any optocoupler. ISL71710M isolators have a maximum propagation delay skew of 6ns, which is five times better than any optocoupler.

6. Radiation Tolerance

The ISL71710M isolator is a radiation tolerant device for commercial space applications, Low Earth Orbits (LEO) applications, high altitude avionics, launch vehicles, and other harsh environments. This device's response to Total Ionizing Dose (TID) radiation effects, and Single Event Effects (SEE) has been measured, characterized, and reported in the proceeding sections. The TID performance of the ISL71710MBZ is not guaranteed through radiation acceptance testing. The ISL71710M30BZ is radiation lot acceptance tested (RLAT) to 30krd (Si), and the ISL71710M50BZ is radiation lot acceptance tested to 50krad (Si).

6.1 Total Ionizing Dose (TID) Testing

Total dose testing of the ISL71710MBZ proceeded in accordance with the guidelines of MIL-STD-883 Test Method 1019. The experimental matrix consisted of 32 samples irradiated at a 5.5V bias, as shown in [Table 1](#), and 16 samples irradiated with all pins grounded (unbiased). Three control units were used. The bias configuration is shown in [Figure 44](#).

Samples of the ISL71710MBZ were packaged in the production 8 Ld plastic NSOIC, Package Outline Drawing (POD) M8.15G. The samples were screened to datasheet limits at +125°C temperature only before irradiation.

Total dose irradiations were performed using a Hopewell Designs N40 panoramic vault-type low dose rate ⁶⁰Co irradiator located in the Renesas Palm Bay, Florida facility. The dose rate was < 10mrad(Si)/s. PbAl spectrum hardening filters were used to shield the test board and devices under test against low energy secondary gamma radiation.

Down points for the testing were 0krad(Si), 10krad(Si), 30krad(Si), and 50krad(Si). All electrical testing was performed outside the irradiator using production Automated Test Equipment (ATE) with data logging of all parameters at each down point. All down point electrical testing was performed at +25°C temperature.

6.1.1 Results

[Table 1](#) summarizes the attributes data.

Table 1. ISL71710M Total Dose Test Attributes Data

Dose Rate (mrad(Si)/s)	Bias	Sample Size	Down Point	Bin 1 ^[1]	Rejects
8.9	Biased Figure 44	32	Pre-rad	32	-
			10krad(Si)	32	0
			30krad(Si)	32	0
			50krad(Si)	32	0
8.9	Grounded	16	Pre-rad	16	-
			10krad(Si)	16	0
			30krad(Si)	16	0
			50krad(Si)	16	0

1. Bin 1 indicates a device that passes all datasheet specification limits.

The plots in [Figure 28](#) through [Figure 43](#) show data for key parameters at all down points. The plots show the average as a function of total dose for each of the irradiation conditions; we chose to use the average because of the relatively large sample sizes. All parts showed excellent stability over irradiation.

[Table 2](#) shows the average of some of these key parameters with respect to total dose in tabular form.

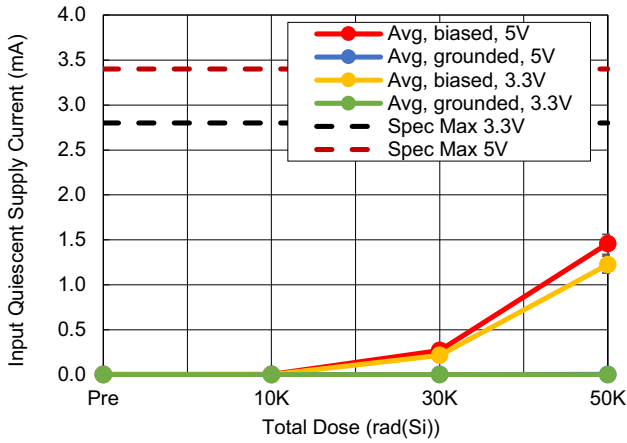

Figure 28. Input Quiescent Supply Current vs TID

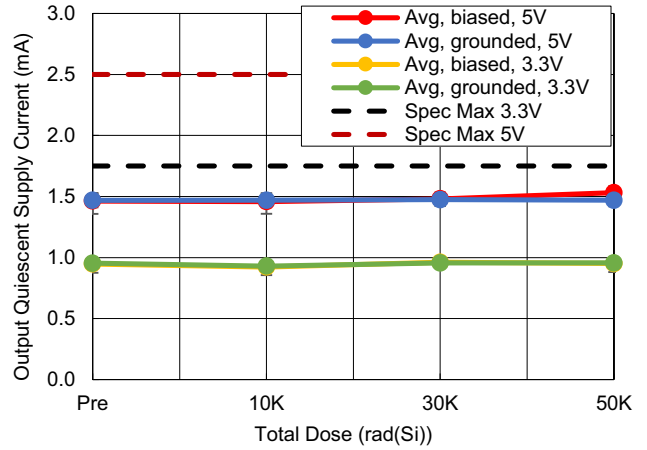

Figure 29. Output Quiescent Supply Current vs TID

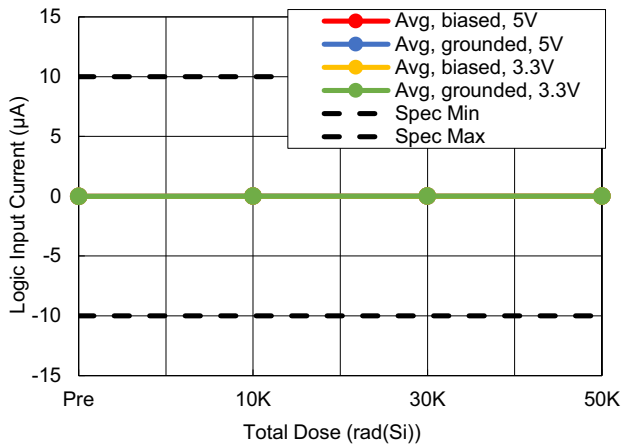

Figure 30. Logic Input Current vs TID

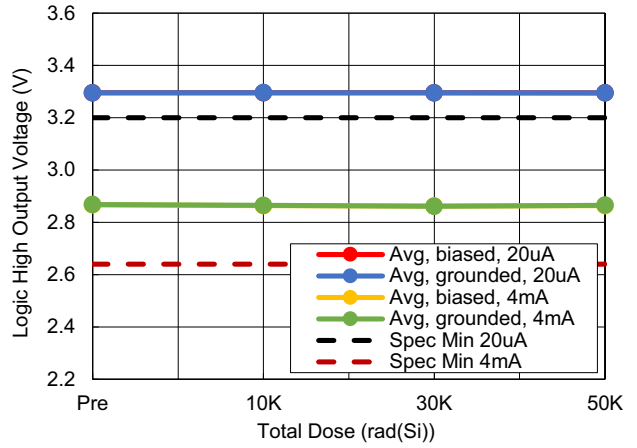

Figure 31. 3.3V Logic High Output Voltage vs TID

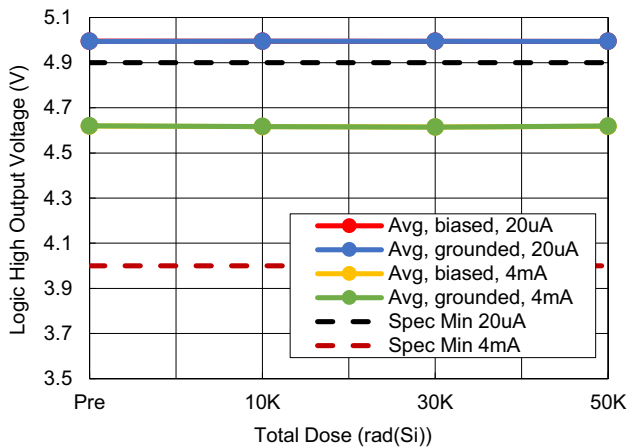

Figure 32. 5V Logic High Output Voltage vs TID

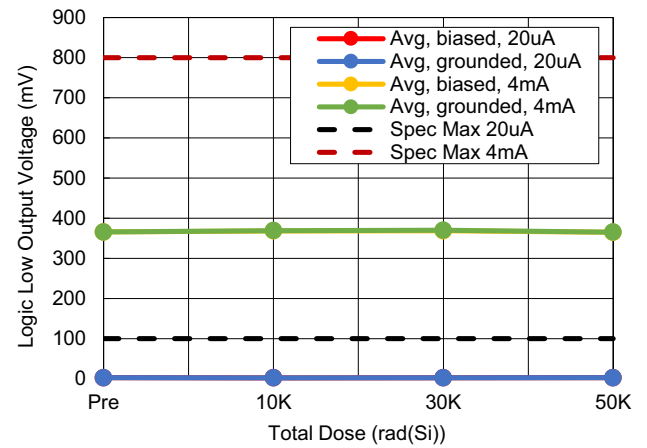

Figure 33. 3.3V Logic Low Output Voltage vs TID

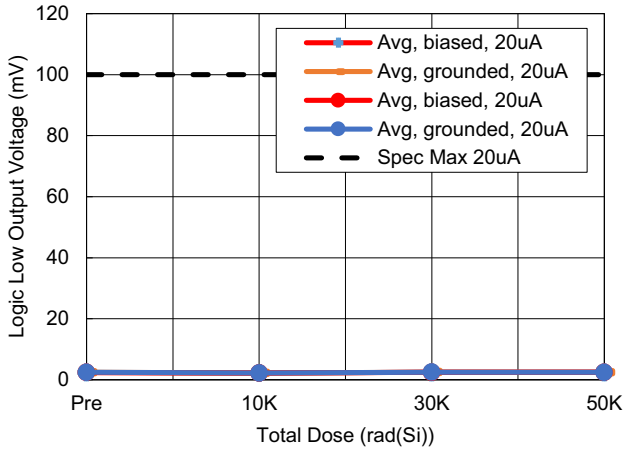

Figure 34. 5V Logic Low Output Voltage vs TID, 20uA

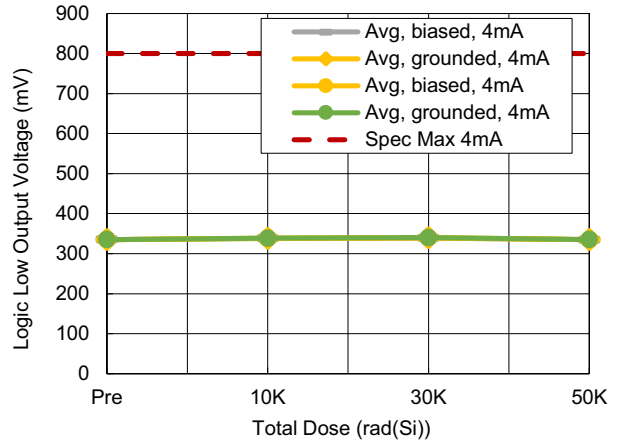

Figure 35. 5V Logic Low Output Voltage vs TID, 4mA

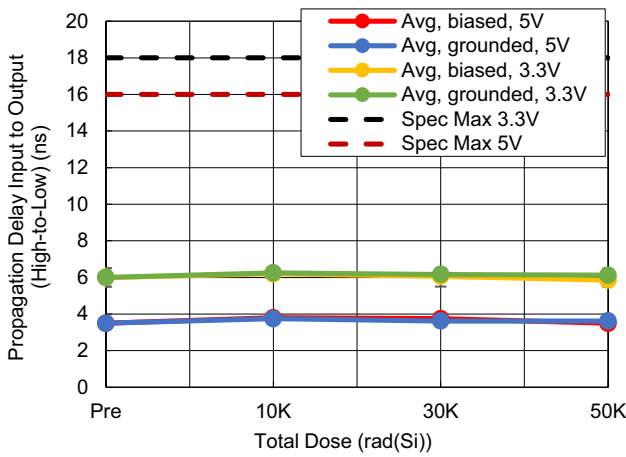

Figure 36. Propagation Delay (High-to-Low) vs TID

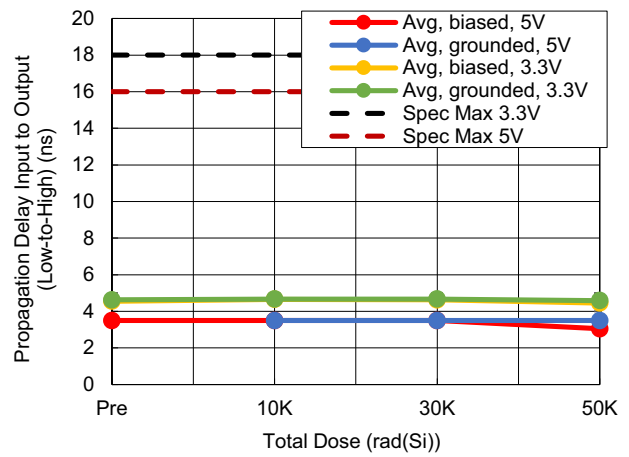

Figure 37. Propagation Delay (Low-to-High) vs TID

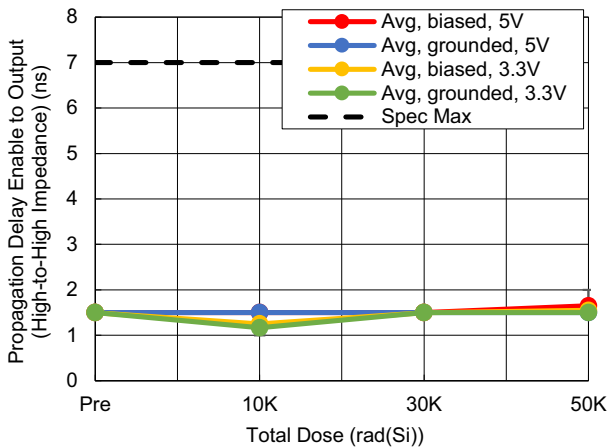

Figure 38. Propagation Delay EN (High-to-High Z) vs TID

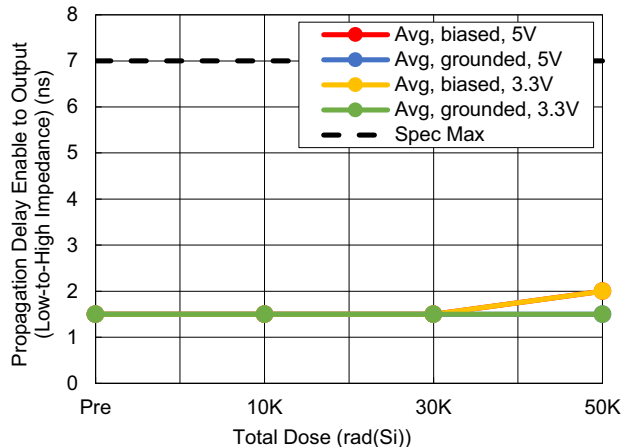

Figure 39. Propagation Delay EN (Low-to-High Z) vs TID

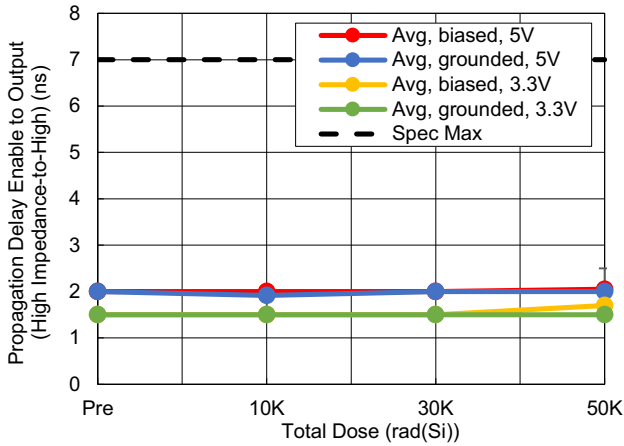

Figure 40. Propagation Delay EN (High Z to High) vs TID

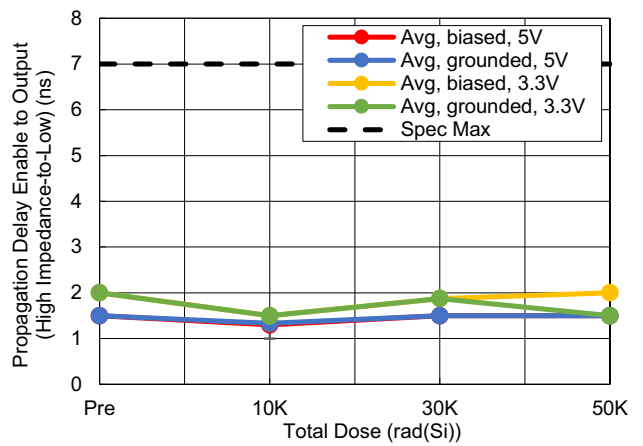

Figure 41. Propagation Delay EN (High Z to Low) vs TID

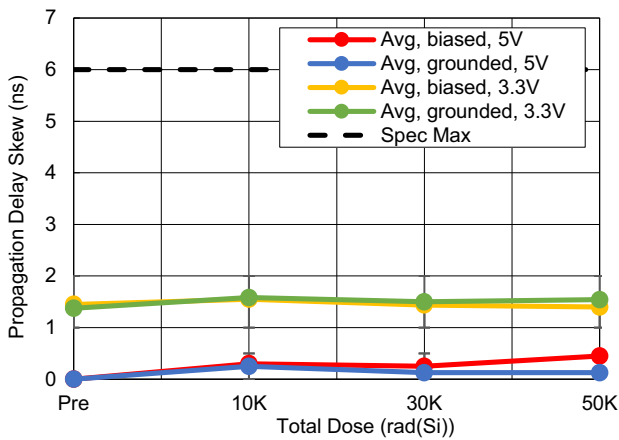

Figure 42. Propagation Delay Skew vs TID

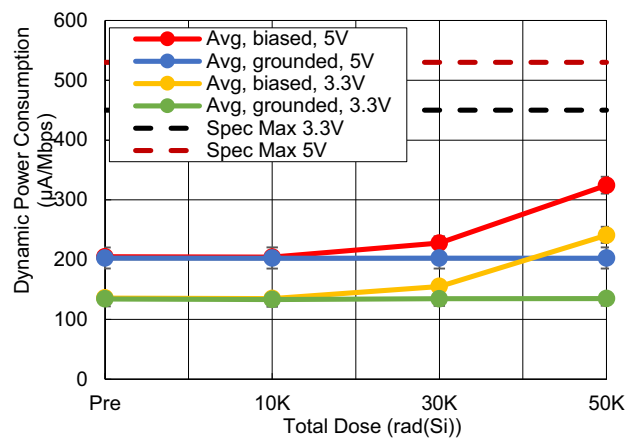

Figure 43. Dynamic Power Consumption vs TID

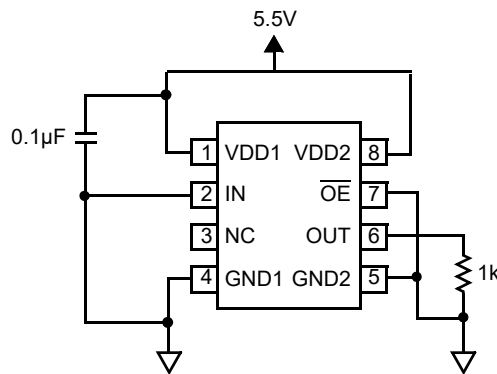

Figure 44. ISL71710M TID Biased Configuration

6.1.2 Conclusion

ATE characterization testing showed no rejects to the datasheet limits at all down points. Variables data for selected parameters is presented in Figure 28 through Figure 43. No differences between biased and unbiased irradiation were noted, and the part is not considered bias sensitive.

Table 2. ISL71710M Response of Selected Key Parameters vs TID

Parameter	Bias	0krad(Si)	10krad(Si)	30krad(Si)	50krad(Si)	Unit
5V Output Quiescent Supply Current	Biased	1.46348	1.46977	1.48083	1.53151	mA
	Grounded	1.46848	1.46977	1.47479	1.46881	
5V Input Quiescent Supply Current	Biased	0.00555	0.00546	0.27117	1.46017	mA
	Grounded	0.00556	0.00548	0.00548	0.00546	
5V Propagation Delay Input to Output (Low-to-High)	Biased	3.5	3.5	3.5	3.5	ns
	Grounded	3.5	3.5	3.5	3.5	
5V Propagation Delay Input to Output (High-to-Low)	Biased	3.50	3.80	3.75	3.50	ns
	Grounded	3.50	3.75	3.63	3.63	
5V Logic Input Current	Biased	-0.00836	0.00554	0.00551	0.00791	μA
	Grounded	-0.00887	0.01019	0.00464	0.00581	
5V Dynamic Power Consumption	Biased	204.73	204.22	227.67	324.29	μA/Mbps
	Grounded	202.56	202.47	202.45	202.49	
3.3V Output Quiescent Supply Current	Biased	0.94754	0.92189	0.96138	0.95411	mA
	Grounded	0.95292	0.92933	0.95567	0.95141	
3.3V Input Quiescent Supply Current	Biased	0.00222	0.00218	0.21798	1.22563	mA
	Grounded	0.00226	0.00216	0.00225	0.00221	
3.3V Propagation Delay Input to Output (Low-to-High)	Biased	4.55	4.65	4.625	4.45	ns
	Grounded	4.625	4.667	4.667	4.583	
3.3V Propagation Delay Input to Output (High-to-Low)	Biased	6.000	6.200	6.063	5.850	ns
	Grounded	6.000	6.250	6.166	6.125	
3.3V Logic Input Current	Biased	-0.00743	0.00789	0.00785	0.00814	μA
	Grounded	-0.00887	0.00843	0.00892	0.00892	
3.3V Dynamic Power Consumption	Biased	135.77	134.82	155.21	240.77	μA/Mbps
	Grounded	134.17	133.23	134.64	134.84	

6.2 Single Event Effects Testing

The intense heavy ion environment encountered in space applications can cause a variety of Single Event Effects (SEE). SEE can lead to system-level performance issues including disruption, degradation, and destruction. For predictable and reliable space system operation, individual electronic components should be characterized to determine their SEE response. The following is a summary of the SEE testing of the ISL71710M.

6.2.1 SEE Test Facility

Testing was performed at the Texas A&M University (TAMU) Cyclotron Institute heavy ion facility. This facility is coupled to a K500 superconducting cyclotron that is capable of generating a wide range of test particles with the various energy, flux, and fluence level needed for advanced radiation testing.

6.2.2 Scope of the ISL71710M SEE Testing

The ISL71710M is a single channel, active input, digital isolator in an 8 Ld NSOIC package. The testing described here was undertaken to do a preliminary evaluation of the ISL71710M for use in space applications. Both destructive Single Event Dielectric Rupture (SEDR) of the barrier isolation and non-destructive Single Event Transients (SET) were tested. In addition, destructive Single Event Burnout (SEB) and Single Event Latch-Up (SEL) of the CMOS circuitry were tested.

6.2.3 Testing Set Up

The plastic packages were opened chemically to expose the die surface so that SEE testing could be accomplished. Care had to be observed to ensure that the plastic was opened but that the isolation barrier was not compromised. This took a bit of trial and error, but a process to open the parts was found. When opened, the barrier isolation was degraded by free air breakdown to about $750V_{DC}$.

Four parts were mounted close together on boards for simultaneous irradiation. For the barrier SEDR testing the pins on either side of the barrier were all shorted together (1-4 on one side and 5-8 on the other side) so that a high voltage could be applied across the isolation barrier. For SEB and SEL testing the parts were powered with various V_{DD1} and V_{DD2} voltages while irradiating. For both forms of destructive SEE the parts were heated to $125^{\circ}C$. For the SET testing the parts were at $25^{\circ}C$ and biased with either 3.0V or 5.5V supplies with static inputs of both states tested.

6.2.4 Isolation Barrier SEDR Testing

Because the ISL71710M digital isolator has the same barrier and isolation construction as the ISL71610M digital isolator, the ISL71610M SEDR test results qualify by extension the ISL71710M part and it is rated to $500V_{DC}$ at $43MeV \cdot cm^2/mg$ SEDR. The following is the summary of the ISL71610M SEDR testing.

The ISL71610M barrier isolation SEDR was tested by biasing the four parts with 200V to 500V in 50V increments while irradiating with normal incidence silver (Ag) for a surface LET of $43MeV \cdot cm^2/mg$ to a fluence of 1×10^7 ion/cm² at each of the seven voltages. The four parts were heated to $+125^{\circ}C$ for the testing. The leakage current across the barrier of each part was measured before and after each irradiation to assess the change. The leakages all measured below 75nA both before and after irradiation. No leakage changed by more than 50% as a result of the irradiation being observed. The isolation barrier is rated to 500V over the entire temperature and voltage ranges.

6.2.5 SEB and SEL Testing

For SEB and SEL testing, the isolation barrier voltage was set to 0V and the four parts were powered with supply voltages for both V_{DD1} and V_{DD2} of 5.5V, 6.0V, 6.5V, and 7.0V. The parts were heated to $+125^{\circ}C$ during the testing. Before and after each irradiation to 1×10^7 ion/cm² with normal incidence silver (Ag) for a surface LET of $43MeV \cdot cm^2/mg$ the supply currents and the output voltages were measured at V_{DD} of 5.0V at both input states to exercise both output conditions. During irradiation the input had a 500kHz signal applied (0V-5V). None of the monitored values changed significantly (more than 1%) during the irradiations.

6.2.6 SET Testing

The ISL71710M was tested for qualification of Single Event Transients (SET) on October 16, 2018. The testing was done at Texas A&M University's Cyclotron Institute.

For SET testing the ISL71710 parts were tested two at a time (all within the beam diameter). The parts were tested in static operation for unambiguous detection of the SET. Each output was buffered and monitored by an oscilloscope that stored a trace whenever triggered. The triggers were set according to the nominal output. When the nominal output was a logic low (GND), the trigger was set for any transition through 0.8V. When the nominal output was logic high (V_{DD2}) the trigger was set for any transition through 2.0V. The supply voltages, V_{DD1} and V_{DD2} , were set together and to either 3.00V or 4.25V. These represent the lowest voltages anticipated for supplies of a 3.3V nominal and for a 5.0V nominal (including use with the ISL70040SEH low side GaN FET driver). The input voltage was set to either 0.8V or 2.4V to provide the marginal logic voltages. The summary of the SET counts appears in [Table 3](#).

Table 3. SET Count Summary for the Testing of ISL71710M

LET (MeV·cm ² /mg)	V _{IN} (V)	Trigger (V)	V _{DD1} and V _{DD2} (V)	SET Counts in 1x10 ⁷ ions/cm ²				Totals
				DUT1	DUT2	DUT3	DUT4	
43	0.8	0.8	3.00	9	4	11	2	26
			4.25	9	7	3	10	29
	2.4	2.0	3.00	0	0	0	7	7
			3.00	0	2	2	13	17
				DUT5	DUT6	DUT7	DUT8	
20	0.8	0.8	3.00	8	7	1	3	19
			4.25	6	1	4	1	12
	2.4	2.0	3.00	0	0	0	4	4
			3.00	0	4	7	8	19
8.5	0.8	0.8	3.00	8	2	4	2	16
			4.25	3	0	0	0	3
	2.4	2.0	3.00	0	0	0	0	0
			3.00	0	0	0	0	0

The captured SET traces for the case of 43MeV·cm²/mg were post processed with a MATLAB® routine to find the duration of the triggering SET. The duration was calculated as the initial transient time beyond the trigger level, either 0.8V or 2.0V depending on the nominal output. These results were plotted in a form similar to a probability plot and are presented in <Hyperlink>Figure 45. The longest SET observed was 18.4ns, for the case of V_{DD} at 3.00V and a high output. Durations were the output SET time below 2.0V for nominal high output, and the duration above 0.8V for a nominal low output. The legend identifies the V_{DD} setting and the input voltage setting.

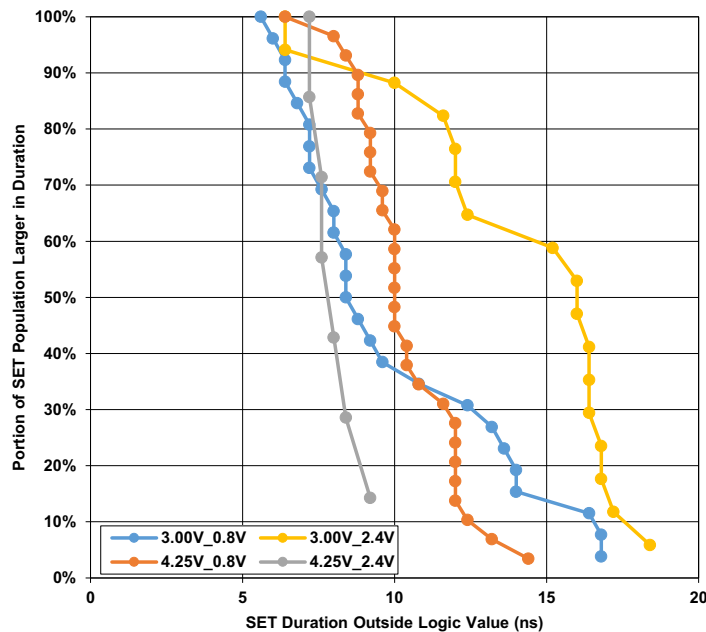

Figure 45. Plot of Cumulative SET Population Portion that is Above an Indicated SET Duration at LET 43MeV·cm²/mg

The longest SET transient captured for the ISL71710M at 43MeV·cm²/mg is presented in Figure 46. The twenty foot coaxial cable used to connect the oscilloscope to the buffer on the DUT induced considerable ringing that appears in Figure 46. No filtering was applied at the receiving end so as not to spread the initial events. The initial event in the figure is the sharp spike down that persists below 2.0V for 18.4ns. The smallest duration events

barely reached the 2.0V or 0.8 trigger levels and persisted for as little as 5.6ns. No significant difference was seen for either choice of V_{DD} (3.00V or 4.25V) or for the state of the output.

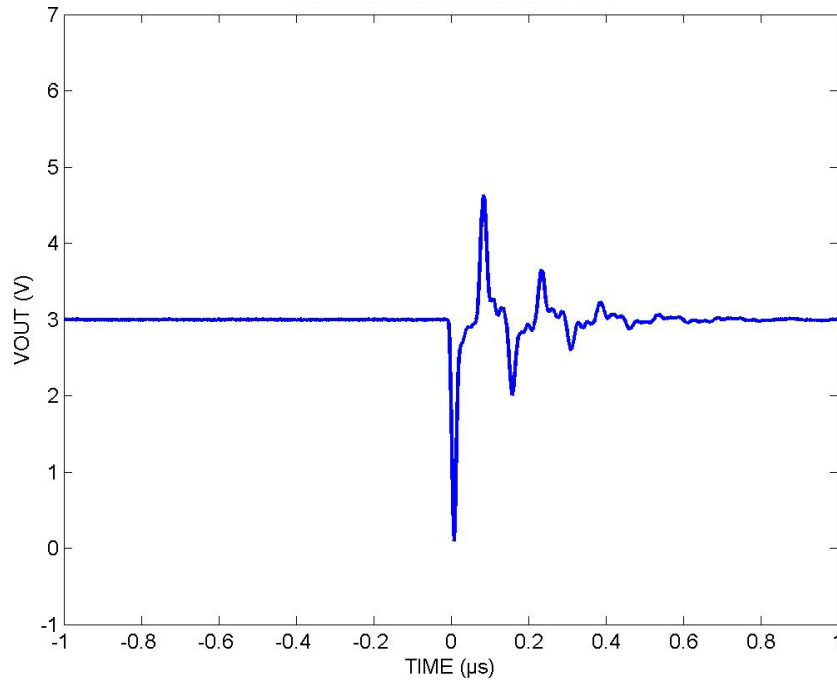

Figure 46. The SET of Extracted Duration of 18.4ns Below 2.0V in the First Impulse.

6.2.7 Summary

The ISL71710M common barrier isolation was immune to SEDR with normal incidence A_g for a LET of $43\text{MeV}\cdot\text{cm}^2/\text{mg}$ to a fluence of $1\times 10^7\text{ion}/\text{cm}^2$ at an isolation voltage of 500V.

The ISL71710M circuitry was immune to SEL and SEB with normal incidence A_g for an LET of $43\text{MeV}\cdot\text{cm}^2/\text{mg}$ to a fluence of $1\times 10^7\text{ion}/\text{cm}^2$ at a supply voltage of 7.0V.

The ISL71710M SET registered a maximum cross section of $130\mu\text{m}^2$ at $43\text{MeV}\cdot\text{cm}^2/\text{mg}$. This occurred for a V_{DD} of 3.0V with a nominally high output and had a maximum duration of 18.4ns. At $8.5\text{MeV}\cdot\text{cm}^2/\text{mg}$ the SET registered a maximum cross section of $80\mu\text{m}^2$ with a maximum duration of 60ns. This is an unusual event in its length and magnitude. As can be seen in [Figure 45](#) the bulk of the SET even at $43\text{MeV}\cdot\text{cm}^2/\text{mg}$ were well below 20ns in duration.

7. Package Outline Drawing

For the most recent package outline drawing, see [M8.15G](#).

M8.15G

8 Lead Narrow Body Small Outline Plastic Package
Rev 2, 10/18

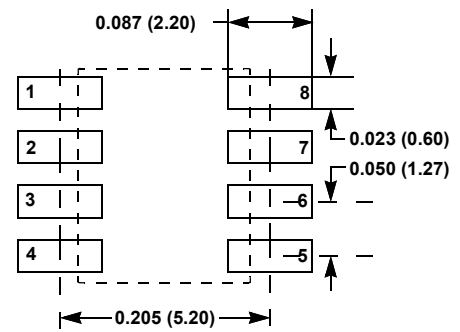
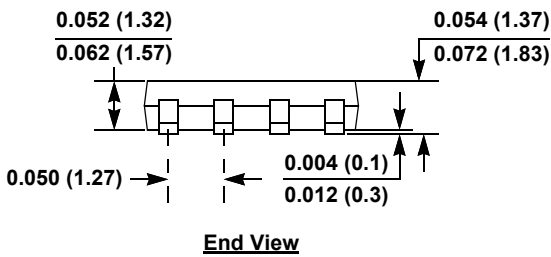
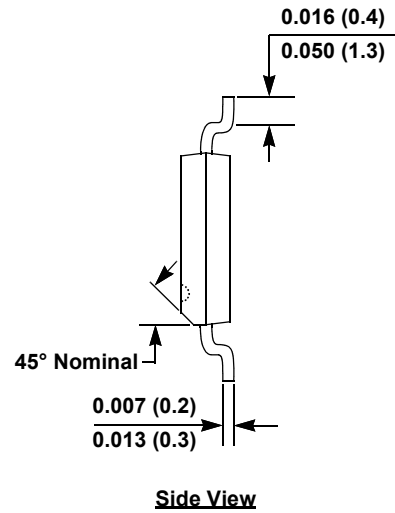
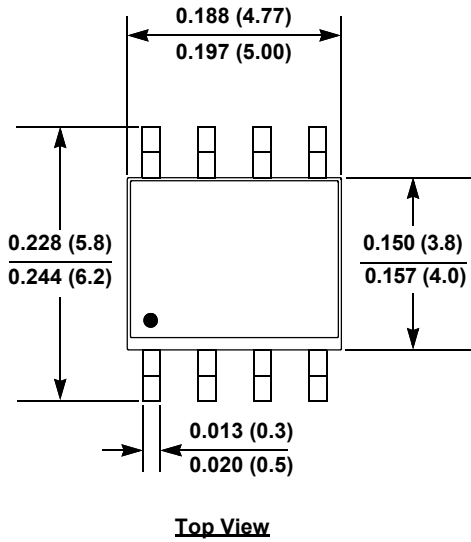

Notes:

1. Dimensions in inches (mm); scale = approximately 5X.
2. Pin spacing is a BASIC dimension; tolerances do not accumulate.

8. Ordering Information

Ordering Part Number ^{[1][2]}	Part Marking	Radiation Lot Acceptance Testing	Package Description (RoHS Compliant)	Package Drawing	Carrier Type ^[3]	Temp. Range
ISL71710MBZ	71710 MBZ	N/A	8 Ld NSOIC	M8.15G	Tube	-55 to +125 (°C)
ISL71710MBZ-T					Reel, 2.5k	
ISL71710MBZ-T7A					Reel, 250	
ISL71710M30BZ		Tube				
ISL71710M30BZ-T		Reel, 2.5k				
ISL71710M30BZ-T7A		Reel, 250				
ISL71710M50BZ		Tube				
ISL71710M50BZ-T		Reel, 2.5k				
ISL71710M50BZ-T7A		Reel, 250				
ISL71610-710EV1Z		Evaluation Board				

1. These Pb-free plastic packaged products employ special Pb-free material sets; molding compounds/die attach materials and NiPdAu-Ag plate-e4 termination finish, which is RoHS compliant and compatible with both SnPb and Pb-free soldering operations. Pb-free products are MSL classified at Pb-free peak reflow temperatures that meet or exceed the Pb-free requirements of IPC/JEDEC J STD-020.
2. For Moisture Sensitivity Level (MSL), see the [ISL71710M](#) product information page. For more information about MSL, see [TB363](#).
3. Refer to [TB347](#) for details about reel specifications.

9. Revision History

Revision	Date	Description
1.01	Mar 28, 2025	Updated to the latest template. Updated Features bullets. Added ISL71710M30BZ and ISL71710M50BZ part information throughout document.
1.00	Mar 11, 2021	Updated Figure 34 "ISL71710M TID Biased Configuration" to connect Pin 2 (IN) to GND1, and Pin 3 (NC) floating.
0.00	Nov 9, 2018	Initial release

IMPORTANT NOTICE AND DISCLAIMER

RENESAS ELECTRONICS CORPORATION AND ITS SUBSIDIARIES (“RENESAS”) PROVIDES TECHNICAL SPECIFICATIONS AND RELIABILITY DATA (INCLUDING DATASHEETS), DESIGN RESOURCES (INCLUDING REFERENCE DESIGNS), APPLICATION OR OTHER DESIGN ADVICE, WEB TOOLS, SAFETY INFORMATION, AND OTHER RESOURCES “AS IS” AND WITH ALL FAULTS, AND DISCLAIMS ALL WARRANTIES, EXPRESS OR IMPLIED, INCLUDING, WITHOUT LIMITATION, ANY IMPLIED WARRANTIES OF MERCHANTABILITY, FITNESS FOR A PARTICULAR PURPOSE, OR NON-INFRINGEMENT OF THIRD-PARTY INTELLECTUAL PROPERTY RIGHTS.

These resources are intended for developers who are designing with Renesas products. You are solely responsible for (1) selecting the appropriate products for your application, (2) designing, validating, and testing your application, and (3) ensuring your application meets applicable standards, and any other safety, security, or other requirements. These resources are subject to change without notice. Renesas grants you permission to use these resources only to develop an application that uses Renesas products. Other reproduction or use of these resources is strictly prohibited. No license is granted to any other Renesas intellectual property or to any third-party intellectual property. Renesas disclaims responsibility for, and you will fully indemnify Renesas and its representatives against, any claims, damages, costs, losses, or liabilities arising from your use of these resources. Renesas' products are provided only subject to Renesas' Terms and Conditions of Sale or other applicable terms agreed to in writing. No use of any Renesas resources expands or otherwise alters any applicable warranties or warranty disclaimers for these products.

(Disclaimer Rev.1.01)

Corporate Headquarters

TOYOSU FORESIA, 3-2-24 Toyosu,
Koto-ku, Tokyo 135-0061, Japan
www.renesas.com

Trademarks

Renesas and the Renesas logo are trademarks of Renesas Electronics Corporation. All trademarks and registered trademarks are the property of their respective owners.

Contact Information

For further information on a product, technology, the most up-to-date version of a document, or your nearest sales office, please visit www.renesas.com/contact-us/.