

To our customers,

---

## Old Company Name in Catalogs and Other Documents

---

On April 1<sup>st</sup>, 2010, NEC Electronics Corporation merged with Renesas Technology Corporation, and Renesas Electronics Corporation took over all the business of both companies. Therefore, although the old company name remains in this document, it is a valid Renesas Electronics document. We appreciate your understanding.

Renesas Electronics website: <http://www.renesas.com>

April 1<sup>st</sup>, 2010  
Renesas Electronics Corporation

Issued by: Renesas Electronics Corporation (<http://www.renesas.com>)

Send any inquiries to <http://www.renesas.com/inquiry>.

## Notice

1. All information included in this document is current as of the date this document is issued. Such information, however, is subject to change without any prior notice. Before purchasing or using any Renesas Electronics products listed herein, please confirm the latest product information with a Renesas Electronics sales office. Also, please pay regular and careful attention to additional and different information to be disclosed by Renesas Electronics such as that disclosed through our website.
2. Renesas Electronics does not assume any liability for infringement of patents, copyrights, or other intellectual property rights of third parties by or arising from the use of Renesas Electronics products or technical information described in this document. No license, express, implied or otherwise, is granted hereby under any patents, copyrights or other intellectual property rights of Renesas Electronics or others.
3. You should not alter, modify, copy, or otherwise misappropriate any Renesas Electronics product, whether in whole or in part.
4. Descriptions of circuits, software and other related information in this document are provided only to illustrate the operation of semiconductor products and application examples. You are fully responsible for the incorporation of these circuits, software, and information in the design of your equipment. Renesas Electronics assumes no responsibility for any losses incurred by you or third parties arising from the use of these circuits, software, or information.
5. When exporting the products or technology described in this document, you should comply with the applicable export control laws and regulations and follow the procedures required by such laws and regulations. You should not use Renesas Electronics products or the technology described in this document for any purpose relating to military applications or use by the military, including but not limited to the development of weapons of mass destruction. Renesas Electronics products and technology may not be used for or incorporated into any products or systems whose manufacture, use, or sale is prohibited under any applicable domestic or foreign laws or regulations.
6. Renesas Electronics has used reasonable care in preparing the information included in this document, but Renesas Electronics does not warrant that such information is error free. Renesas Electronics assumes no liability whatsoever for any damages incurred by you resulting from errors in or omissions from the information included herein.
7. Renesas Electronics products are classified according to the following three quality grades: “Standard”, “High Quality”, and “Specific”. The recommended applications for each Renesas Electronics product depends on the product’s quality grade, as indicated below. You must check the quality grade of each Renesas Electronics product before using it in a particular application. You may not use any Renesas Electronics product for any application categorized as “Specific” without the prior written consent of Renesas Electronics. Further, you may not use any Renesas Electronics product for any application for which it is not intended without the prior written consent of Renesas Electronics. Renesas Electronics shall not be in any way liable for any damages or losses incurred by you or third parties arising from the use of any Renesas Electronics product for an application categorized as “Specific” or for which the product is not intended where you have failed to obtain the prior written consent of Renesas Electronics. The quality grade of each Renesas Electronics product is “Standard” unless otherwise expressly specified in a Renesas Electronics data sheets or data books, etc.
  - “Standard”: Computers; office equipment; communications equipment; test and measurement equipment; audio and visual equipment; home electronic appliances; machine tools; personal electronic equipment; and industrial robots.
  - “High Quality”: Transportation equipment (automobiles, trains, ships, etc.); traffic control systems; anti-disaster systems; anti-crime systems; safety equipment; and medical equipment not specifically designed for life support.
  - “Specific”: Aircraft; aerospace equipment; submersible repeaters; nuclear reactor control systems; medical equipment or systems for life support (e.g. artificial life support devices or systems), surgical implantations, or healthcare intervention (e.g. excision, etc.), and any other applications or purposes that pose a direct threat to human life.
8. You should use the Renesas Electronics products described in this document within the range specified by Renesas Electronics, especially with respect to the maximum rating, operating supply voltage range, movement power voltage range, heat radiation characteristics, installation and other product characteristics. Renesas Electronics shall have no liability for malfunctions or damages arising out of the use of Renesas Electronics products beyond such specified ranges.
9. Although Renesas Electronics endeavors to improve the quality and reliability of its products, semiconductor products have specific characteristics such as the occurrence of failure at a certain rate and malfunctions under certain use conditions. Further, Renesas Electronics products are not subject to radiation resistance design. Please be sure to implement safety measures to guard them against the possibility of physical injury, and injury or damage caused by fire in the event of the failure of a Renesas Electronics product, such as safety design for hardware and software including but not limited to redundancy, fire control and malfunction prevention, appropriate treatment for aging degradation or any other appropriate measures. Because the evaluation of microcomputer software alone is very difficult, please evaluate the safety of the final products or system manufactured by you.
10. Please contact a Renesas Electronics sales office for details as to environmental matters such as the environmental compatibility of each Renesas Electronics product. Please use Renesas Electronics products in compliance with all applicable laws and regulations that regulate the inclusion or use of controlled substances, including without limitation, the EU RoHS Directive. Renesas Electronics assumes no liability for damages or losses occurring as a result of your noncompliance with applicable laws and regulations.
11. This document may not be reproduced or duplicated, in any form, in whole or in part, without prior written consent of Renesas Electronics.
12. Please contact a Renesas Electronics sales office if you have any questions regarding the information contained in this document or Renesas Electronics products, or if you have any other inquiries.

(Note 1) “Renesas Electronics” as used in this document means Renesas Electronics Corporation and also includes its majority-owned subsidiaries.

(Note 2) “Renesas Electronics product(s)” means any product developed or manufactured by or for Renesas Electronics.

# HA13173H

## Multiple Voltage Regulator for Car Audio

REJ03F0226-0100

Rev.1.00

Jan 16, 2007

---

### Description

The HA13173H is a multiple voltage regulator for car audio system. This IC has 5.0 V output for a microcontroller, 3.3 V output for a Digital Signal Processor, 8.0 V output for CD driver, 8.4 V output for audio control, 8.4 V output for illuminations, and high side switch output for external output.

The HA13173H also has FREG that is possible to control external PNP transistor. It is adjustable output voltage by changing an external resistor.

### Functions

- Standby current is 100  $\mu$ A max.
- The Vdd output for microcontroller has backup function, by independent power supply line.
- Low saturation output (PNP output) used for audio output.
- Output current limit circuit to avoid device destruction caused by shorted output, etc.
- High surge input protector against VB and VBUP.
- Built in a thermal shutdown circuit to prevent against the thermal destruction.
- The package is PRSS0015DA-C (SP-15TGV).

EOL announced Product

## Pin Description

Pin No.	Pin Name	Specification	Protection			
			Normal	TSD ON	VB = 24 V	VB = 50 V
1	GND	Ground	—	—	—	—
2	FREG_B	External transistor bias operation	On/Off	On/Off	Off	Off
3	FREG_F	FREG feed back terminal	On/Off	On/Off	Off	Off
4	ILM OUT	8.4 V output for ILM/500 mA max	On/Off	Off	Off	Off
5	CTL4	FREG control terminal	—	—	—	—
6	CD OUT	8.0 V output for CD/1.3 A max	On/Off	Off	Off	Off
7	DSP OUT	3.3 V output for DSP/250 mA max	On/Off	Off	Off	Off
8	VB	Battery	—	—	—	—
9	CTL3	ILM control terminal	—	—	—	—
10	AUDIO OUT	8.4 V output for AUDIO/500 mA max	On/Off	Off	Off	Off
11	CTL1	DSP, CD, AUDIO control terminal	—	—	—	—
12	EXT OUT	High side output/600 mA max	On/Off	Off	Off	Off
13	CTL2	EXT control terminal	—	—	—	—
14	VDD OUT	5.0 V output for microcontroller	On	On	On	Off
15	VBUP	Back up	—	—	—	—

Equivalent Circuit

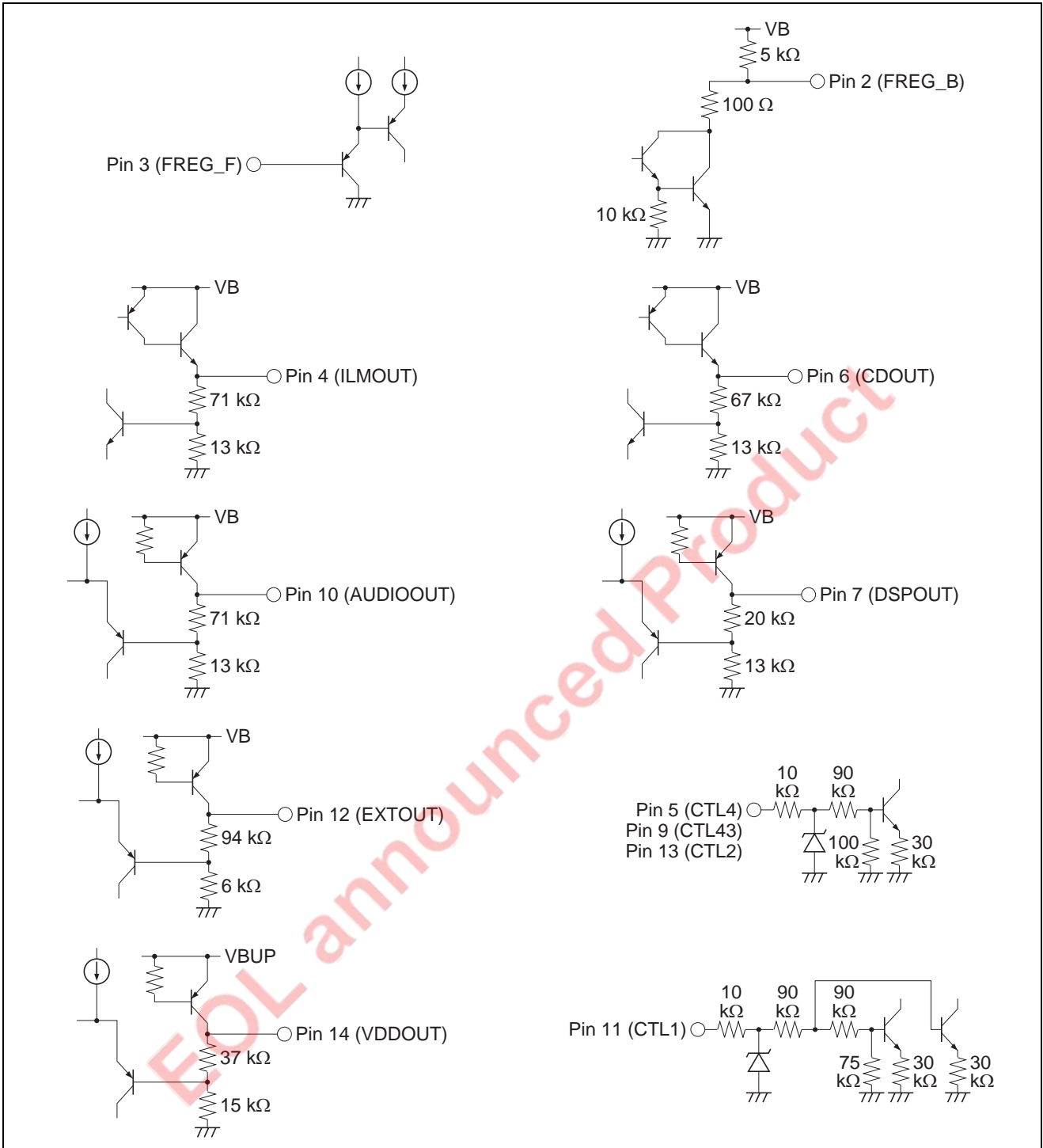

Timing Chart

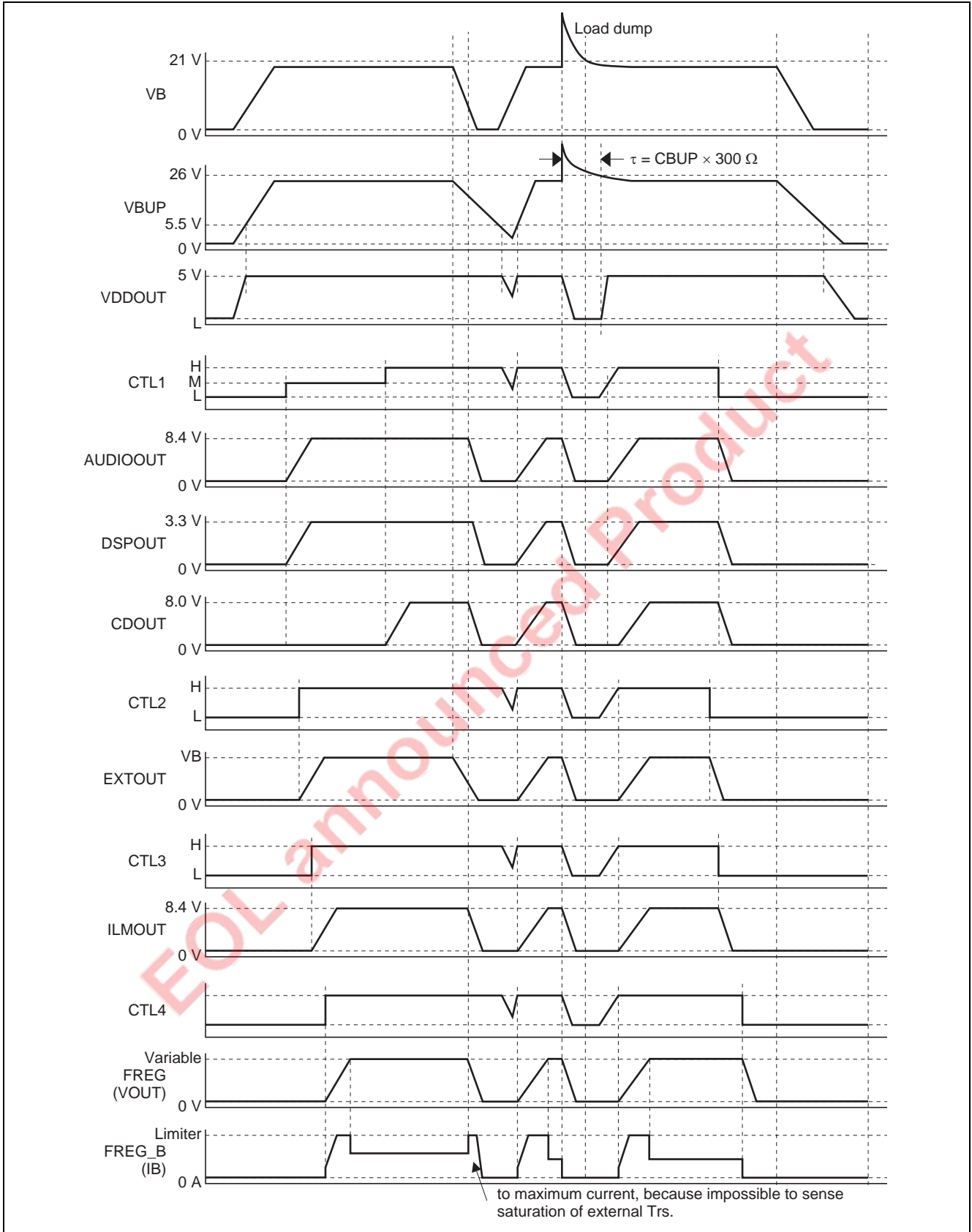

Block Diagram

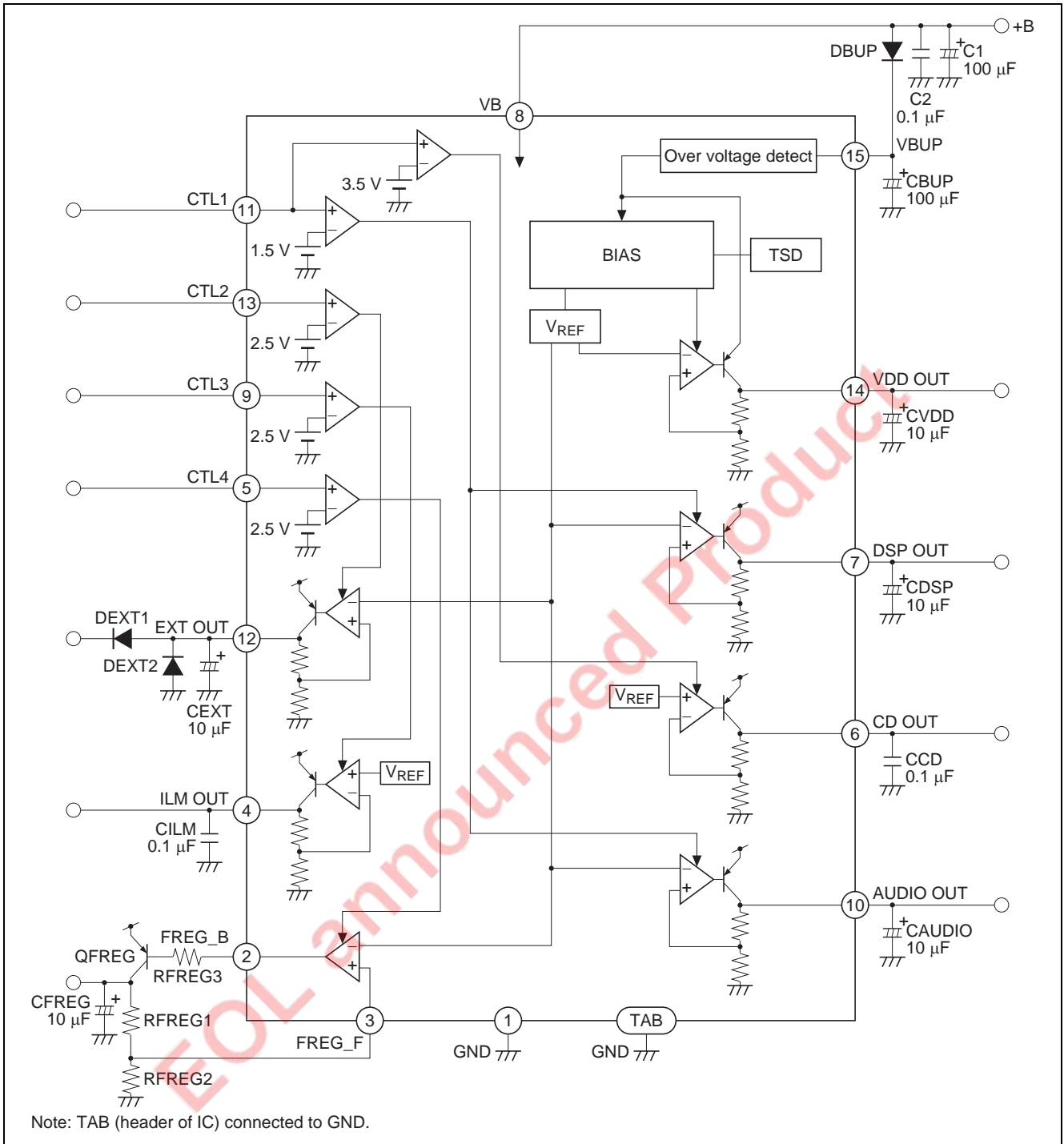

## External Parts Lineup

Parts No.	Function	Range of Recommended	Operation with Different Value from the Range of Recommended Value	
			More than the Range	Less than the Range
C1	Bypass capacitor	Upper 100 $\mu$ F	—	Unstable Lower ripple rejection ratio
C2	To prevent oscillation	0.1 $\mu$ F	Stability improve	Unstable
CBUP	B backup capacitor	0.1 to 1000 $\mu$ F	Backup time becomes long	Unstable
CCD CILM	To prevent oscillation	0.1 to 1000 $\mu$ F	Unconfirmed	Unstable
CVDD CDSP CAUDIO CFREG CEXT	To prevent oscillation	0.1 to 470 $\mu$ F	Unconfirmed	Unstable
DBUP		IF $\geq$ 200 mA	Be careful of the maximum rating	
DEXT1 DEXT2	Protection against mistake in joining. Terminal protection for short circuit to +B when VCC terminal is open and for short circuit to GND when GND terminal is open. We recommend Schottky barrier diodes.	IF $\geq$ 1 A	—	Be careful of the maximum rating. The ability to protect terminal lower. And there is some possibility of destruction.
RFREG1 RFREG2	Output voltage = $(1 + \text{RFREG1/RFREG2}) \times 1.26 \text{ V}$	100 to 10 k $\Omega$	Unstable	Loss of current increases
GFREG3	Resistance for limiting base current of PNP transistor	Choose resistance by a required output current value and hFE of PNP transistor		
QFREG	Output PNP transistor for FREG (We recommend Renesas 2SB857.)	hFE = 50 to 200	Choose resistance by a required output current value and hFE of PNP transistor	
			Unstable	Lower output current capability

Notes: 1. We recommend Polyester film capacitor. To improve stability, take notes of the below precautions.

- (1) Use capacitor that is temperature independent.
  - (2) Use capacitor that is bias voltage independent.
  - (3) In order to bypass high frequency noise efficiently, mount the capacitor as close as possible to the VCC and GND of IC to eliminate PCB pattern inductance.
2. For using of the lower limit of recommended value, take notes of the below precautions.
- (1) Use capacitor that is temperature independent.
  - (2) Use capacitor that is bias voltage independent.
  - (3) To eliminate PCB pattern inductance mount the capacitor as close as possible to the output pin and GND of IC.
3. To improve stability, take notes of the below precautions.
- (1) Use capacitor that is temperature independent.
  - (2) Use capacitor that is bias voltage independent.
  - (3) ESR needs to be less than 10  $\Omega$  in all the temperature ranges to be used.
  - (4) To eliminate PCB pattern inductance mount the capacitor as close as possible to the output pin and GND of IC.



### Absolute Maximum Ratings

(Ta = 25°C)

Item	Symbol	Rating	Unit	Note
Operating power supply voltage 1	Vcc1	19	V	
Operating power supply voltage 2	Vcc2	24	V	1
Peak voltage	Vcc(PEAK)	50	V	2
Power dissipation	Pd	36	W	3
Junction temperature	Tj	150	°C	
Operating temperature	Topr	-40 to +85	°C	
Storage temperature	Tstg	-55 to +125	°C	

Notes: Recommended power supply voltage range 10 to 16 V.

1. Applied time is less than 60 s.
2. Surge pulse as input.
3. Ta = 25°C. : Permissible power dissipation when using a heat sink of infinite area. Refer to the derating curves below.

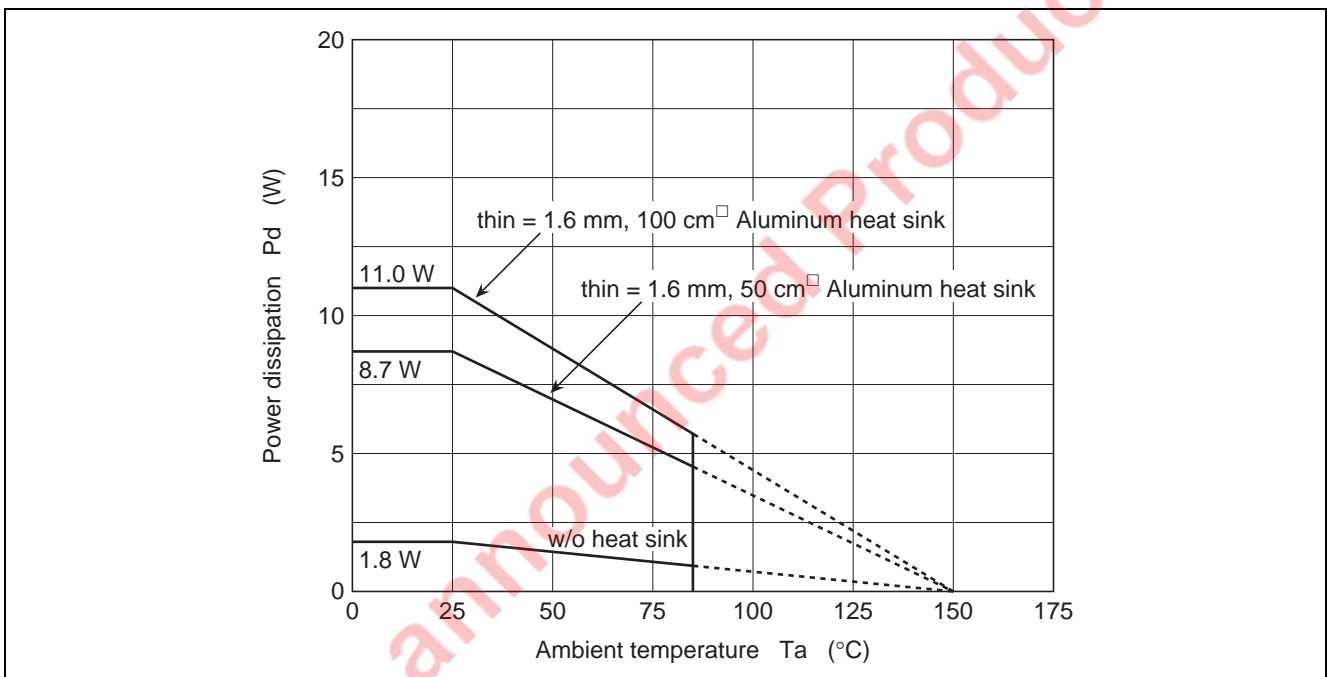

## Electrical Characteristics

Item	Symbol	Min	Typ	Max	Unit	Test Condition	
Standby current	IST	—	65	100	μA	CTL1, 2, 3, 4 = 0 V	
CTL1 L level (DSP, AUDIO, CD OFF)	VC1L	0.0	—	1.0	V		
CTL1 M level (DSP, AUDIO ON, CD OFF)	VC1M	2.0	—	3.0	V		
CTL1 H level (DSP, AUDIO, CD ON)	VC1H	4.0	—	6.0	V		
CTL2 L level (EXT OFF)	VC2L	0.0	—	2.0	V		
CTL2 H level (EXT ON)	VC2H	3.0	—	6.0	V		
CTL3 L level (ILM OFF)	VC3L	0.0	—	2.0	V		
CTL3 H level (ILM ON)	VC3H	3.0	—	6.0	V		
CTL4 L level (FREG OFF)	VC4L	0.0	—	2.0	V		
CTL4 H level (FREG ON)	VC4H	3.0	—	6.0	V		
VDD OUT	Output voltage	Vo1	4.75	5.00	5.25	V	Io1 = 160 mA
	Voltage regulation	ΔVo11	—	10	50	mV	Vcc = 10 to 16 V, Io1 = 160 mA
	Load regulation	ΔVo12	—	50	100	mV	Io1 = 0 to 160 mA
	Minimum I/O voltage differential	ΔVo13	—	0.4	0.9	V	Io1 = 160 mA
	Output current capacity	Io1	200	400	—	mA	Vo1 ≥ 4.75 V
	Ripple rejection ratio	SVR1	45	55	—	dB	f = 100 Hz, Io1 = 160 mA
CD OUT	Output voltage	Vo2	7.6	8.0	8.4	V	Io2 = 1.0 A
	Voltage regulation	ΔVo21	—	40	100	mV	Vcc = 10 to 16V, Io2 = 1.0 A
	Load regulation	ΔVo22	—	70	150	mV	Io2 = 10m to 1.0 A
	Minimum I/O voltage differential	ΔVo23	—	1.0	1.5	V	Io2 = 1.0 A
	Output current capacity	Io2	1.3	2.0	—	mA	Vo2 ≥ 7.6 V
	Ripple rejection ratio	SVR2	40	50	—	dB	f = 100 Hz, Io2 = 1.0 A
AUDIO OUT	Output voltage	Vo3	8.1	8.4	8.7	V	Io3 = 400 mA
	Voltage regulation	ΔVo31	—	30	90	mV	Vcc = 10 to 16 V, Io3 = 400 mA
	Load regulation	ΔVo32	—	100	200	mV	Io3 = 10 to 400 mA
	Minimum I/O voltage differential	ΔVo33	—	0.4	0.9	V	Io3 = 400 mA
	Output current capacity	Io3	500	850	—	mA	Vo3 ≥ 8.1 V
	Ripple rejection ratio	SVR3	45	50	—	dB	f = 100 Hz, Io3 = 400 mA
DSP OUT	Output voltage	Vo4	3.1	3.3	3.5	V	Io4 = 200 mA
	Voltage regulation	ΔVo41	—	40	100	mV	Vcc = 10 to 16 V, Io4 = 200 mA
	Load regulation	ΔVo42	—	50	100	mV	Io4 = 0 to 200 mA
	Output current capacity	Io4	250	500	—	mA	Vo4 ≥ 3.1 V
	Ripple rejection ratio	SVR4	45	55	—	dB	f = 100 Hz, Io4 = 200 mA
ILM OUT	Output voltage	Vo5	8.0	8.4	8.8	V	Io5 = 400 mA
	Voltage regulation	ΔVo51	—	40	100	mV	Vcc = 10 to 16 V, Io5 = 400 mA
	Load regulation	ΔVo52	—	70	150	mV	Io5 = 10 to 400 mA
	Minimum I/O voltage differential	ΔVo53	—	1.0	1.3	V	Io5 = 400 mA
	Output current capacity	Io5	500	900	—	mA	Vo5 ≥ 8.0 V
	Ripple rejection ratio	SVR5	40	50	—	dB	f = 100 Hz, Io5 = 400 mA
EXT OUT	Minimum I/O voltage differential	ΔVo61	—	0.6	1.0	V	Vcc = 10 to 16 V, Io6 = 480 mA
	Output current capacity	Io6	600	900	—	mA	Vo61 ≤ 1.0 V
FREG OUT	FREG_F Output voltage	VFF7	1.20	1.26	1.32	V	Iload (external PNP) = 400 mA
	FREG_F Voltage regulation	ΔVFF71	—	10	25	mV	Vcc = 10 to 16 V, Iload = 400 mA
	FREG_F Load regulation	ΔVFF72	—	10	25	mV	Iload = 10 to 400 mA
	FREG_B Output current capacity	IFB7	35	50	80	mA	VFF ≥ 1.20 V
	FREG_F input bias current	IFF7	—	50	300	nA	

Evaluation Circuit

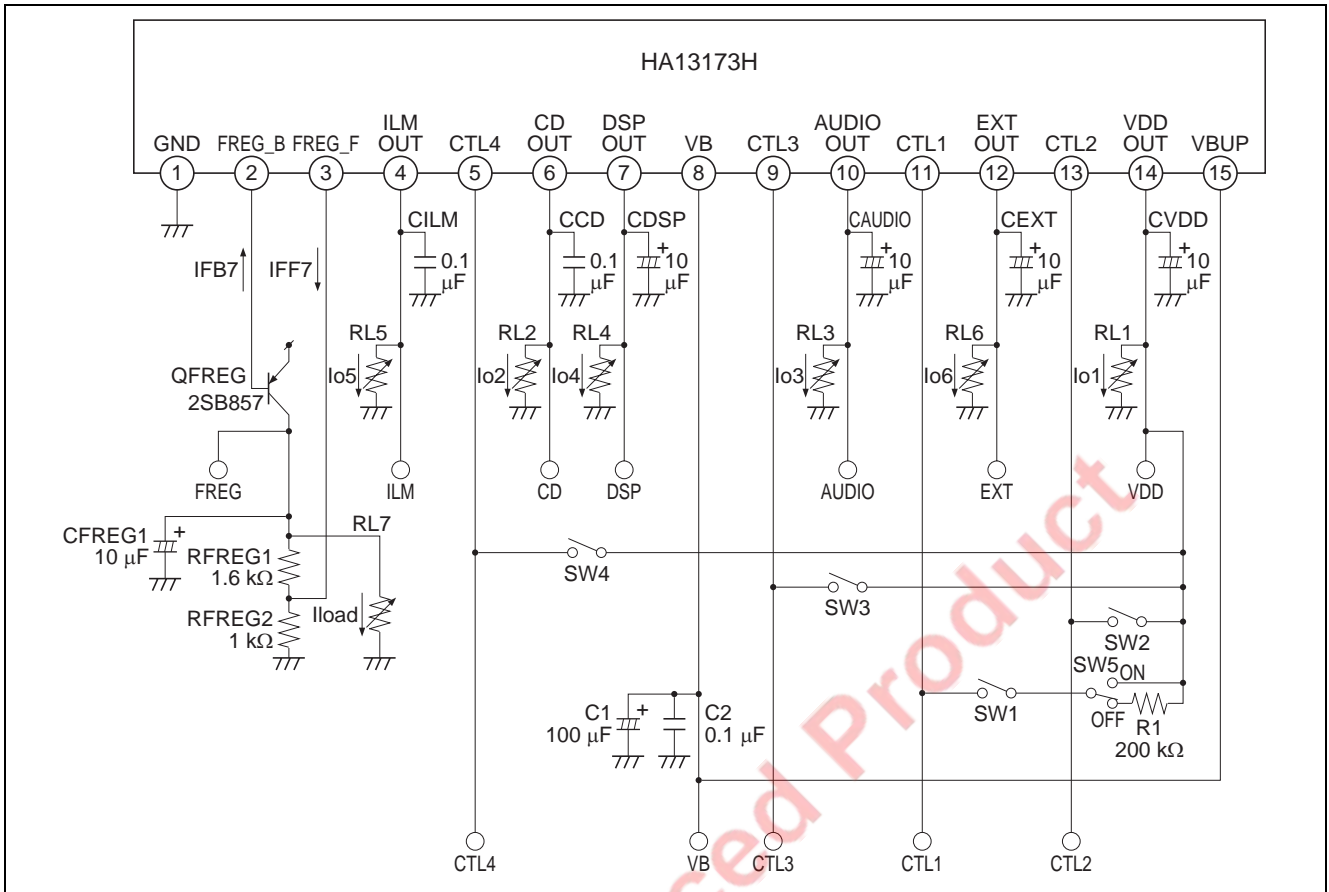

Main Characteristics

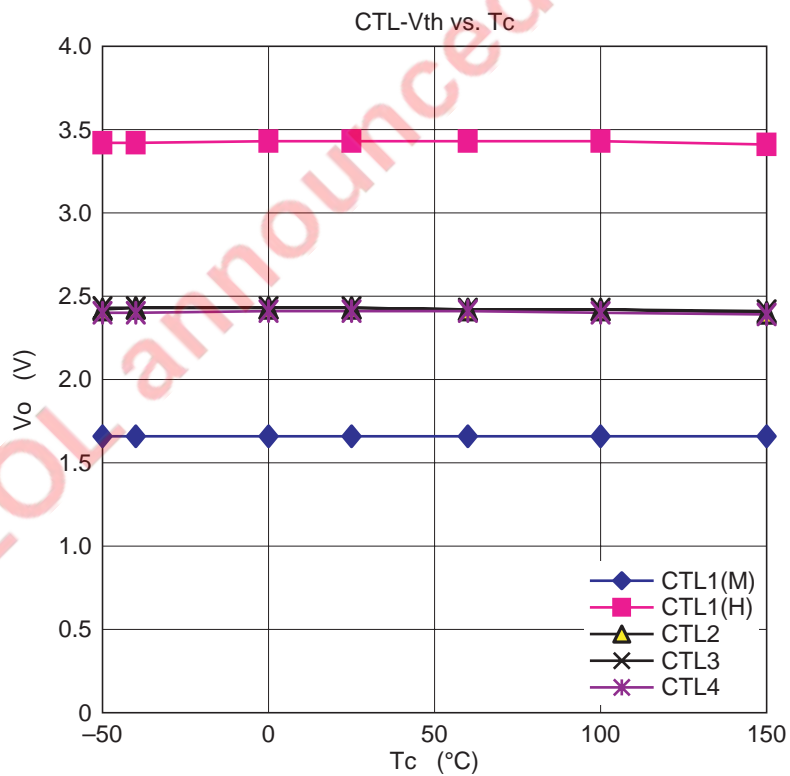
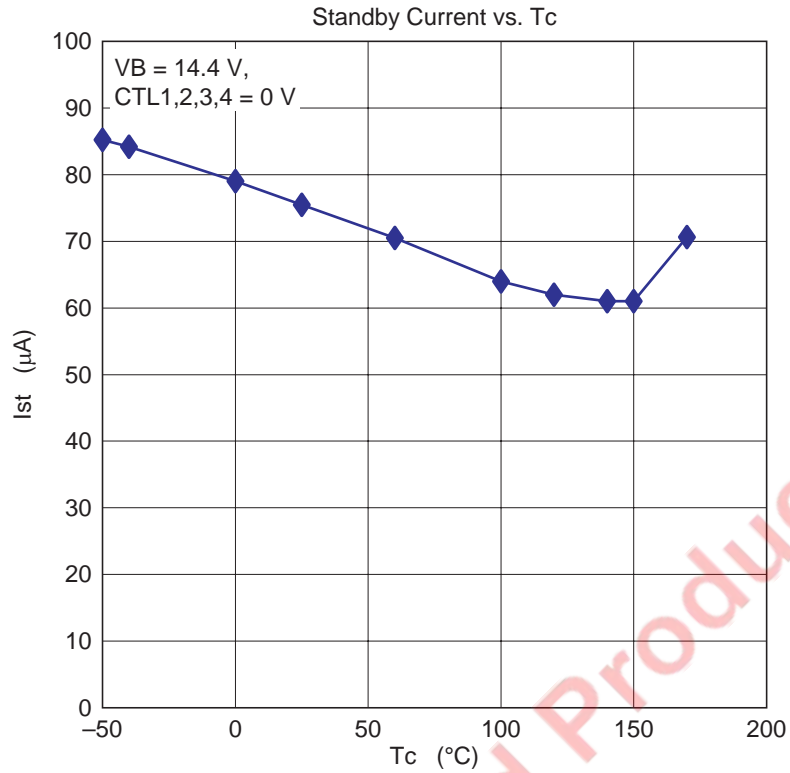

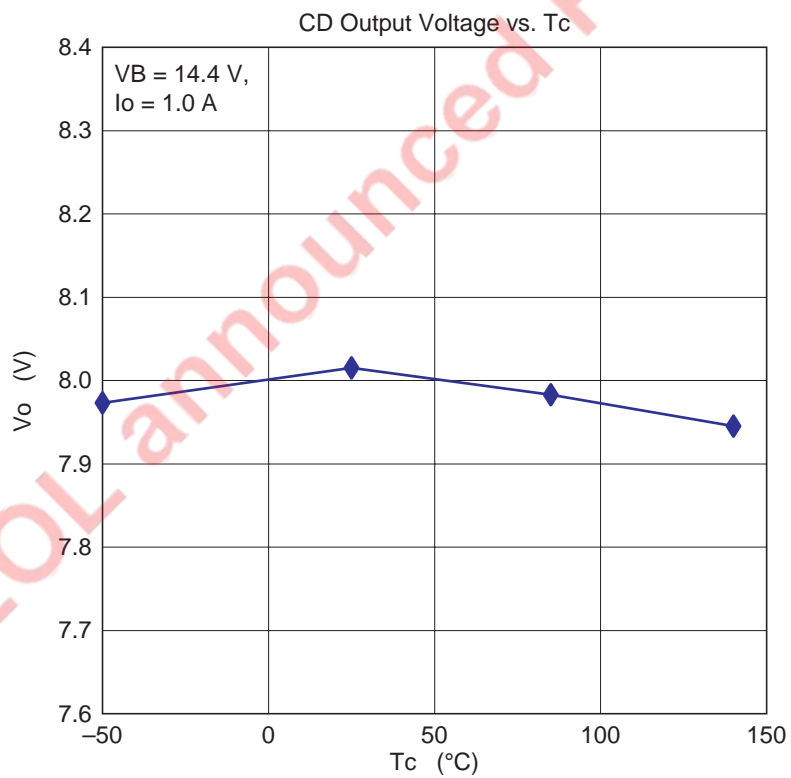
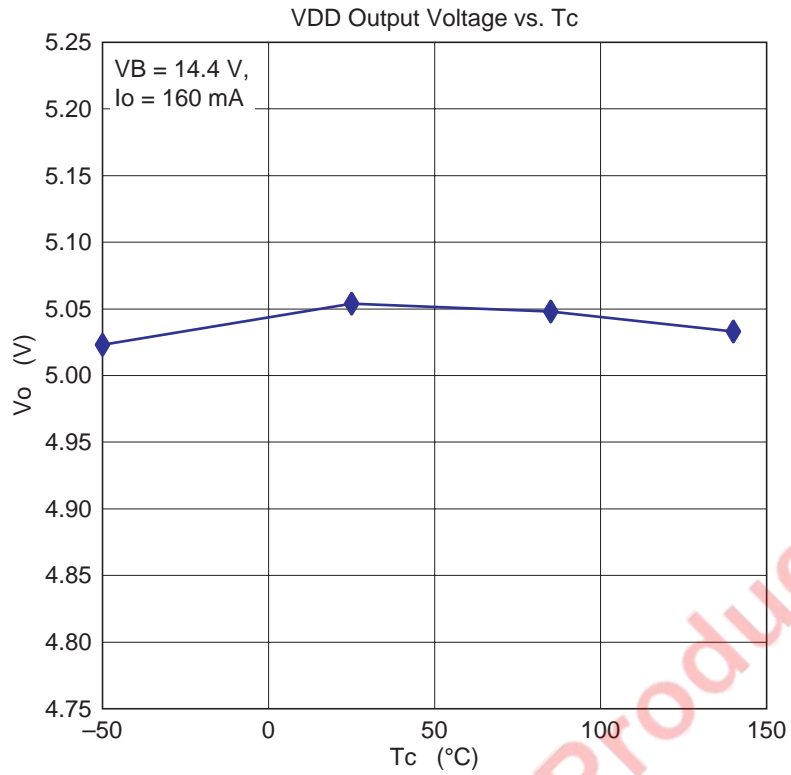

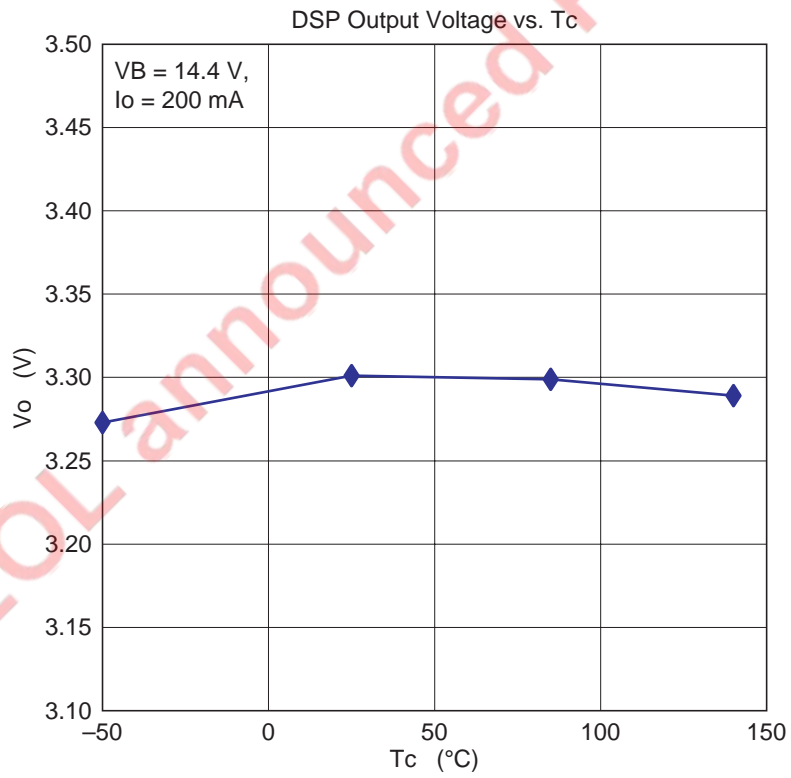
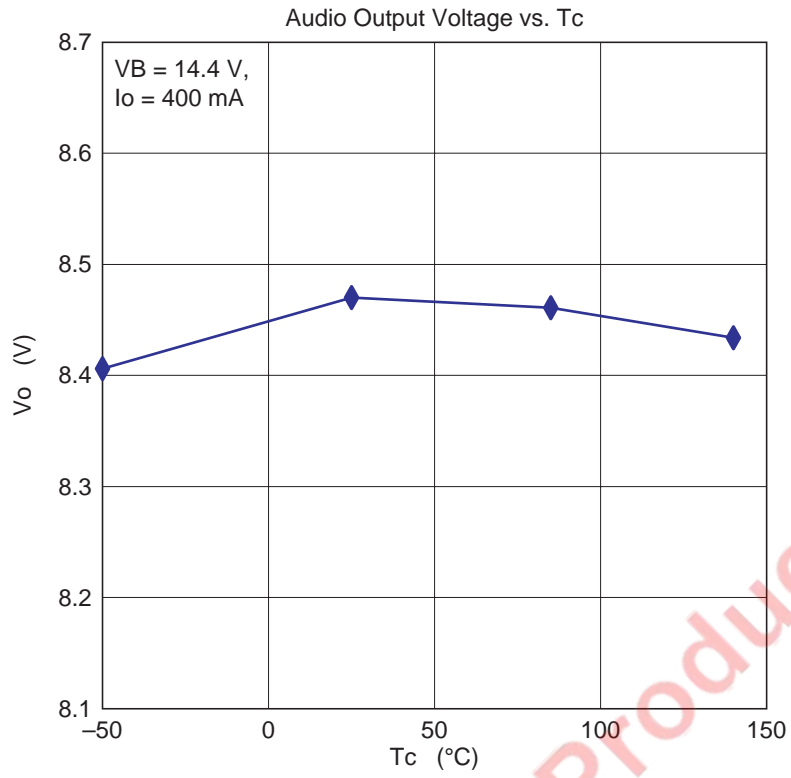

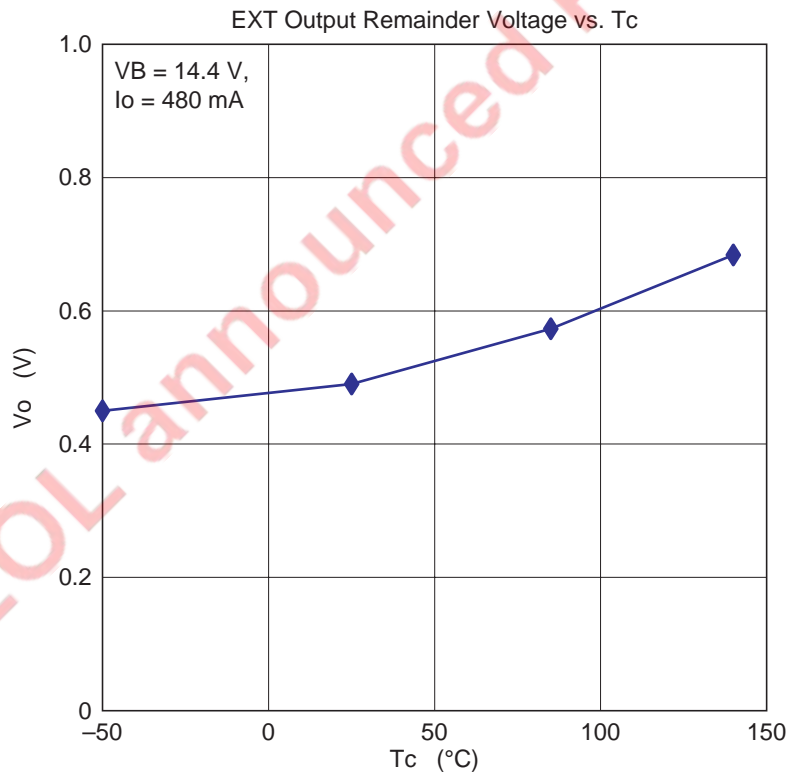
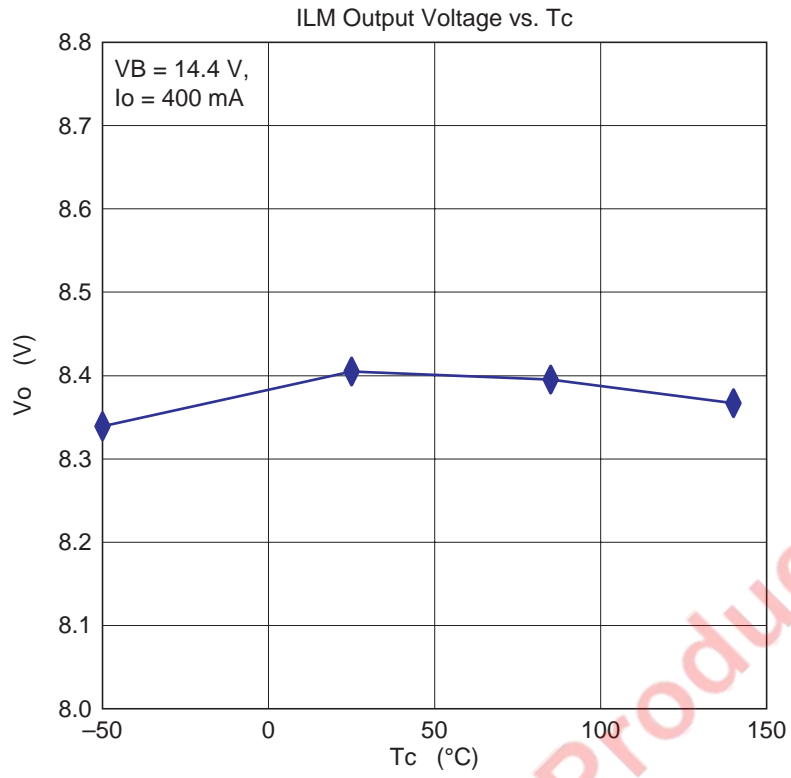

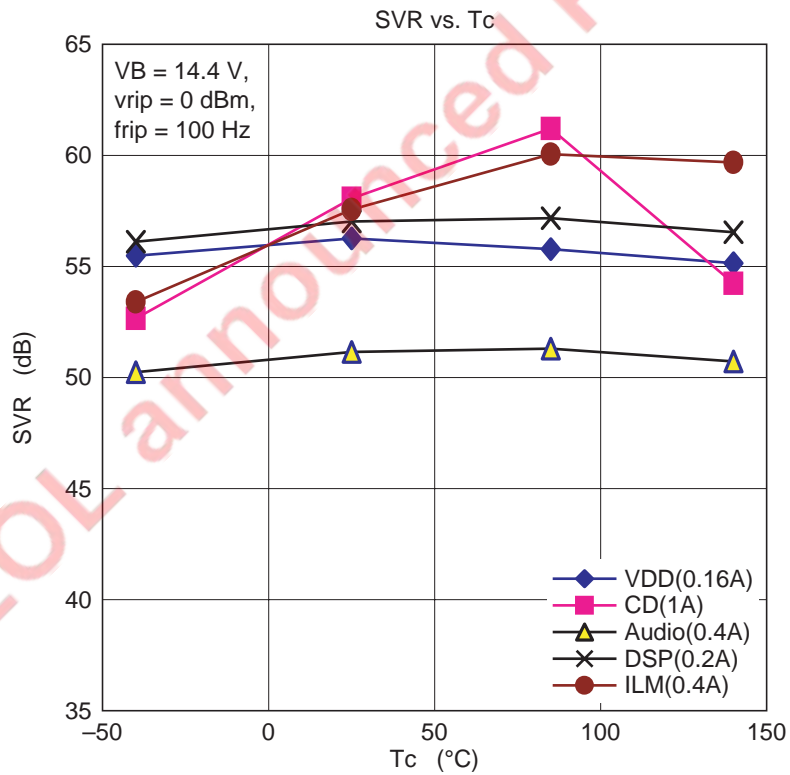
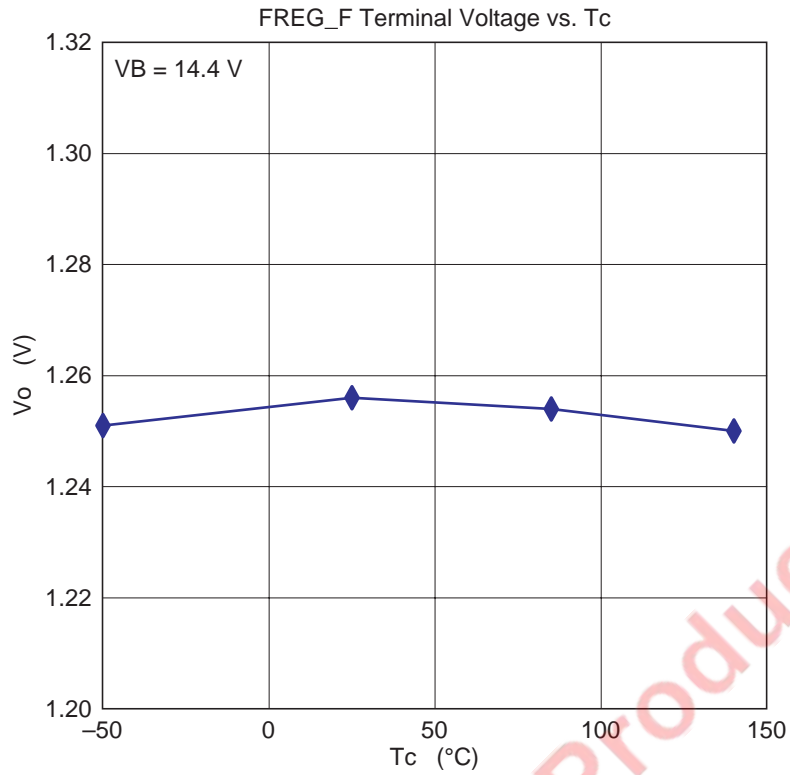



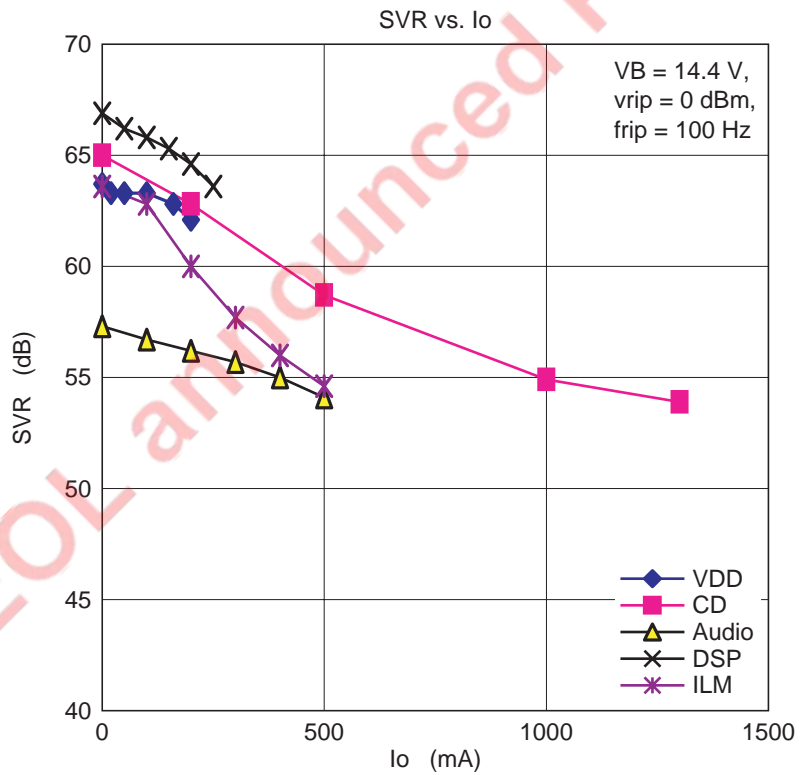
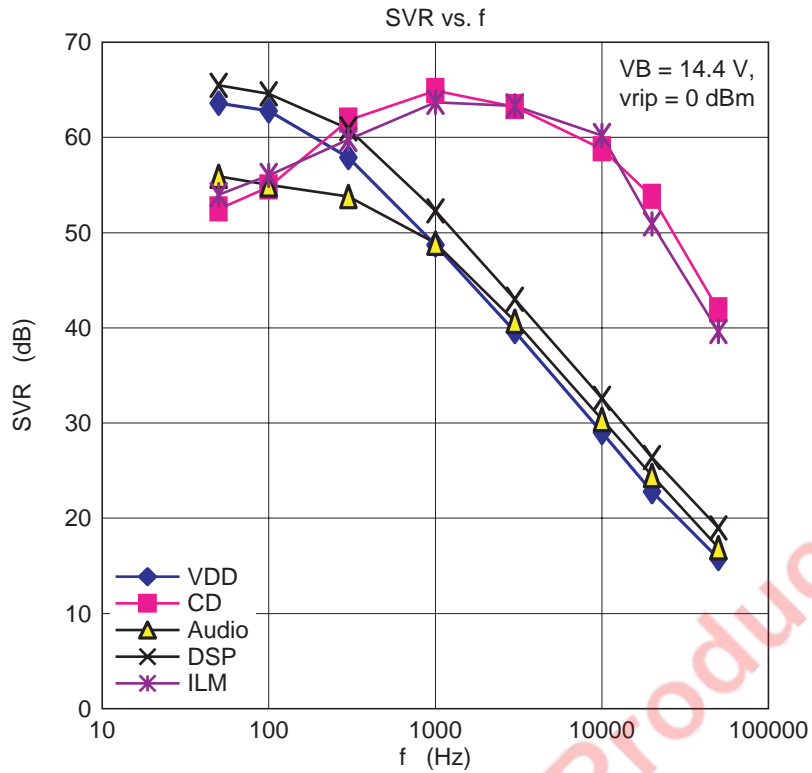

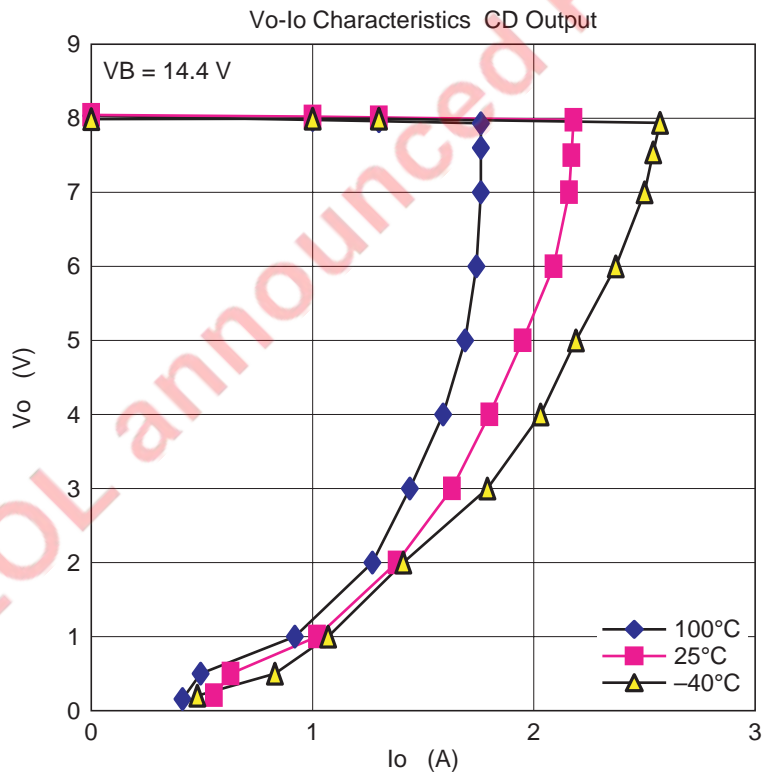
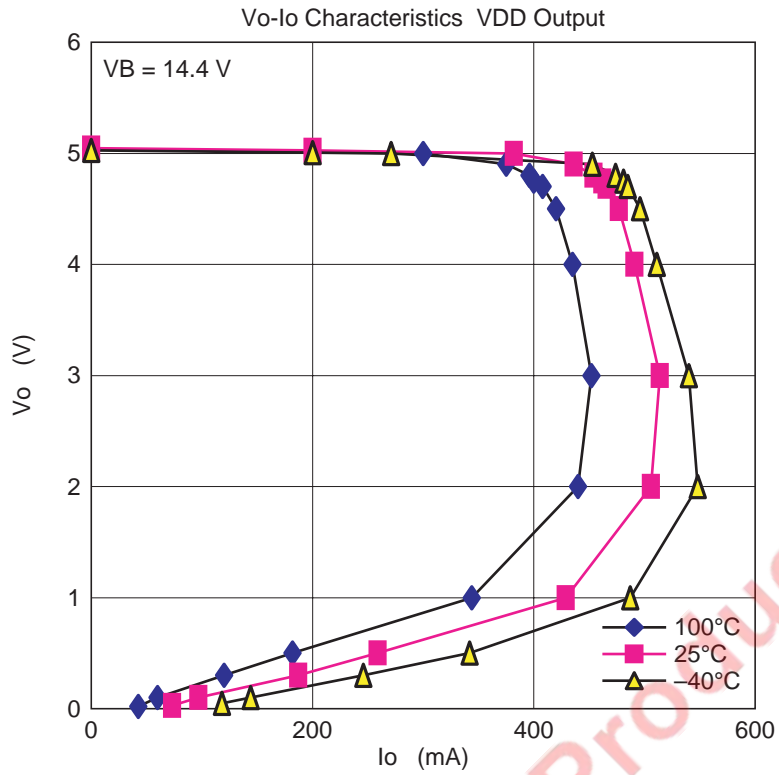

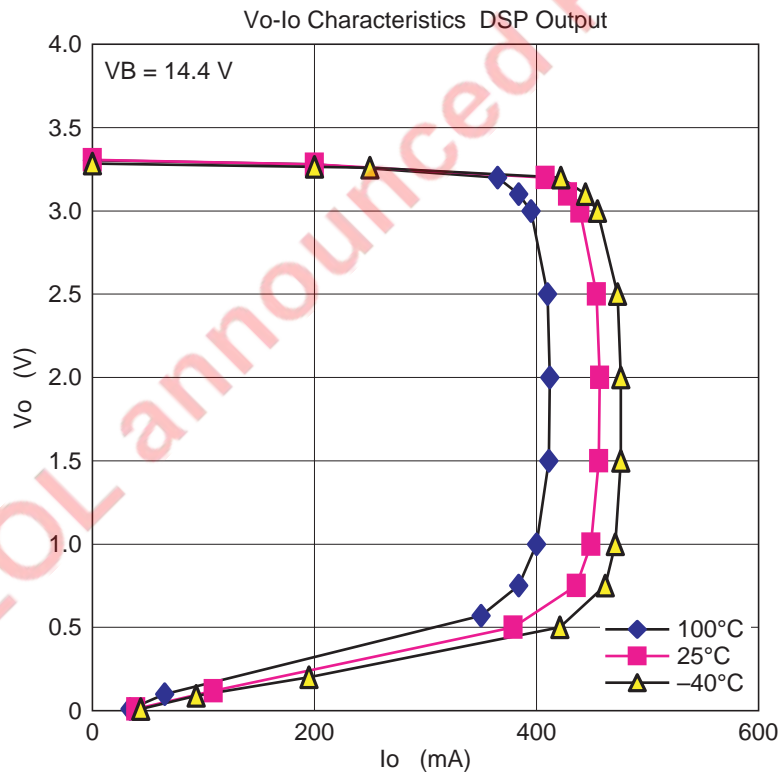
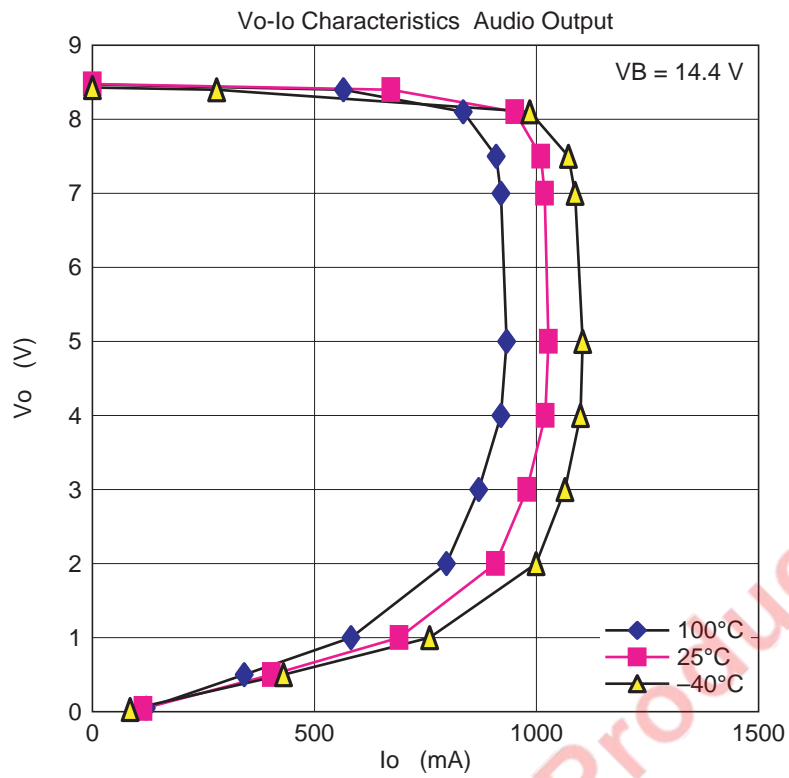

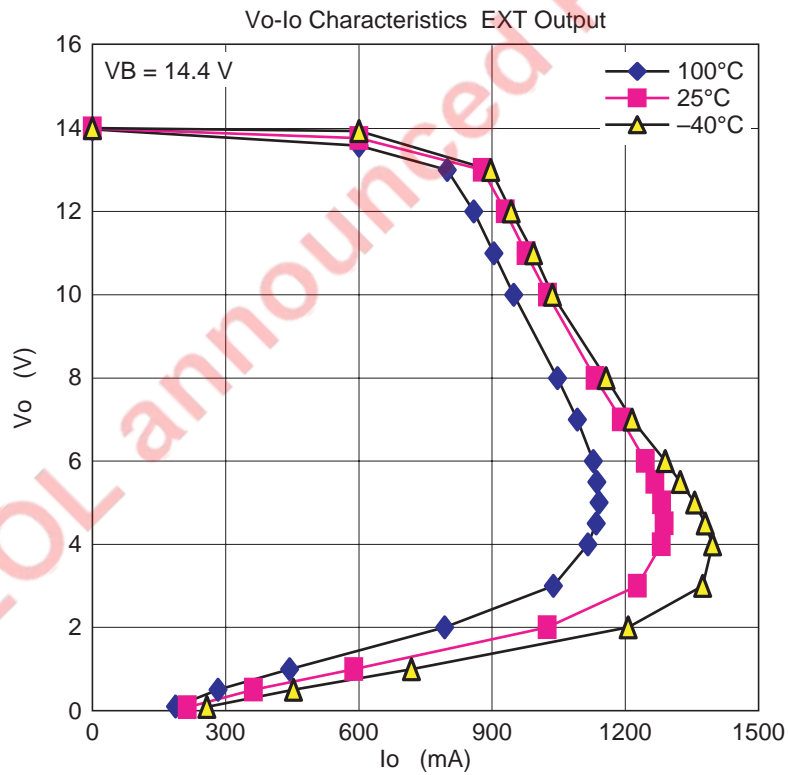
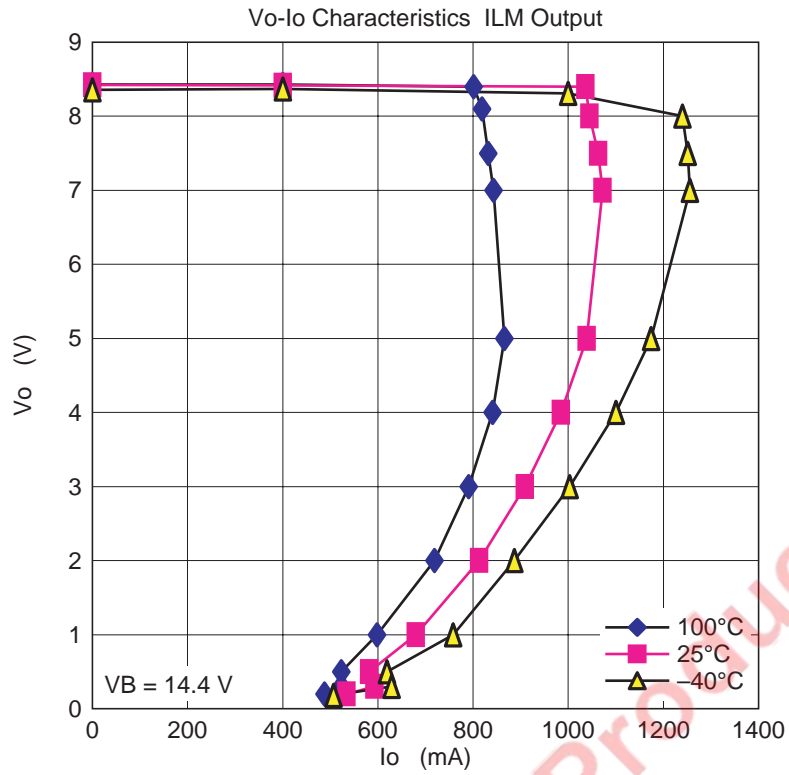

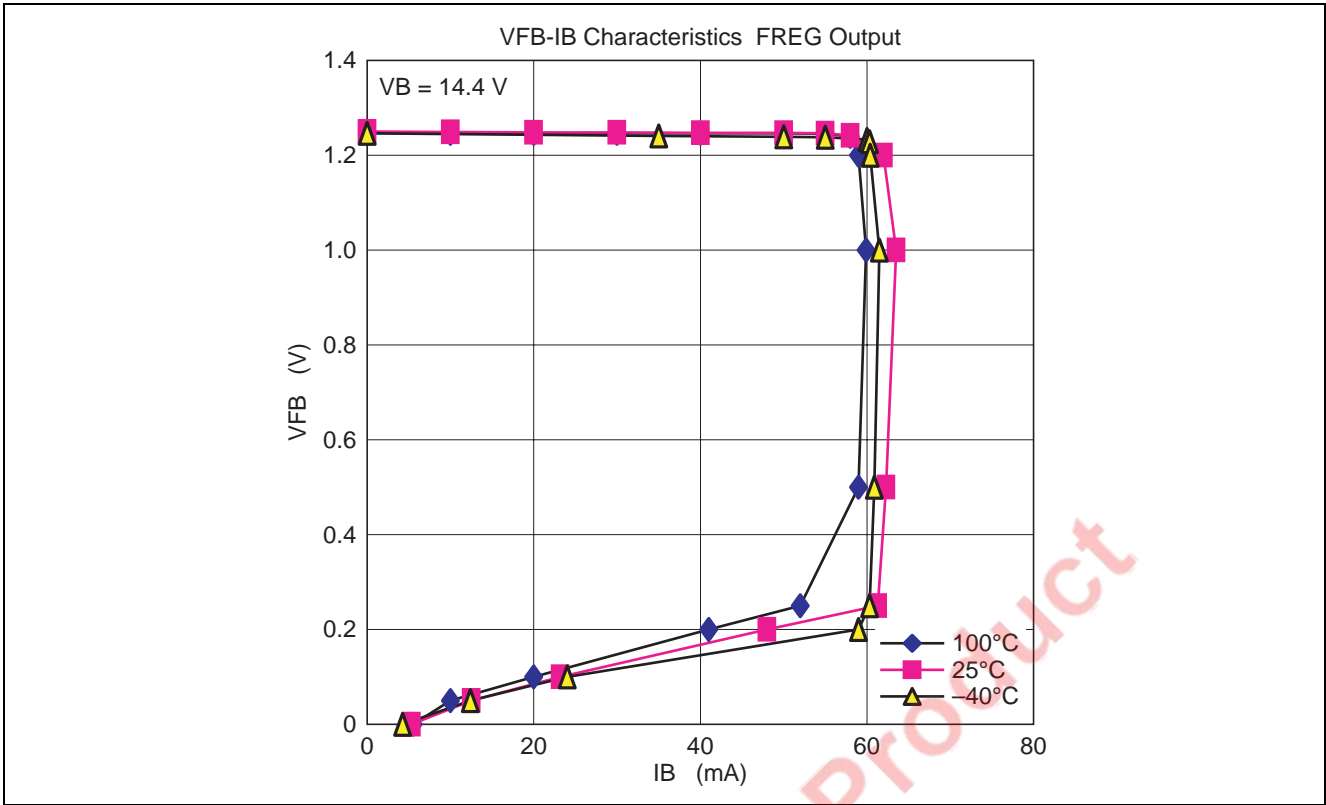

EOL announced Product

## Handling Cautions (SP-15TGV Package)

### Mounting

1. For mounting the package on the heat sink, 4 to 8 kg-cm of screwing-torque is recommended; excessive torque will cause device deformation, resulting in pellet-crack, connector-lead-wire-breaking, etc., and too less torque will increase the heat resistance.
2. The use of screws needs the following cautions.
  - 1) Use the standardized binding-head screws.
  - 2) Oval counter-sunk screws, subjecting the IC to intense stress, must not be used.
  - 3) To the use of tapping screws the cautions for binding torque strength must be applied.
  - 4) Use a tapping screw diameter smaller than an IC mounting-hole.

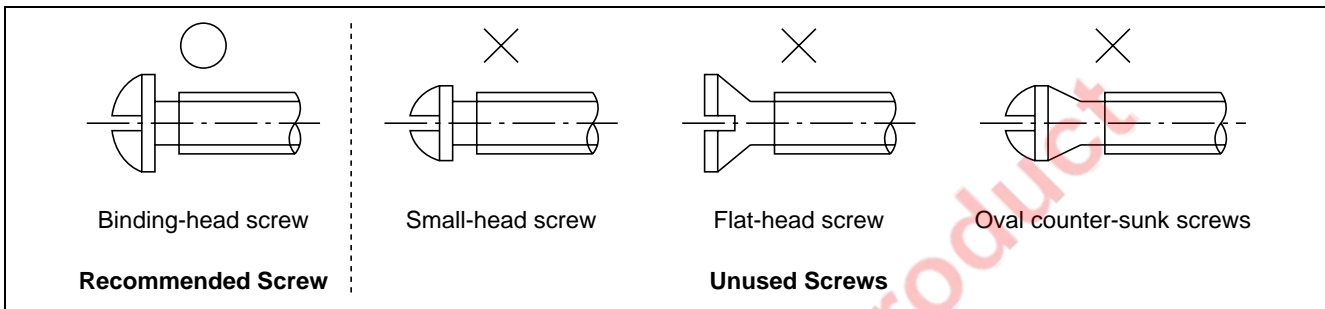

3. In IC binding, metal-fittings striking on the plastic of the IC may cause characteristics-deterioration or package-crack.
4. Poor flatness of heat sink sometimes prevents effective heat-sinking or subjects the IC surface to intense stress, causing characteristics-deterioration or package-crack.
  - 1) 0.1 mm max. of heat-sink flatness error for the contact area (14.3 mm × 19.66 mm) will be tolerated.
  - 2) Contact-surface ruggedness should be finished in ∇∇ grade.
  - 3) For aluminum, copper, or iron plates, check them for no burr and mold them for screw-holes.
  - 4) Cutting chips between the IC header and the heat sink will cause heat-sinking deterioration.
  - 5) The heat-sink hole diameter should not exceed 4.0 mm.
5. As silicone grease, the Shin-Etsu Chemical Industry G746 is recommended. Coarse or an excessive amount of grease may cause intensive stress to the IC, when binding.
6. Do not Screw the IC on the heat sink after soldering the lead wires on the printed circuit board (PCB). If the IC is screwed after the lead wires are soldered on the PCB then characteristics of the IC may deteriorate in the cause of large strain concentrate to the lead wires because of dimension-difference of the PCB and the heat sink.
7. Do not solder of lead wires to the header of the IC on direct. If you solder direct then the IC life characteristics will deteriorate remarkably with bad-influence on the die.  
For the method and conditions of lead-wire forming, users are requested to contact the vendor.

8. Header of IC (TAB) have to connect to GND.

For mounting the header of IC on the heat sink with the screw, heat sink have to connect to GND. When header of IC mount with heat sink with holding parishes conductive material, holding parts have to connect to GND. At this time, the holding parts mount with heat sink with the screw, or it must connect to header of IC. If users have question or request, please contact the vendor.

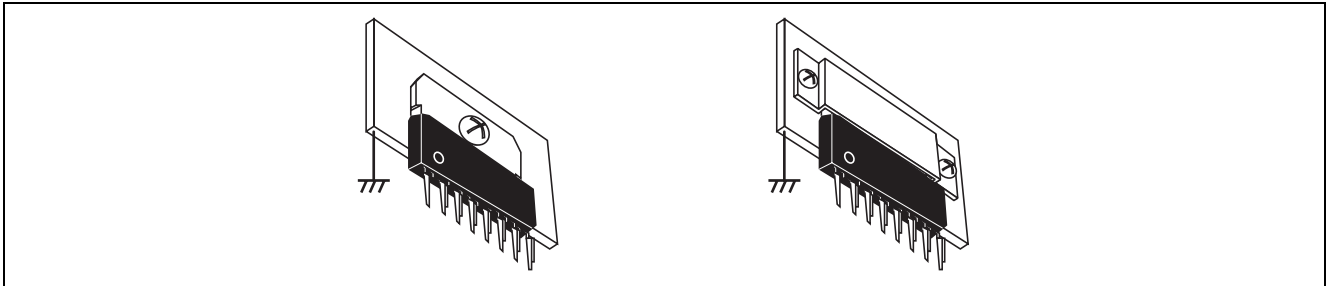

Example of Recommendation about the Method of Connecting Header of IC to GND

**Bad example**

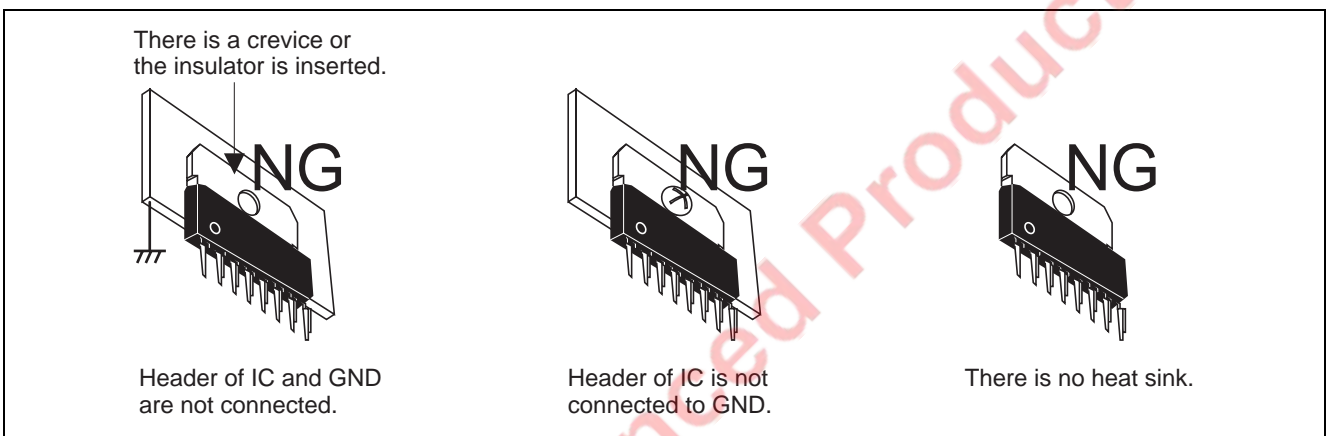

9. Soldering should be done within the soldering heat test standard of the IC, specifying that the lead wires, up to 1 to 1.5 mm off the IC body, are kept in solder at 260°C for 10 seconds (2 or less times) and at 350°C for 3 seconds. Therefore give careful consideration in order to do not exceed the condition. In a soldering iron is used, use a soldering iron grounded and do not leak at the tip.

**Characteristics**

1. When there may be the mode which VB, VBUP or GND, and each output reverse with a normal potential state in application, it recommends attaching a diode for IC protection. When outputting the terminal of IC to the direct set exterior, a diode is required in order to protect IC from incorrect contact on a battery and a GND line. Especially EXTOUT is required.
2. In the parts shown in external part lineup, the value of a capacitor is the minimum value required in order to secure the oscillation stability of IC. Please use the capacitor independent of temperature and bias. Moreover, please use the capacitor whose ESR is 10 Ω or less in the operating temperature range.

## Protections

### 1. Overvoltage protection circuit

The overvoltage protection circuit (surge protector) turns off all outputs without Vdd, when VB voltage is more than about 21 V.

And the overvoltage protection circuit (surge protector) turns off Vdd output with other all outputs, when VB voltage is more than about 26 V.

The  $V_B \geq 18$  V condition, the stand by current increases.

### 2. Overcurrent protection circuit

FREG\_B (pin 2), ILM OUT (pin 4), CD OUT (pin 6), DSP OUT (pin 7), AUDIO OUT (pin 10), EXT OUT (pin 12), VDD OUT (pin 14) output circuits are built-in overcurrent protection circuit, based on the respective output current.

### 3. Thermal protection circuit

A built-in thermal protection circuit (TSD: Thermal Shut Down) prevents thermal damage to the IC.

All outputs except VDD (pin 14) and FREG (pin 2, 3) are switched off when the circuit operates, revert to the original state when the temperature drops to a certain level.

### 4. FREG operation

FREG function needs external PNP transistor, feedback resistor, stability capacitor. If the external transistor become saturation level, the base current depend on IC specification, that is FREG\_B (pin 2) maximum current specification.

### 5. We recommend to mount a bypass diode in your application if there is a mode where potential difference between each output and VB (pin 8), VBUP (pin 15) or GND (pin 1) is reversed from the normal state.

### 6. **Header of IC (TAB) have to connect to GND.**

For mounting the header of IC on the heat sink with the screw, heat sink have to connect to GND. When header of IC mount with heat sink with holding parts (use conductive material), holding parts have to connect to GND.

At this time, the holding parts mount with heat sink with the screw, or it must connect to header of IC.

If users have question or request, please contact the vendor.

### 7. Soldering should be done within the soldering heat test standard of the IC, specifying that the lead wires, up to 1 to 1.5 mm off the IC body, are kept in solder at 260°C for 10 s and at 350°C for 3 s. Therefore give careful consideration in order to do not exceed the condition. In a soldering iron is used, use a soldering iron grounded and do not leak at the tip.

### 8. To keep stability regulation

The stability capacitor should be no temperature dependability and no bias voltage dependability.

ESR level should be bellow 10 W all temperature range.



Package Dimensions

JEITA Package Code	RENESAS Code	Previous Code	MASS[Typ.]
P-HSIP15-14.3x19.66-1.27	PRSS0015DA-C	SP-15TGV	3.0g

Unit : mm

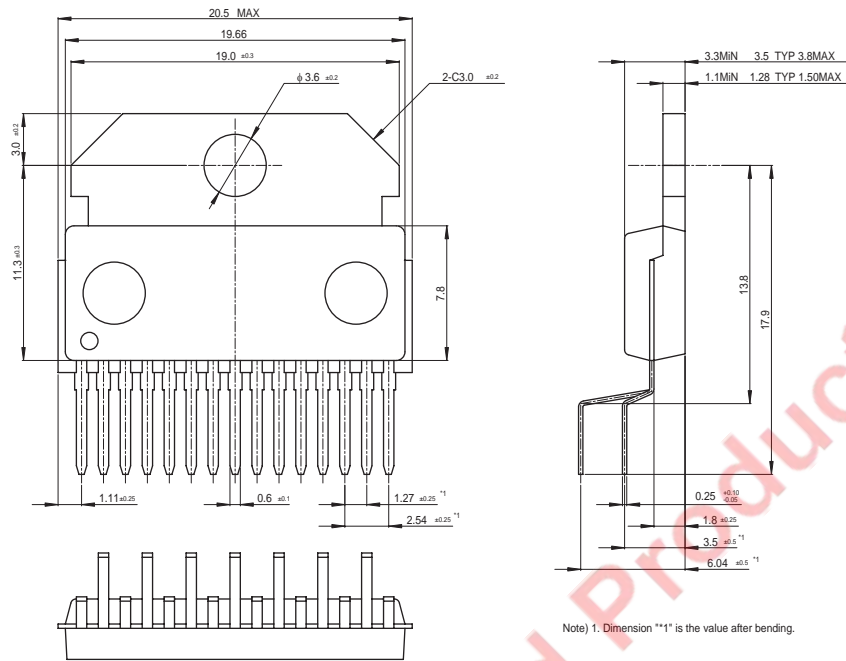

EOL announced Product

Notes:

1. This document is provided for reference purposes only so that Renesas customers may select the appropriate Renesas products for their use. Renesas neither makes warranties or representations with respect to the accuracy or completeness of the information contained in this document nor grants any license to any intellectual property rights or any other rights of Renesas or any third party with respect to the information in this document.
2. Renesas shall have no liability for damages or infringement of any intellectual property or other rights arising out of the use of any information in this document, including, but not limited to, product data, diagrams, charts, programs, algorithms, and application circuit examples.
3. You should not use the products or the technology described in this document for the purpose of military applications such as the development of weapons of mass destruction or for the purpose of any other military use. When exporting the products or technology described herein, you should follow the applicable export control laws and regulations, and procedures required by such laws and regulations.
4. All information included in this document such as product data, diagrams, charts, programs, algorithms, and application circuit examples, is current as of the date this document is issued. Such information, however, is subject to change without any prior notice. Before purchasing or using any Renesas products listed in this document, please confirm the latest product information with a Renesas sales office. Also, please pay regular and careful attention to additional and different information to be disclosed by Renesas such as that disclosed through our website. (<http://www.renesas.com>)
5. Renesas has used reasonable care in compiling the information included in this document, but Renesas assumes no liability whatsoever for any damages incurred as a result of errors or omissions in the information included in this document.
6. When using or otherwise relying on the information in this document, you should evaluate the information in light of the total system before deciding about the applicability of such information to the intended application. Renesas makes no representations, warranties or guaranties regarding the suitability of its products for any particular application and specifically disclaims any liability arising out of the application and use of the information in this document or Renesas products.
7. With the exception of products specified by Renesas as suitable for automobile applications, Renesas products are not designed, manufactured or tested for applications or otherwise in systems the failure or malfunction of which may cause a direct threat to human life or create a risk of human injury or which require especially high quality and reliability such as safety systems, or equipment or systems for transportation and traffic, healthcare, combustion control, aerospace and aeronautics, nuclear power, or undersea communication transmission. If you are considering the use of our products for such purposes, please contact a Renesas sales office beforehand. Renesas shall have no liability for damages arising out of the uses set forth above.
8. Notwithstanding the preceding paragraph, you should not use Renesas products for the purposes listed below:
  - (1) artificial life support devices or systems
  - (2) surgical implantations
  - (3) healthcare intervention (e.g., excision, administration of medication, etc.)
  - (4) any other purposes that pose a direct threat to human lifeRenesas shall have no liability for damages arising out of the uses set forth in the above and purchasers who elect to use Renesas products in any of the foregoing applications shall indemnify and hold harmless Renesas Technology Corp., its affiliated companies and their officers, directors, and employees against any and all damages arising out of such applications.
9. You should use the products described herein within the range specified by Renesas, especially with respect to the maximum rating, operating supply voltage range, movement power voltage range, heat radiation characteristics, installation and other product characteristics. Renesas shall have no liability for malfunctions or damages arising out of the use of Renesas products beyond such specified ranges.
10. Although Renesas endeavors to improve the quality and reliability of its products, IC products have specific characteristics such as the occurrence of failure at a certain rate and malfunctions under certain use conditions. Please be sure to implement safety measures to guard against the possibility of physical injury, and injury or damage caused by fire in the event of the failure of a Renesas product, such as safety design for hardware and software including but not limited to redundancy, fire control and malfunction prevention, appropriate treatment for aging degradation or any other applicable measures. Among others, since the evaluation of microcomputer software alone is very difficult, please evaluate the safety of the final products or system manufactured by you.
11. In case Renesas products listed in this document are detached from the products to which the Renesas products are attached or affixed, the risk of accident such as swallowing by infants and small children is very high. You should implement safety measures so that Renesas products may not be easily detached from your products. Renesas shall have no liability for damages arising out of such detachment.
12. This document may not be reproduced or duplicated, in any form, in whole or in part, without prior written approval from Renesas.
13. Please contact a Renesas sales office if you have any questions regarding the information contained in this document, Renesas semiconductor products, or if you have any other inquiries.



**RENESAS SALES OFFICES**

<http://www.renesas.com>

Refer to "<http://www.renesas.com/en/network>" for the latest and detailed information.

**Renesas Technology America, Inc.**

450 Holger Way, San Jose, CA 95134-1368, U.S.A  
Tel: <1> (408) 382-7500, Fax: <1> (408) 382-7501

**Renesas Technology Europe Limited**

Dukes Meadow, Millboard Road, Bourne End, Buckinghamshire, SL8 5FH, U.K.  
Tel: <44> (1628) 585-100, Fax: <44> (1628) 585-900

**Renesas Technology (Shanghai) Co., Ltd.**

Unit 204, 205, AZIACenter, No.1233 Lujiazui Ring Rd, Pudong District, Shanghai, China 200120  
Tel: <86> (21) 5877-1818, Fax: <86> (21) 6887-7898

**Renesas Technology Hong Kong Ltd.**

7th Floor, North Tower, World Finance Centre, Harbour City, 1 Canton Road, Tsimshatsui, Kowloon, Hong Kong  
Tel: <852> 2265-6688, Fax: <852> 2730-6071

**Renesas Technology Taiwan Co., Ltd.**

10th Floor, No.99, Fushing North Road, Taipei, Taiwan  
Tel: <886> (2) 2715-2888, Fax: <886> (2) 2713-2999

**Renesas Technology Singapore Pte. Ltd.**

1 Harbour Front Avenue, #06-10, Keppel Bay Tower, Singapore 098632  
Tel: <65> 6213-0200, Fax: <65> 6278-8001

**Renesas Technology Korea Co., Ltd.**

Kukje Center Bldg. 18th Fl., 191, 2-ka, Hangang-ro, Yongsan-ku, Seoul 140-702, Korea  
Tel: <82> (2) 796-3115, Fax: <82> (2) 796-2145

**Renesas Technology Malaysia Sdn. Bhd**

Unit 906, Block B, Menara Amcorp, Amcorp Trade Centre, No.18, Jalan Persiaran Barat, 46050 Petaling Jaya, Selangor Darul Ehsan, Malaysia  
Tel: <603> 7955-9390, Fax: <603> 7955-9510