

To our customers,

Old Company Name in Catalogs and Other Documents

On April 1st, 2010, NEC Electronics Corporation merged with Renesas Technology Corporation, and Renesas Electronics Corporation took over all the business of both companies. Therefore, although the old company name remains in this document, it is a valid Renesas Electronics document. We appreciate your understanding.

Renesas Electronics website: <http://www.renesas.com>

April 1st, 2010
Renesas Electronics Corporation

Issued by: Renesas Electronics Corporation (<http://www.renesas.com>)

Send any inquiries to <http://www.renesas.com/inquiry>.

Notice

1. All information included in this document is current as of the date this document is issued. Such information, however, is subject to change without any prior notice. Before purchasing or using any Renesas Electronics products listed herein, please confirm the latest product information with a Renesas Electronics sales office. Also, please pay regular and careful attention to additional and different information to be disclosed by Renesas Electronics such as that disclosed through our website.
2. Renesas Electronics does not assume any liability for infringement of patents, copyrights, or other intellectual property rights of third parties by or arising from the use of Renesas Electronics products or technical information described in this document. No license, express, implied or otherwise, is granted hereby under any patents, copyrights or other intellectual property rights of Renesas Electronics or others.
3. You should not alter, modify, copy, or otherwise misappropriate any Renesas Electronics product, whether in whole or in part.
4. Descriptions of circuits, software and other related information in this document are provided only to illustrate the operation of semiconductor products and application examples. You are fully responsible for the incorporation of these circuits, software, and information in the design of your equipment. Renesas Electronics assumes no responsibility for any losses incurred by you or third parties arising from the use of these circuits, software, or information.
5. When exporting the products or technology described in this document, you should comply with the applicable export control laws and regulations and follow the procedures required by such laws and regulations. You should not use Renesas Electronics products or the technology described in this document for any purpose relating to military applications or use by the military, including but not limited to the development of weapons of mass destruction. Renesas Electronics products and technology may not be used for or incorporated into any products or systems whose manufacture, use, or sale is prohibited under any applicable domestic or foreign laws or regulations.
6. Renesas Electronics has used reasonable care in preparing the information included in this document, but Renesas Electronics does not warrant that such information is error free. Renesas Electronics assumes no liability whatsoever for any damages incurred by you resulting from errors in or omissions from the information included herein.
7. Renesas Electronics products are classified according to the following three quality grades: “Standard”, “High Quality”, and “Specific”. The recommended applications for each Renesas Electronics product depends on the product’s quality grade, as indicated below. You must check the quality grade of each Renesas Electronics product before using it in a particular application. You may not use any Renesas Electronics product for any application categorized as “Specific” without the prior written consent of Renesas Electronics. Further, you may not use any Renesas Electronics product for any application for which it is not intended without the prior written consent of Renesas Electronics. Renesas Electronics shall not be in any way liable for any damages or losses incurred by you or third parties arising from the use of any Renesas Electronics product for an application categorized as “Specific” or for which the product is not intended where you have failed to obtain the prior written consent of Renesas Electronics. The quality grade of each Renesas Electronics product is “Standard” unless otherwise expressly specified in a Renesas Electronics data sheets or data books, etc.
 - “Standard”: Computers; office equipment; communications equipment; test and measurement equipment; audio and visual equipment; home electronic appliances; machine tools; personal electronic equipment; and industrial robots.
 - “High Quality”: Transportation equipment (automobiles, trains, ships, etc.); traffic control systems; anti-disaster systems; anti-crime systems; safety equipment; and medical equipment not specifically designed for life support.
 - “Specific”: Aircraft; aerospace equipment; submersible repeaters; nuclear reactor control systems; medical equipment or systems for life support (e.g. artificial life support devices or systems), surgical implantations, or healthcare intervention (e.g. excision, etc.), and any other applications or purposes that pose a direct threat to human life.
8. You should use the Renesas Electronics products described in this document within the range specified by Renesas Electronics, especially with respect to the maximum rating, operating supply voltage range, movement power voltage range, heat radiation characteristics, installation and other product characteristics. Renesas Electronics shall have no liability for malfunctions or damages arising out of the use of Renesas Electronics products beyond such specified ranges.
9. Although Renesas Electronics endeavors to improve the quality and reliability of its products, semiconductor products have specific characteristics such as the occurrence of failure at a certain rate and malfunctions under certain use conditions. Further, Renesas Electronics products are not subject to radiation resistance design. Please be sure to implement safety measures to guard them against the possibility of physical injury, and injury or damage caused by fire in the event of the failure of a Renesas Electronics product, such as safety design for hardware and software including but not limited to redundancy, fire control and malfunction prevention, appropriate treatment for aging degradation or any other appropriate measures. Because the evaluation of microcomputer software alone is very difficult, please evaluate the safety of the final products or system manufactured by you.
10. Please contact a Renesas Electronics sales office for details as to environmental matters such as the environmental compatibility of each Renesas Electronics product. Please use Renesas Electronics products in compliance with all applicable laws and regulations that regulate the inclusion or use of controlled substances, including without limitation, the EU RoHS Directive. Renesas Electronics assumes no liability for damages or losses occurring as a result of your noncompliance with applicable laws and regulations.
11. This document may not be reproduced or duplicated, in any form, in whole or in part, without prior written consent of Renesas Electronics.
12. Please contact a Renesas Electronics sales office if you have any questions regarding the information contained in this document or Renesas Electronics products, or if you have any other inquiries.

(Note 1) “Renesas Electronics” as used in this document means Renesas Electronics Corporation and also includes its majority-owned subsidiaries.

(Note 2) “Renesas Electronics product(s)” means any product developed or manufactured by or for Renesas Electronics.

HA12226F/HA12227F

Audio Signal Processor for Cassette Deck (Dolby B-type NR with Recording System)

REJ03F0133-0600
Previous: ADE-207-270E
Rev.6.00
Jun 15, 2005

Description

The HA12226F/HA12227F are silicon monolithic bipolar IC providing Dolby noise reduction system*¹, music sensor system, REC equalizer system and each electronic control switch in one chip.

Note: 1. Dolby is a trademark of Dolby Laboratories Licensing Corporation.
A license from Dolby Laboratories Licensing Corporation is required for the use of this IC.
The HA12227F is not built-in Dolby B-NR.

Functions

- Dolby B-NR*² × 2 channel
- REC equalizer × 2 channel
- Music sensor × 1 channel
- Pass amp. × 2 channel
- Each electronic control switch to change REC equalizer, bias, etc.

Note: 2. The HA12227F is not built-in Dolby B-NR.

Features

- REC equalizer is very small number of external parts and have 4 types of frequency characteristics built-in.
- 2 types of input for PB, 1 type of input for REC.
- 70μ - PB equalizer changing system built-in.
- Dolby NR*² with dubbing double cassette decks.
Unprocessed signal output available from recording out terminals during PB mode.
- Provide stable music sensor system, available to design music sensing time and level.
- Controllable from direct micro-computer output.
- Bias oscillator control switch built-in.
- NR ON / OFF and REC / PB fully electronic control switching built-in.
- Normal-speed / high-speed, Normal / Crom and PB equalizer fully electronic control switching built-in.
- Available to reduce substrate-area because of high integration and small external parts.

Ordering Information

Operating Voltage

Product	Power Supply Range (Single Supply)
HA12226F	11.0 V to 15.0 V
HA12227F	9.5 V to 15.0 V

Standard Level

Product	Package Code	PB-OUT Level	REC-OUT Level	Dolby Level
HA12226F	FP-56A	580 mVrms	300 mVrms	300 mVrms
HA12227F				—

Function

Product	Dolby B-NR	REC-EQ	Music Sensor	Pass Amp.	REC / PB Selection	ALC
HA12226F	○	○	○	○	○	○
HA12227F	×	○	○	○	○	○

Note: Depending on the employed REC / PB head and test tape characteristics, there is a rare case that the REC-EQ characteristics of this LSI can not be matched to the required characteristics because of built-in resistors which determined the REC-EQ parameters in this case, please inquire the responsible agent because the adjustment built-in resistor is necessary.

Difference of HA12215F and HA12226F/HA12227F

Product	Supply Voltage	Tape Correspondence		
		NORM	CROM	METAL
HA12226F/HA12227F	Single supply voltage	○	○	×
HA12215F	Split supply voltage	○	○	○

Note: The HA12226F/HA12227F became single power supply for the HA12215F and deleted metal correspondence.
The HA12227F is not built-in Dolby B-NR.
Other characteristic aspects are similar as the HA12215F.

Pin Description, Equivalent Circuit

($V_{CC} = 12\text{ V}$, A system of single supply voltage, $T_a = 25^\circ\text{C}$, No Signal, The value in the show typical value.)

Pin No.	Terminal Name	Note	Equivalent Circuit	Pin Description
51	AIN (R)	$V = V_{CC} / 2$		PB A Deck input
48	AIN (L)			PB B Deck input
53	BIN (R)			REC input
46	BIN (L)			REC equalizer input
56	RIN (R)			
43	RIN (L)			
5	EQIN (R)			
38	EQIN (L)			
1 * ²	DET (R)	$V = 2.7\text{ V}$		Time constant pin for Dolby-NR
42 * ²	DET (L)			Ripple filter
49	RIP			
2 * ³	BIAS1	$V = 0.6\text{ V}$		Dolby bias current input
41	BIAS2			REC equalizer bias current input

Pin Description, Equivalent Circuit (cont.)

($V_{CC} = 12\text{ V}$, A system of single supply voltage, $T_a = 25^\circ\text{C}$, No Signal, The value in the show typical value.)

Pin No.	Terminal Name	Note	Equivalent Circuit	Pin Description
3	PBOUT (R)	$V = V_{CC} / 2$		PB output
40	PBOUT (L)			REC output
4	RECOUT (R)			REC equalizer output
39	RECOUT (L)			MS Amp. output *1
7	EQOUT (R)			Input Amp. output
36	EQOUT (L)			
28	MAOUT			
8	ROUT (R)			
35	ROUT (L)			
52	ABO (R)	$R1 = 15\text{ k}$ $R2 = 12\text{ k}$ $V = V_{CC} / 2$		Time constant pin for PB equalizer (70μ)
47	ABO (L)			
6	BOOST (R)	$R1 = 4.8\text{ k}$ $R2 = 4.8\text{ k}$ $V = V_{CC} / 2$		Time constant pin for low boost
37	BOOST (L)			
32	BIAS (C)	$V = V_{CC} - 0.7\text{ V}$		REC bias current output
33	BIAS (N)			
21	V_{CC}	$V = V_{CC}$		Power supply
50	GND	$V = 0\text{ V}$		GND pin
31, 45, 54	NC	No connection		No connection

Pin Description, Equivalent Circuit (cont.)

($V_{CC} = 12\text{ V}$, A system of single supply voltage, $T_a = 25^\circ\text{C}$, No Signal, The value in the show typical value.)

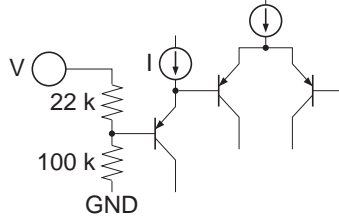
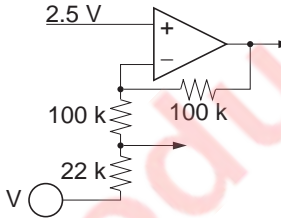
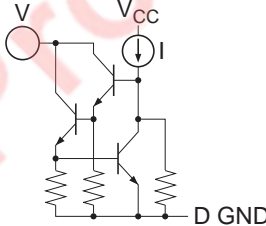
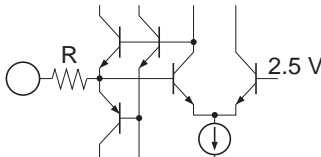
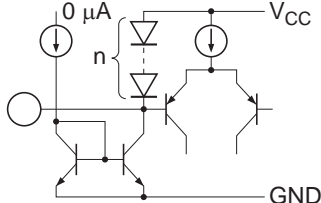
Pin No.	Terminal Name	Note	Equivalent Circuit	Pin Description
15	ALC $\overline{\text{ON/OFF}}$	$I = 20\ \mu\text{A}$		Mode control input
16	PB $\overline{\text{A/B}}$			
17	A $\overline{120/70}$			
18	$\overline{\text{NORM/HIGH}}$			
19	B $\overline{\text{NORM/CROM}}$			
20	BIAS $\overline{\text{ON/OFF}}$			
22	RM $\overline{\text{ON/OFF}}$			
23 *2	NR $\overline{\text{ON/OFF}}$			
25	LM $\overline{\text{ON/OFF}}$			
24	REC/PB/PASS			Mode control input
26	MSOUT	$I = 0\ \mu\text{A}$		MS output (to MPU) *1
10	GPCAL	$R = 110\ \text{k}\Omega$		GP gain calibration terminal
11	RECCAL	$R = 110\ \text{k}\Omega$		REC gain calibration terminal
12	ALCCAL	$R = 140\ \text{k}\Omega$		ALC operation level calibration terminal
14	MSDET	$n = 6$		Time constant pin for MS *1
13	ALCDET	$n = 2$		

Pin Description, Equivalent Circuit (cont.)

(V_{CC} = 12 V, A system of single supply voltage, T_a = 25°C, No Signal, The value in the show typical value.)

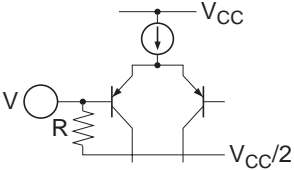
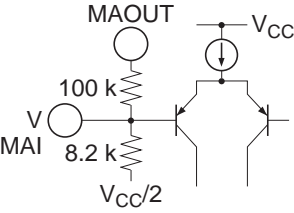
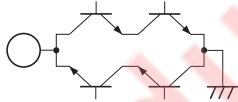
Pin No.	Terminal Name	Note	Equivalent Circuit	Pin Description
27	MSIN	R = 50 kΩ		MS input * ¹
9	ALCIN (R)	R = 100 kΩ		
34	ALCIN (L)			
30	MAI	V = V _{CC} / 2		MS Amp. input * ¹
29	MS GND	V = 0 V		MS output voltage level control pin * ¹
55	ALC (R)	V = 0 V		Variable impedance for attenuation
44	ALC (L)			

- Notes: 1. MS: Music Sensor
 2. Non connection regarding the HA12227F.
 3. Test pin regarding the HA12227F.

Block Diagram

HA12226F

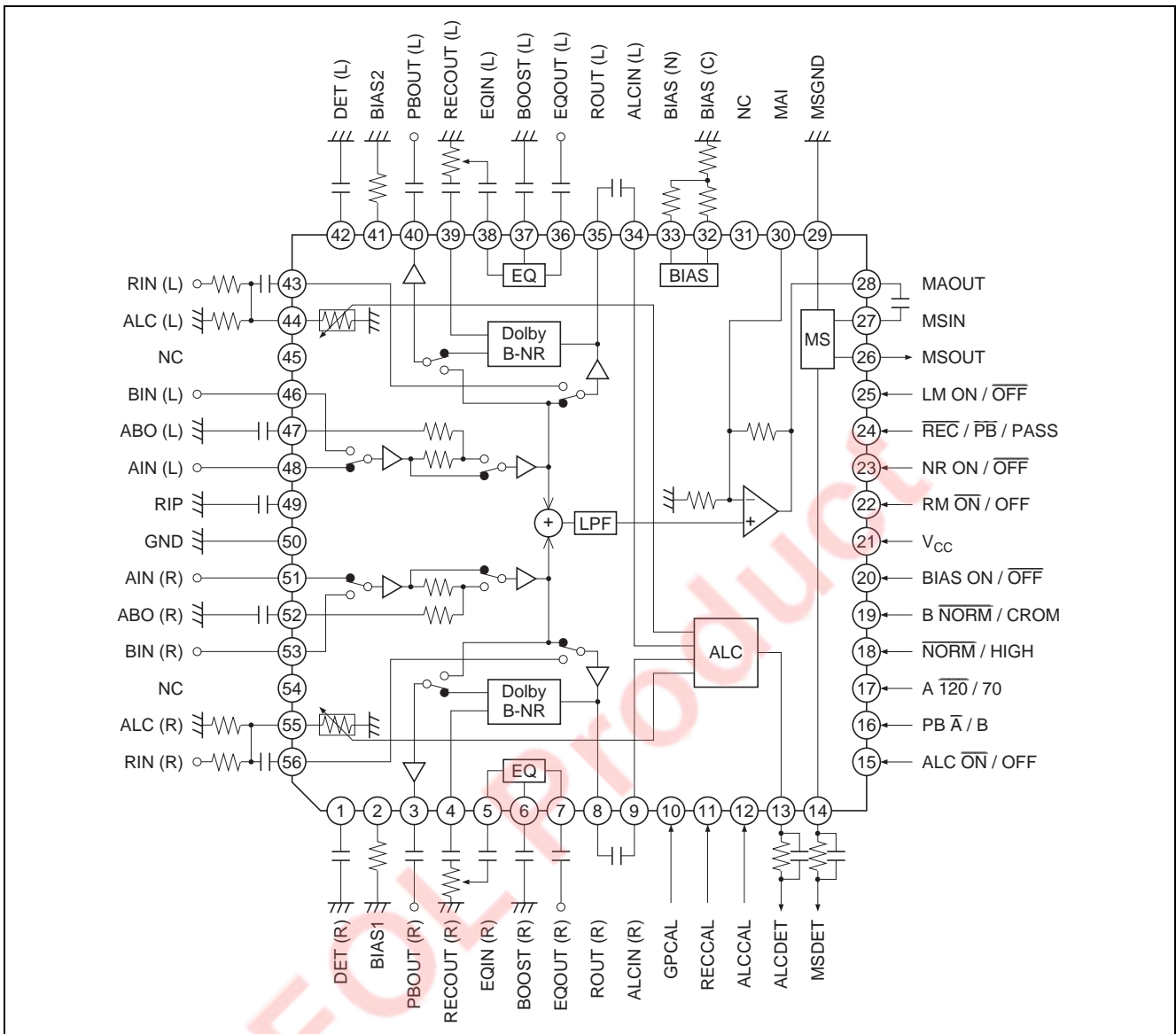

HA12227F

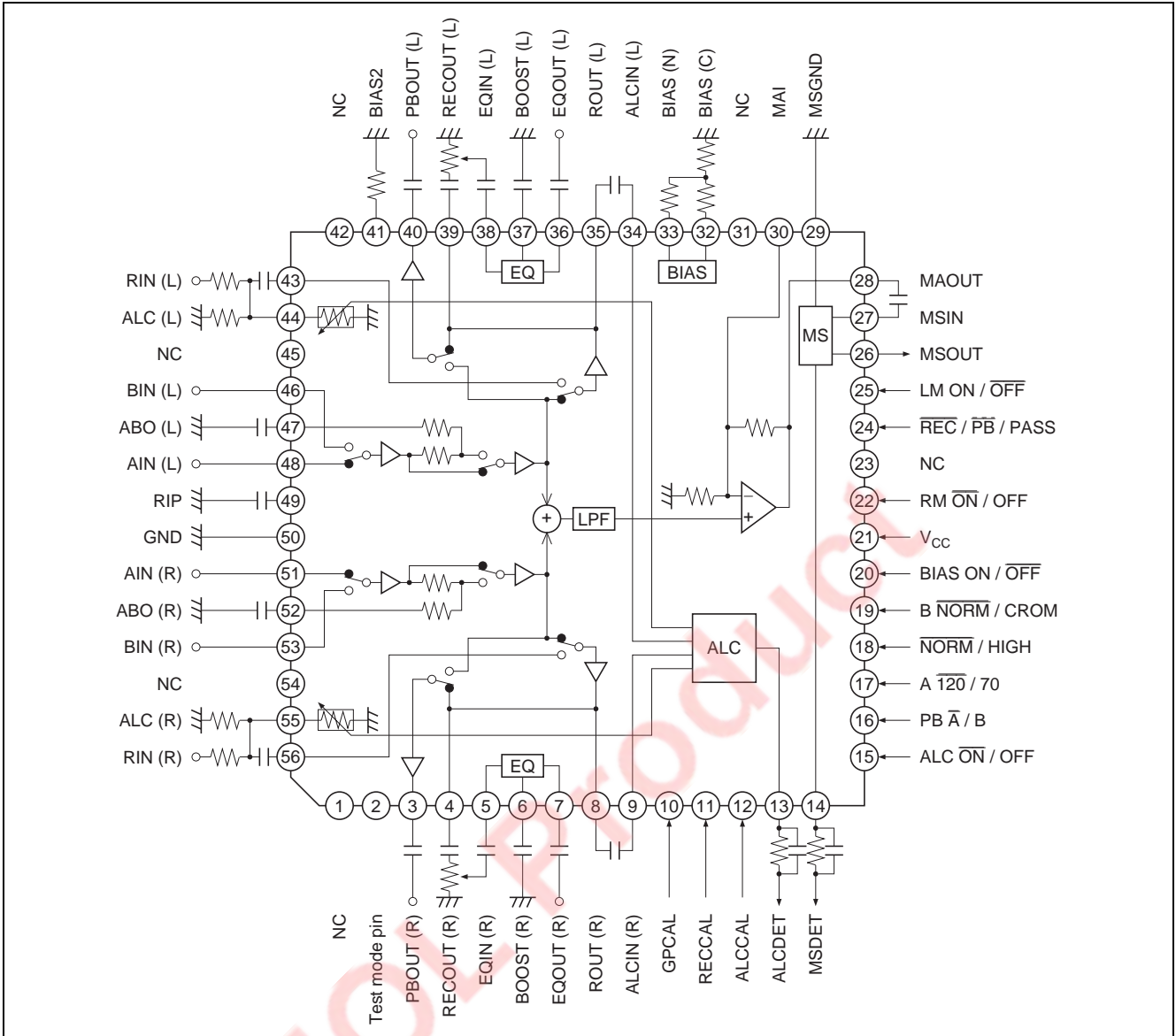

Parallel-Data Format

Pin No.	Pin Name	Lo	Mid	Hi	MODE "Pin Open"
15	ALC $\overline{\text{ON}}$ /OFF	ALC ON	—	ALC OFF	Lo
16	PB $\overline{\text{A/B}}$	Ain * ¹	—	Bin * ¹	Lo
17	A $\overline{\text{T20/70}}$	*1	—	*1	Lo
22	RM $\overline{\text{ON}}$ /OFF	REC MUTE ON	—	REC MUTE OFF	Lo
20	BIAS ON/ $\overline{\text{OFF}}$	BIAS OFF	—	BIAS ON	Lo
23 * ²	NR ON/ $\overline{\text{OFF}}$	NR OFF	—	NR ON	Lo
24	$\overline{\text{REC/PB/PASS}}$	REC MODE	PB MODE	REC MODE PASS	Mid
25	LM ON/ $\overline{\text{OFF}}$	LINE MUTE OFF	—	LINE MUTE ON	Lo
18	$\overline{\text{NORM/HIGH}}$	Normal speed	—	High speed	Lo
19	B $\overline{\text{NORM/CROM}}$	REC EQ Normal * ¹ Bias Normal	REC EQ CROM * ¹ Bias CROM	REC EQ CROM * ¹ Bias CROM	Lo

Notes: 1. PB EQ logic

A $\overline{\text{T20/70}}$	B $\overline{\text{NORM / CROM}}$	PB	
		Lo	Hi
Lo	Lo	FLAT	FLAT
Lo	Mid or Hi	FLAT	70 μ
Hi	Lo	70 μ	FLAT
Hi	Mid or Hi	70 μ	70 μ

2. The HA12226F only.

Functional Description

Power Supply Range

These ICs are designed to operate on single supply.

Table 1 Supply Voltage

Product	Power Supply Range (Single Supply)
HA12226F	11.0 V to 15.0 V
HA12227F	9.5 V to 15.0 V

Note: The lower limit of supply voltage depends on the line output reference level.
 The minimum value of the overload margin is specified as 12 dB by Dolby Laboratories (Dolby IC HA12226F).

Reference Voltage

The reference voltage are provided for the left channel and the right channel separately. The block diagram is shown as figure 1.

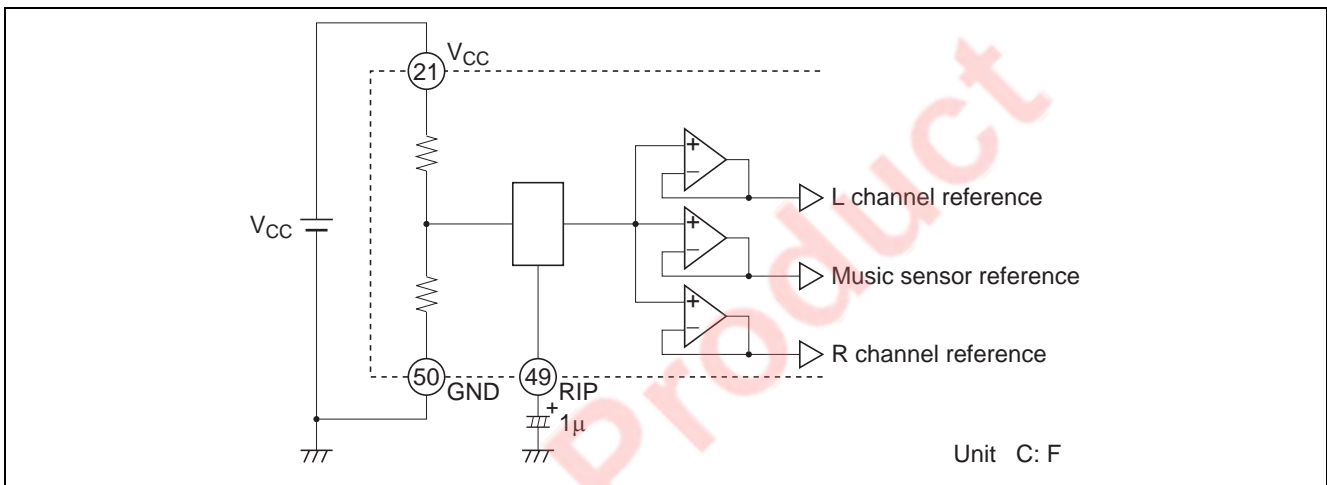

Figure 1 Reference Voltage

Operating Mode Control

The HA12226F/HA12227F provide fully electronic switching circuits. And each operating mode control is controlled by parallel data (DC voltage).

Table 2 Control Voltage

Pin No.	Lo	Mid	Hi	Unit	Test Condition
15, 16, 17, 18, 20, 22, 23*4, 25	-0.2 to 1.0	—	4.0 to V _{CC}	V	Input Pin Measure
19, 24	-0.2 to 1.0	2.0 to 3.0	4.0 to V _{CC}	V	

- Notes:
- Each pins are on pulled down with 100 kΩ internal resistor. Therefore, it will be low-level when each pins are open. But pin 24 is mid-level when it is open.
 - Over shoot level and under shoot level of input signal must be the standardized (High: V_{CC}, Low: -0.2 V).
 - For reduction of pop noise, connect 1 µF to 22 µF capacitor with mode control pins. But it is impossible to reduce completely in regard to Line mute, therefore, use external mute at the same time.
 - Non connection regarding the HA12227F.

Input Block Diagram and Level Diagram

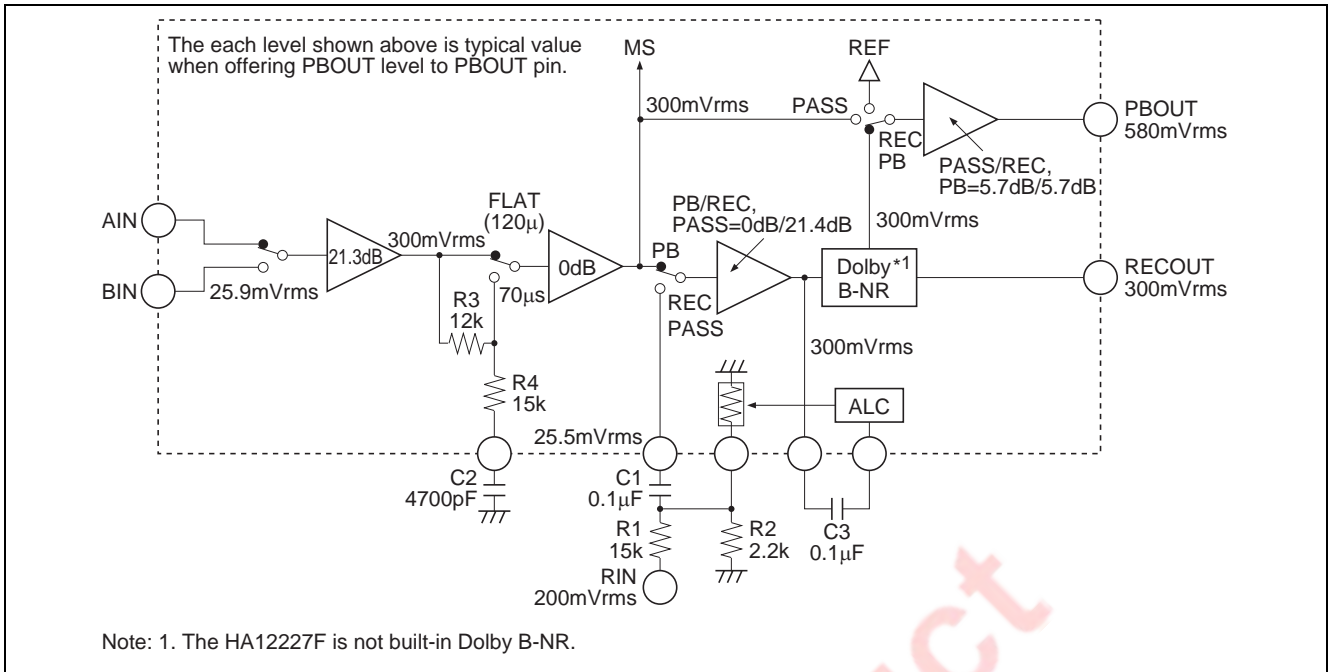

Figure 2 Input Block Diagram

PB Equalizer

By switching logical input level of pin 17 (for Ain) and pin 19 (for Bin), you can equalize corresponding to tape position at play back mode.

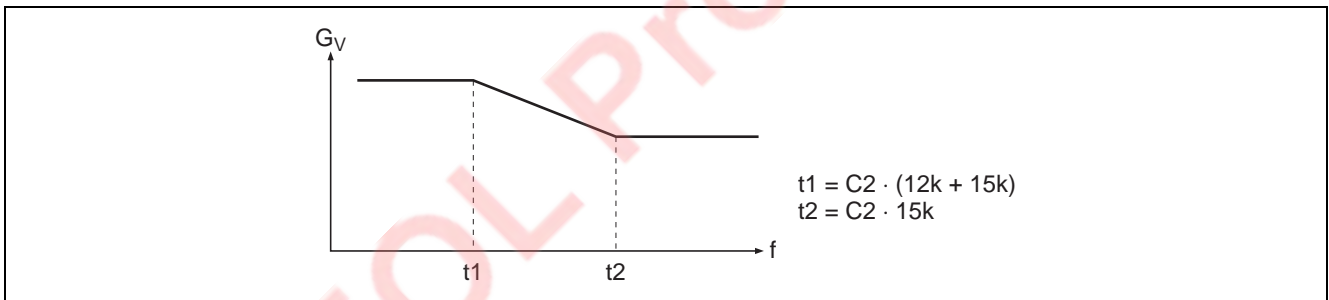

Figure 3 Frequency Characteristic of PB Equalizer

The Sensitivity Adjustment of Music Sensor

Adjusting MS Amp gain by external resistor, the sensitivity of music sensor can set up.

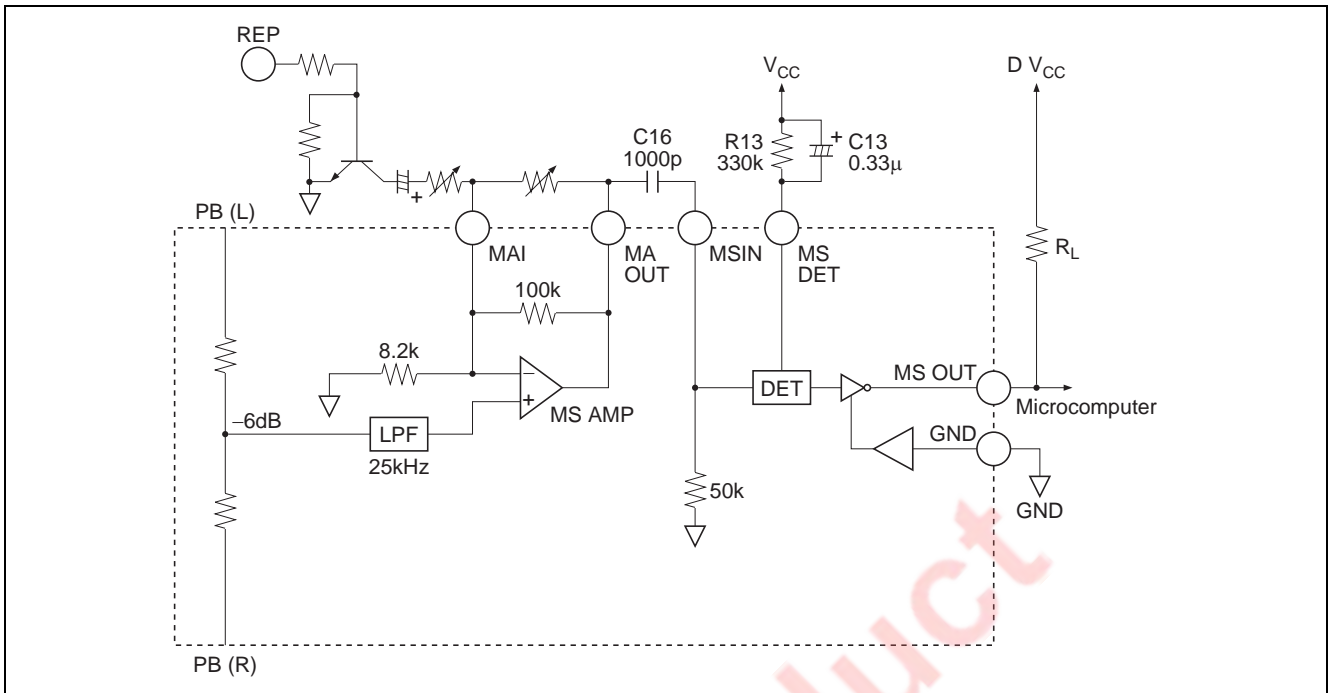

Figure 4 Music Sensor Block Diagram

The Sensitivity of Music Sensor

A standard level of MS input pin 25.9 mVrms, therefore, the sensitivity of music sensor (S) can request it, by lower formulas.

$$\begin{aligned}
 A &= \text{MS Amp Gain} \times 1 \\
 B &= \text{PB input Gain} \times (1/2)^2 \\
 C &= \text{Sensed voltage} \\
 20\log(A \times B) &= D \text{ [dB]} \\
 C &= 130 \text{ [mVrms]} \text{ (Intenally voltage in a standard)} \\
 \text{PB input Gain} &= 21.3 \text{ [dB]}
 \end{aligned}$$

$$S = 20\log \frac{C}{25.9 \cdot A \cdot B} \text{ [dB]}$$

$$S = 14 - D \text{ [dB]}$$

- Notes: 1. When there is not a regulation outside.
 2. Case of one-sided channel input.

But necessary to consider the same attenuation quantity practically, on account of A(B) have made frequency response.

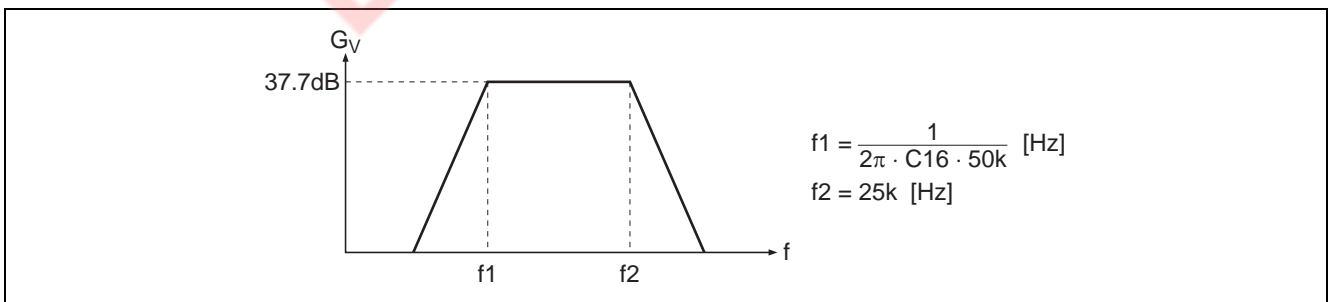

Figure 5 Frequency Characteristic of MSIN

Occasion of the external component of figure 4, f1 is 3.18 kHz.

Time constant of detection

Figure 6(1) generally shows that detection time is in proportion to value of capacitor C13. But, with Attack*¹ and Recovery*² the detection time differs exceptionally.

- Notes: 1. Attack : Non-music to Music
 2. Recovery : Music to Non-music

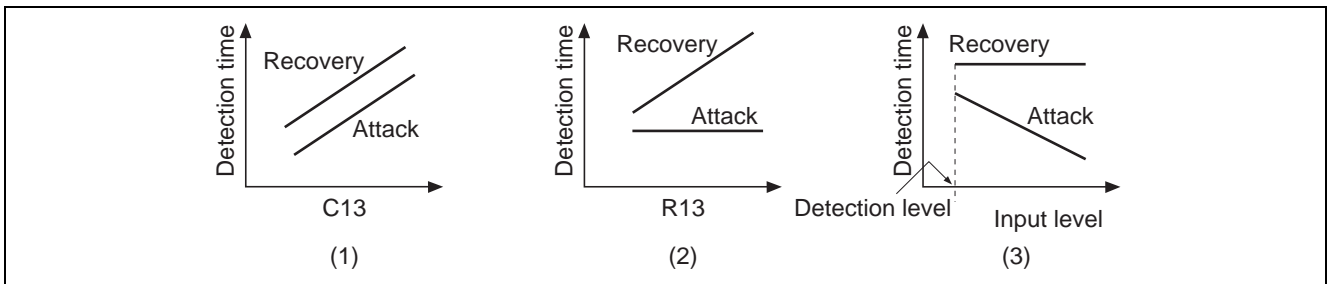

Figure 6 Function Characteristic of MS

Like the figure 6(2), Recovery time is variably possible by value of resistor R13. But Attack time gets about fixed value. Attack time has dependence by input level. When a large signal is inputted, Attack time is short tendency.

Music Sensor Output (MSOUT)

As for internal circuit of music sensor block, music sensor output pin is connected to the collector of NPN type directly, output level will be “high” when sensing no signal. And output level will be “low” when sensing signal.

Connection with microcomputer, it is requested to use external pull up resistor ($R_L = 10\text{ k}\Omega$ to $22\text{ k}\Omega$)

Note: Supply voltage of MSOUT pin must be less than V_{CC} voltage.

The Tolerances of External Components for Dolby NR-Block (Only the HA12226F)

For Dolby NR precision securing, please use external components shown at figure 7. If leak-current are a few electrolytic-capacitor, it can be applicable to C5 and C23.

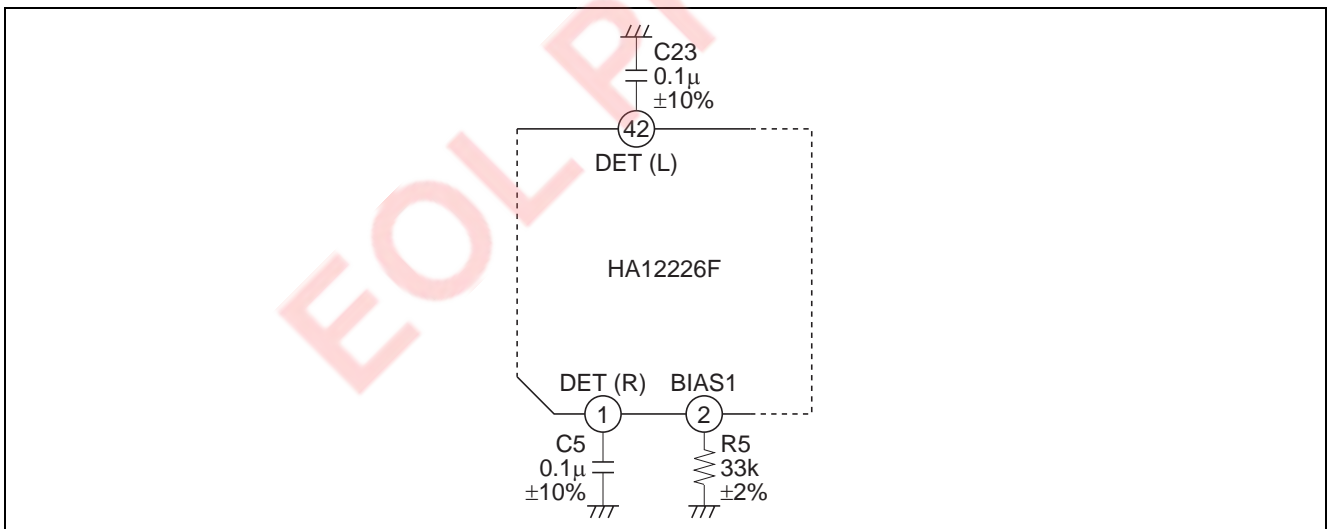

Figure 7 Tolerance of External Components

Low-Boost

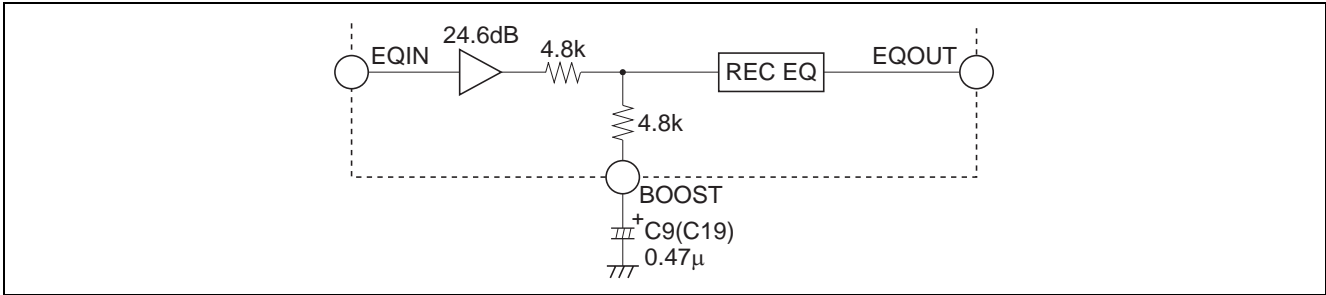

Figure 8 Example of Low Boost Circuit

External components shown figure 8 gives frequency response to take 6 dB boost. And cut off frequency can request it, by C9 (C19).

REC Equalizer

The outlines of REC Equalizing frequency characteristics are shown by figure 9. Those peak level can be set up by supplying voltage. (0 V to 5 V, GND = 0 V) to pin 10 (GPCAL).

And whole band gain can be set up by supplying voltage (0 V to 5 V, GND = 0 V) to pin 11 (RECCAL).

Both setting up range are ±4.5 dB. In case that you do not need setting up, pin 10, pin 11 should be open bias.

Note: Depending on the employed REC/PB head and test tape characteristics, there is a rare case that the REC-EQ characteristics of this LSI can not be matched to the required characteristics because of built-in resistors which determined the REC-EQ parameters in this case, please inquire the responsible agent because of the adjustment of built-in resistor is necessary.

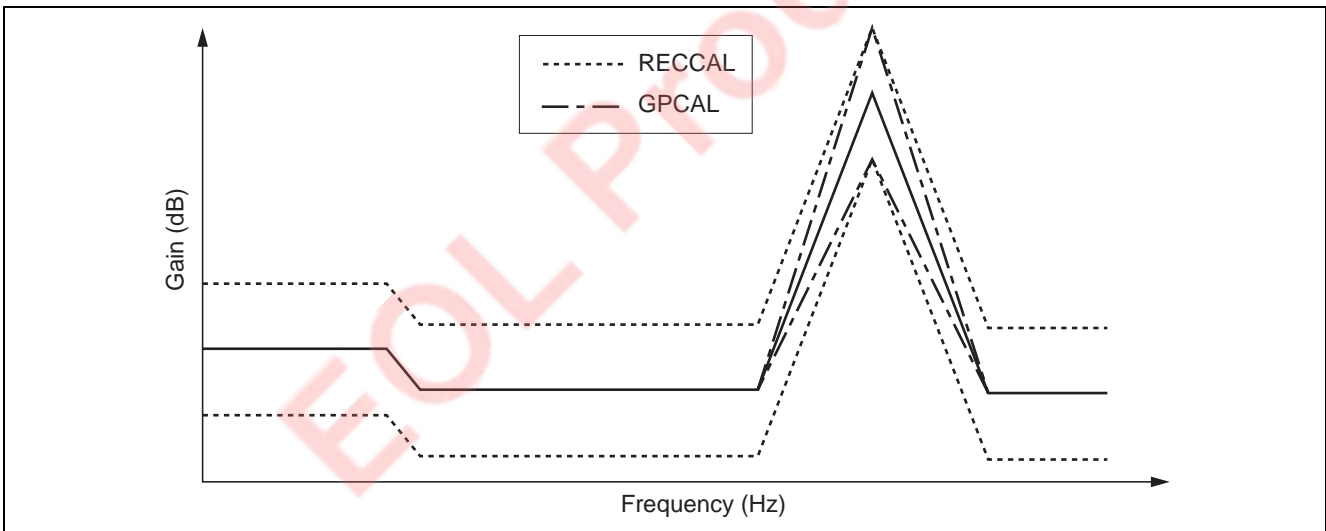

Figure 9 Frequency Characteristics of REC Equalizer

Bias Switch

The HA12215F built-in DC voltage generator for bias oscillator and its bias switches.

External resistor R20, R21 which corresponded with tape positions and bias out voltage are related with below.

$$V_{bias} \doteq \left(\frac{R22}{(R20 \text{ or } R21) + R22} \right) \times (V_{CC} - 0.7) \text{ [V]}$$

Bias switch follows to a logic of pin 19 (B / Norm / Crom).

Note: A current that flows at bias out pin, please use it less than 5 mA.

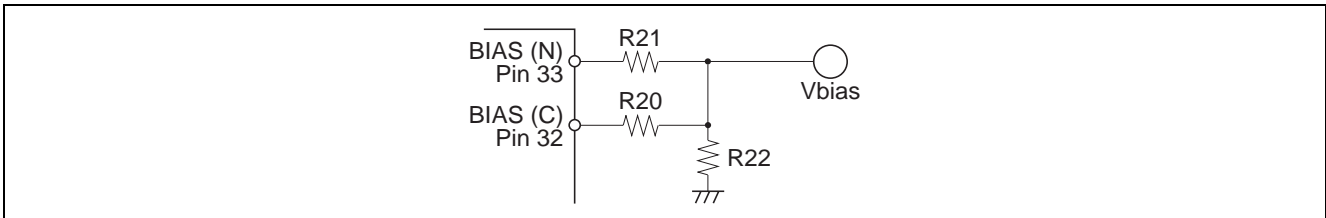

Figure 10 External Components of Bias Block

Automatic Level Control

ALC is the input decay rate variable system. It has internal variable resistors of pin 55 (pin 44) by RECOUT signal that is inputted to pin 9 (pin 34).

The operation is similitude to MS, detected by pin 13.

The signal input pin is pin 56 (pin 43). Resistor R1, R2 and capacitor C2, external components, for the input circuit are commended as figure 12. There are requested to use value of the block diagram figure for performance maintenance of S/N, T.H.D. etc.

Figure 11 shows the relation with R1 front RIN point and ROUT.

ALC operation level acts for the center of +4.5 dB at tape position TYPE I and the center of +2.5 dB at tape position TYPE II, to standard level (300 mVrms).

Then, adopted maximum value circuit, ALC is operated by a large channel of a signal.

ALC ON/OFF can switch it by pin 15. Please do ALC ON, after it does for one time ALC OFF inevitably, for ALC time to start usefully (when switching PB → PASS, when switching PB → PASS), in order to reset ALC circuit.

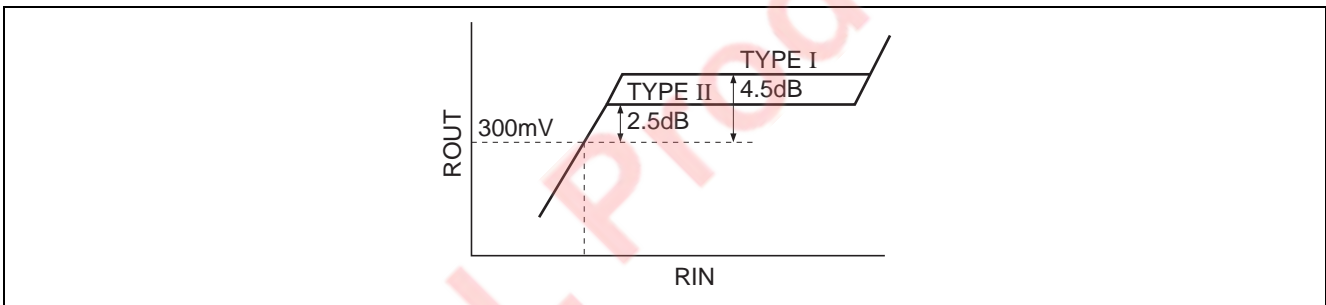

Figure 11 ALC Operation Level

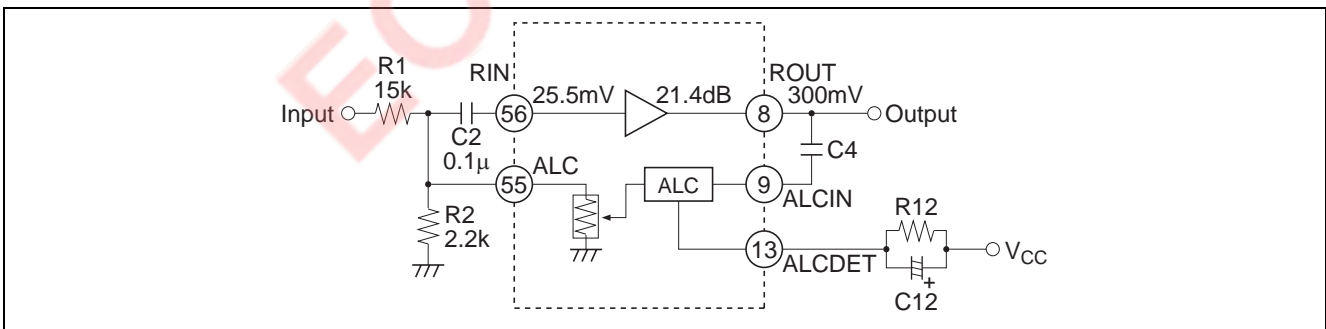

Figure 12 ALC Block Diagram

ALC Operation Level Necessary

ALC operation level is variable to pin 12 bias (ALC-CAL: 0 to 5 V), and its range is ± 4.0 dB.

Unnecessary, pin 12 is unforced.

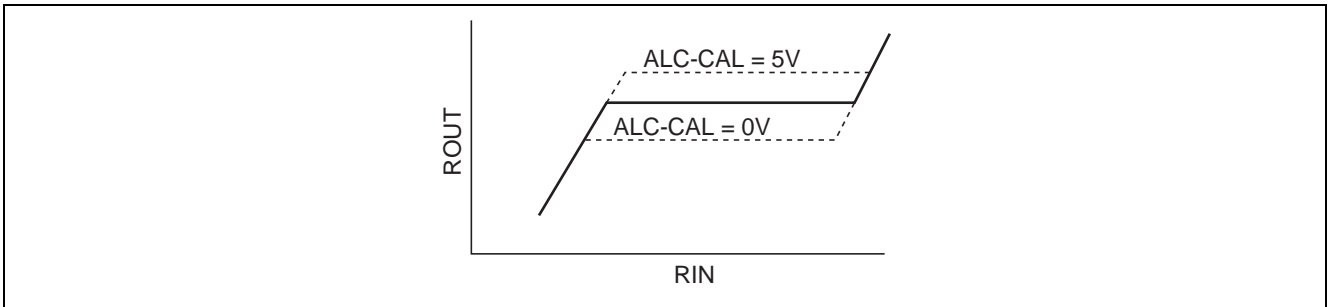

Figure 13 ALC-CAL Characteristics

About a Test Pin (Pin 2)

The HA12227F does for testing exclusive terminal for pin 2.

In mount circuit, this terminal is open or connected to GND with a resistor of 33 k Ω .

Absolute Maximum Ratings

Item	Symbol	Rating	Unit	Note
Max supply voltage	V _{CC} max	16	V	
Power dissipation	Pd	625	mW	Ta \leq 75°C
Operating temperature	Topr	-40 to +75	°C	
Storage temperature	Tstg	-55 to +125	°C	

Electrical Characteristics

HA12226F

(Ta = 25°C, Vcc = 12 V, Dolby Level = REC-OUT Level = 300 mV/rms = 0 dB)

Item	Symbol	Test Condition										Application Terminal				Remark				
		IC Condition *1					Other					Input		Output						
		NR ON/OFF	ALC ON/OFF	REC/PB /PASS	A/B	120µ/70µ	LINE MUTE	B N/C	fin (Hz)	RECOUT level (dB)	Other	Min	Typ	Max	Unit		R	L	R	L
Quiescent current	I _Q	OFF	OFF	PB	A	120	OFF	NORM	1k	0	No signal	18.0	26.0	35.0	mA	—	—	—	21	—
Input AMP. gain	G _V PB	OFF	OFF	PB	A/B	120	OFF	NORM	1k	0		25.5	27.0	28.5	dB	51/53	48/46	3	40	—
	G _V REC	OFF	OFF	REC	A	120	OFF	NORM	1k	0		25.0	26.5	28.0	dB	56	43	3	40	—
B-type Encode boost	ENC 2k (1)	ON	OFF	REC	A	120	OFF	NORM	2k	-20		2.8	4.3	5.8	dB	56	43	4	39	—
	ENC 2k (2)	ON	OFF	REC	A	120	OFF	NORM	2k	-30		7.0	8.5	10.0	dB	56	43	4	39	—
	ENC 5k (1)	ON	OFF	REC	A	120	OFF	NORM	5k	-20		1.7	3.2	4.7	dB	56	43	4	39	—
	ENC 5k (2)	ON	OFF	REC	A	120	OFF	NORM	5k	-30		6.7	8.2	9.7	dB	56	43	4	39	—
	Signal handling	V _o max	ON	OFF	REC	A	120	OFF	NORM	1k	—	THD=1%	12.0	13.0	—	dB	56	43	4	39
Signal to noise ratio	S/N	ON	OFF	REC	A	120	OFF	NORM	1k	—	Rg=5.1kΩ, CCIR/ARM	64.0	70.0	—	dB	56	43	4	39	—
Total Harmonic Distortion	THD	ON	OFF	REC	A	120	OFF	NORM	1k	0		—	0.05	0.3	%	56	43	4	39	—
Channel separation	CTRL (1)	OFF	OFF	PB	A	120	OFF	NORM	1k	+12		70.0	80.0	—	dB	51	48	3	40	—
	CTRL (2)	OFF	OFF	REC	A	120	OFF	NORM	1k	+12		70.0	85.0	—	dB	56	43	3	40	—
Crosstalk	CT A/B	OFF	OFF	PB	A/B	120	OFF	NORM	1k	+12		70.0	80.0	—	dB	51/53	48/46	3	40	—
	CT R/P	OFF	OFF	REC/PB	A	120	OFF	NORM	1k	+12		70.0	80.0	—	dB	51/56	48/43	3	40	—
Pass AMP. gain	G _V PA	OFF	OFF	PASS	A/B	120	OFF	NORM	1k	0		25.5	27.0	28.5	dB	51/53	48/46	3	40	—
Gain deviation	ΔG _V	OFF	OFF	PASS	A/B	120	OFF	NORM	1k	0	G _V PA - G _V PB	-1.0	0.0	1.0	dB	51/53	48/46	3	40	—
MUTE ATT.	MUTE	OFF	OFF	PB	A	120	ON	NORM	1k	+12		70.0	80.0	—	dB	51	48	3	40	—
70µt EQ gain	G _V EQ 1k	OFF	OFF	PB	A	70	OFF	CROM	1k	0		24.0	25.5	27.0	dB	51	48	3	40	—
	G _V EQ 10k	OFF	OFF	PB	A	70	OFF	CROM	10k	0		20.8	22.3	23.8	dB	51	48	3	40	—
MS sensing level	V _{ON}	OFF	OFF	PB	A	120	OFF	NORM	5k	—		-26.0	-22.0	-18.0	dB	51	48	3	40	26
MS output low level	V _{OL}	OFF	OFF	PB	A	120	OFF	NORM	—	—		—	1.0	1.5	V	51	48	—	—	26
MS output leak current	I _{OH}	OFF	OFF	PB	A	120	OFF	NORM	—	—		—	—	—	µA	—	—	—	—	26
ALC operate level	ALC (1)	OFF	ON	REC	A	120	OFF	NORM	1k	+12		2.0	4.5	7.0	dB	56	43	4	39	—
	ALC (2)	OFF	ON	REC	A	120	OFF	CROM	1k	+12		0.0	2.5	5.0	dB	56	43	4	39	—

Notes: 1. Other IC-condition : REC-MUTE OFF, Normal tape, Normal speed, Bias OFF
 2. Vcc = 11.0 V
 3. For inputting signal to one side channel

HA12226F (cont.)

(Ta = 25°C, VCC = 12 V)

Item	Symbol	TAPE SPEED		Test Condition	Min	Typ	Max	Unit	Application Terminal						Remark
		NORM	HIGH						Input	Output	R	L	R	L	
Equalizer S/N	S/N (EQ)	NORM	NORM	Rg = 5.1kΩ, A-WTG Filter (0dB = -5dBs at EQOUT)	55	58	—	dB	5	38	7	36	—	—	—
Equalizer maximum input	Vin max (EQ)	NORM	NORM	f = 1kHz, THD = 1%, Vin = -26dBs = 0dB	10.5	12.5	—	dB	5	38	7	36	—	—	—
Equalizer total harmonic distortion	T.H.D.1 (EQ) T.H.D.2 (EQ)	NORM	NORM	f = 1kHz, Vin = -26dBs	—	0.2	0.5	%	5	38	7	36	—	—	—
Equalizer offset voltage	Vofs (EQ)	NORM	NORM	f = 1kHz, Vin = -30dBs	—500	0	500	mV	5	38	7	36	—	—	—
Equalizer frequency response (NORM - NORM)	GVEQ-NH1	NORM	NORM	No-Signal	18.8	20.3	21.8	dB	5	38	7	36	—	—	—
	GVEQ-NH2	NORM	NORM	f = 3kHz, Vin = -46dBs	30.1	32.6	35.1	dB	5	38	7	36	—	—	—
	GVEQ-NH3	NORM	NORM	f = 8kHz, Vin = -46dBs	23.3	24.8	26.3	dB	5	38	7	36	—	—	—
Equalizer frequency response (CROM - NORM)	GVEQ-CH1	CROM	NORM	f = 12kHz, Vin = -46dBs	28.5	30.5	32.5	dB	5	38	7	36	—	—	—
	GVEQ-CH2	CROM	NORM	f = 3kHz, Vin = -46dBs	34.0	36.5	39.0	dB	5	38	7	36	—	—	—
	GVEQ-CH3	CROM	NORM	f = 12kHz, Vin = -46dBs	15.0	16.5	18.0	dB	5	38	7	36	—	—	—
Equalizer frequency response (NORM - High)	GVEQ-NH1	NORM	HIGH	f = 5kHz, Vin = -46dBs	19.9	21.9	23.9	dB	5	38	7	36	—	—	—
	GVEQ-NH2	NORM	HIGH	f = 15kHz, Vin = -46dBs	23.4	25.9	28.4	dB	5	38	7	36	—	—	—
	GVEQ-NH3	NORM	HIGH	f = 20kHz, Vin = -46dBs	19.7	21.2	22.7	dB	5	38	7	36	—	—	—
Equalizer frequency response (CROM - High)	GVEQ-CH1	CROM	HIGH	f = 5kHz, Vin = -46dBs	23.5	25.5	27.5	dB	5	38	7	36	—	—	—
	GVEQ-CH2	CROM	HIGH	f = 15kHz, Vin = -46dBs	26.5	29.0	31.5	dB	5	38	7	36	—	—	—
	GVEQ-CH3	CROM	HIGH	f = 20kHz, Vin = -46dBs	60	70	—	dB	5	38	7	36	—	—	—
REC-MUTE attenuation	REC-MUTE	NORM	NORM	f = 1kHz, Vin = -14dBs, VREC-CAL = 5V	3.0	4.5	6.0	dB	5	38	7	36	—	—	—
REC CAL response	R-CAL1	NORM	NORM	f = 3kHz, Vin = -46dBs, VREC-CAL = 5V	—6.0	-4.5	-3.0	dB	5	38	7	36	—	—	—
	R-CAL2	NORM	NORM	f = 3kHz, Vin = -46dBs, VREC-CAL = 0V	—	-4.0	-3.0	dB	56	43	4	39	—	—	—
GPCAL response	GP-CAL1	NORM	NORM	f = 12kHz, Vin = -46dBs, VGP-CAL = 0V	3.0	4.5	6.0	dB	5	38	7	36	—	—	—
	GP-CAL2	NORM	NORM	f = 12kHz, Vin = -46dBs, VGP-CAL = 5V	-6.0	-4.5	-3.0	dB	5	38	7	36	—	—	—
ALC CAL response	ALC-CAL1	NORM	NORM	f = 1kHz, VALC-CAL = 0V	—	-4.0	-3.0	dB	56	43	4	39	—	—	—
	ALC-CAL2	NORM	NORM	f = 1kHz, VALC-CAL = 5V	3.0	4.0	—	dB	56	43	4	39	—	—	—
Bias out maximum level	Bias on	RL = 2.2kΩ		Vcc	-1.4	-0.7	—	V	—	—	—	—	—	—	32, 33
Bias out offset	Bias off	RL = 2.2kΩ		Vcc	-0.1	0.0	0.1	V	—	—	—	—	—	—	—
Control voltage	VIL				-0.2	—	—	V	—	—	—	—	—	—	15 to 20, 22 to 25
	VIM				2.0	—	—	V	—	—	—	—	—	—	19, 24
	VIH				4.0	—	VCC	V	—	—	—	—	—	—	15 to 20, 22 to 25

HA12227F

(Ta = 25°C, V_{CC} = 12 V, Dolby Level = REC-OUT Level = 300 mVrms = 0 dB)

Item	Symbol	Test Condition										Application Terminal							
		IC Condition *1					Other					Input		Output					
		REC/PB /PASS	ALC ON/OFF	A/B	120µV /70µV	LINE MUTE	B N/C	f _{in} (Hz)	RECOULT level (dB)	Other	Min	Typ	Max	Unit	R	L	R	L	COM Remark
Quiescent current	I _Q	PB	OFF	A	120	OFF	NORM	—	No signal	14.0	22.0	30.0	mA	—	—	—	—	21	
Input AMP . gain	G _V PB	PB	OFF	A/B	120	OFF	NORM	1k	0	25.5	27.0	28.5	dB	51/53	48/46	3	40	—	
	G _V REC	REC	OFF	A	120	OFF	NORM	1k	0	25.0	26.5	28.0	dB	56	43	3	40	—	
Signal handling	V _o max	REC	OFF	A	120	OFF	NORM	1k	—	THD=1%	12.0	13.0	—	dB	56	43	4	39	2
Signal to noise ratio	S/N	REC	OFF	A	120	OFF	NORM	1k	—	Rg=5.1kΩ, CC/R/ARM	64.0	70.0	—	dB	56	43	4	39	—
Total Harmonic Distortion	THD	REC	OFF	A	120	OFF	NORM	1k	0	—	0.05	0.3	—	%	56	43	4	39	—
Channel separation	CTRL (1)	PB	OFF	A	120	OFF	NORM	1k	+12	—	70.0	80.0	—	dB	51	48	3	40	—
	CTRL (2)	REC	OFF	A	120	OFF	NORM	1k	+12	—	70.0	85.0	—	dB	56	43	3	40	—
Crosstalk	CT A/B	PB	OFF	A/B	120	OFF	NORM	1k	+12	—	70.0	80.0	—	dB	51/53	48/46	3	40	—
	CT R/P	REC/PB	OFF	A	120	OFF	NORM	1k	+12	—	70.0	80.0	—	dB	51/56	48/43	3	40	—
Pass AMP . gain	G _V PA	PASS	OFF	A/B	120	OFF	NORM	1k	0	—	25.5	27.0	28.5	dB	51/53	48/46	3	40	—
Gain deviation	ΔG _V	PASS	OFF	A/B	120	OFF	NORM	1k	0	G _V PA – G _V PB	-1.0	0.0	1.0	dB	51/53	48/46	3	40	—
MUTE ATT.	MUTE	PB	OFF	A	120	ON	NORM	1k	+12	—	70.0	80.0	—	dB	51	48	3	40	—
70µ EQ gain	G _V EQ 1k	PB	OFF	A	70	OFF	CROM	1k	0	—	24.0	25.5	27.0	dB	51	48	3	40	—
	G _V EQ 10k	PB	OFF	A	70	OFF	CROM	10k	0	—	20.8	22.3	23.8	dB	51	48	3	40	—
MS sensing level	V _{ON}	PB	OFF	A	120	OFF	NORM	5k	—	—	-26.0	-22.0	-18.0	dB	51	48	3	40	26
MS output low level	V _{OL}	PB	OFF	A	120	OFF	NORM	—	—	—	—	1.0	1.5	V	51	48	—	—	26
MS output leak current	I _{OH}	PB	OFF	A	120	OFF	NORM	—	—	—	—	—	2.0	µA	—	—	—	—	26
ALC operate level	ALC (1)	REC	ON	A	120	OFF	NORM	1k	+12	—	2.0	4.5	7.0	dB	56	43	4	39	—
	ALC (2)	REC	ON	A	120	OFF	CROM	1k	+12	—	0.0	2.5	5.0	dB	56	43	4	39	—

Notes: 1. Other IC-condition : REC-MUTE OFF, Normal tape, Normal speed, Bias OFF
 2. V_{CC} = 11.0 V
 3. For inputting signal to one side channel

HA12227F (cont.)

(Ta = 25°C, Vcc = 12 V)

Item	Symbol	TAPE SPEED			Test Condition	Min	Typ	Max	Unit	Application Terminal						
		S/N (EQ)	Vin max (EQ)	T.H.D.1 (EQ)						T.H.D.2 (EQ)	Input			Output		
											NORM	NORM	NORM	R	L	R
Equalizer S/N	S/N (EQ)	NORM	NORM	NORM	Rg = 5.1kΩ, A-WTG Filter (0dB = -5dBs at EQOUT)	55	58	—	dB	5	38	7	36	—	—	
Equalizer maximum input	Vin max (EQ)	NORM	NORM	NORM	f = 1kHz, THD = 1%, Vin = -26dBs = 0dB	10.5	12.5	—	dB	5	38	7	36	—	—	
Equalizer total harmonic distortion	T.H.D.1 (EQ)	NORM	NORM	NORM	f = 1kHz, Vin = -26dBs	—	0.2	0.5	%	5	38	7	36	—	—	
Equalizer offset voltage	T.H.D.2 (EQ)	NORM	NORM	NORM	f = 1kHz, Vin = -30dBs	—	0.2	0.5	%	5	38	7	36	—	—	
Equalizer frequency response (NORM - NORM)	Vofs (EQ)	NORM	NORM	NORM	No-Signal	-500	0	500	mV	5	38	7	36	—	—	
Equalizer frequency response (CROM - NORM)	GVEQ-NH1	NORM	NORM	NORM	f = 3kHz, Vin = -46dBs	18.8	20.3	21.8	dB	5	38	7	36	—	—	
	GVEQ-NH2	NORM	NORM	NORM	f = 8kHz, Vin = -46dBs	23.9	25.9	27.9	dB	5	38	7	36	—	—	
	GVEQ-NH3	NORM	NORM	NORM	f = 12kHz, Vin = -46dBs	30.1	32.6	35.1	dB	5	38	7	36	—	—	
Equalizer frequency response (NORM - High)	GVEQ-CH1	CROM	NORM	NORM	f = 3kHz, Vin = -46dBs	23.3	24.8	26.3	dB	5	38	7	36	—	—	
	GVEQ-CH2	CROM	NORM	NORM	f = 8kHz, Vin = -46dBs	28.5	30.5	32.5	dB	5	38	7	36	—	—	
	GVEQ-CH3	CROM	NORM	NORM	f = 12kHz, Vin = -46dBs	34.0	36.5	39.0	dB	5	38	7	36	—	—	
REC-MUTE attenuation	REC-MUTE	NORM	NORM	NORM	f = 5kHz, Vin = -46dBs	15.0	16.5	18.0	dB	5	38	7	36	—	—	
	R-CAL1	NORM	NORM	NORM	f = 15kHz, Vin = -46dBs	19.9	21.9	23.9	dB	5	38	7	36	—	—	
	R-CAL2	NORM	NORM	NORM	f = 20kHz, Vin = -46dBs	23.4	25.9	28.4	dB	5	38	7	36	—	—	
GP CAL response	GP-CAL1	NORM	NORM	NORM	f = 5kHz, Vin = -46dBs	19.7	21.2	22.7	dB	5	38	7	36	—	—	
	GP-CAL2	NORM	NORM	NORM	f = 15kHz, Vin = -46dBs	23.5	25.5	27.5	dB	5	38	7	36	—	—	
	ALC CAL response	NORM	NORM	NORM	f = 20kHz, Vin = -46dBs	26.5	29.0	31.5	dB	5	38	7	36	—	—	
Bias out maximum level	REC-CAL1	NORM	NORM	NORM	f = 1kHz, Vin = -14dBs, VREC-CAL = 5V	60	70	—	dB	5	38	7	36	—	—	
	REC-CAL2	NORM	NORM	NORM	f = 3kHz, Vin = -46dBs, VREC-CAL = 0V	3.0	4.5	6.0	dB	5	38	7	36	—	—	
	ALC CAL response	NORM	NORM	NORM	f = 12kHz, Vin = -46dBs, VGP-CAL = 5V	-6.0	-4.5	-3.0	dB	5	38	7	36	—	—	
Bias out offset	ALC-CAL1	NORM	NORM	NORM	f = 12kHz, Vin = -46dBs, VGP-CAL = 0V	3.0	4.5	6.0	dB	5	38	7	36	—	—	
	ALC-CAL2	NORM	NORM	NORM	f = 12kHz, Vin = -46dBs, VGP-CAL = 5V	-6.0	-4.5	-3.0	dB	5	38	7	36	—	—	
	Bias on	NORM	NORM	NORM	f = 1kHz, V _{ALC-CAL} = 0V	—	-4.0	-3.0	dB	56	43	4	39	—	—	
Control voltage	Bias off	NORM	NORM	NORM	f = 1kHz, V _{ALC-CAL} = 5V	3.0	4.0	—	dB	56	43	4	39	—	—	
	V _{IL}	NORM	NORM	NORM	ALC (1) = 0dB	V _{CC}	—	—	V	—	—	—	—	—	32, 33	
	V _{IM}	NORM	NORM	NORM	R _L = 2.2kΩ	-1.4	0.0	0.1	V	—	—	—	—	—	15 to 20, 22 to 25	
Control voltage	V _{IH}	NORM	NORM	NORM	R _L = 2.2kΩ	-0.2	1.0	1.0	V	—	—	—	—	—	19, 24	
	V _{IL}	NORM	NORM	NORM	R _L = 2.2kΩ	2.0	—	3.0	V	—	—	—	—	—	15 to 20, 22 to 25	
	V _{IH}	NORM	NORM	NORM	R _L = 2.2kΩ	4.0	—	V _{CC}	V	—	—	—	—	—	15 to 20, 22 to 25	

Test Circuit

HA12226F

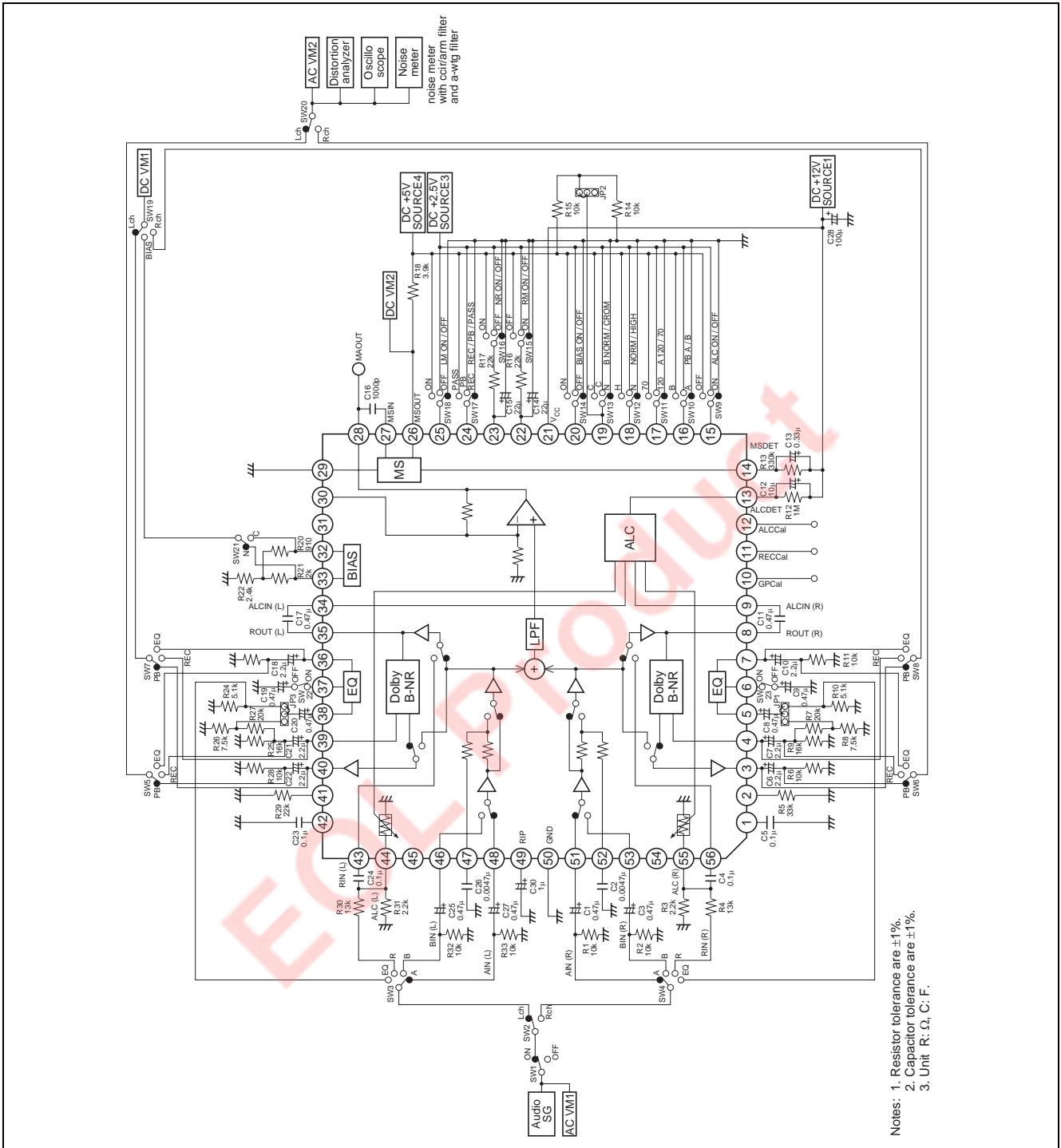

HA12227F

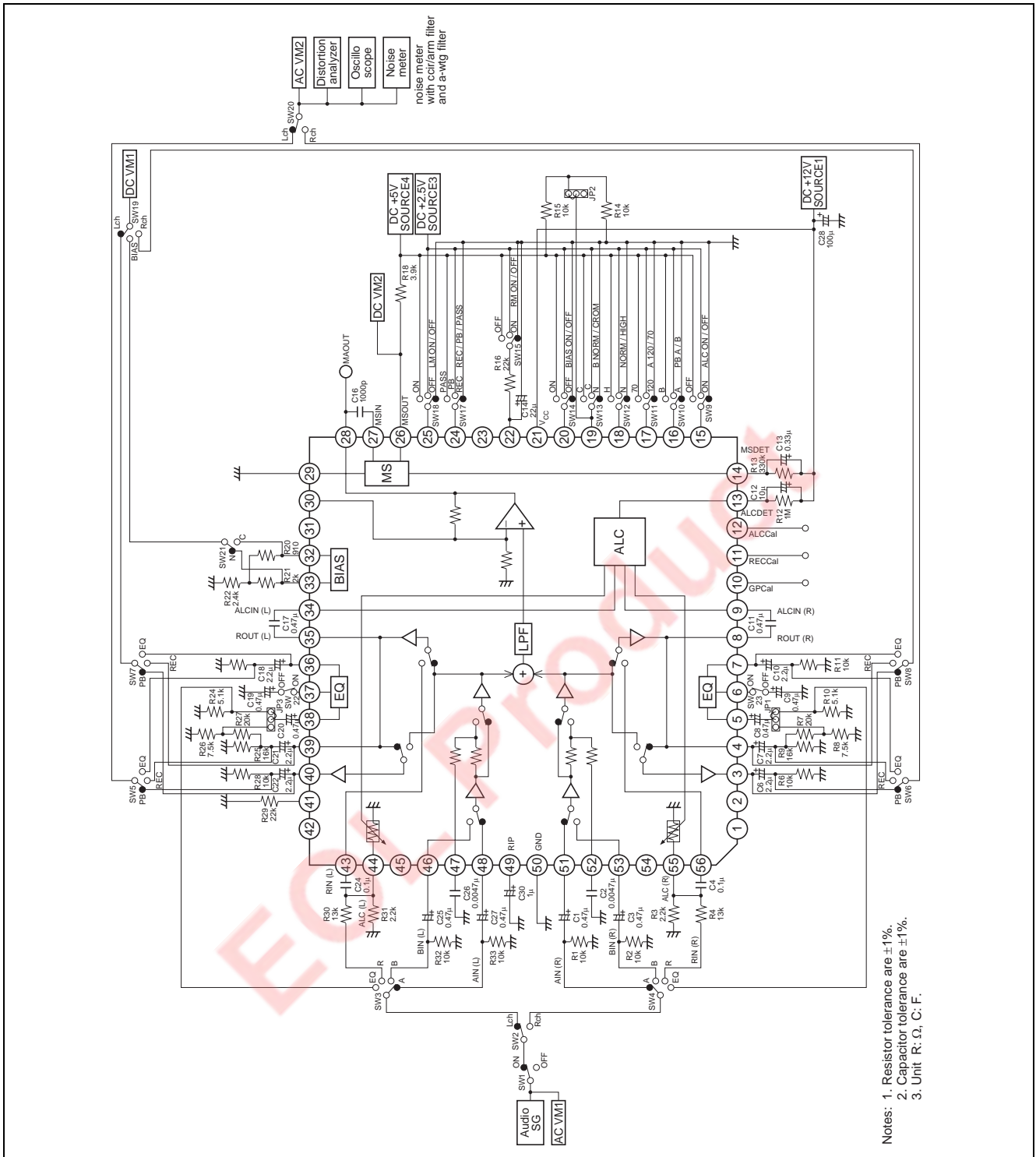

Characteristic Curves

HA12226F

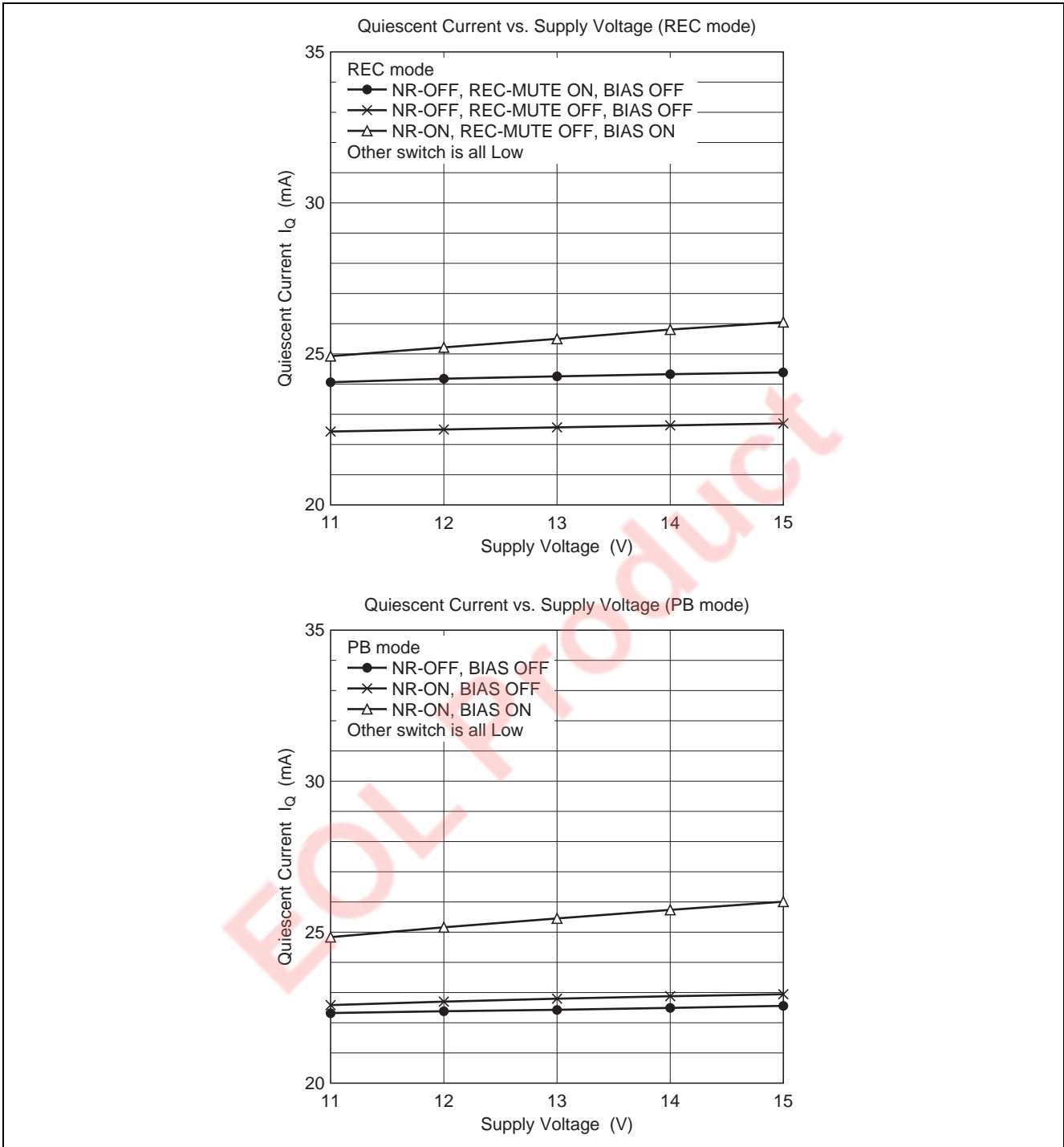

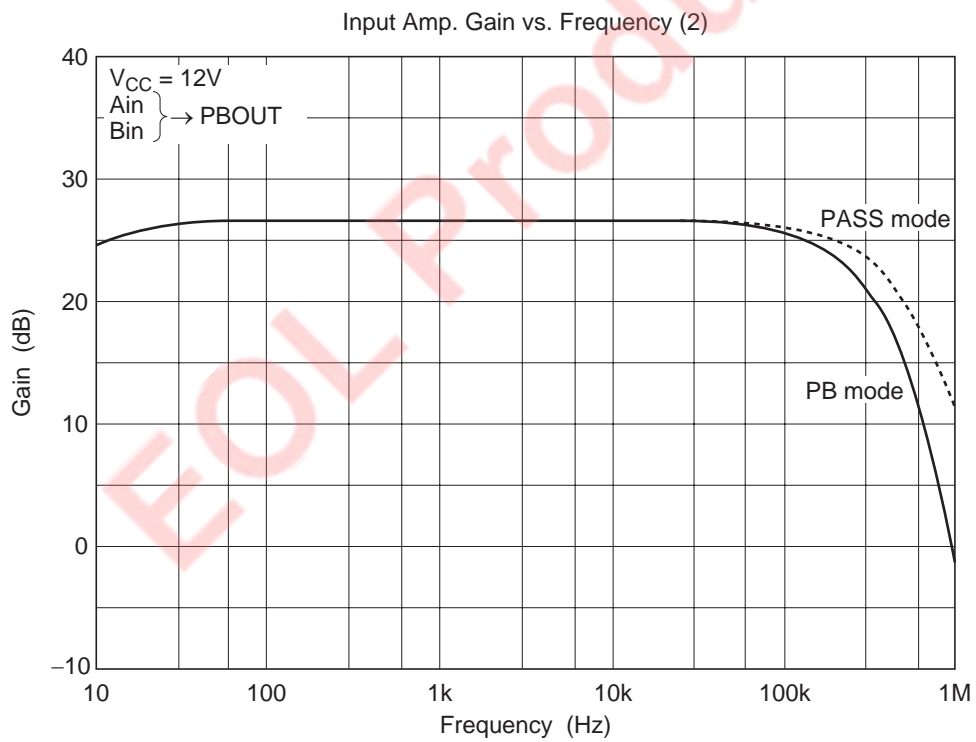
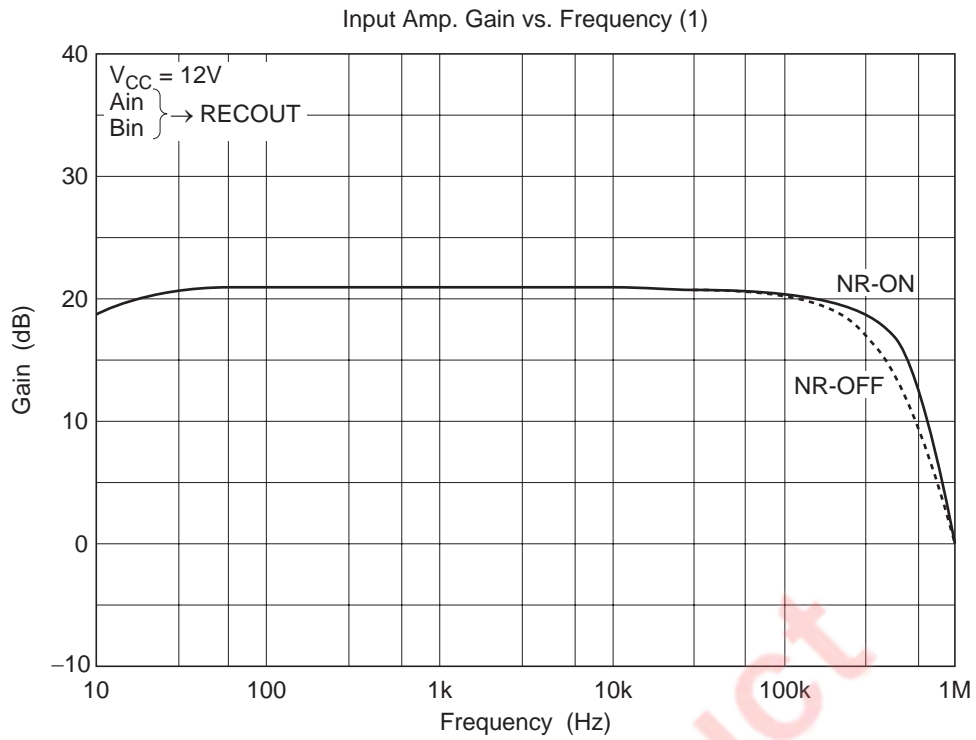

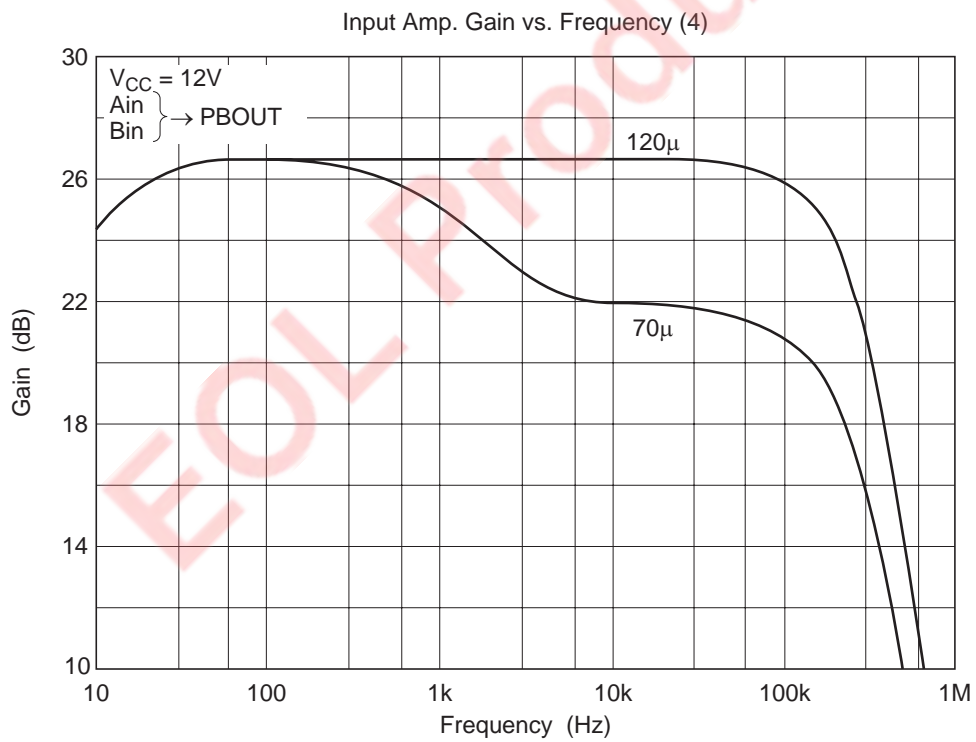
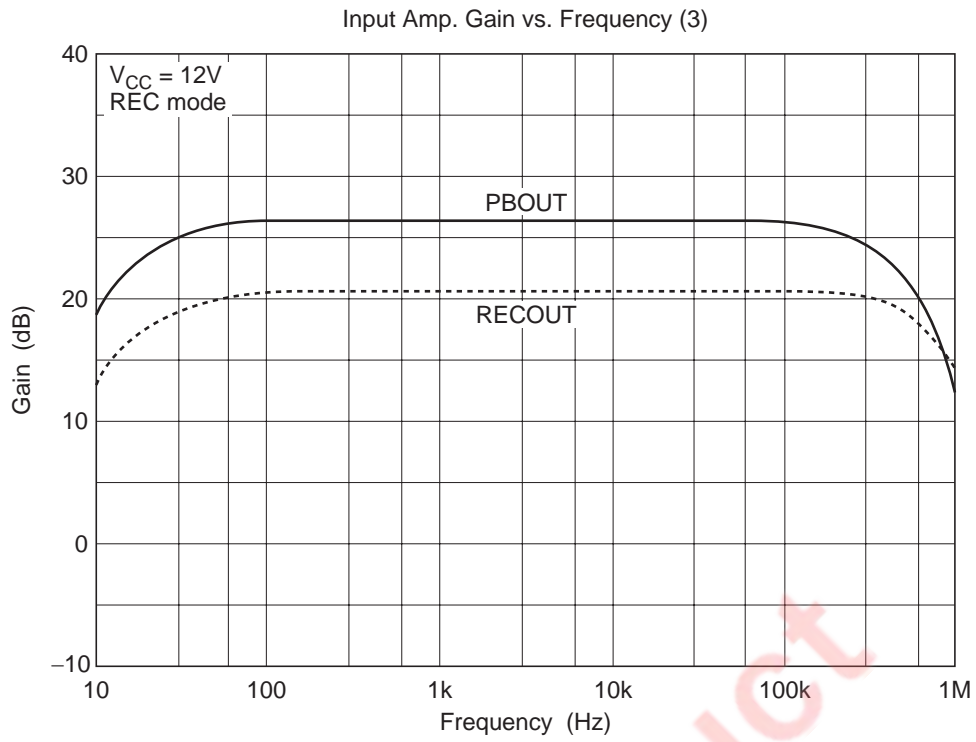

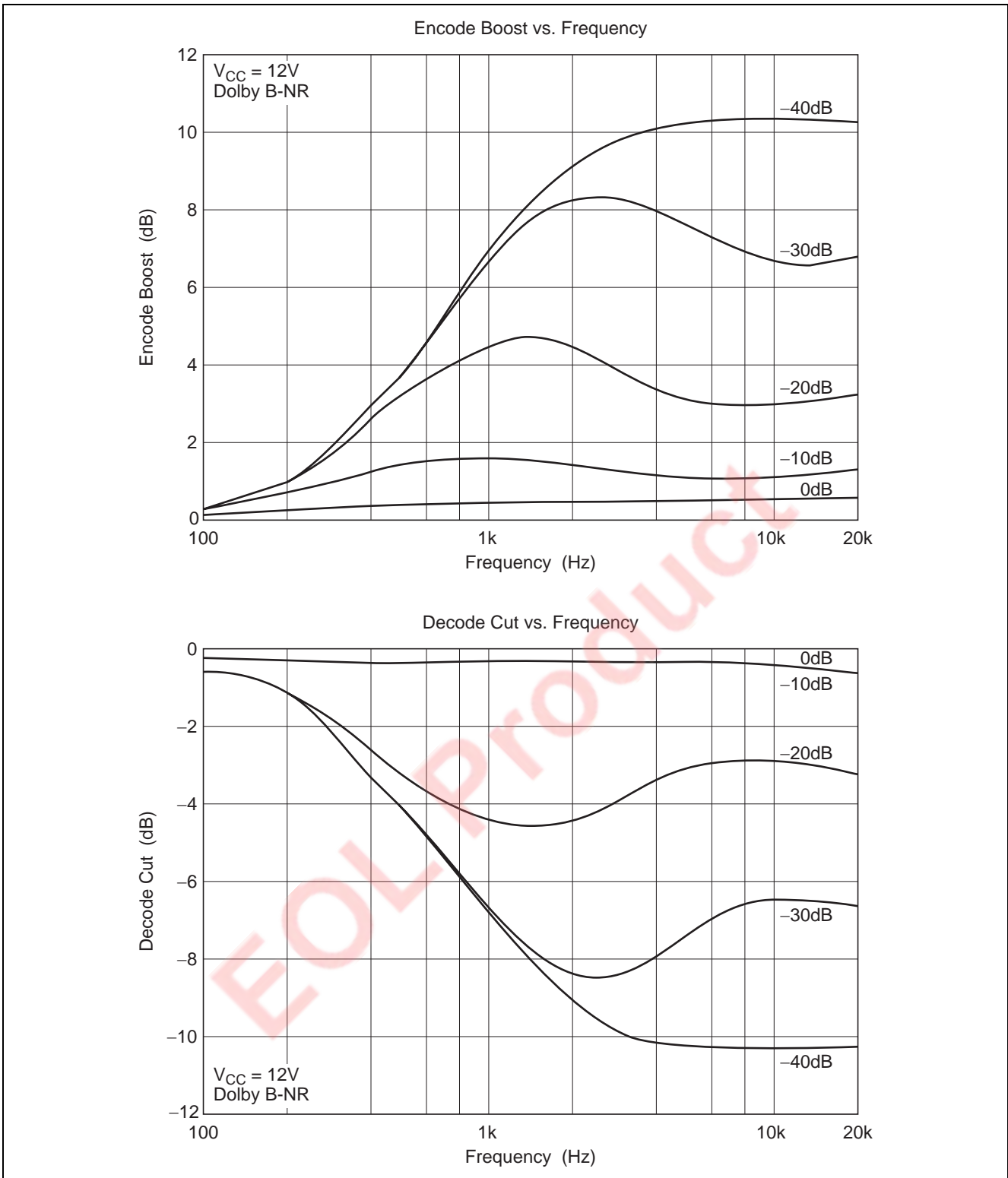

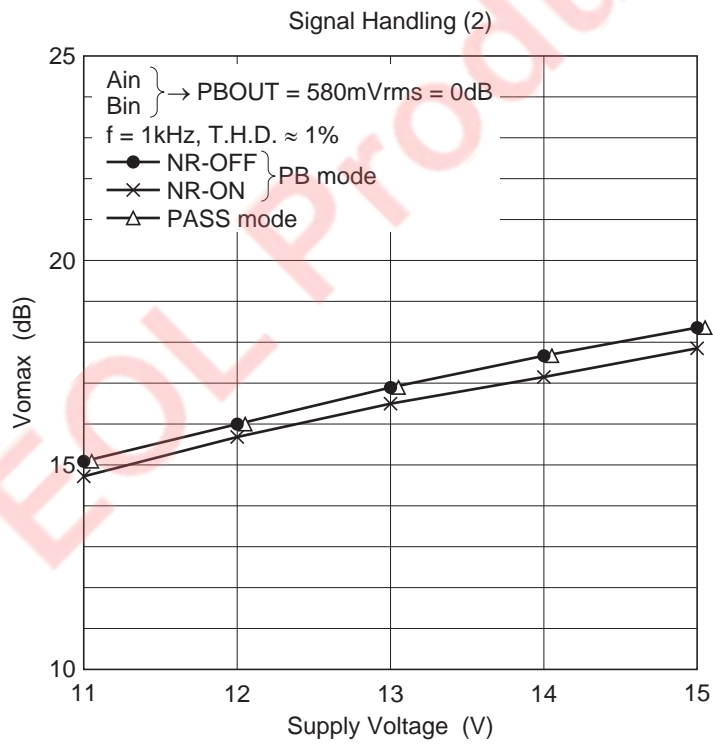
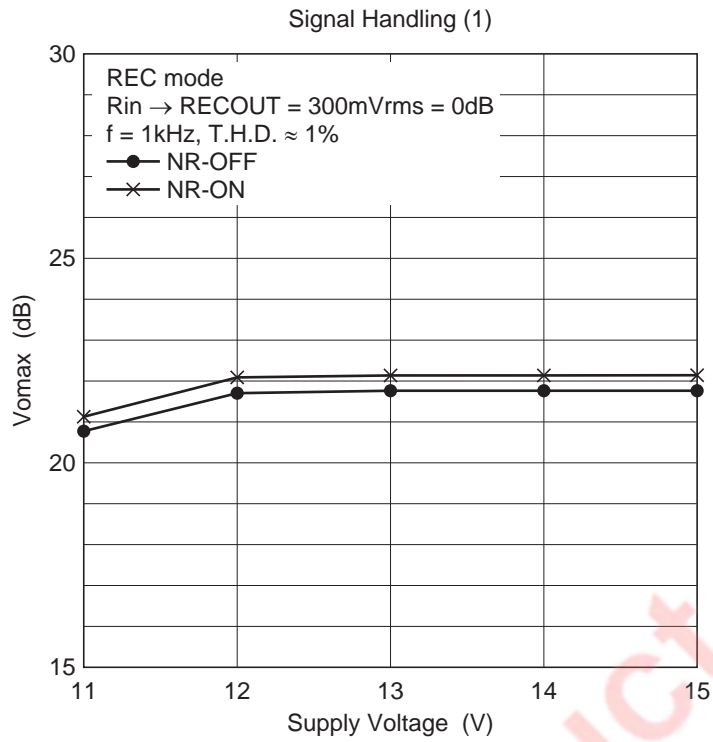

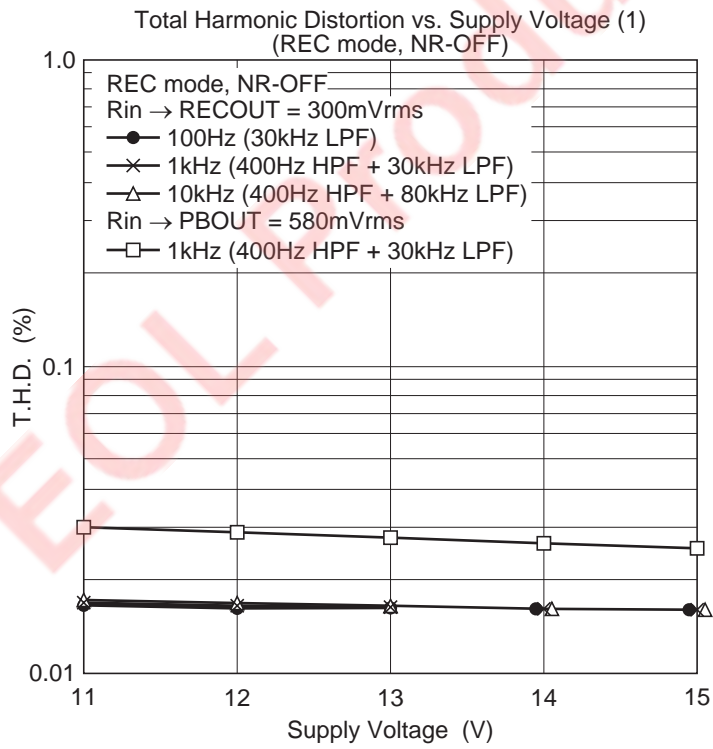
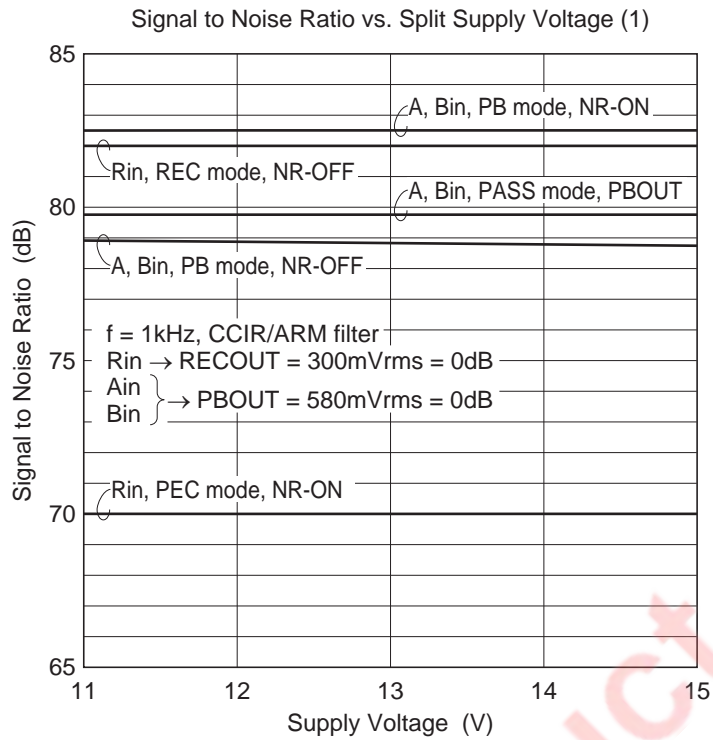

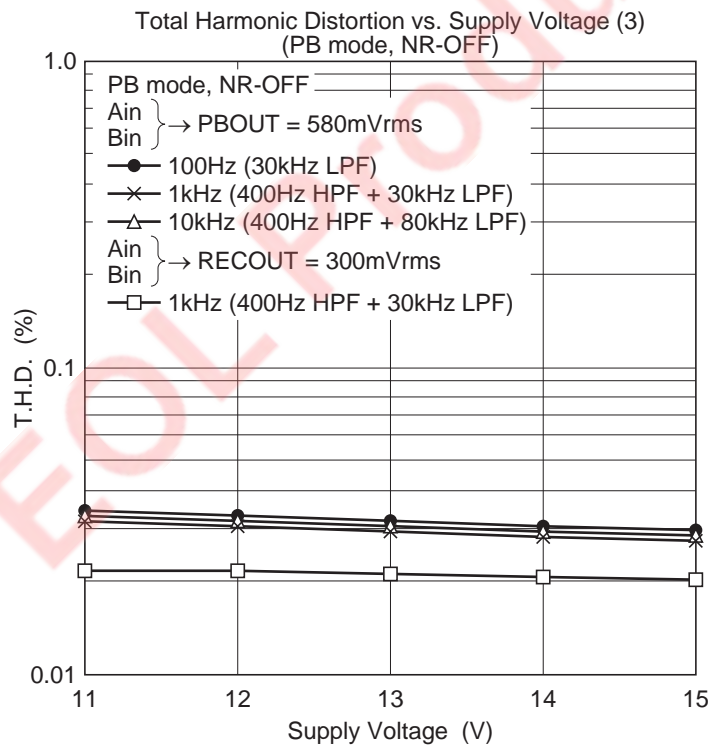
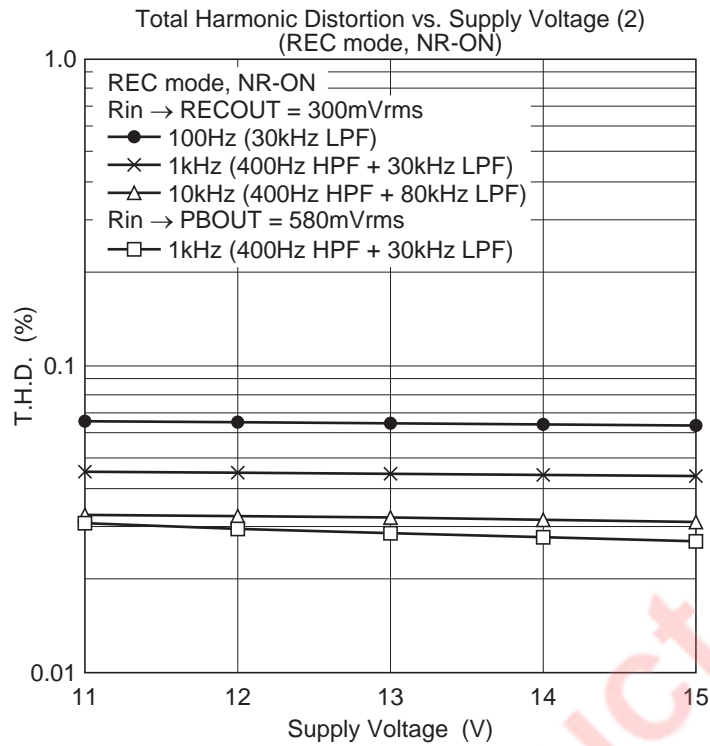

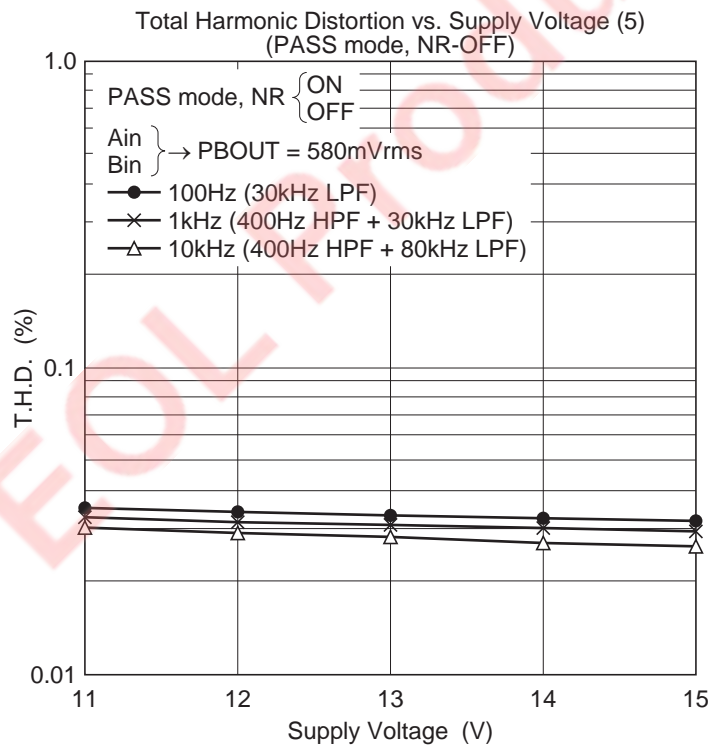
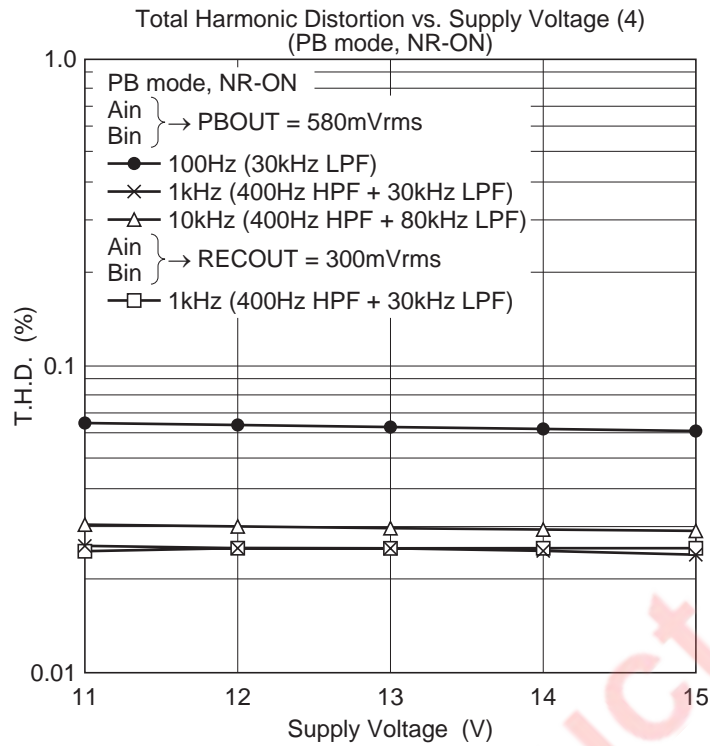

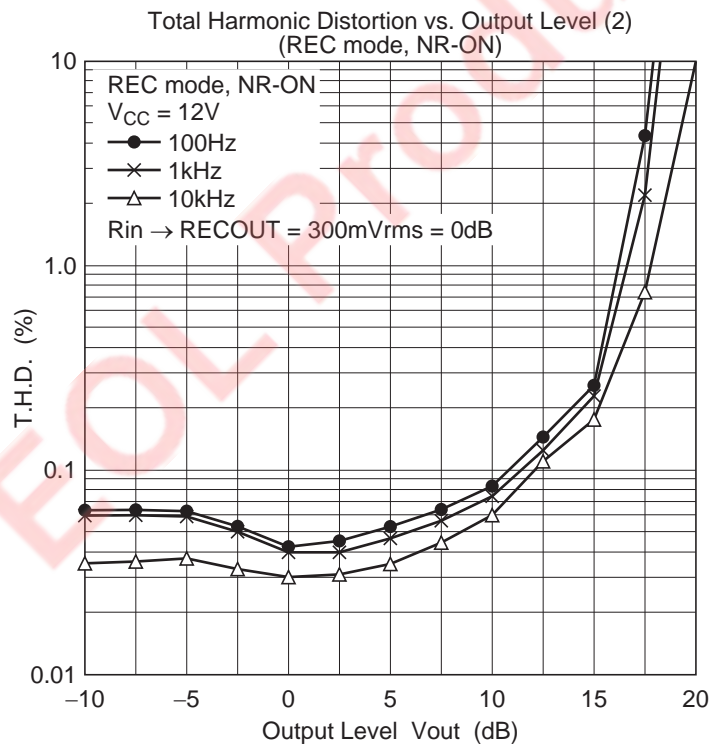
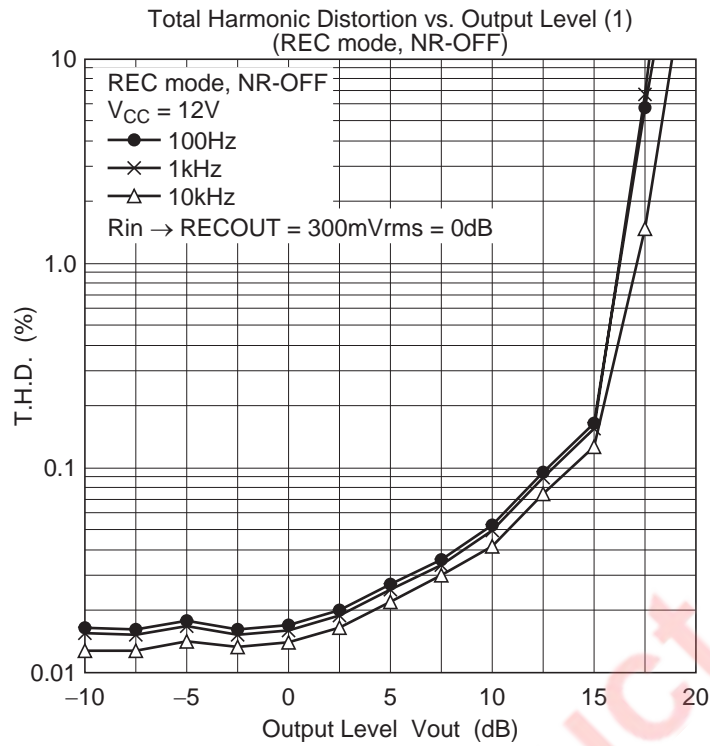

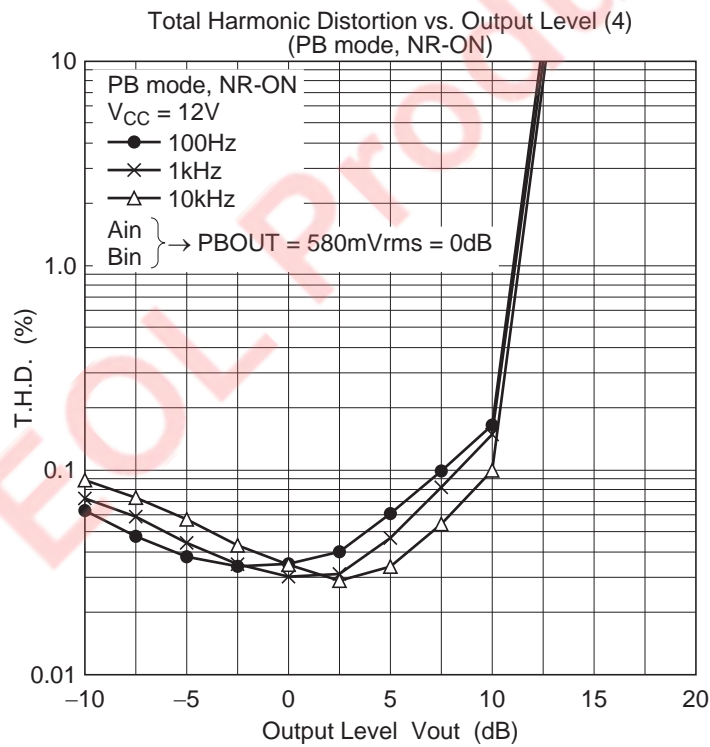
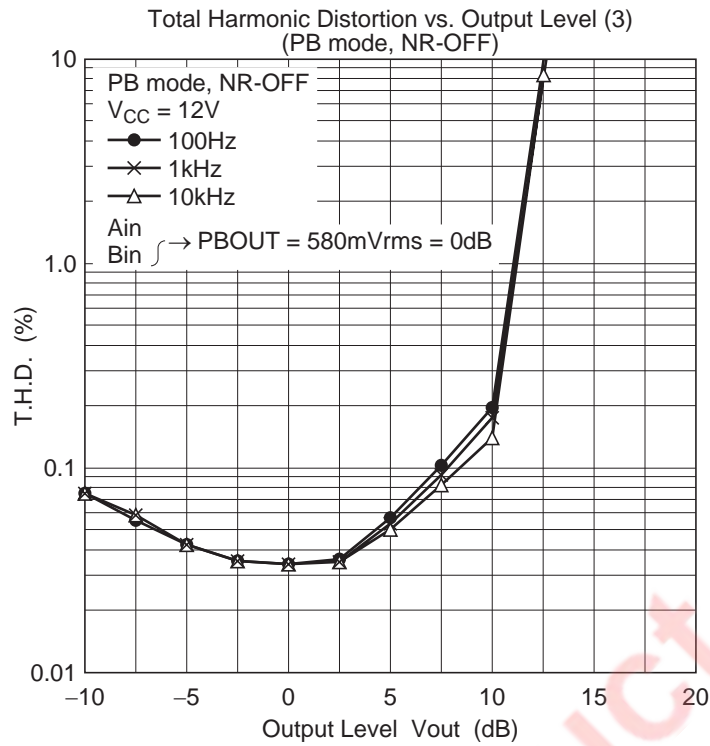

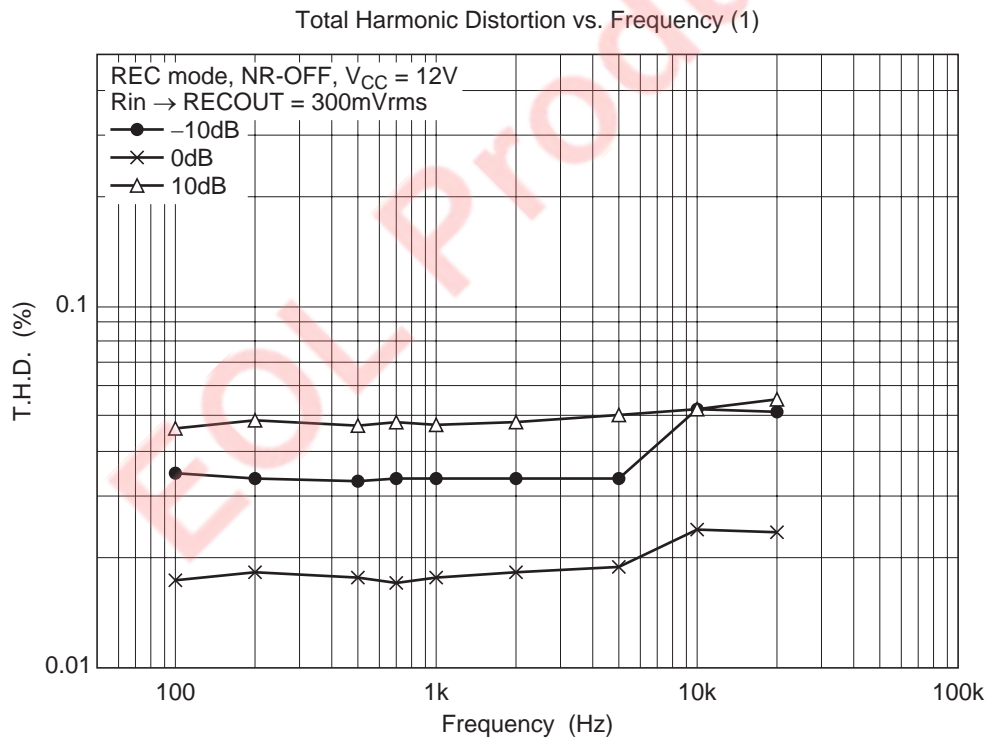
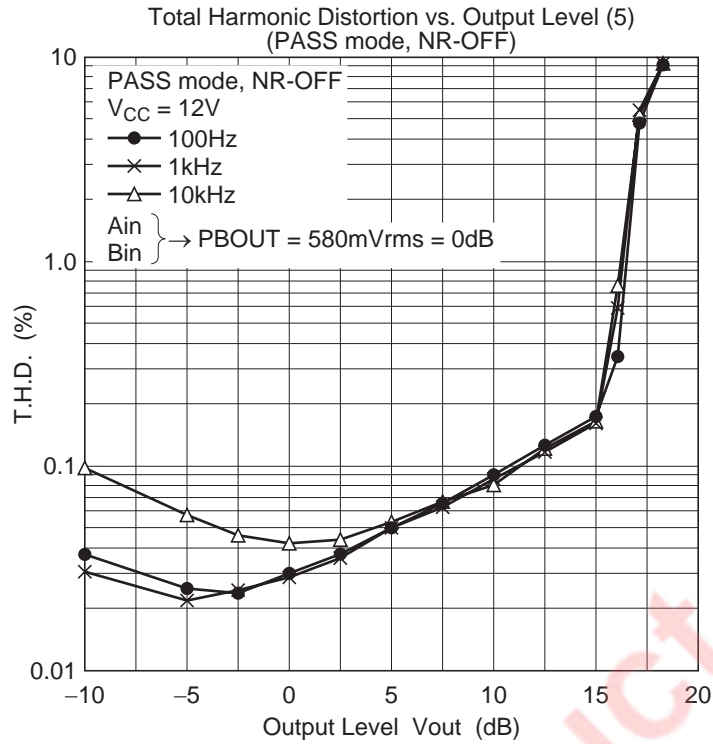

Total Harmonic Distortion vs. Frequency (2)

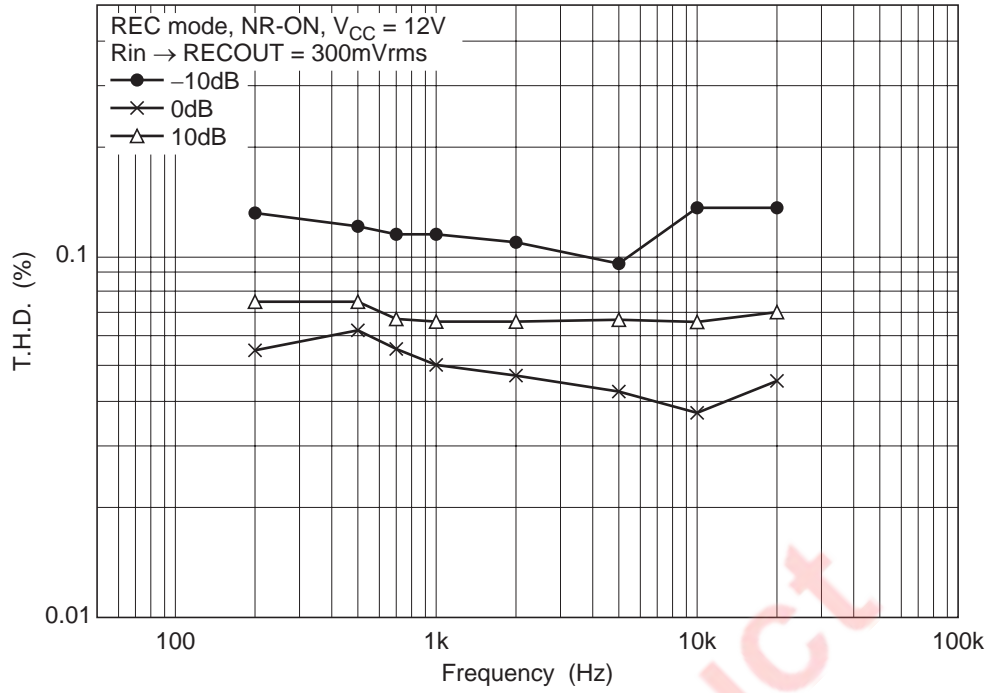

Total Harmonic Distortion vs. Frequency (3)

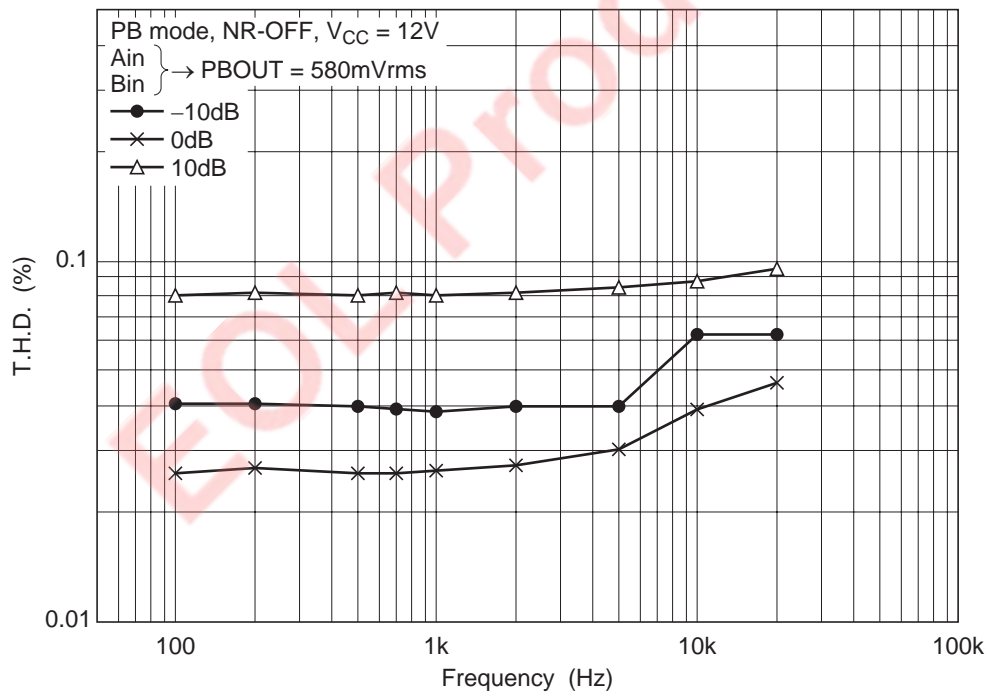

Total Harmonic Distortion vs. Frequency (4)

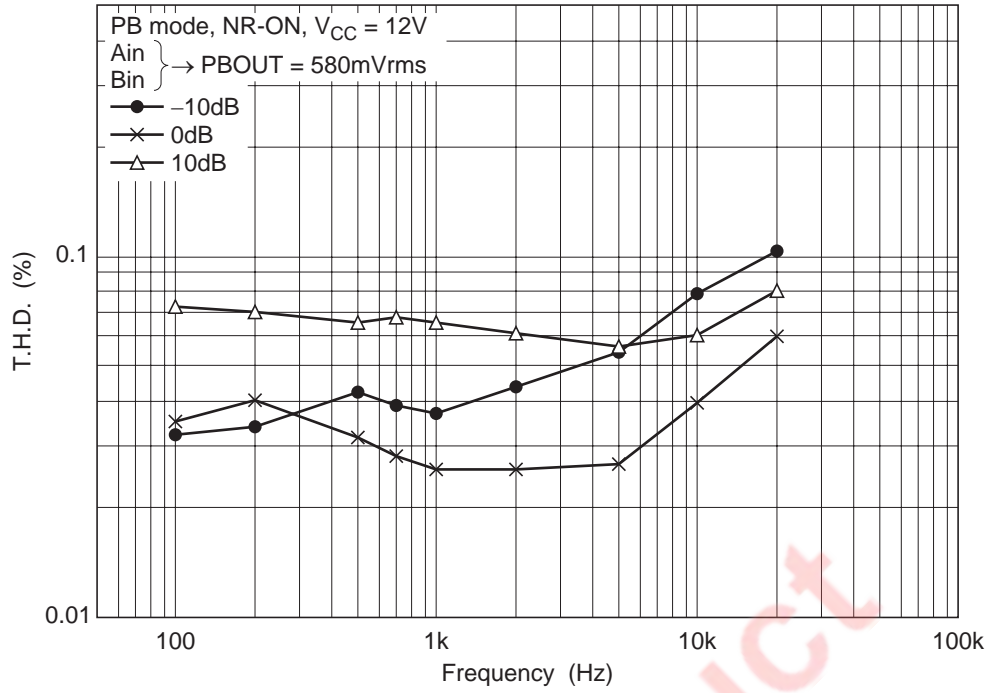

Total Harmonic Distortion vs. Frequency (5)

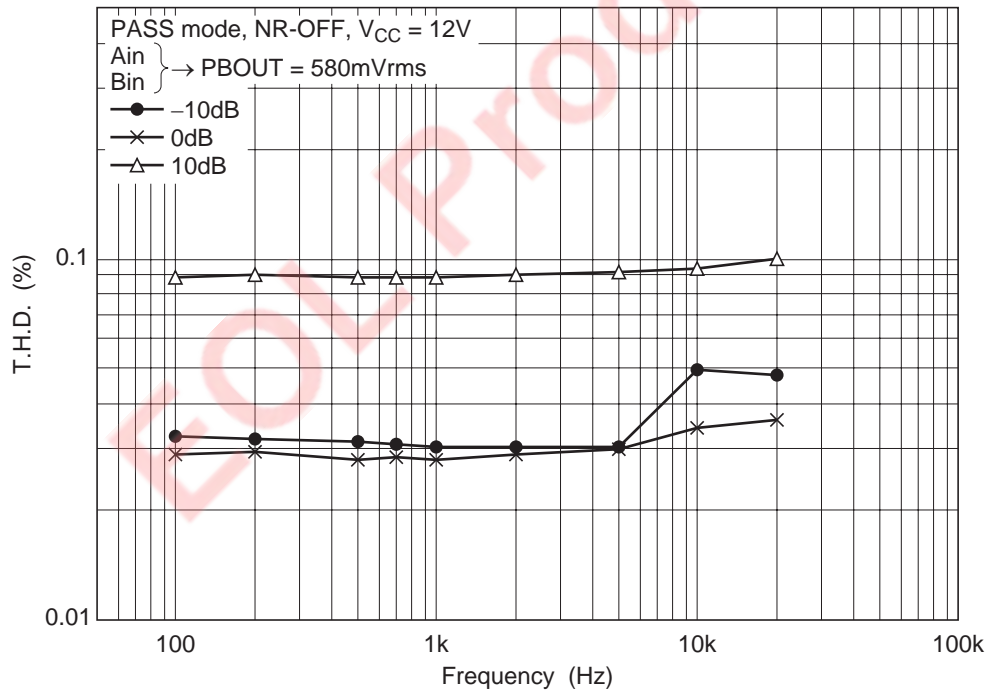

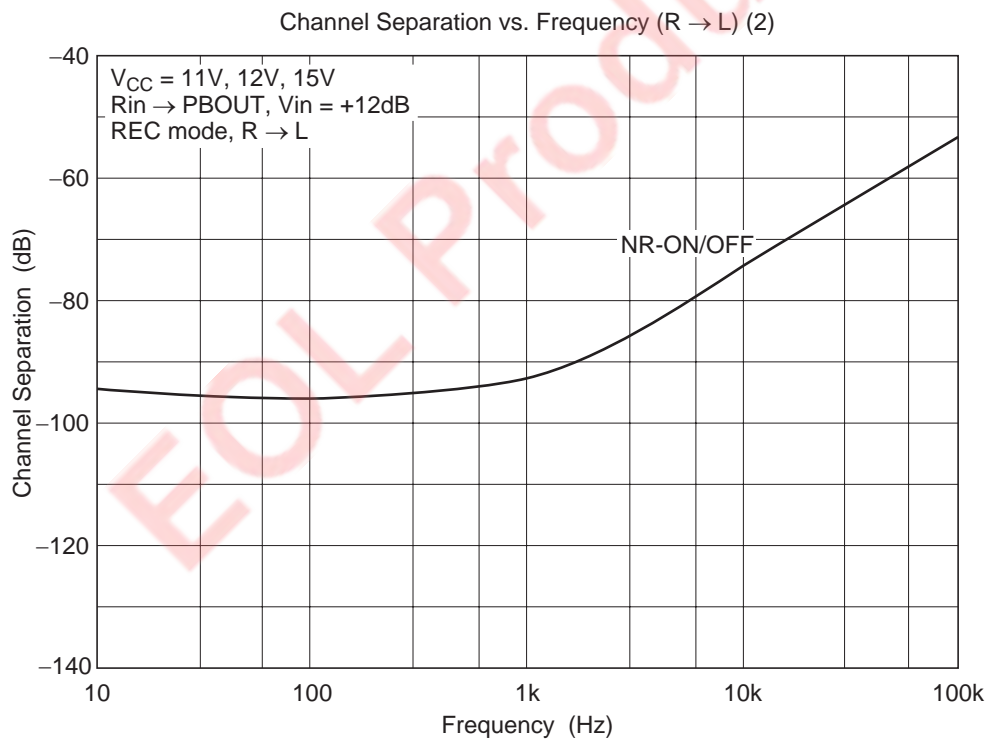
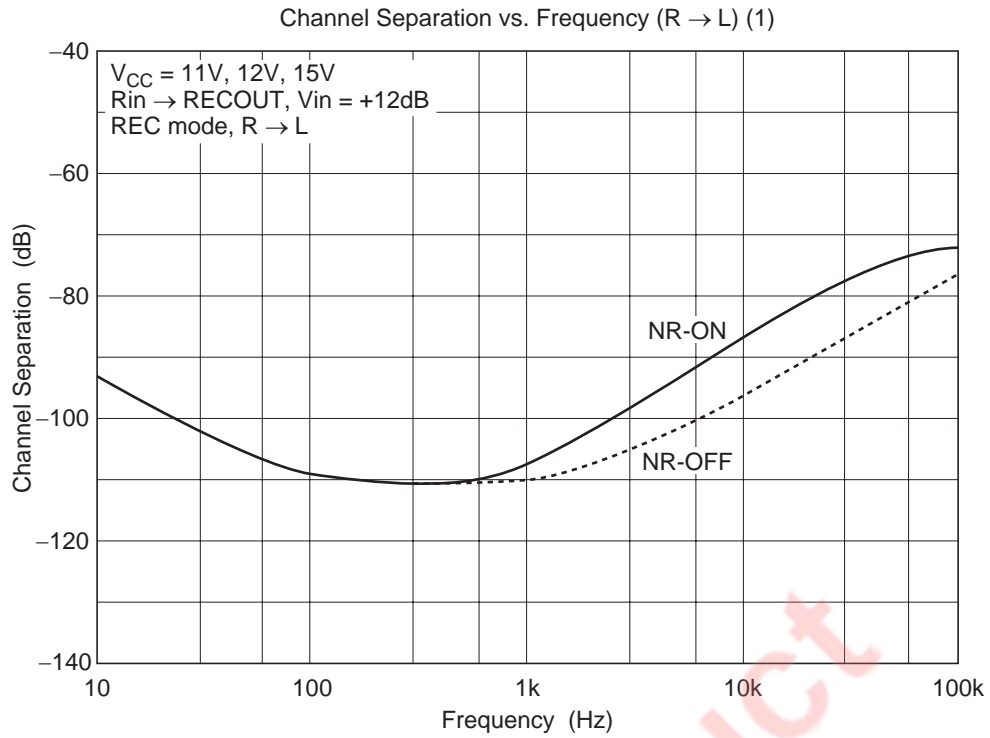

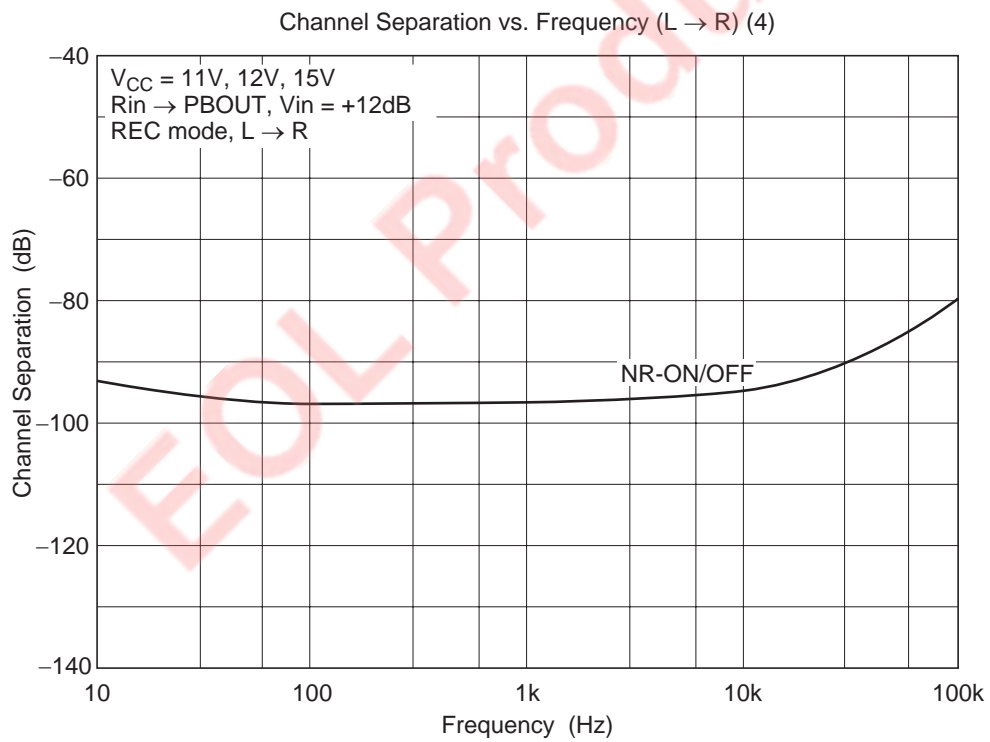
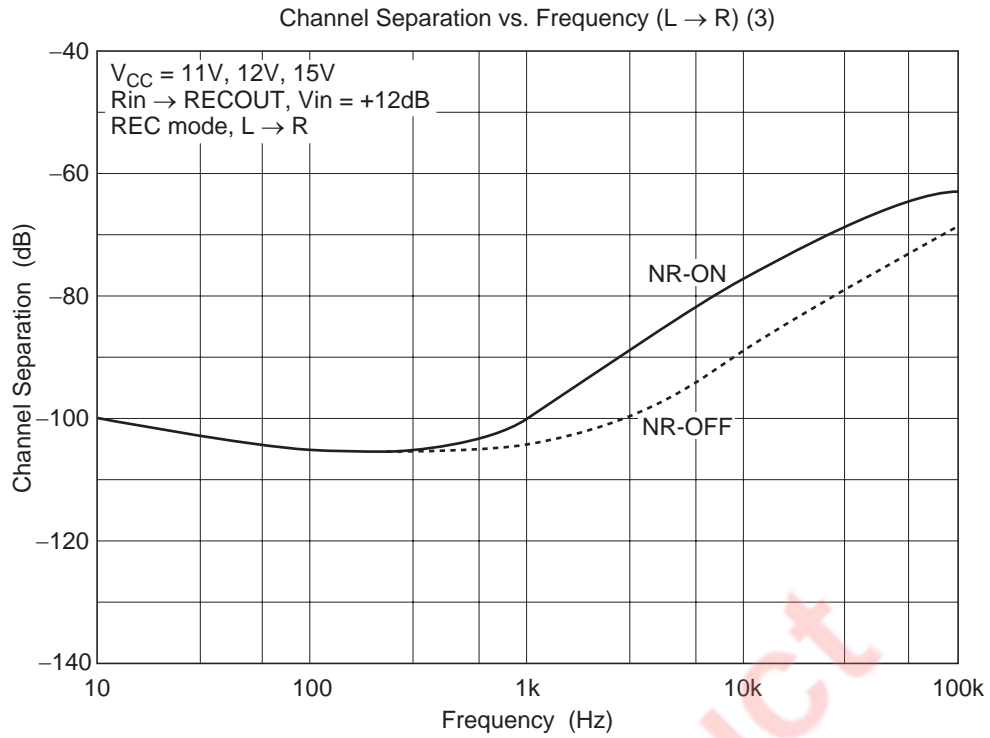

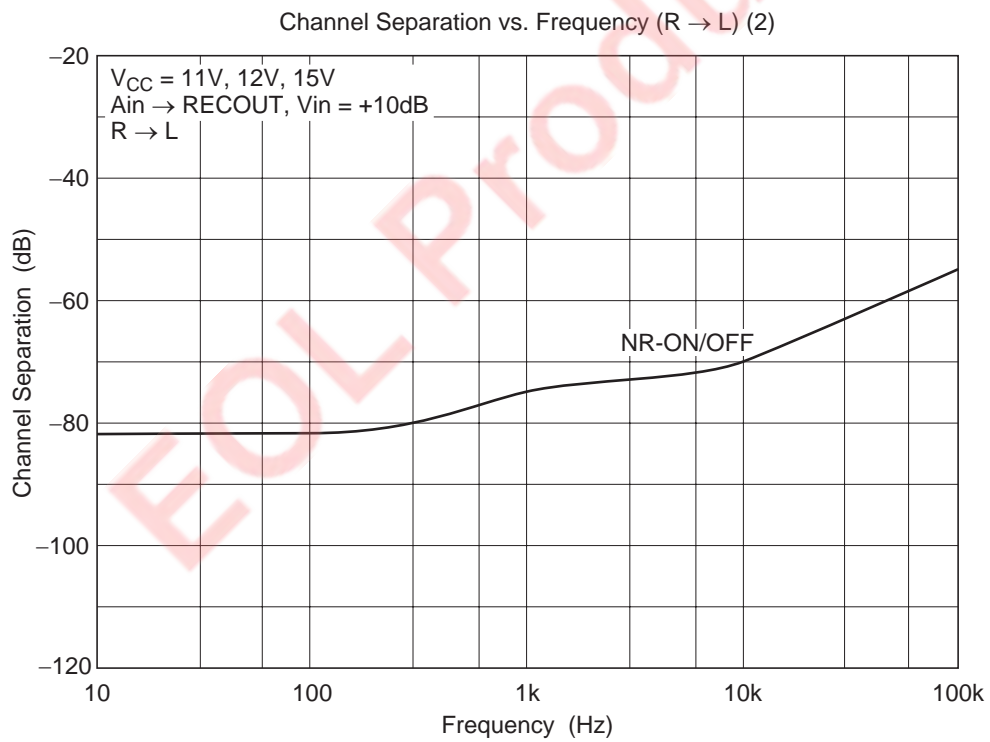
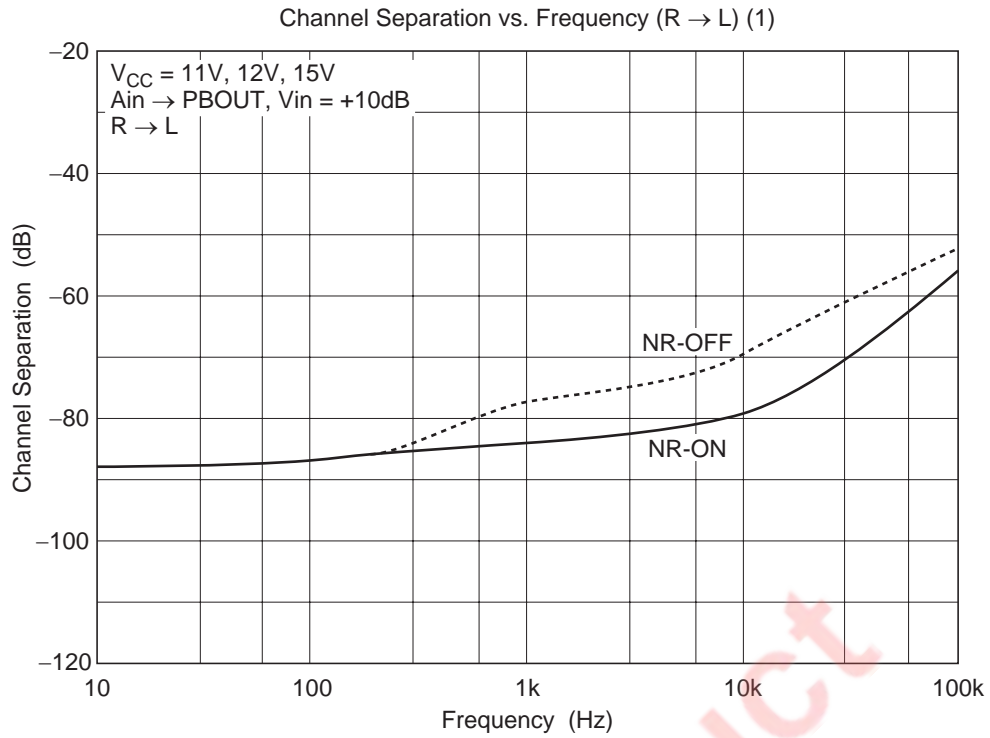

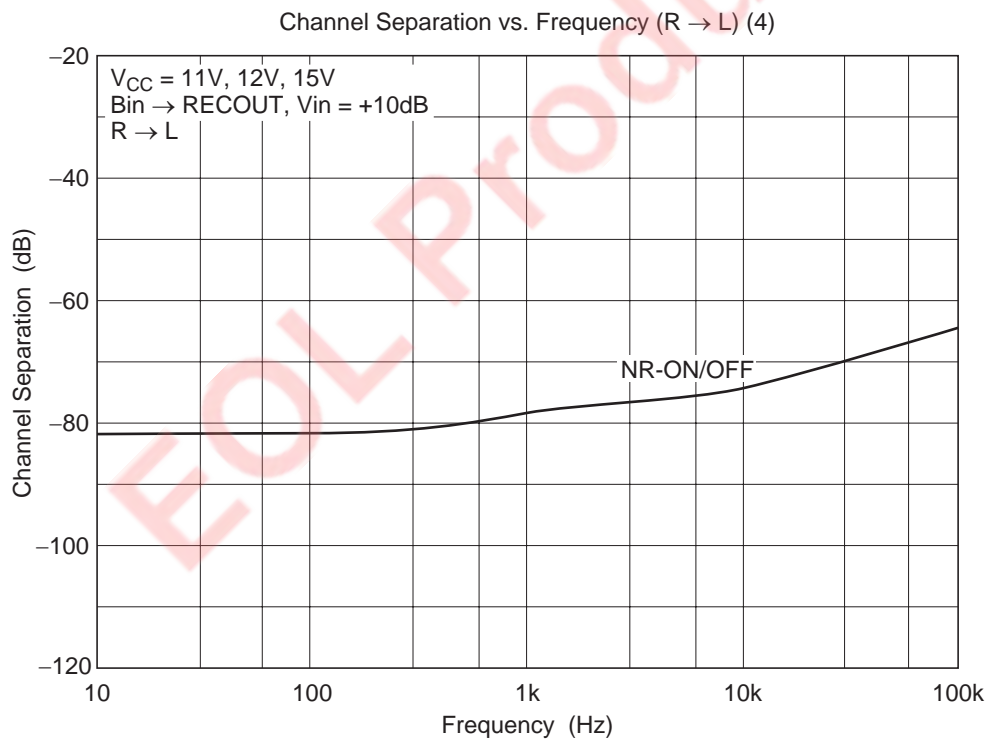
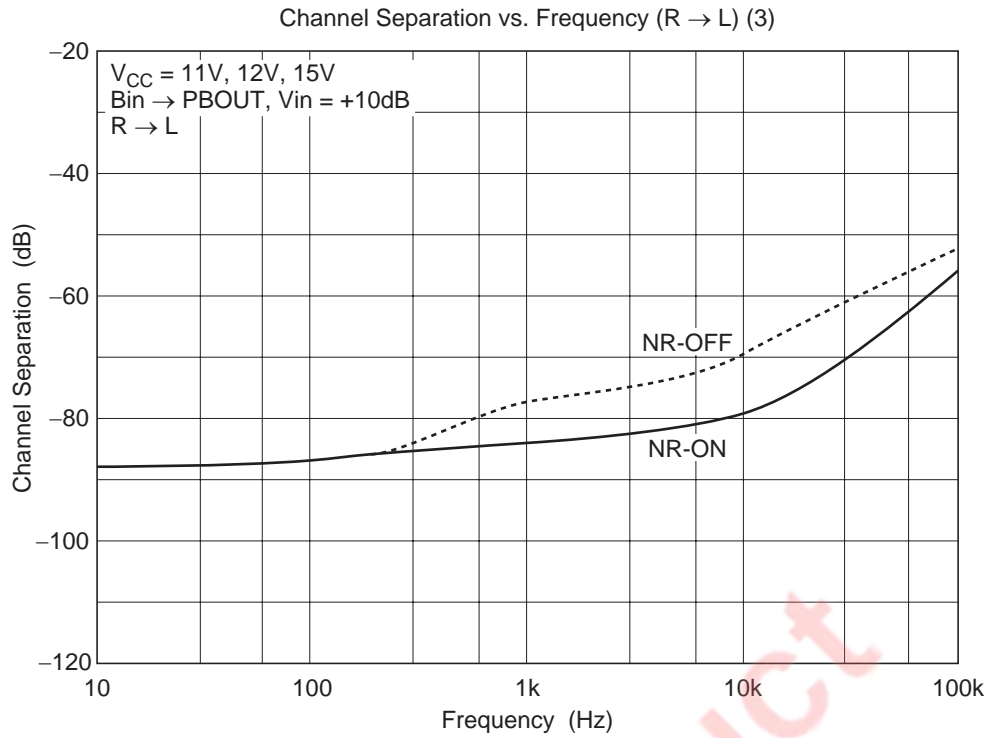

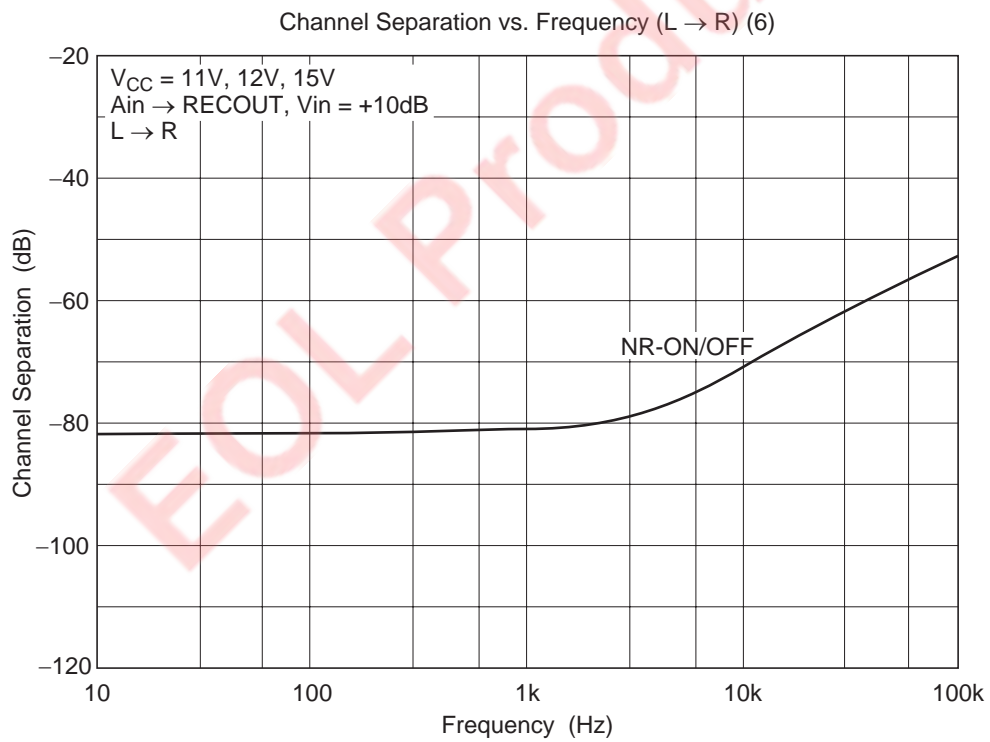
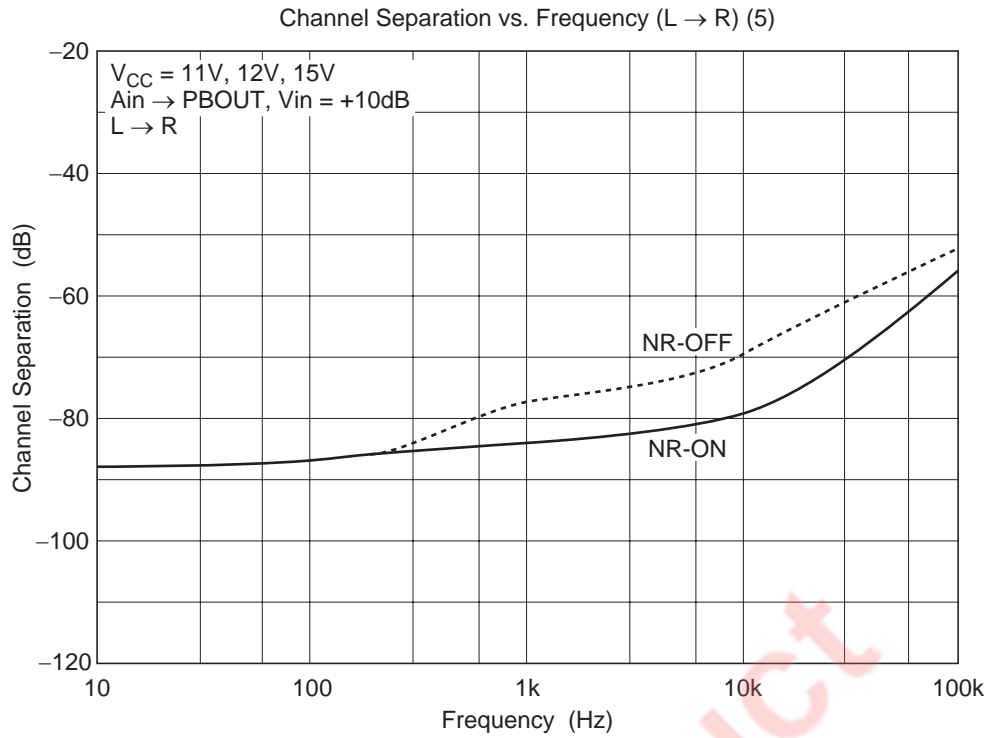

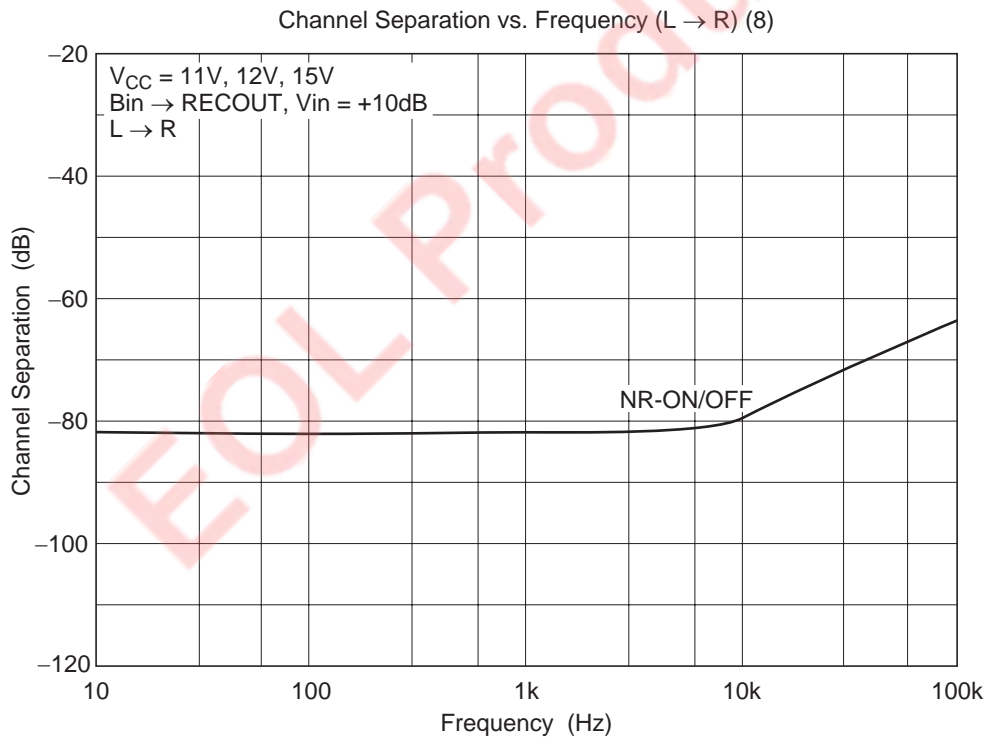
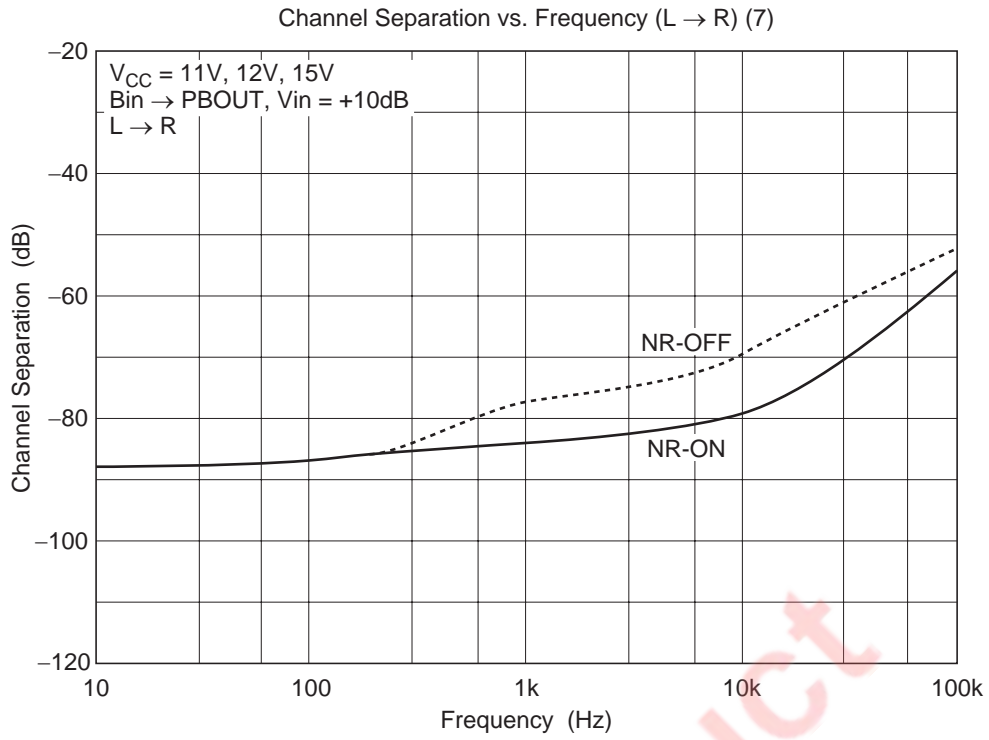

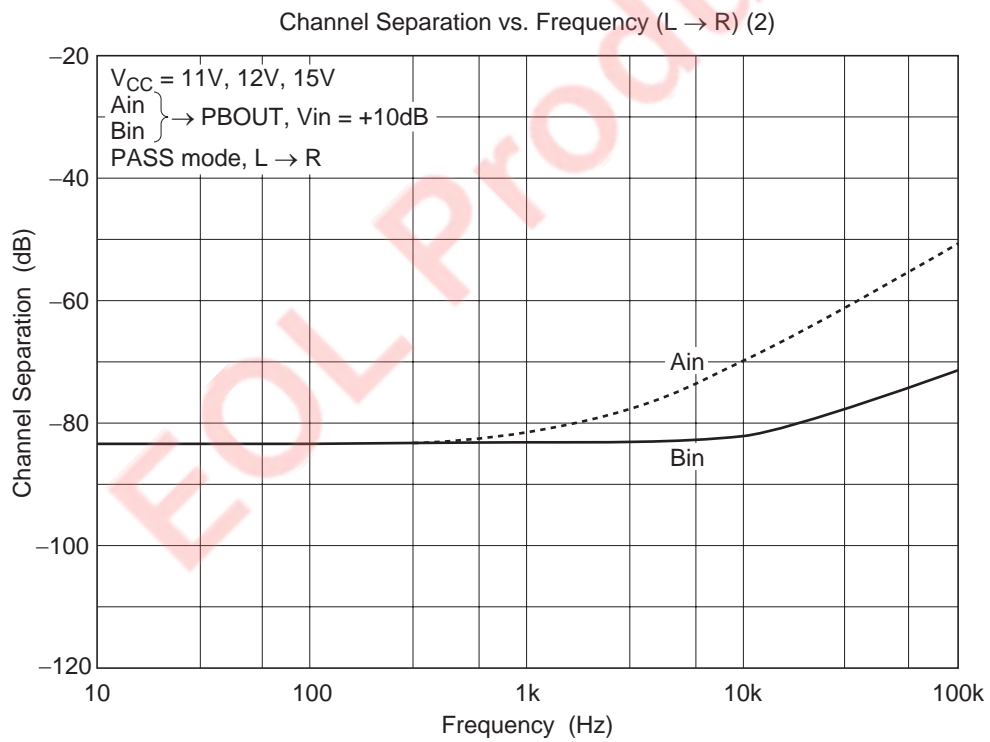
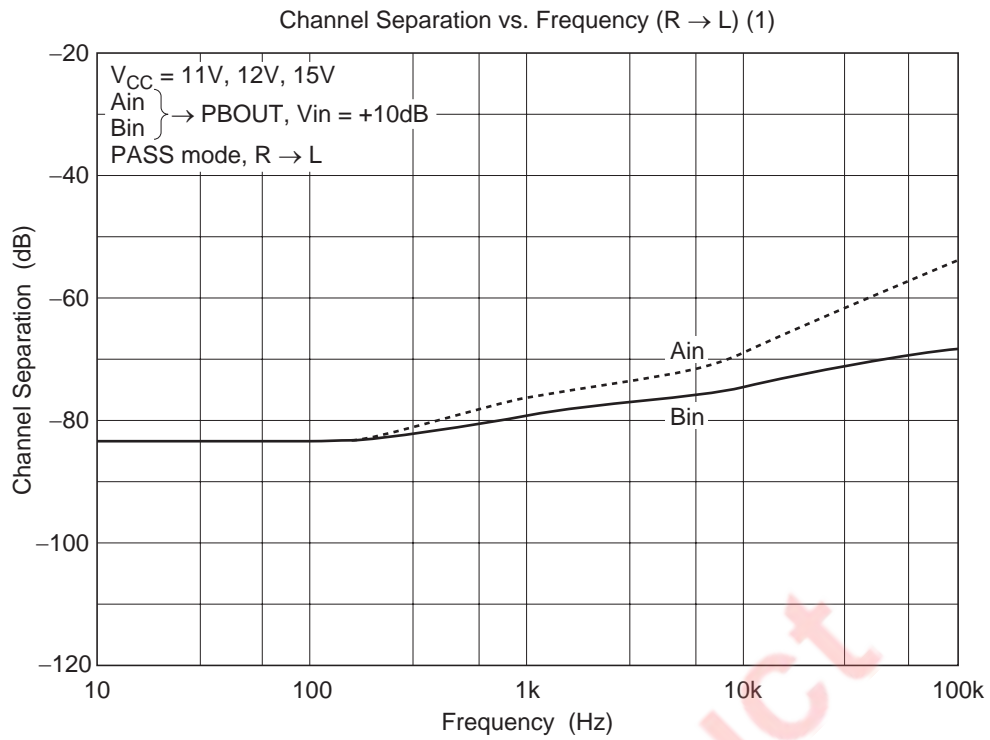

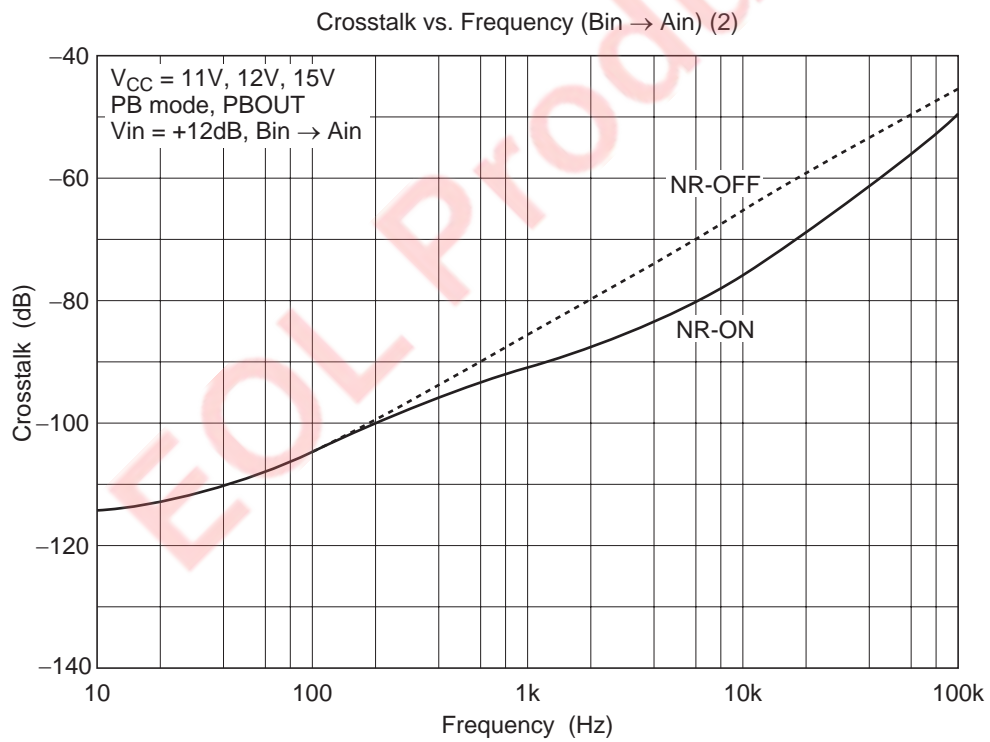
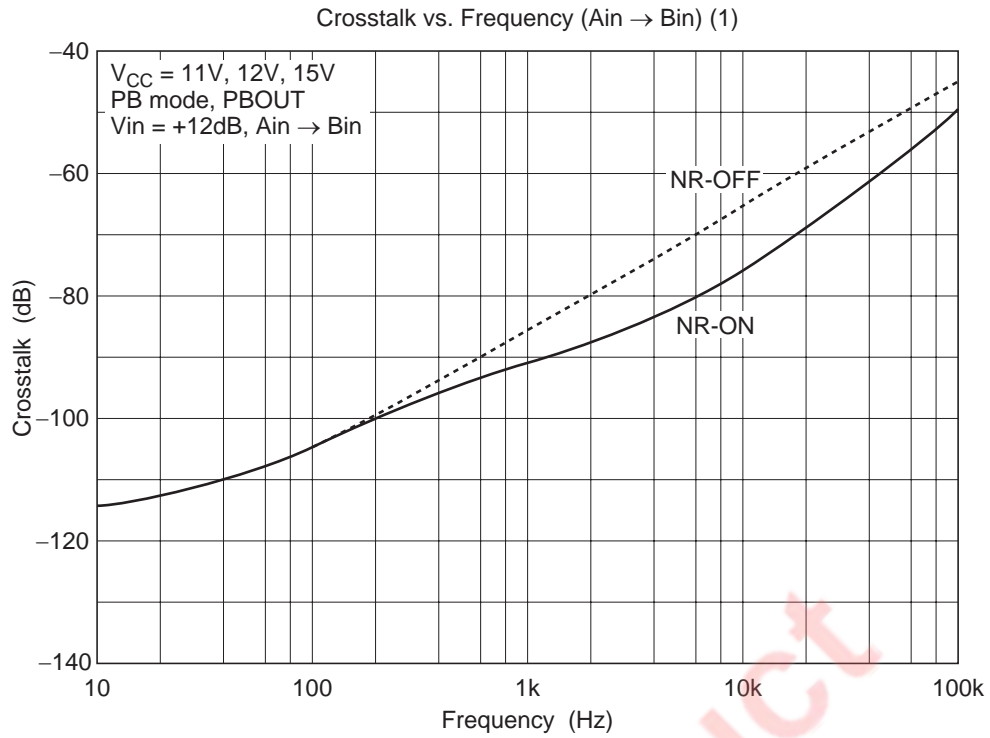

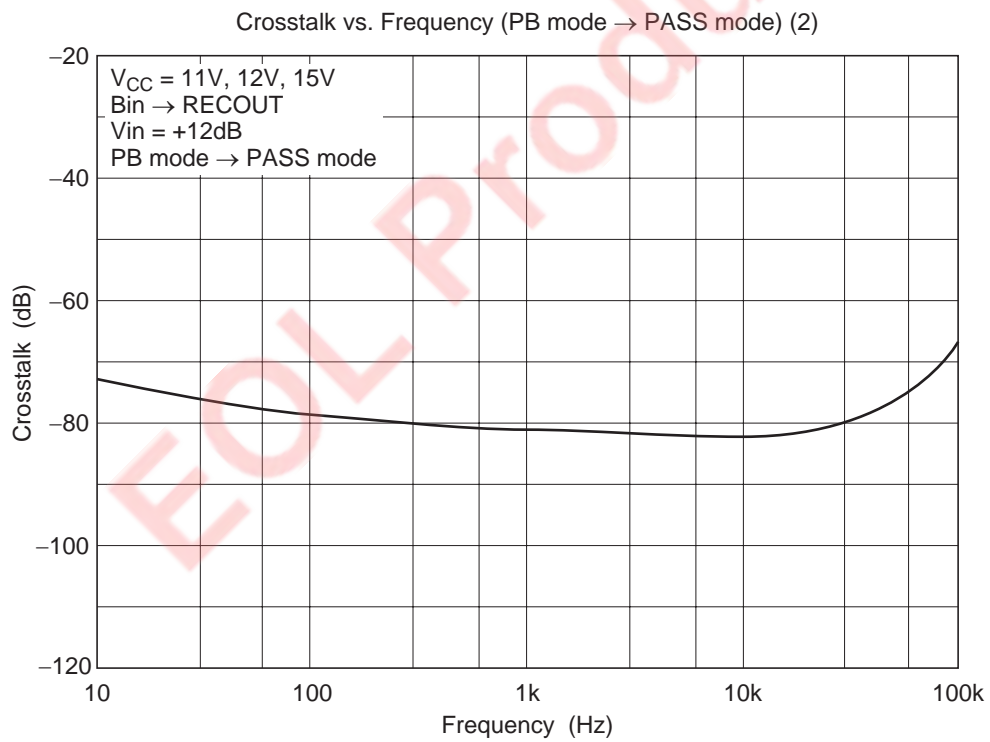
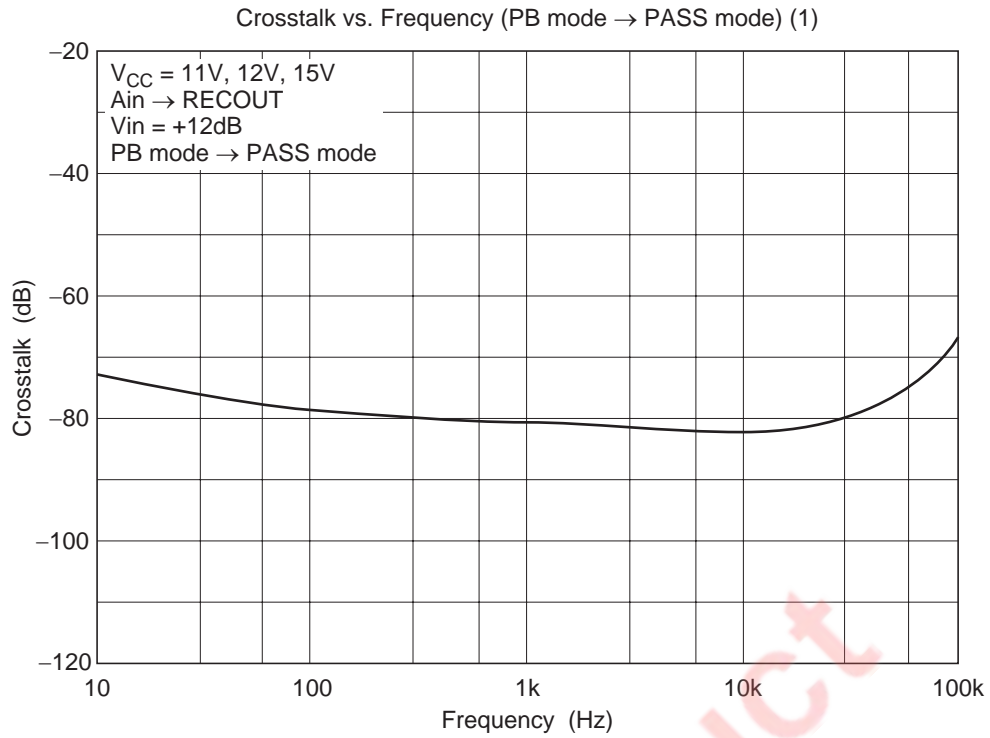

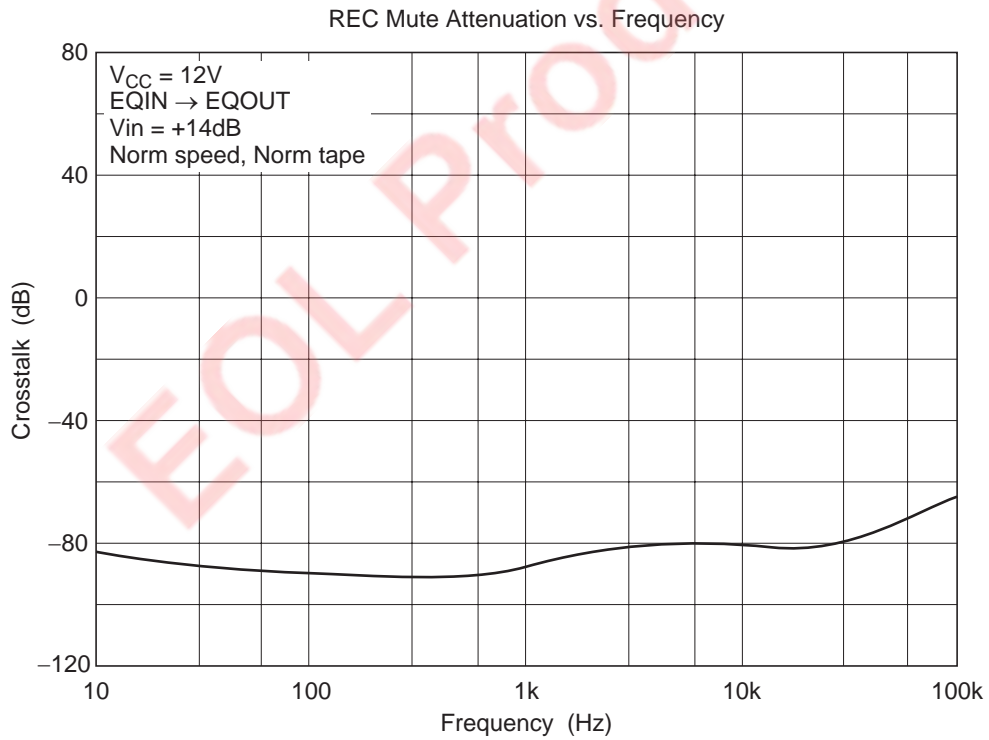
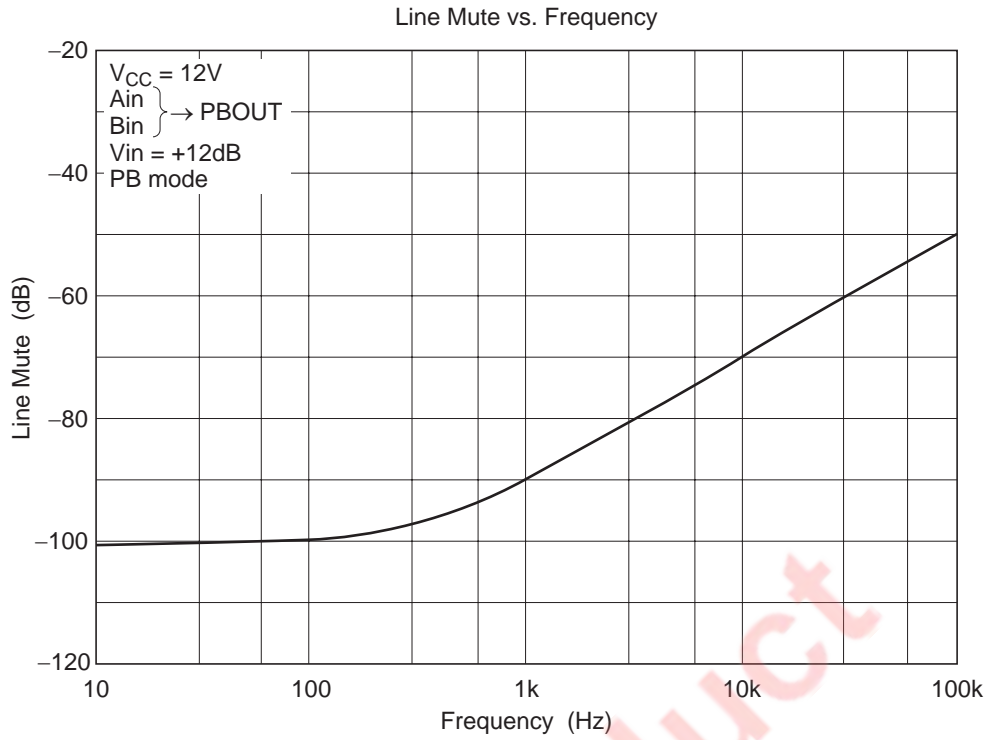

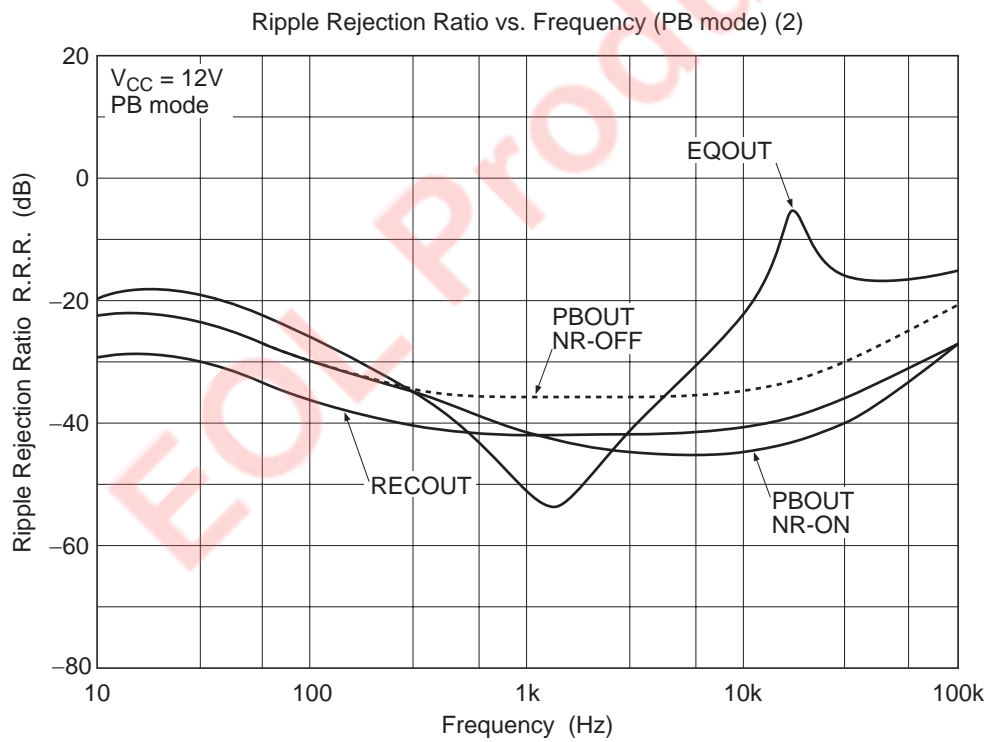
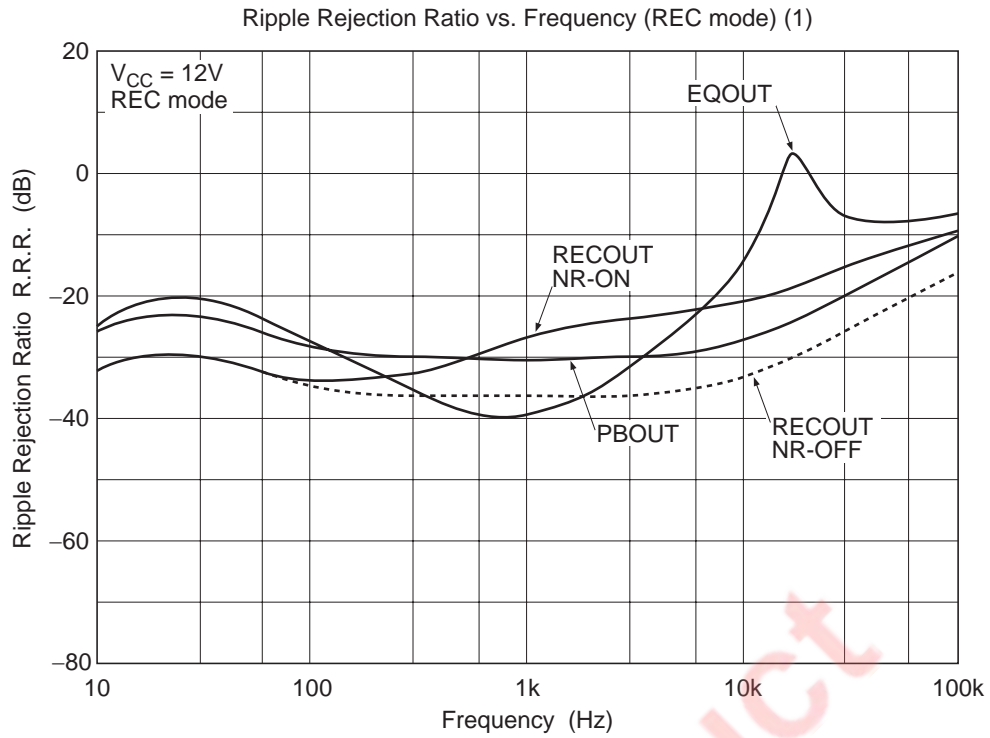

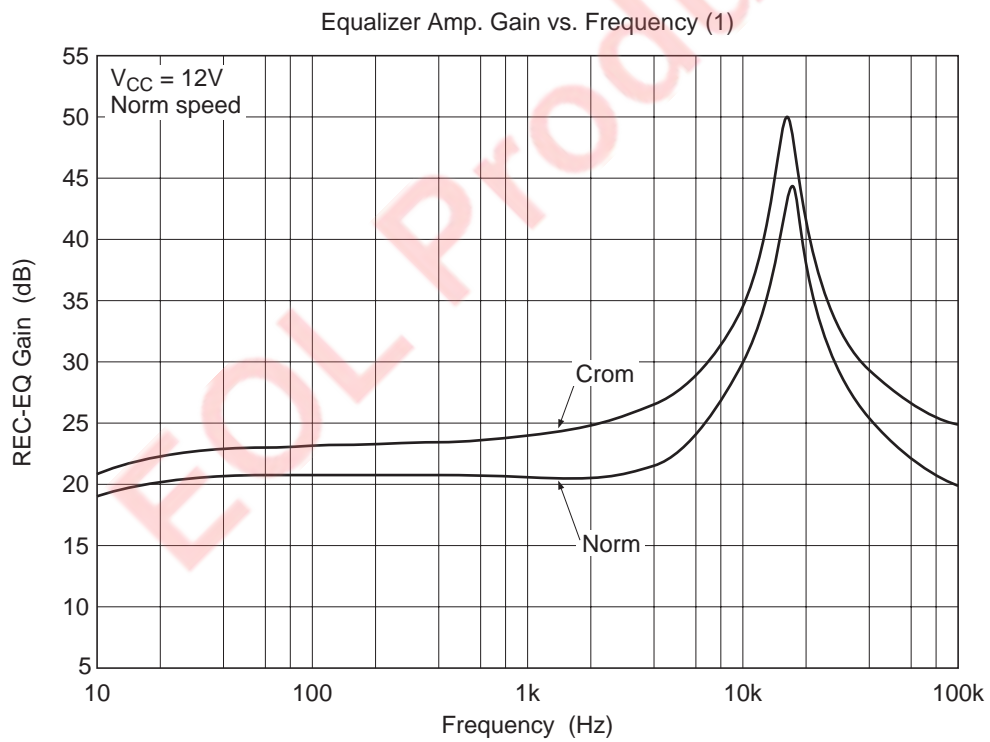
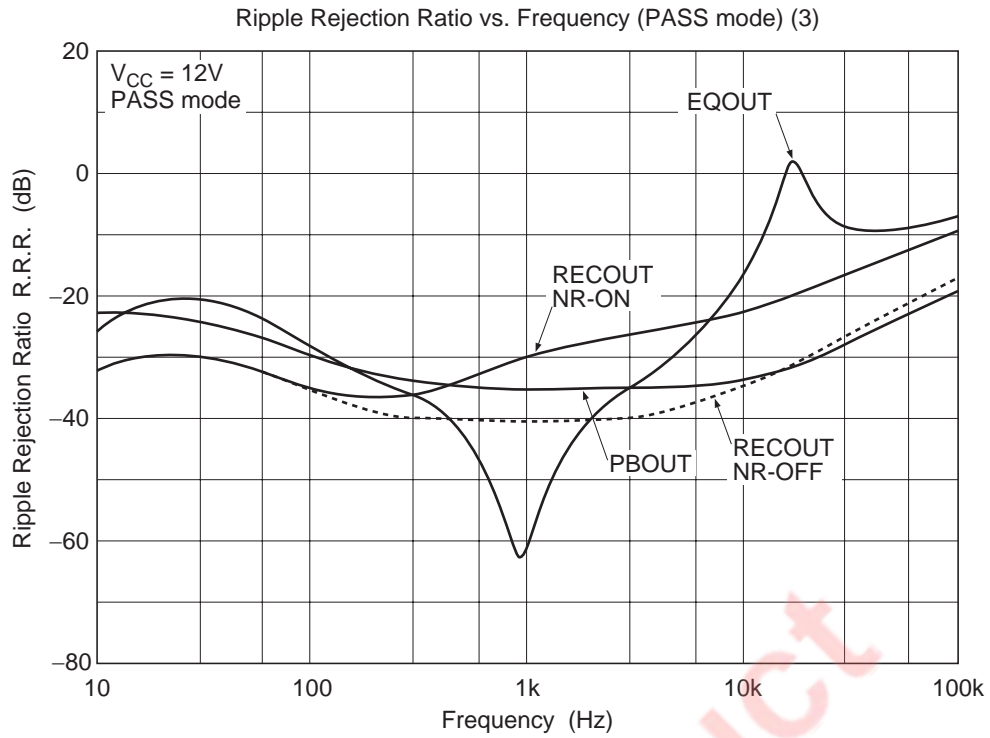

Equalizer Amp. Gain vs. Frequency (2)

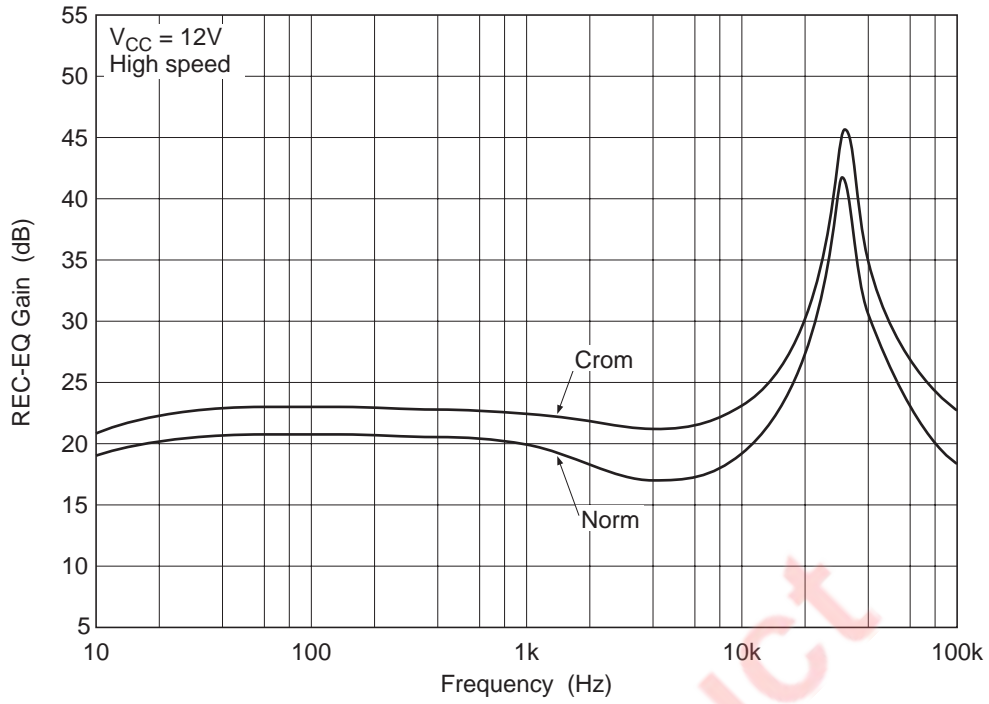

Equalizer Amp. Gain vs. Frequency (REC-cal)

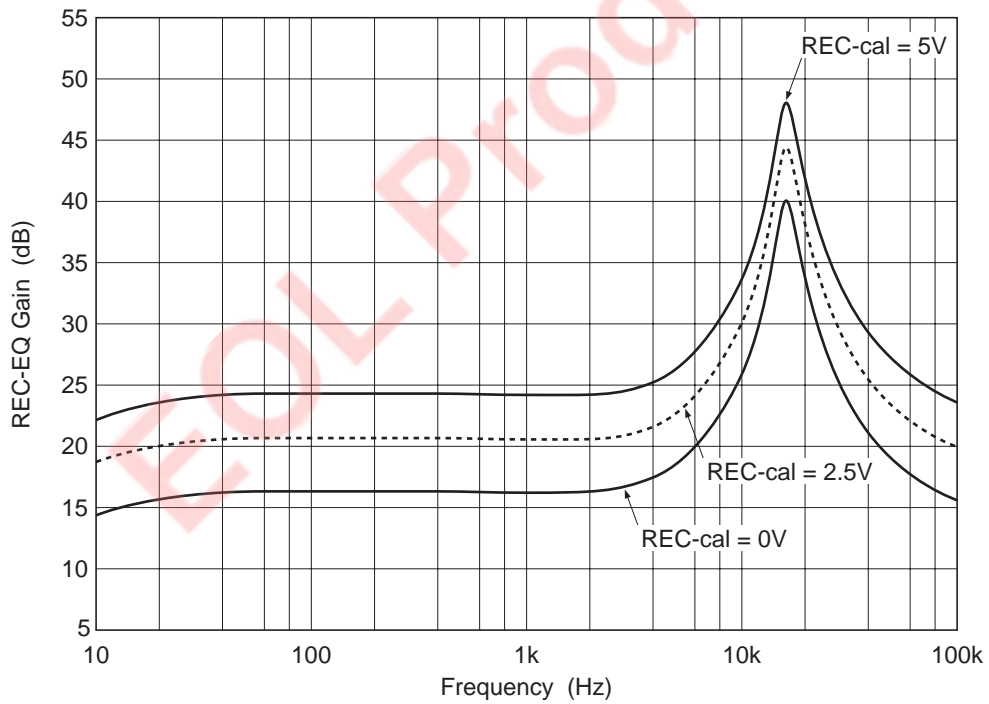

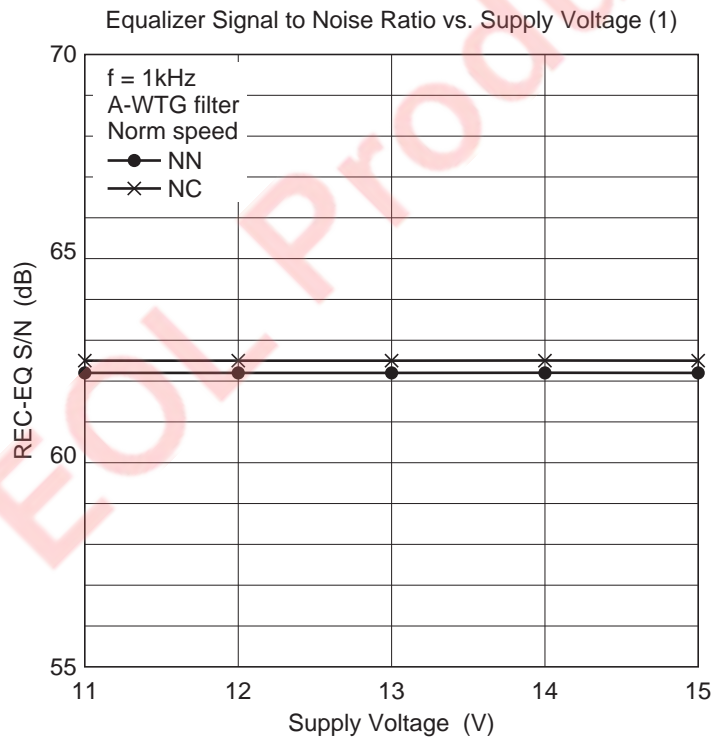
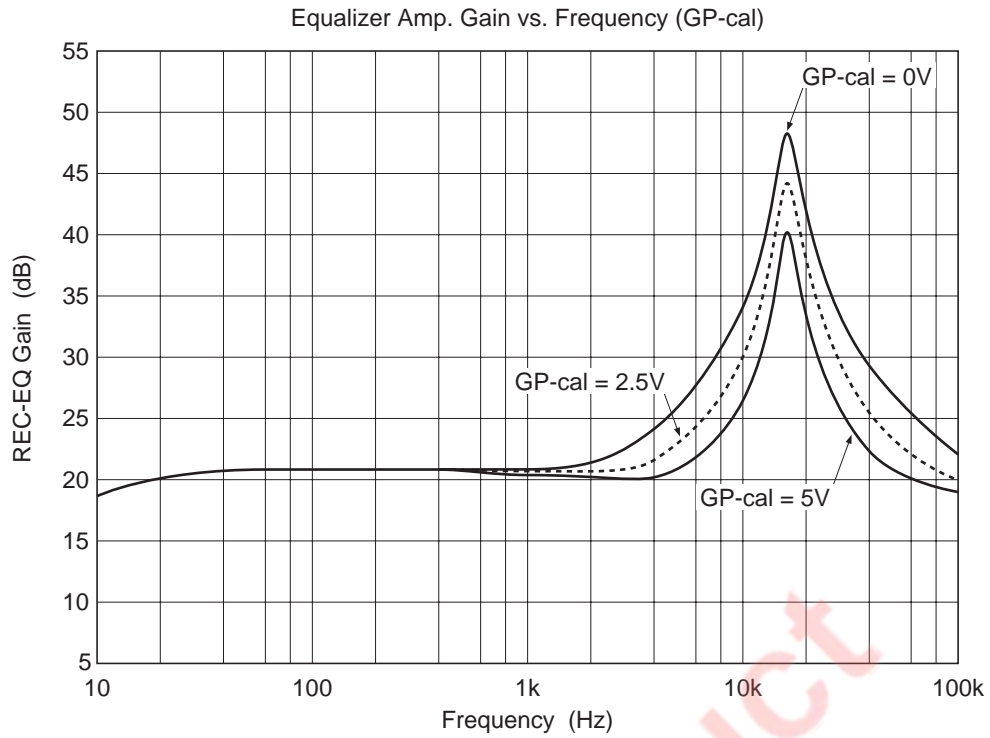

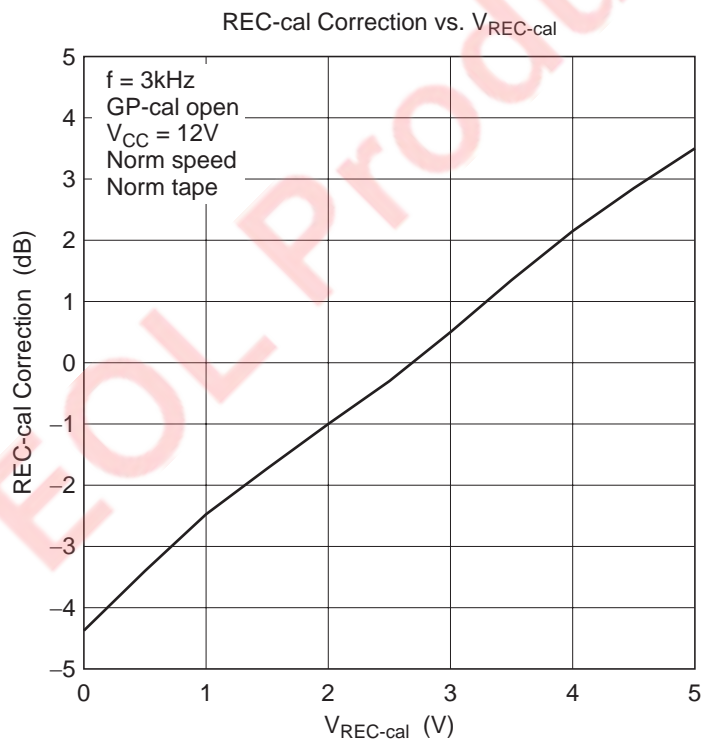
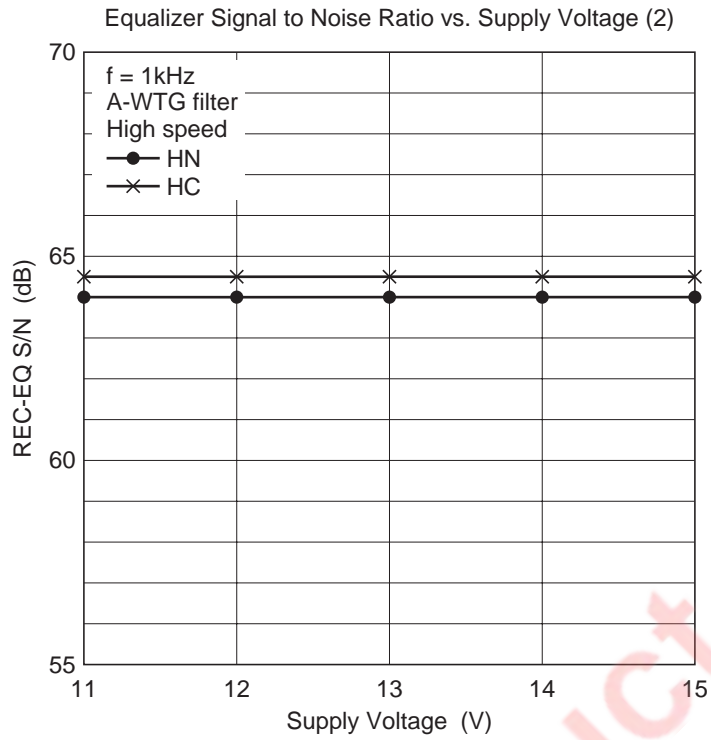

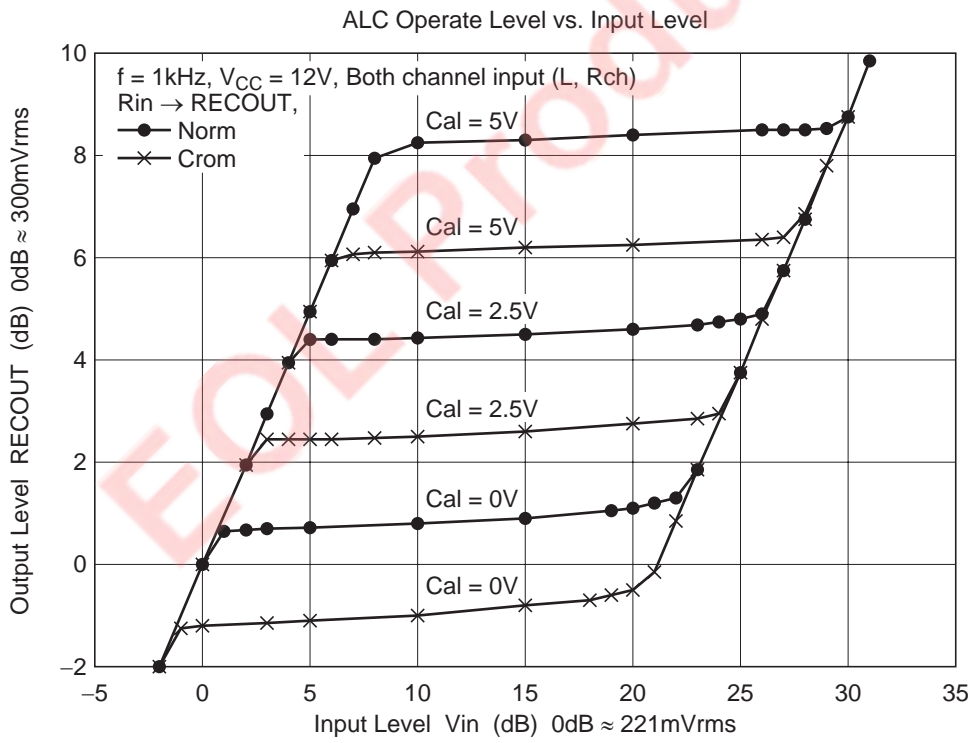
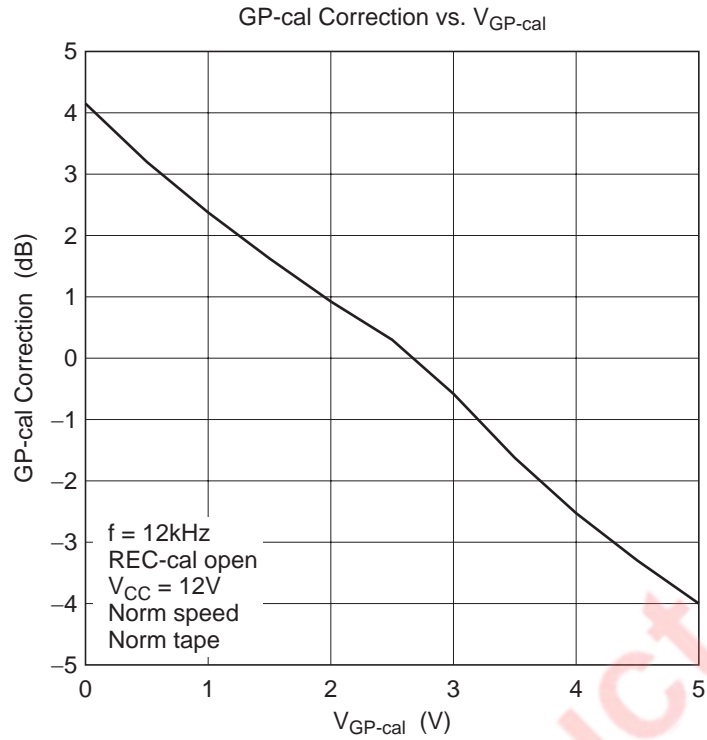

ALC Total Harmonic Distortion vs. Input Level (1)

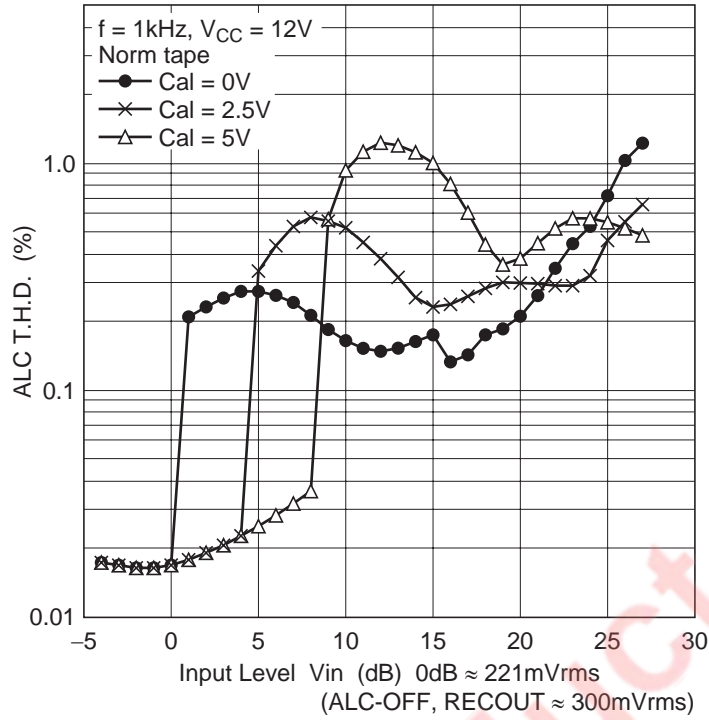

ALC Total Harmonic Distortion vs. Input Level (2)

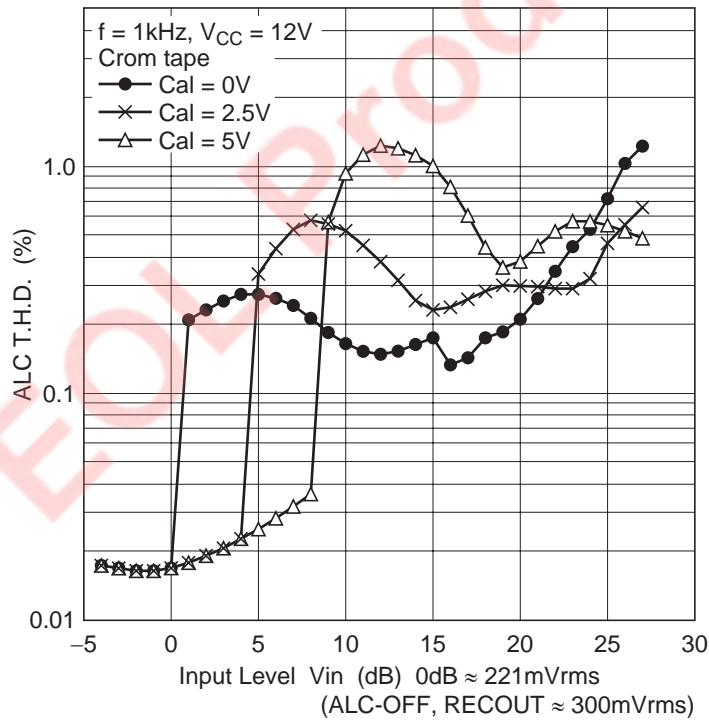

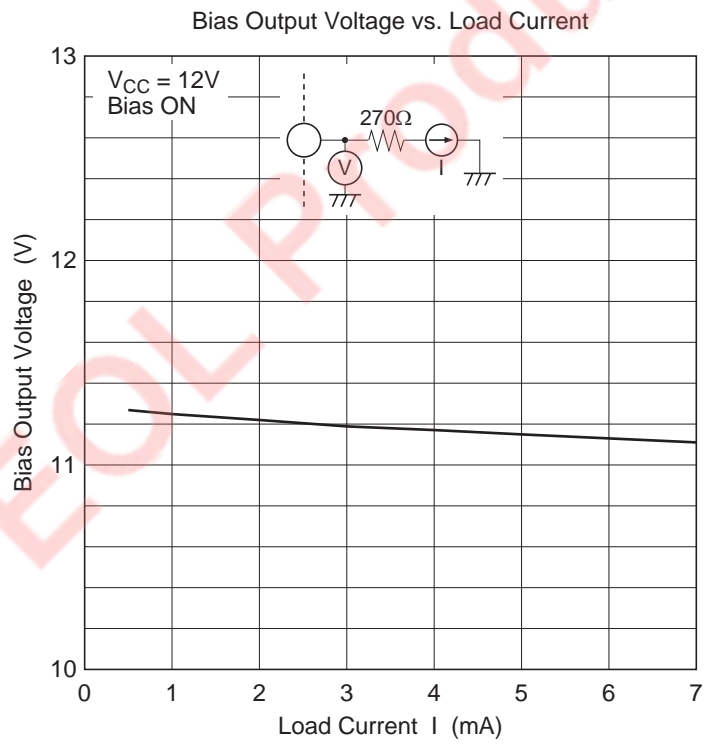
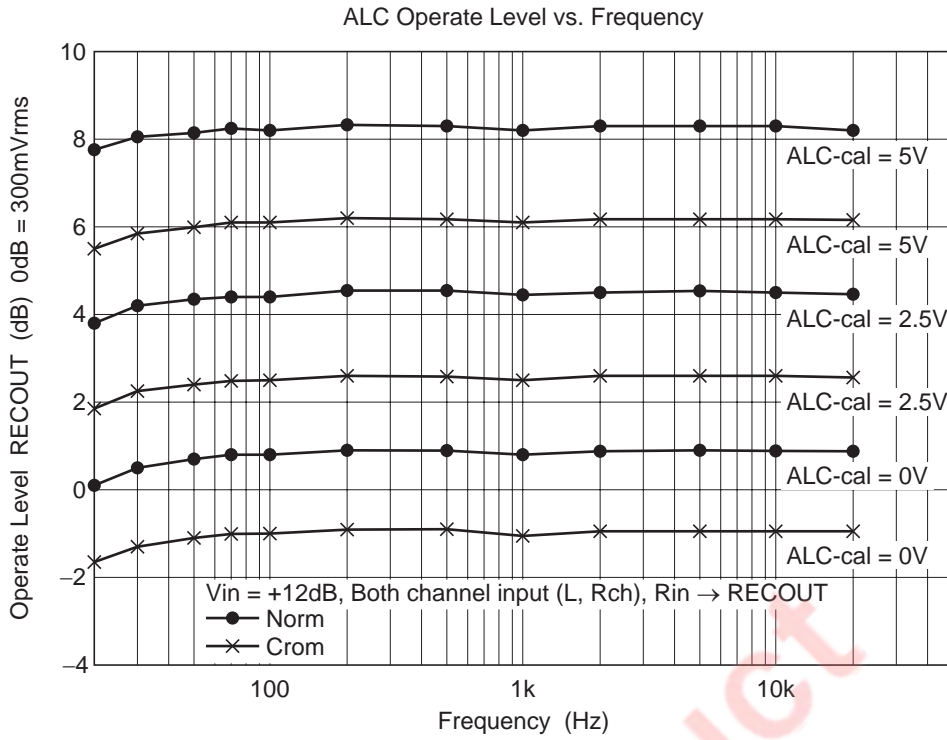

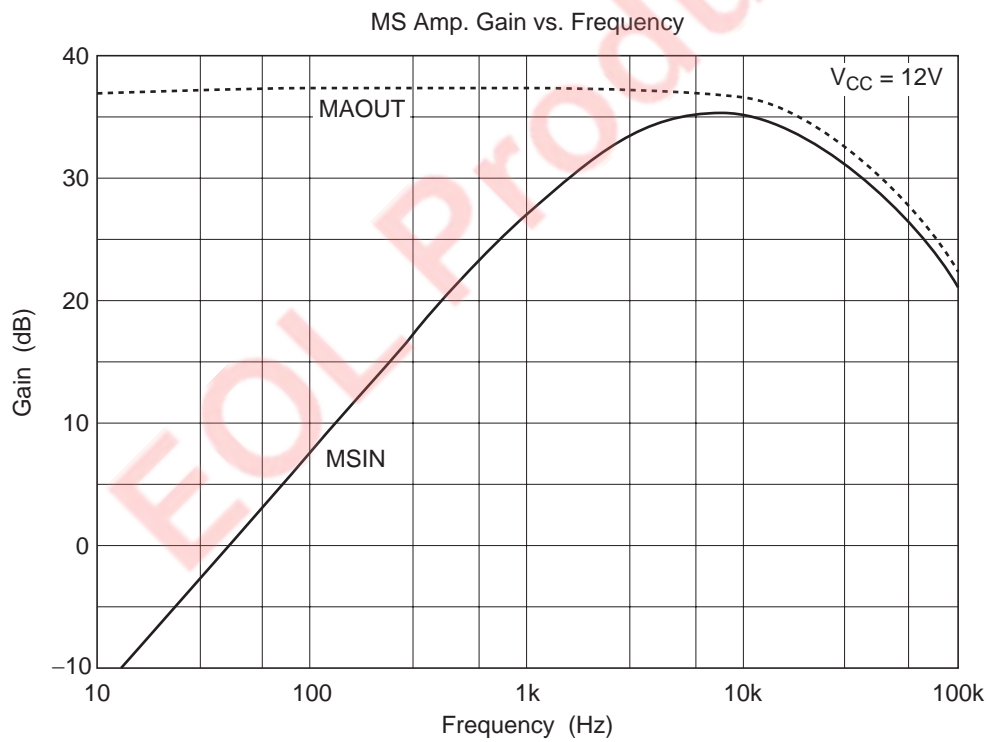
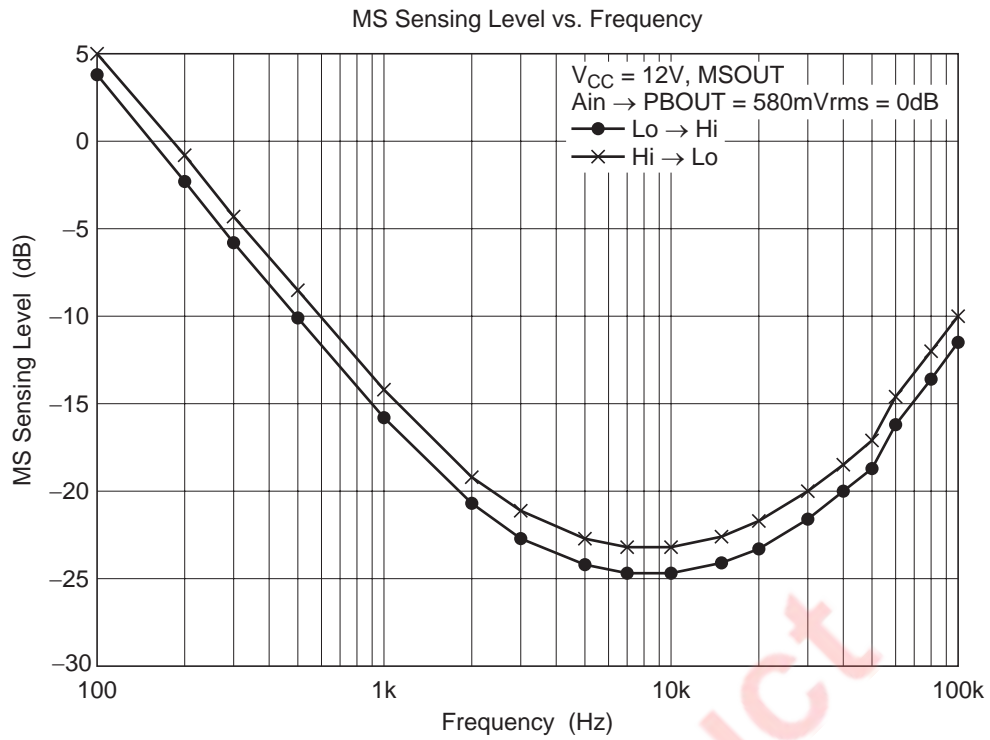

No-Signal Sensing Time vs. Resistance

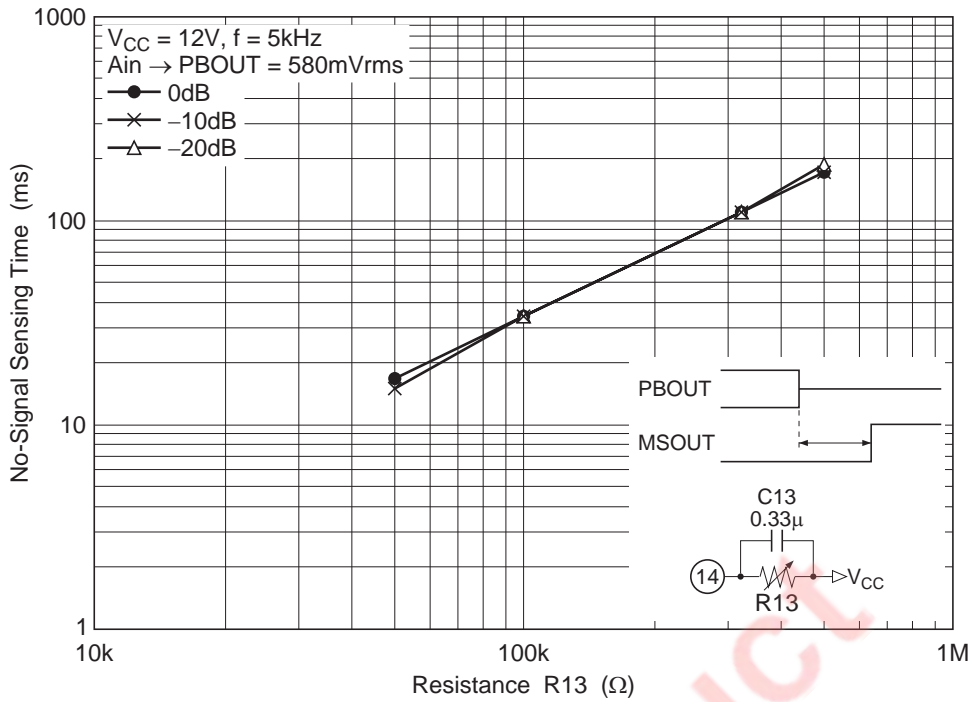

Signal Sensing Time vs. Capacitance

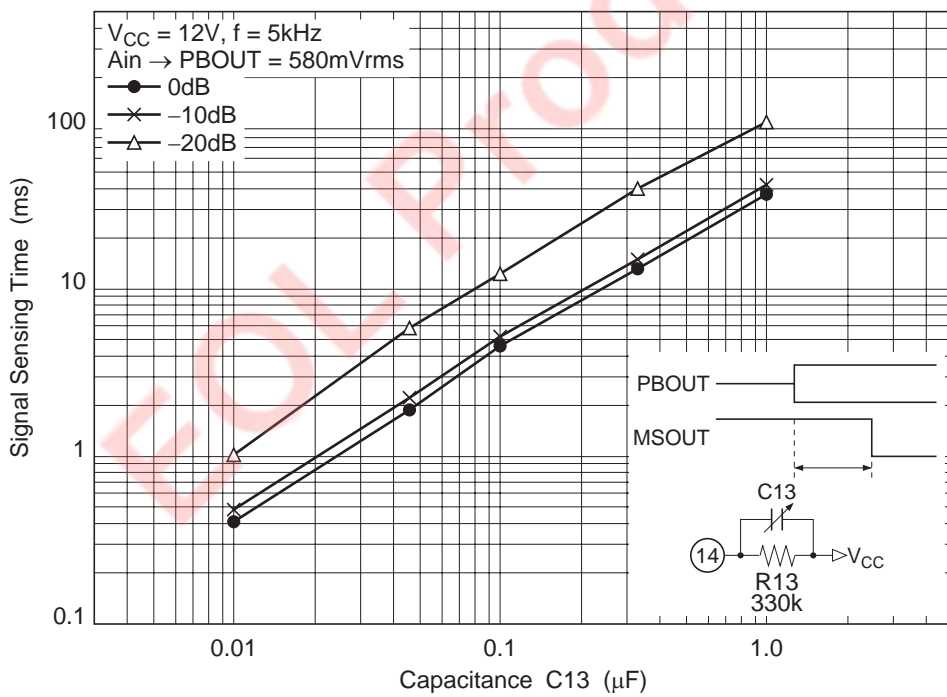

HA12227F

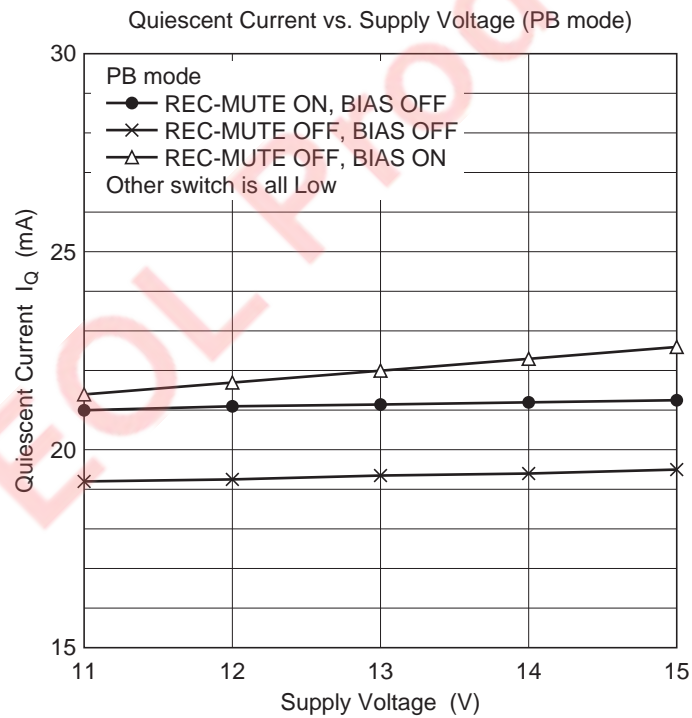
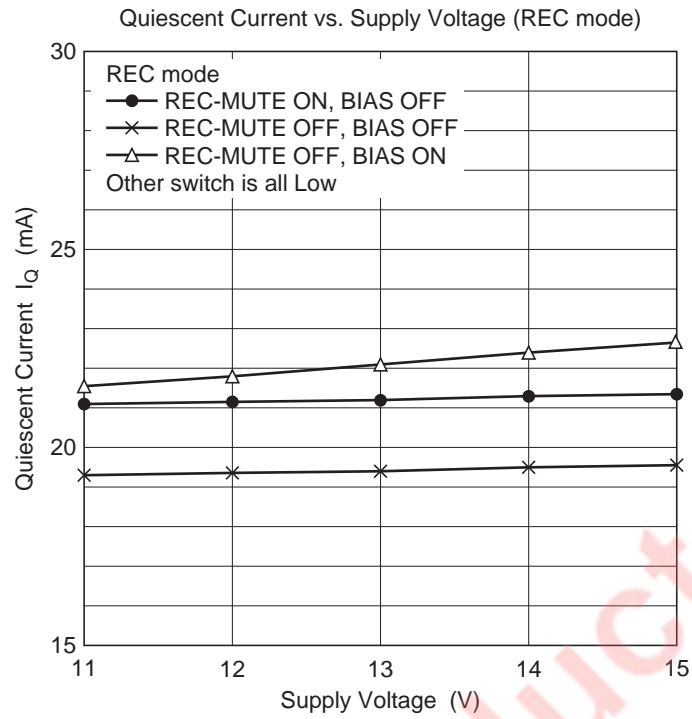

Input Amp. Gain vs. Frequency (1)

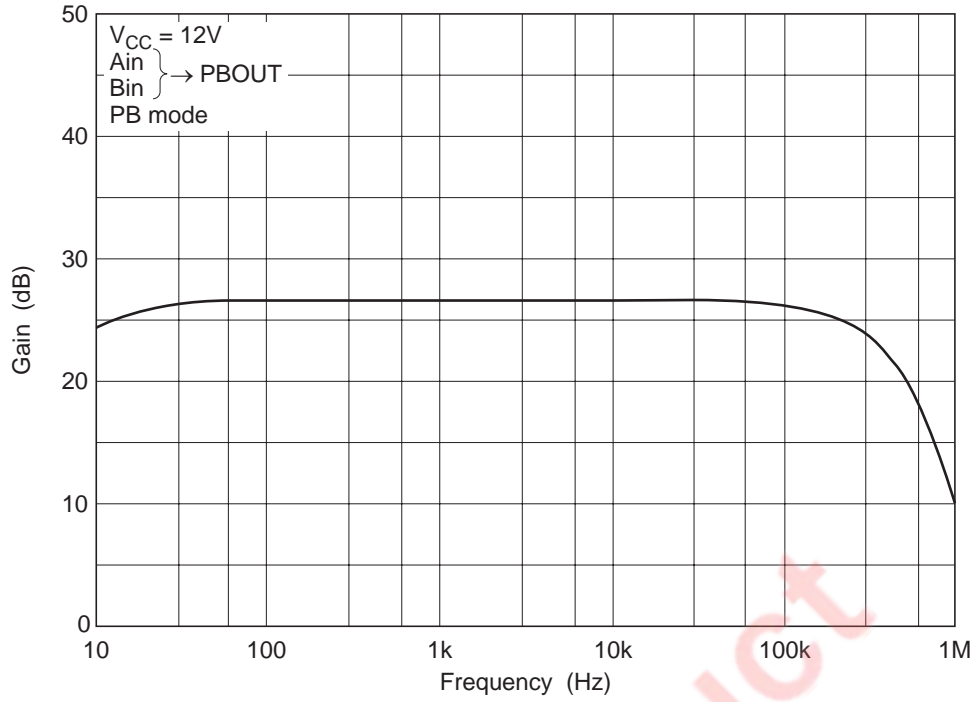

Input Amp. Gain vs. Frequency (2)

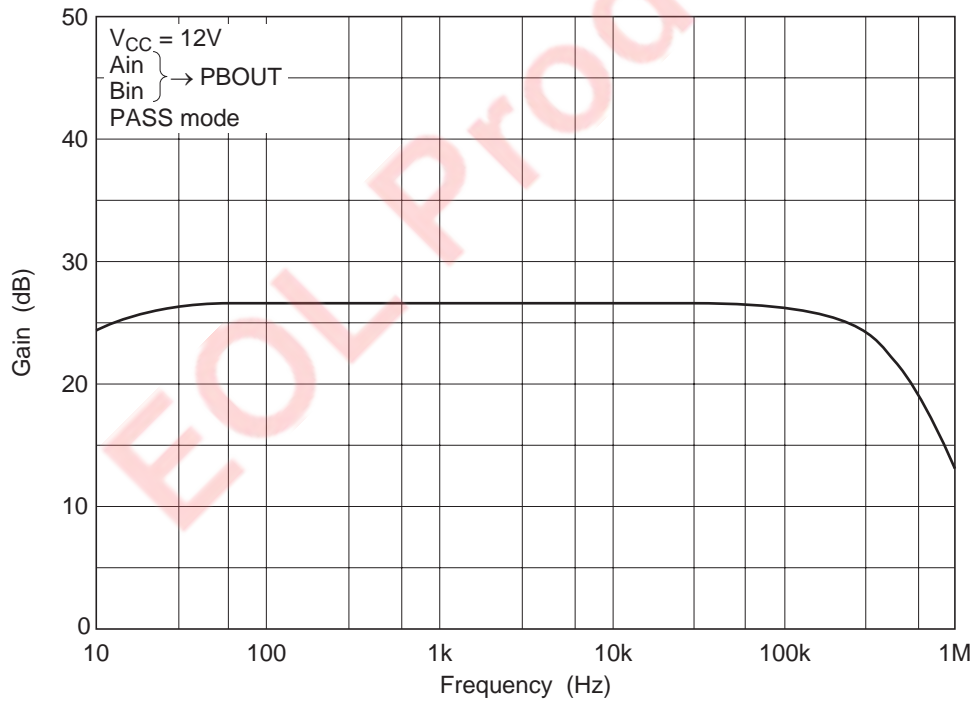

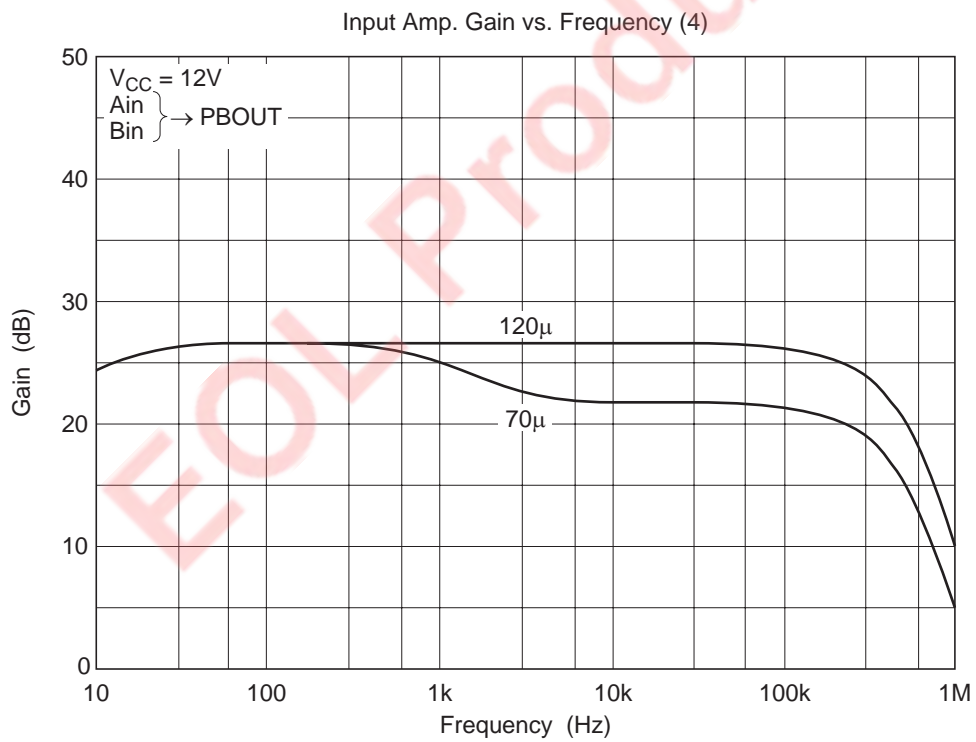
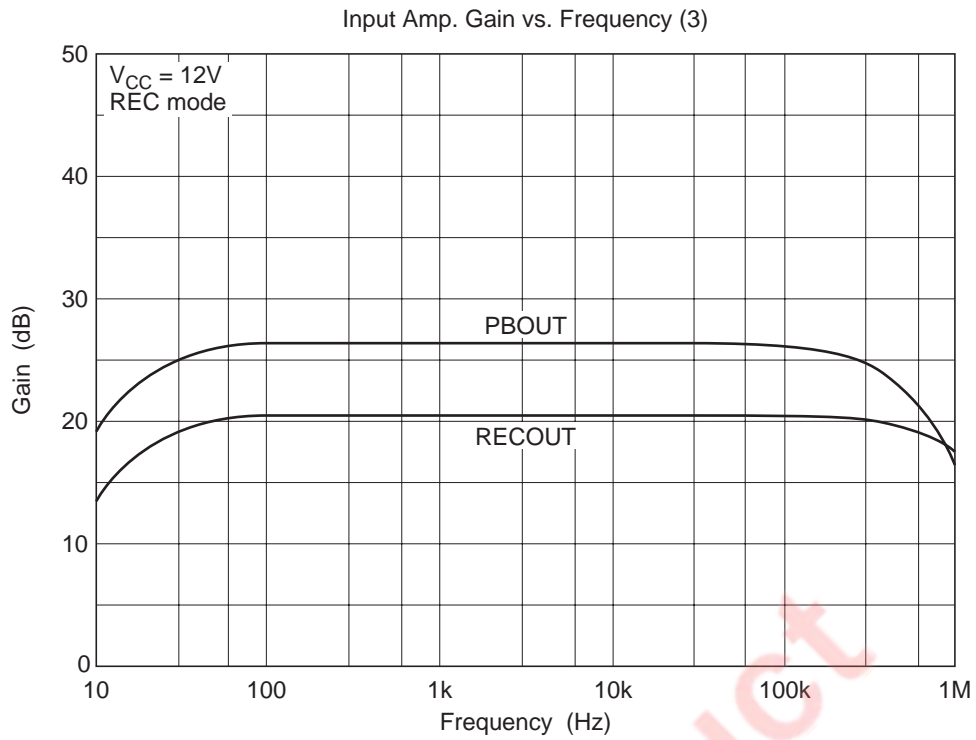

Signal Handling (1)

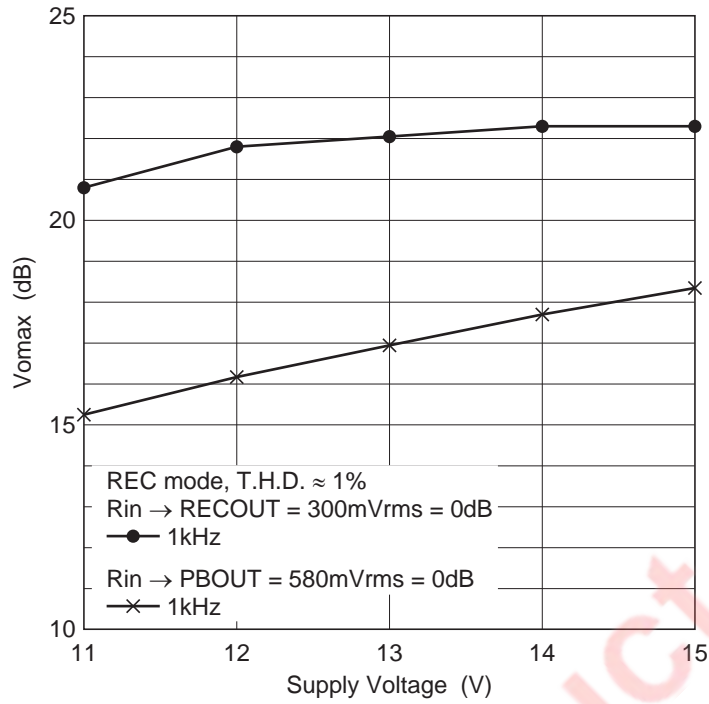

Signal Handling (2)

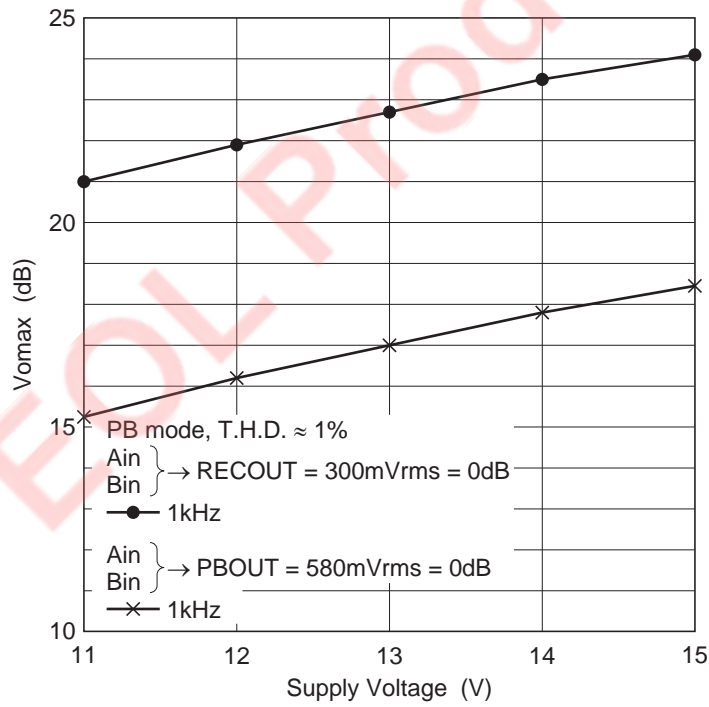

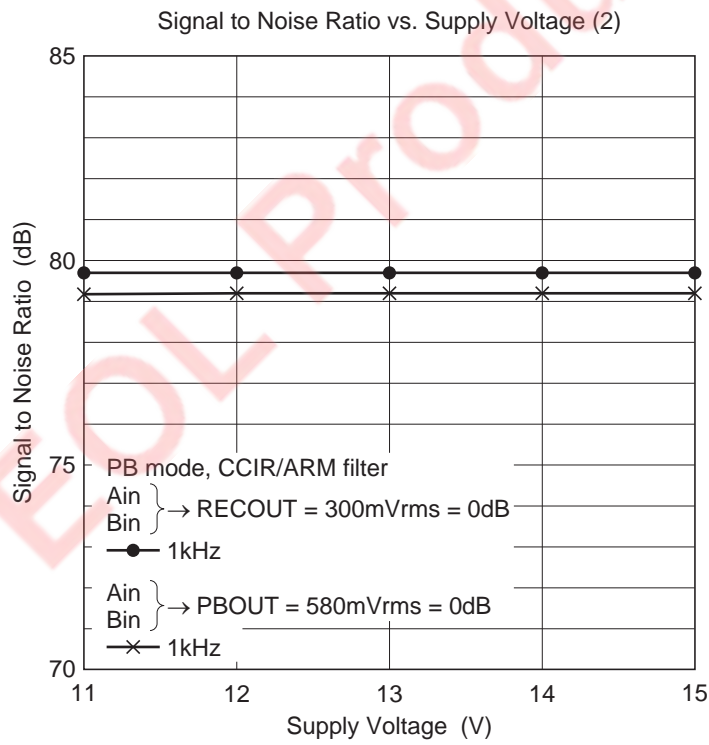
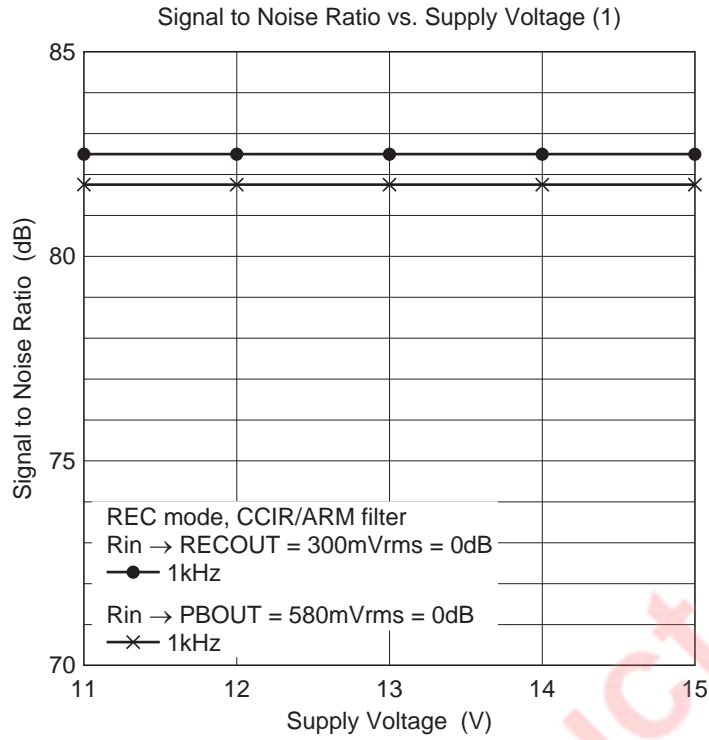

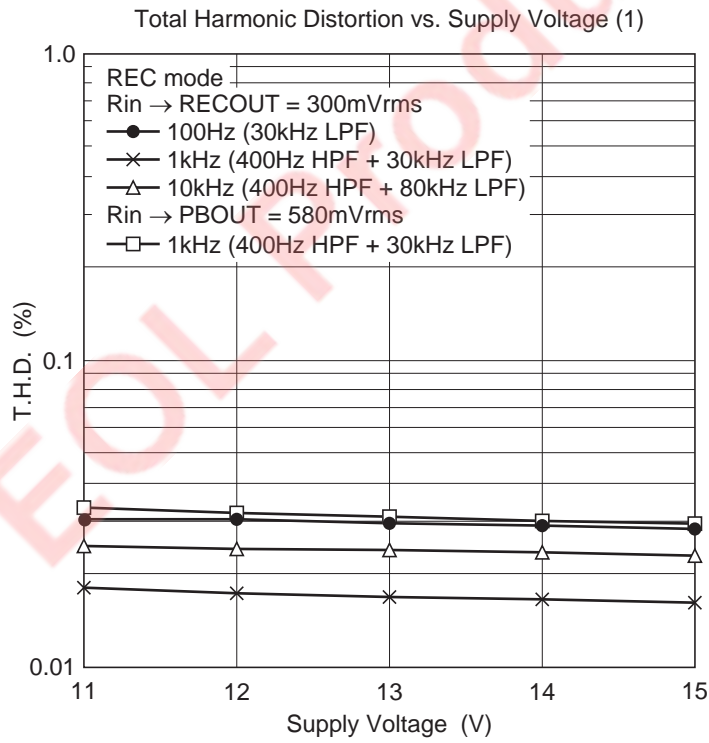
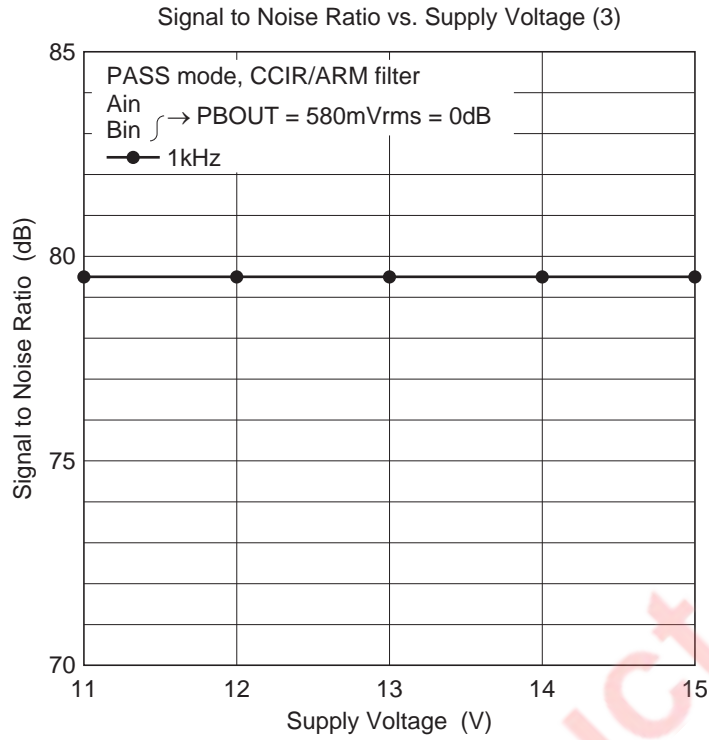

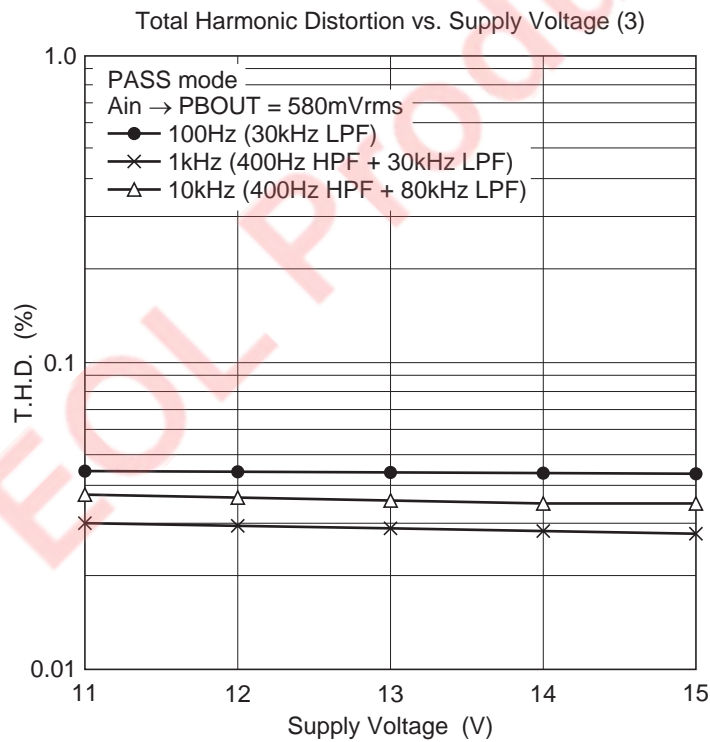
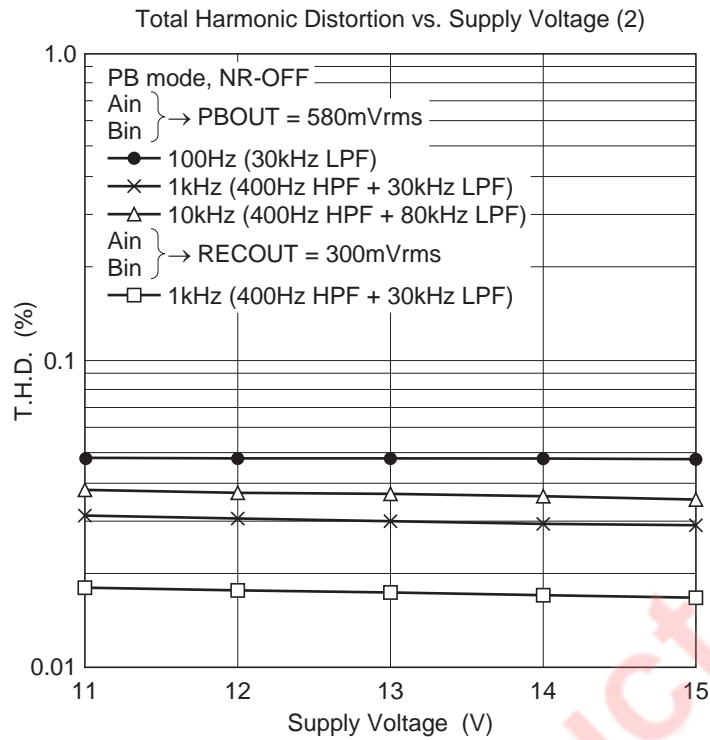

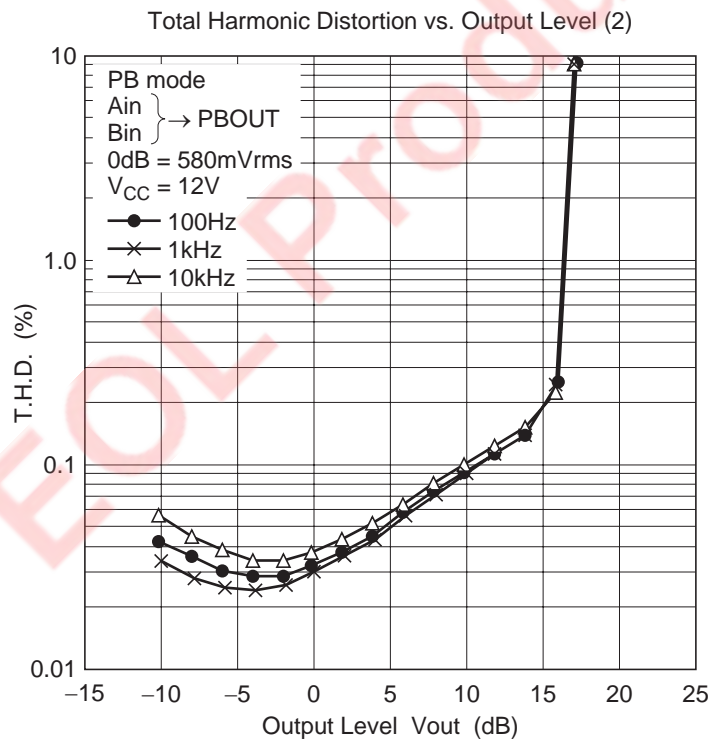
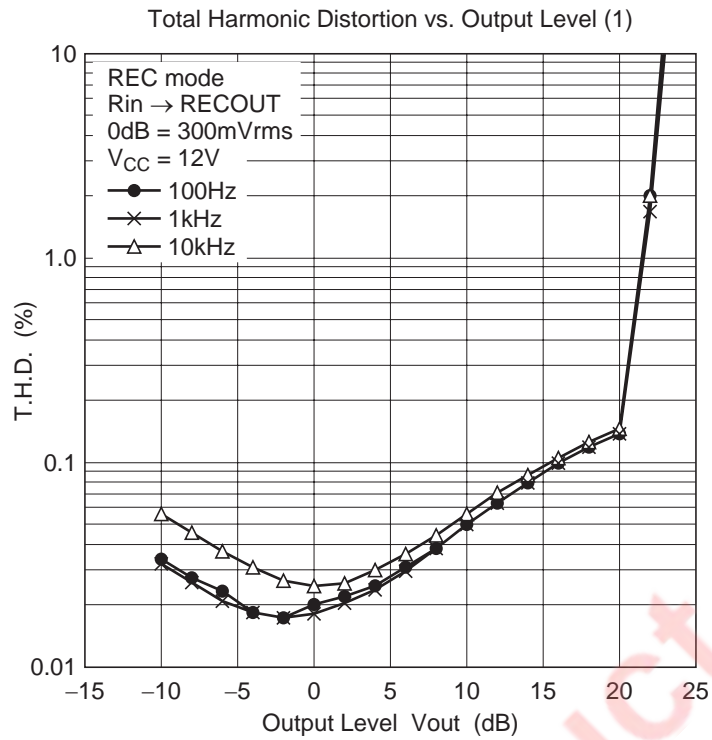

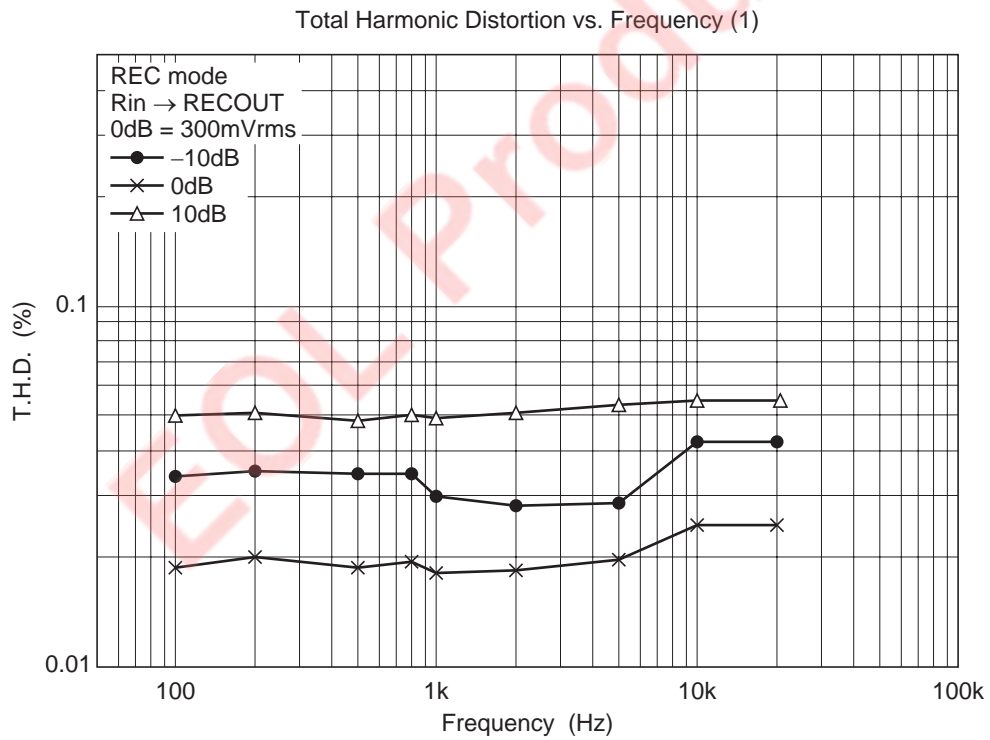
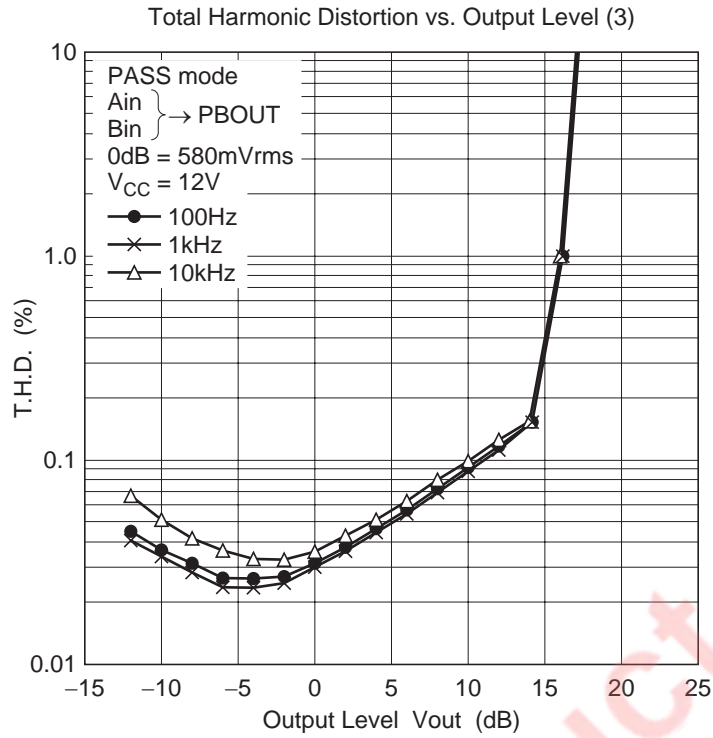

Total Harmonic Distortion vs. Frequency (2)

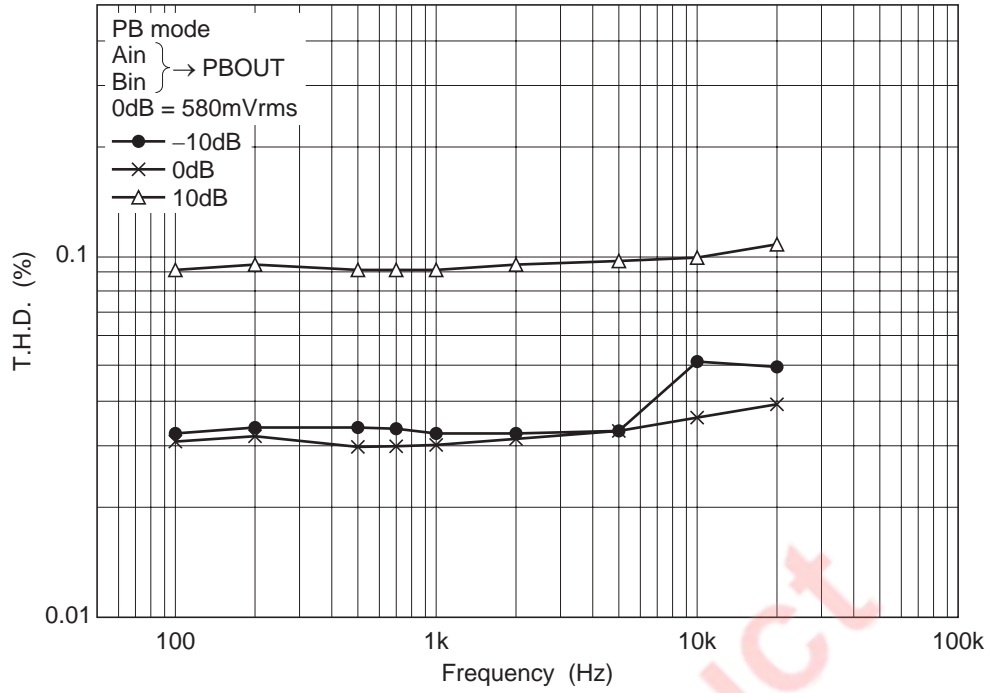

Total Harmonic Distortion vs. Frequency (3)

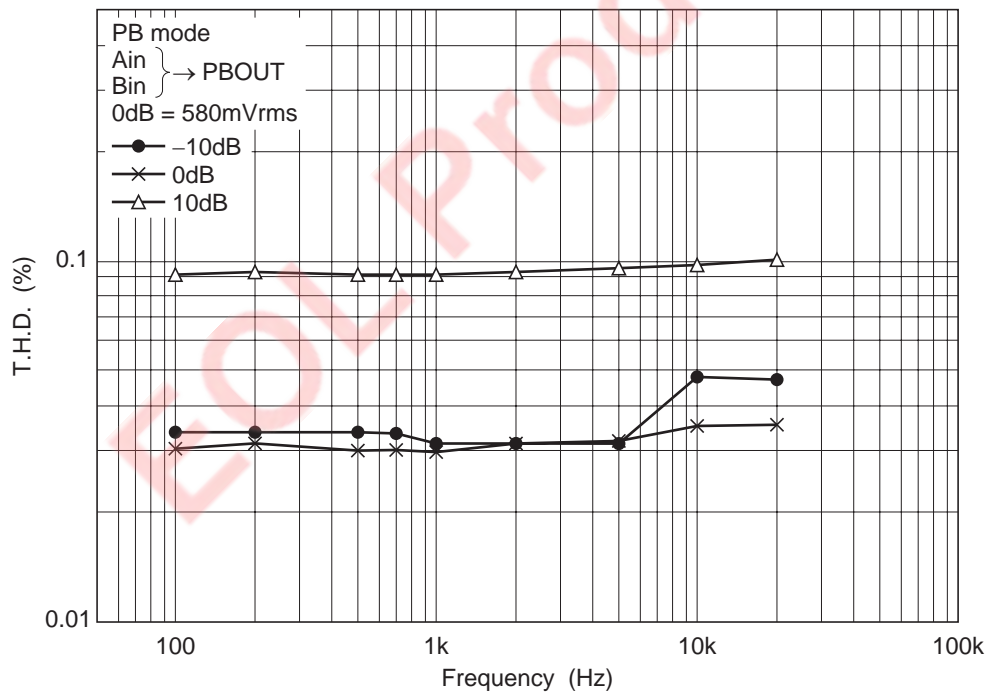

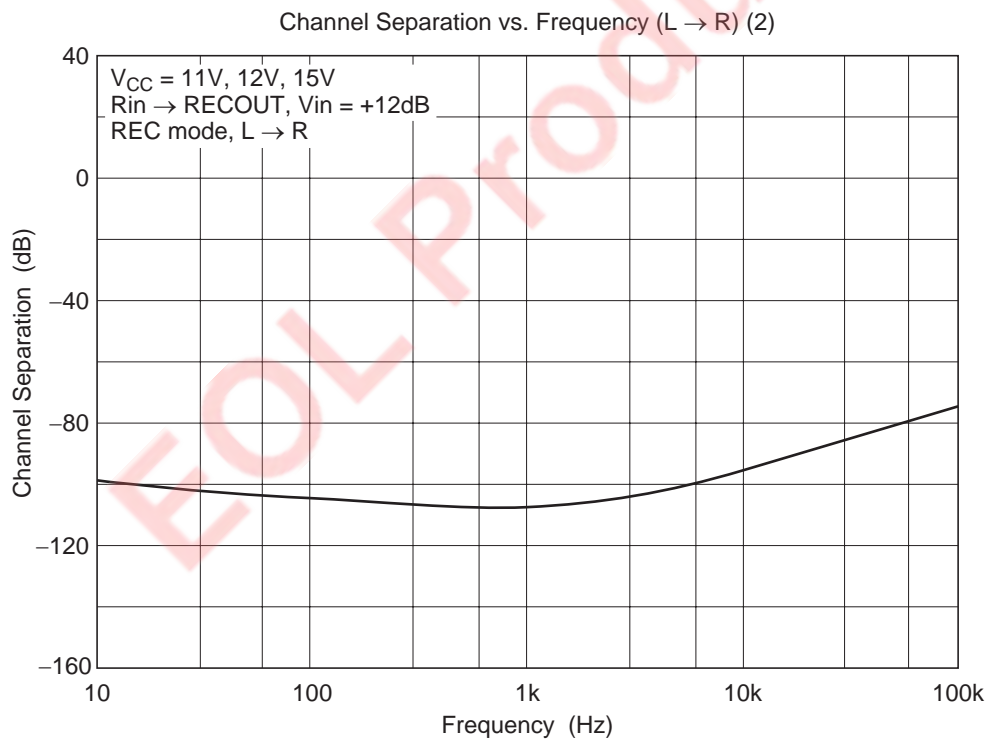
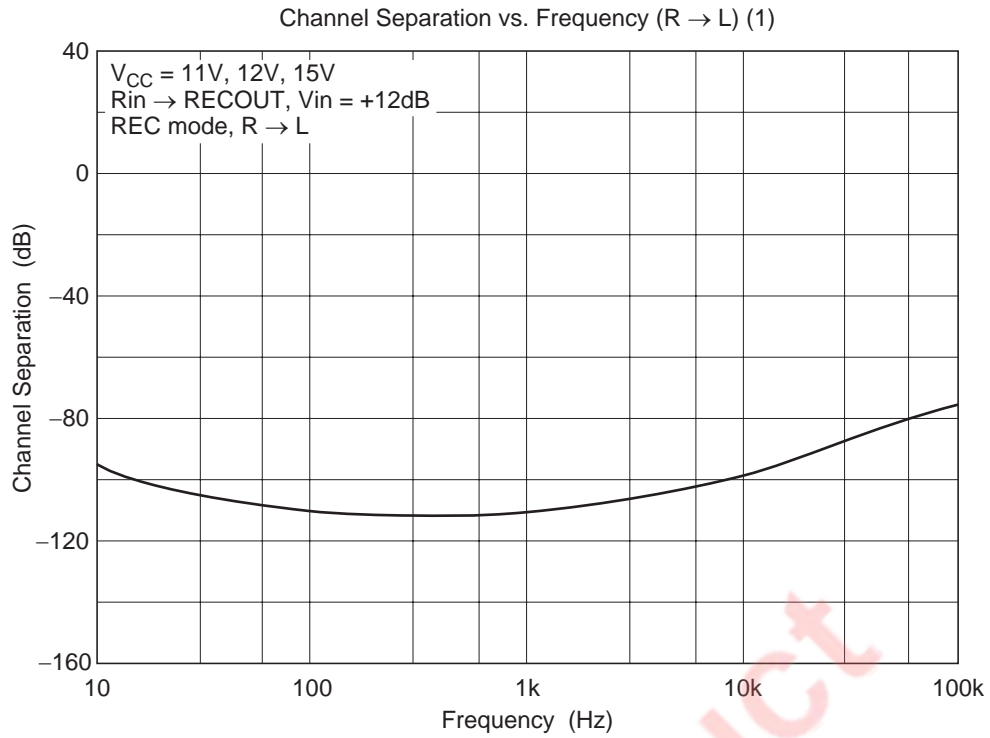

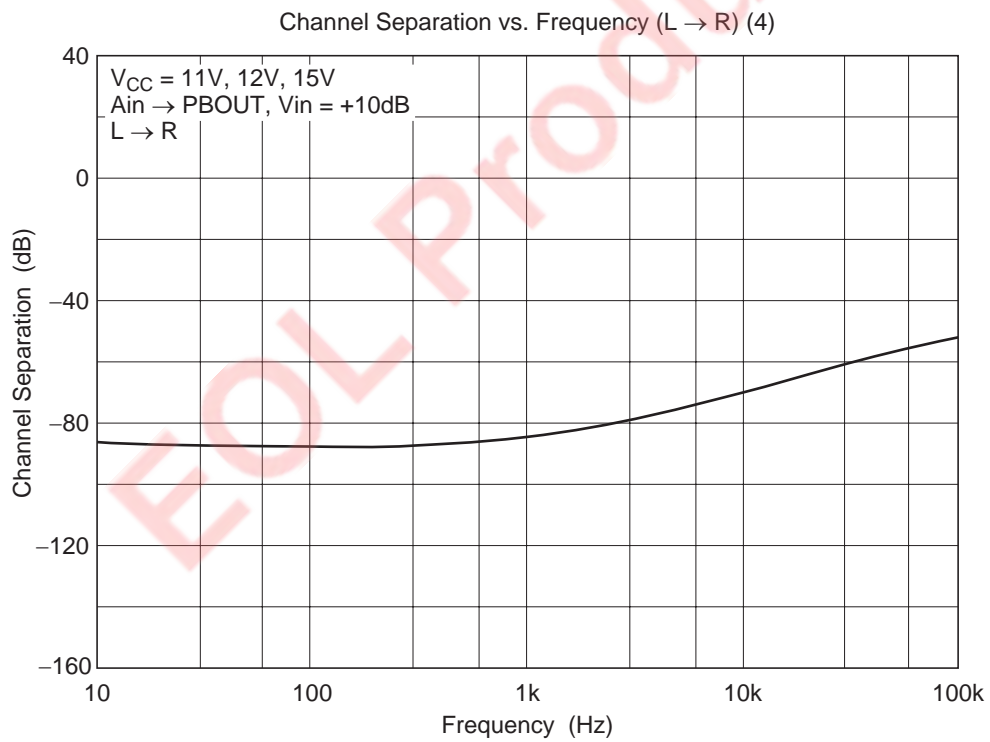
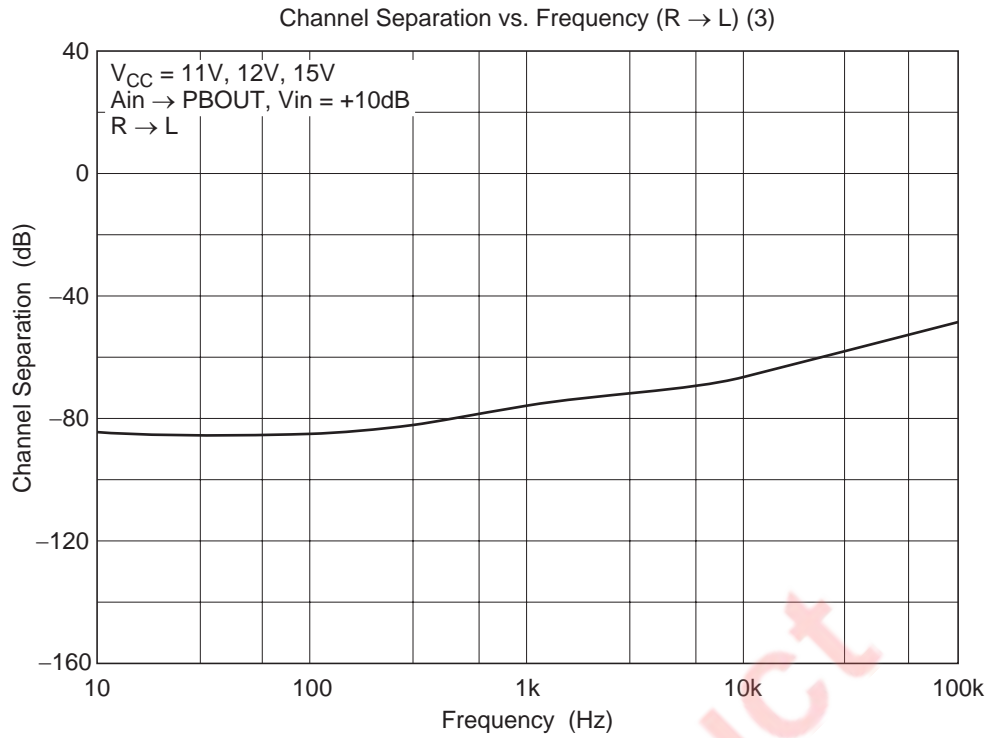

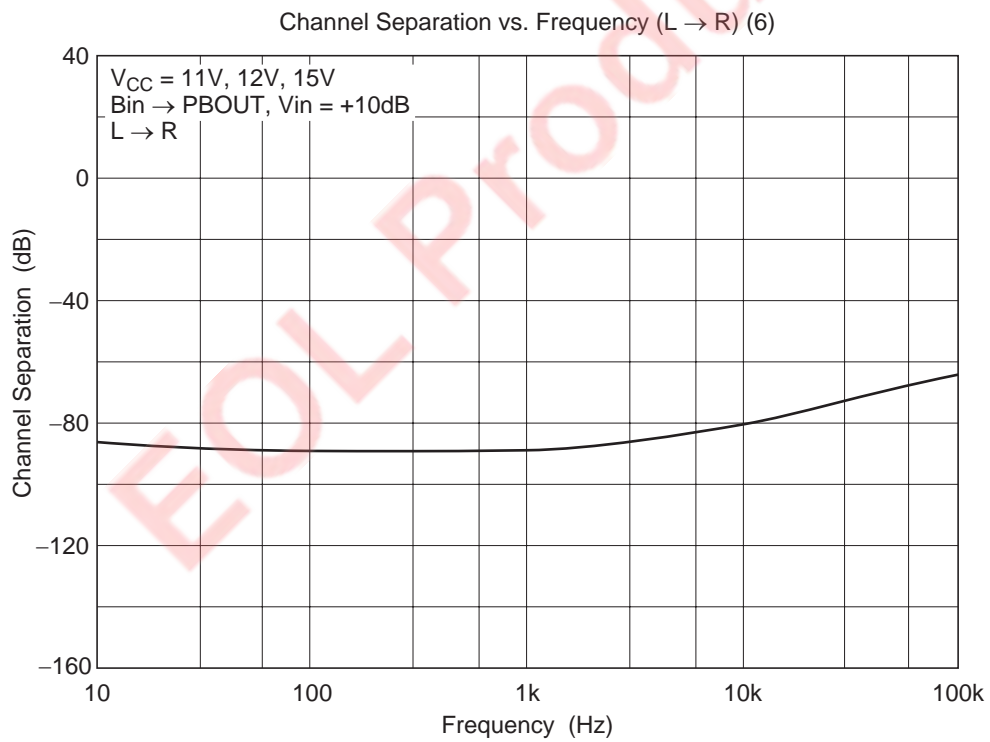
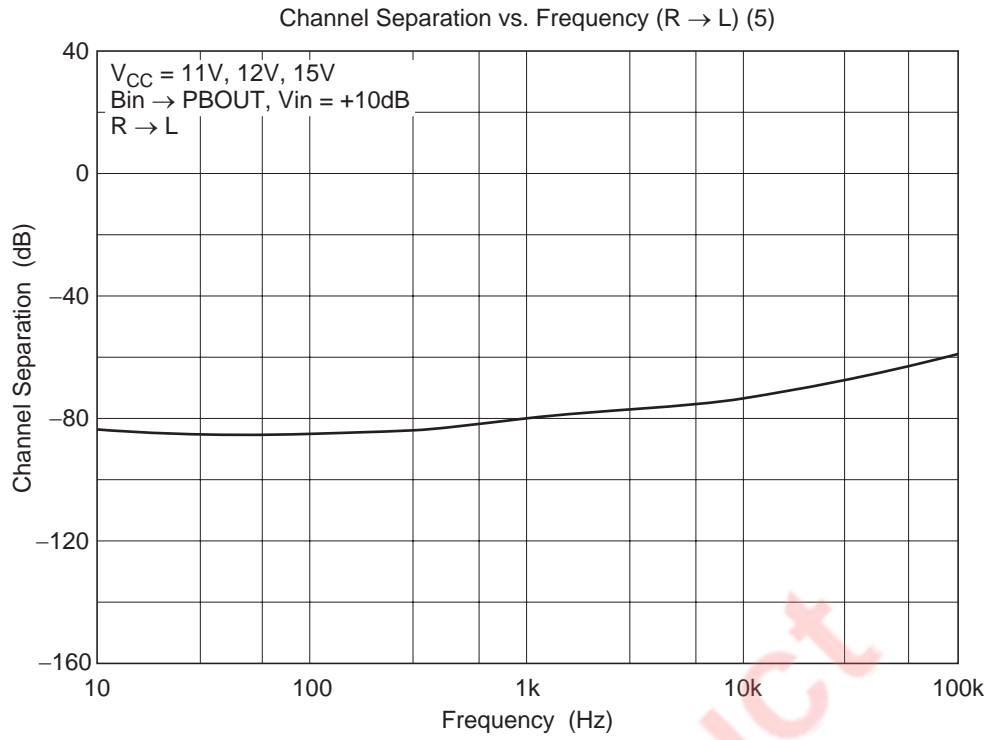

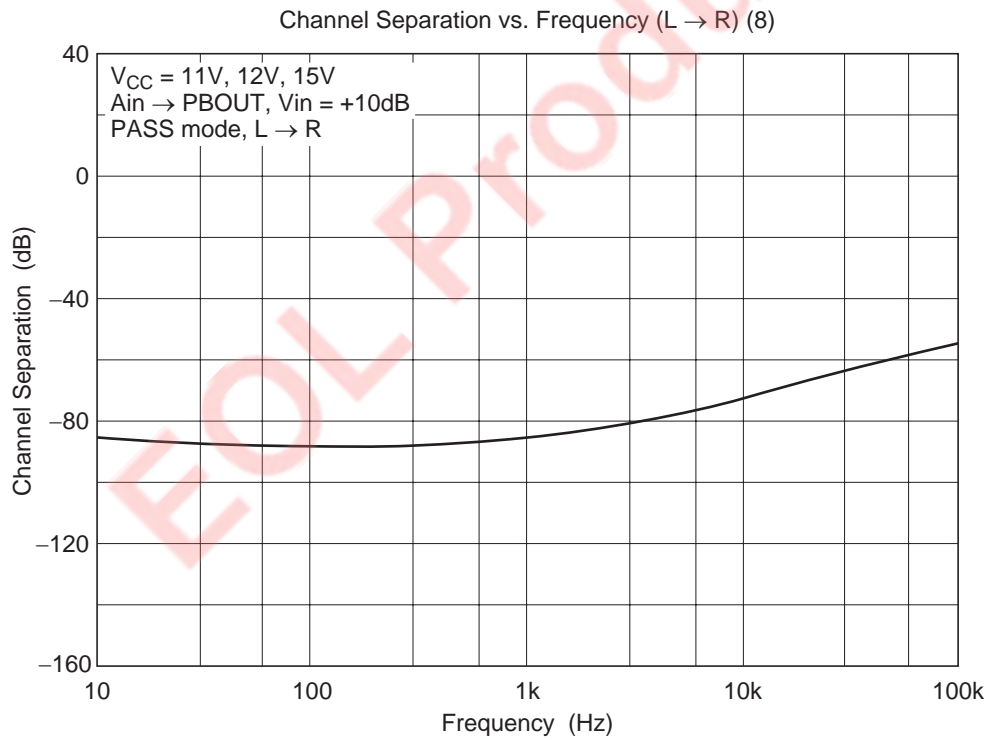
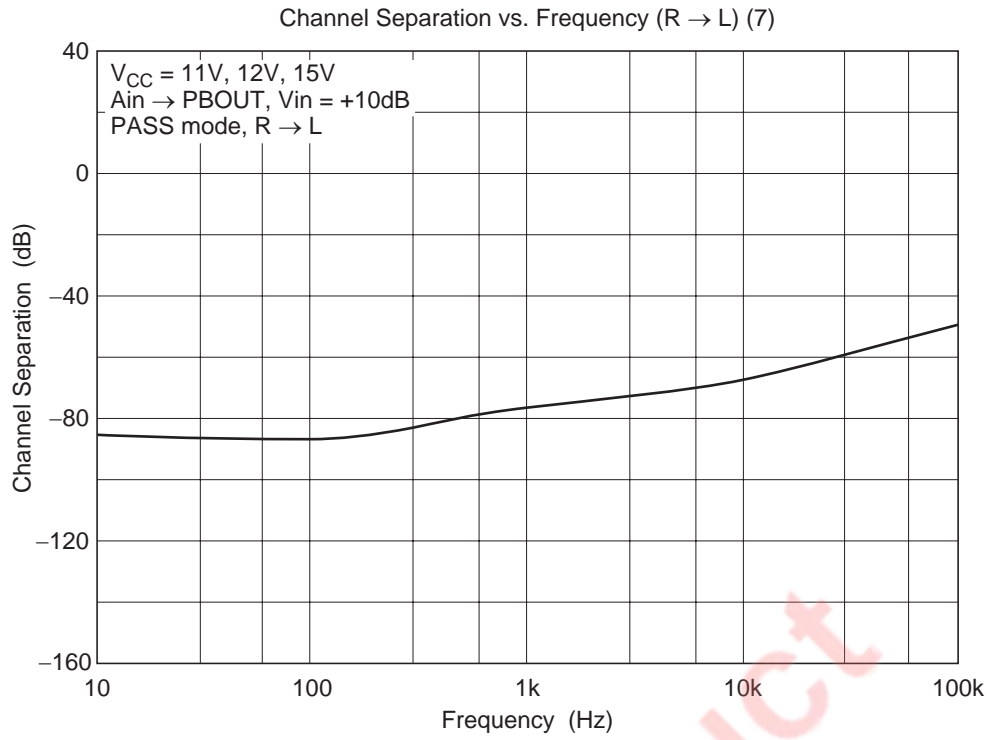

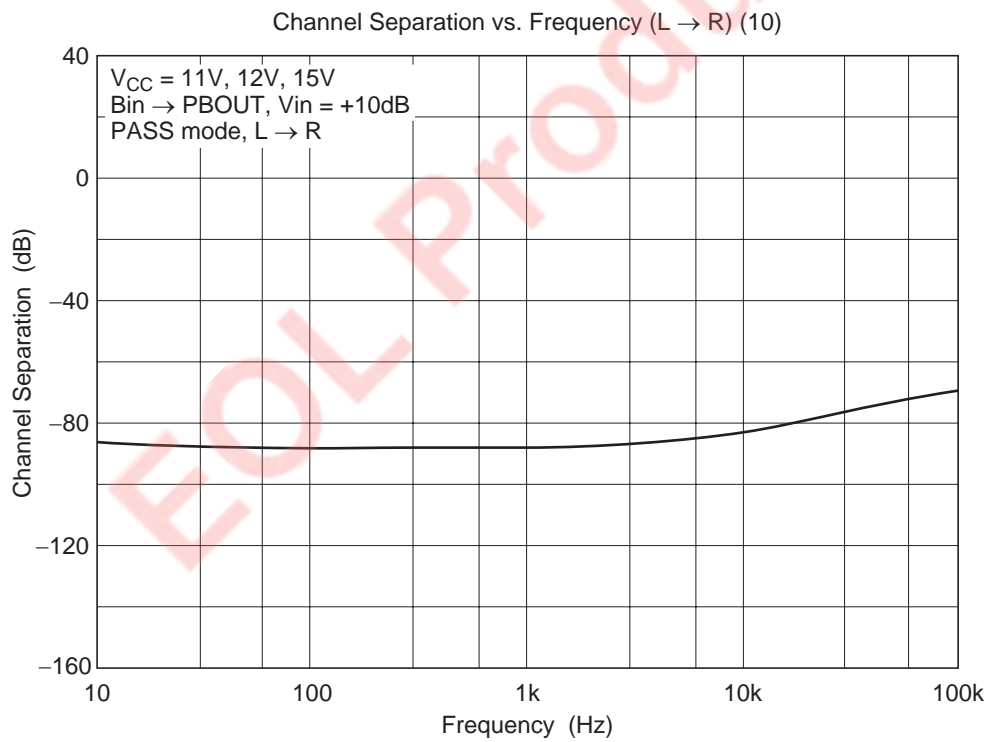
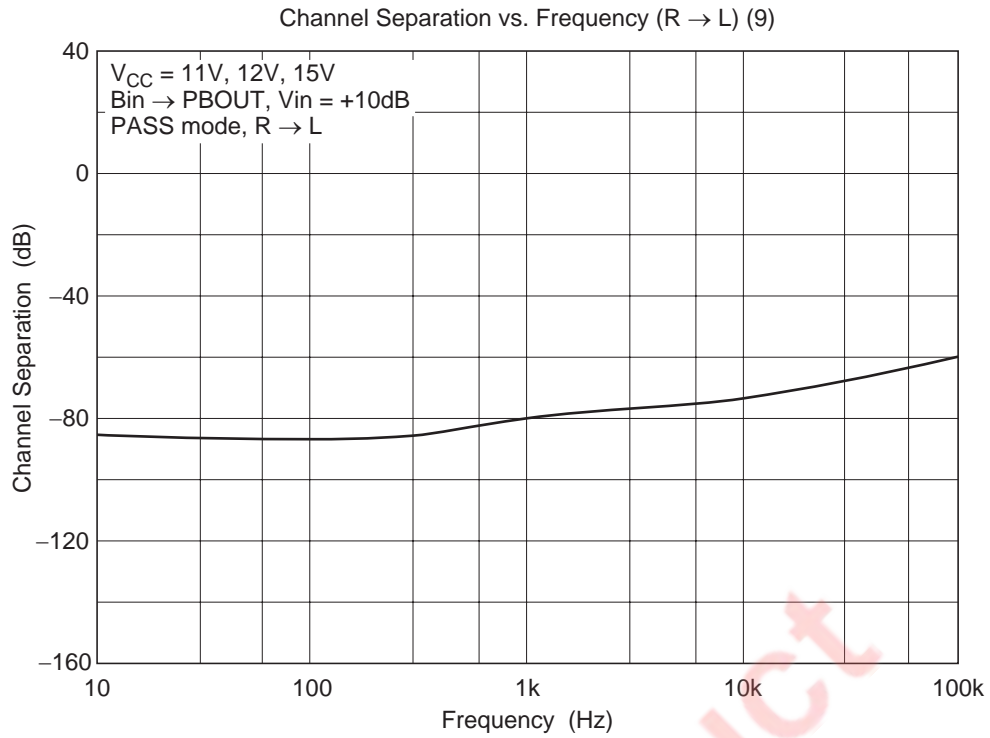

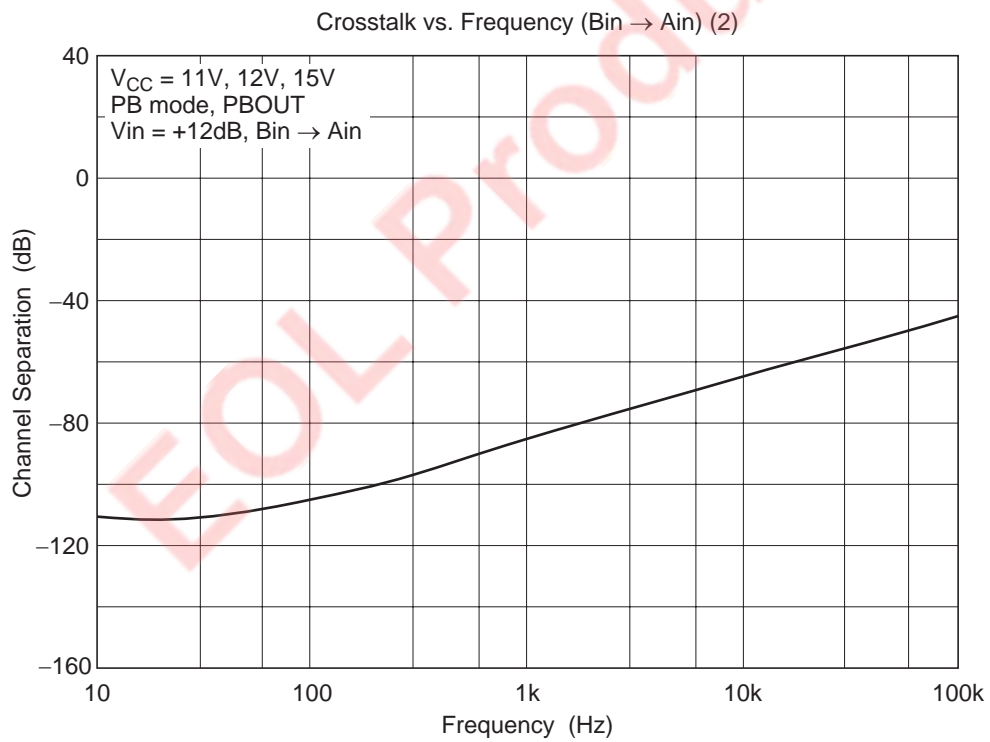
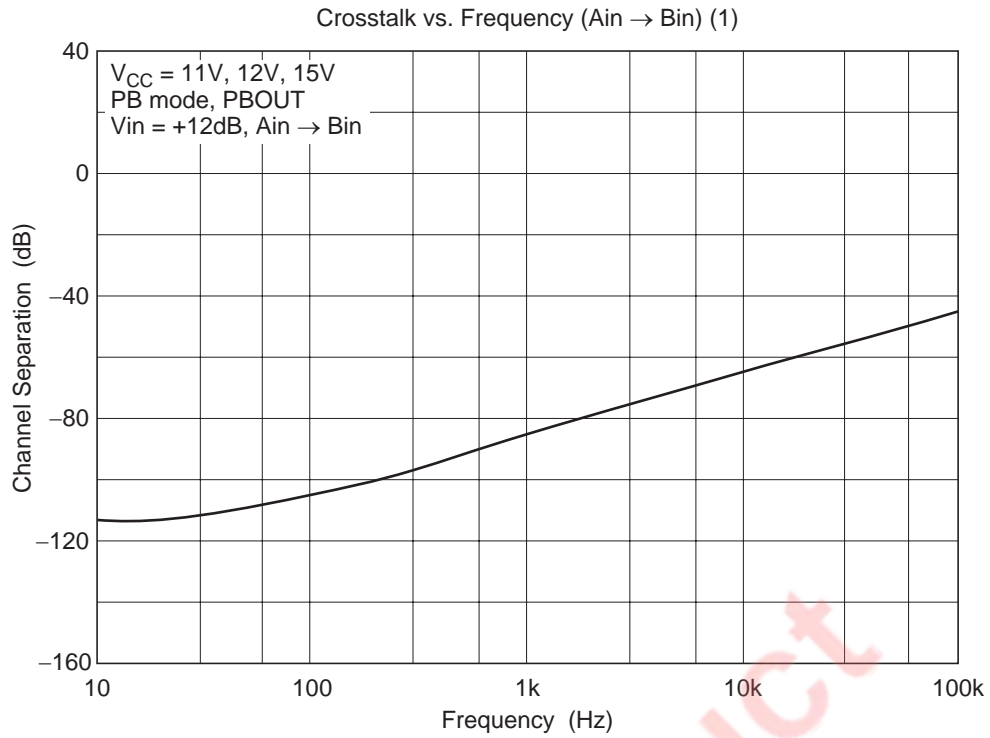

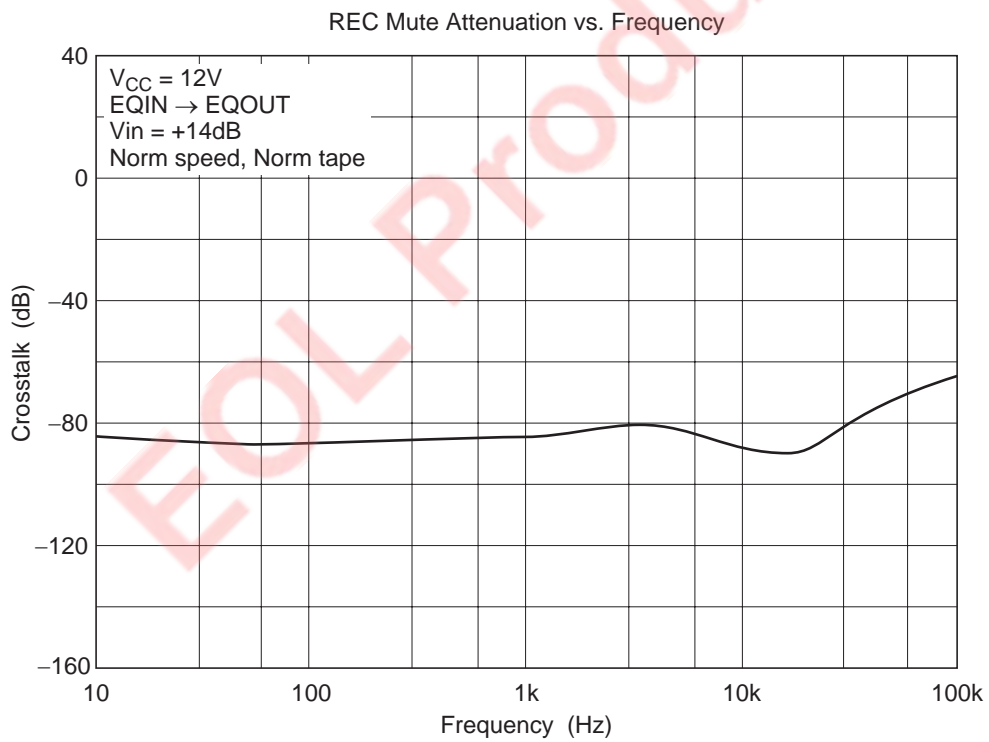
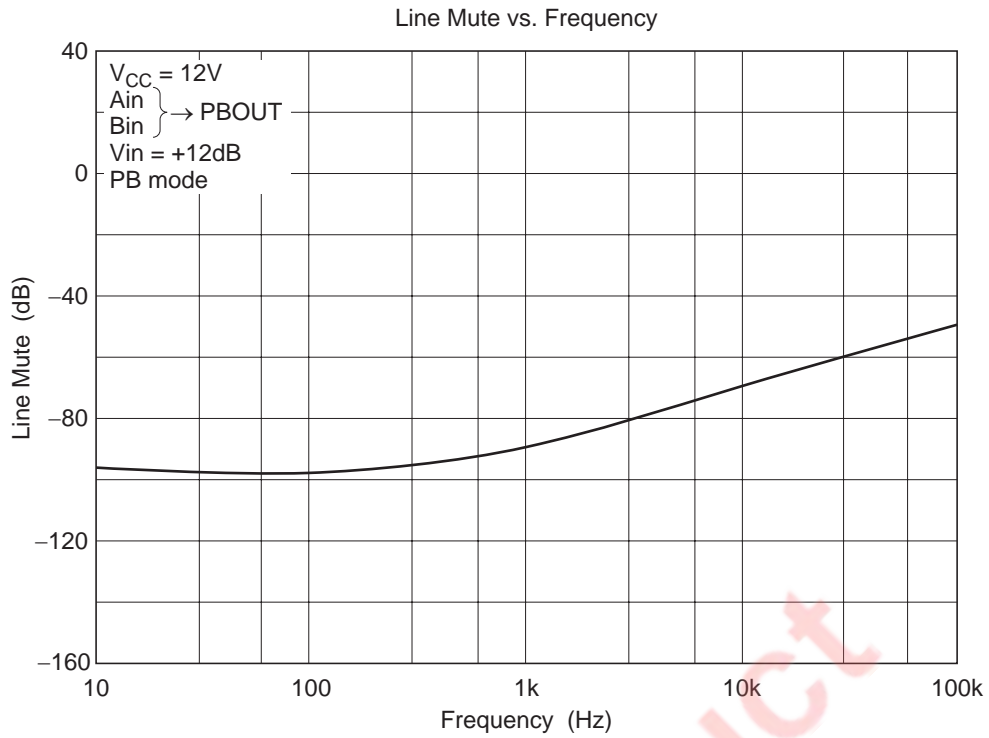

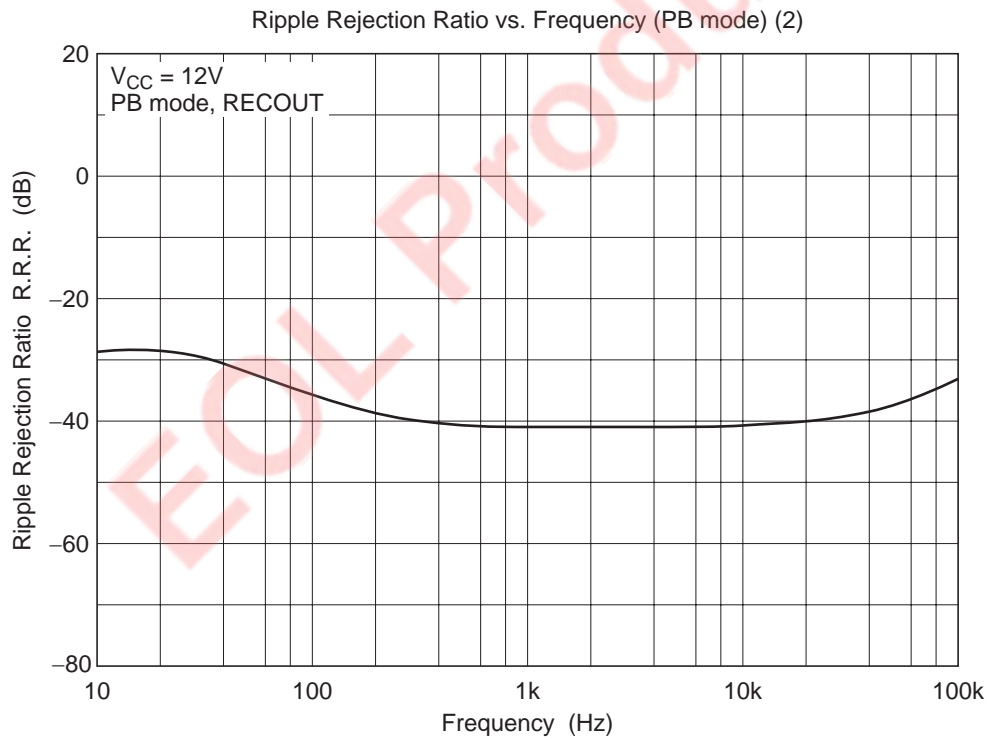
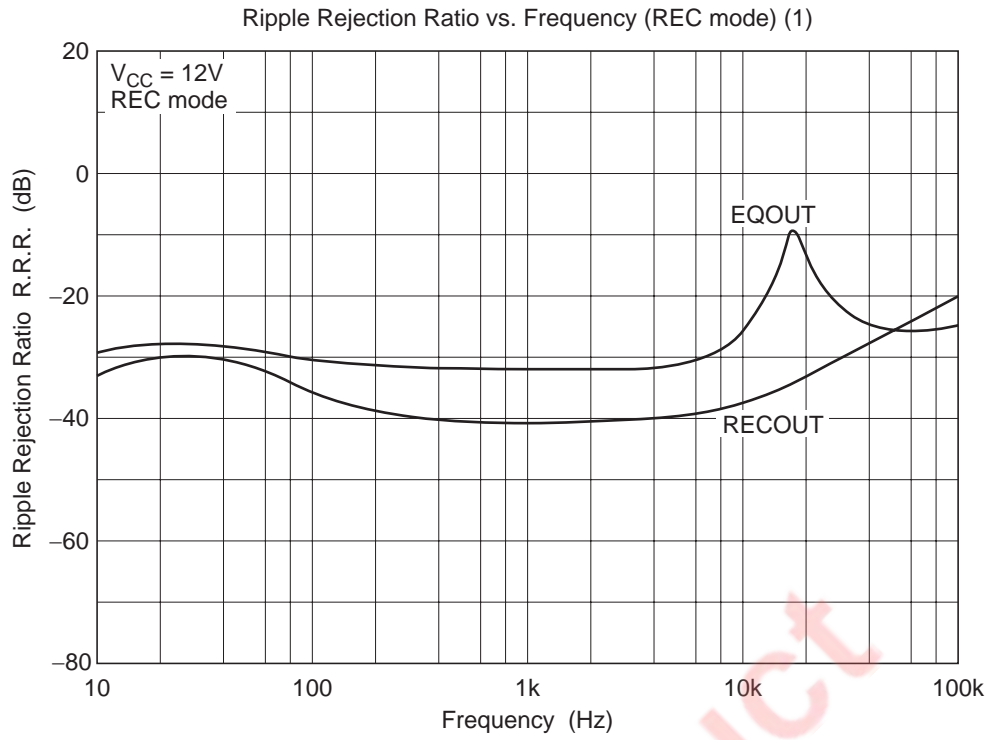

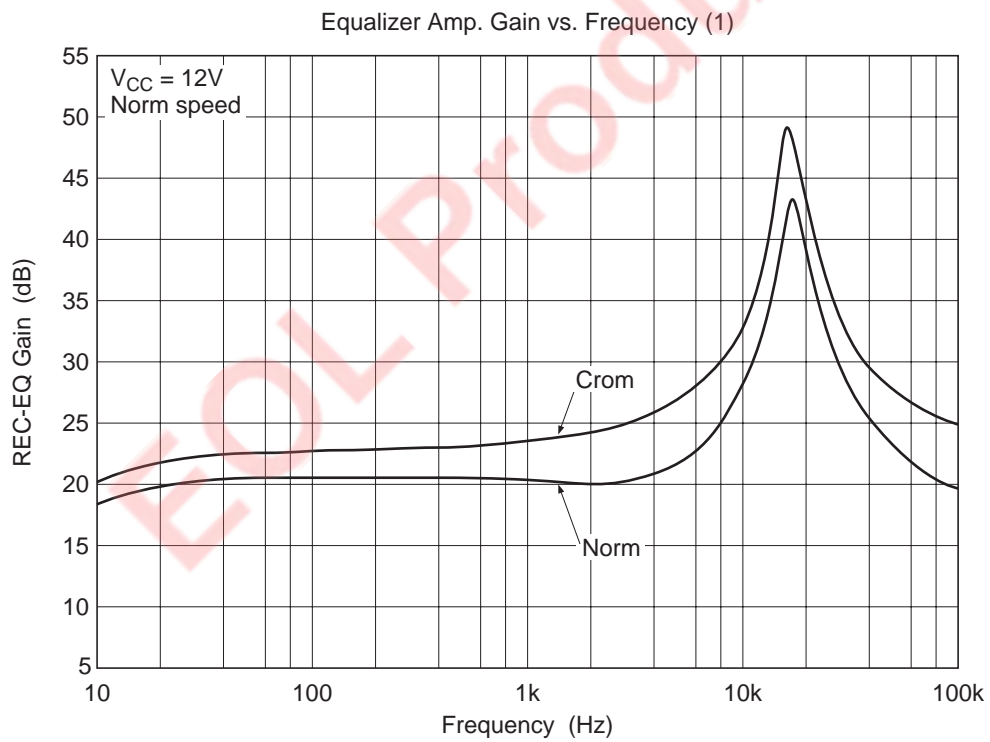
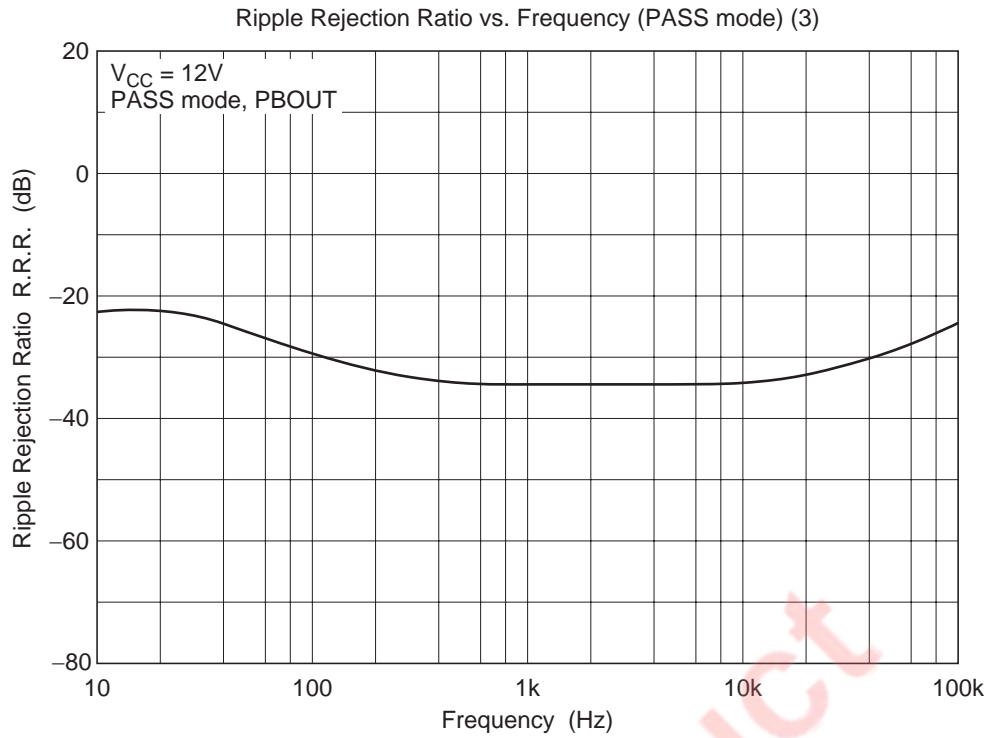

Equalizer Amp. Gain vs. Frequency (2)

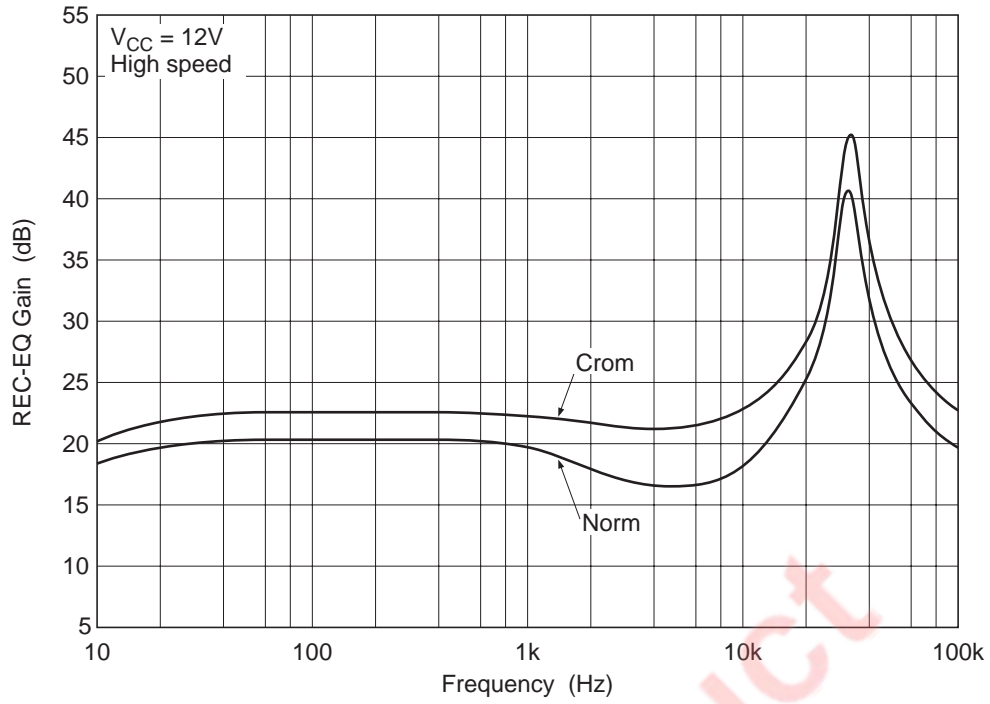

Equalizer Amp. Gain vs. Frequency (REC-cal)

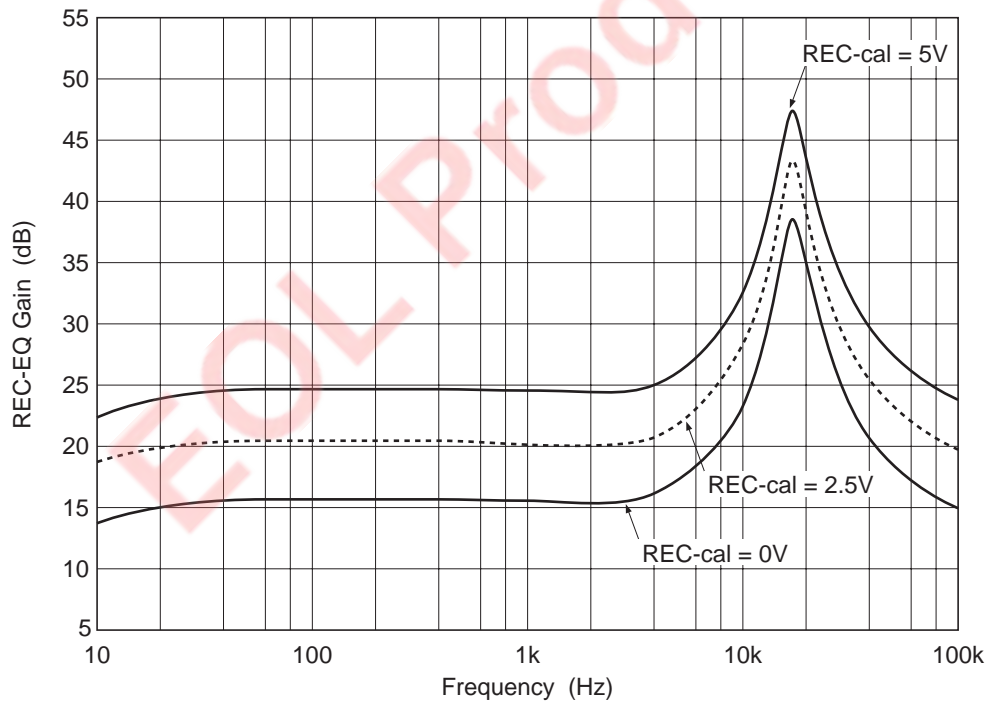

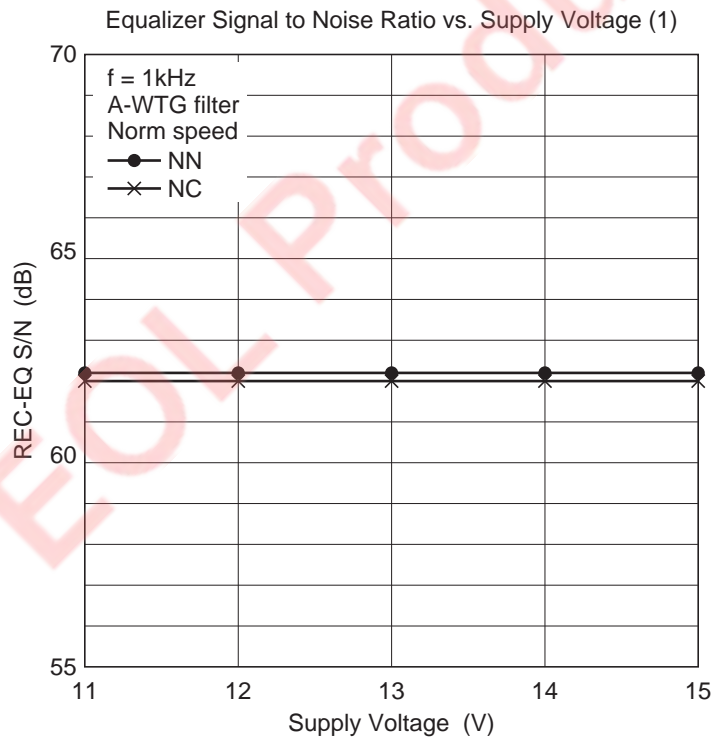
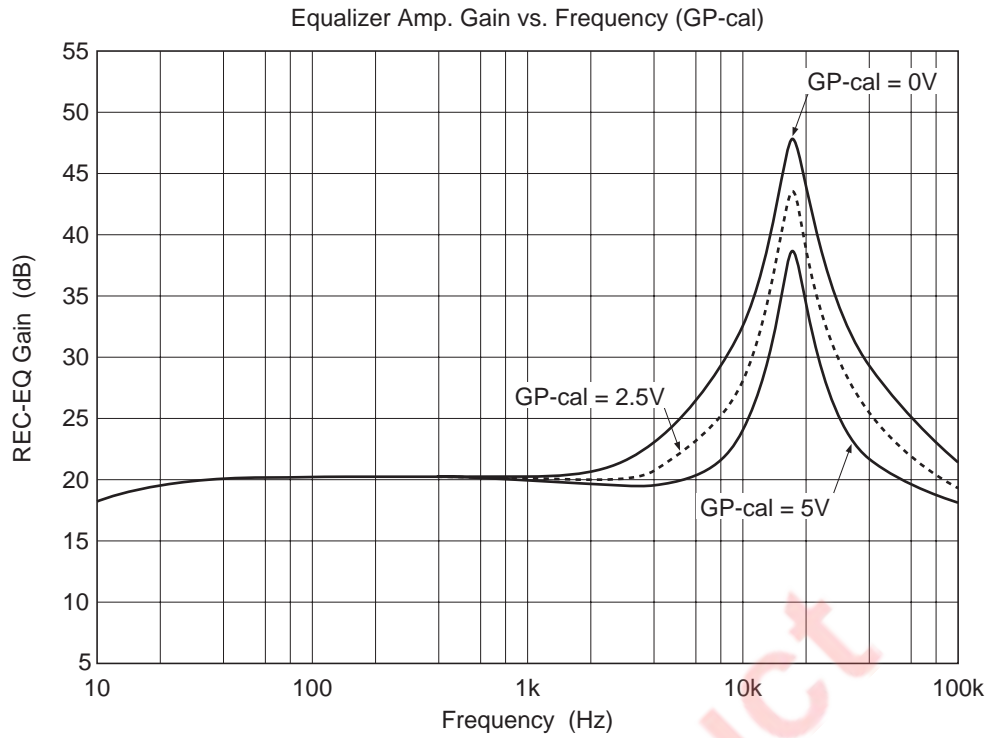

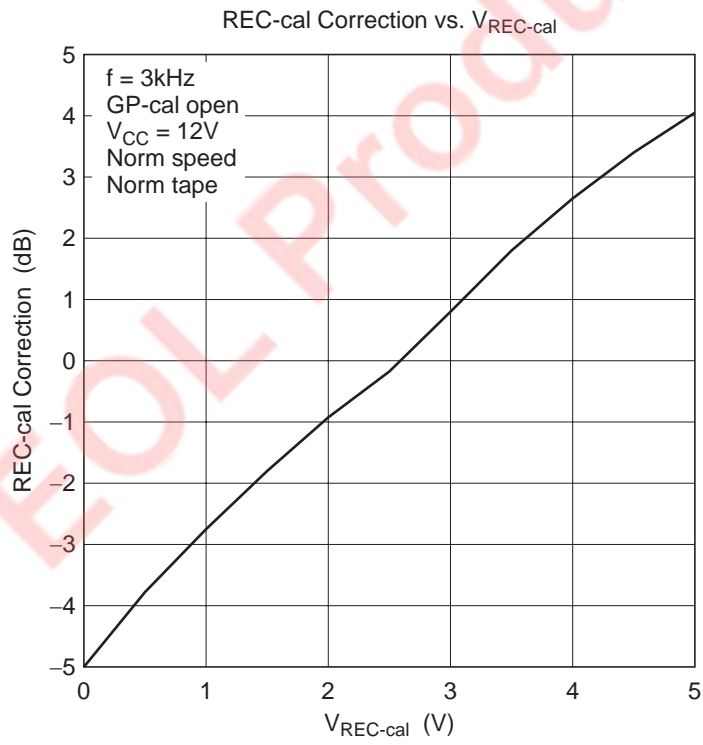
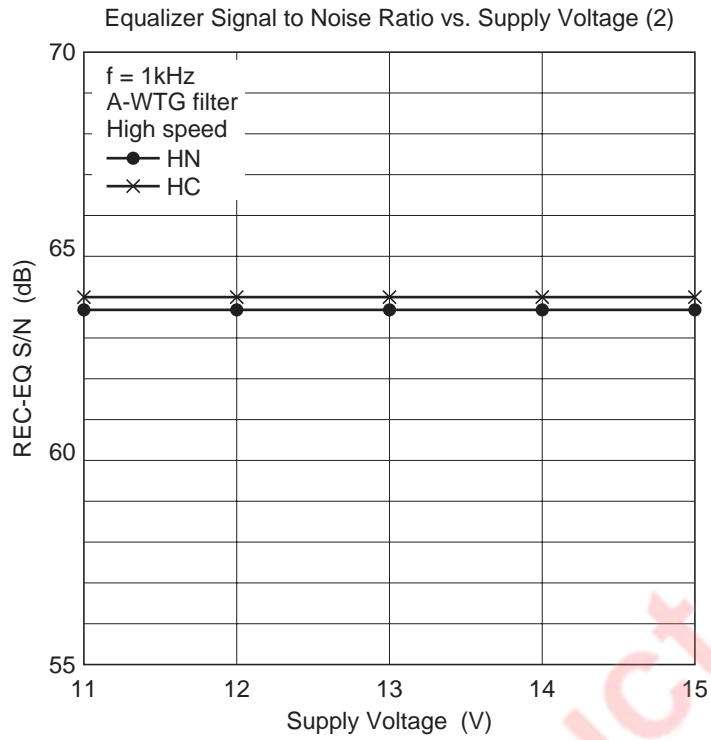

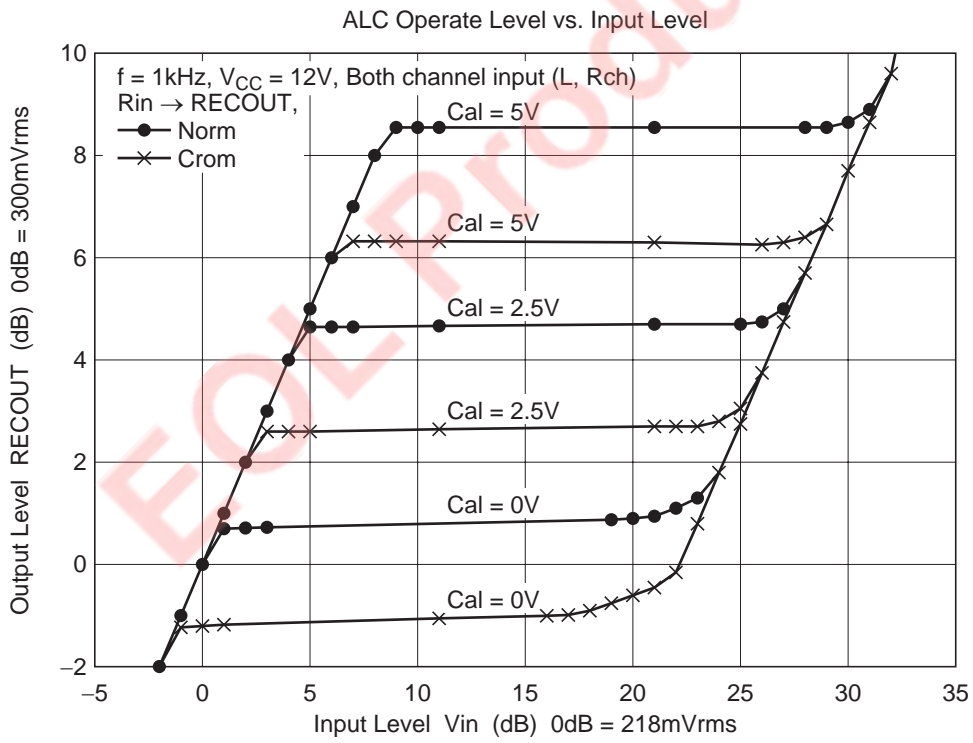
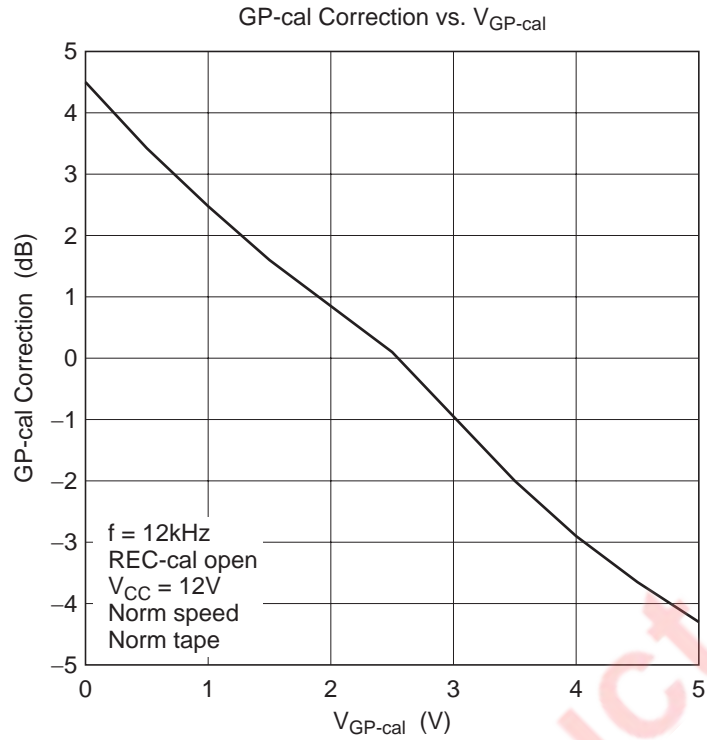

ALC Total Harmonic Distortion vs. Input Level (1)

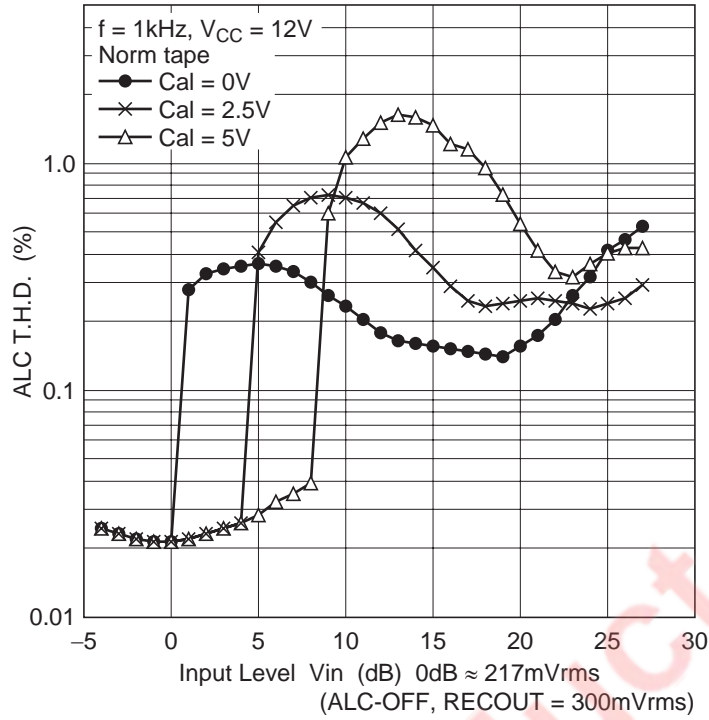

ALC Total Harmonic Distortion vs. Input Level (2)

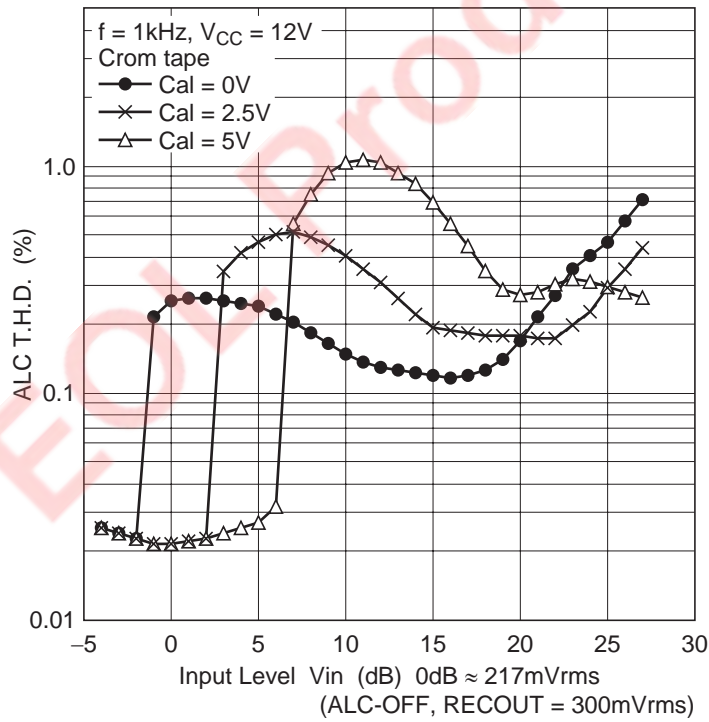

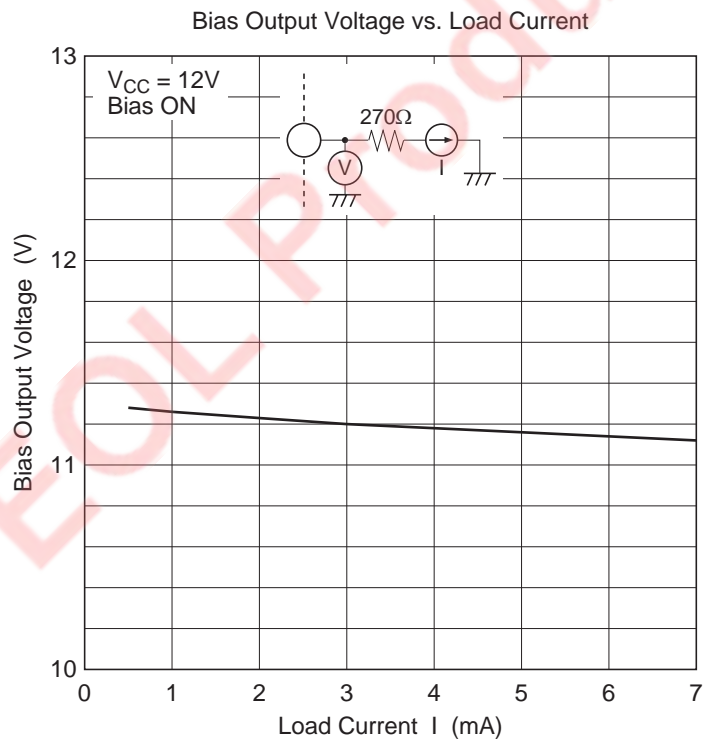
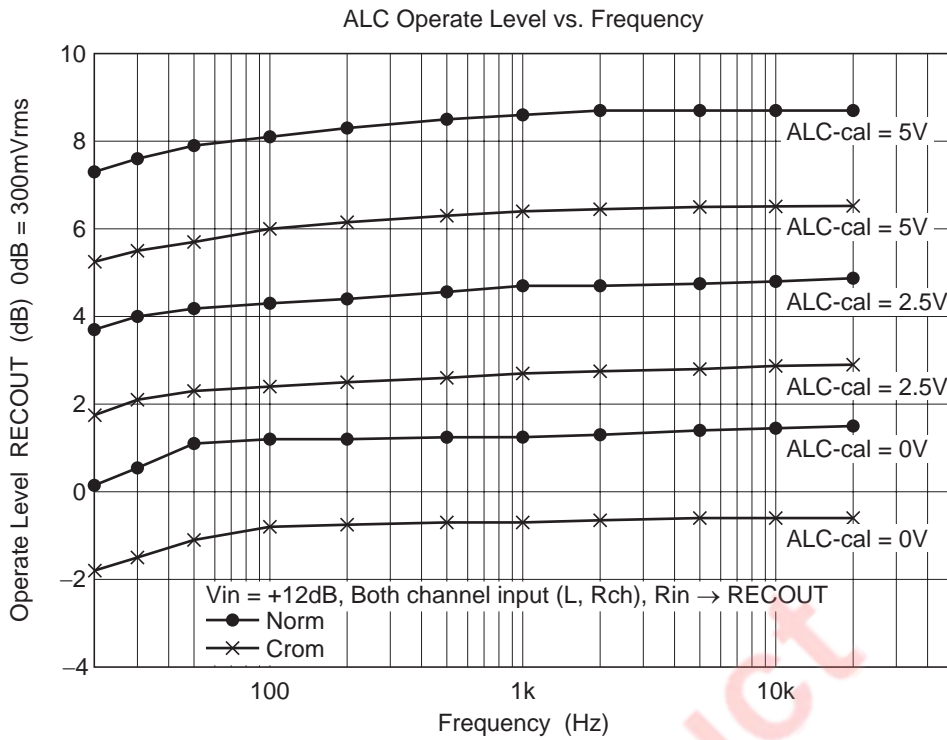

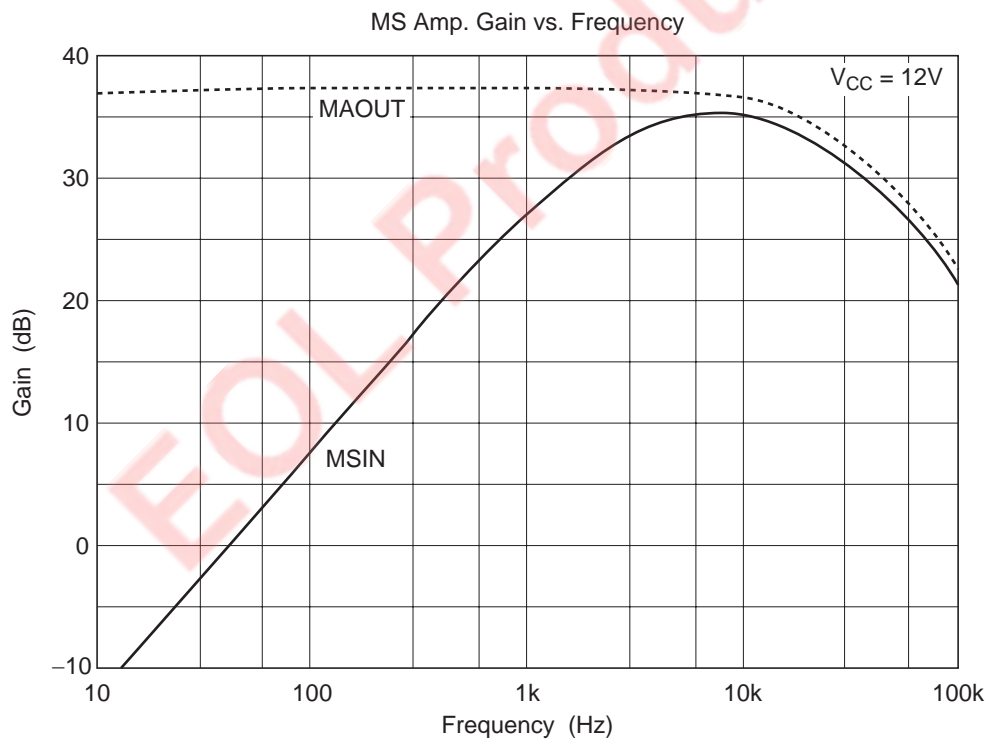
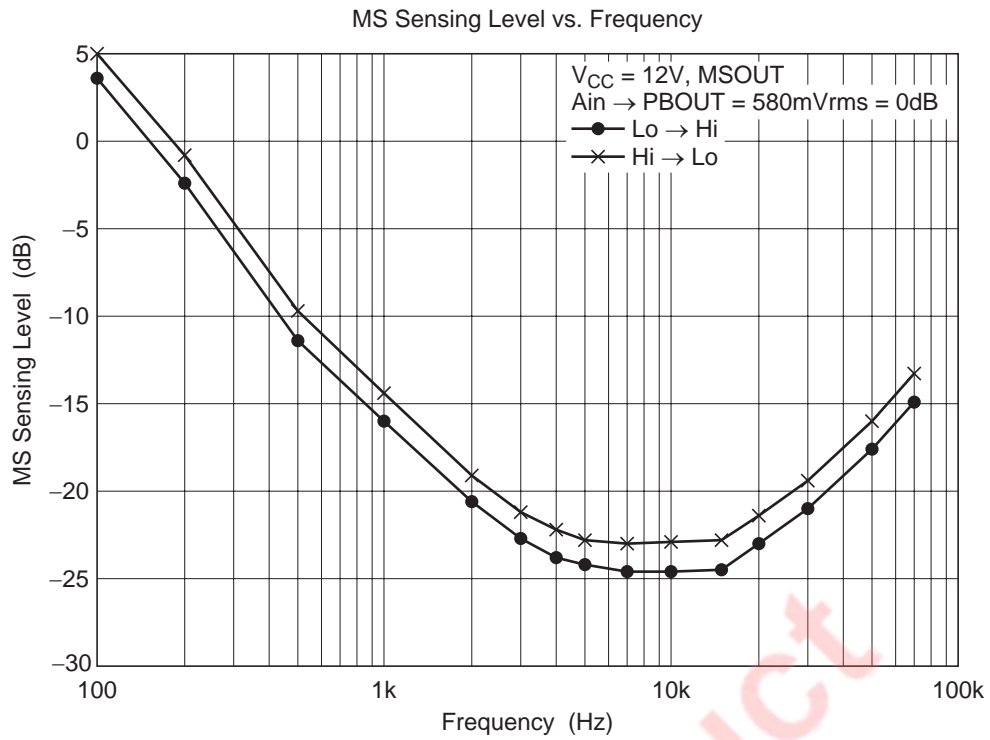

No-Signal Sensing Time vs. Resistance

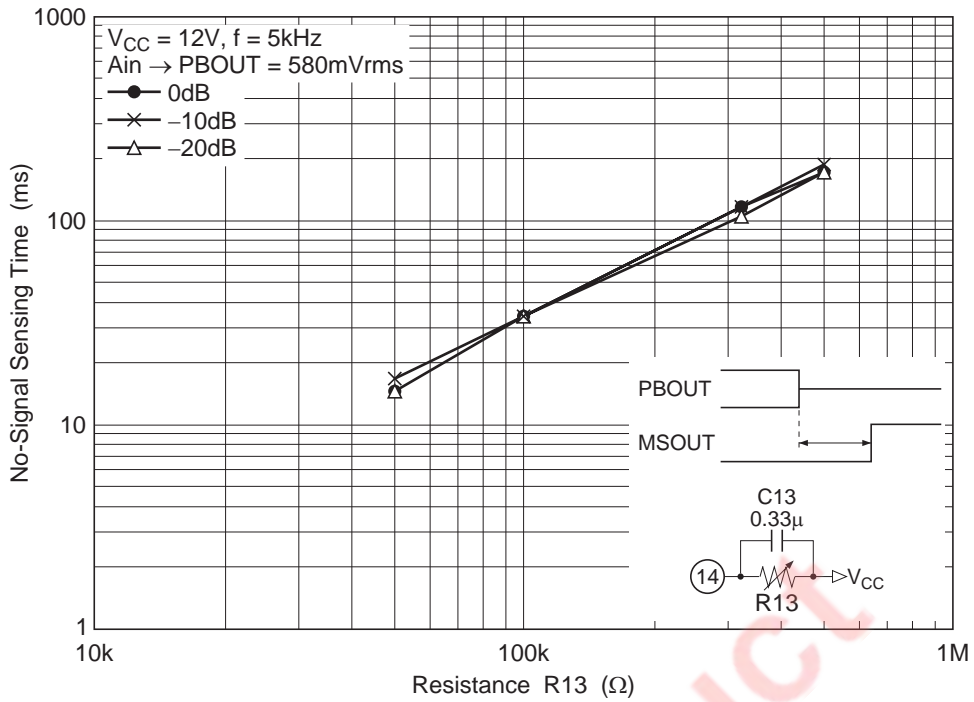

Signal Sensing Time vs. Capacitance

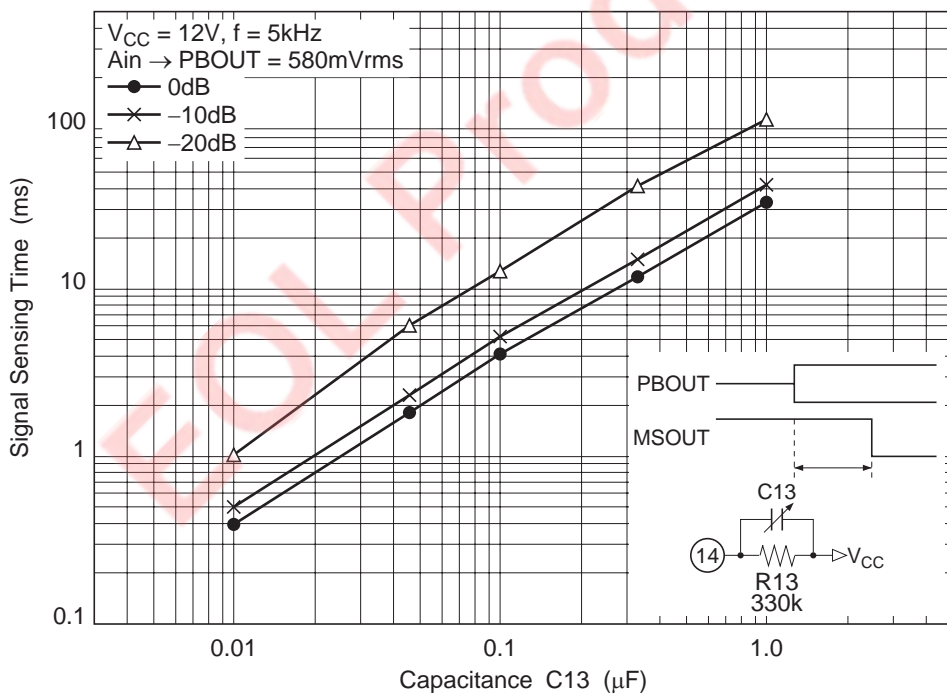

Package Dimensions

As of January, 2003
Unit: mm

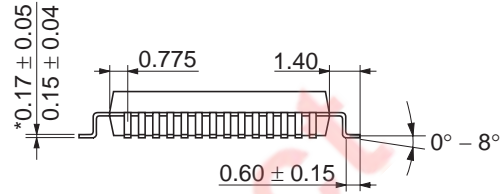
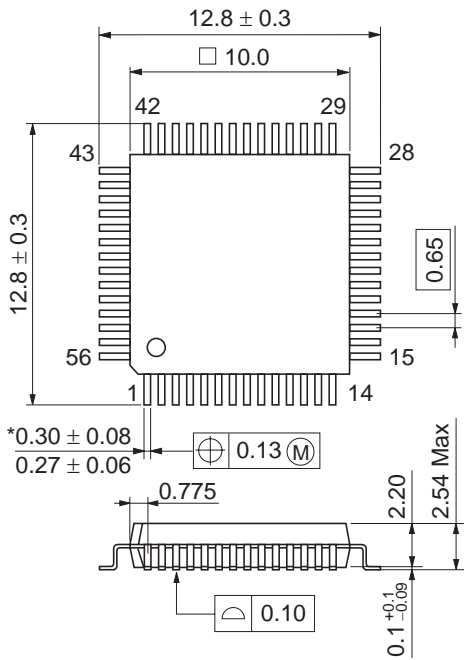
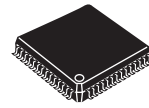

*Dimension including the plating thickness
Base material dimension

Package Code	FP-56A
JEDEC	—
JEITA	—
Mass (reference value)	0.5 g

EOL Product

Renesas Technology Corp. Sales Strategic Planning Div. Nippon Bldg., 2-6-2, Ohte-machi, Chiyoda-ku, Tokyo 100-0004, Japan

Keep safety first in your circuit designs!

1. Renesas Technology Corp. puts the maximum effort into making semiconductor products better and more reliable, but there is always the possibility that trouble may occur with them. Trouble with semiconductors may lead to personal injury, fire or property damage.
Remember to give due consideration to safety when making your circuit designs, with appropriate measures such as (i) placement of substitutive, auxiliary circuits, (ii) use of nonflammable material or (iii) prevention against any malfunction or mishap.

Notes regarding these materials

1. These materials are intended as a reference to assist our customers in the selection of the Renesas Technology Corp. product best suited to the customer's application; they do not convey any license under any intellectual property rights, or any other rights, belonging to Renesas Technology Corp. or a third party.
2. Renesas Technology Corp. assumes no responsibility for any damage, or infringement of any third-party's rights, originating in the use of any product data, diagrams, charts, programs, algorithms, or circuit application examples contained in these materials.
3. All information contained in these materials, including product data, diagrams, charts, programs and algorithms represents information on products at the time of publication of these materials, and are subject to change by Renesas Technology Corp. without notice due to product improvements or other reasons. It is therefore recommended that customers contact Renesas Technology Corp. or an authorized Renesas Technology Corp. product distributor for the latest product information before purchasing a product listed herein.
The information described here may contain technical inaccuracies or typographical errors.
Renesas Technology Corp. assumes no responsibility for any damage, liability, or other loss arising from these inaccuracies or errors.
Please also pay attention to information published by Renesas Technology Corp. by various means, including the Renesas Technology Corp. Semiconductor home page (<http://www.renesas.com>).
4. When using any or all of the information contained in these materials, including product data, diagrams, charts, programs, and algorithms, please be sure to evaluate all information as a total system before making a final decision on the applicability of the information and products. Renesas Technology Corp. assumes no responsibility for any damage, liability or other loss resulting from the information contained herein.
5. Renesas Technology Corp. semiconductors are not designed or manufactured for use in a device or system that is used under circumstances in which human life is potentially at stake. Please contact Renesas Technology Corp. or an authorized Renesas Technology Corp. product distributor when considering the use of a product contained herein for any specific purposes, such as apparatus or systems for transportation, vehicular, medical, aerospace, nuclear, or undersea repeater use.
6. The prior written approval of Renesas Technology Corp. is necessary to reprint or reproduce in whole or in part these materials.
7. If these products or technologies are subject to the Japanese export control restrictions, they must be exported under a license from the Japanese government and cannot be imported into a country other than the approved destination.
Any diversion or reexport contrary to the export control laws and regulations of Japan and/or the country of destination is prohibited.
8. Please contact Renesas Technology Corp. for further details on these materials or the products contained therein.



RENESAS SALES OFFICES

<http://www.renesas.com>

Refer to "<http://www.renesas.com/en/network>" for the latest and detailed information.

Renesas Technology America, Inc.
450 Holger Way, San Jose, CA 95134-1368, U.S.A
Tel: <1> (408) 382-7500, Fax: <1> (408) 382-7501

Renesas Technology Europe Limited
Dukes Meadow, Millboard Road, Bourne End, Buckinghamshire, SL8 5FH, U.K.
Tel: <44> (1628) 585-100, Fax: <44> (1628) 585-900

Renesas Technology Hong Kong Ltd.
7th Floor, North Tower, World Finance Centre, Harbour City, 1 Canton Road, Tsimshatsui, Kowloon, Hong Kong
Tel: <852> 2265-6688, Fax: <852> 2730-6071

Renesas Technology Taiwan Co., Ltd.
10th Floor, No.99, Fushing North Road, Taipei, Taiwan
Tel: <886> (2) 2715-2888, Fax: <886> (2) 2713-2999

Renesas Technology (Shanghai) Co., Ltd.
Unit2607 Ruijing Building, No.205 Maoming Road (S), Shanghai 200020, China
Tel: <86> (21) 6472-1001, Fax: <86> (21) 6415-2952

Renesas Technology Singapore Pte. Ltd.
1 Harbour Front Avenue, #06-10, Keppel Bay Tower, Singapore 098632
Tel: <65> 6213-0200, Fax: <65> 6278-8001