

To our customers,

---

## Old Company Name in Catalogs and Other Documents

---

On April 1<sup>st</sup>, 2010, NEC Electronics Corporation merged with Renesas Technology Corporation, and Renesas Electronics Corporation took over all the business of both companies. Therefore, although the old company name remains in this document, it is a valid Renesas Electronics document. We appreciate your understanding.

Renesas Electronics website: <http://www.renesas.com>

April 1<sup>st</sup>, 2010  
Renesas Electronics Corporation

Issued by: Renesas Electronics Corporation (<http://www.renesas.com>)

Send any inquiries to <http://www.renesas.com/inquiry>.

## Notice

1. All information included in this document is current as of the date this document is issued. Such information, however, is subject to change without any prior notice. Before purchasing or using any Renesas Electronics products listed herein, please confirm the latest product information with a Renesas Electronics sales office. Also, please pay regular and careful attention to additional and different information to be disclosed by Renesas Electronics such as that disclosed through our website.
2. Renesas Electronics does not assume any liability for infringement of patents, copyrights, or other intellectual property rights of third parties by or arising from the use of Renesas Electronics products or technical information described in this document. No license, express, implied or otherwise, is granted hereby under any patents, copyrights or other intellectual property rights of Renesas Electronics or others.
3. You should not alter, modify, copy, or otherwise misappropriate any Renesas Electronics product, whether in whole or in part.
4. Descriptions of circuits, software and other related information in this document are provided only to illustrate the operation of semiconductor products and application examples. You are fully responsible for the incorporation of these circuits, software, and information in the design of your equipment. Renesas Electronics assumes no responsibility for any losses incurred by you or third parties arising from the use of these circuits, software, or information.
5. When exporting the products or technology described in this document, you should comply with the applicable export control laws and regulations and follow the procedures required by such laws and regulations. You should not use Renesas Electronics products or the technology described in this document for any purpose relating to military applications or use by the military, including but not limited to the development of weapons of mass destruction. Renesas Electronics products and technology may not be used for or incorporated into any products or systems whose manufacture, use, or sale is prohibited under any applicable domestic or foreign laws or regulations.
6. Renesas Electronics has used reasonable care in preparing the information included in this document, but Renesas Electronics does not warrant that such information is error free. Renesas Electronics assumes no liability whatsoever for any damages incurred by you resulting from errors in or omissions from the information included herein.
7. Renesas Electronics products are classified according to the following three quality grades: “Standard”, “High Quality”, and “Specific”. The recommended applications for each Renesas Electronics product depends on the product’s quality grade, as indicated below. You must check the quality grade of each Renesas Electronics product before using it in a particular application. You may not use any Renesas Electronics product for any application categorized as “Specific” without the prior written consent of Renesas Electronics. Further, you may not use any Renesas Electronics product for any application for which it is not intended without the prior written consent of Renesas Electronics. Renesas Electronics shall not be in any way liable for any damages or losses incurred by you or third parties arising from the use of any Renesas Electronics product for an application categorized as “Specific” or for which the product is not intended where you have failed to obtain the prior written consent of Renesas Electronics. The quality grade of each Renesas Electronics product is “Standard” unless otherwise expressly specified in a Renesas Electronics data sheets or data books, etc.
  - “Standard”: Computers; office equipment; communications equipment; test and measurement equipment; audio and visual equipment; home electronic appliances; machine tools; personal electronic equipment; and industrial robots.
  - “High Quality”: Transportation equipment (automobiles, trains, ships, etc.); traffic control systems; anti-disaster systems; anti-crime systems; safety equipment; and medical equipment not specifically designed for life support.
  - “Specific”: Aircraft; aerospace equipment; submersible repeaters; nuclear reactor control systems; medical equipment or systems for life support (e.g. artificial life support devices or systems), surgical implantations, or healthcare intervention (e.g. excision, etc.), and any other applications or purposes that pose a direct threat to human life.
8. You should use the Renesas Electronics products described in this document within the range specified by Renesas Electronics, especially with respect to the maximum rating, operating supply voltage range, movement power voltage range, heat radiation characteristics, installation and other product characteristics. Renesas Electronics shall have no liability for malfunctions or damages arising out of the use of Renesas Electronics products beyond such specified ranges.
9. Although Renesas Electronics endeavors to improve the quality and reliability of its products, semiconductor products have specific characteristics such as the occurrence of failure at a certain rate and malfunctions under certain use conditions. Further, Renesas Electronics products are not subject to radiation resistance design. Please be sure to implement safety measures to guard them against the possibility of physical injury, and injury or damage caused by fire in the event of the failure of a Renesas Electronics product, such as safety design for hardware and software including but not limited to redundancy, fire control and malfunction prevention, appropriate treatment for aging degradation or any other appropriate measures. Because the evaluation of microcomputer software alone is very difficult, please evaluate the safety of the final products or system manufactured by you.
10. Please contact a Renesas Electronics sales office for details as to environmental matters such as the environmental compatibility of each Renesas Electronics product. Please use Renesas Electronics products in compliance with all applicable laws and regulations that regulate the inclusion or use of controlled substances, including without limitation, the EU RoHS Directive. Renesas Electronics assumes no liability for damages or losses occurring as a result of your noncompliance with applicable laws and regulations.
11. This document may not be reproduced or duplicated, in any form, in whole or in part, without prior written consent of Renesas Electronics.
12. Please contact a Renesas Electronics sales office if you have any questions regarding the information contained in this document or Renesas Electronics products, or if you have any other inquiries.

(Note 1) “Renesas Electronics” as used in this document means Renesas Electronics Corporation and also includes its majority-owned subsidiaries.

(Note 2) “Renesas Electronics product(s)” means any product developed or manufactured by or for Renesas Electronics.

To all our customers

---

## **Regarding the change of names mentioned in the document, such as Mitsubishi Electric and Mitsubishi XX, to Renesas Technology Corp.**

---

The semiconductor operations of Hitachi and Mitsubishi Electric were transferred to Renesas Technology Corporation on April 1st 2003. These operations include microcomputer, logic, analog and discrete devices, and memory chips other than DRAMs (flash memory, SRAMs etc.) Accordingly, although Mitsubishi Electric, Mitsubishi Electric Corporation, Mitsubishi Semiconductors, and other Mitsubishi brand names are mentioned in the document, these names have in fact all been changed to Renesas Technology Corp. Thank you for your understanding. Except for our corporate trademark, logo and corporate statement, no changes whatsoever have been made to the contents of the document, and these changes do not constitute any alteration to the contents of the document itself.

Note : Mitsubishi Electric will continue the business operations of high frequency & optical devices and power devices.

Renesas Technology Corp.  
Customer Support Dept.  
April 1, 2003

# FS5UM-5

HIGH-SPEED SWITCHING USE

## FS5UM-5



- V<sub>DSS</sub> ..... 250V
- r<sub>DS (ON)</sub> (MAX) ..... 1.3Ω
- I<sub>D</sub> ..... 5A

## OUTLINE DRAWING

Dimensions in mm

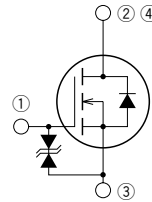
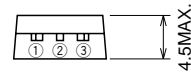
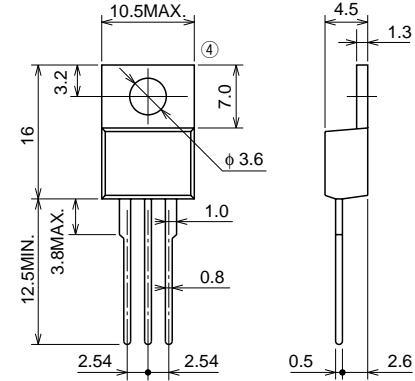

- ① GATE
- ② DRAIN
- ③ SOURCE
- ④ DRAIN

TO-220

## APPLICATION

SMPS, DC-DC Converter, battery charger, power supply of printer, copier, HDD, FDD, TV, VCR, personal computer etc.

## MAXIMUM RATINGS (T<sub>c</sub> = 25°C)

| Symbol           | Parameter                 | Conditions           | Ratings    | Unit |
|------------------|---------------------------|----------------------|------------|------|
| V <sub>DSS</sub> | Drain-source voltage      | V <sub>GS</sub> = 0V | 250        | V    |
| V <sub>GSS</sub> | Gate-source voltage       | V <sub>DS</sub> = 0V | ±30        | V    |
| I <sub>D</sub>   | Drain current             |                      | 5          | A    |
| I <sub>DM</sub>  | Drain current (Pulsed)    |                      | 15         | A    |
| P <sub>D</sub>   | Maximum power dissipation |                      | 60         | W    |
| T <sub>ch</sub>  | Channel temperature       |                      | -55 ~ +150 | °C   |
| T <sub>stg</sub> | Storage temperature       |                      | -55 ~ +150 | °C   |
| —                | Weight                    | Typical value        | 2.0        | g    |

**ELECTRICAL CHARACTERISTICS** (T<sub>ch</sub> = 25°C)

| Symbol                 | Parameter                        | Test conditions  | Limits |      |      | Unit |
|------------------------|----------------------------------|--|--------|------|------|------|
|                        |                                  |  | Min.   | Typ. | Max. |      |
| V (BR) DSS             | Drain-source breakdown voltage   | I <sub>D</sub> = 1mA, V <sub>GS</sub> = 0V   | 250    | —    | —    | V    |
| V (BR) GSS             | Gate-source breakdown voltage    | I <sub>G</sub> = ±100μA, V <sub>DS</sub> = 0V  | ±30    | —    | —    | V    |
| I <sub>GSS</sub>       | Gate-source leakage current      | V <sub>GS</sub> = ±25V, V <sub>DS</sub> = 0V   | —      | —    | ±10  | mA   |
| I <sub>DSS</sub>       | Drain-source leakage current     | V <sub>DS</sub> = 250V, V <sub>GS</sub> = 0V   | —      | —    | 1    | mA   |
| V <sub>GS</sub> (th)   | Gate-source threshold voltage    | I <sub>D</sub> = 1mA, V <sub>DS</sub> = 10V  | 2      | 3    | 4    | V    |
| r <sub>DS</sub> (ON)   | Drain-source on-state resistance | I <sub>D</sub> = 2A, V <sub>GS</sub> = 10V   | —      | 1.0  | 1.3  | W    |
| V <sub>DS</sub> (ON)   | Drain-source on-state voltage    | I <sub>D</sub> = 2A, V <sub>GS</sub> = 10V   | —      | 2.0  | 2.6  | V    |
| y <sub>fs</sub>        | Forward transfer admittance      | I <sub>D</sub> = 2A, V <sub>DS</sub> = 10V   | 1.6    | 2.5  | —    | S    |
| C <sub>iss</sub>       | Input capacitance                | V <sub>DS</sub> = 25V, V <sub>GS</sub> = 0V, f = 1MHz  | —      | 270  | —    | pF   |
| C <sub>oss</sub>       | Output capacitance               |  | —      | 55   | —    | pF   |
| C <sub>rss</sub>       | Reverse transfer capacitance     |  | —      | 10   | —    | pF   |
| t <sub>d</sub> (on)    | Turn-on delay time               | V <sub>DD</sub> = 150V, I <sub>D</sub> = 2A, V <sub>GS</sub> = 10V, R <sub>GEN</sub> = R <sub>GS</sub> = 50Ω | —      | 11   | —    | ns   |
| t <sub>r</sub>         | Rise time                        |  | —      | 13   | —    | ns   |
| t <sub>d</sub> (off)   | Turn-off delay time              |  | —      | 32   | —    | ns   |
| t <sub>f</sub>         | Fall time                        |  | —      | 22   | —    | ns   |
| V <sub>SD</sub>        | Source-drain voltage             | I <sub>S</sub> = 2A, V <sub>GS</sub> = 0V  | —      | 1.5  | 2.0  | V    |
| R <sub>th</sub> (ch-c) | Thermal resistance               | Channel to case  | —      | —    | 2.08 | °C/W |

**PERFORMANCE CURVES**

**POWER DISSIPATION DERATING CURVE**

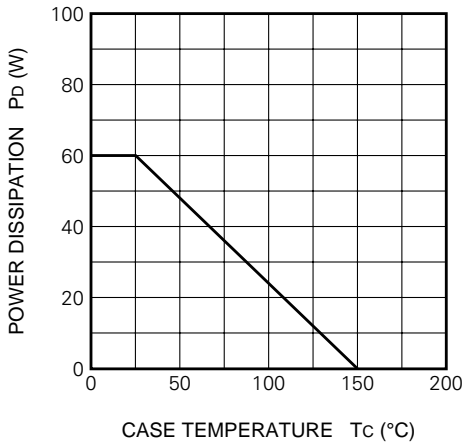

**MAXIMUM SAFE OPERATING AREA**

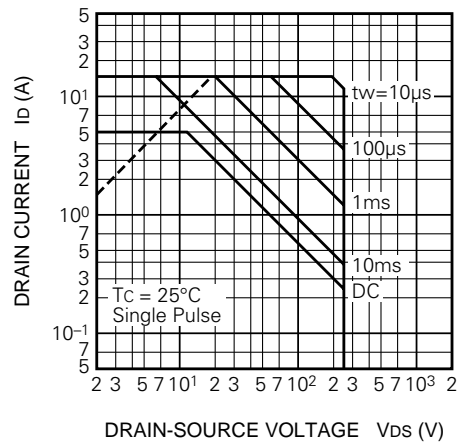

**OUTPUT CHARACTERISTICS (TYPICAL)**

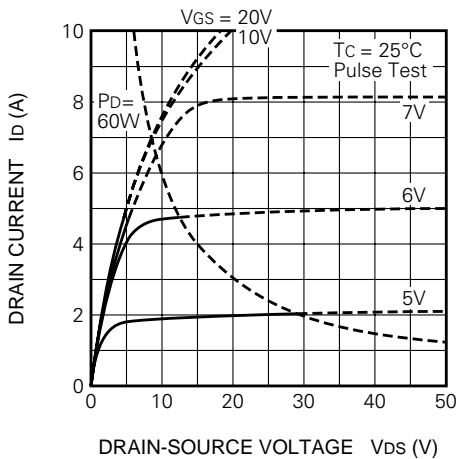

**OUTPUT CHARACTERISTICS (TYPICAL)**

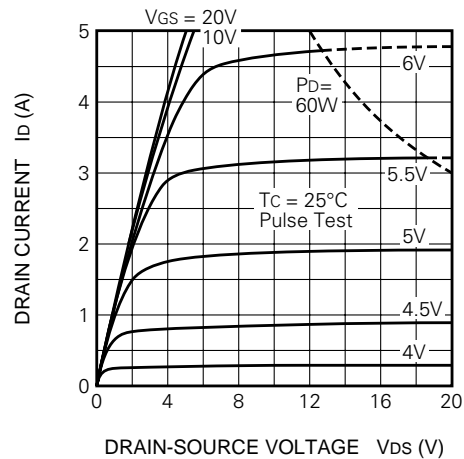

ON-STATE VOLTAGE VS. GATE-SOURCE VOLTAGE (TYPICAL)

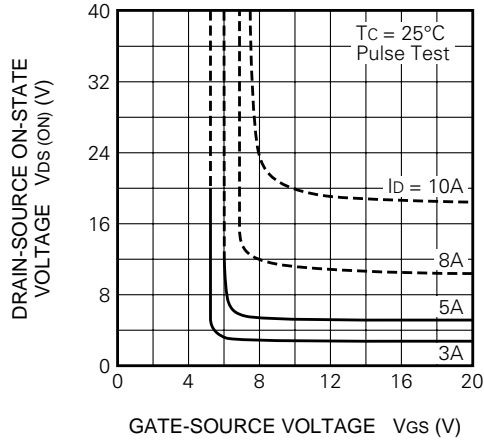

ON-STATE RESISTANCE VS. DRAIN CURRENT (TYPICAL)

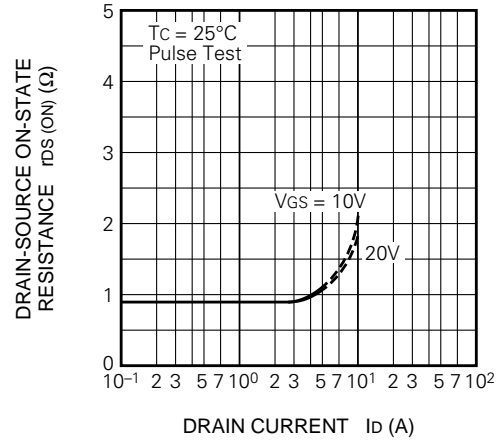

TRANSFER CHARACTERISTICS (TYPICAL)

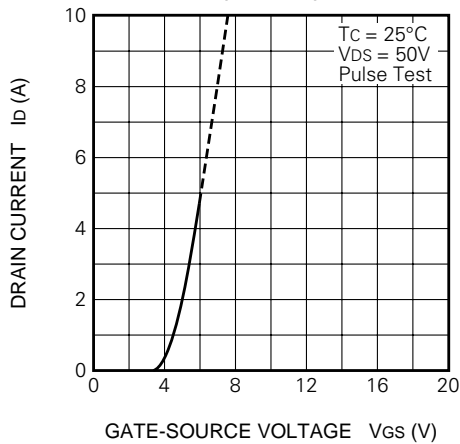

FORWARD TRANSFER ADMITTANCE VS. DRAIN CURRENT (TYPICAL)

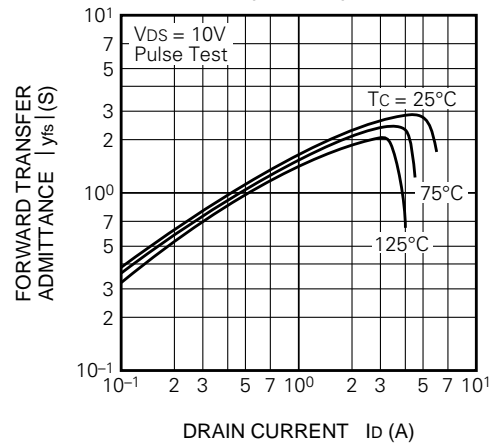

CAPACITANCE VS. DRAIN-SOURCE VOLTAGE (TYPICAL)

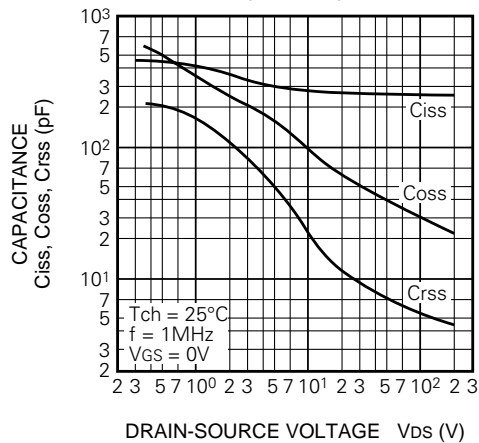

SWITCHING CHARACTERISTICS (TYPICAL)

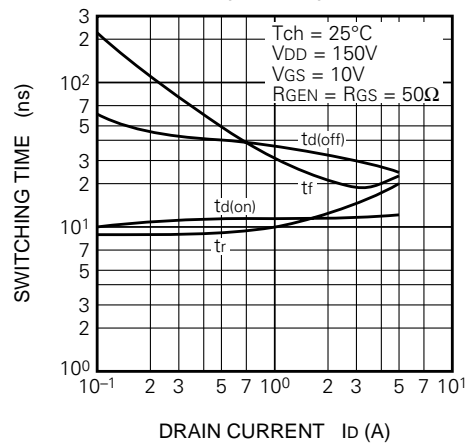

**GATE-SOURCE VOLTAGE VS. GATE CHARGE (TYPICAL)**

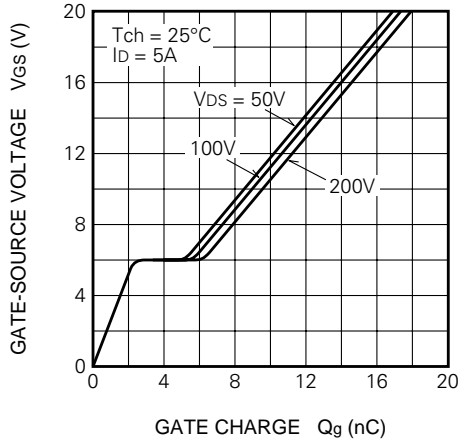

**SOURCE-DRAIN DIODE FORWARD CHARACTERISTICS (TYPICAL)**

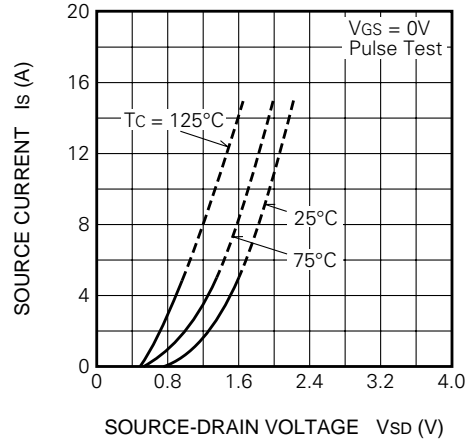

**ON-STATE RESISTANCE VS. CHANNEL TEMPERATURE (TYPICAL)**

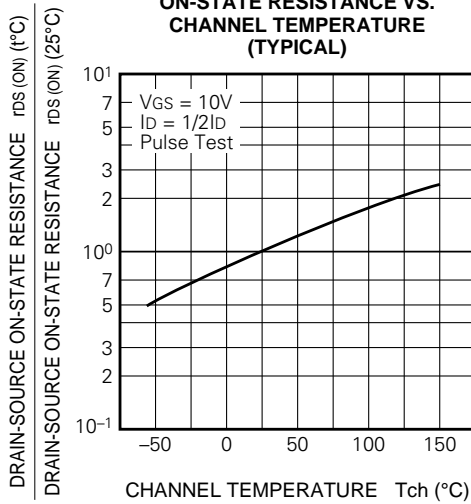

**THRESHOLD VOLTAGE VS. CHANNEL TEMPERATURE (TYPICAL)**

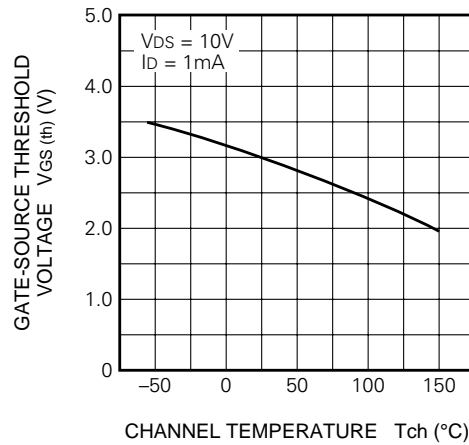

**BREAKDOWN VOLTAGE VS. CHANNEL TEMPERATURE (TYPICAL)**

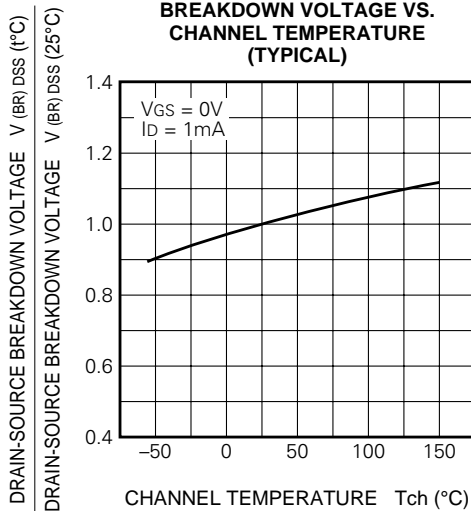

**TRANSIENT THERMAL IMPEDANCE CHARACTERISTICS**

