

EL8108

Video Distribution Amplifier

**OBSOLETE PRODUCT
NO RECOMMENDED REPLACEMENT**
contact our Technical Support Center at
1-888-INTERSIL or www.intersil.com/tsc

FN7417
Rev 2.00
January 29, 2008

The EL8108 is a dual current feedback operational amplifier designed for video distribution solutions. This device features a high drive capability of 450mA while consuming only 5mA of supply current per amplifier and operating from a single 5V to 12V supply.

The EL8108 is available in the industry standard 8 Ld SOIC as well as the thermally-enhanced 16 Ld QFN package. Both are specified for operation over the full -40°C to +85°C temperature range. The EL8108 has control pins C0 and C1 for controlling the bias and enable/disable of the outputs.

The EL8108 is ideal for driving multiple video loads while maintaining linearity.

Pinouts

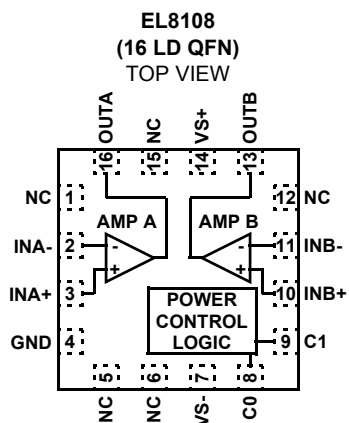
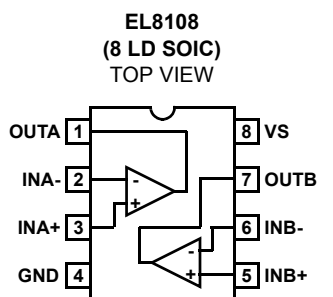

Features

- Drives up to 450mA from a +12V supply
- 20V_{P-P} differential output drive into 100Ω
- -85dBc typical driver output distortion at full output at 150kHz
- -70dBc typical driver output distortion at 3.75MHz
- Low quiescent current of 5mA per amplifier
- 300MHz bandwidth
- Pb-free available (RoHS compliant)

Applications

- Video distribution amplifiers

TABLE 1.

150Ω	150Ω	DIFF GAIN	DIFF PHASE
1	0	0.03	0.01
1	1	0.03	0.01
2	1	0.05	0.02
2	2	0.06	0.03
3	2	0.08	0.03
3	3	0.11	0.03
2	0	0.04	0.01
3	0	0.05	0.02
4	0	0.07	0.02
5	0	0.08	0.03
6	0	0.10	0.03

Ordering Information

PART NUMBER	PART MARKING	TEMPERATURE RANGE (°c)	PACKAGE	PKG. DWG. #
EL8108IS	8108IS	-40 to +85	8 Ld SOIC	MDP0027
EL8108IS-T7*	8108IS	-40 to +85	8 Ld SOIC	MDP0027
EL8108IS-T13*	8108IS	-40 to +85	8 Ld SOIC	MDP0027
EL8108ISZ (Note)	8108ISZ	-40 to +85	8 Ld SOIC (Pb-free)	MDP0027
EL8108ISZ-T7* (Note)	8108ISZ	-40 to +85	8 Ld SOIC (Pb-free)	MDP0027
EL8108ISZ-T13* (Note)	8108ISZ	-40 to +85	8 Ld SOIC (Pb-free)	MDP0027
EL8108IL	8108IL	-40 to +85	16 Ld 4x4 QFN	MDP0046
EL8108IL-T7*	8108IL	-40 to +85	16 Ld 4x4 QFN	MDP0046
EL8108IL-T13*	8108IL	-40 to +85	16 Ld 4x4 QFN	MDP0046
EL8108ILZ (Note)	8108ILZ	-40 to +85	16 Ld 4x4 QFN (Pb-free)	MDP0046
EL8108ILZ-T7* (Note)	8108ILZ	-40 to +85	16 Ld 4x4 QFN (Pb-free)	MDP0046
EL8108ILZ-T13* (Note)	8108ILZ	-40 to +85	16 Ld 4x4 QFN (Pb-free)	MDP0046

* Please refer to TB347 for details on reel specifications.

NOTE: These Intersil Pb-free plastic packaged products employ special Pb-free material sets; molding compounds/die attach materials and 100% matte tin plate PLUS ANNEAL - e3 termination finish, which is RoHS compliant and compatible with both SnPb and Pb-free soldering operations. Intersil Pb-free products are MSL classified at Pb-free peak reflow temperatures that meet or exceed the Pb-free requirements of IPC/JEDEC J STD-020.

Absolute Maximum Ratings (T_A = +25°C)

V _{S+} Voltage to Ground	-0.3V to +13.2V
V _{IN+} Voltage	GND to V _{S+}
Current into any Input	8mA
Continuous Output Current	75mA

Thermal Information

Ambient Operating Temperature Range	-40°C to +85°C
Storage Temperature Range	-60°C to +150°C
Operating Junction Temperature	+150°C
Power Dissipation	See Curves
Pb-free Reflow Profile	see link below http://www.intersil.com/pbfree/Pb-FreeReflow.asp

CAUTION: Do not operate at or near the maximum ratings listed for extended periods of time. Exposure to such conditions may adversely impact product reliability and result in failures not covered by warranty.

IMPORTANT NOTE: All parameters having Min/Max specifications are guaranteed. Typical values are for information purposes only. Unless otherwise noted, all tests are at the specified temperature and are pulsed tests, therefore: T_J = T_C = T_A

Electrical Specifications V_S = 12V, R_F = 750Ω, R_L = 100Ω connected to mid supply, T_A = +25°C, unless otherwise specified.

PARAMETER	DESCRIPTION	CONDITIONS	MIN	TYP	MAX	UNIT
AC PERFORMANCE						
BW	-3dB Bandwidth	R _F = 500Ω, A _V = +2		200		MHz
		R _F = 500Ω, A _V = +4		150		MHz
HD	Total Harmonic Distortion, Differential	f = 200kHz, V _O = 16V _{P-P} , R _L = 50Ω	-72	-83		dBc
		f = 4MHz, V _O = 2V _{P-P} , R _L = 100Ω		-70		dBc
		f = 8MHz, V _O = 2V _{P-P} , R _L = 100Ω		-60		dBc
		f = 16MHz, V _O = 2V _{P-P} , R _L = 100Ω		-50		dBc
SR	Slew Rate, Single-ended	V _{OUT} from -3V to +3V	600	800	1100	V/μs
DC PERFORMANCE						
V _{OS}	Offset Voltage		-25		+25	mV
ΔV _{OS}	V _{OS} Mismatch		-3		+3	mV
R _{OL}	Transimpedance	V _{OUT} from -4.5V to +4.5V	0.7	1.4	2.5	MΩ
INPUT CHARACTERISTICS						
I _{B+}	Non-inverting Input Bias Current		-5		5	μA
I _{B-}	Inverting Input Bias Current		-20	5	+20	μA
ΔI _{B-}	I _{B-} Mismatch		-18	0	+18	μA
e _N	Input Noise Voltage			6		nV√Hz
i _N	-Input Noise Current			13		pA√Hz
OUTPUT CHARACTERISTICS						
V _{OUT}	Loaded Output Swing (Single-ended)	V _S = ±6V, R _L = 100Ω to GND	±4.8	±5		V
		V _S = ±6V, R _L = 25Ω to GND		±4.7		V
I _{OUT}	Output Current	R _L = 0Ω		450		mA
SUPPLY						
V _S	Supply Voltage	Single supply	4.5		13	V
I _S (EL8108IS only)	Supply Current, Maximum Setting	All outputs at mid supply	11	14.3	18	mA
SUPPLY (EL8108IL ONLY)						
I _{S+} (Full Power)	Positive Supply Current per Amplifier	All outputs at 0V, C ₀ = C ₁ = 0V	11	14.3	18	mA
I _{S+} (Medium Power)	Positive Supply Current per Amplifier	All outputs at 0V, C ₀ = 5V, C ₁ = 0V	7	8.9	11	mA
I _{S+} (Low Power)	Positive Supply Current per Amplifier	All outputs at 0V, C ₀ = 0V, C ₁ = 5V	3.7	4.5	5.5	mA
I _{S+} (Power Down)	Positive Supply Current per Amplifier	All outputs at 0V, C ₀ = C ₁ = 5V		0.1	0.5	mA
I _{INH} , C ₀ or C ₁	C ₀ , C ₁ Input Current, High	C ₀ , C ₁ = 5V	90	125	160	μA
I _{INL} , C ₀ or C ₁	C ₀ , C ₁ Input Current, Low	C ₀ , C ₁ = 0V	-5		+5	μA

Typical Performance Curves

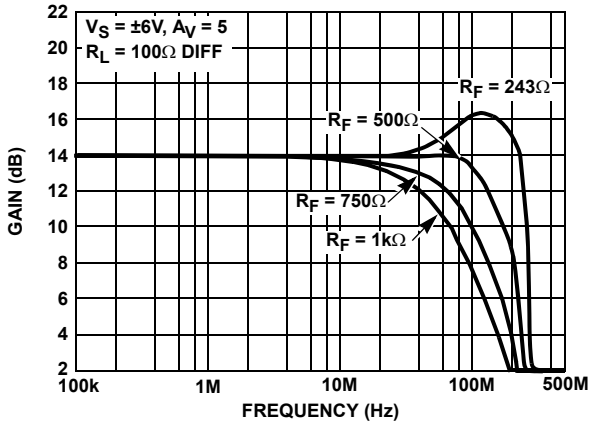

FIGURE 1. DIFFERENTIAL FREQUENCY RESPONSE WITH VARIOUS R_F (FULL POWER MODE)

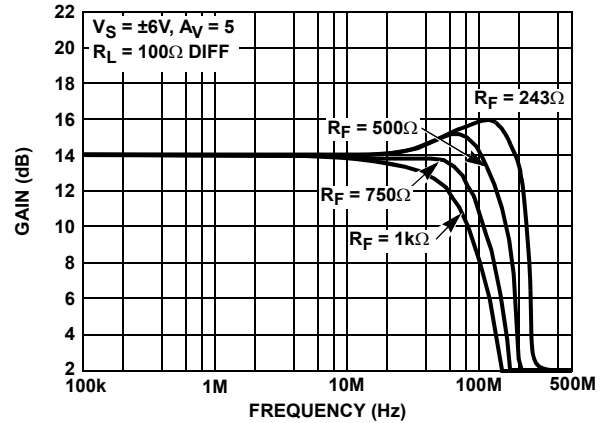

FIGURE 2. DIFFERENTIAL FREQUENCY RESPONSE WITH VARIOUS R_F (3/4 POWER MODE)

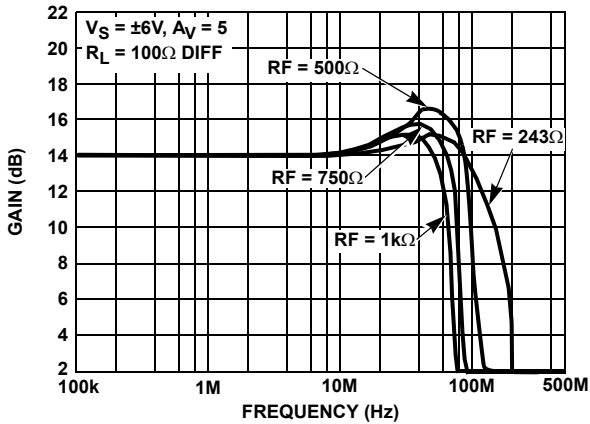

FIGURE 3. DIFFERENTIAL FREQUENCY RESPONSE WITH VARIOUS R_F (1/2 POWER MODE)

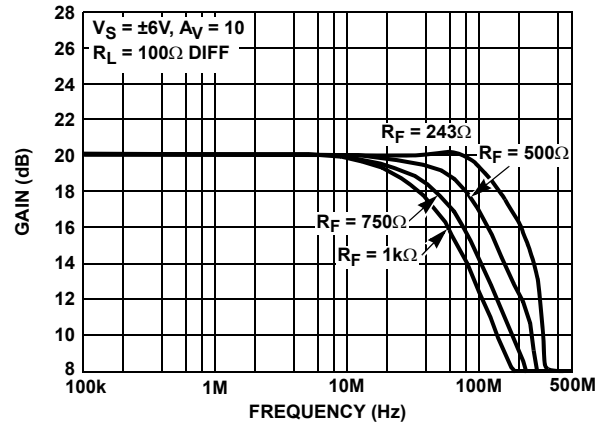

FIGURE 4. DIFFERENTIAL FREQUENCY RESPONSE WITH VARIOUS R_F (FULL POWER MODE)

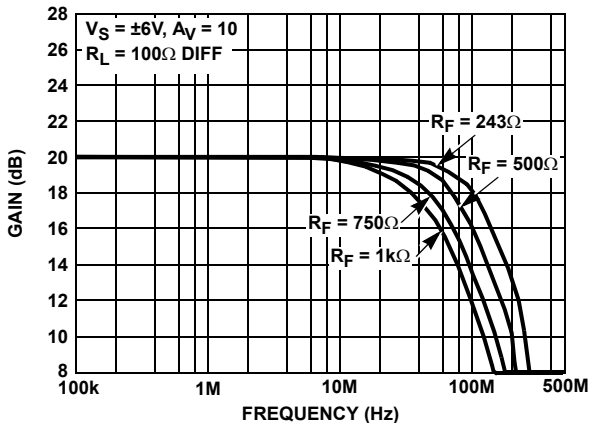

FIGURE 5. DIFFERENTIAL FREQUENCY RESPONSE WITH VARIOUS R_F (3/4 POWER MODE)

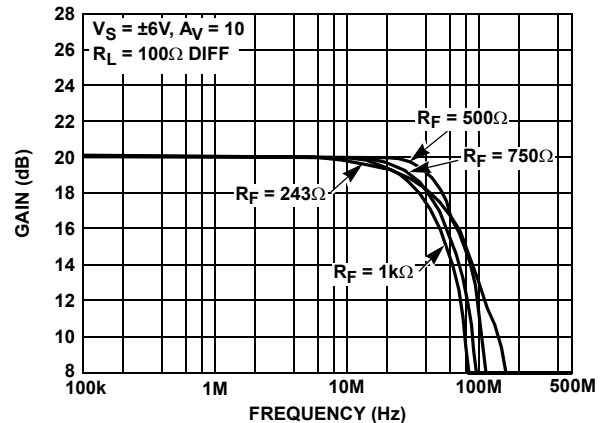

FIGURE 6. DIFFERENTIAL FREQUENCY RESPONSE WITH VARIOUS R_F (1/2 POWER MODE)

Typical Performance Curves (Continued)

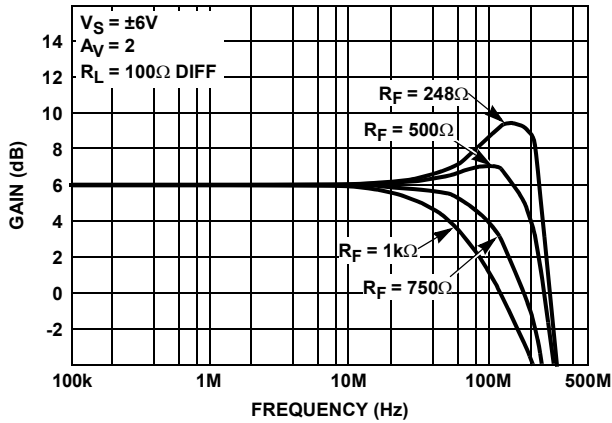

FIGURE 7. DIFFERENTIAL FREQUENCY RESPONSE WITH VARIOUS R_F

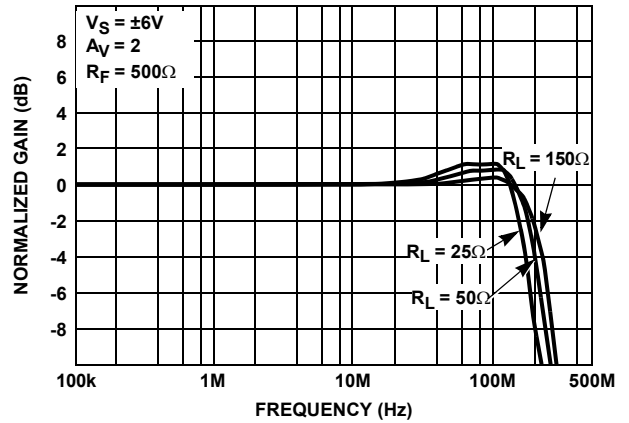

FIGURE 8. FREQUENCY RESPONSE FOR VARIOUS R_{LOAD}

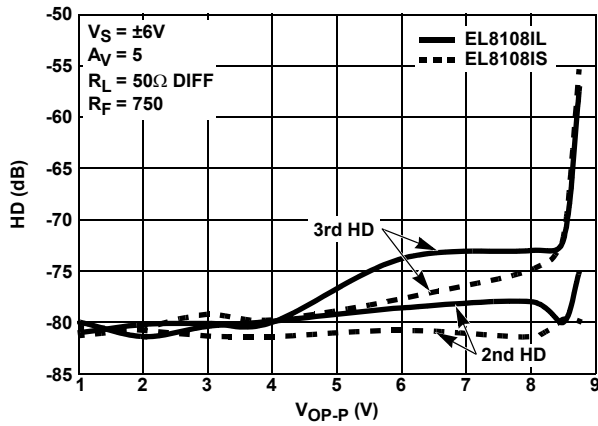

FIGURE 9. DISTORTION BETWEEN EL8108IL vs EL8108IS AT 2MHz

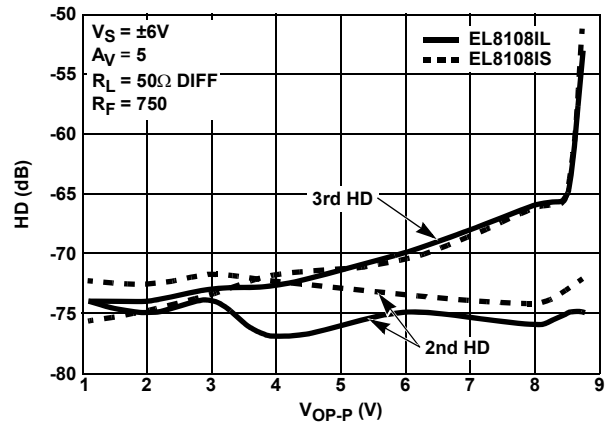

FIGURE 10. DISTORTION BETWEEN EL8108IL vs EL8108IS AT 3MHz

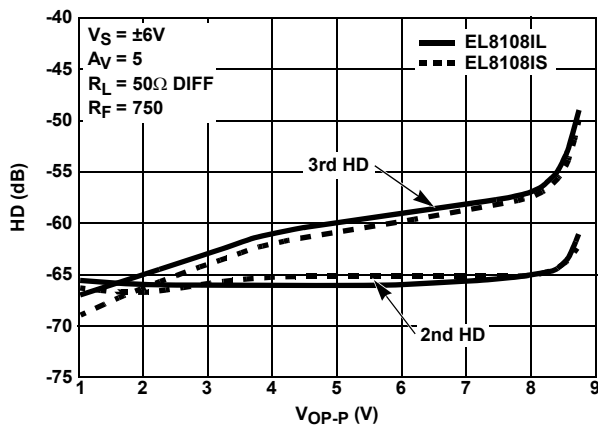

FIGURE 11. DISTORTION BETWEEN EL8108IL vs EL8108IS AT 5MHz

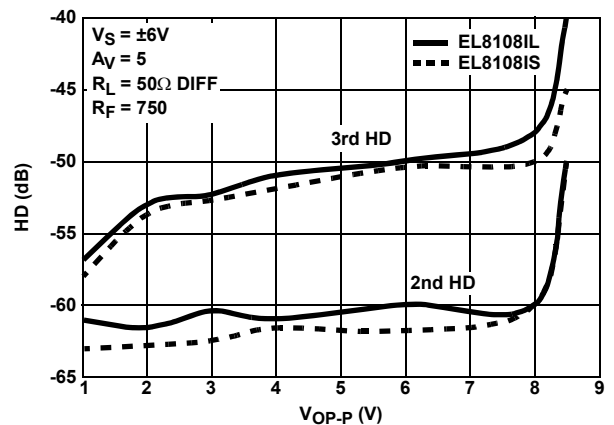

FIGURE 12. DISTORTION BETWEEN EL8108IL vs EL8108IS AT 10MHz

Typical Performance Curves (Continued)

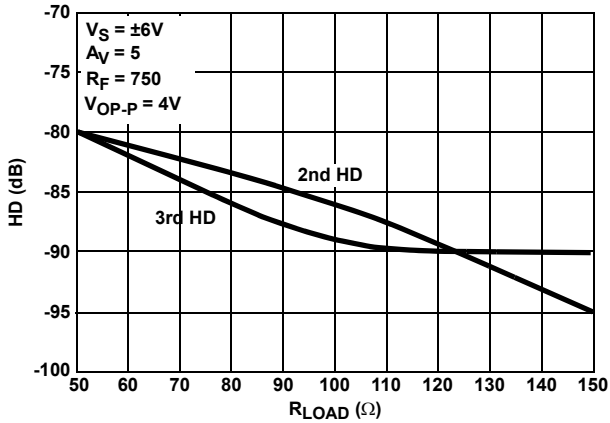

FIGURE 13. 2nd AND 3rd HARMONIC DISTORTION vs R_{LOAD} @ 2MHz (EL8108IL)

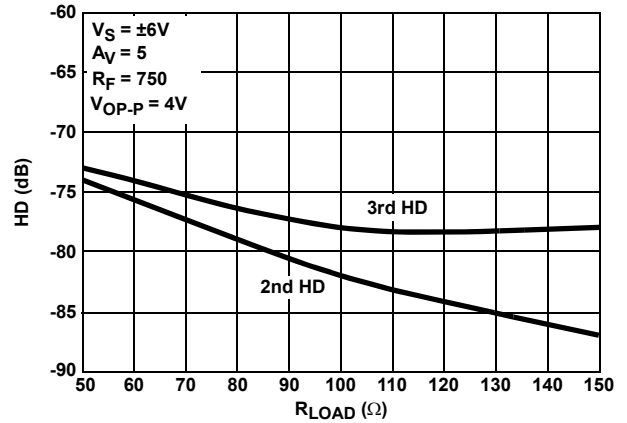

FIGURE 14. 2nd AND 3rd HARMONIC DISTORTION vs R_{LOAD} @ 3MHz (EL8108IL)

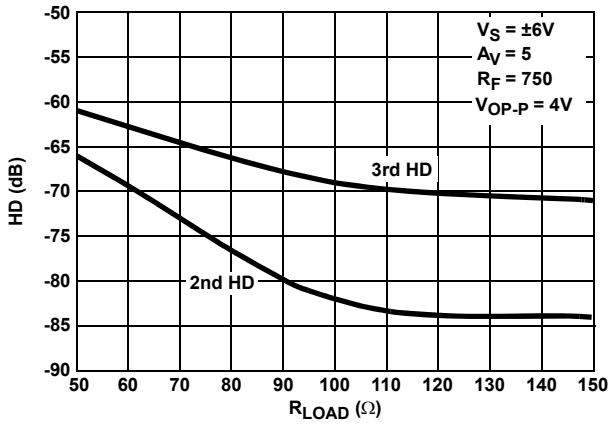

FIGURE 15. 2nd AND 3rd HARMONIC DISTORTION vs R_{LOAD} @ 5MHz (EL8108IL)

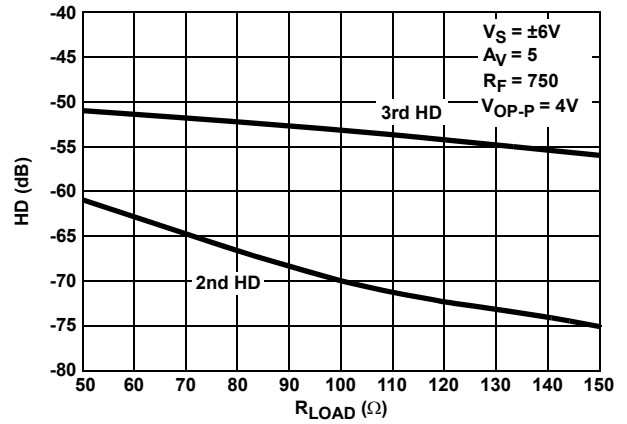

FIGURE 16. 2nd AND 3rd HARMONIC DISTORTION vs R_{LOAD} @ 10MHz (EL8108IL)

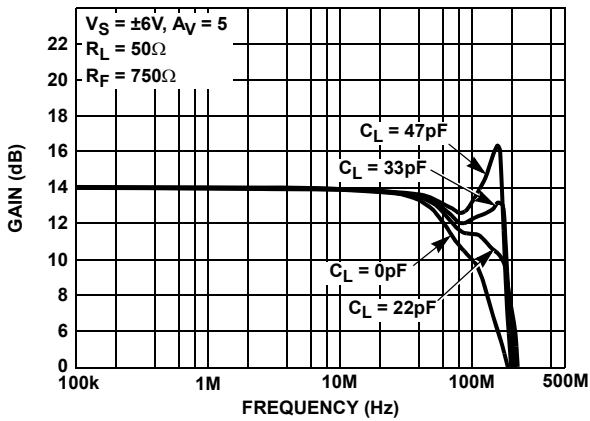

FIGURE 17. FREQUENCY RESPONSE WITH VARIOUS C_L

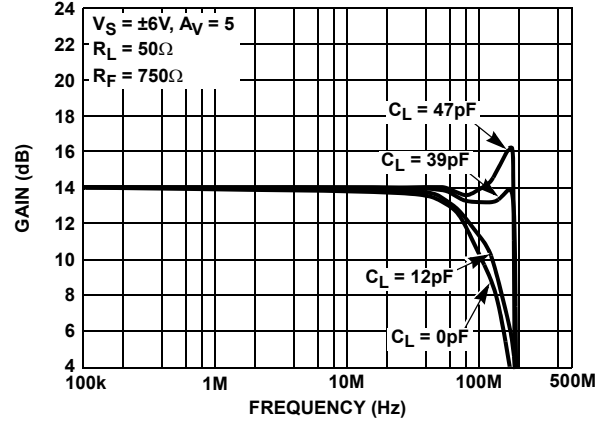

FIGURE 18. FREQUENCY RESPONSE vs VARIOUS C_L (3/4 POWER MODE)

Typical Performance Curves (Continued)

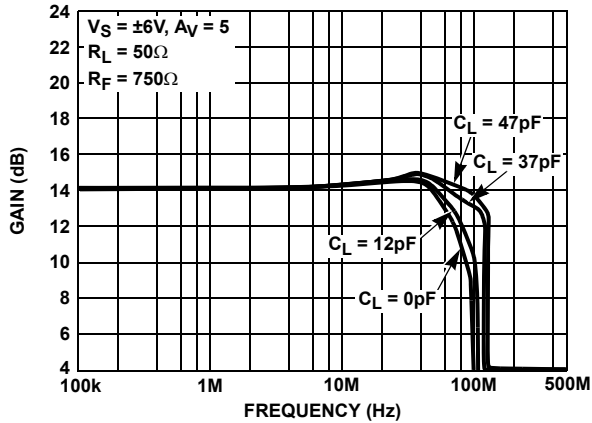

FIGURE 19. FREQUENCY RESPONSE WITH VARIOUS C_L (1/2 POWER MODE)

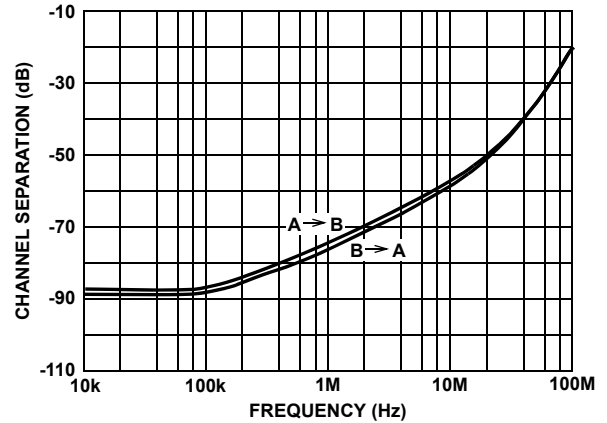

FIGURE 20. CHANNEL SEPARATION vs FREQUENCY

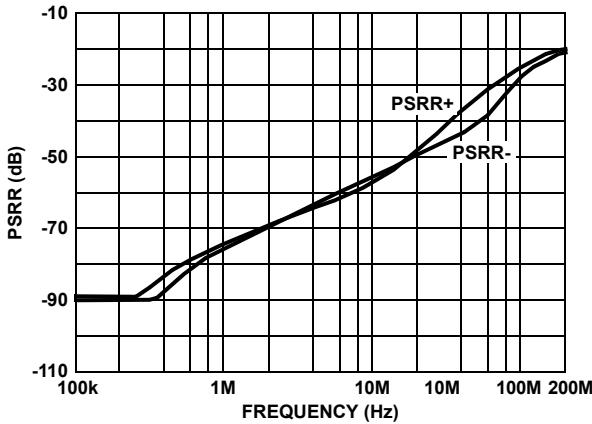

FIGURE 21. PSRR vs FREQUENCY

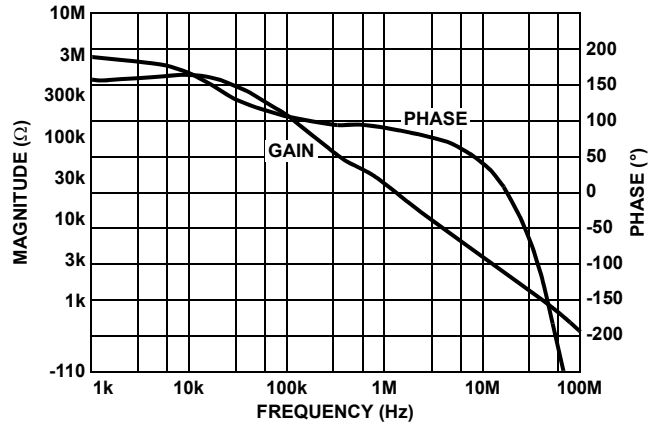

FIGURE 22. TRANSIMPEDANCE (R_{OL}) vs FREQUENCY

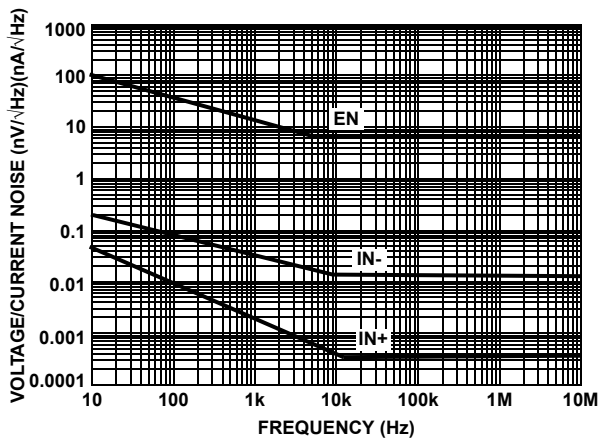

FIGURE 23. VOLTAGE AND CURRENT NOISE vs FREQUENCY

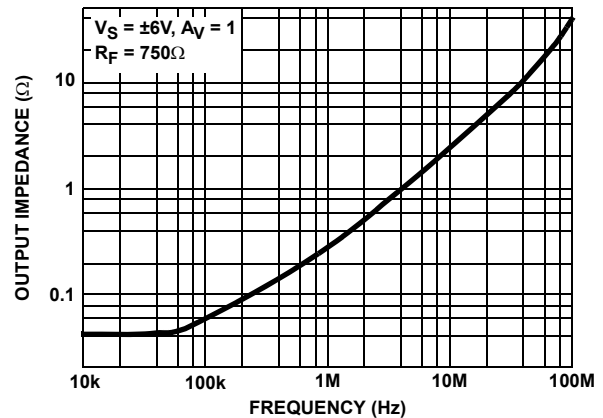

FIGURE 24. OUTPUT IMPEDANCE vs FREQUENCY

Typical Performance Curves (Continued)

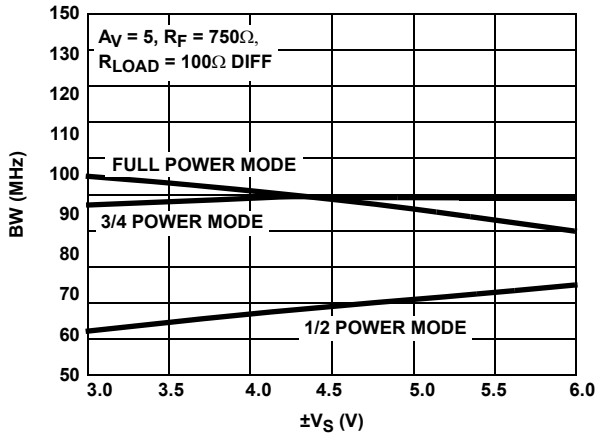

FIGURE 25. DIFFERENTIAL BANDWIDTH vs SUPPLY VOLTAGE

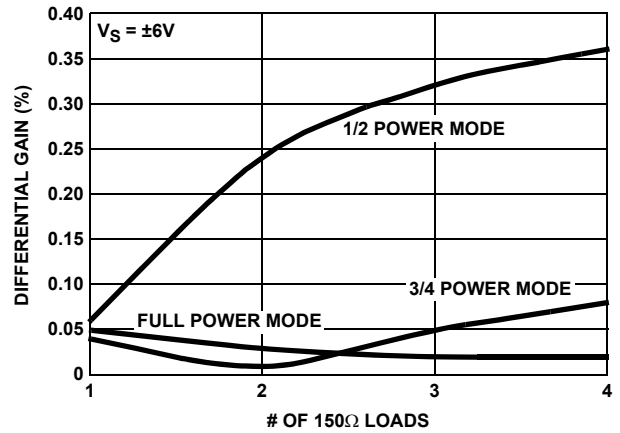

FIGURE 26. DIFFERENTIAL GAIN

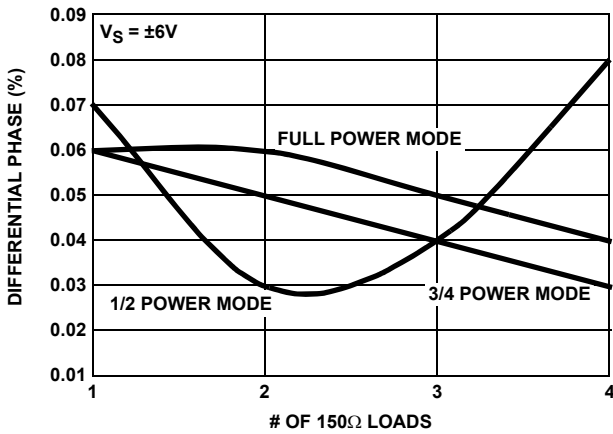

FIGURE 27. DIFFERENTIAL PHASE

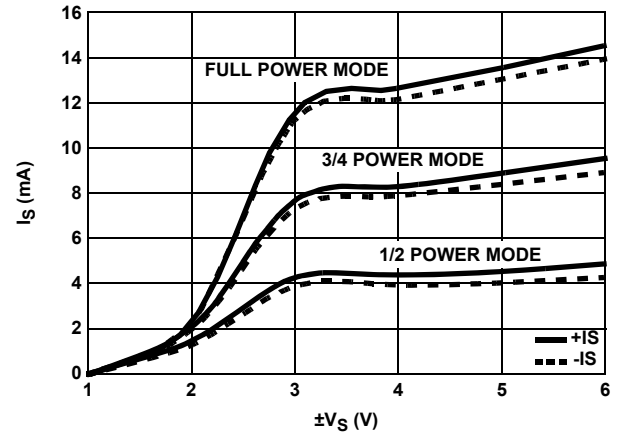

FIGURE 28. SUPPLY CURRENT vs SUPPLY VOLTAGE

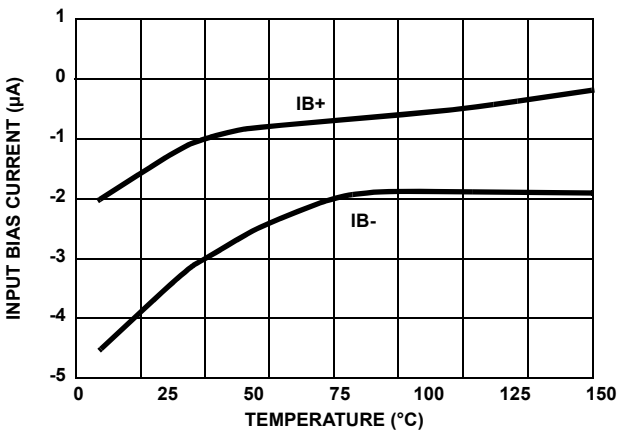

FIGURE 29. INPUT BIAS CURRENT vs TEMPERATURE

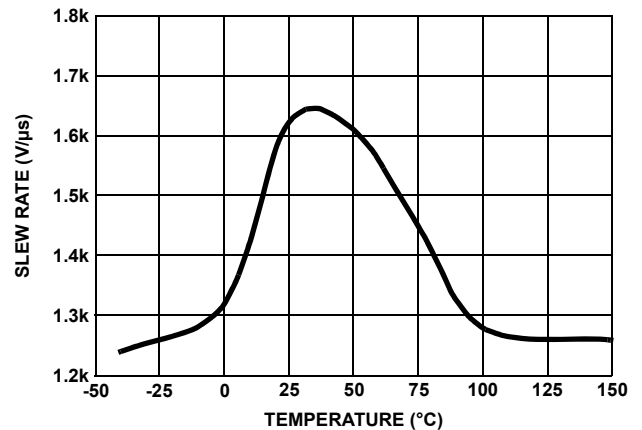

FIGURE 30. SLEW RATE vs TEMPERATURE

Typical Performance Curves (Continued)

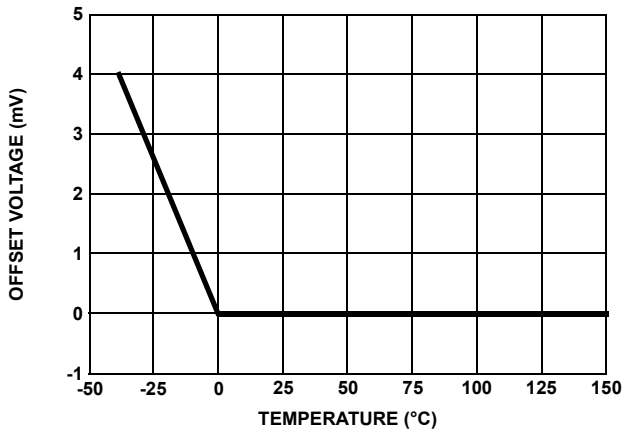

FIGURE 31. OFFSET VOLTAGE vs TEMPERATURE

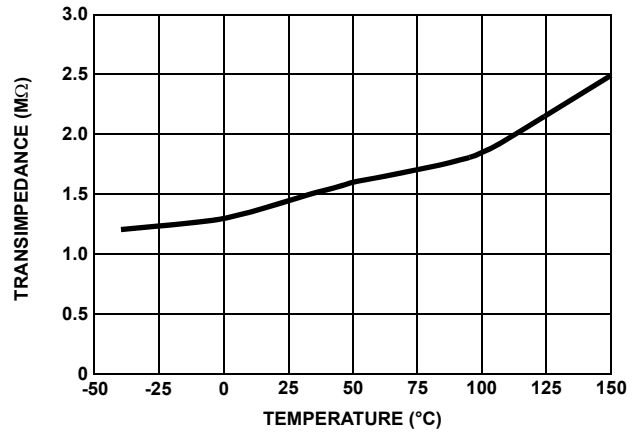

FIGURE 32. TRANSIMPEDANCE vs TEMPERATURE

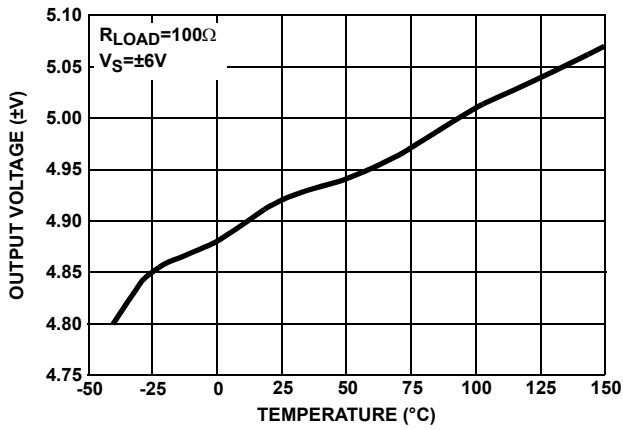

FIGURE 33. OUTPUT VOLTAGE vs TEMPERATURE

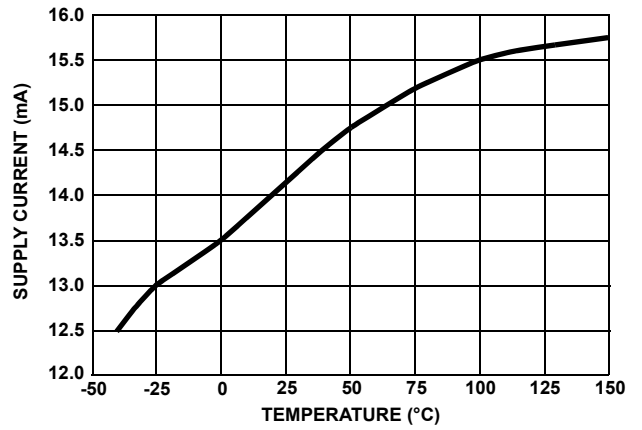

FIGURE 34. SUPPLY CURRENT vs TEMPERATURE

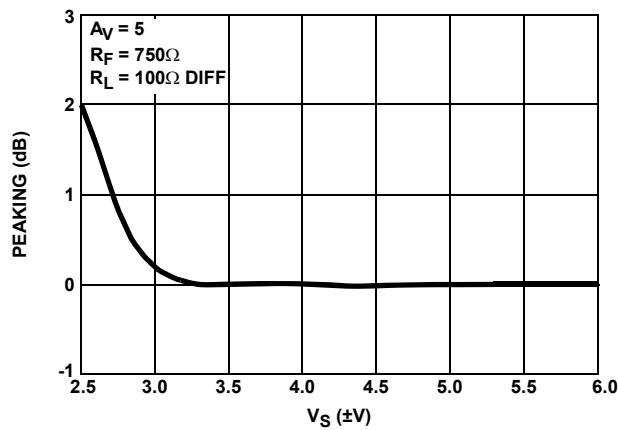

FIGURE 35. DIFFERENTIAL PEAKING vs SUPPLY VOLTAGE

Typical Performance Curves (Continued)

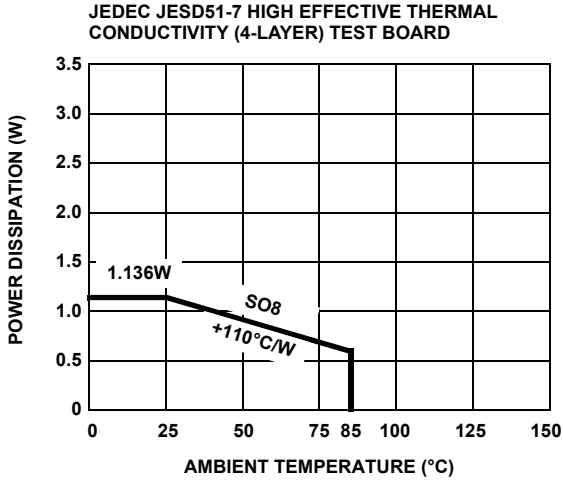

FIGURE 36. PACKAGE POWER DISSIPATION vs AMBIENT TEMPERATURE

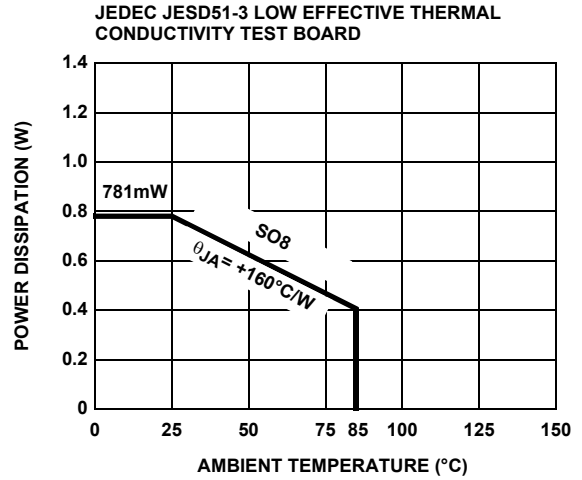

FIGURE 37. PACKAGE POWER DISSIPATION vs AMBIENT TEMPERATURE

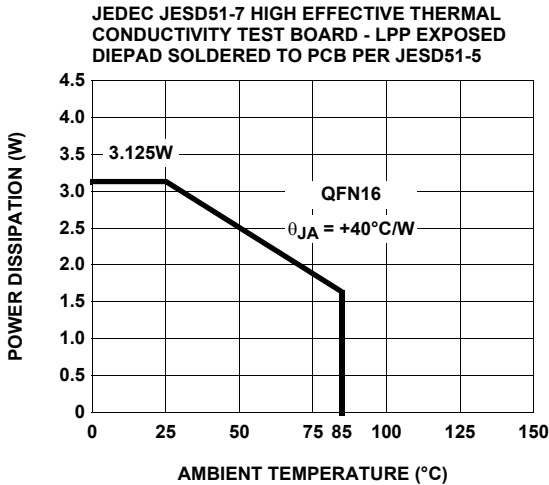

FIGURE 38. PACKAGE POWER DISSIPATION vs AMBIENT TEMPERATURE

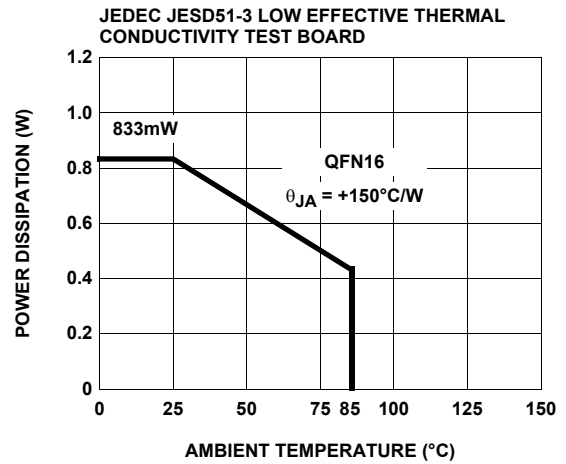

FIGURE 39. PACKAGE POWER DISSIPATION vs AMBIENT TEMPERATURE

Applications Information

Product Description

The EL8108 is a dual current feedback operational amplifier designed for video distribution solutions. It is a dual current mode feedback amplifier with low distortion while drawing moderately low supply current. It is built using Intersil's proprietary complimentary bipolar process and is offered in industry standard pinouts. Due to the current feedback architecture, the EL8108 closed-loop 3dB bandwidth is dependent on the value of the feedback resistor. First the desired bandwidth is selected by choosing the feedback resistor, R_F , and then the gain is set by picking the gain resistor, R_G . The curves at the beginning of the "Typical Performance Curves" on page 4 show the effect of varying both R_F and R_G . The 3dB bandwidth is somewhat dependent on the power supply voltage.

Power Supply Bypassing and Printed Circuit Board Layout

As with any high frequency device, good printed circuit board layout is necessary for optimum performance. Ground plane construction is highly recommended. Lead lengths should be as short as possible, below 1/4". The power supply pins must be well bypassed to reduce the risk of oscillation. A 4.7µF tantalum capacitor in parallel with a 0.1µF ceramic capacitor is adequate for each supply pin.

For good AC performance, parasitic capacitances should be kept to a minimum, especially at the inverting input. This implies keeping the ground plane away from this pin. Carbon resistors are acceptable, while use of wire-wound resistors should not be used because of their parasitic inductance. Similarly, capacitors should be low inductance for best performance.

Capacitance at the Inverting Input

Due to the topology of the current feedback amplifier, stray capacitance at the inverting input will affect the AC and transient performance of the EL8108 when operating in the non-inverting configuration.

In the inverting gain mode, added capacitance at the inverting input has little effect since this point is at a virtual ground and stray capacitance is therefore not “seen” by the amplifier.

Feedback Resistor Values

The EL8108 has been designed and specified with $R_F = 500\Omega$ for $A_V = +2$. This value of feedback resistor yields extremely flat frequency response with little to no peaking out to 200MHz. As is the case with all current feedback amplifiers, wider bandwidth, at the expense of slight peaking, can be obtained by reducing the value of the feedback resistor. Inversely, larger values of feedback resistor will cause rolloff to occur at a lower frequency. See “Typical Performance Curves” beginning on page 4, which show 3dB bandwidth and peaking vs frequency for various feedback resistors and various supply voltages.

Bandwidth vs Temperature

Whereas many amplifier's supply current and consequently 3dB bandwidth drop off at high temperature, the EL8108 was designed to have little supply current variations with temperature. An immediate benefit from this is that the 3dB bandwidth does not drop off drastically with temperature.

Supply Voltage Range

The EL8108 has been designed to operate with supply voltages from $\pm 2.5V$ to $\pm 6V$. Optimum bandwidth, slew rate, and video characteristics are obtained at higher supply voltages. However, at $\pm 2.5V$ supplies, the 3dB bandwidth at $A_V = +5$ is a respectable 200MHz.

Single Supply Operation

If a single supply is desired, values from +5V to +12V can be used as long as the input common mode range is not exceeded. When using a single supply, be sure to either:

1. DC bias the inputs at an appropriate common mode voltage and AC couple the signal, or
2. Ensure the driving signal is within the common mode range of the EL8108.

Driving Cables and Capacitive Loads

The EL8108 was designed with driving multiple coaxial cables in mind. With 450mA of output drive and low output impedance, driving six, 75Ω double terminated coaxial cables to $\pm 11V$ with one EL8108 is practical.

When used as a cable driver, double termination is always recommended for reflection-free performance. For those applications, the back termination series resistor will decouple the EL8108 from the capacitive cable and allow extensive capacitive drive.

Other applications may have high capacitive loads without termination resistors. In these applications, an additional small value (5Ω to 50Ω) resistor in series with the output will eliminate most peaking.

The following schematic show the EL8108 driving 6 double terminated cables, each an average length of 50 ft.

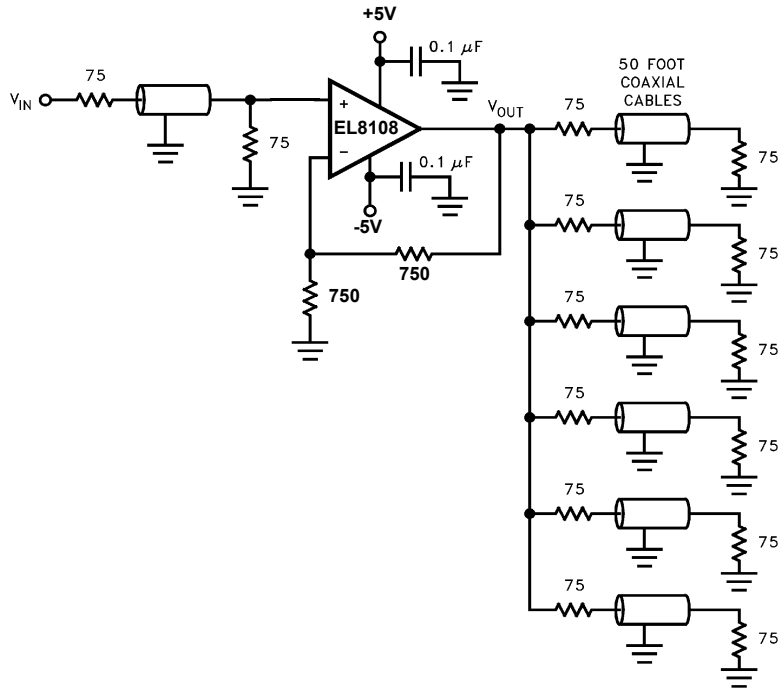

© Copyright Intersil Americas LLC 2007-2008. All Rights Reserved.
 All trademarks and registered trademarks are the property of their respective owners.

For additional products, see www.intersil.com/en/products.html

Intersil products are manufactured, assembled and tested utilizing ISO9001 quality systems as noted in the quality certifications found at www.intersil.com/en/support/qualandreliability.html

Intersil products are sold by description only. Intersil may modify the circuit design and/or specifications of products at any time without notice, provided that such modification does not, in Intersil's sole judgment, affect the form, fit or function of the product. Accordingly, the reader is cautioned to verify that datasheets are current before placing orders. Information furnished by Intersil is believed to be accurate and reliable. However, no responsibility is assumed by Intersil or its subsidiaries for its use; nor for any infringements of patents or other rights of third parties which may result from its use. No license is granted by implication or otherwise under any patent or patent rights of Intersil or its subsidiaries.

For information regarding Intersil Corporation and its products, see www.intersil.com

Small Outline Package Family (SO)

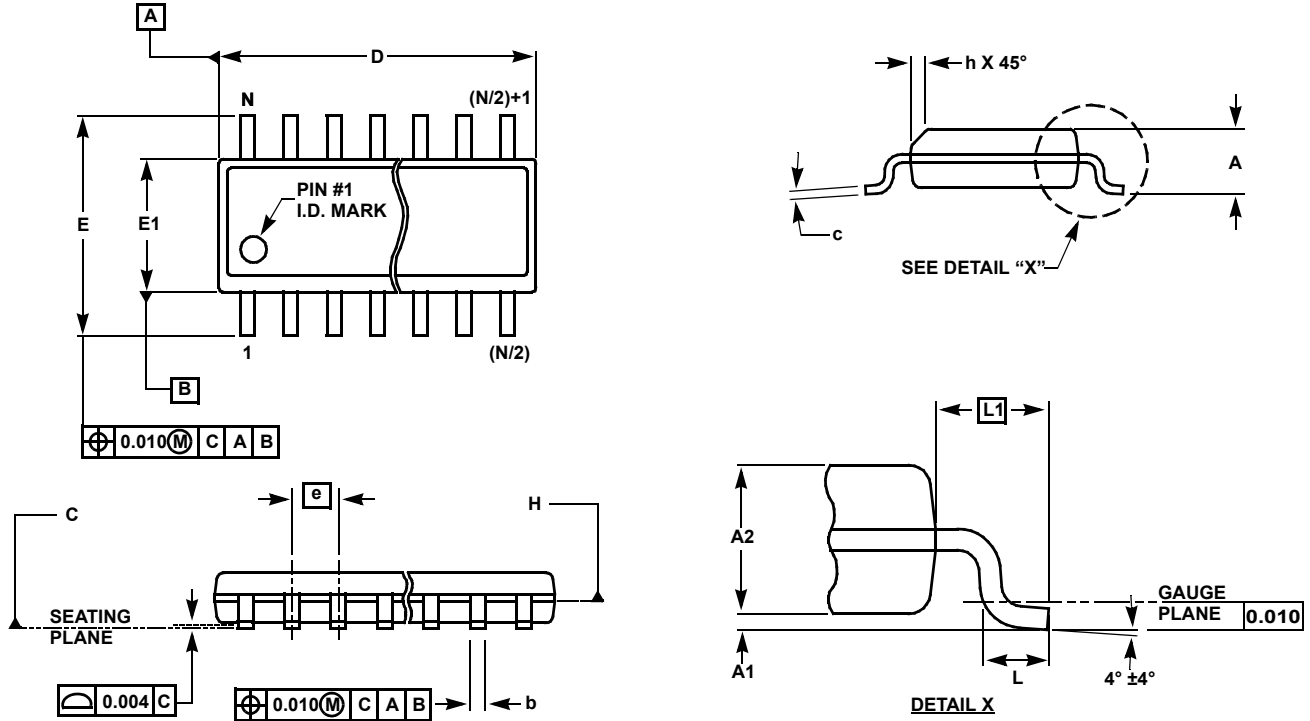

MDP0027

SMALL OUTLINE PACKAGE FAMILY (SO)

SYMBOL	INCHES							TOLERANCE	NOTES
	SO-8	SO-14	SO16 (0.150")	SO16 (0.300") (SOL-16)	SO20 (SOL-20)	SO24 (SOL-24)	SO28 (SOL-28)		
A	0.068	0.068	0.068	0.104	0.104	0.104	0.104	MAX	-
A1	0.006	0.006	0.006	0.007	0.007	0.007	0.007	±0.003	-
A2	0.057	0.057	0.057	0.092	0.092	0.092	0.092	±0.002	-
b	0.017	0.017	0.017	0.017	0.017	0.017	0.017	±0.003	-
c	0.009	0.009	0.009	0.011	0.011	0.011	0.011	±0.001	-
D	0.193	0.341	0.390	0.406	0.504	0.606	0.704	±0.004	1, 3
E	0.236	0.236	0.236	0.406	0.406	0.406	0.406	±0.008	-
E1	0.154	0.154	0.154	0.295	0.295	0.295	0.295	±0.004	2, 3
e	0.050	0.050	0.050	0.050	0.050	0.050	0.050	Basic	-
L	0.025	0.025	0.025	0.030	0.030	0.030	0.030	±0.009	-
L1	0.041	0.041	0.041	0.056	0.056	0.056	0.056	Basic	-
h	0.013	0.013	0.013	0.020	0.020	0.020	0.020	Reference	-
N	8	14	16	16	20	24	28	Reference	-

Rev. M 2/07

NOTES:

1. Plastic or metal protrusions of 0.006" maximum per side are not included.
2. Plastic interlead protrusions of 0.010" maximum per side are not included.
3. Dimensions "D" and "E1" are measured at Datum Plane "H".
4. Dimensioning and tolerancing per ASME Y14.5M-1994

QFN (Quad Flat No-Lead) Package Family

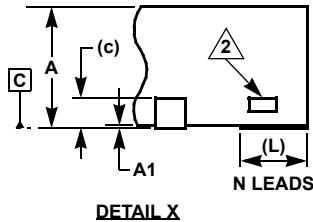
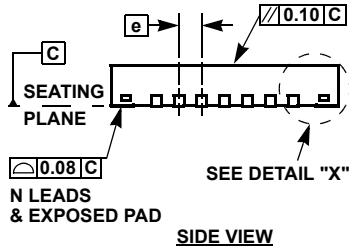
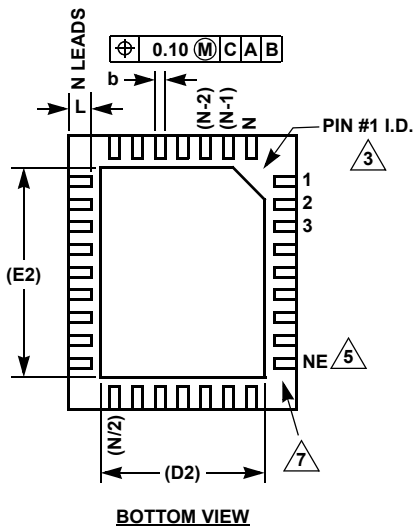
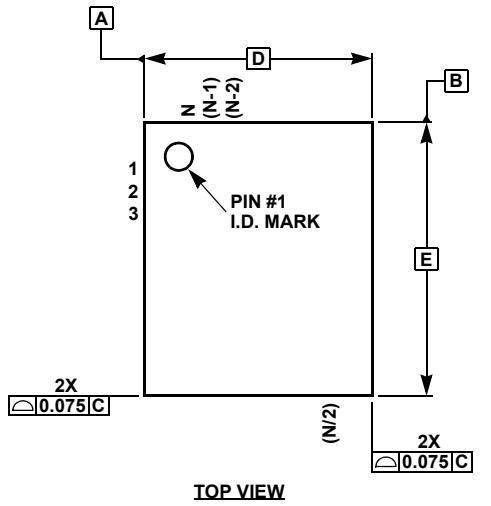

MDP0046

**QFN (QUAD FLAT NO-LEAD) PACKAGE FAMILY
(COMPLIANT TO JEDEC MO-220)**

SYMBOL	MILLIMETERS				TOLERANCE	NOTES
	QFN44	QFN38	QFN32			
A	0.90	0.90	0.90	0.90	±0.10	-
A1	0.02	0.02	0.02	0.02	+0.03/-0.02	-
b	0.25	0.25	0.23	0.22	±0.02	-
c	0.20	0.20	0.20	0.20	Reference	-
D	7.00	5.00	8.00	5.00	Basic	-
D2	5.10	3.80	5.80	3.60/2.48	Reference	8
E	7.00	7.00	8.00	6.00	Basic	-
E2	5.10	5.80	5.80	4.60/3.40	Reference	8
e	0.50	0.50	0.80	0.50	Basic	-
L	0.55	0.40	0.53	0.50	±0.05	-
N	44	38	32	32	Reference	4
ND	11	7	8	7	Reference	6
NE	11	12	8	9	Reference	5

SYMBOL	MILLIMETERS					TOLERANCE	NOTES
	QFN28	QFN24	QFN20		QFN16		
A	0.90	0.90	0.90	0.90	0.90	±0.10	-
A1	0.02	0.02	0.02	0.02	0.02	+0.03/-0.02	-
b	0.25	0.25	0.30	0.25	0.33	±0.02	-
c	0.20	0.20	0.20	0.20	0.20	Reference	-
D	4.00	4.00	5.00	4.00	4.00	Basic	-
D2	2.65	2.80	3.70	2.70	2.40	Reference	-
E	5.00	5.00	5.00	4.00	4.00	Basic	-
E2	3.65	3.80	3.70	2.70	2.40	Reference	-
e	0.50	0.50	0.65	0.50	0.65	Basic	-
L	0.40	0.40	0.40	0.40	0.60	±0.05	-
N	28	24	20	20	16	Reference	4
ND	6	5	5	5	4	Reference	6
NE	8	7	5	5	4	Reference	5

Rev 11 2/07

NOTES:

1. Dimensioning and tolerancing per ASME Y14.5M-1994.
2. Tiebar view shown is a non-functional feature.
3. Bottom-side pin #1 I.D. is a diepad chamfer as shown.
4. N is the total number of terminals on the device.
5. NE is the number of terminals on the "E" side of the package (or Y-direction).
6. ND is the number of terminals on the "D" side of the package (or X-direction). ND = (N/2)-NE.
7. Inward end of terminal may be square or circular in shape with radius (b/2) as shown.
8. If two values are listed, multiple exposed pad options are available. Refer to device-specific datasheet.