

TRAY PACKING

1. CONTAINER

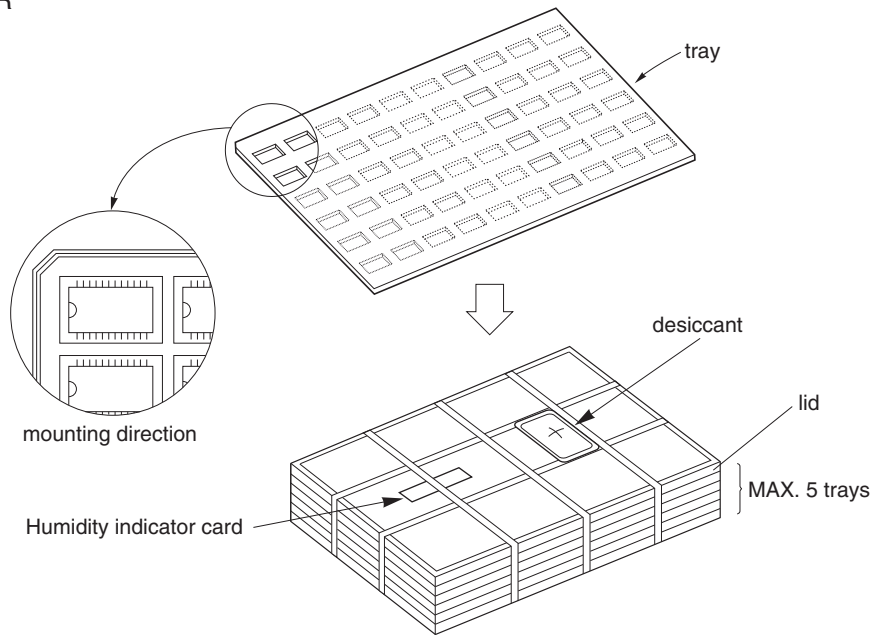

2. DRY PACK

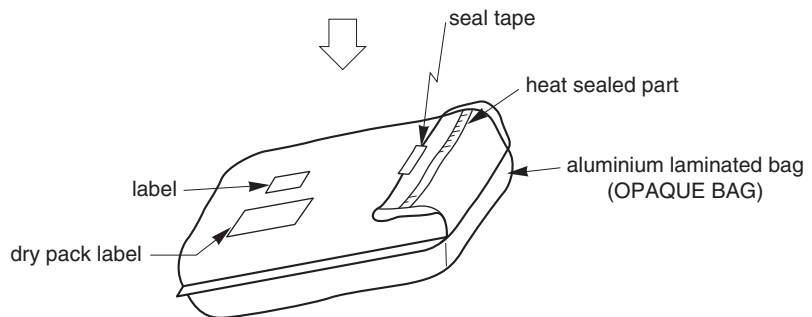

3. INNER BOX

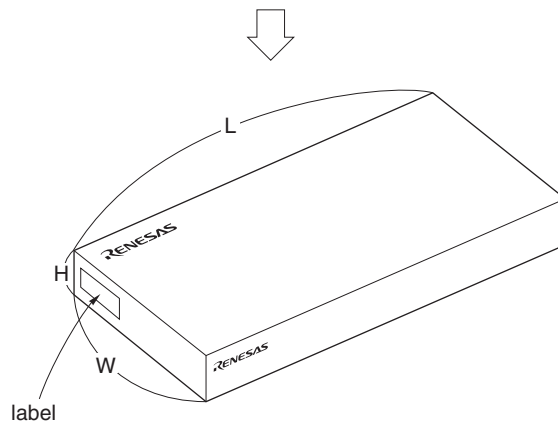

LABEL POSITION	SIDE OF BOX
LABEL	PRODUCT NAME, QUANTITY, LOT NUMBER, CLASS
INNER BOX	DIMENSION (W x L x H) 215 x 385 x 75 (mm)