

---

# SH7216 Group

R01AN0066EJ0110

Rev.1.10

Mar 17, 2011

## Protocol Conversion between Ethernet and USB

---

### Introduction

This application note describes a sample program that uses the Ethernet-related modules (EtherC and E-DMAC) and the USB function module of the SH7216 in combination to transmit and receive text data between the Ethernet and USB interfaces.

### Target Device

SH7216

### Contents

1. Preface .....	2
2. Operating Environment .....	4
3. Sample Program Operation Overview .....	6
4. Specifications of Sample Program .....	8
5. Reference Documents.....	33

## 1. Preface

### 1.1 Specifications

The Ethernet-related modules (EtherC and E-DMAC) and the USB function module of the SH7216 are used to transfer text data between two PCs (evaluation board model: R0K572167C001BR).

The example application uses two communication terminals (host PC (A) and host PC (B)), one running a serial application and the other a Telnet application, to perform the following operations.

(1) Ethernet to USB text data transfer

Text data input using the Telnet application is converted by the Ethernet-USB conversion software on the SH7216 from TCP/IP protocol data to USB COM class communication data and output to the serial application.

(2) USB to Ethernet text data transfer

Text data input using the serial application is converted by the Ethernet-USB conversion software on the SH7216 from USB COM class communication data to TCP/IP protocol data and output to the Telnet application.

Figure 1 shows the system configuration of the example application.

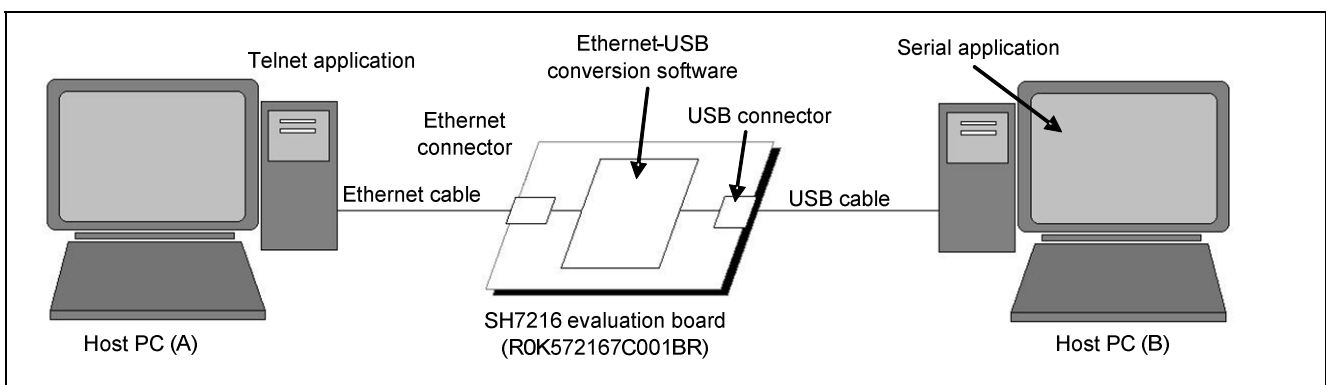

Figure 1 System Configuration

### 1.2 Functions

- Interrupt controller (INTC)
- Ethernet controller (EtherC)
- Ethernet controller direct memory access controller (E-DMAC)
- Compare match timer (CMT)
- Pin function controller (PFC)
- USB function module (USB)

### 1.3 Applicable Conditions

MCU	SH7216
Operating frequencies	Internal clock: $I\phi = 200$ MHz
	Bus clock: $B\phi = 50$ MHz
	Peripheral clock: $P\phi = 50$ MHz
Integrated development environment	Renesas Electronics High-performance Embedded Workshop, Ver. 4.07.00.007
C compiler	Renesas Electronics SuperH RISC Engine Family C/C++ Compiler Package, Ver. 9.03, Release 02
Compile options	High-performance Embedded Workshop default settings (-cpu=sh2afpu -pic=1 -object="\$(CONFIGDIR)\\$(FILELEAF).obj" -debug -gbr=auto -volatile_loop -enable_register -chgincpath -errorpath -global_volatile=1 -opt_range=all -infinite_loop=0 -del_vacant_loop=0 -struct_alloc=1 -nologo)

### 1.4 Related Application Notes

- H8S/2472 and SH7216 uIP TCP/IP Protocol Stack Demonstration (Rev. 2.00)
- SH7216 Group USB Function Module USB HID Class Application Note
- SH7727 USB Function Module USB Serial Conversion Application Note
- SH7216 Group Reprogramming Flash Memory in User Program Mode Using an Ethernet Connection Application Note
- SH7216 Group USB Function Module USB Mass Storage Class Application Note

## 2. Operating Environment

The environment and settings needed to run the SH7216 sample program are described below.

### 2.1 Hardware Environment

The hardware used by the example application is as follows.

- SH7216 CPU board (product No.: R0K572167C001BR) × 1
- USB 2.0 cable × 1
- Ethernet cable (crossover cable) × 1
- Host PC for use as Telnet terminal (OS: Windows XP or Windows Vista) × 1
- Host PC for use as serial terminal (OS: Windows XP or Windows Vista) × 1

### 2.2 Evaluation Board Environment Settings

(1) Mode settings for running SH7216 sample program

Before powering on the SH7216 CPU board, select the “single-chip mode” settings with the SW5 switches.  
(See table 1.)

**Table 1 W5 Switch Mode Settings**

Switch	Single-Chip Mode	Description
SW5-1	On	Write/erase protection enabled for on-chip flash memory
SW5-2	Off	MD1 pin state
SW5-3	Off	MD0 pin state
SW5-4	On	Ethernet function enabled

## 2.3 PC Environment Settings

The environment settings of host PC (A), the Telnet communication terminal, and host PC (B), the serial communication terminal, are described below.

### 2.3.1 Host PC (A) Telnet Communication Terminal

- (1) Install a general-purpose communication program such as TeraTerm or Hyper Terminal on the PC.
- (2) Set IP address and subnet mask to the following values.

IP address: 192.168.1.77

Subnet mask: 255.255.255.0

Note: If it is necessary to change the IP address of PC (A) from that indicated above, make sure to also change the value in the definition data of the sample program to enable communication. (See figure 2 in 4.2.)

### 2.3.2 Host PC (B) Serial Communication Terminal

- (1) Install a general-purpose communication program such as TeraTerm or Hyper Terminal on the PC.

### 3. Sample Program Operation Overview

The operation of the SH7216 sample program is described in this section.

Before performing the following steps, confirm that the switches on the SH7216 CPU board are set for “single-chip mode.” (See table 1.)

#### 3.1 Usage

Make connections as described below, and power on the SH7216 CPU board.

- Connect the E10A to the SH7216 CPU board.
- Connect host PC (A), the Telnet communication terminal, to the SH7216 CPU board with an Ethernet cable.
- Connect a USB cable to the SH7216 CPU board.

- (1) Start the general-purpose communication program, select **Telnet** as the application, and use TCP/IP to set the IP address to **192.168.1.76**.
- (2) Connect the USB cable to host PC (B). If a request for a device driver appears, use the new hardware detection wizard to recognize the device. During this process, specify the file RN\_EtherConvert.inf (in the case of Windows XP) as the device driver.

Device driver storage location: C:\WorkSpace\sh7216\_usb\_etherconvert\USB\_CommClass\_INF

- Notes: 1. For Windows Vista, select the file RN\_EtherConvertVista.inf as the device driver.  
2. The device driver recognition procedure only needs to be performed once.

- (3) Start the general-purpose communication program on host PC (B), and select the COM port to be used.
- (4) Set the serial port attributes to the values listed in table 2.

**Table 2 Serial Port Attributes**

Setting Item	Value
Port number	COM port number of SH7216 CPU board as recognized by host PC (B)
Baud rate	115,200 bps
Data bits	8 bits
Parity	None
Stop bits	1 bit
Flow control	None

- (5) In the communication settings of the general-purpose communication program, select **CR+LF** for reception and **CR** for transmission, and enable the local echo function.
- (6) If text data input to the Telnet terminal on host PC (A) is echoed back on the display of the serial terminal on host PC (B), Ethernet to USB text data transfer is working correctly. In like manner, if text data input to the serial terminal of host PC (B) is echoed back on the display of the Telnet terminal on host PC (A), USB to Ethernet text data transfer is working properly.

In this state, it is possible to transmit the data in a text file by selecting the file name in the file selection menu.

## 3.2 Operation with Cables Disconnected/Connected

### 3.2.1 USB Cable Disconnected/Connected

Ethernet-USB text data transfer is not possible when the USB cable is not connected. In this case, text data input to the Telnet terminal on host PC (A) is discarded by the program internally.

After reconnecting the USB cable, perform the following steps.

- (1) If the serial terminal window is open on host PC (B), exit the serial terminal for the time being.
- (2) Restart the general-purpose communication program on host PC (B), then perform steps (3) to (5) from 3.1 to open the serial terminal.

After completing the above steps, retry Ethernet-USB text data transfer.

### 3.2.2 Ethernet Cable Disconnected/Connected

The Telnet communication terminal on host PC (A) closes automatically when the Ethernet cable is disconnected. In this case, text data input to the serial terminal on host PC (B) is discarded by the program internally.

After reconnecting the Ethernet cable, perform the following steps.

- (1) Restart the general-purpose communication program on host PC (A), then perform steps (1) to (5) from 3.1 to open the Telnet terminal.

After completing the above steps, retry USB-Ethernet text data transfer.

## 4. Specifications of Sample Program

The specifications of the SH7216 sample program used in the example application are described below.

### 4.1 Functions

#### (1) Ethernet to USB text data transfer

Ethernet reception

- Ethernet data from host PC (A) is received by using interrupt notification.
- The data is copied to the USB transmit buffer.

USB transmission

- The USB transmit buffer is polled to determine whether or not it contains USB transmit data.
- If there is data in the USB transmit buffer, bulk-in data transfer to host PC (B) is performed.

#### (2) USB to Ethernet text data transfer

USB reception

- Bulk-out transfer data from host PC (B) is received by using interrupt notification.
- The data is copied to the USB receive buffer.

Ethernet transmission

- USB receive buffer is polled to determine whether or not it contains Ethernet transmit data.
- If there is data in the USB receive buffer, it is transferred to host PC (A) by using TCP/IP communication.

#### (3) USB cable disconnection/reconnection

Disconnection

- Disconnection is detected by using an interrupt, and the USB device is disabled.
- After the USB device is disabled, the Ethernet receive data is discarded.

Reconnection

- Reconnection is detected by using an interrupt, and the USB device is enabled.
- After the USB device is enabled, the Ethernet-USB conversion function is enabled.

#### (4) Ethernet cable disconnection/reconnection

Disconnection/reconnection

- Disconnection is detected by using an interrupt, and the Ethernet link signal change (link-up or link-down) is reflected by the link signal change flag.
- The link signal change flag is polled to determine whether or not a Ethernet link signal change has occurred, and if so whether the state is link-up or link-down.

Link-down

- The uIP timer stops and the Ethernet device is disabled.
- After the Ethernet device is disabled, USB receive data is discarded.

Link-up

- The uIP timer, Ethernet driver, and uIP (TCP/IP protocol stack) are initialized.
- After a Telnet connection is established, the Ethernet device is enabled.
- After the Ethernet device is enabled, the Ethernet-USB conversion function is enabled.



## 4.2 SH7216 Sample Program

The SH7216 sample program comprises a main process, TCP/IP protocol stack, Ethernet driver, timer driver, and USB driver.

The IP address used by the sample program for Telnet connections is fixed at **192.168.1.76**.

Note: If it is necessary to change the IP address, change the value in the definition data (ipAddrData) of the source code as shown in figure 2.

```
(main.c)
...
/* network data for Ethernet */
static struct uip_eth_addr mac_addr = {0x00,0x01,0x02,0x03,0x04,0x05} ;
static uchar8_t          ipAddrData[4] = {192,168,1,76} ;
static uchar8_t          netMaskData[4] = {255,255,255,0} ;
...
```

**Figure 2 IP Address Definition**

Figure 3 shows the configuration of the SH7216 sample program. The arrows in the figure indicate the direction of control.

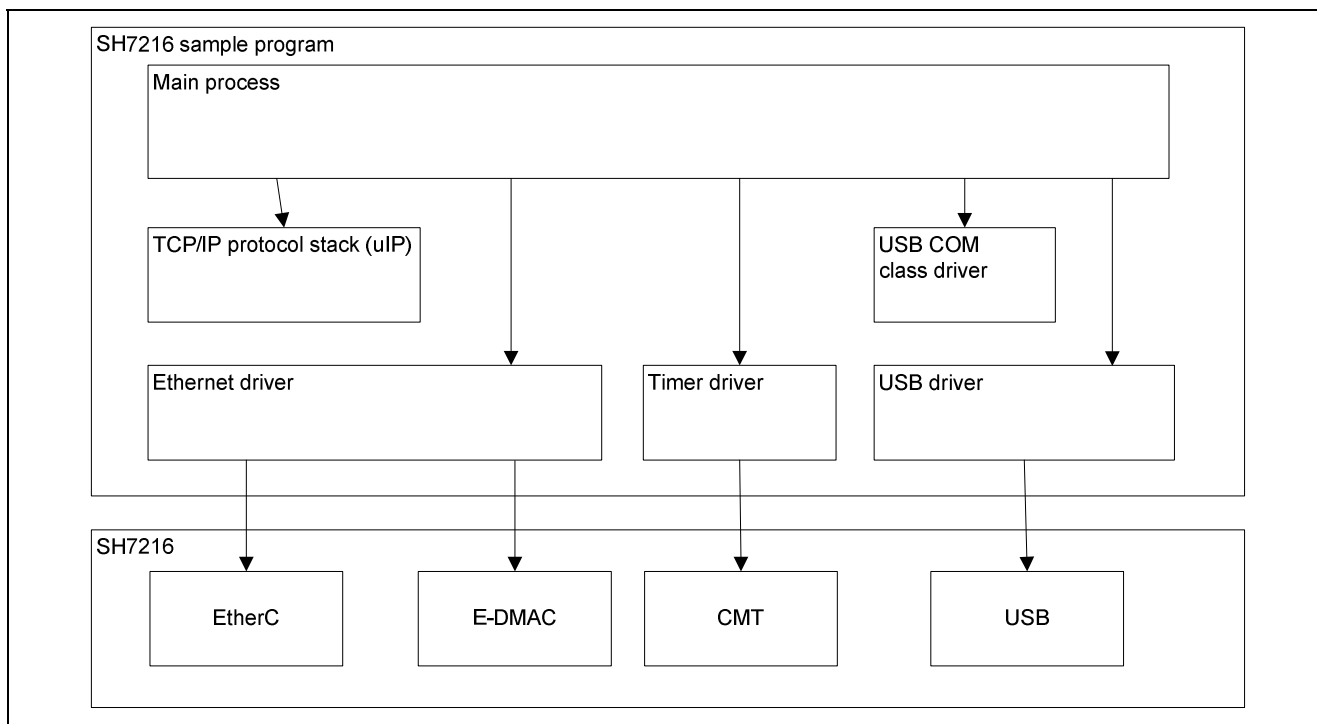

**Figure 3 Configuration of SH7216 Sample Program**

### 4.2.1 Main Process

The main loop process uses polling control to perform the following.

- Checking for detection of link signal changes occurring when the Ethernet cable is inserted or removed
- Checking for reception of Ethernet frames
- Checking uIP timer timeouts
- Checking for reception of USB data

Table 3 lists the flags used for polling control, data transmission/reception control, and device enable/disable control.

**Table 3 List of Control Flags**

No.	Flag	Description
1	EtherLinkChgFlag	Flag that indicates whether or not a link signal change has occurred and, if so, its link-up or link-down status
2	EtherDevEnableFlag	Flag that indicates whether the Ethernet device is enabled or disabled
3	UsbDevEnableFlag	Flag that indicates whether the USB device is enabled or disabled
4	BulkOutEnableFlag	Flag for controlling USB to Ethernet text data transfer
5	EtherInEnableFlag	Flag for controlling Ethernet to USB text data transfer

Figures 4 to 8 are flowcharts of the main process.

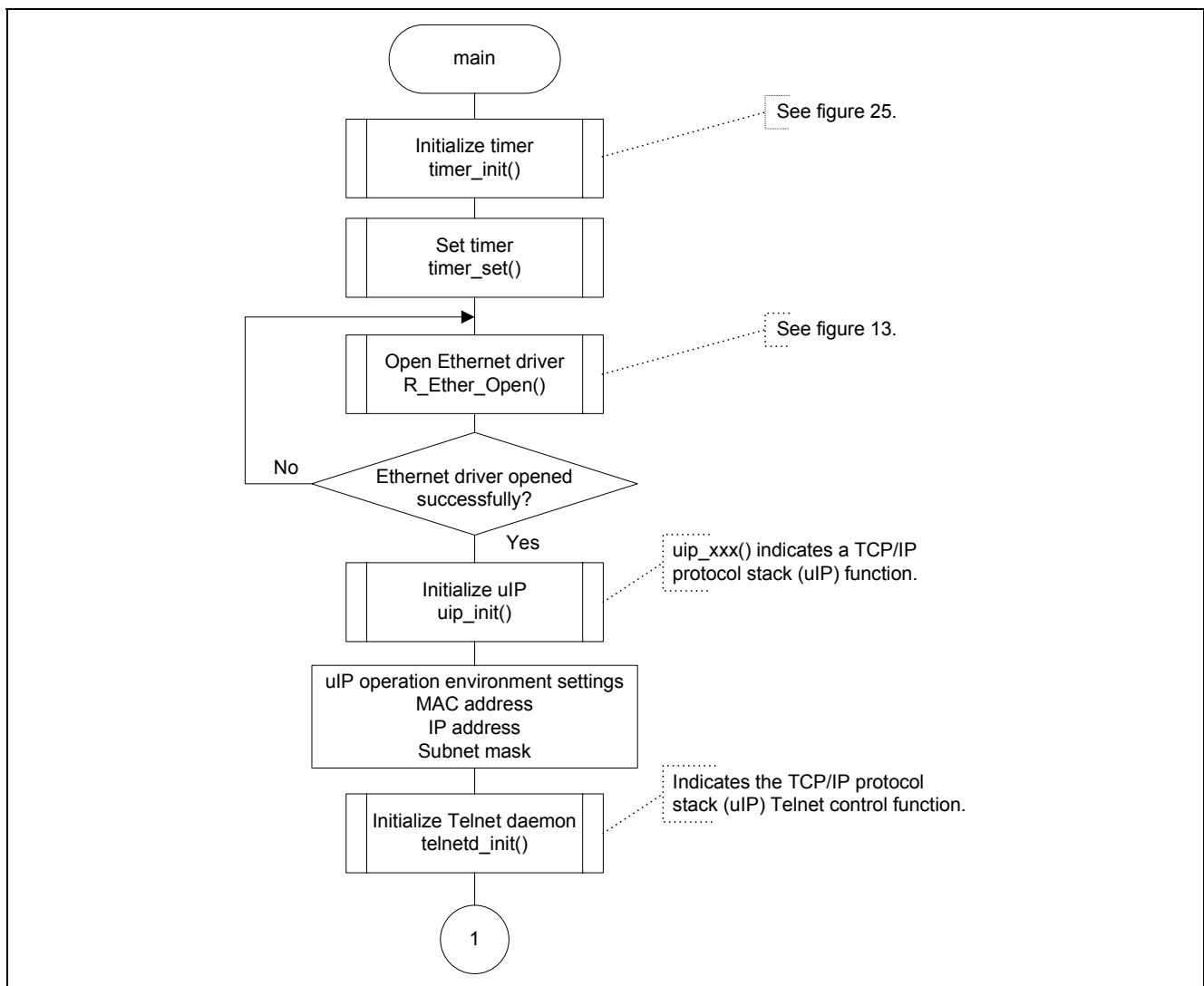

**Figure 4 Main Process Flowcharts (1/5)**

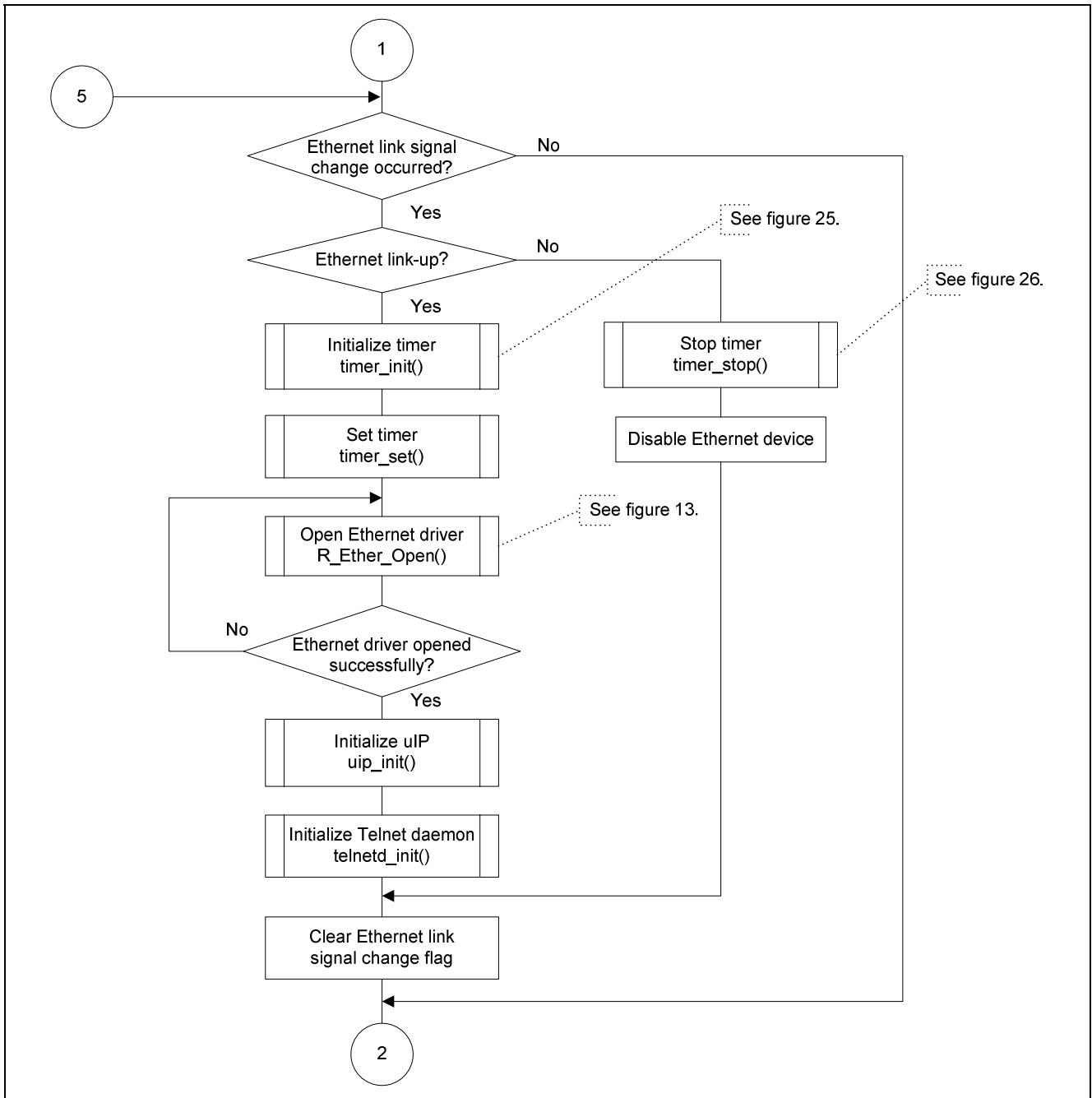

Figure 5 Main Process Flowcharts (2/5)

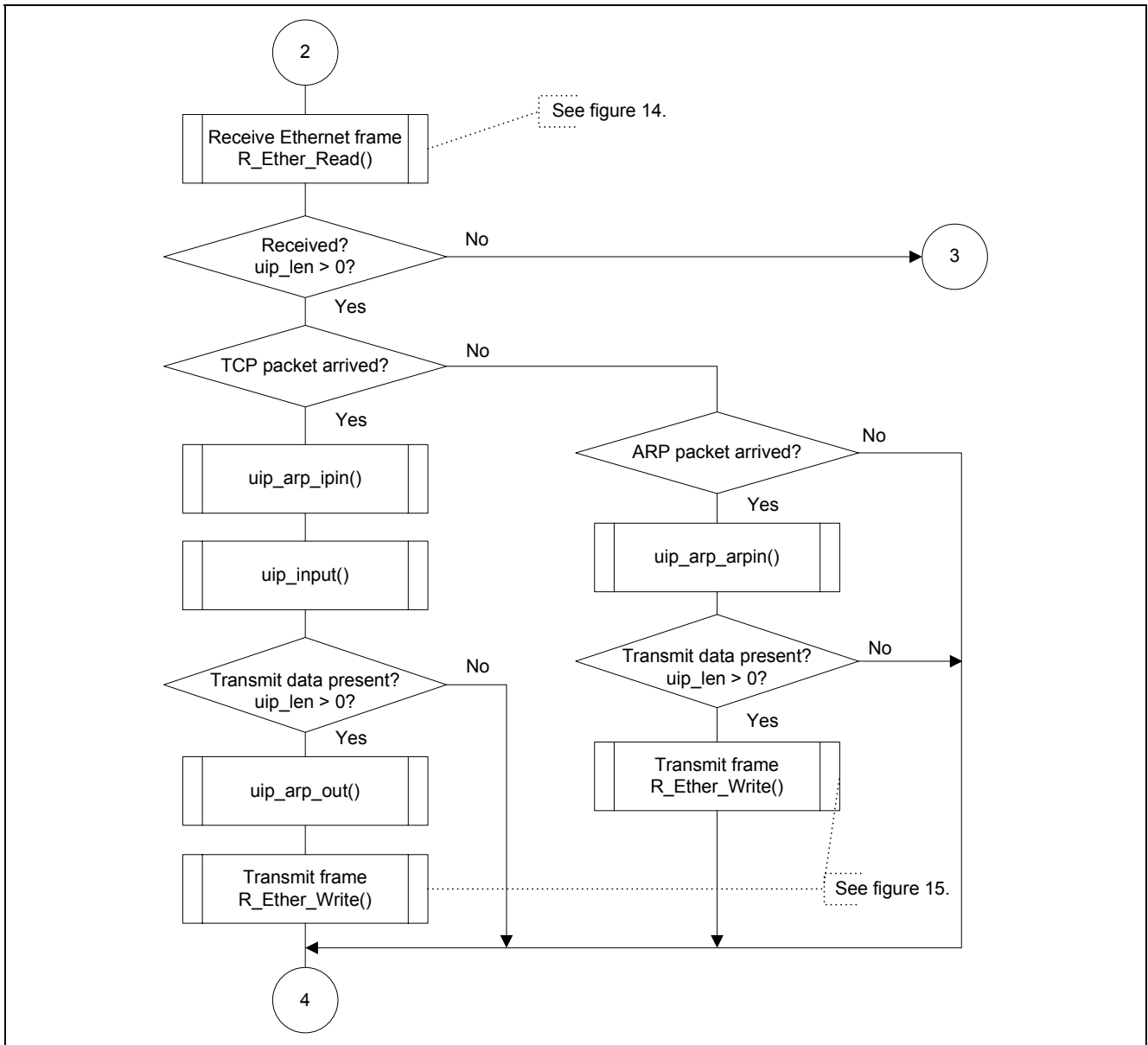

Figure 6 Main Process Flowcharts (3/5)

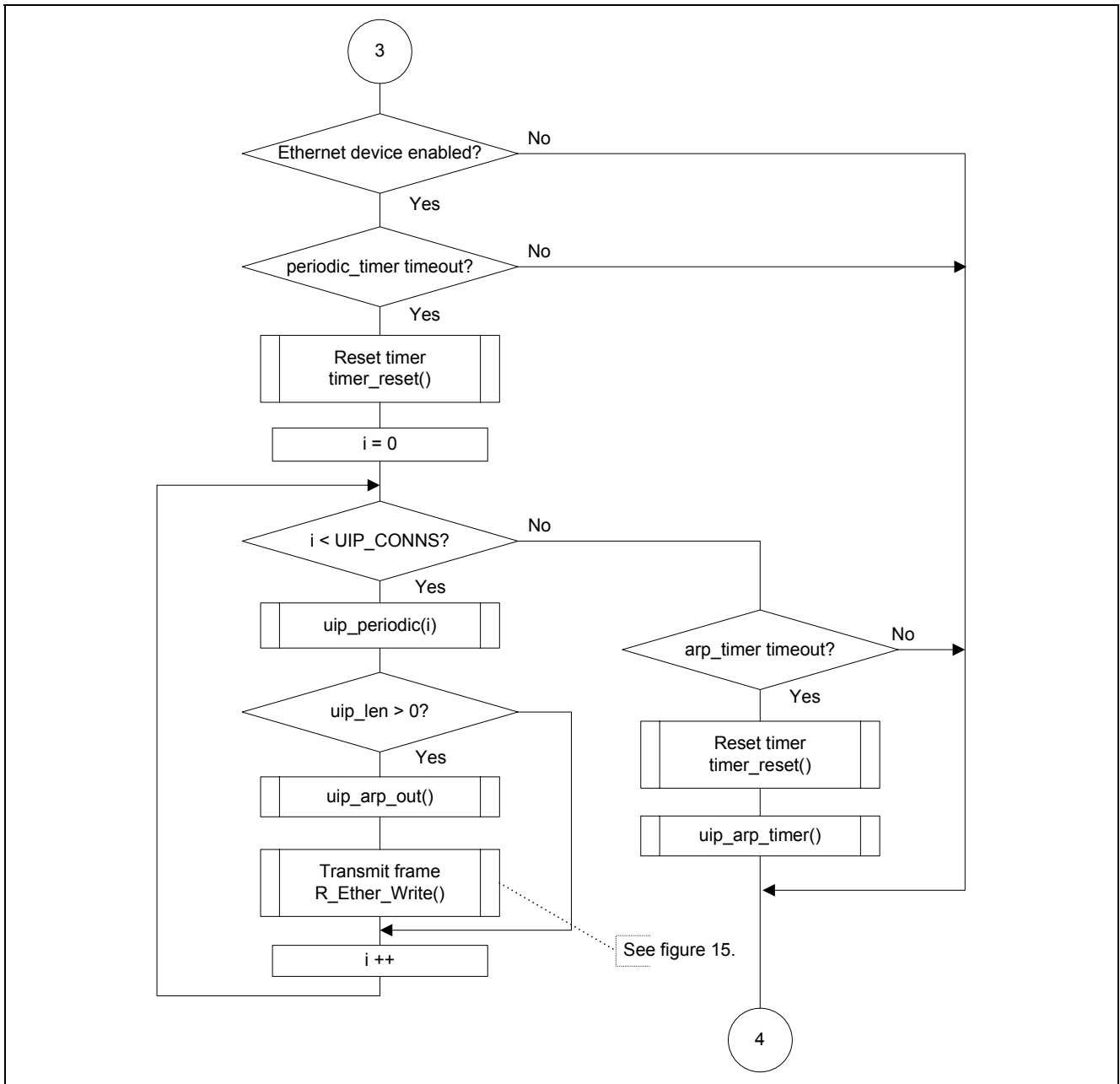

Figure 7 Main Process Flowcharts (4/5)

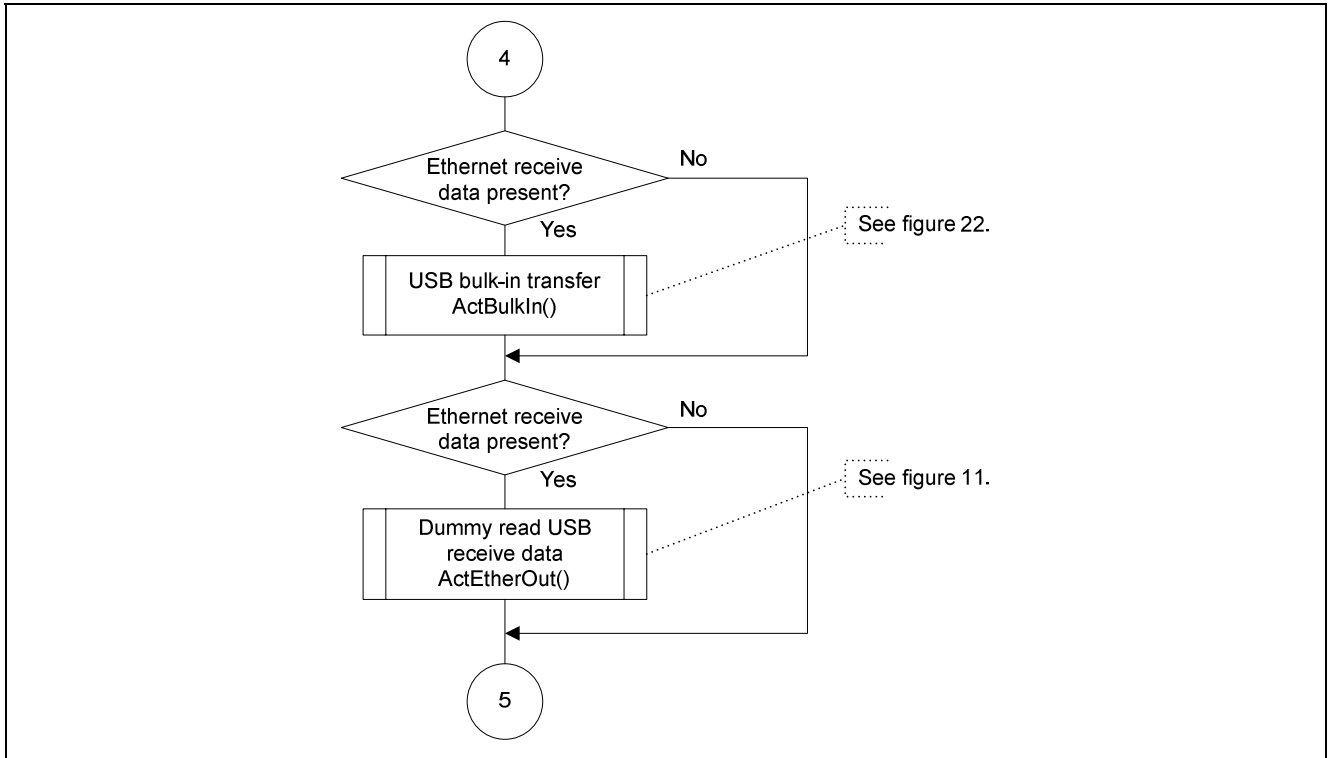

Figure 8 Main Process Flowcharts (5/5)

#### 4.2.2 TCP/IP Protocol Stack

The example application uses uIP 1.0, which is open source software, as the TCP/IP protocol stack.

uIP is a TCP/IP protocol stack for 8- and 16-bit microcontrollers that was developed by Adam Dunkels of SICS.

In the example application, Telnet is used as a TCP/IP application running on top of uIP.

Note: SICS: Swedish Institute of Computer Science

Figures 9 and 10 are flowcharts illustrating the operation of the Telnet application.

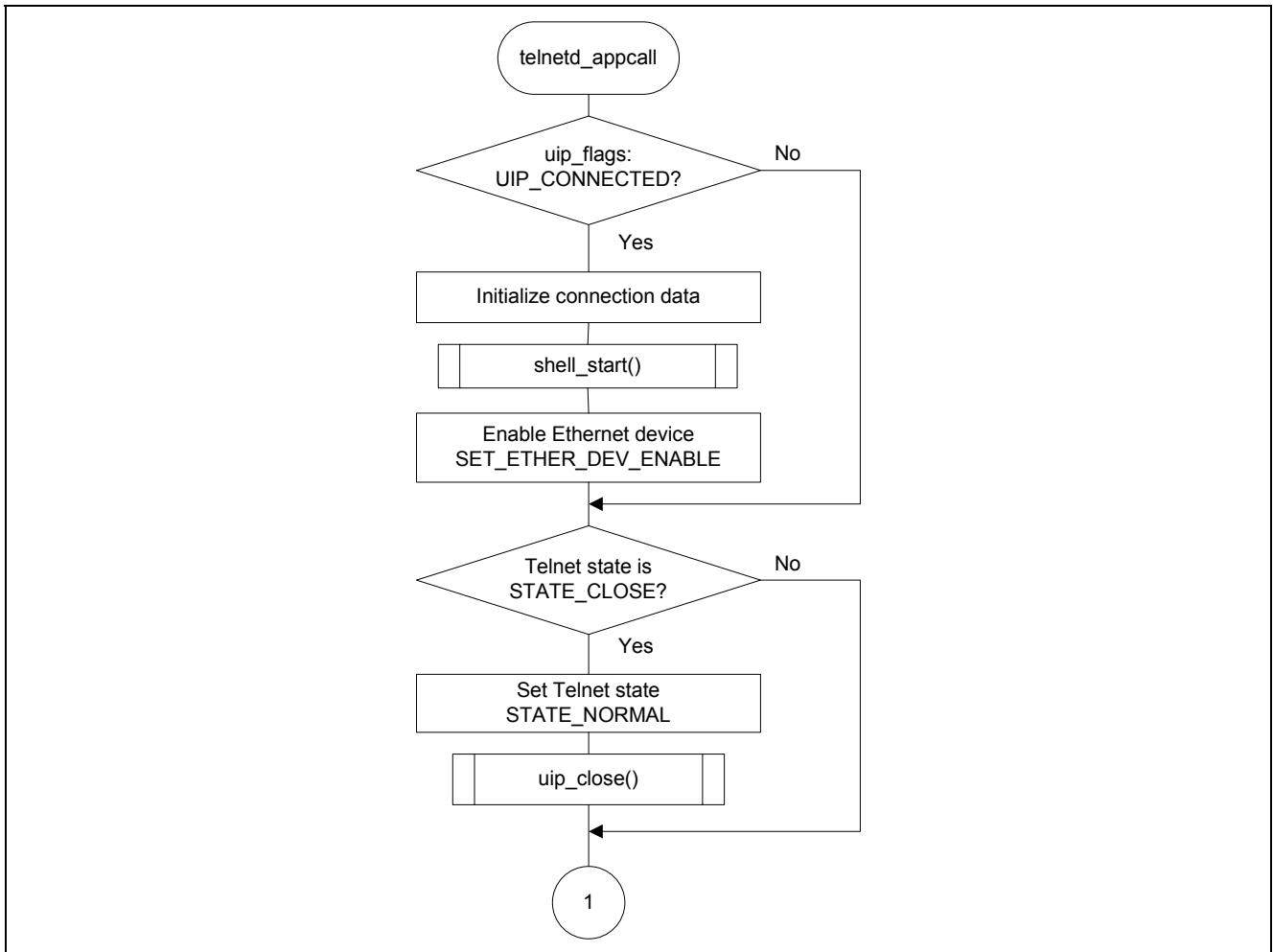

Figure 9 Telnet Application (telnetd\_appcall) Processing Sequence (1/2)

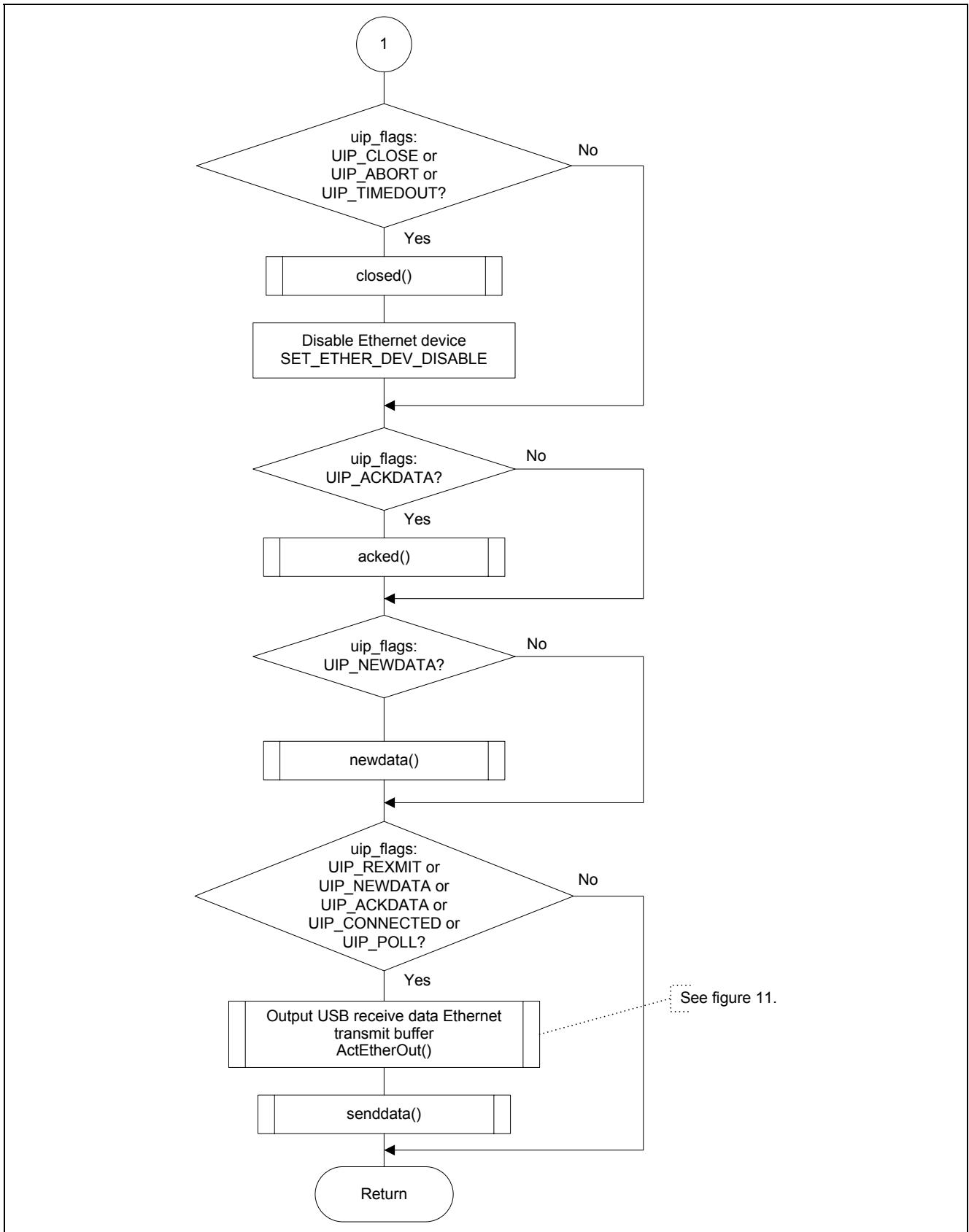

Figure 10 Telnet Application (telnetd\_appcall) Processing Sequence (2/2)



### 4.2.3 Ethernet driver

The Ethernet driver comprises the SH7216 Ethernet controller (EtherC) and a group of functions for transmitting and receiving Ethernet frames using the Ethernet controller direct memory access controller (E-DMAC).

The SH7216 has a dedicated Ethernet controller DMAC (E-DMAC) to enable efficient transmission and reception of Ethernet frames. Control by E-DMAC is facilitated through the use of descriptors created in memory.

Table 4 lists the functions related to the Ethernet driver.

**Table 4 List of Ethernet Driver Functions**

No.	Function	Description
1	ActEtherOut	Performs USB to Ethernet transmission
2	ActEtherIn	Performs Ethernet to USB transmission
3	R_Ether_Open	Initializes EtherC, E-DMAC, and PHY
4	R_Ether_Read	Receives Ethernet frames
5	R_Ether_Write	Transmits Ethernet frames
6	Ian_isr	Interrupt handler for EtherC and E-DMAC

Note: R\_XXX\_XXX indicates an Ethernet driver public function.

Figures 11 to 16 are flowcharts for the various functions.

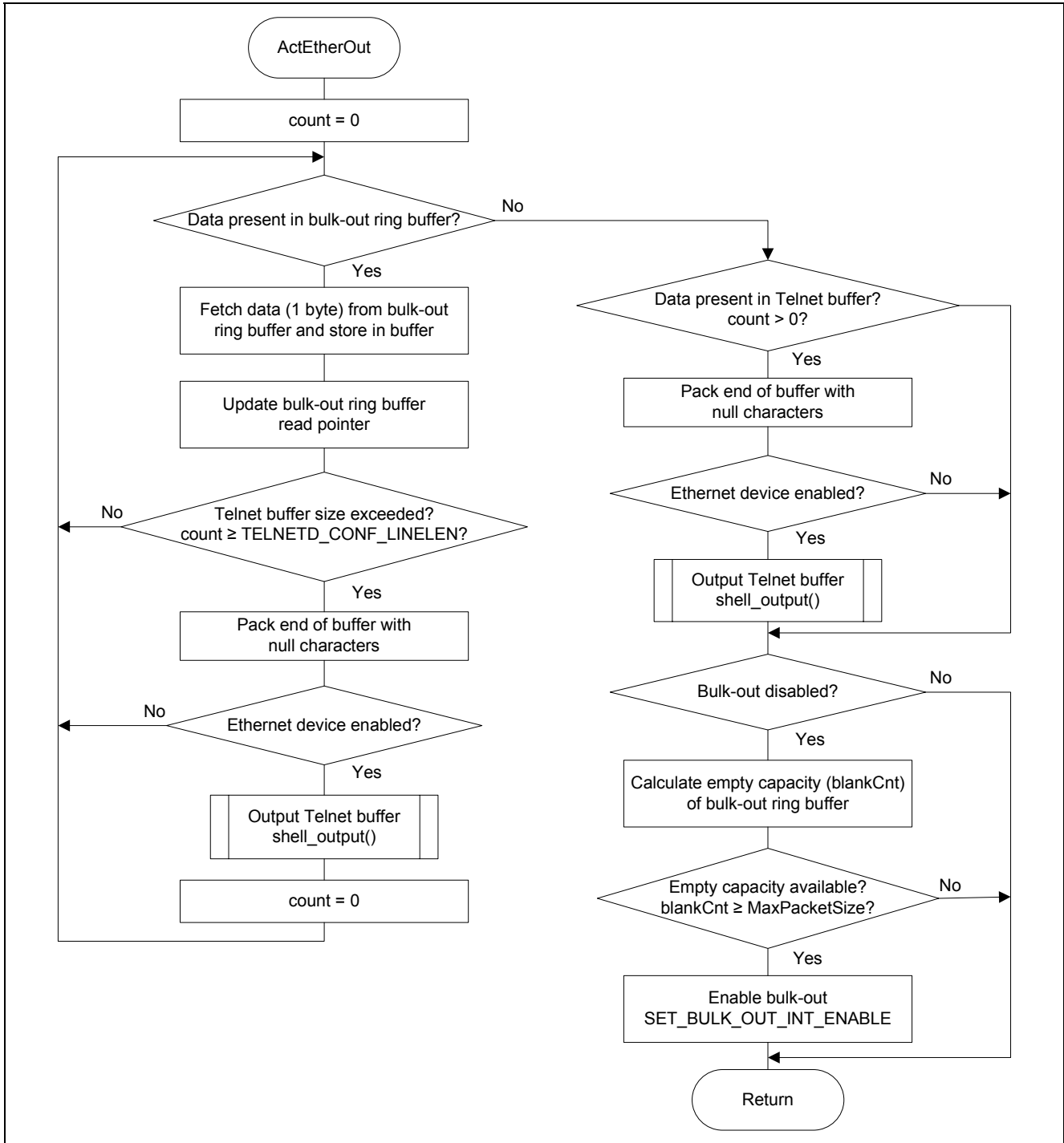

Figure 11 ActEtherOut Processing Sequence

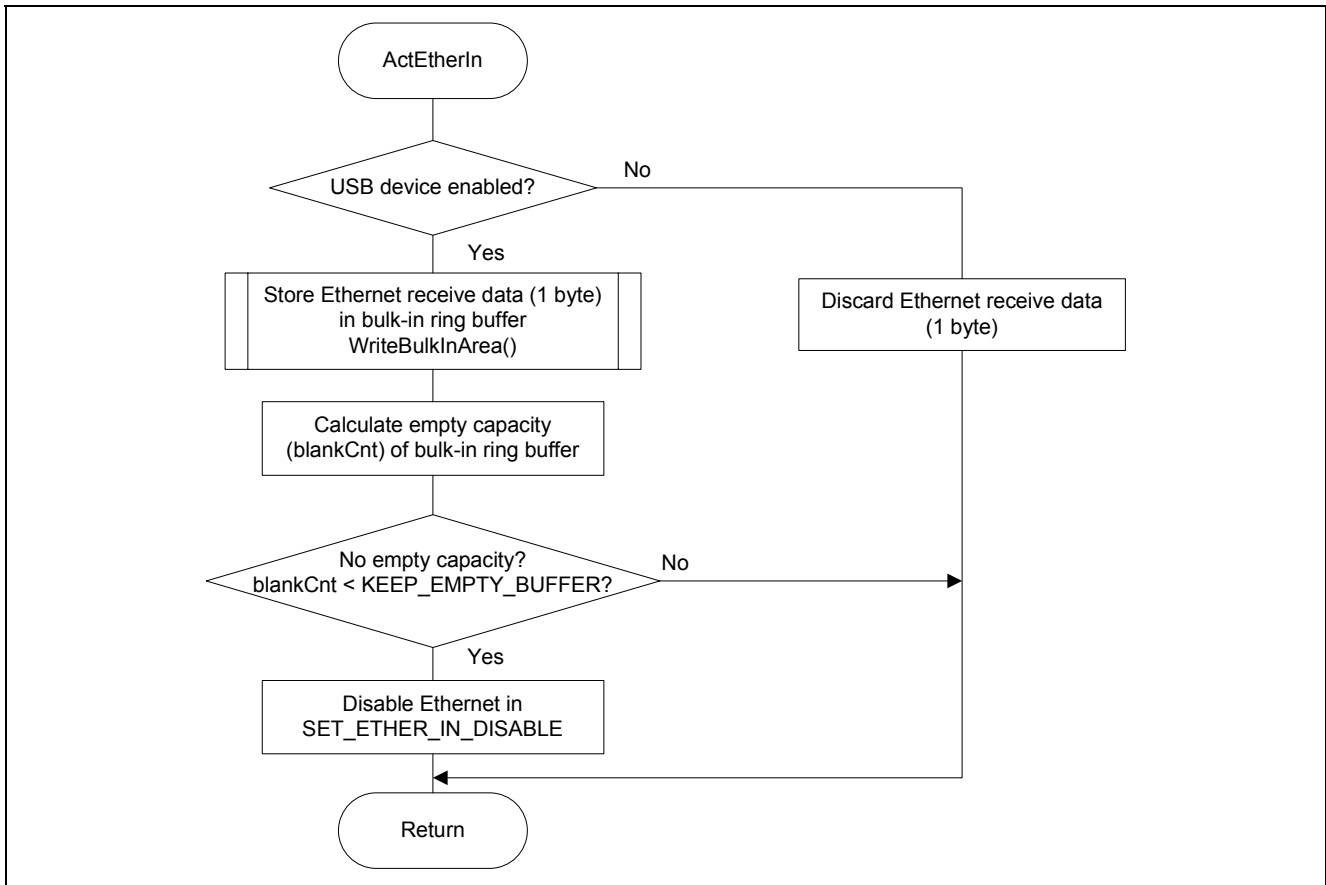

Figure 12 ActEtherIn Processing Sequence

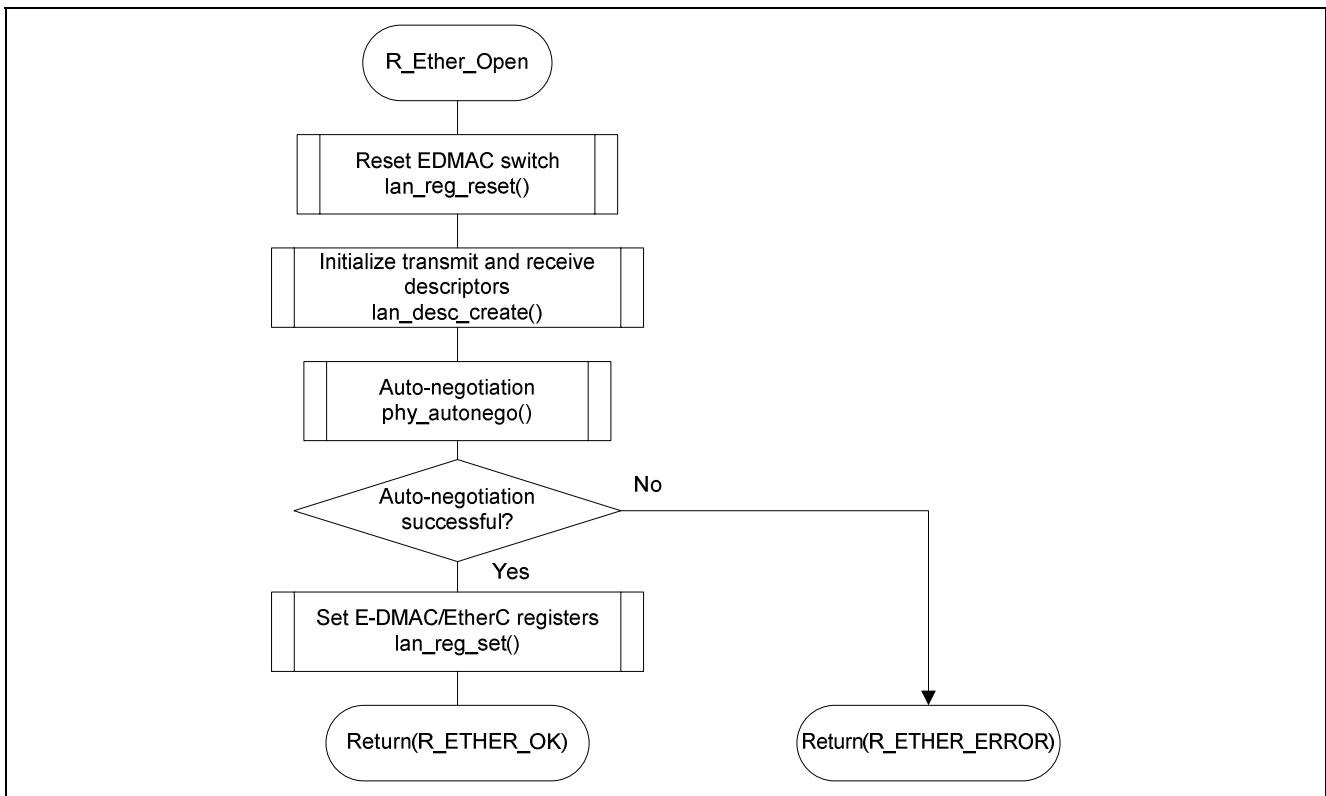

Figure 13 R\_Ether\_Open Processing Sequence

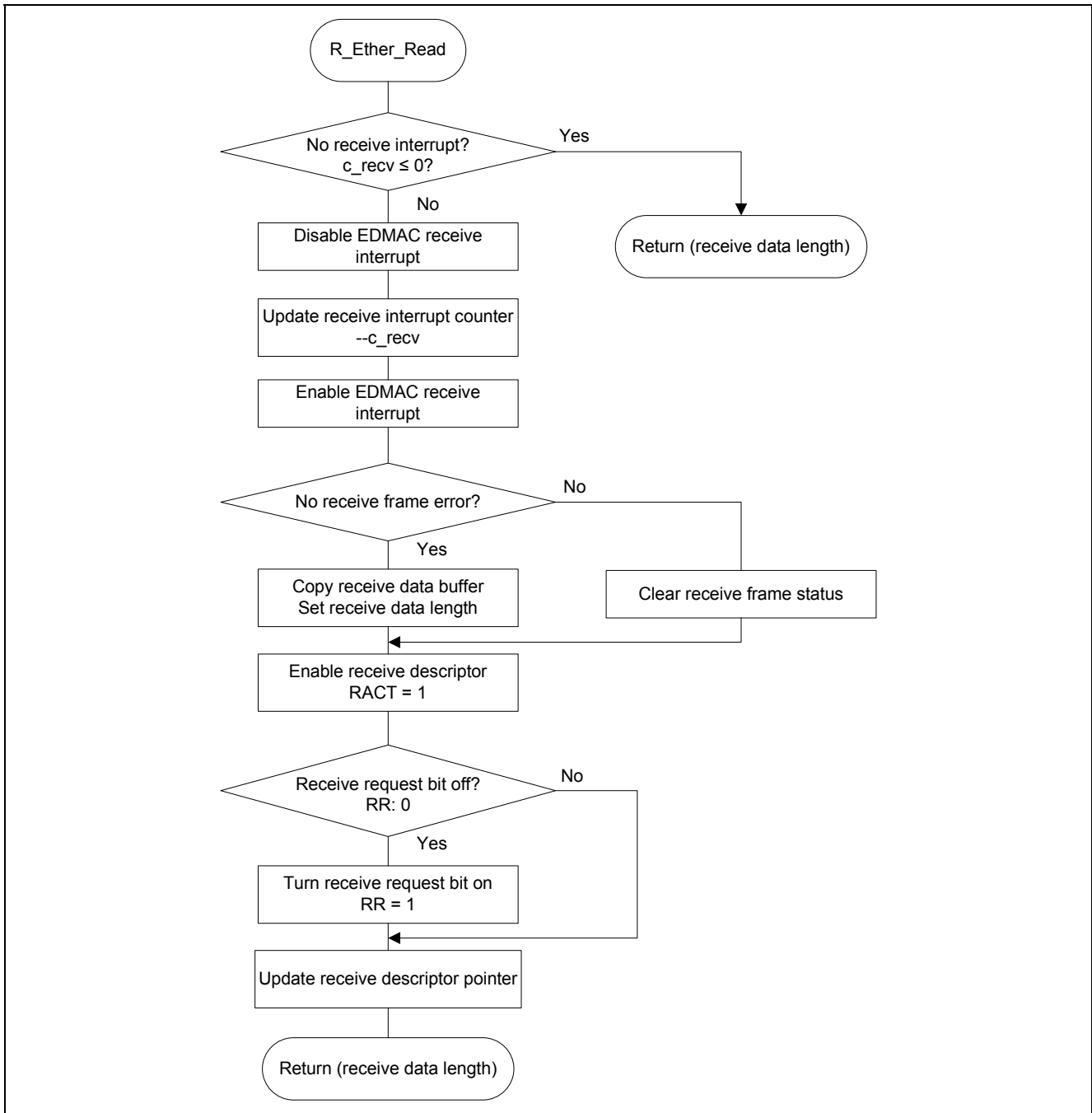

Figure 14 R\_Ether\_Read Processing Sequence

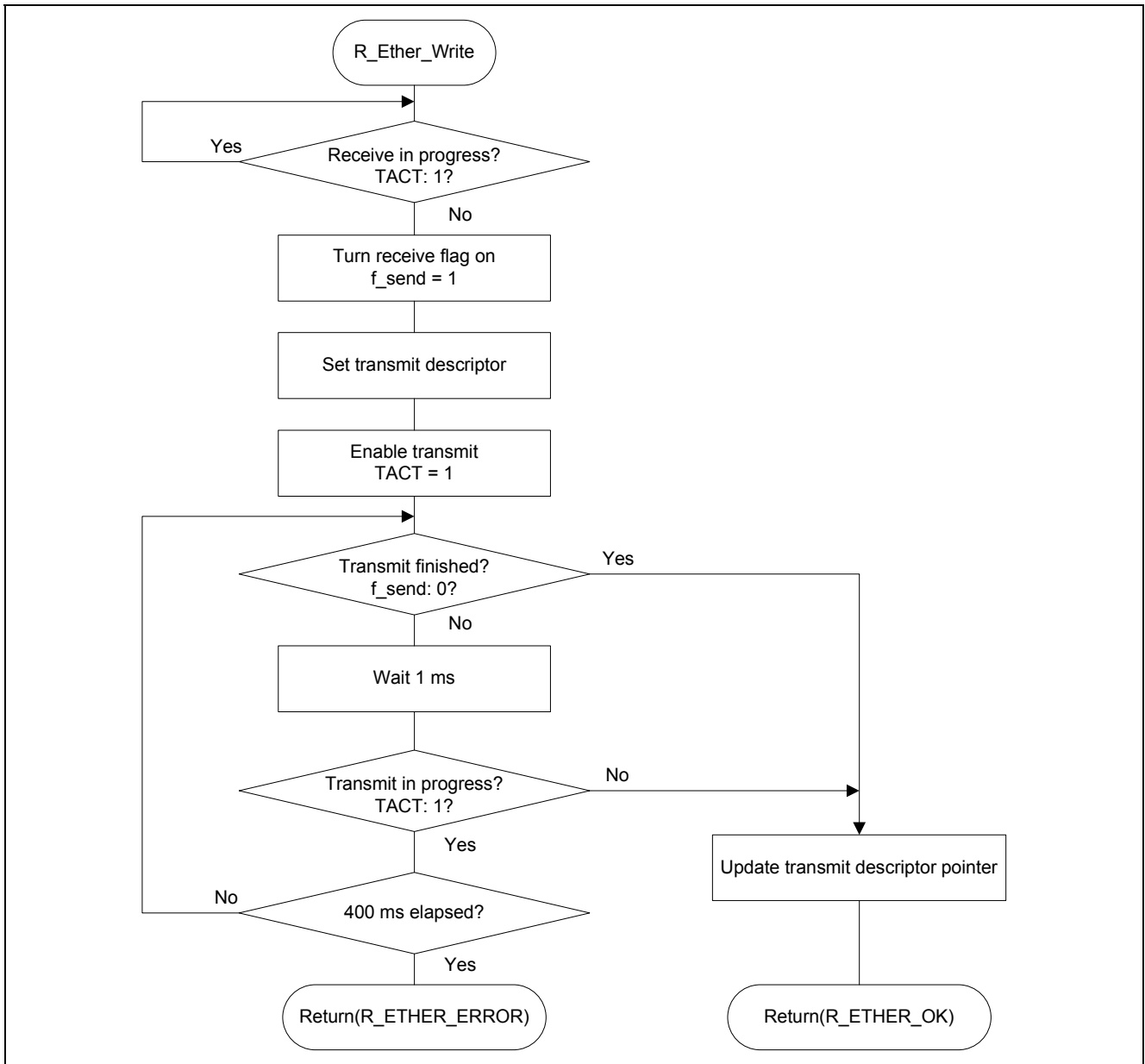

Figure 15 R\_Ether\_Write Processing Sequence

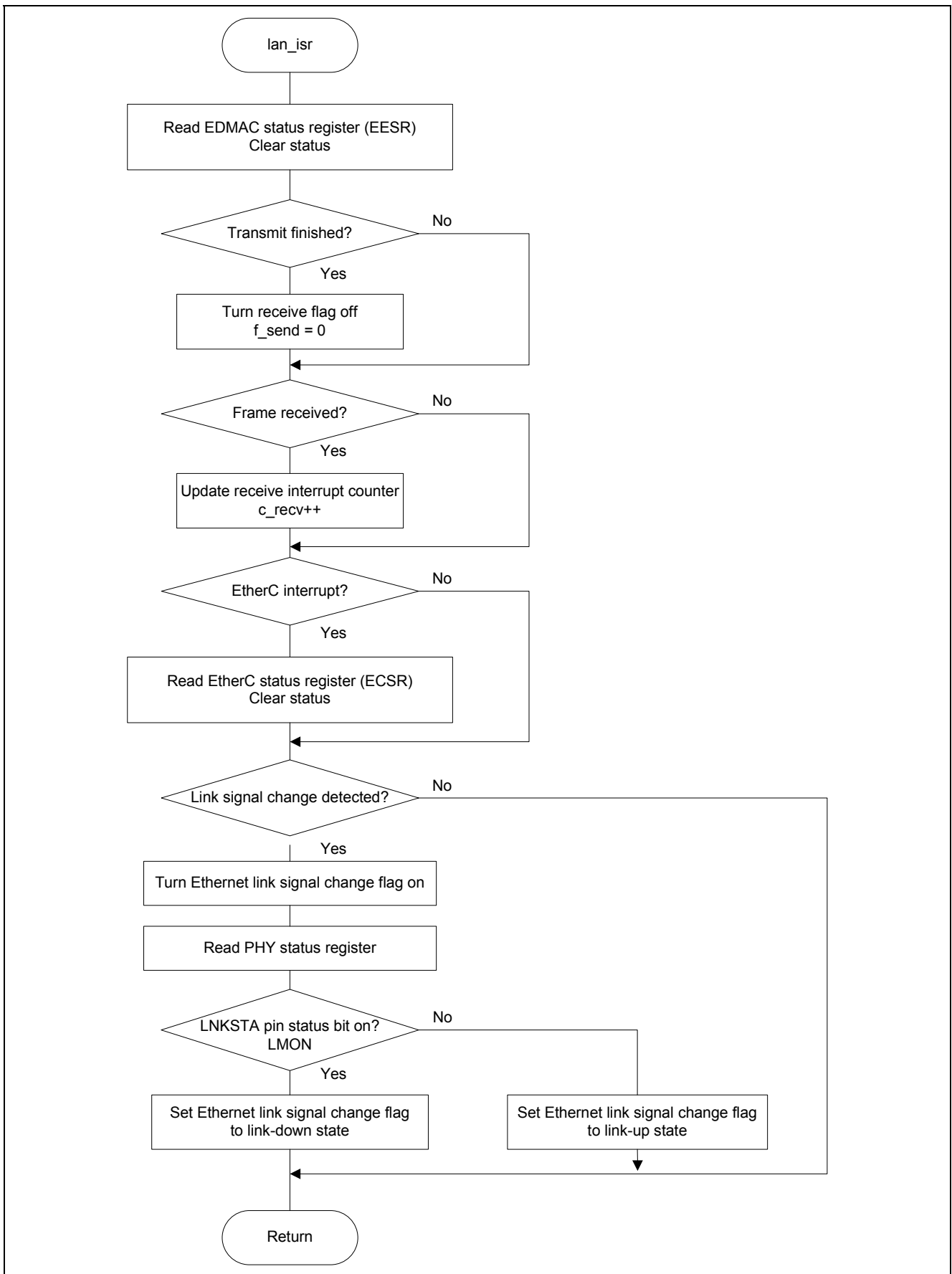

Figure 16 lan\_isr Processing Sequence

#### 4.2.4 USB Driver

The USB driver comprises a group of functions for handling control transfer, bulk transfer, and serial conversion operations using the USB function module (USB) of the SH7216.

Table 5 lists the functions of the USB driver.

**Table 5 List of USB Driver Functions**

No.	Function	Description
1	ActBusReset	Bus reset interrupt handler
2	ActBusVcc	USB bus connect/disconnect interrupt handler
3	ActControlInOut	Processes control-in/control-out
4	ActControl	Performs control transfers
5	ActBulkOut	Receives bulk-out data
6	ActBulkIn	Transmits bulk-in data
7	BranchOfInt0	USBIFR0 interrupt handler
8	BranchOfInt1	USBIFR1 interrupt handler

Figures 17 to 24 are flowcharts for the various functions.

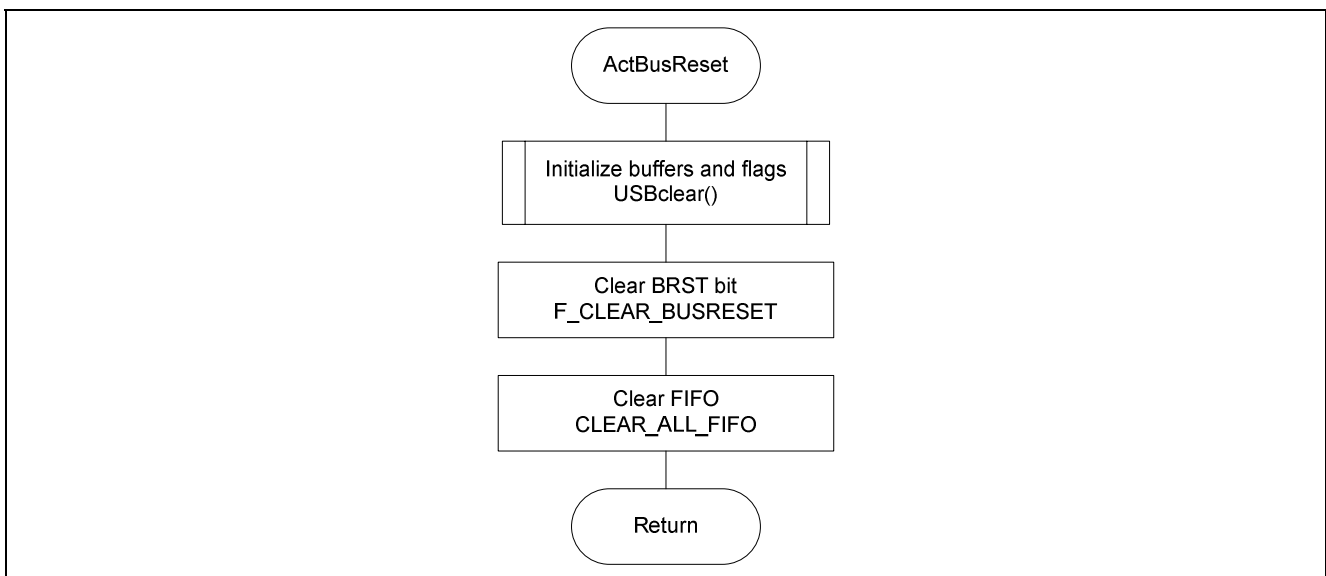

**Figure 17 ActBusReset Processing Sequence**

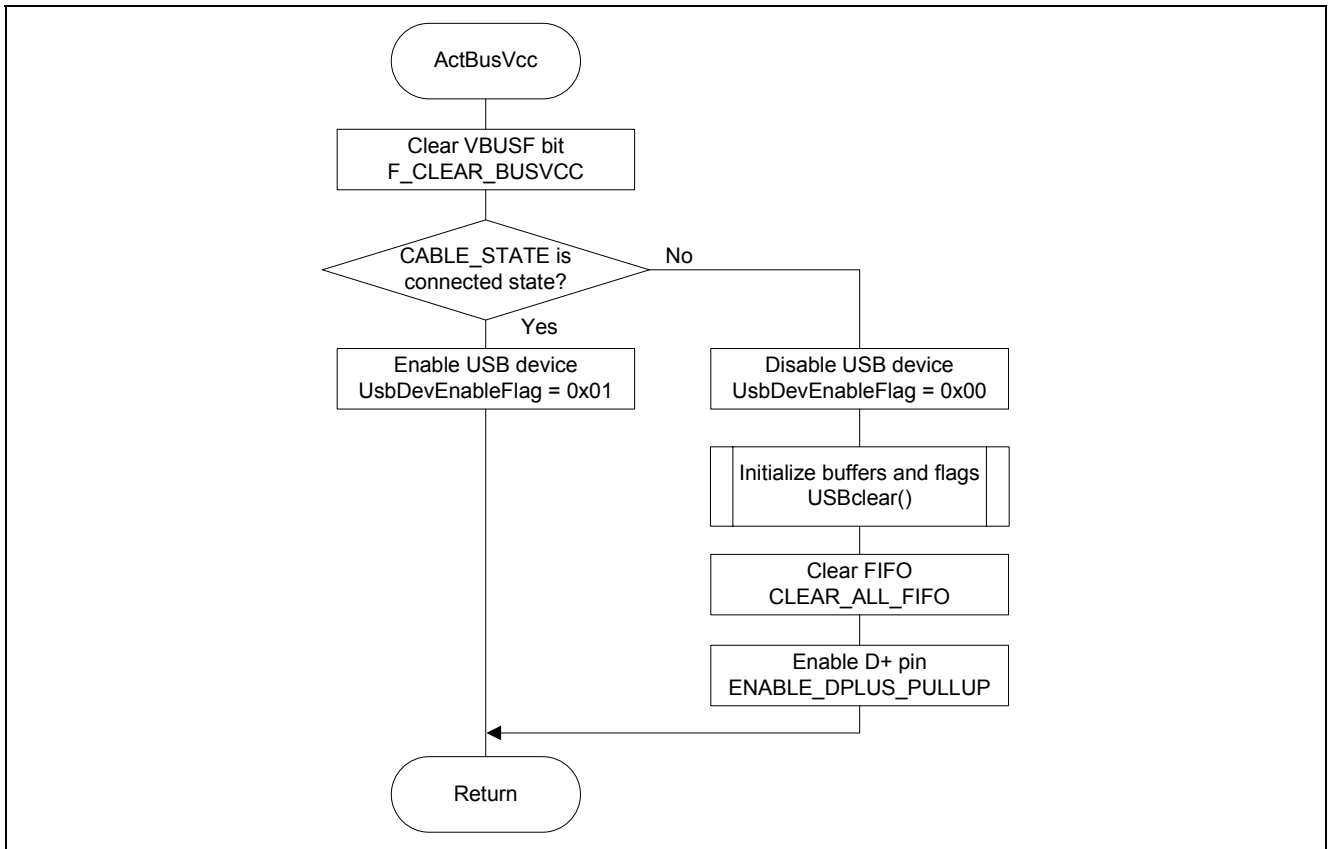

Figure 18 ActBusVcc Processing Sequence

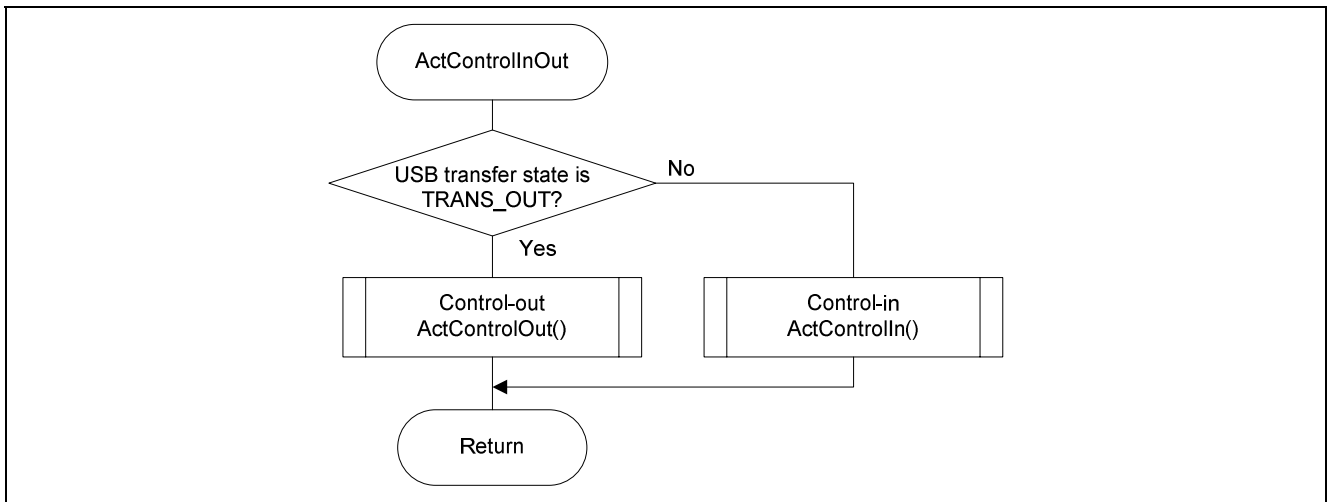

Figure 19 ActControlInOut Processing Sequence



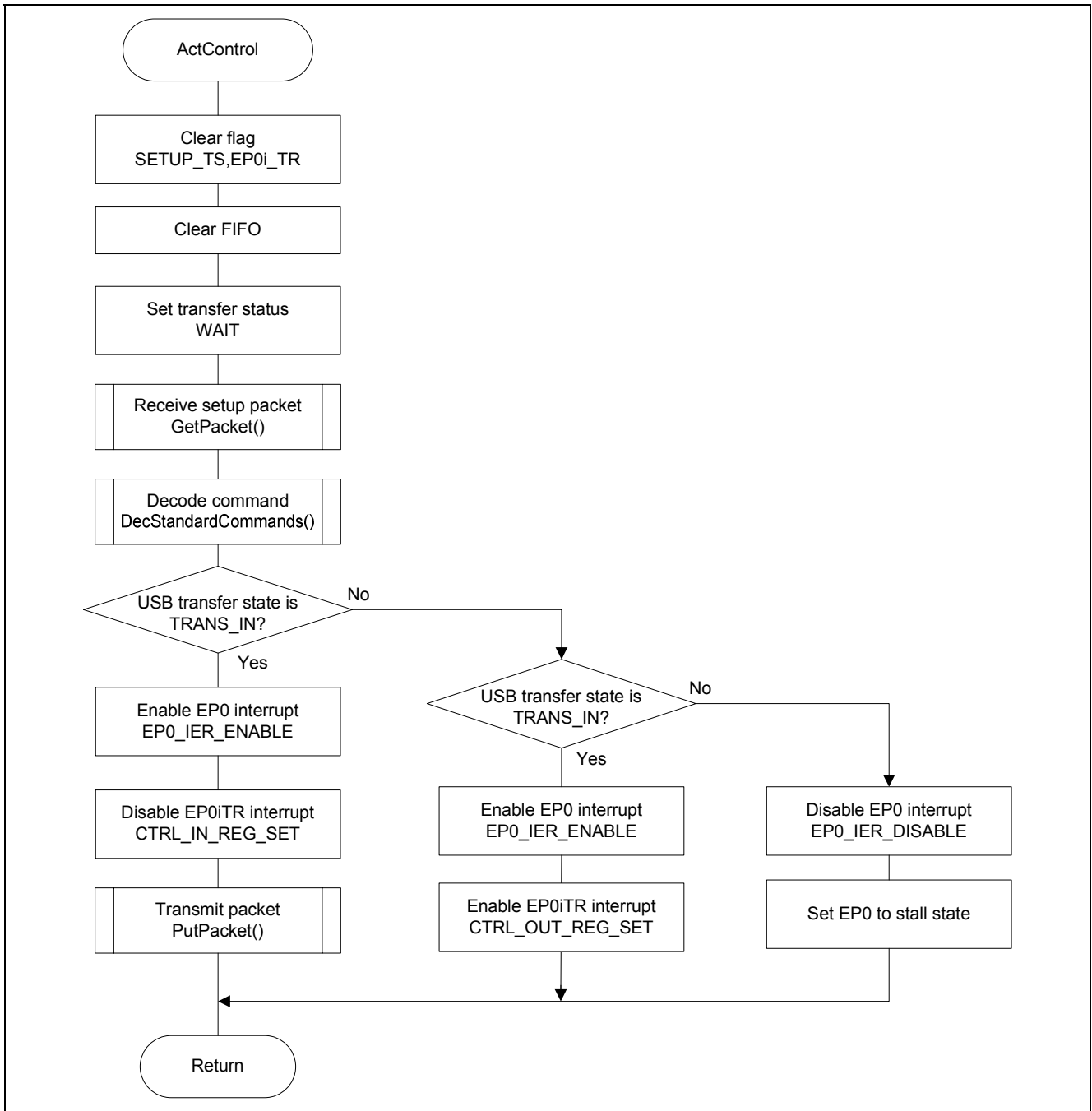

Figure 20 ActControl Processing Sequence

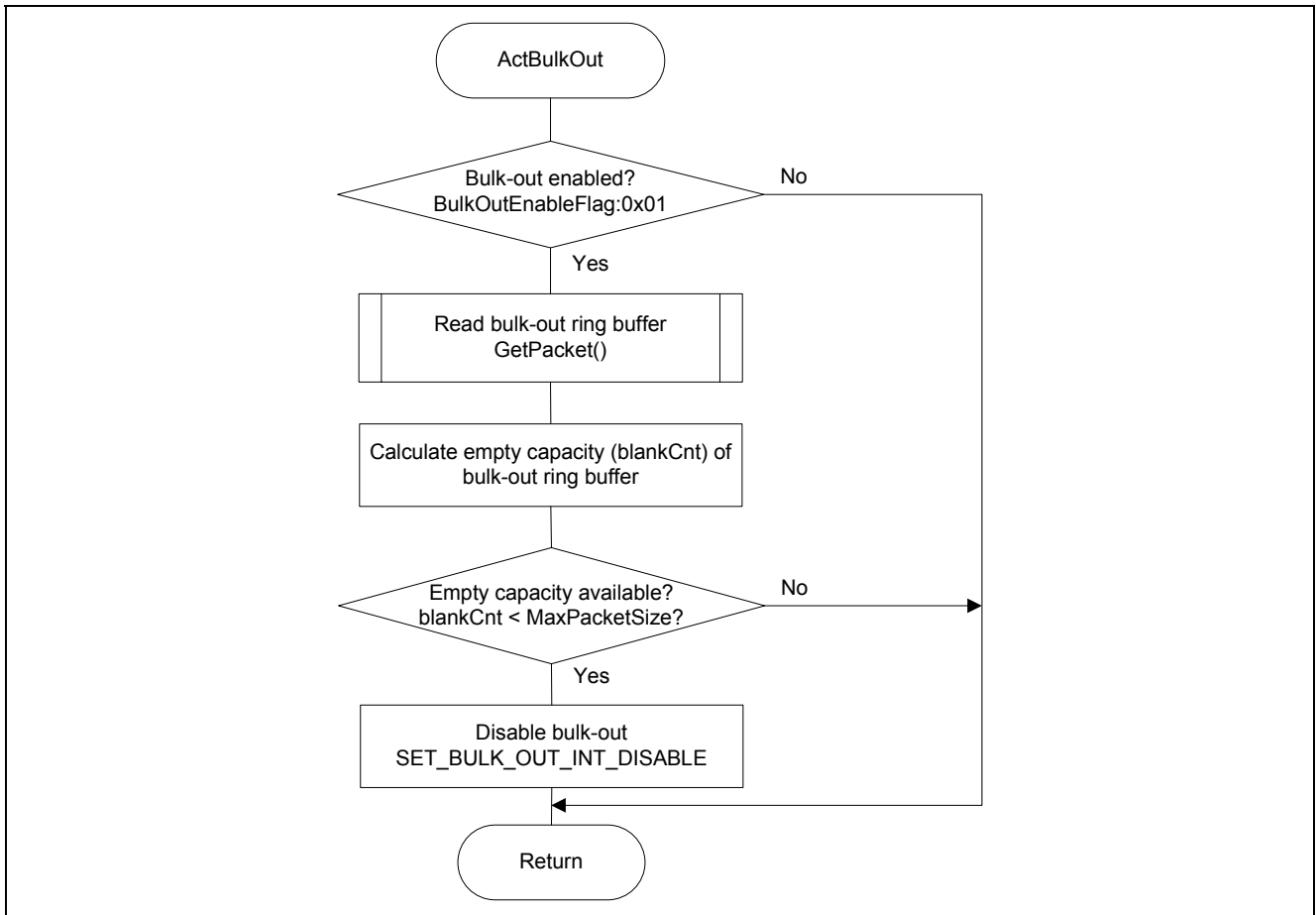

Figure 21 ActBulkOut Processing Sequence

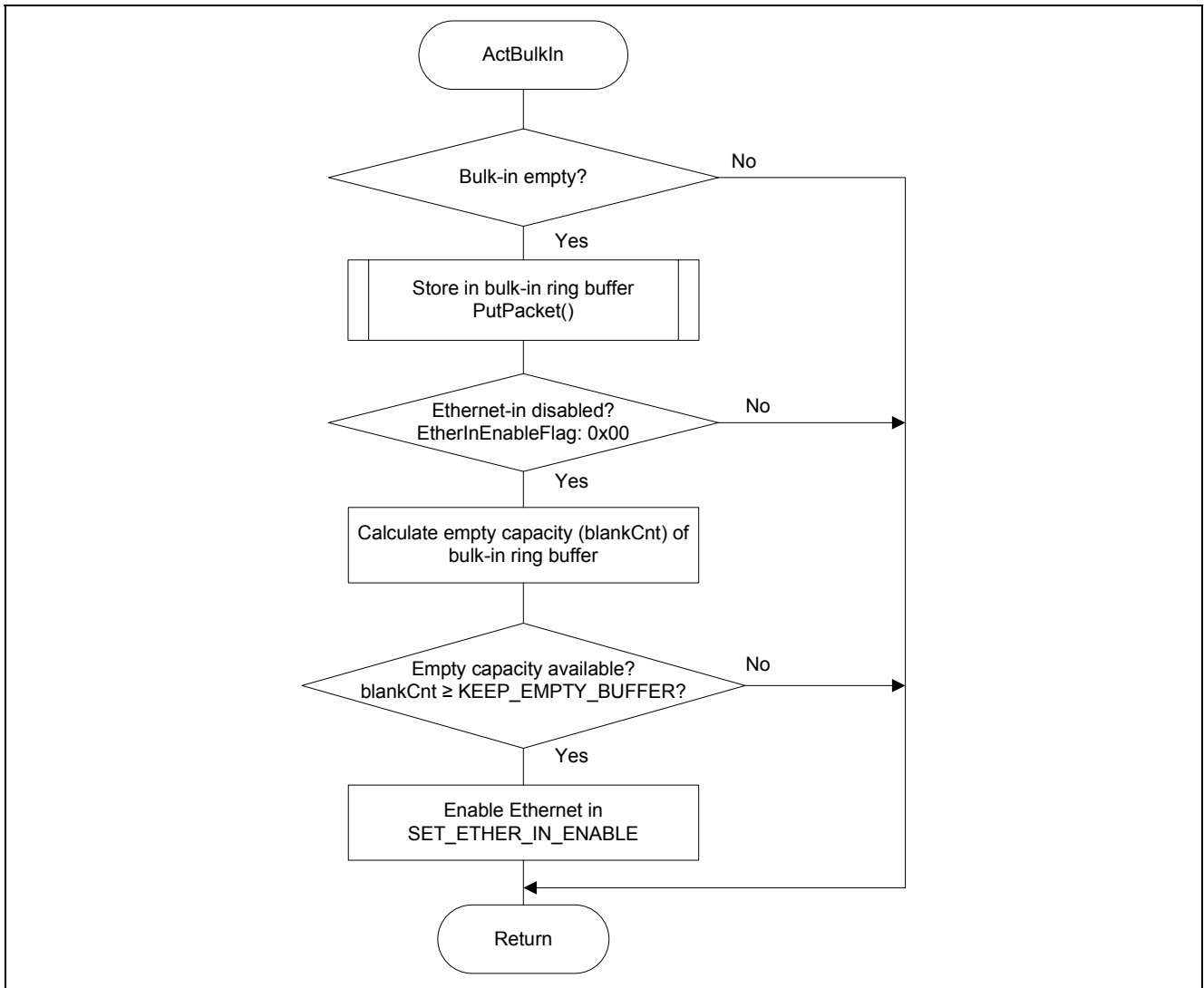

Figure 22 ActBulkIn Processing Sequence

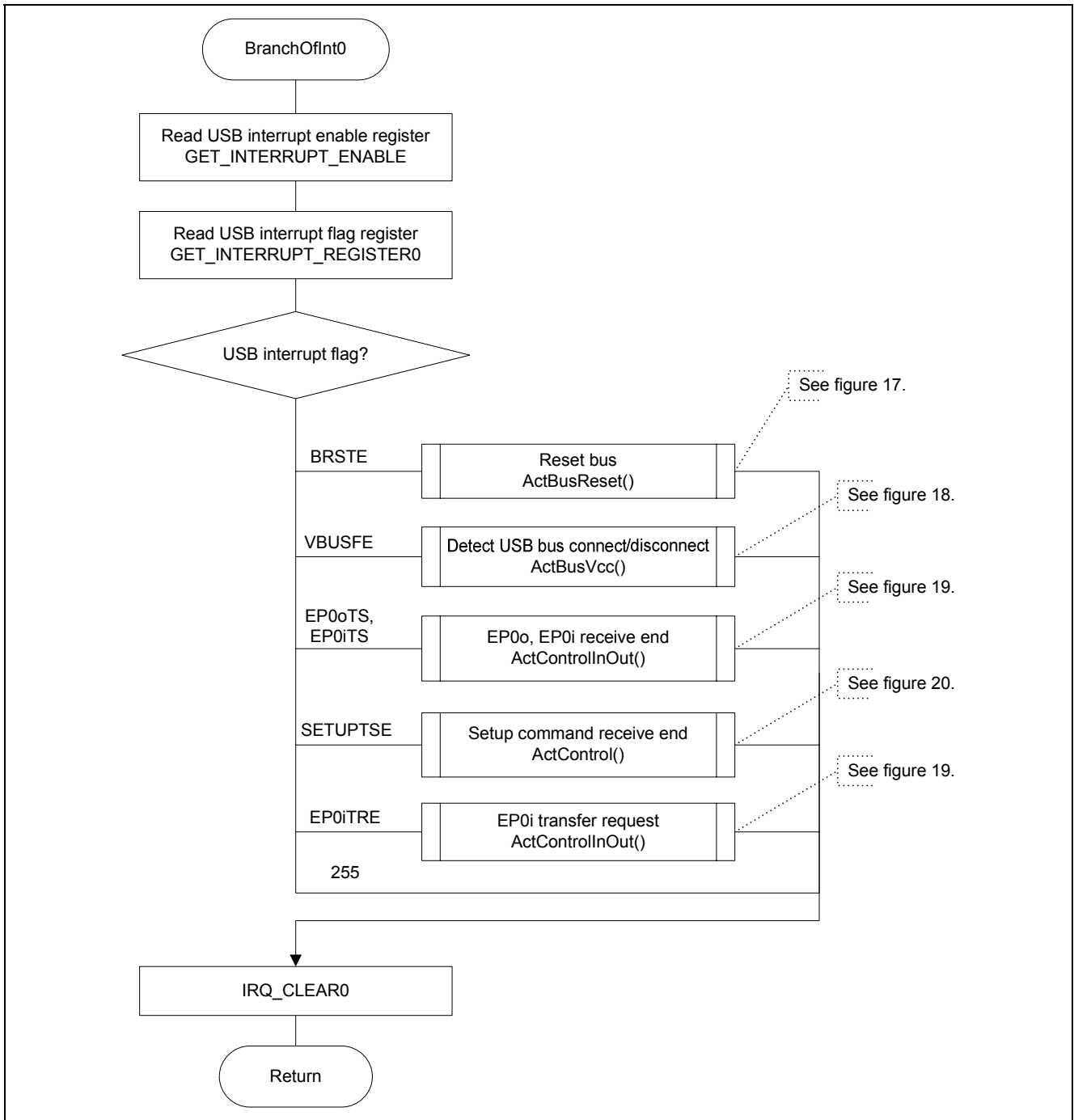

Figure 23 BranchOfInt0 Processing Sequence

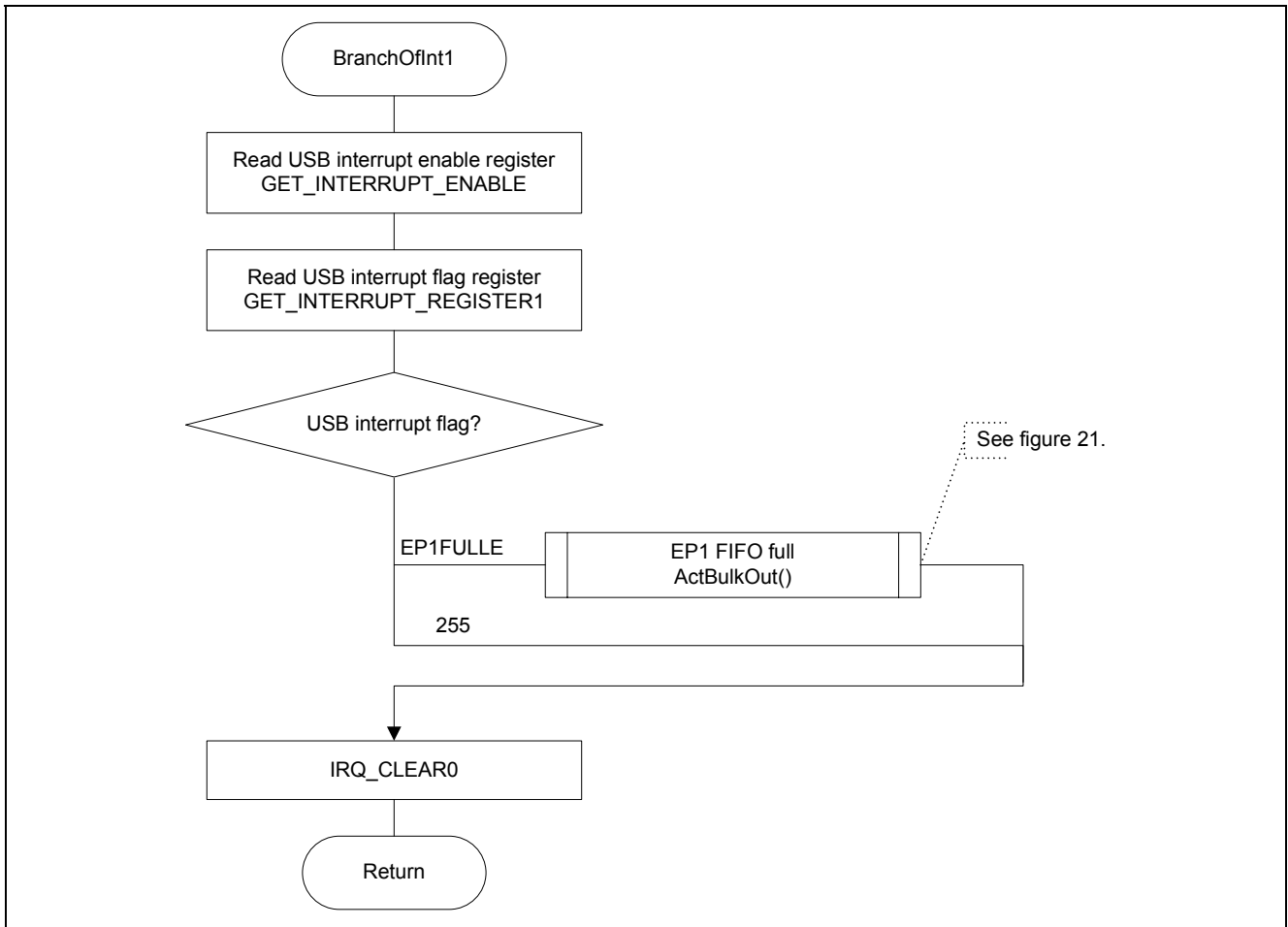

Figure 24 BranchOfInt1 Processing Sequence

### 4.2.5 Timer Driver

The timer driver comprises a group of functions for controlling the periodic timer using the compare match timer (CMT) of the SH7216.

The timer driver is used as the timer for uIP.

Table 6 lists the timer driver functions.

**Table 6 List of Timer Driver Functions**

No.	Function	Description
1	timer_init	Initializes and activates CMT0
2	timer_stop	Stops CMT0
3	clock_time	Fetches CMT0 counter value
4	int_cmt0_isr	CMT0 interrupt handler

Figures 25 to 28 are flowcharts for the various functions.

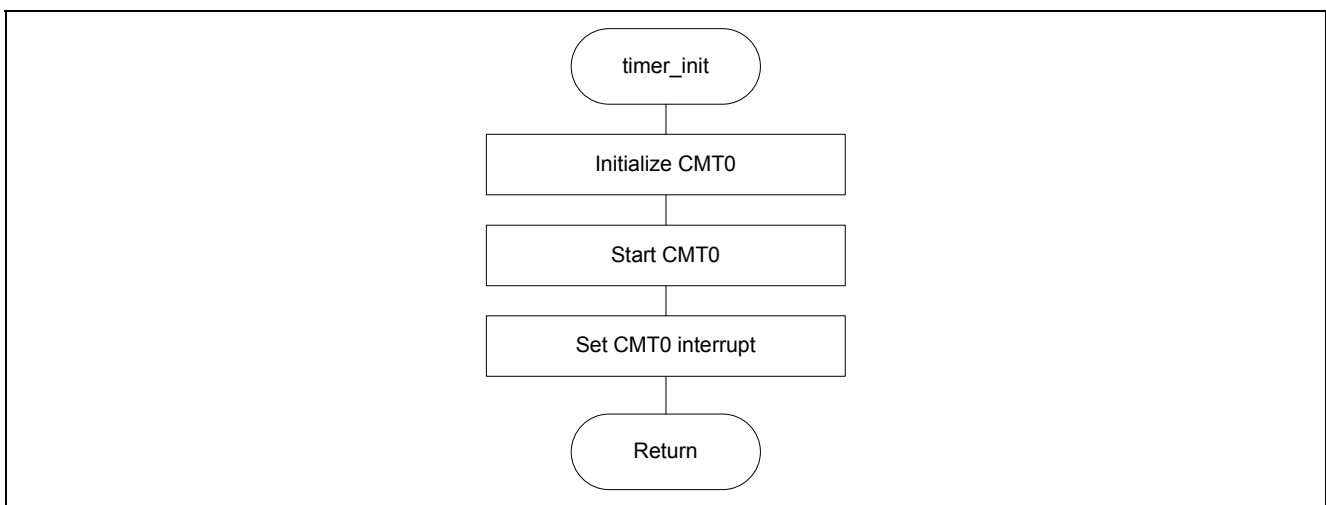

**Figure 25 timer\_init Processing Sequence**

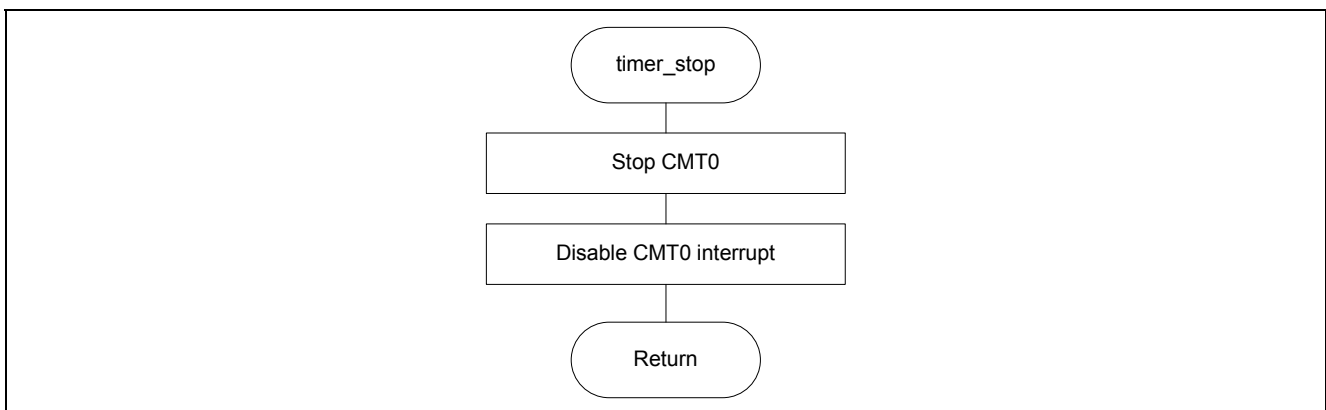

**Figure 26 timer\_stop Processing Sequence**

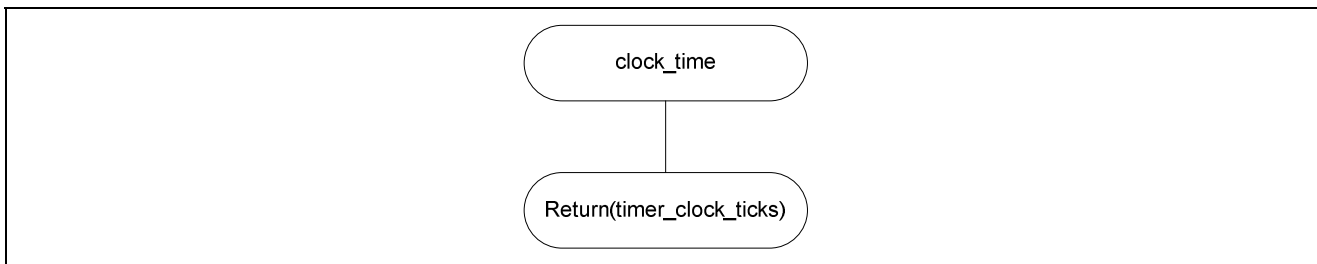

Figure 27 clock\_time Processing Sequence

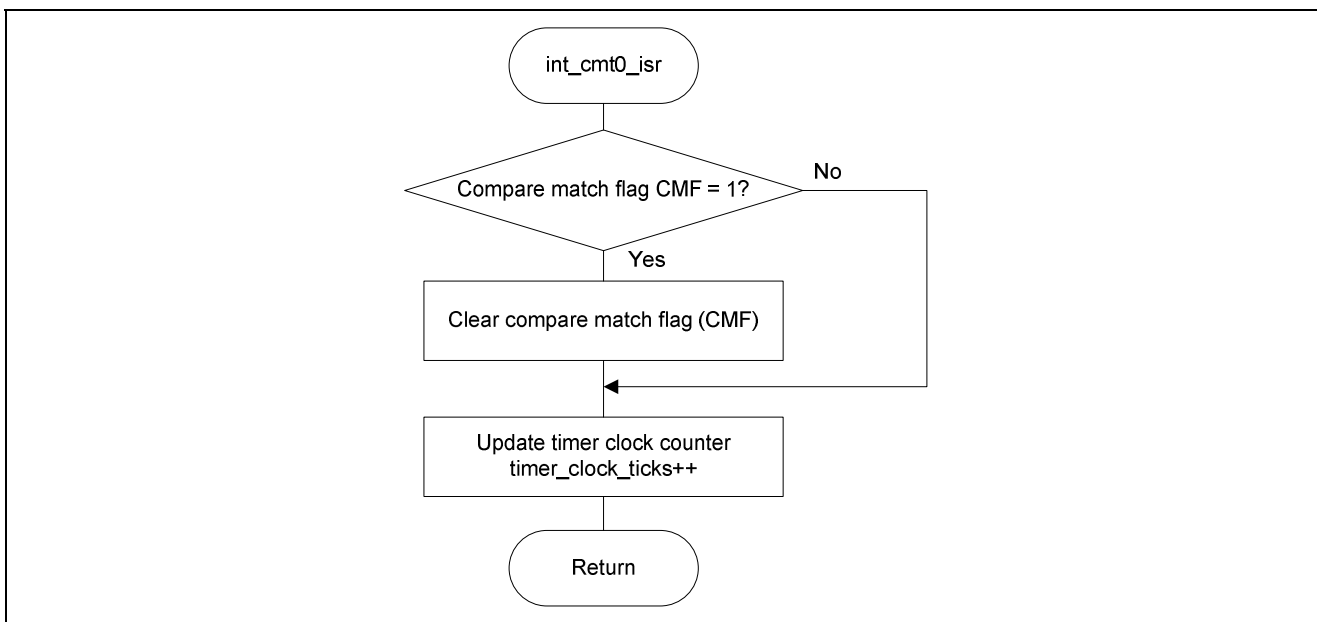

Figure 28 int\_cmt0\_isr Processing Sequence

#### 4.2.6 Section Settings

Table 7 lists information on the sections of the SH7216 sample program.

**Table 7 SH7216 Sample Program Section Information**

No.	Address	Section	Description
1	0x00000000	DVECTTBL	Vector table
2	0x00000400	P	Program area
3		P_CH_CPG	CPG setting program area
4		C	Constant area
5		D	Initialized data area
6	0xFFFF80000	B	Uninitialized data area
7		R	Initialized data area (for RAM allocation)
8	0xFFFF85000	R_CH_CPG	CPG setting program area (for RAM allocation)
9	0xFFFF88000	BETH_BUFF	Ethernet buffer area
10	0xFFFF8C000	BETH_DESC	Ethernet descriptor area
11	0xFFFF8FC00	S	Stack area

Note: The item 7 and item 8 Ethernet driver areas must be aligned with 32-byte boundaries.



**5. Reference Documents**

- Hardware Manual  
SH7216 Group Hardware Manual  
(The latest version can be downloaded from the Renesas Electronics Web site.)
- SH7216 Group USB Function Module USB HID Class Application Note
- SH7216 CPU Board User's Manual  
SH7216 CPU Board R0K572167C001BR User's Manual, Rev. 0.03
- uIP 1.0 Reference Manual  
The uIP Embedded TCP/IP Stack: The uIP 1.0 Reference Manual (June 2006)

## Website and Support

Renesas Electronics Website

<http://www.renesas.com/>

Inquiries

<http://www.renesas.com/inquiry>

All trademarks and registered trademarks are the property of their respective owners.

## Revision Record

Rev.	Date	Description	
		Page	Summary
1.00	Sep.07.10	—	First edition issued
1.01	Oct.19.10	32	Table 7 amended
1.10	Mar.17.11	—	Added read after FRQCR settings

## General Precautions in the Handling of MPU/MCU Products

The following usage notes are applicable to all MPU/MCU products from Renesas. For detailed usage notes on the products covered by this manual, refer to the relevant sections of the manual. If the descriptions under General Precautions in the Handling of MPU/MCU Products and in the body of the manual differ from each other, the description in the body of the manual takes precedence.

### 1. Handling of Unused Pins

Handle unused pins in accord with the directions given under Handling of Unused Pins in the manual.

- The input pins of CMOS products are generally in the high-impedance state. In operation with an unused pin in the open-circuit state, extra electromagnetic noise is induced in the vicinity of LSI, an associated shoot-through current flows internally, and malfunctions occur due to the false recognition of the pin state as an input signal become possible. Unused pins should be handled as described under Handling of Unused Pins in the manual.

### 2. Processing at Power-on

The state of the product is undefined at the moment when power is supplied.

- The states of internal circuits in the LSI are indeterminate and the states of register settings and pins are undefined at the moment when power is supplied.

In a finished product where the reset signal is applied to the external reset pin, the states of pins are not guaranteed from the moment when power is supplied until the reset process is completed.

In a similar way, the states of pins in a product that is reset by an on-chip power-on reset function are not guaranteed from the moment when power is supplied until the power reaches the level at which resetting has been specified.

### 3. Prohibition of Access to Reserved Addresses

Access to reserved addresses is prohibited.

- The reserved addresses are provided for the possible future expansion of functions. Do not access these addresses; the correct operation of LSI is not guaranteed if they are accessed.

### 4. Clock Signals

After applying a reset, only release the reset line after the operating clock signal has become stable.

When switching the clock signal during program execution, wait until the target clock signal has stabilized.

- When the clock signal is generated with an external resonator (or from an external oscillator) during a reset, ensure that the reset line is only released after full stabilization of the clock signal. Moreover, when switching to a clock signal produced with an external resonator (or by an external oscillator) while program execution is in progress, wait until the target clock signal is stable.

### 5. Differences between Products

Before changing from one product to another, i.e. to one with a different type number, confirm that the change will not lead to problems.

- The characteristics of MPU/MCU in the same group but having different type numbers may differ because of the differences in internal memory capacity and layout pattern. When changing to products of different type numbers, implement a system-evaluation test for each of the products.

## Notice

1. All information included in this document is current as of the date this document is issued. Such information, however, is subject to change without any prior notice. Before purchasing or using any Renesas Electronics products listed herein, please confirm the latest product information with a Renesas Electronics sales office. Also, please pay regular and careful attention to additional and different information to be disclosed by Renesas Electronics such as that disclosed through our website.
2. Renesas Electronics does not assume any liability for infringement of patents, copyrights, or other intellectual property rights of third parties by or arising from the use of Renesas Electronics products or technical information described in this document. No license, express, implied or otherwise, is granted hereby under any patents, copyrights or other intellectual property rights of Renesas Electronics or others.
3. You should not alter, modify, copy, or otherwise misappropriate any Renesas Electronics product, whether in whole or in part.
4. Descriptions of circuits, software and other related information in this document are provided only to illustrate the operation of semiconductor products and application examples. You are fully responsible for the incorporation of these circuits, software, and information in the design of your equipment. Renesas Electronics assumes no responsibility for any losses incurred by you or third parties arising from the use of these circuits, software, or information.
5. When exporting the products or technology described in this document, you should comply with the applicable export control laws and regulations and follow the procedures required by such laws and regulations. You should not use Renesas Electronics products or the technology described in this document for any purpose relating to military applications or use by the military, including but not limited to the development of weapons of mass destruction. Renesas Electronics products and technology may not be used for or incorporated into any products or systems whose manufacture, use, or sale is prohibited under any applicable domestic or foreign laws or regulations.
6. Renesas Electronics has used reasonable care in preparing the information included in this document, but Renesas Electronics does not warrant that such information is error free. Renesas Electronics assumes no liability whatsoever for any damages incurred by you resulting from errors in or omissions from the information included herein.
7. Renesas Electronics products are classified according to the following three quality grades: "Standard", "High Quality", and "Specific". The recommended applications for each Renesas Electronics product depends on the product's quality grade, as indicated below. You must check the quality grade of each Renesas Electronics product before using it in a particular application. You may not use any Renesas Electronics product for any application categorized as "Specific" without the prior written consent of Renesas Electronics. Further, you may not use any Renesas Electronics product for any application for which it is not intended without the prior written consent of Renesas Electronics. Renesas Electronics shall not be in any way liable for any damages or losses incurred by you or third parties arising from the use of any Renesas Electronics product for an application categorized as "Specific" or for which the product is not intended where you have failed to obtain the prior written consent of Renesas Electronics. The quality grade of each Renesas Electronics product is "Standard" unless otherwise expressly specified in a Renesas Electronics data sheets or data books, etc.  
"Standard": Computers; office equipment; communications equipment; test and measurement equipment; audio and visual equipment; home electronic appliances; machine tools; personal electronic equipment; and industrial robots.  
"High Quality": Transportation equipment (automobiles, trains, ships, etc.); traffic control systems; anti-disaster systems; anti-crime systems; safety equipment; and medical equipment not specifically designed for life support.  
"Specific": Aircraft; aerospace equipment; submersible repeaters; nuclear reactor control systems; medical equipment or systems for life support (e.g. artificial life support devices or systems), surgical implantations, or healthcare intervention (e.g. excision, etc.), and any other applications or purposes that pose a direct threat to human life.
8. You should use the Renesas Electronics products described in this document within the range specified by Renesas Electronics, especially with respect to the maximum rating, operating supply voltage range, movement power voltage range, heat radiation characteristics, installation and other product characteristics. Renesas Electronics shall have no liability for malfunctions or damages arising out of the use of Renesas Electronics products beyond such specified ranges.
9. Although Renesas Electronics endeavors to improve the quality and reliability of its products, semiconductor products have specific characteristics such as the occurrence of failure at a certain rate and malfunctions under certain use conditions. Further, Renesas Electronics products are not subject to radiation resistance design. Please be sure to implement safety measures to guard them against the possibility of physical injury, and injury or damage caused by fire in the event of the failure of a Renesas Electronics product, such as safety design for hardware and software including but not limited to redundancy, fire control and malfunction prevention, appropriate treatment for aging degradation or any other appropriate measures. Because the evaluation of microcomputer software alone is very difficult, please evaluate the safety of the final products or system manufactured by you.
10. Please contact a Renesas Electronics sales office for details as to environmental matters such as the environmental compatibility of each Renesas Electronics product. Please use Renesas Electronics products in compliance with all applicable laws and regulations that regulate the inclusion or use of controlled substances, including without limitation, the EU RoHS Directive. Renesas Electronics assumes no liability for damages or losses occurring as a result of your noncompliance with applicable laws and regulations.
11. This document may not be reproduced or duplicated, in any form, in whole or in part, without prior written consent of Renesas Electronics.
12. Please contact a Renesas Electronics sales office if you have any questions regarding the information contained in this document or Renesas Electronics products, or if you have any other inquiries.

(Note 1) "Renesas Electronics" as used in this document means Renesas Electronics Corporation and also includes its majority-owned subsidiaries.

(Note 2) "Renesas Electronics product(s)" means any product developed or manufactured by or for Renesas Electronics.



### SALES OFFICES

Renesas Electronics Corporation

<http://www.renesas.com>

Refer to "<http://www.renesas.com/>" for the latest and detailed information.

#### Renesas Electronics America Inc.

2880 Scott Boulevard Santa Clara, CA 95050-2554, U.S.A.  
Tel: +1-408-588-6000, Fax: +1-408-588-6130

#### Renesas Electronics Canada Limited

1101 Nicholson Road, Newmarket, Ontario L3Y 9C3, Canada  
Tel: +1-905-898-5441, Fax: +1-905-898-3220

#### Renesas Electronics Europe Limited

Dukes Meadow, Millboard Road, Bourne End, Buckinghamshire, SL8 5FH, U.K  
Tel: +44-1628-585-100, Fax: +44-1628-585-900

#### Renesas Electronics Europe GmbH

Arcadiastrasse 10, 40472 Düsseldorf, Germany  
Tel: +49-211-65030, Fax: +49-211-6503-1327

#### Renesas Electronics (China) Co., Ltd.

7th Floor, Quantum Plaza, No.27 ZhiChunLu Haidian District, Beijing 100083, P.R.China  
Tel: +86-10-8235-1155, Fax: +86-10-8235-7679

#### Renesas Electronics (Shanghai) Co., Ltd.

Unit 204, 205, AZIA Center, No.1233 Lujiazui Ring Rd., Pudong District, Shanghai 200120, China  
Tel: +86-21-5877-1818, Fax: +86-21-6887-7858 / -7898

#### Renesas Electronics Hong Kong Limited

Unit 1601-1613, 16/F., Tower 2, Grand Century Place, 193 Prince Edward Road West, Mongkok, Kowloon, Hong Kong  
Tel: +852-2886-9318, Fax: +852-2886-9022/9044

#### Renesas Electronics Taiwan Co., Ltd.

7F, No. 363 Fu Shing North Road Taipei, Taiwan  
Tel: +886-2-8175-9600, Fax: +886-2-8175-9670

#### Renesas Electronics Singapore Pte. Ltd.

1 HarbourFront Avenue, #06-10, Keppel Bay Tower, Singapore 098632  
Tel: +65-6213-0200, Fax: +65-6278-8001

#### Renesas Electronics Malaysia Sdn.Bhd.

Unit 906, Block B, Menara Amcorp, Amcorp Trade Centre, No. 18, Jln Persiaran Barat, 46050 Petaling Jaya, Selangor Darul Ehsan, Malaysia  
Tel: +60-3-7955-9390, Fax: +60-3-7955-9510

#### Renesas Electronics Korea Co., Ltd.

11F., Samik Laviel' or Bldg., 720-2 Yeoksam-Dong, Kangnam-Ku, Seoul 135-080, Korea  
Tel: +82-2-558-3737, Fax: +82-2-558-5141