

---

## RZ/T2M Group

R01AN7274EJ0110

Rev.1.10

## MTU3 Phase Count Sample Program (Z Phase support)

---

Jun.26,2024

### Introduction

This application note uses the Multi-Function Timer Pulse Unit 3 (MTU3) phase counting mode feature of the RZ/T2M.

This is a sample program that counts the number of pulses in phases A and B of a 3-phase encoder using the function of phase counting in mode 1, and clears the count of pulses in phases A and B when the pulse in phase Z is acquired.

The main functions of the MTU3 Phase Count Mode sample program are shown below.

1. Command input from the terminal acquires the count value of phase A and B pulses of the 3-phase encoder pulse number and resets the count value
2. After the pulse of phase Z is acquired, the pulse counts of phase A and B are cleared.
3. Phase Counting Mode 1 can use the following two functions
  - Cascade Connection 32-Bit Phase Counting Mode (default)
  - 16-Bit Phase Counting Mode

### Target Device

RZ/T2M Group

When applying the sample program covered in this application note to another microcomputer, modify the program according to the specifications for the target microcomputer and conduct an extensive evaluation of the modified program.

## Contents

<b>1. Specifications</b> .....	3
<b>1.1 RZ/T2M operating environment</b> .....	4
1.1.1 Switch Setting .....	5
1.1.2 Jumper Setting .....	5
<b>2. Operating Environment</b> .....	6
<b>3. Peripheral Functions</b> .....	7
<b>4. Hardware</b> .....	8
4.1 Hardware Configuration .....	8
4.2 Pins .....	9
<b>5. Software</b> .....	10
5.1 Operation Outline .....	10
5.2 System Block Diagram .....	10
5.3 Application .....	11
5.3.1 Constants .....	11
5.3.2 Main function .....	12
5.3.3 Functions List .....	13
5.3.3.1 hal_entry .....	14
5.3.3.2 initialize .....	14
5.3.3.3 sci_uart_callback .....	14
5.3.3.4 handle_error .....	14
5.4 FSP driver functions .....	15
5.4.1 SCI module functions .....	15
5.4.2 MTU3 Phase Count module functions .....	15
<b>6. How the sample application works</b> .....	16
6.1 How the EWARM version works .....	16
6.2 How the GCC version works .....	19
6.3 How the sample application works .....	23
6.3.1 Operation .....	23
6.3.1.1 Count Get operation .....	24
6.3.1.2 Count Reset operation .....	24
<b>7. About phase counting mode</b> .....	25
7.1 Phase counting mode 1 .....	25
7.2 Cascade Connection 32-Bit Phase Counting Mode .....	26
<b>Revision History</b> .....	27

## 1. Specifications

Table 1-1 lists the peripheral functions to be used and their applications, Table 1-1 shows the operating environment.

**Table 1-1 Peripheral Functions and Applications**

Peripheral Function	Application
Serial communication interface (SCI)	Used for setting instructions from the terminal. (Get or Reset instructions)
Multi-Function Timer Pulse Unit 3 (MTU3)	Cascade Connection 32-Bit Phase Counting Mode or 16-Bit Phase Counting Mode. Phase counting mode 1. The MTIOC1A pin is used for Z-phase.

### 1.1 RZ/T2M operating environment

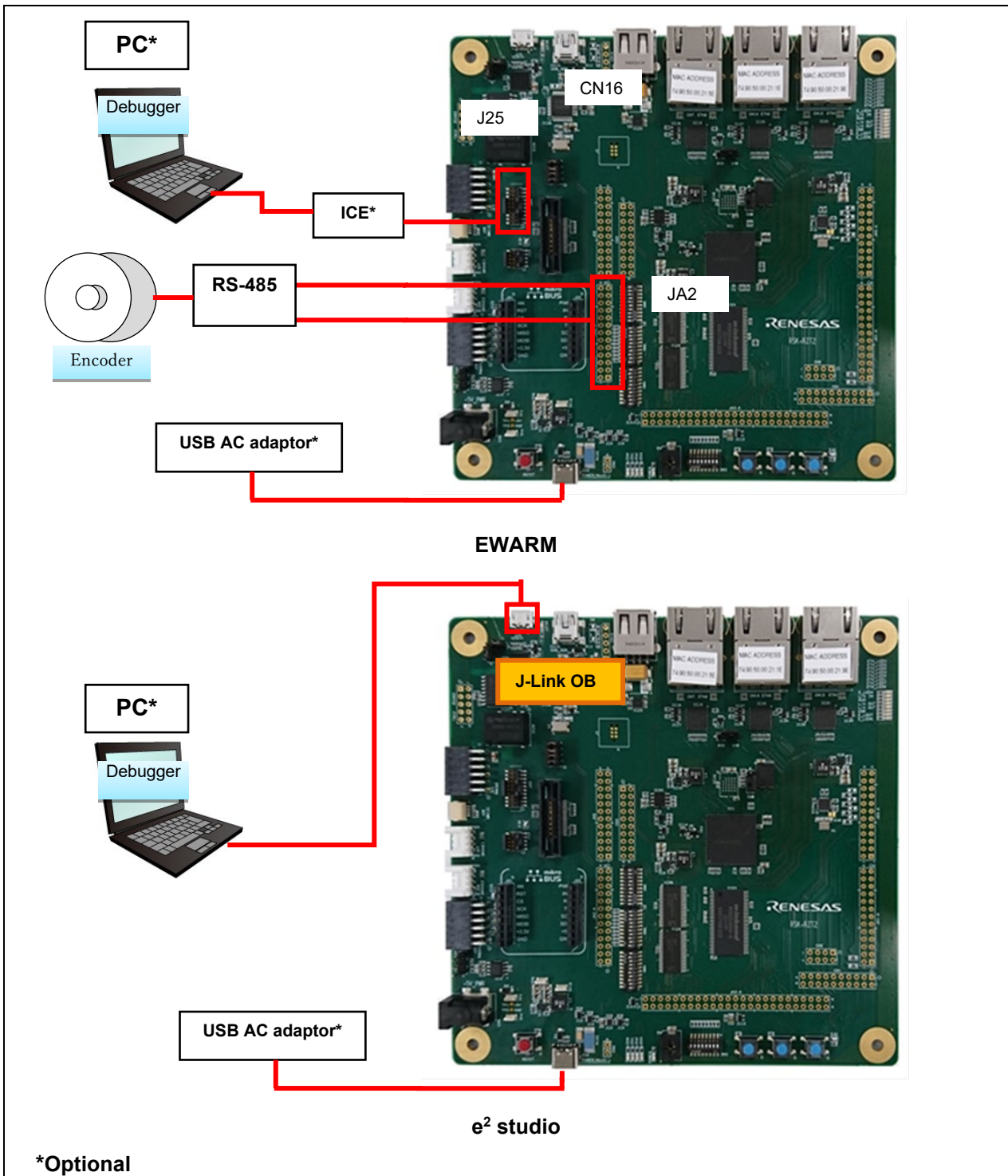

Figure 1-1 Operating Environment (RZ/T2M)

\*Optional

Function	Connector	Pin	Signal	Condition
SCI	CN16	TXD0(P16_5) RXD0(P16_6)	UART_USB_TX UART_USB_RX	USB on Renesas Starter Kit+ for RZ/T2M
MTU3	JA2-A-25 JA2-A-26 JA2-A-23	MTCLKA(P13_5) MTCLKB(P13_6) MTIOC1A(P11_1)	M1_TRCCLK_18 M1_TRDCLK_18 MTIOC1A_18	Pin header on Renesas Starter Kit+ for RZ/T2M

### 1.1.1 Switch Setting

#### ■SW4

1	2	3	4	5	6	7	8
ON	OFF	ON	ON	OFF	OFF	OFF	OFF

#### ■SW5

1	2	3	4	5	6	7	8	9	10
OFF	OFF	OFF	ON	OFF	OFF	OFF	OFF	ON	OFF

#### ■SW6

1	2	3	4	5	6	7	8	9	10
OFF	OFF	OFF	OFF	OFF	OFF	OFF	OFF	OFF	OFF

### 1.1.2 Jumper Setting

Table 1-2 Renesas Starter Kit+ for RZ/T2M jumper setting

No	Jumper number	Setting
1	CN17	Jumper 2-3 short
2	J9	Jumper 1-2 short (When using JTAG)
		Jumper 1-2 open (When using J-Link OB)

## 2. Operating Environment

The sample program covered in this application note is intended for the environment below.

**Table 2-1 Operating Environment**

Item	Description
Board	Renesas Starter Kit+ for RZ/T2M
MPU	RZ/T2M Group(R9A07G075M24GBG)
Encoder(Motor)	MB057GA140
Conversion board	RS-485 board
Operating frequency	CPU Core0 : 800MHz(Arm <sup>®</sup> Cortex <sup>®</sup> -R52)
Operating voltage	3.3V/1.8V/1.1V
Integrated development environment	Manufactured by IAR Systems Embedded Workbench <sup>®</sup> for Arm Version 9.50.1 Manufactured by RENESAS e <sup>2</sup> studio 2024-01.1 (24.1.1) (R20240125-1623) Toolchain GNU ARM Embedded 12.2.1.arm-12-24
Emulator	Manufactured by IAR Systems I-jet Manufactured by SEGGER J-Link Base Ver.11.0
Flexible Software Package (FSP)	Version 2.0.0

### 3. Peripheral Functions

The basics of the operating modes, Serial communication interface (SCI), Multi-Function Timer Pulse Unit 3 (MTU3), and general I/O ports are described in the RZ/T2M Group User's Manual.

## 4. Hardware

### 4.1 Hardware Configuration

The hardware configuration is shown below.

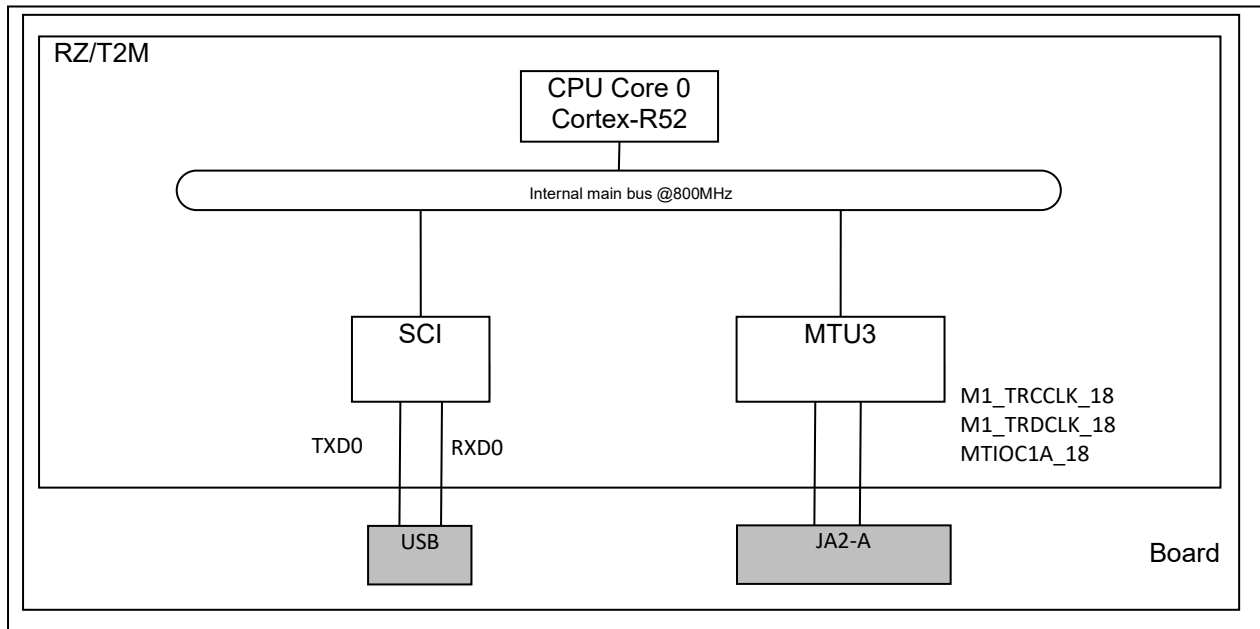

Figure 4-1 Hardware Configuration (RZ/T2M)

## 4.2 Pins

The following table shows the pins and functions.

**Table 4-1 Pins and Functions (RZ/T2M)**

Pin name	I/O	Function
TXD0(P16_5)	Output	Send data to terminal
RXD0(P16_6)	Input	Receive data from terminal
M1_TRCCLK_18 (P13_5)	Input	3-phase encoder Phase A signal
M1_TRDCLK_18 (P13_6)	Input	3-phase encoder Phase B signal
MTIOC1A_18 (P11_1)	Input	3-phase encoder Phase Z signal

## 5. Software

### 5.1 Operation Outline

This software uses serial communication interface (SCI) asynchronous communication to communicate with the host PC via COM port of RS-232 interface, and changes the bit mode by changing the program.

Do one of the following with a command from the terminal software on the host PC.

- When you enter the "g" command, the count value is obtained. (When the pulse of phase Z is acquired, the count value is set to 0.)
- When you enter the "r" command, the count value is reset to 0.

The bit mode can be switched by changing BITMODE\_CHANGE below.

(Default is cascaded 32-bit phase counting mode.)

```
33 #define BITMODE_CHANGE      (0) /* 0:32bit,1:16bit */
```

- Setting BITMODE\_CHANGE to 0 places the device in cascade-connected 32-bit phase counting mode.
- Setting BITMODE\_CHANGE to 1 places the device in 16-bit phase counting mode.

### 5.2 System Block Diagram

Figure 5-1 shows the software configuration of this sample program.

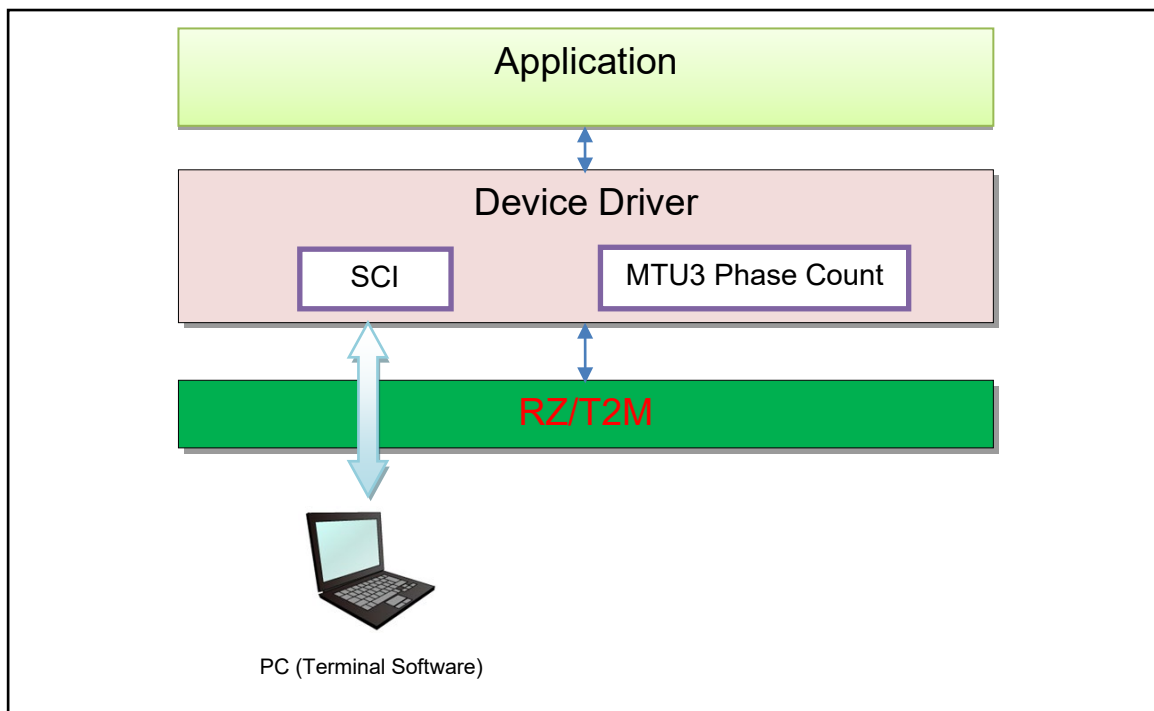

Figure 5-1 Software Configuration

## 5.3 Application

### 5.3.1 Constants

Table 5-1 shows the Constants

**Table 5-1 Constants**

Constant Name	Setting Value	Description
CHARACTER_LENGTH_BYTE	20	Maximum data length of character string (unit: Byte)
BITMODE_CHANGE	0	Bitmode change

5.3.2 Main function

Figure 5-2 shown flowchart of the main function flowchart

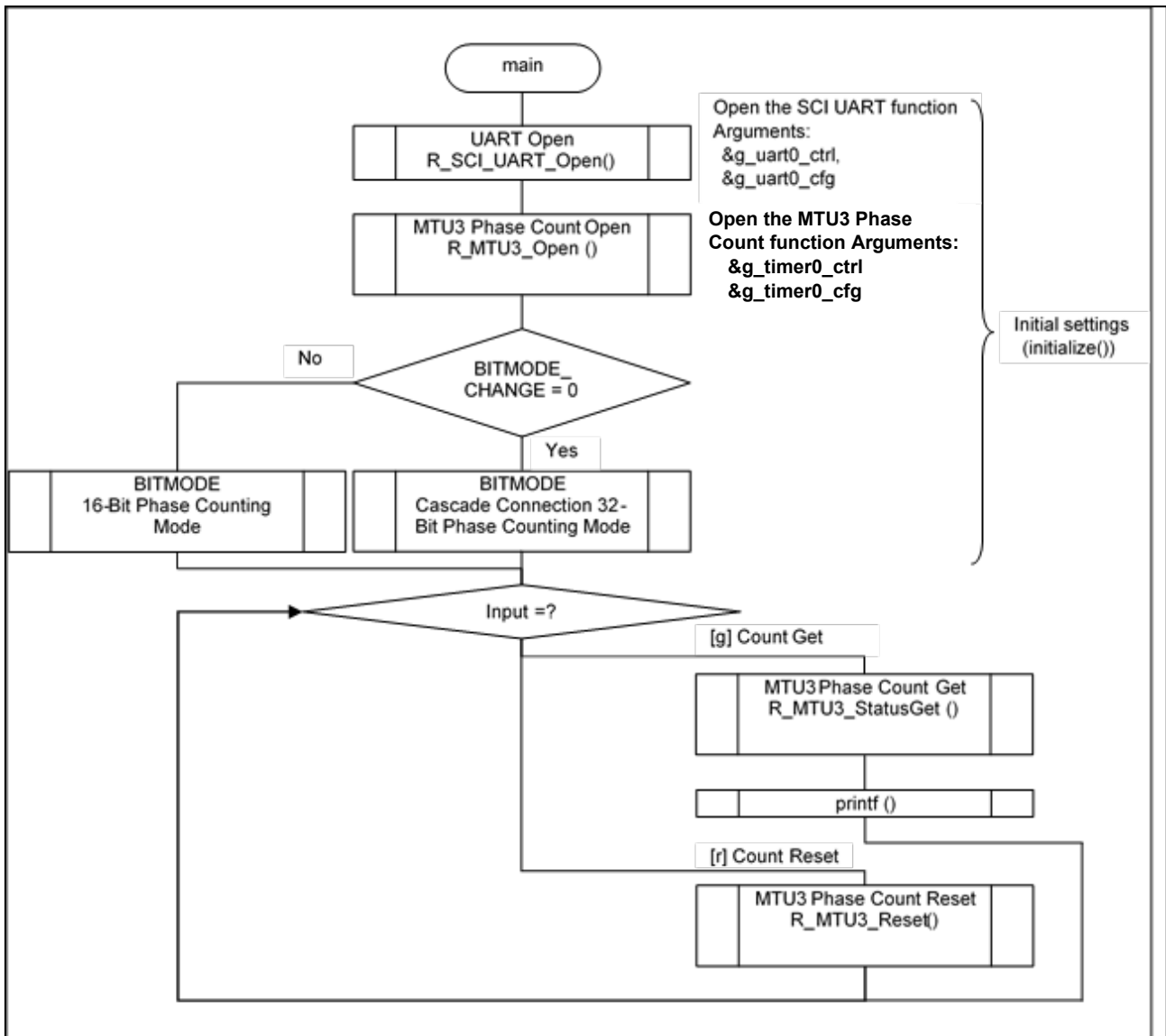

Figure 5-2 FLOWCHART (Initialize, Mode select)

### 5.3.3 Functions List

Table 5-2 shows the functions.

**Table 5-2 Function list**

Layer / Block	Function Name	Chapter
Application	hal_entry ()	5.3.3.1
	initialize ()	5.3.3.2
	sci_uart_callback ()	5.3.3.3
	handle_error ()	5.3.3.4

**5.3.3.1 hal\_entry**

---

**hal\_entry**

---

Synopsis	Master side main routine of the sample software	
Header	hal_data.h	
Declaration	void hal_entry(void)	
Description	This is the master side main routine of the sample software.	
Arguments	void	none
Return values	-	none

**5.3.3.2 initialize**

---

**initialize**

---

Synopsis	Initialize	
Header	-	
Declaration	static void initialize(void)	
Description	Initialize for the following processes. <ul style="list-style-type: none"> <li>• SCI_UART</li> <li>• SCI_UART_Baud</li> <li>• MTU3 Phase Count</li> </ul>	
Arguments	void	none
Return values	-	none

**5.3.3.3 sci\_uart\_callback**

---

**sci\_uart\_callback**

---

Synopsis	Callback function for sci_uart instruction	
Header	-	
Declaration	void sci_uart_callback(uart_callback_args_t* p_args)	
Description	Receive the callback of the sci_uart instruction and process the events in the received callback.	
Arguments	uart_callback_args_t* p_args	A pointer to the Arguments information
Return values	-	none

**5.3.3.4 handle\_error**

---

**handle\_error**

---

Synopsis	Error processing	
Header	-	
Declaration	static void handle_error(fsp_err_t err)	
Description	Performs processing when an error occurs in processing using the FSP driver.	
Arguments	fsp_err_t err	fsp error content
Return values	-	none

## 5.4 FSP driver functions

### 5.4.1 SCI module functions

Table 5-3 lists the functions to be used.

Please refer to "RZ/T2M Flexible Software Package Documentation" for the function details.

**Table 5-3 Functions**

Function	Description
R_SCI_UART_Open	SCI_UART open function
R_SCI_UART_Close	SCI_UART close function
R_SCI_UART_Read	Read from UART device
R_SCI_UART_Write	Write to UART device
R_SCI_UART_CallbackSet	User callback function
R_SCI_UART_BaudSet	Update SCI_UART baud rate
R_SCI_UART_InfoGet	Provides driver information
R_SCI_UART_Abort	Provides an API to abort an in-progress transfer
R_SCI_UART_BaudCalculate	Calculate the set value of the baud rate register
R_SCI_UART_VersionGet	Get the API version number

### 5.4.2 MTU3 Phase Count module functions

Table 5-4 lists the functions to be used

Please refer to "RZ/T2M Flexible Software Package Documentation" for the function details.

**Table 5-4 Functions**

Function	Description
R_MTU3_Open	MTU3 open function
R_MTU3_Stop	Stop the MTU3 timer
R_MTU3_Start	Start the MTU3 timer
R_MTU3_Reset	Reset the MTU3 timer
R_MTU3_PeriodSet	Sets the MTU3 period
R_MTU3_InfoGet	Gets information about the MTU3 clock, TGR register, etc.
R_MTU3_StatusGet	Gets MTU3 counter value etc.
R_MTU3_CouterSet	Sets the MTU3 counter value.
R_MTU3_OutputEnable	Enables MTU3 output
R_MTU3_OutputDisable	Disables MTU3 output.
R_MTU3_AdcTriggerSet	Set the timer A/D conversion start request period setting register
R_MTU3_CallbackSet	User callback function
R_MTU3_Close	MTU3 close function

## 6. How the sample application works

### 6.1 How the EWARM version works

Build the sample program and load it into RAM using IAR Embedded Workbench.

Note: Please install FSP Smart Configurator in advance.

1. Open a sample project.

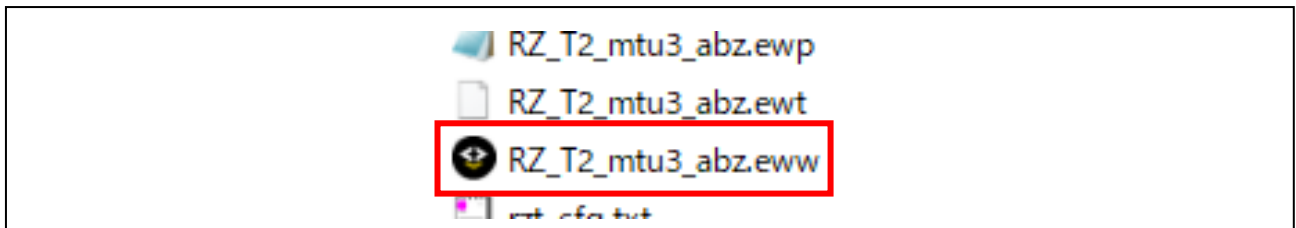

Figure 6-1 Open sample project

2. Open "RZ Smart Configurator".

Note: Smart Configurator must be registered in advance in [Tools] – [Configure Tools...].

[Tools] – [Configure Tools...] select [New] and enter the following:

Menu Text : RZ Smart Configurator

Command : " Describe the absolute path of rasc.exe installation "

Argument : --compiler IAR configuration.xml

Initial Directory : \$PROJ\_DIR\$

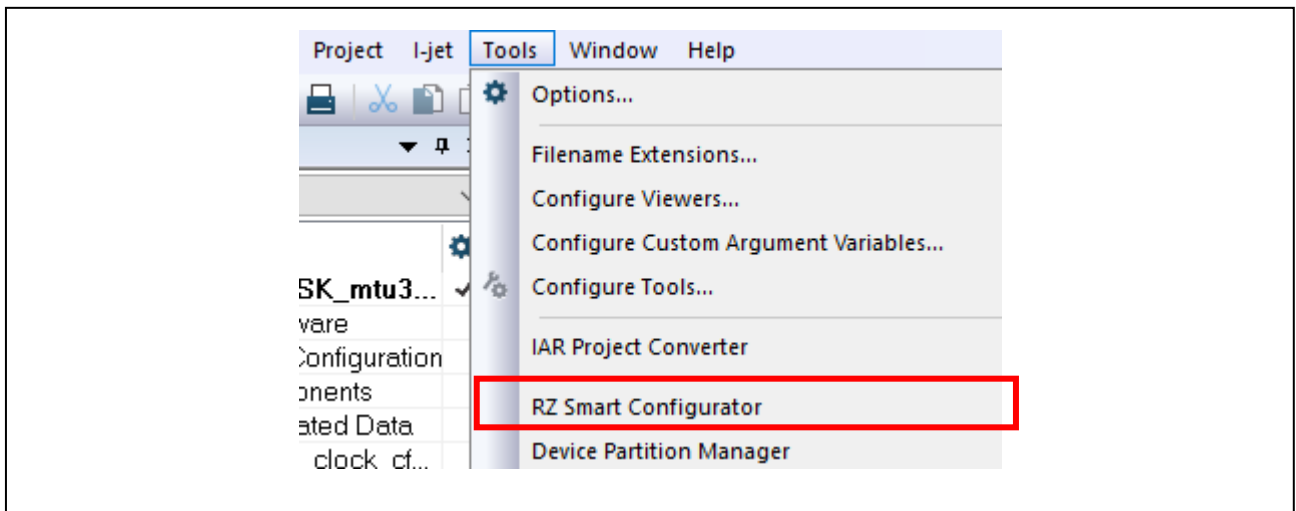

Figure 6-2 RZ Smart Configurator

- Click "Generate Project Content" to generate the code.

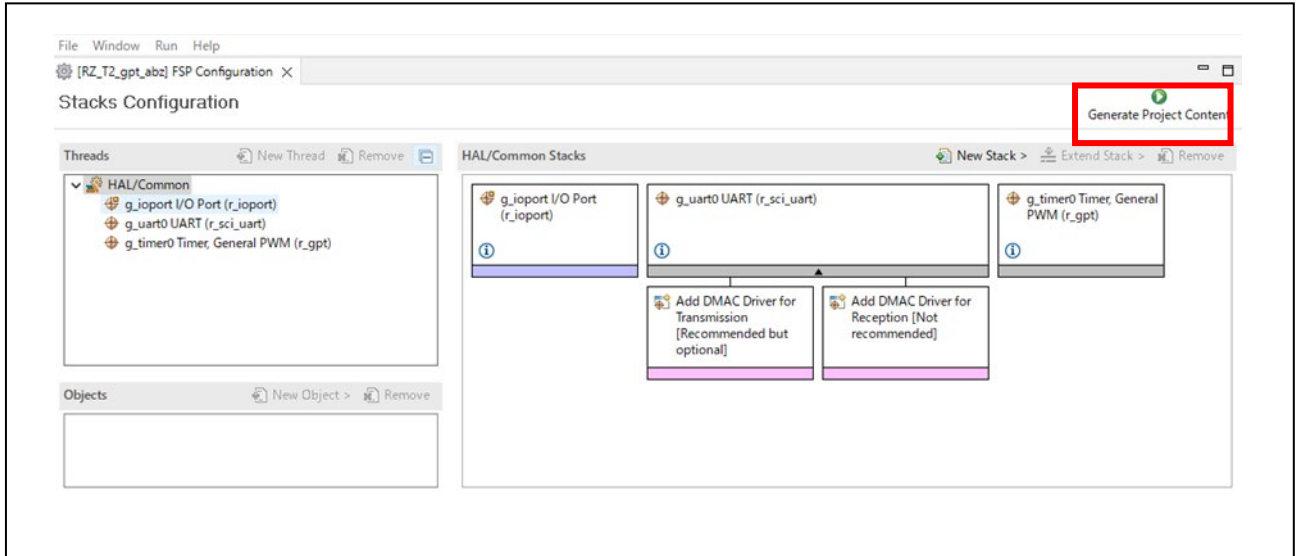

Figure 6-3 Code generator

- Select "Rebuild All" from the "Project" menu to rebuild the project.

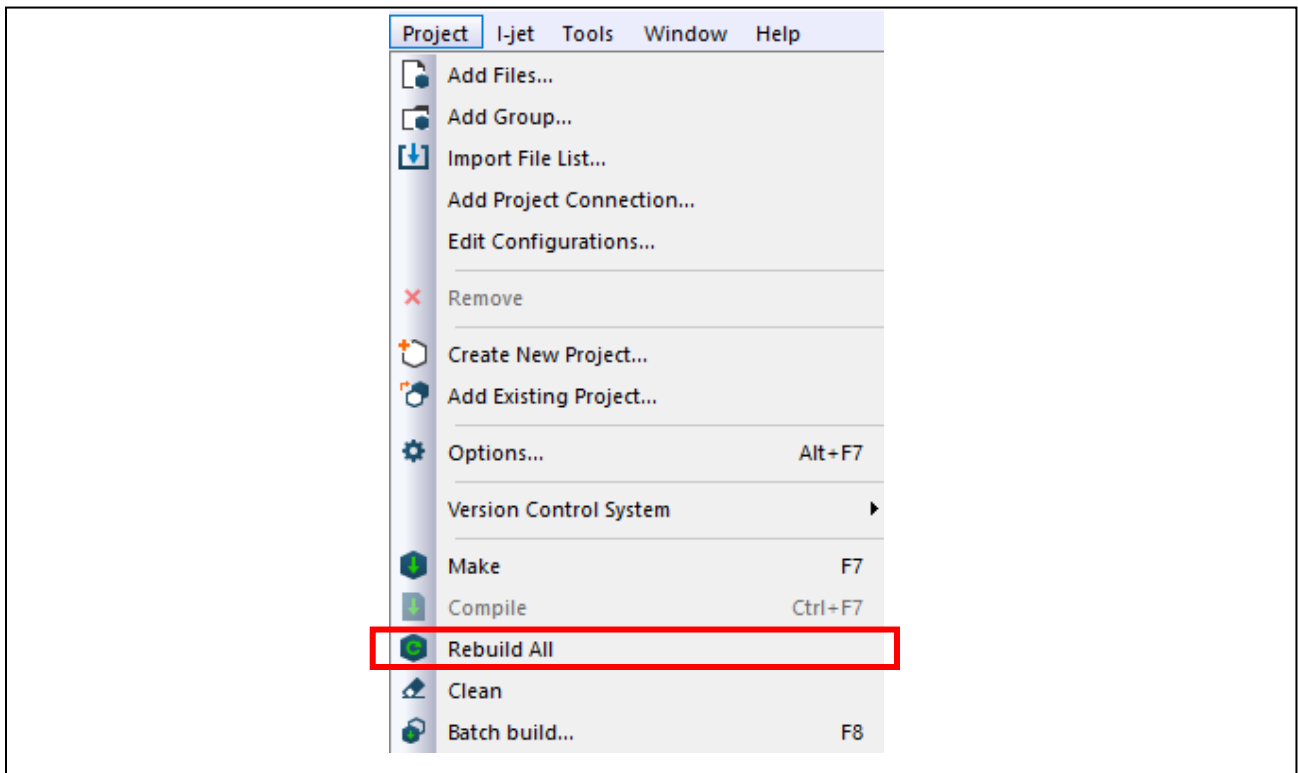

Figure 6-4 Rebuild All

- After connecting the board and I-jet, select "Download and Debug" from the "Project" menu.

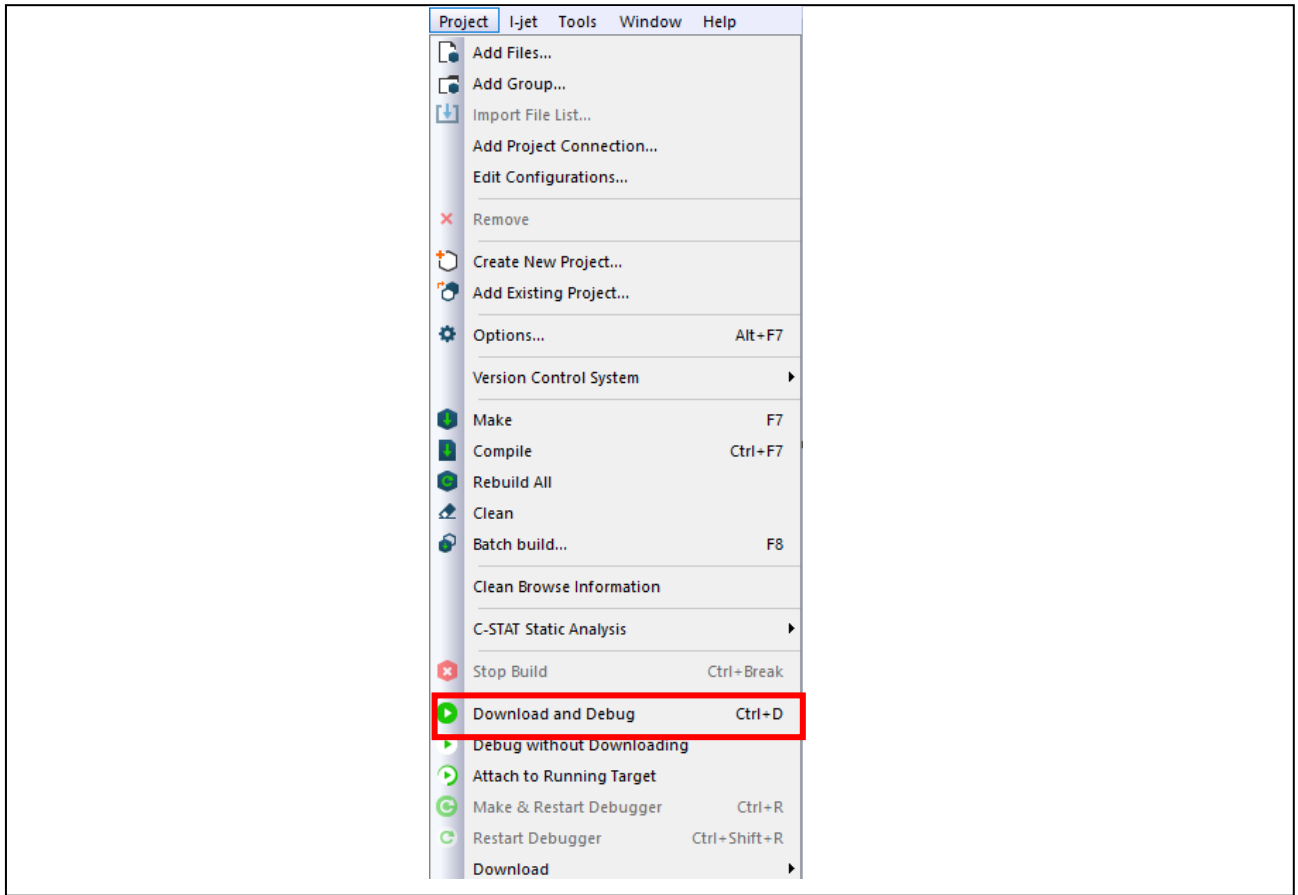

Figure 6-5 Download and Debug

- Select "Go" from the "Debug" menu to run the program.

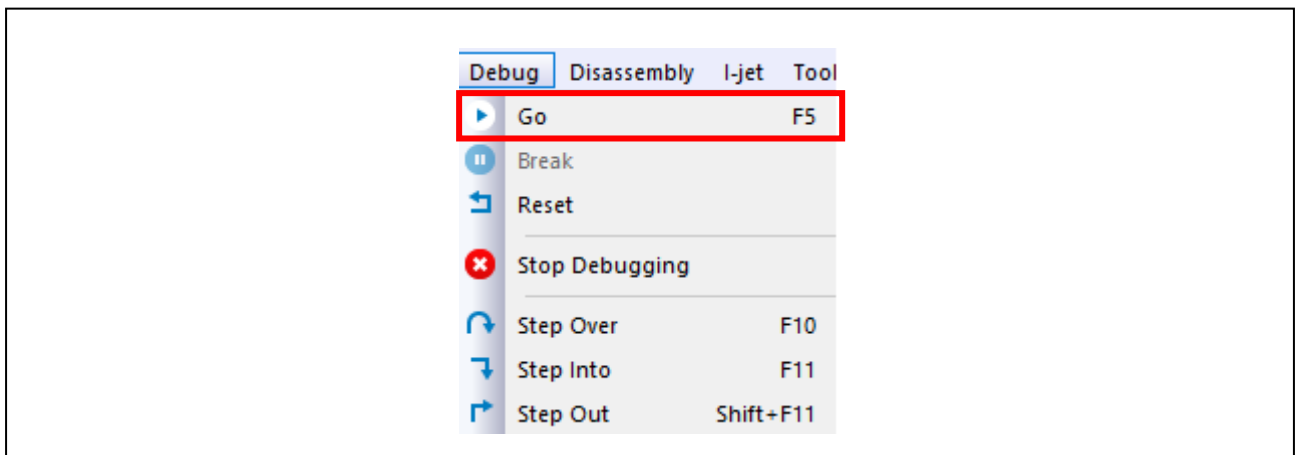

Figure 6-6 Run sample program

## 6.2 How the GCC version works

Build the sample program and load it into RAM using Renesas Electronics e<sup>2</sup>studio.

Note: Please install e<sup>2</sup>studio and apply FSP\_Packs in advance.

1. Import the sample project. After launching e2studio, select [File] → [Import] → [Existing Projects into Workspace]. Check [select archive file], select " RZ\_T2\_mtu3\_abz.zip " compressed folder → select [Finish].



Figure 6-7 Sample program import

2. Open "configuration.xml" of the project.

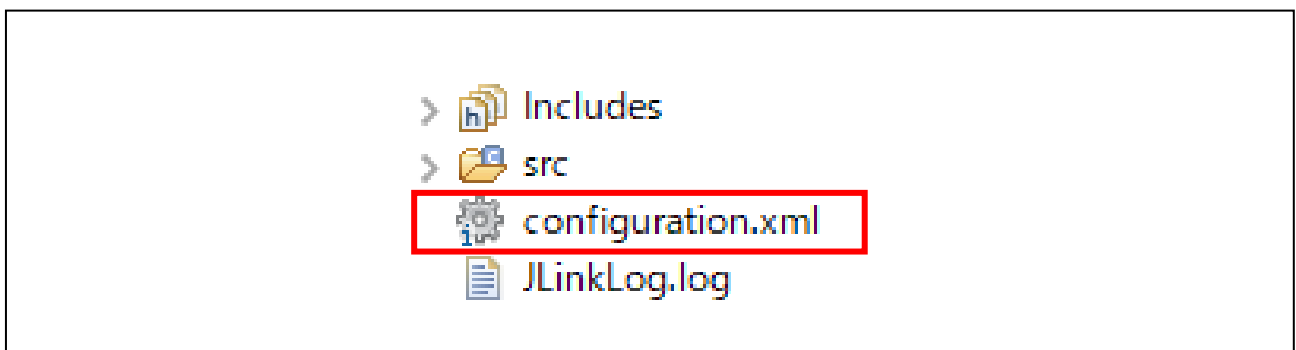

Figure 6-8 Configuration.xml

3. Click "Generate Project Content" to generate the code.

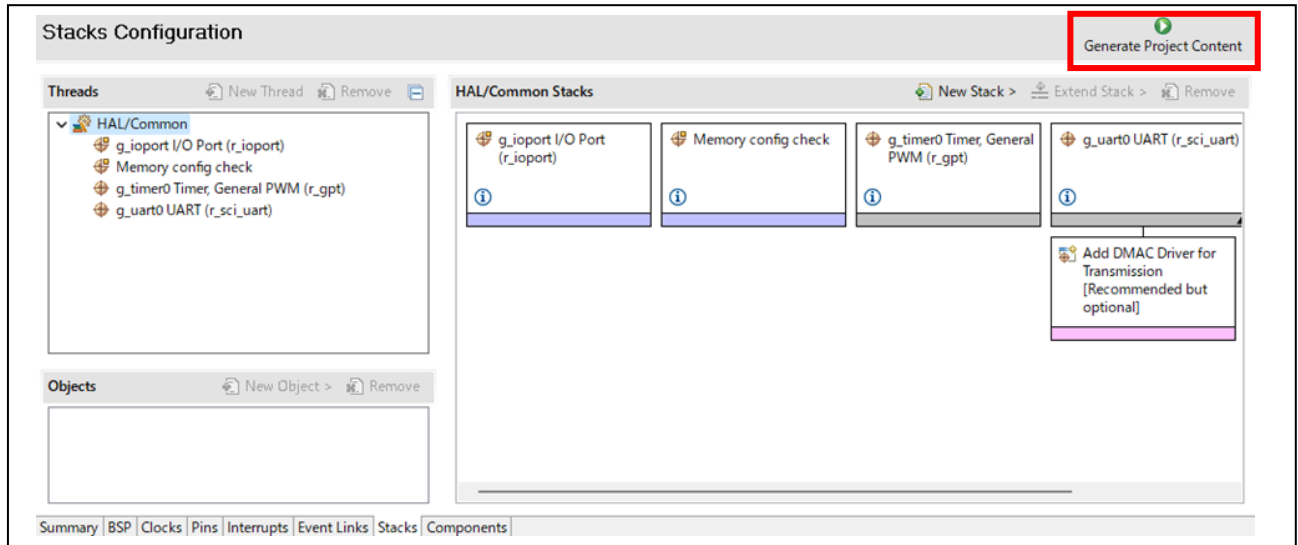

Figure 6-9 Code Generation

4. Select your project and run the build.

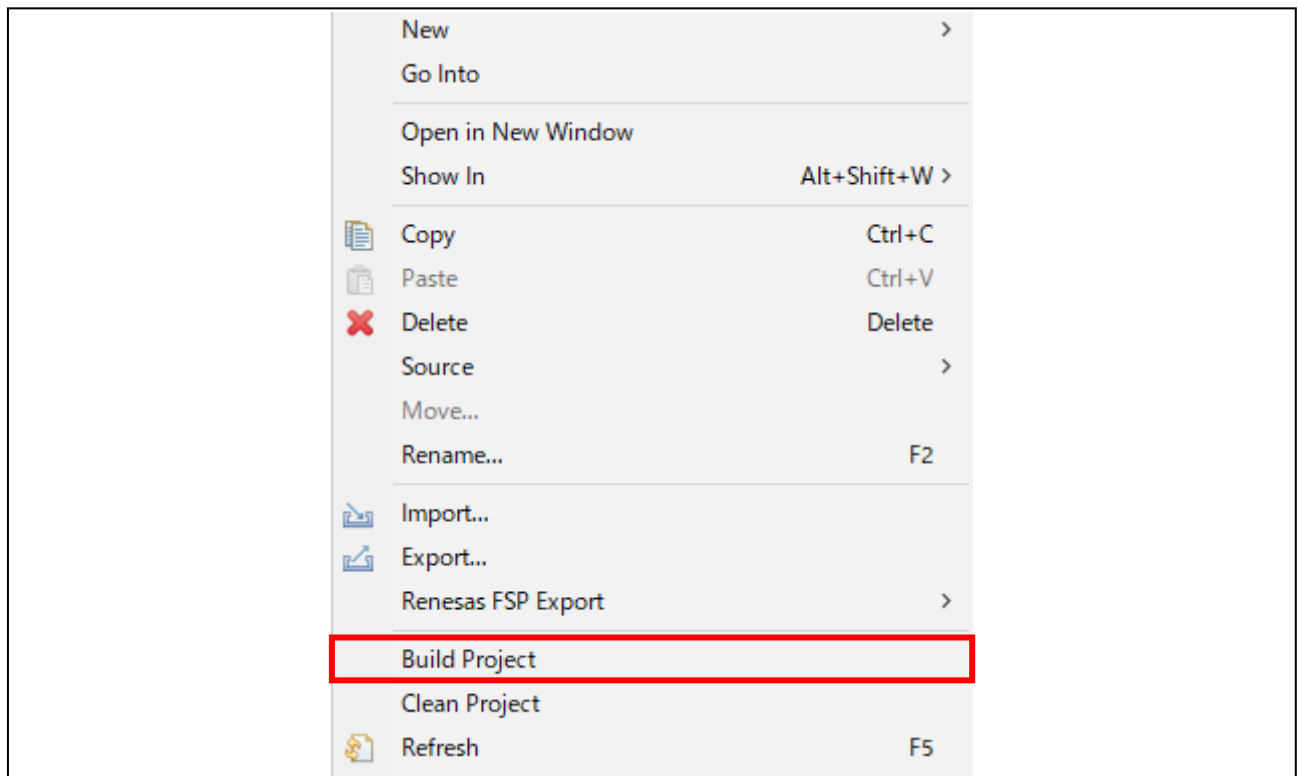

Figure 6-10 Run build

5. After connecting the board and J-Link, start debugging by following the steps below.
  - I. Select "Debug Configurations..." from the "Run" menu.

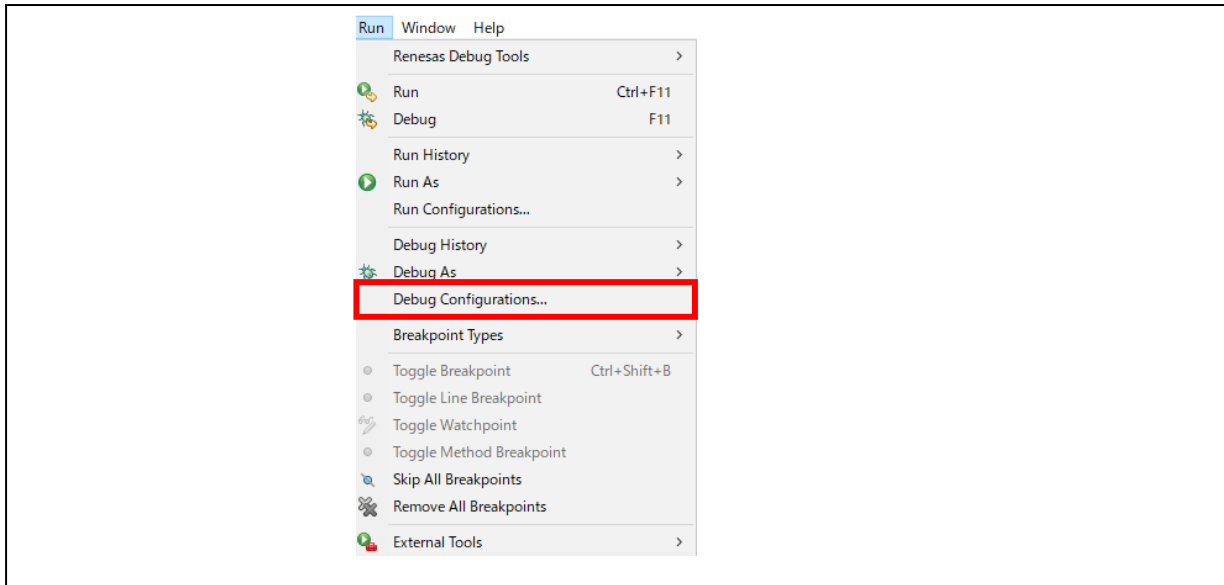

Figure 6-11 Debug Configurations

- II. In the [Renesas DBG Hardware Debugging] → [RZ\_T2\_mtu3\_abz.elf] item, press [Debug].

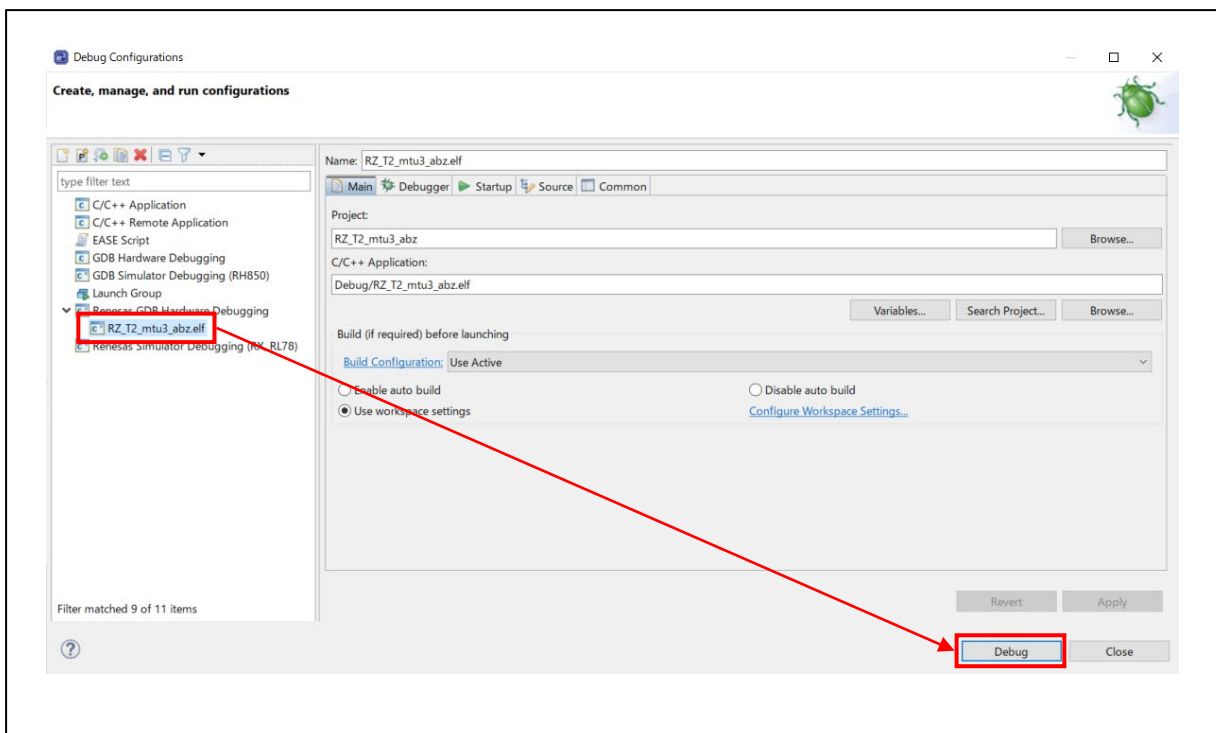
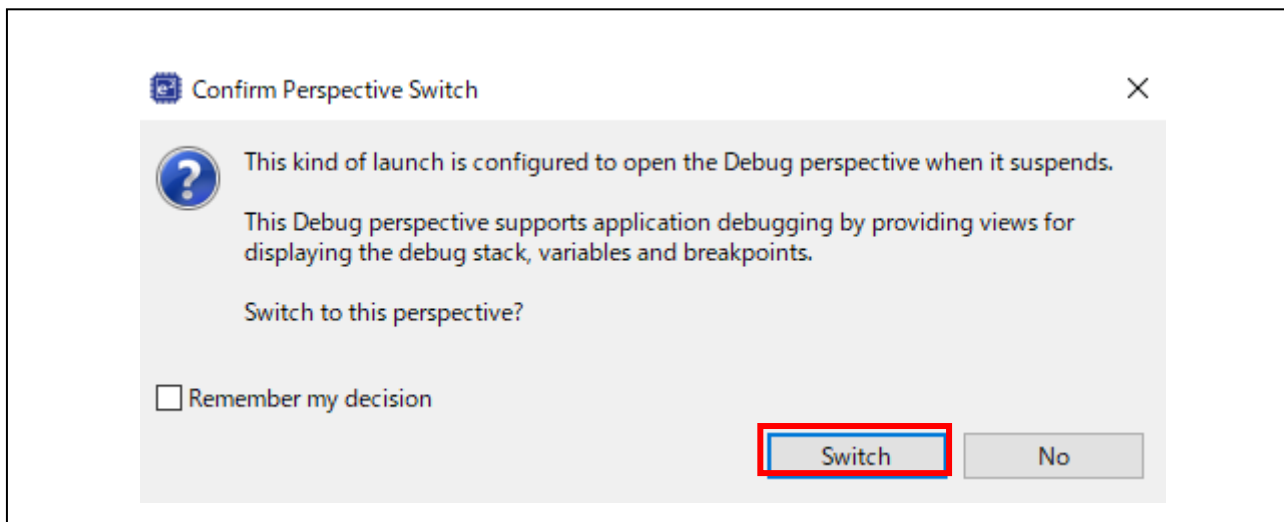

Figure 6-12 Run debug

III. The following dialog will be displayed. Please switch to the debug screen.



**Figure 6-13 Switch debug screen**

6. Debugging starts when you press the "Resume" button, and the program is interrupted at "hal\_entry();" in main.c. Press the "Resume" button again to run the program.

### 6.3 How the sample application works

This sample program will communicate with a PC, so the preparations for its execution will be explained.

1. Start the terminal software on the host PC and set the serial port as follows.  
(When using COM3 with Tera Term)

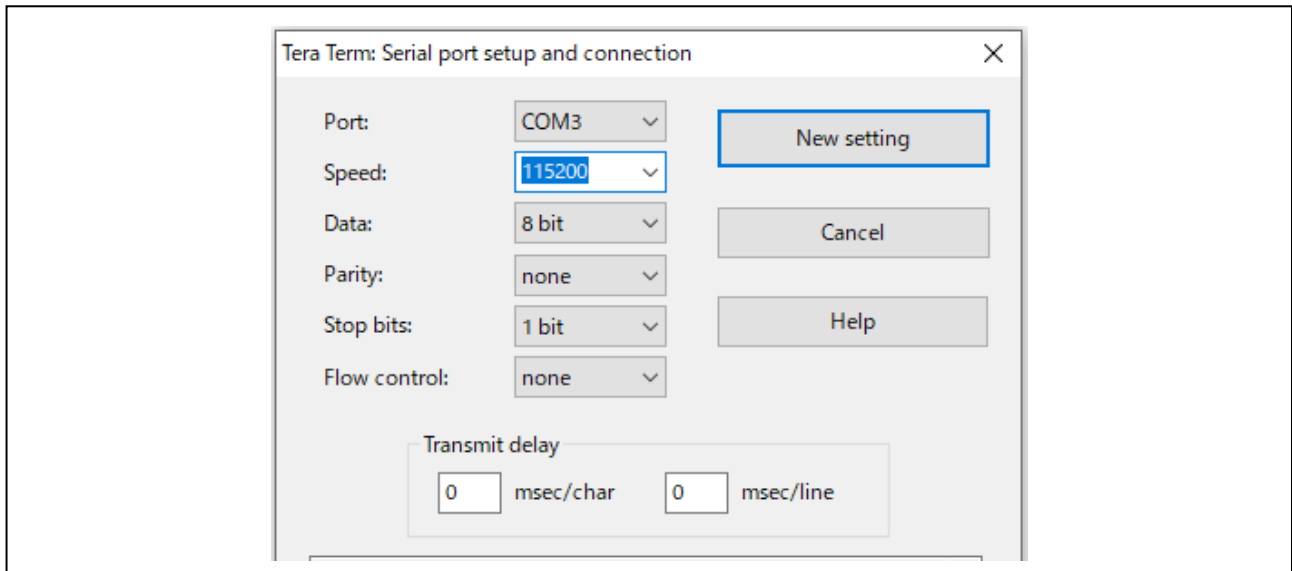

Figure 6-14 Serial port settings

#### 6.3.1 Operation

When the sample program is executed and communication becomes possible, the sample program menu will be displayed on the terminal software.

Note: Enter commands in lower case only

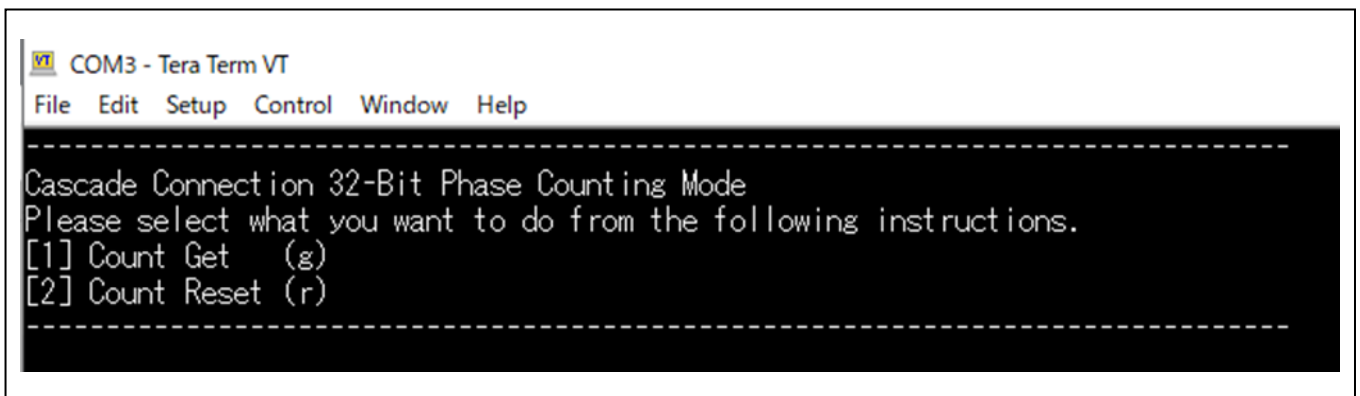
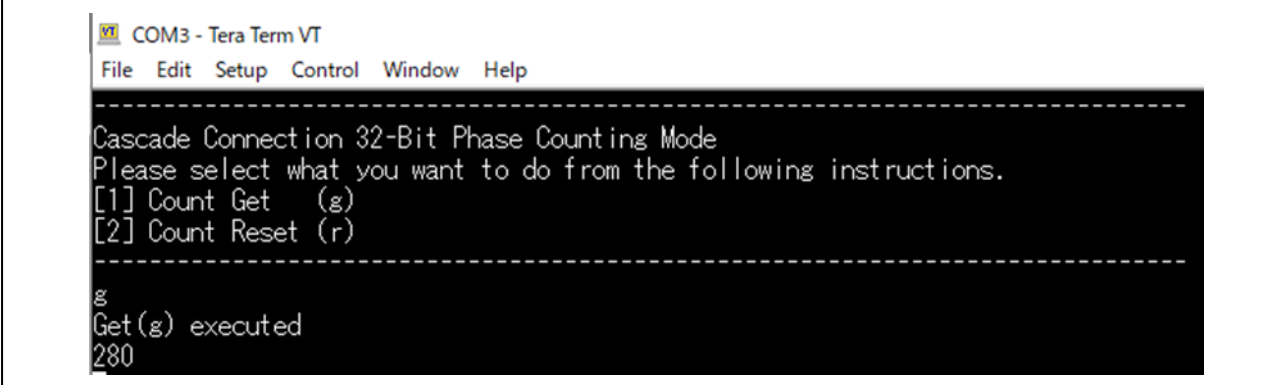

Figure 6-15 Display of terminal software after running the sample program

### 6.3.1.1 Count Get operation

In the state of **Figure 6-15** input "g" and press Enter to read the MTU3 counter value.  
(When the pulse of phase Z is acquired, the count value is set to 0.)



```
COM3 - Tera Term VT
File Edit Setup Control Window Help
-----
Cascade Connection 32-Bit Phase Counting Mode
Please select what you want to do from the following instructions.
[1] Count Get (g)
[2] Count Reset (r)
-----
g
Get (g) executed
280
```

Figure 6-16 Count Get mode input example

### 6.3.1.2 Count Reset operation

In the state of **Figure 6-15** input "r" and press Enter to clear the MTU3 counter value.

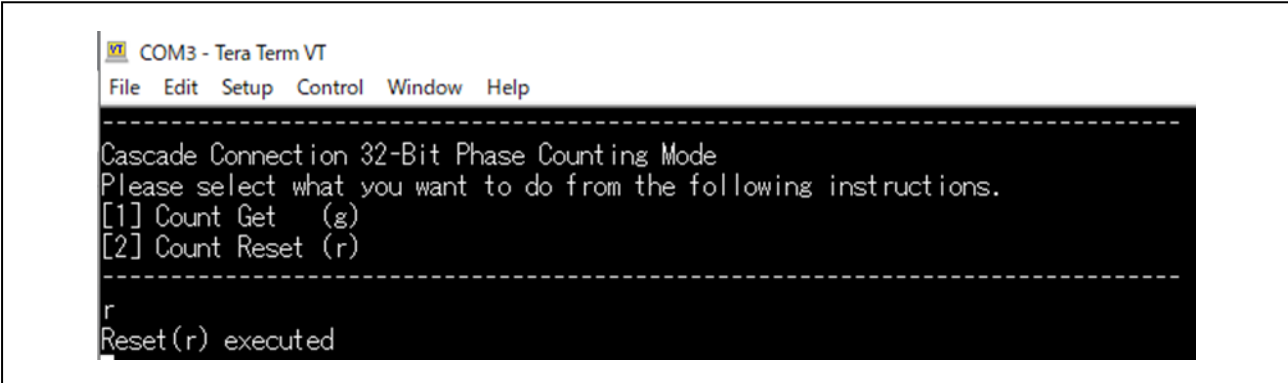

```
COM3 - Tera Term VT
File Edit Setup Control Window Help
-----
Cascade Connection 32-Bit Phase Counting Mode
Please select what you want to do from the following instructions.
[1] Count Get (g)
[2] Count Reset (r)
-----
r
Reset (r) executed
```

Figure 6-17 Count Reset mode input example

### 7. About phase counting mode

The operation of each mode of the phase counting mode is shown below.

#### 7.1 Phase counting mode 1

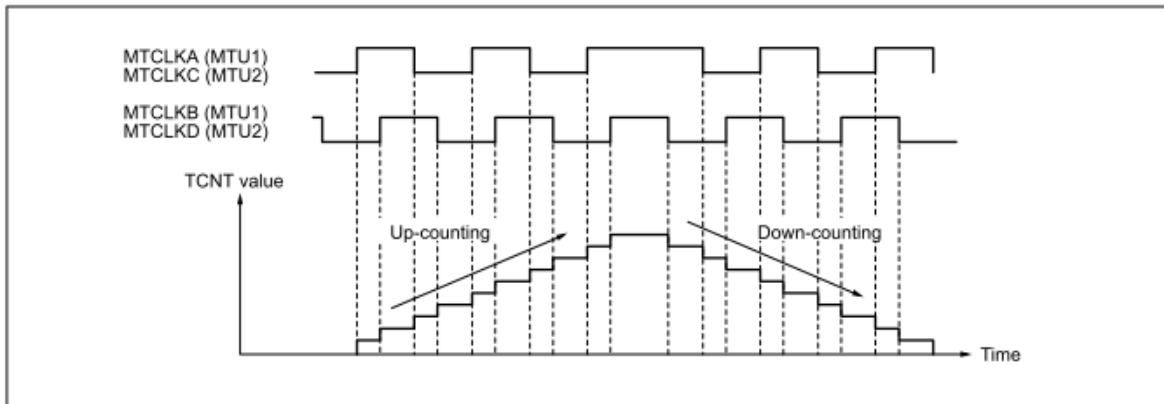

Figure 17.31 Example of operation in phase counting mode 1

Table 17.62 Up-counting and down-counting conditions in phase counting mode 1

⬆ : Rising edge  
 ⬇ : Falling edge

MTCLKA (MTU1) MTCLKC (MTU2)	MTCLKB (MTU1) MTCLKD (MTU2)	Operation
High	⬆	Up-counting
Low	⬇	
⬆	Low	
⬇	High	
High	⬇	Down-counting
Low	⬆	
⬆	High	
⬇	Low	

Figure 7-1 Phase count mode 1

### 7.2 Cascade Connection 32-Bit Phase Counting Mode

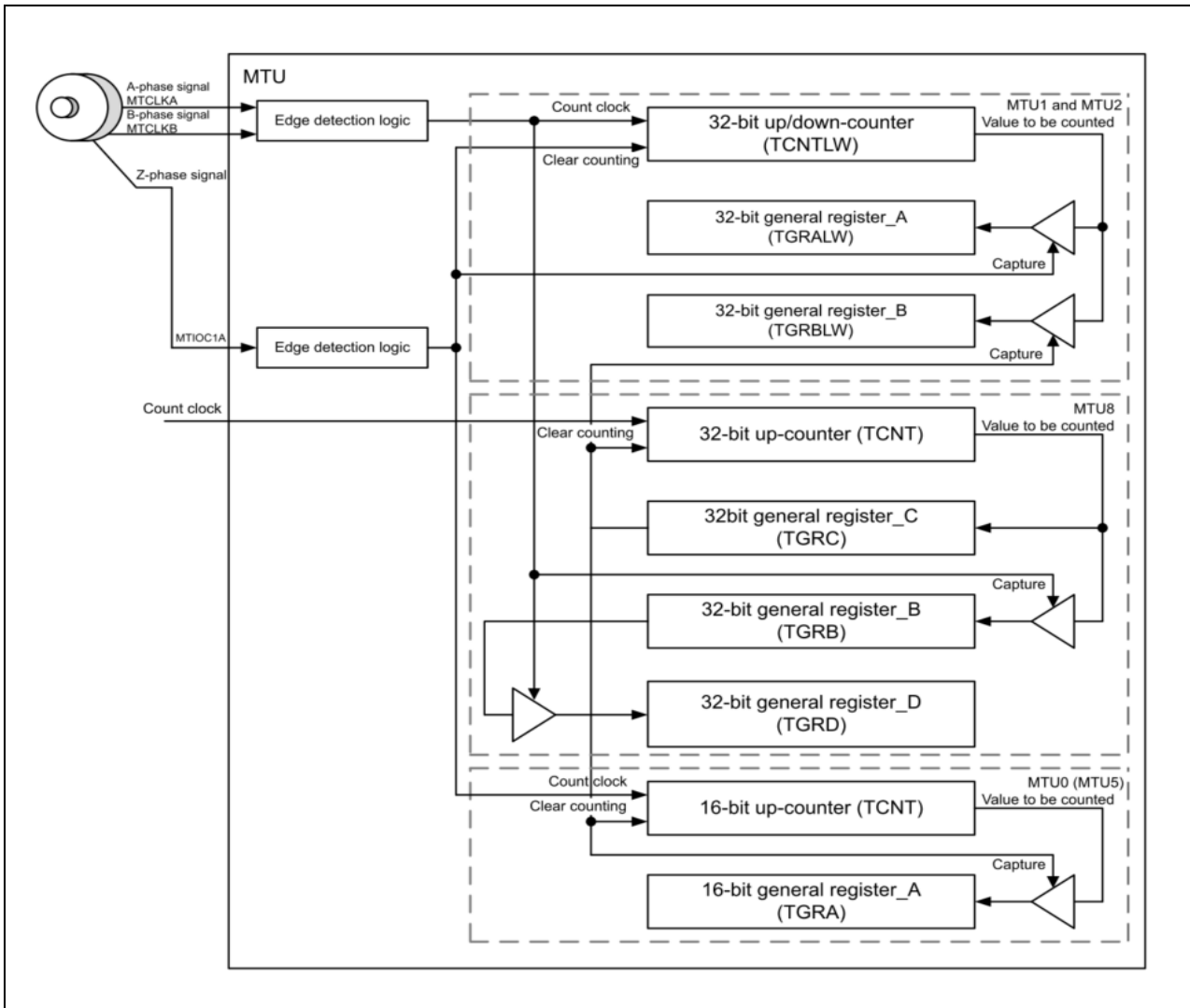

Figure 7-2 Cascade Connection 32-Bit Phase Counting Mode

**Revision History**

Rev.	Date	Description	
		Page	Summary
1.00	Mar.14,2024	-	First edition issued
1.10	Jun.26.2024	P.6	Update 2.Operating Environment chapter
		P.12	Change 5.3.2 Main function chapter
		P.15	Changed the chapter title from MTU3 Phase Count Module Functions to MTU3 Module Functions
		P.17	Update Figure 6.3
		P.20	Update Figure 6.9

## General Precautions in the Handling of Microprocessing Unit and Microcontroller Unit Products

The following usage notes are applicable to all Microprocessing unit and Microcontroller unit products from Renesas. For detailed usage notes on the products covered by this document, refer to the relevant sections of the document as well as any technical updates that have been issued for the products.

### 1. Precaution against Electrostatic Discharge (ESD)

A strong electrical field, when exposed to a CMOS device, can cause destruction of the gate oxide and ultimately degrade the device operation. Steps must be taken to stop the generation of static electricity as much as possible, and quickly dissipate it when it occurs. Environmental control must be adequate. When it is dry, a humidifier should be used. This is recommended to avoid using insulators that can easily build up static electricity. Semiconductor devices must be stored and transported in an anti-static container, static shielding bag or conductive material. All test and measurement tools including work benches and floors must be grounded. The operator must also be grounded using a wrist strap. Semiconductor devices must not be touched with bare hands. Similar precautions must be taken for printed circuit boards with mounted semiconductor devices.

### 2. Processing at power-on

The state of the product is undefined at the time when power is supplied. The states of internal circuits in the LSI are indeterminate and the states of register settings and pins are undefined at the time when power is supplied. In a finished product where the reset signal is applied to the external reset pin, the states of pins are not guaranteed from the time when power is supplied until the reset process is completed. In a similar way, the states of pins in a product that is reset by an on-chip power-on reset function are not guaranteed from the time when power is supplied until the power reaches the level at which resetting is specified.

### 3. Input of signal during power-off state

Do not input signals or an I/O pull-up power supply while the device is powered off. The current injection that results from input of such a signal or I/O pull-up power supply may cause malfunction and the abnormal current that passes in the device at this time may cause degradation of internal elements. Follow the guideline for input signal during power-off state as described in your product documentation.

### 4. Handling of unused pins

Handle unused pins in accordance with the directions given under handling of unused pins in the manual. The input pins of CMOS products are generally in the high-impedance state. In operation with an unused pin in the open-circuit state, extra electromagnetic noise is induced in the vicinity of the LSI, an associated shoot-through current flows internally, and malfunctions occur due to the false recognition of the pin state as an input signal become possible.

### 5. Clock signals

After applying a reset, only release the reset line after the operating clock signal becomes stable. When switching the clock signal during program execution, wait until the target clock signal is stabilized. When the clock signal is generated with an external resonator or from an external oscillator during a reset, ensure that the reset line is only released after full stabilization of the clock signal. Additionally, when switching to a clock signal produced with an external resonator or by an external oscillator while program execution is in progress, wait until the target clock signal is stable.

### 6. Voltage application waveform at input pin

Waveform distortion due to input noise or a reflected wave may cause malfunction. If the input of the CMOS device stays in the area between  $V_{IL}$  (Max.) and  $V_{IH}$  (Min.) due to noise, for example, the device may malfunction. Take care to prevent chattering noise from entering the device when the input level is fixed, and also in the transition period when the input level passes through the area between  $V_{IL}$  (Max.) and  $V_{IH}$  (Min.).

### 7. Prohibition of access to reserved addresses

Access to reserved addresses is prohibited. The reserved addresses are provided for possible future expansion of functions. Do not access these addresses as the correct operation of the LSI is not guaranteed.

### 8. Differences between products

Before changing from one product to another, for example to a product with a different part number, confirm that the change will not lead to problems. The characteristics of a microprocessing unit or microcontroller unit products in the same group but having a different part number might differ in terms of internal memory capacity, layout pattern, and other factors, which can affect the ranges of electrical characteristics, such as characteristic values, operating margins, immunity to noise, and amount of radiated noise. When changing to a product with a different part number, implement a system-evaluation test for the given product.

• Arm® and Cortex® are registered trademarks of Arm Limited (or its subsidiaries) in the EU and/or elsewhere. All rights reserved.

• Ethernet is a registered trademark of Fuji Xerox Co. Ltd.

• IEEE is a registered trademark of the Institute of Electrical and Electronics Engineers Inc

• Additionally all product names and service names in this document are a trademark or a registered trademark which belongs to the respective owners. a trademark or a registered trademark which belongs to the respective owners.

## Notice

1. Descriptions of circuits, software and other related information in this document are provided only to illustrate the operation of semiconductor products and application examples. You are fully responsible for the incorporation or any other use of the circuits, software, and information in the design of your product or system. Renesas Electronics disclaims any and all liability for any losses and damages incurred by you or third parties arising from the use of these circuits, software, or information.
2. Renesas Electronics hereby expressly disclaims any warranties against and liability for infringement or any other claims involving patents, copyrights, or other intellectual property rights of third parties, by or arising from the use of Renesas Electronics products or technical information described in this document, including but not limited to, the product data, drawings, charts, programs, algorithms, and application examples.
3. No license, express, implied or otherwise, is granted hereby under any patents, copyrights or other intellectual property rights of Renesas Electronics or others.
4. You shall be responsible for determining what licenses are required from any third parties, and obtaining such licenses for the lawful import, export, manufacture, sales, utilization, distribution or other disposal of any products incorporating Renesas Electronics products, if required.
5. You shall not alter, modify, copy, or reverse engineer any Renesas Electronics product, whether in whole or in part. Renesas Electronics disclaims any and all liability for any losses or damages incurred by you or third parties arising from such alteration, modification, copying or reverse engineering.
6. Renesas Electronics products are classified according to the following two quality grades: "Standard" and "High Quality". The intended applications for each Renesas Electronics product depends on the product's quality grade, as indicated below.

"Standard": Computers; office equipment; communications equipment; test and measurement equipment; audio and visual equipment; home electronic appliances; machine tools; personal electronic equipment; industrial robots; etc.

"High Quality": Transportation equipment (automobiles, trains, ships, etc.); traffic control (traffic lights); large-scale communication equipment; key financial terminal systems; safety control equipment; etc.

Unless expressly designated as a high reliability product or a product for harsh environments in a Renesas Electronics data sheet or other Renesas Electronics document, Renesas Electronics products are not intended or authorized for use in products or systems that may pose a direct threat to human life or bodily injury (artificial life support devices or systems; surgical implantations; etc.), or may cause serious property damage (space system; undersea repeaters; nuclear power control systems; aircraft control systems; key plant systems; military equipment; etc.). Renesas Electronics disclaims any and all liability for any damages or losses incurred by you or any third parties arising from the use of any Renesas Electronics product that is inconsistent with any Renesas Electronics data sheet, user's manual or other Renesas Electronics document.
7. No semiconductor product is absolutely secure. Notwithstanding any security measures or features that may be implemented in Renesas Electronics hardware or software products, Renesas Electronics shall have absolutely no liability arising out of any vulnerability or security breach, including but not limited to any unauthorized access to or use of a Renesas Electronics product or a system that uses a Renesas Electronics product. RENESAS ELECTRONICS DOES NOT WARRANT OR GUARANTEE THAT RENESAS ELECTRONICS PRODUCTS, OR ANY SYSTEMS CREATED USING RENESAS ELECTRONICS PRODUCTS WILL BE INVULNERABLE OR FREE FROM CORRUPTION, ATTACK, VIRUSES, INTERFERENCE, HACKING, DATA LOSS OR THEFT, OR OTHER SECURITY INTRUSION ("Vulnerability Issues"). RENESAS ELECTRONICS DISCLAIMS ANY AND ALL RESPONSIBILITY OR LIABILITY ARISING FROM OR RELATED TO ANY VULNERABILITY ISSUES. FURTHERMORE, TO THE EXTENT PERMITTED BY APPLICABLE LAW, RENESAS ELECTRONICS DISCLAIMS ANY AND ALL WARRANTIES, EXPRESS OR IMPLIED, WITH RESPECT TO THIS DOCUMENT AND ANY RELATED OR ACCOMPANYING SOFTWARE OR HARDWARE, INCLUDING BUT NOT LIMITED TO THE IMPLIED WARRANTIES OF MERCHANTABILITY, OR FITNESS FOR A PARTICULAR PURPOSE.
8. When using Renesas Electronics products, refer to the latest product information (data sheets, user's manuals, application notes, "General Notes for Handling and Using Semiconductor Devices" in the reliability handbook, etc.), and ensure that usage conditions are within the ranges specified by Renesas Electronics with respect to maximum ratings, operating power supply voltage range, heat dissipation characteristics, installation, etc. Renesas Electronics disclaims any and all liability for any malfunctions, failure or accident arising out of the use of Renesas Electronics products outside of such specified ranges.
9. Although Renesas Electronics endeavors to improve the quality and reliability of Renesas Electronics products, semiconductor products have specific characteristics, such as the occurrence of failure at a certain rate and malfunctions under certain use conditions. Unless designated as a high reliability product or a product for harsh environments in a Renesas Electronics data sheet or other Renesas Electronics document, Renesas Electronics products are not subject to radiation resistance design. You are responsible for implementing safety measures to guard against the possibility of bodily injury, injury or damage caused by fire, and/or danger to the public in the event of a failure or malfunction of Renesas Electronics products, such as safety design for hardware and software, including but not limited to redundancy, fire control and malfunction prevention, appropriate treatment for aging degradation or any other appropriate measures. Because the evaluation of microcomputer software alone is very difficult and impractical, you are responsible for evaluating the safety of the final products or systems manufactured by you.
10. Please contact a Renesas Electronics sales office for details as to environmental matters such as the environmental compatibility of each Renesas Electronics product. You are responsible for carefully and sufficiently investigating applicable laws and regulations that regulate the inclusion or use of controlled substances, including without limitation, the EU RoHS Directive, and using Renesas Electronics products in compliance with all these applicable laws and regulations. Renesas Electronics disclaims any and all liability for damages or losses occurring as a result of your noncompliance with applicable laws and regulations.
11. Renesas Electronics products and technologies shall not be used for or incorporated into any products or systems whose manufacture, use, or sale is prohibited under any applicable domestic or foreign laws or regulations. You shall comply with any applicable export control laws and regulations promulgated and administered by the governments of any countries asserting jurisdiction over the parties or transactions.
12. It is the responsibility of the buyer or distributor of Renesas Electronics products, or any other party who distributes, disposes of, or otherwise sells or transfers the product to a third party, to notify such third party in advance of the contents and conditions set forth in this document.
13. This document shall not be reprinted, reproduced or duplicated in any form, in whole or in part, without prior written consent of Renesas Electronics.
14. Please contact a Renesas Electronics sales office if you have any questions regarding the information contained in this document or Renesas Electronics products.

(Note1) "Renesas Electronics" as used in this document means Renesas Electronics Corporation and also includes its directly or indirectly controlled subsidiaries.

(Note2) "Renesas Electronics product(s)" means any product developed or manufactured by or for Renesas Electronics.

(Rev.5.0-1 October 2020)

## Corporate Headquarters

TOYOSU FORESIA, 3-2-24 Toyosu,  
Koto-ku, Tokyo 135-0061, Japan  
[www.renesas.com](http://www.renesas.com)

## Trademarks

Renesas and the Renesas logo are trademarks of Renesas Electronics Corporation. All trademarks and registered trademarks are the property of their respective owners.

## Contact information

For further information on a product, technology, the most up-to-date version of a document, or your nearest sales office, please visit:  
[www.renesas.com/contact/](http://www.renesas.com/contact/)