

RZ/N2H Group

Quick Start Guide: Modbus TCP Gateway Software

Introduction

This document is a quick start guide for evaluating Modbus communication with the RZ microcomputer evaluation board.

Modbus protocol is a communication protocol developed by Modicon Inc. (Schneider Electric SA.) for programmable logic controllers (PLCs), and its specifications are open to the public.

For details, refer to the protocol specifications (PI-MBUS-300 Rev.J).

Target Device

RZ/N2H

Contents

1. Overview	3
1.1 Abbreviations / Definitions	3
1.2 Reference	3
2. Features	3
3. Project Setup	4
3.1 Requirements	4
3.2 Hardware	5
3.3 Setting the Board	10
3.3.1 Debug connection	10
3.3.2 Serial board connection	11
4. Setup a Client tool	13
5. Running the sample application	14
5.1 Setup sample project for e ² studio	14
5.1.1 Dual core project startup procedure (CR52_0, CR52_1), (CR52_0, CA55_2)	15
5.2 Setup sample project for EWARM	22
5.2.1 Dual core project startup procedure (CR52_0, CR52_1), (CR52_0, CA55_2)	23
5.3 Demonstration	29
5.3.1 Simple demonstration	29
5.3.2 Standard demonstration	30
6. Appendix	31
6.1 Appendix A. Setting the baud rate	31
6.2 Appendix B. Application Programming Interface	32
7. Limitations	41

Revision History42

1. Overview

This document describes the Modbus protocol stack that runs on the RZ/N2H board, and provides a functional overview, application programming interface (API), and application samples for developing and implementing protocol stack applications using the multiple cores, Cortex®-R52 and Cortex®-A55.

This package supports the RS-485 based Modbus TCP and Modbus RTU/ASCII protocol.

1.1 Abbreviations / Definitions

Table 1 Abbreviations/Definitions

Index	Abbreviations /Definitions	Description
1	IP	Internet Protocol
2	TCP	Transmission Control Protocol
3	USB	Universal Serial Bus
4	PC	Personal Computer
5	SW	Switch
6	EWARM	Embedded Workbench® for ARM
7	LED	Light Emitting Diode

1.2 Reference

Technical information about RZ/N2H is available via Renesas.

Table 1-2 Technical Inputs for RZ/N2H

Index	Technical Inputs
1	r01uh1039ejxxxx-rzt2h-rzn2h.pdf
2	r01an6434ejxxxx-rzt2-rzn2-fsp-getting-started.pdf
3	r01ds0426ejxxxx-rzt2h-rzn2h.pdf
4	r20ut5522ejxxxx-rzn2hevb.pdf
5	Modicon Modbus Protocol Reference Guide Rev.J
6	Modbus Application Protocol Specification V1.1b3

2. Features

- The Modbus protocol stack for RZ/N2H allows for quick and easy development of the Modbus RTU/ASCII applications. The following nine codes can be implemented in this stack.
 - (0x01) - Read coils
 - (0x02) - Read discrete input
 - (0x03) - Read holding registers
 - (0x04) - Read input registers
 - (0x05) - Write single coil
 - (0x06) - Write single register
 - (0x0F) - Write multiple coils
 - (0x10) - Write multiple registers
 - (0x17) - Read/Write multiple registers

For more information about Modbus, refer to the following site:

<http://www.modbus.org>

Note), The version number may differ depending on the update. Refer to the latest manual.

3. Project Setup

3.1 Requirements

This RZ/N2H Modbus protocol stack project has been developed and tested on these environments using the following boards and tools.

Table 3 RZ/N2H Requirements

Item	Description
Board	Renesas Electronics RZ/N2H Evaluation Board
IDE	IAR Systems - IAR Embedded Workbench® for ARM Version 9.60.3 - patch (EWARM_Patch_for_RZT2H_N2H_rev1.0) Renesas Electronics - e² studio 2025-12 GCC toolchain GNU ARM Embedded Toolchain (version 13.3.1.arm-13-24 for CR52) GNU ARM A-Profile (AArch64 bare-metal) (version 13.2.1.20231009 for CA55) - FSP Smart Configurator 2025-12
Emulator	IAR Systems I-jet SEGGER J-Link 8.60
Client demo tool	Renesas Electronics ModbusDemoApplication.exe (Included in this package)

3.2 Hardware

This document describes the major hardware. Refer to Renesas Starter Kit+ for RZ/N2H user’s manual and schematic for more board details.

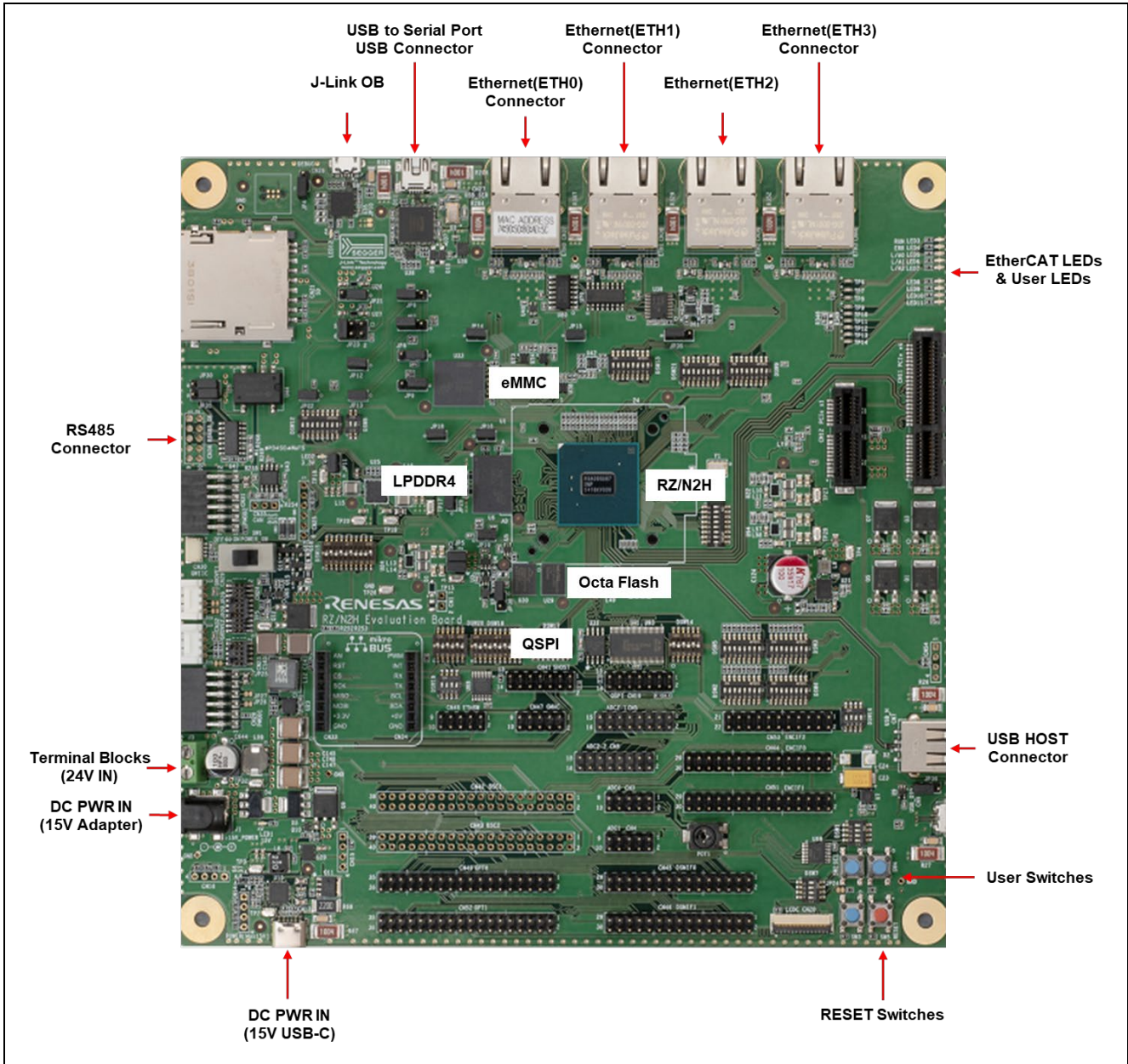

Figure 3.1 RZ/N2H EVALUATION board layout.

Table 3-1 Jumper Pin settings (Power Selection)

Reference	Jumper Position	Description
JP6	Short 1-2	1.8-V power is supplied to VCC1833_0. (for Ethernet Port 0)
	Short 2-3	3.3-V power is supplied to VCC1833_0. (for Ethernet Port 0)
JP7	Short 1-2	1.8-V power is supplied to VCC1833_1. (for Ethernet Port 1)
	Short 2-3	3.3-V power is supplied to VCC1833_1. (for Ethernet Port 1)
JP8	Short 1-2	1.8-V power is supplied to VCC1833_1. (for Ethernet Port 2)
	Short 2-3	3.3-V power is supplied to VCC1833_1. (for Ethernet Port 2)
JP9	Short 1-2	1.8-V power is supplied to VCC1833_1. (for Ethernet Port 3)
	Short 2-3	3.3-V power is supplied to VCC1833_1. (for Ethernet Port 3)
JP21	Short 1-2	3.3-V power is supplied to VCC1833_7. (for SD1)
	Short 2-3	Power control IC output for SD1 is supplied to VCC1833_7. (for SD1)
JP23	Short 1-2	3.3-V power is supplied to VCC1833_6. (for SD0)
	Short 2-3	The output from the power-supply control IC for SD0 is supplied to VCC1833_6 (for SD0).
	Short 5-6	1.8-V power is supplied to VCC1833_6. (for SD0)
JP35	Short 1-2	VCC1833_0 is supplied to VCC_ETH2_MDIO (DSW5-6 is ON: When P21_4 and P21_5 are selected for MDIO).
	Short 2-3	VCC1833_2 is supplied to VCC_ETH2_MDIO. (DSW5-6 is OFF: When P30_5 and P30_6 are selected for MDIO)

Table 3-2 Jumper Pin settings (Debugging Function)

Reference	Jumper Position	Description
JP40	Open - circuit	The on-board debugging function J-Link® OB is enabled.
	Short-circuit	The on-board debugging function J-Link™ OB is disabled. Connect an external emulator to CN23 or CN24 at debugging.

Table 3-3 Jumper Pin settings (RS485 Interface Communication)

Reference	Jumper Position	Description
JP30	1-2 are short-circuit	Full-duplex communication
JP31	2-3 are short-circuit	Half-duplex communication

Table 3-4 Switch3 settings

SW3	Setting	Description
SW3-1	ON	RAM Boot mode
SW3-2	OFF	* Substitute using “xSPI1 boot mode”
SW3-3	ON	
SW3-4	OFF	The number of ATCM wait cycles of CPU0 in the Cortex-R52 is 1 wait cycle.
SW3-5	OFF	The number of ATCM wait cycles of CPU1 in the Cortex-R52 is 1 wait cycle.
SW3-6	OFF	The power-supply voltage of the boot peripheral is 3.3 V.
SW3-7	ON	JTAG mode = Normal mode
SW3-8	OFF	(At the time of shipment = OFF)

Table 3-5 Switch2 settings

SW2	Setting	Description
SW2-1	ON	XTALSEL = 'L' Select oscillator for RZ/N2H clock input.
SW2-2	OFF	(At the time of shipment = OFF)
SW2-3	ON	P27_2, P27_3, P27_6, and P31_3 are used as inputs to user DIP switches.
SW2-4	OFF	P13_4, P13_5, and P14_0 are used as RXD3, TXD3, and DE3 of the RS485.
SW2-5	ON	P00_0 to P00_2 are used as control signals for the USB power-supply IC. In this case, set DSW14-1, DSW14-3, and DSW14-5 to ON and DSW14-2, DSW14-4, and DSW14-6 to OFF.
SW2-6	ON	P01_0, P01_2, P01_4 to P01_7, and P02_0 to P02_3 are used as XSPI1 signals.
SW2-7	OFF	(At the time of shipment = OFF)
SW2-8	OFF	(At the time of shipment = OFF)

Table 3-6 Switch5 settings

SW5	Setting	Description
SW5-1	ON	P12_0 to 7, P13_0 to 2 are connected to eMMC.
SW5-2	ON	
SW5-3	ON	P08_6 and P17_4 are used as SD1 control signal.
SW5-4	OFF	(At the time of shipment = OFF)
SW5-5	OFF	(At the time of shipment = OFF)
SW5-6	ON	MDC and MDIO of Ethernet port 2 are connected to GMAC0 (P21_4 and P21_5).
SW5-7	ON	P29_1 to P29_7, P30_0 to P30_4, P30_7, P31_2, P31_4, and P31_5 are used as control signals for Ethernet Port 2.
SW5-8	ON	P00_0 to P00_2, P33_2 to P33_7, and P34_0 to P34_6 are used as control signals for Ethernet Port 3.

Table 3-7 Switch8 settings

SW8	Setting	Description
SW8-1	ON	P03_1_GMAC_RESETOUT2# is used as RESET for Ethernet Port 2.
SW8-2	OFF	

Table 3-9 Switch12 settings

SW12	Setting	Description
SW12-1	OFF	P00_3 is used as P00_3_ETH3_COL of Ethernet Port 3.
SW12-2	ON	
SW12-3	OFF	P11_0 is used as P11_0_ESC_RESETOUT# of Ethernet Port 0 and 1.
SW12-4	ON	
SW12-5	OFF	P03_2 is used as P03_2_GMAC_RESETOUT3# of Ethernet Port 3.
SW12-6	ON	
SW12-7	OFF	P03_1 is used as P03_1_GMAC_RESETOUT2# of Ethernet Port 2.
SW12-8	ON	In this case, set DSW8-1 to ON and DSW8-2 to OFF.

Table 3-10 Switch13 settings

SW13	Setting	Description
SW13-1	ON	P26_7 is used as P26_7_ETH1_RXER of Ethernet Port 1.
SW13-2	OFF	
SW13-3	ON	P27_0 is used as P27_0_ETH1_CRIS of Ethernet Port 1.
SW13-4	OFF	
SW13-5	ON	P27_1 is used as P27_1_ETH1_COL of Ethernet Port 1.
SW13-6	OFF	
SW13-7	OFF	P13_7 is used as MDINT of Ethernet Port 2.
SW13-8	ON	

Table 3-11 Switch15 settings

SW15	Setting	Description
SW15-1	OFF	P22_6 is used as P22_6_SD0_WP.
SW15-2	ON	
SW15-3	OFF	P22_5 is used as P22_5_SD0_CD.
SW15-4	ON	
SW15-5	OFF	P14_7 is used as P14_7_USER_LED1(LED9).
SW15-6	ON	
SW15-7	OFF	- (At the time of shipment = OFF)
SW15-8	OFF	P14_6 is used as P14_6_USER_LED0(LED8).
SW15-9	OFF	
SW15-10	ON	

Table 3-12 Switch17 settings

SW17	Setting	Description
SW17-1	OFF	P03_0 is used as USER_LED3(LED11).
SW17-2	ON	
SW17-3	OFF	P02_7 is used as USER_LED2(LED10).
SW17-4	ON	
SW17-5	OFF	P02_6 is used as P02_6_SD0_IOVS.
SW17-6	ON	
SW17-7	OFF	- (At the time of shipment = OFF)
SW17-8	ON	P02_5 is used as P02_5_SD0_PWEN.

Table 3-13 Switch18 settings

SW18	Setting	Description
SW18-1	ON	P22_7 is used as ESC_LINKACT0(LED5).
SW18-2	OFF	
SW18-3	ON	P23_0 is used as ESC_LINKACT1(LED6).
SW18-4	OFF	
SW18-5	ON	P14_3 is used as ESC_LINKACT2(LED7).
SW18-6	OFF	
SW18-7	ON	P31_6 is used as ESC_LED RUN(LED3).
SW18-8	OFF	
SW18-9	ON	P18_1 is used as ESC_LEDERR(LED4).
SW18-10	OFF	

3.3 Setting the Board

3.3.1 Debug connection

Setting the board for running sample program is shown below.

Build and run the sample code on the RZ/N2H EVALUATION board by following the steps below.

Both loading into RAM and flash can be done using IAR Embedded Workbench or e² studio.

1. Connect the decoder to the header "CN24" on the RZ/N2H evaluation board."

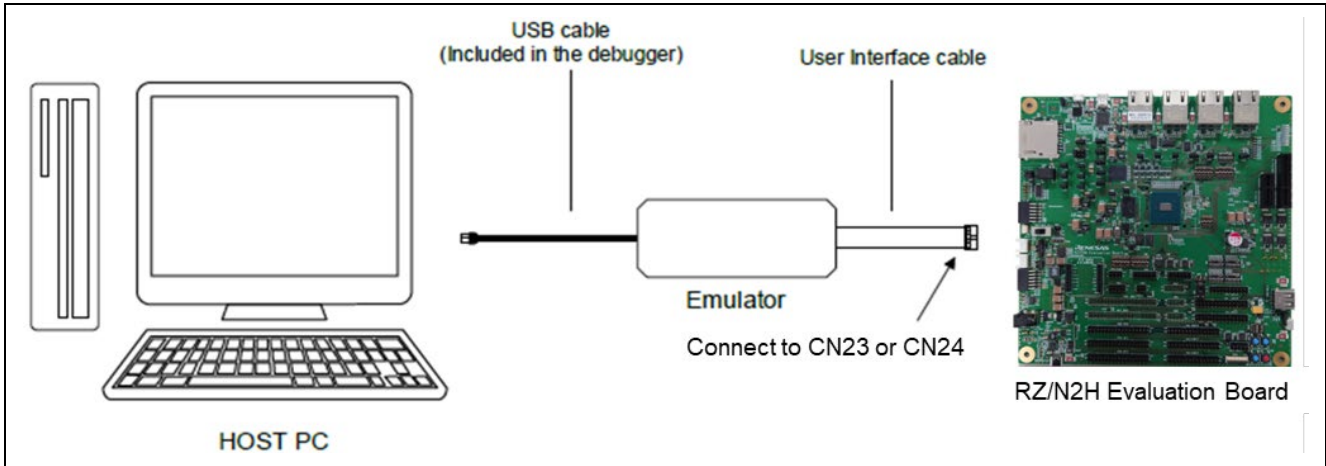

Figure 3.2: RZ/N2H evaluation board debug connection diagram.

When using J-Link OB, connect the USB cable to the header "CN26" and set "JP40" to open.

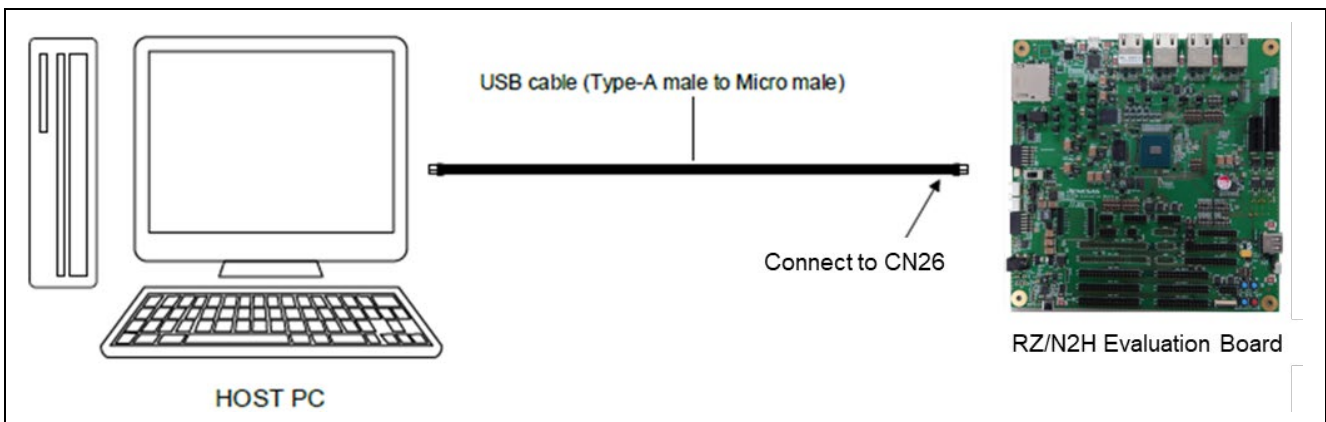

Figure 3.3: RZ/N2H evaluation board debug connection diagram (J-Link OB)

2. When connecting the AC/DC adapter, connect it to the connector "J1" on the RZ/N2H evaluation board.

3.3.2 Serial board connection

Connect the PC to the RZ/N2H board as shown below.

Power is supplied by connecting a USB micro-c cable to the board.

For Modbus serial communication, use RS485 connector and connect to PC with RS-485 cable.

Connect the RS485 A cable to CN36-6, the B cable to CN36-3, and the G cable to CN36-10.

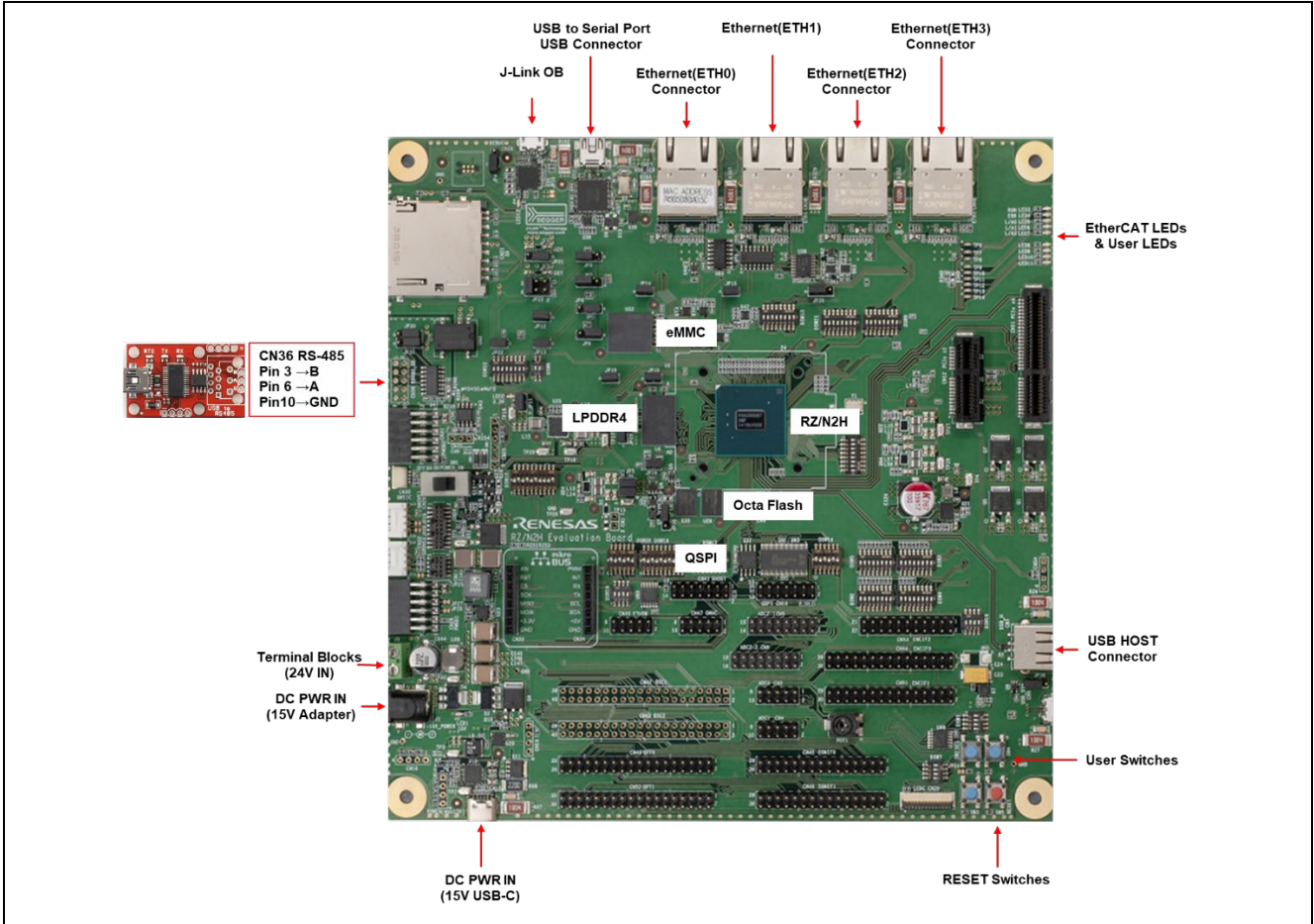

Figure 3.4 RZ/N2H EVALUATION board layout.

This shows a configuration example for connecting to a Modbus RTU/ASCII server device via a gateway device using an application running on a Windows PC and Modbus commands.

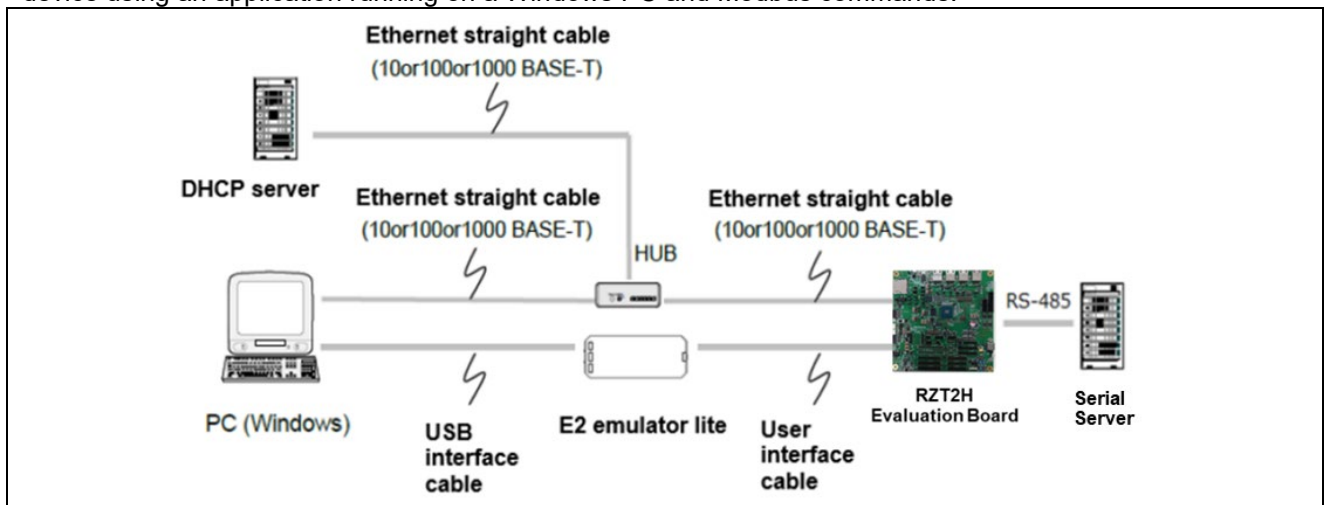

Figure 3.5 Hardware connection example in Modbus TCP serial gateway stack mode.

This is an example of a simple evaluation connection in Modbus TCP serial gateway stack mode. If there is no Serial server, you can connect TCP and Serial to the same PC and run two demo software tools to check.

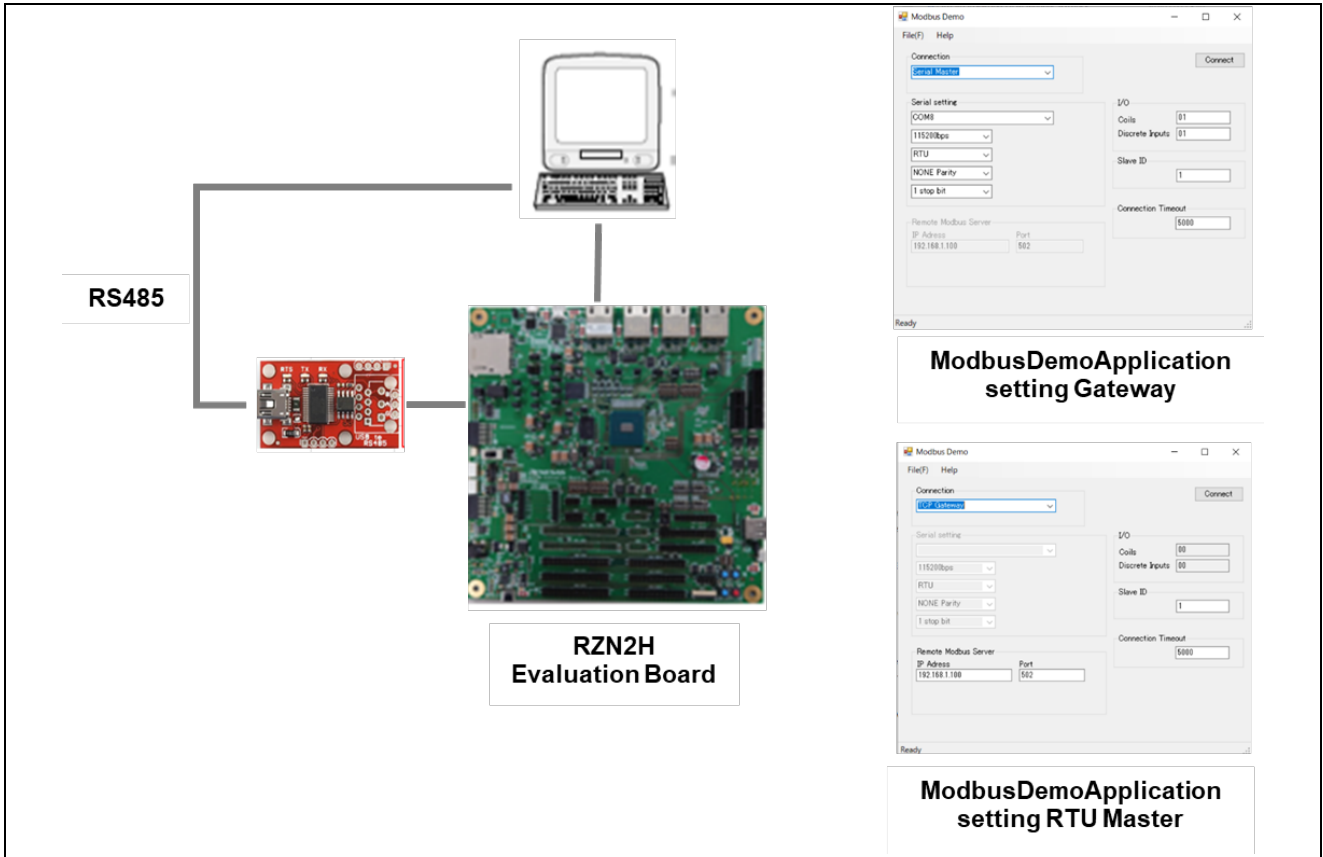

Figure 3.6 Example of a simple evaluation connection in Modbus TCP serial gateway stack mode.

4. Setup a Client tool

1. Open “**ModbusDemoApplication.exe**” which is included in this package.
3. Set the " TCP Gateway" IP Address (e.g., "192.168.1.100") and Port (e.g.,"502").

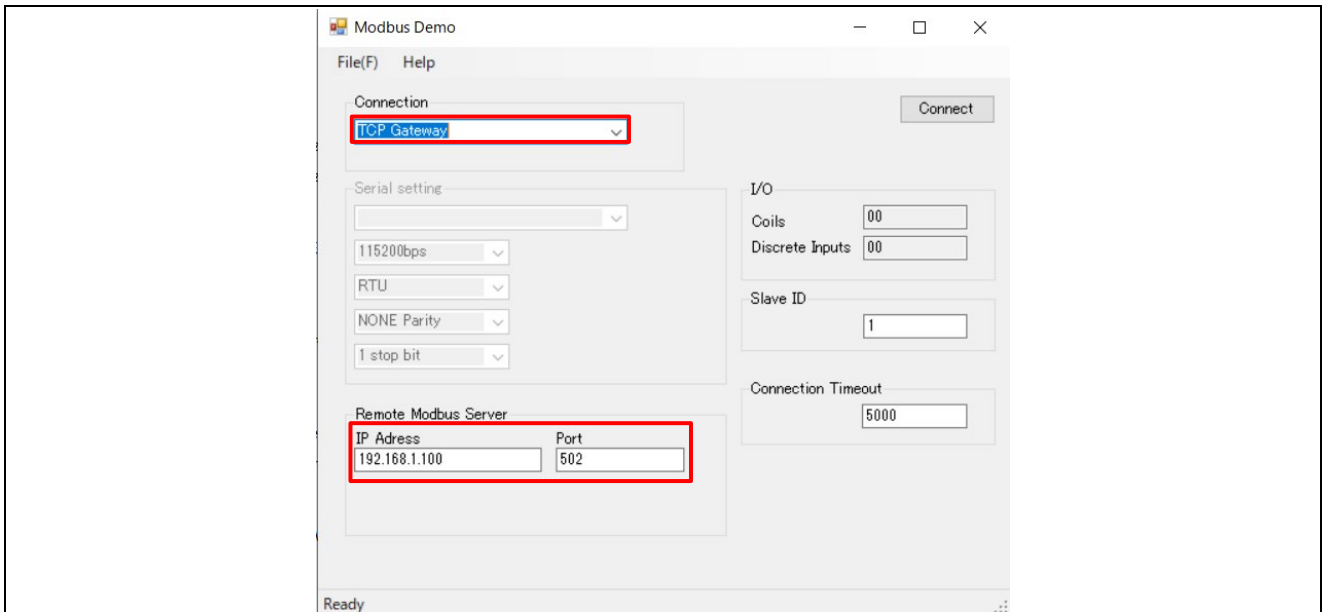

Figure 4.1 ModbusDemoApplication setting for Gateway.

4. “Connection” is selected to Serial Client and set serial Port No (for example, “COM3”), Baud Rate (for example, “115200bps”), Communication mode (for example, “RTU”), Parity (for example, “NONE Parity”), and Stop Bit (for example, “1 stop bit”).

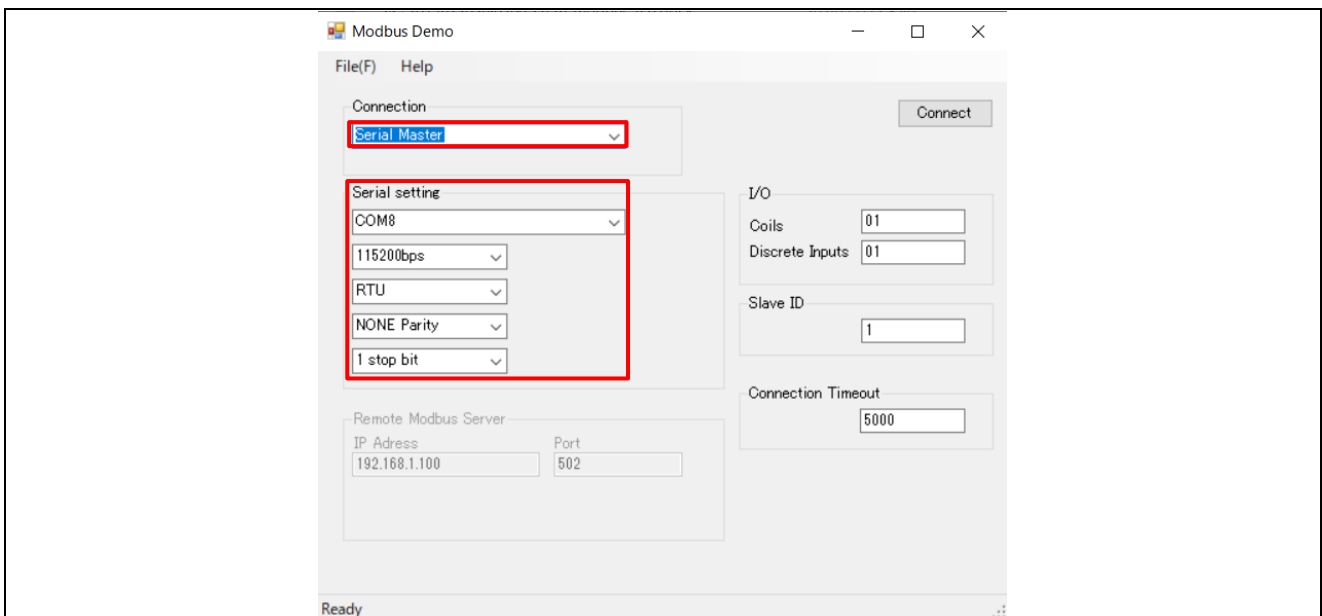

Figure 4.2 Modbus Demo Application setting for RTU Client

5. Running the sample application

Refer to Section 3.3 Setting the Board for board settings.

The setup differs depending on the IDE.

- When using e² studio, refer to section 5.1.
- When using EWARM, refer to section 5.2.

5.1 Setup sample project for e² studio

Build the sample code and load it into RAM using Renesas Electronics e² studio.

Note). Please install e² studio and adapt the RZ_FSP_Packs_v4.0.0 in advance.

Refer to the latest getting started guide. (r01an6434ejxxxx-rzt2-rzn2-fsp-getting-started.pdf)

This package includes the following projects.

Project		CPU
Dual-core project (CR52_dual)	Primary_0	CR52_0
	Secondary_1	CR52_1
Dual-core project (CR52-CA55_dual)	Primary_0	CR52_0
	Secondary_1	CA55_2

5.1.1 Dual core project startup procedure (CR52_0, CR52_1), (CR52_0, CA55_2)

1. Import the sample project. After the program is started, by selecting [File] → [Import] → [Existing Projects into Workspace]. Check the "select root directory" and click "Browse..." button.
→ Select "C:\RZN2H_Modbus_EVB_rev400\Modbus_gateway\project\xxxx_dual" folder. → Check "Primary_0" and "Secondary_1" → [Finish].

Note), **xxxx** is either "CR52" or "CR52-CA55", select one.

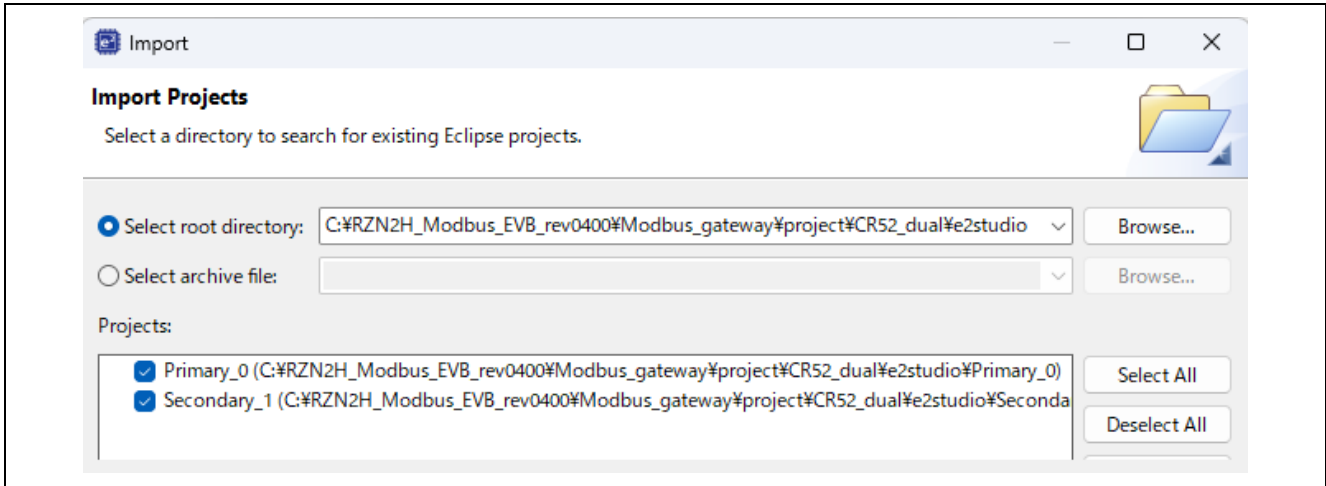

2. Open "configuration.xml" in the "Primary_0" project

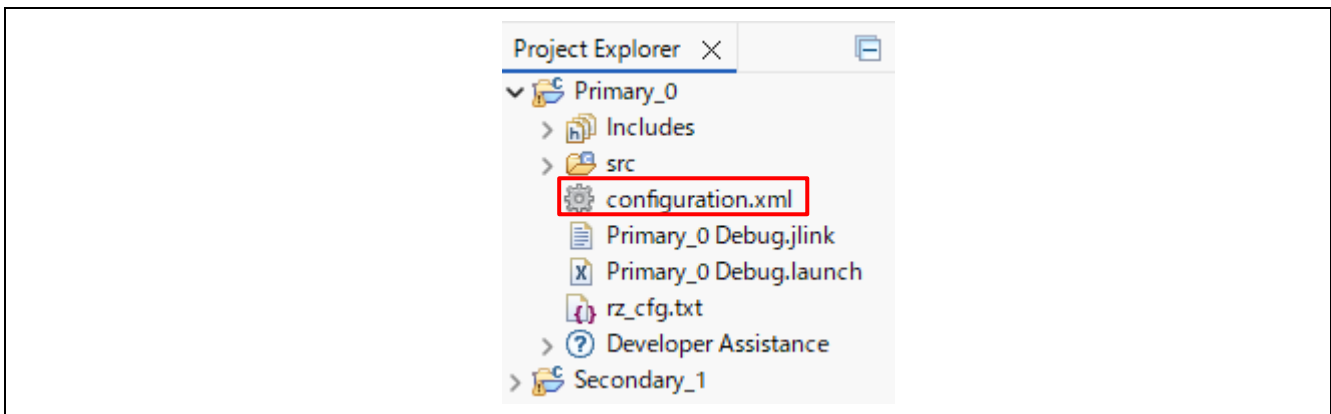

- 3. Confirm the project boot mode. (Following is RAM boot mode.)
Generate the code with "**Generate Project Content**".

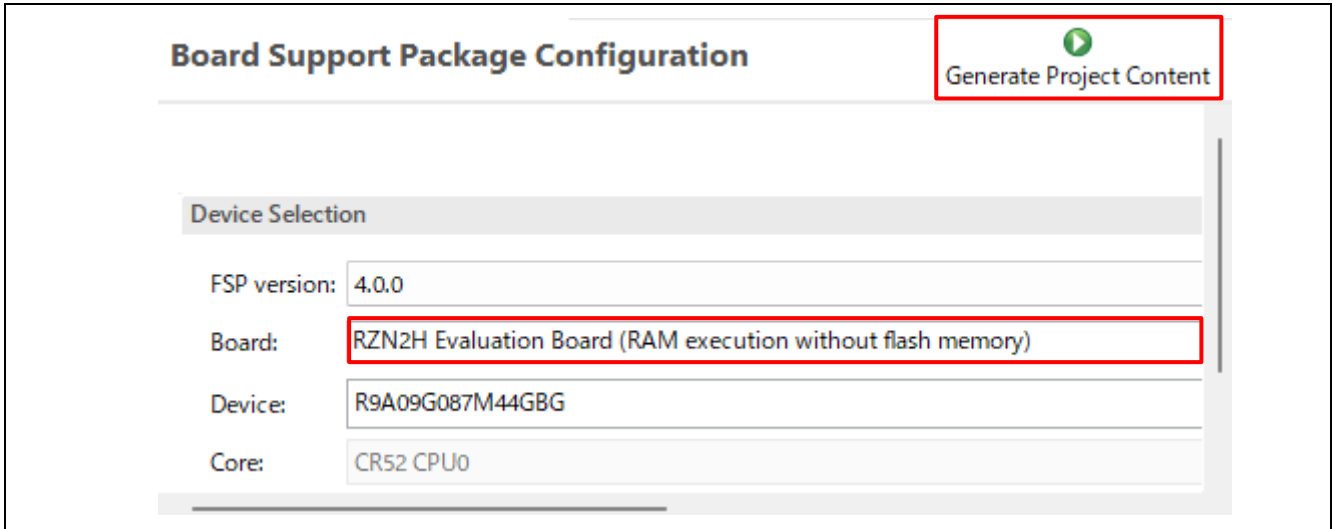

- 4. Select the "**Primary_0**" project and execute the build.

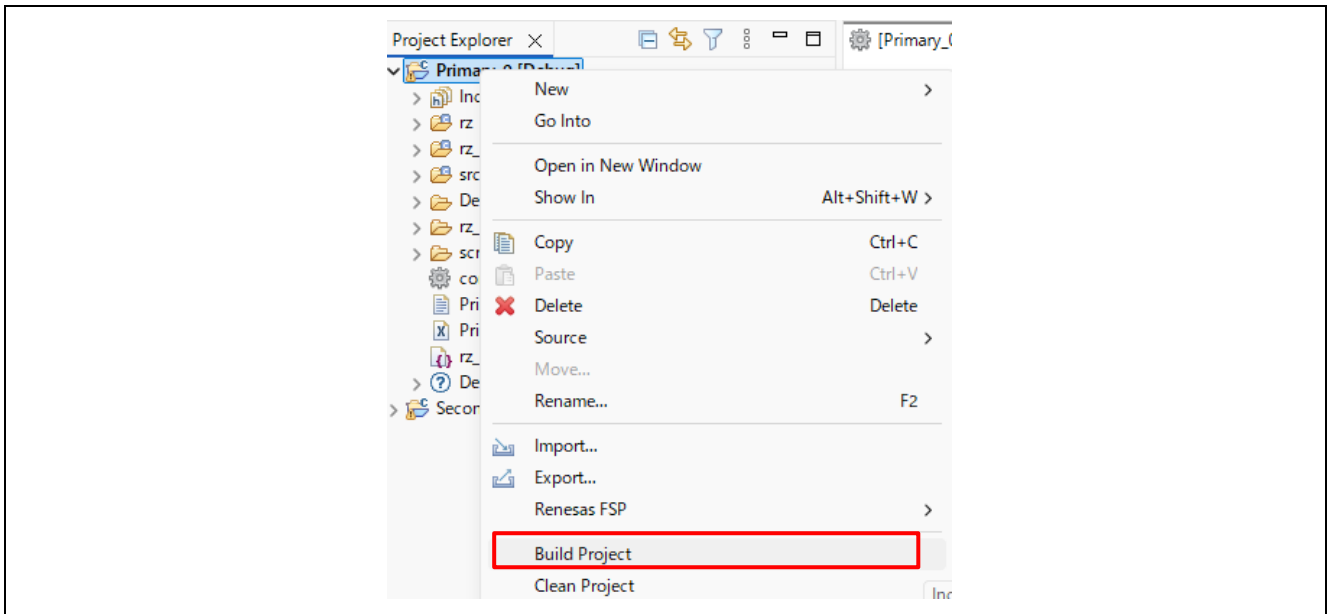

5. Open "configuration.xml" in the "Secondary_1" project

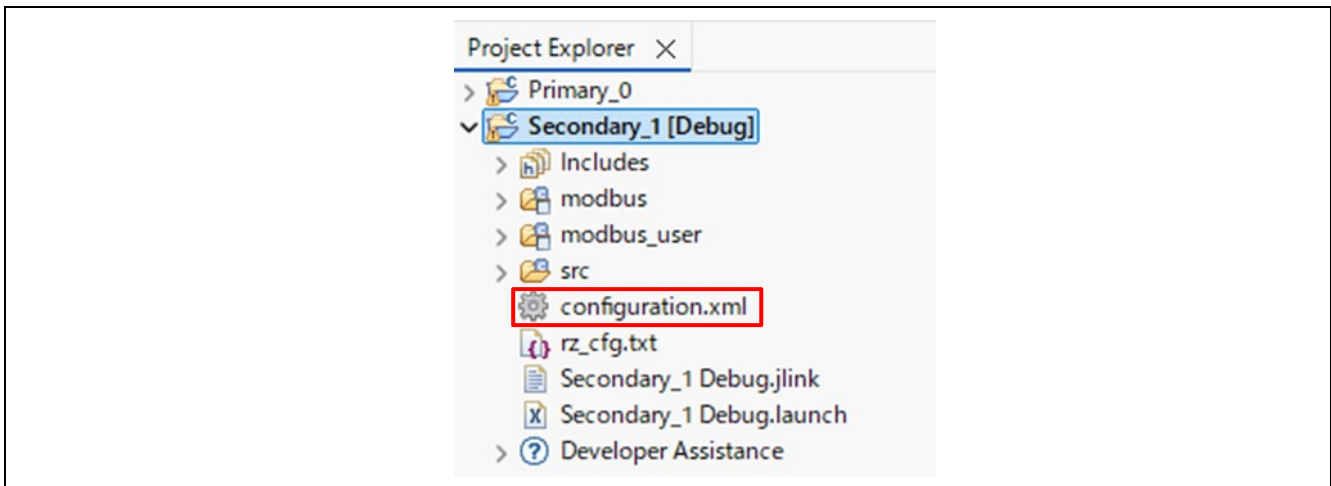

6. Confirm the project boot mode. (Following is RAM boot mode.)
Generate the code with "Generate Project Content".

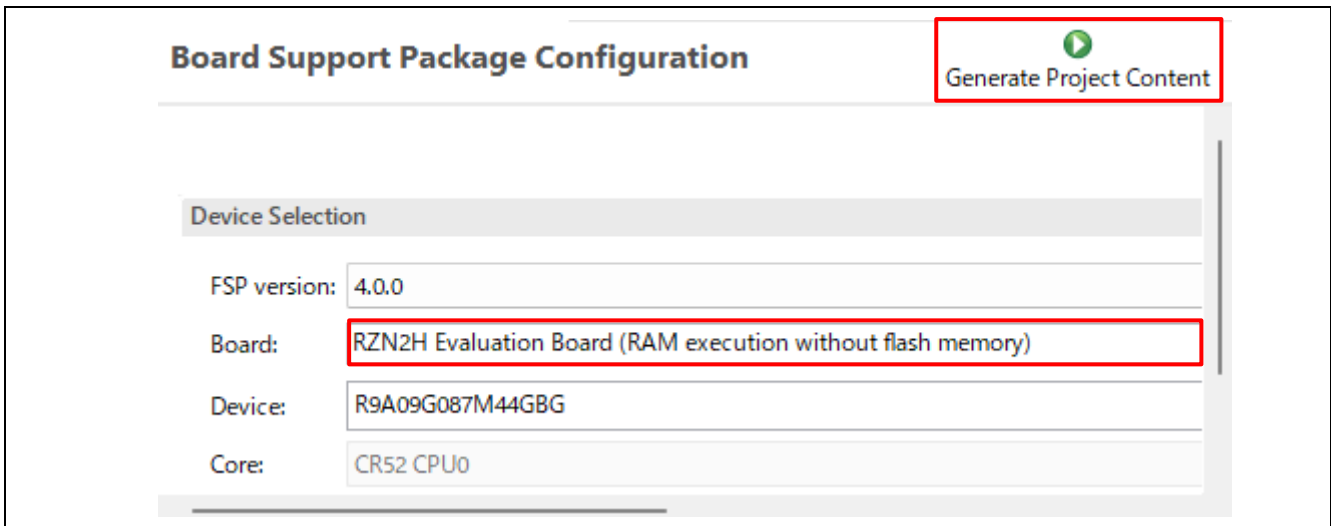

7. Select the “**Secondary_1**” project and execute the build.

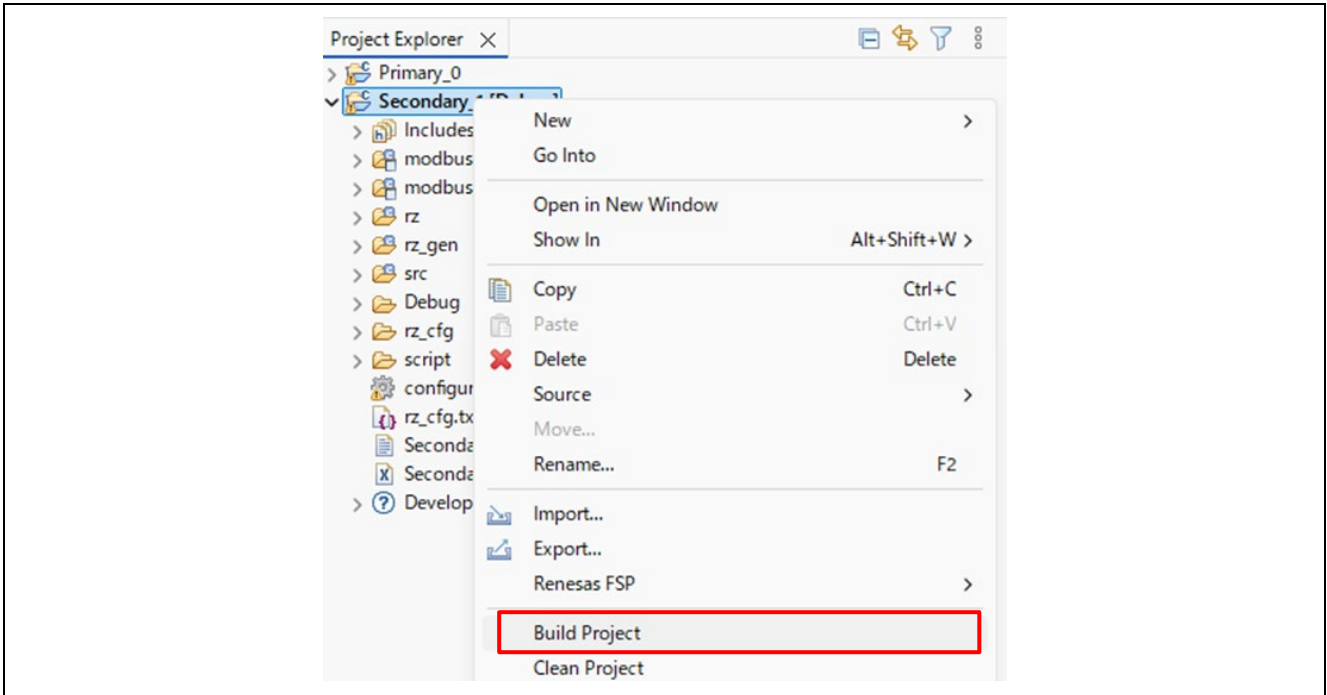

8. After connecting the board and J-Link, start debugging in the following procedure.
Select the drop-down menu next to the bug icon and selecting “**Debugger Configurations**”.

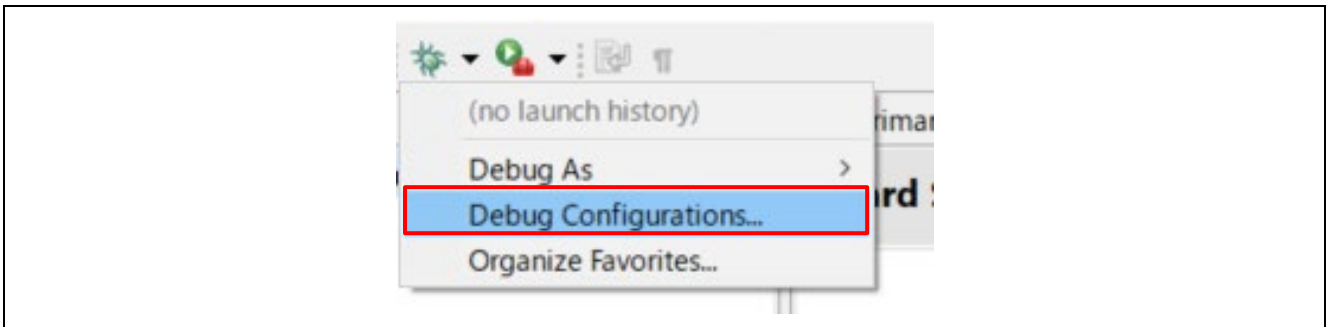

9. Select the “Primary_0” debug item want to use and press [Debug].

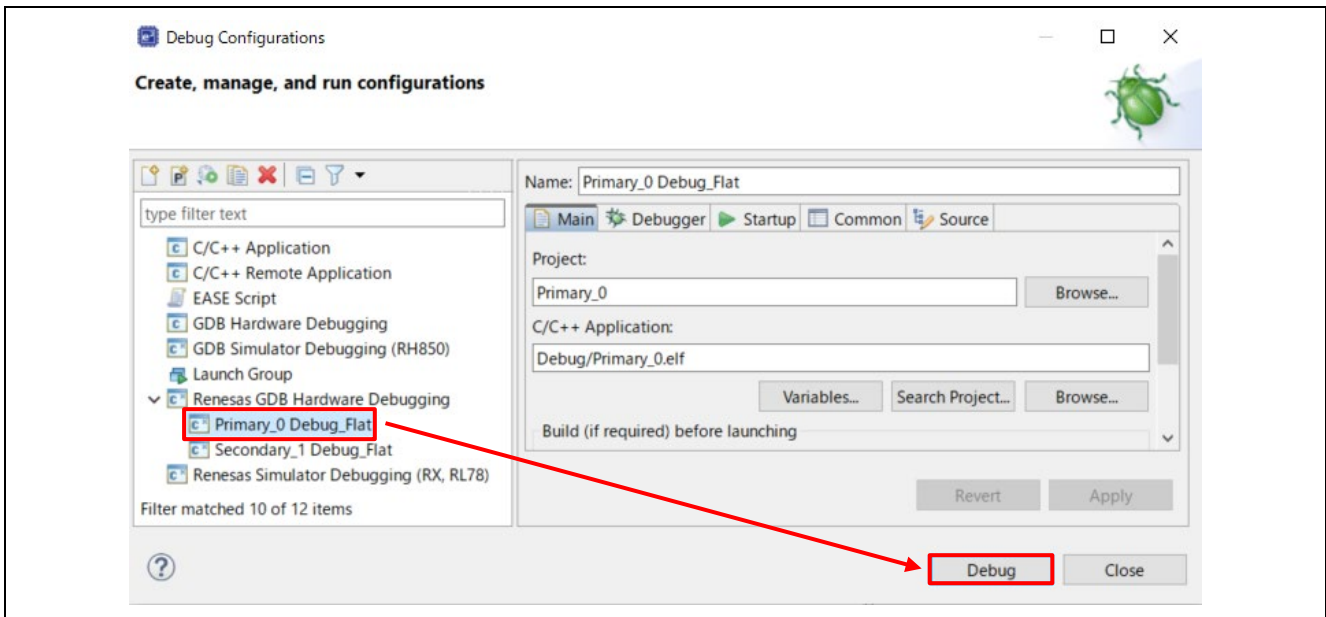

Following dialog will appear, so switch to the debug screen.

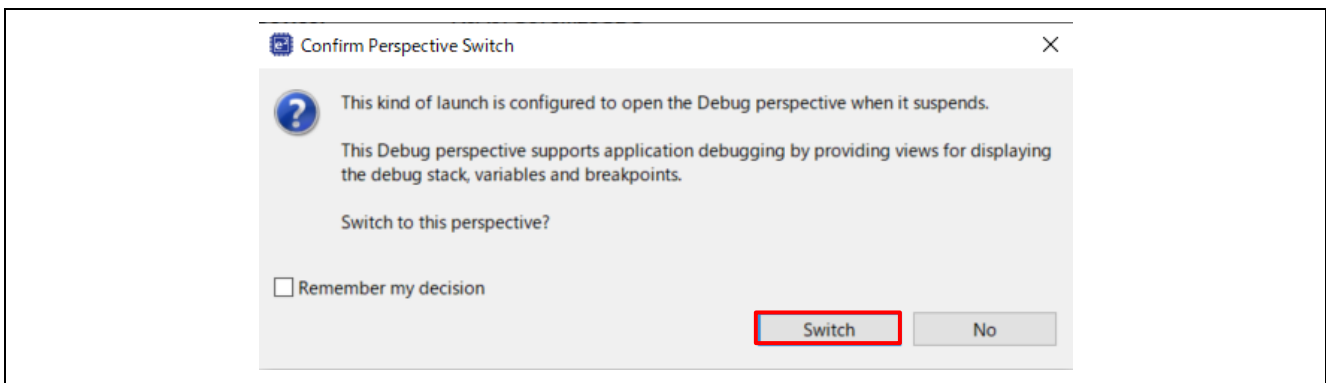

10. In [Project Explorer] view, right click the node of “Secondary_1” project to be debugged and select [Debug As] → [Debug Configurations].

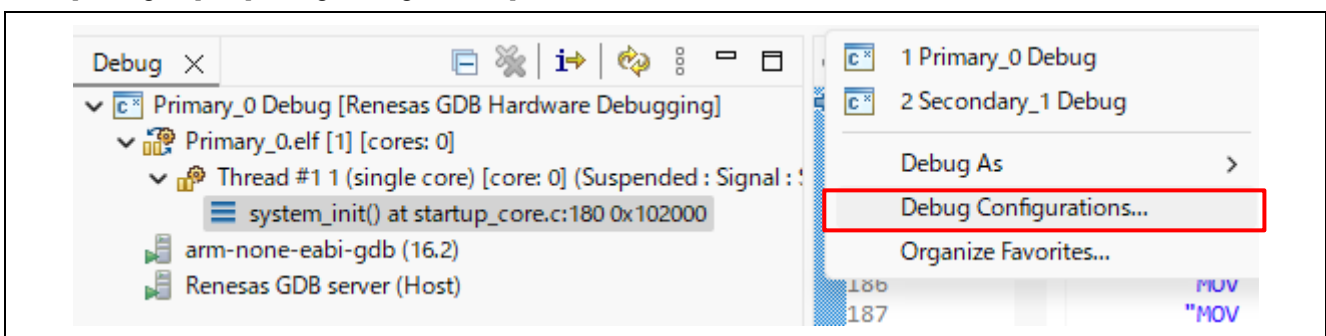

11. Select the "Secondary_1" debug item want to use and press [Debug]

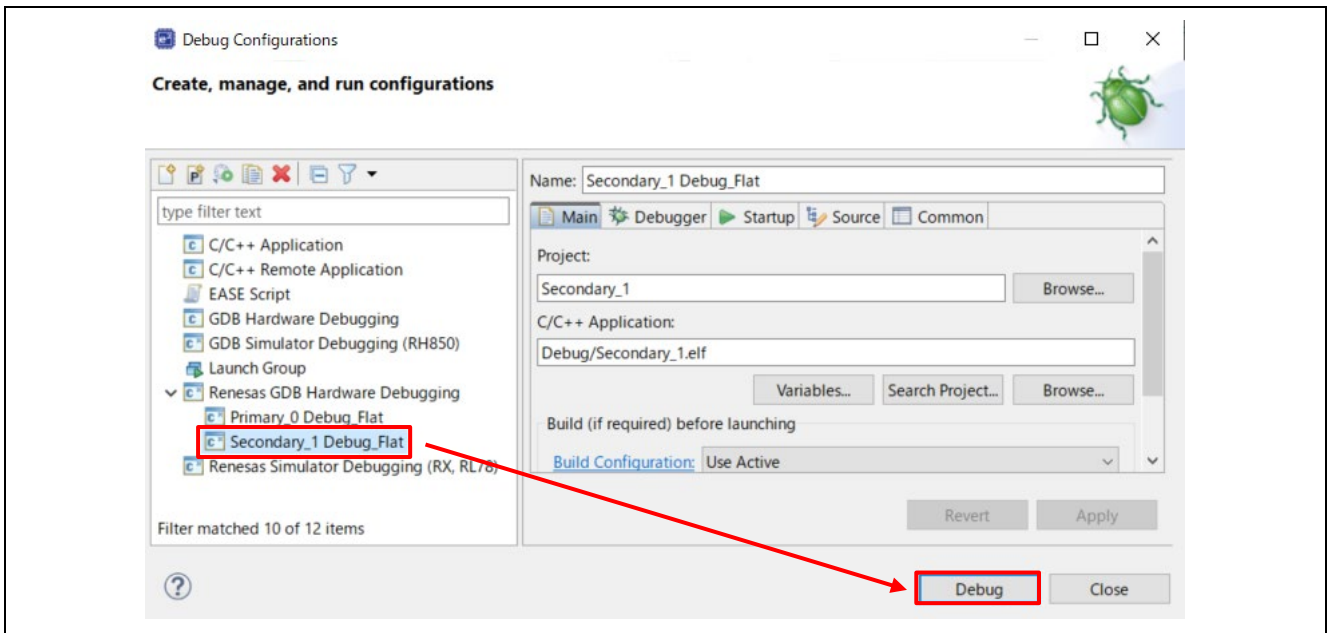

12. Message will appear asking if you want to close all currently active programs. Select "No."

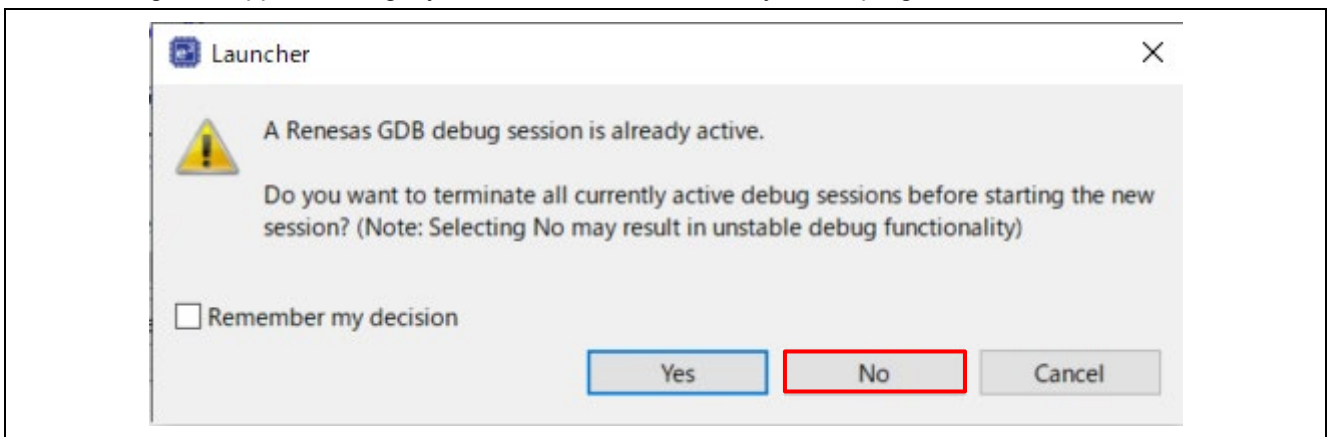

13. Message will appear asking if you want to continue launching, select "Yes".

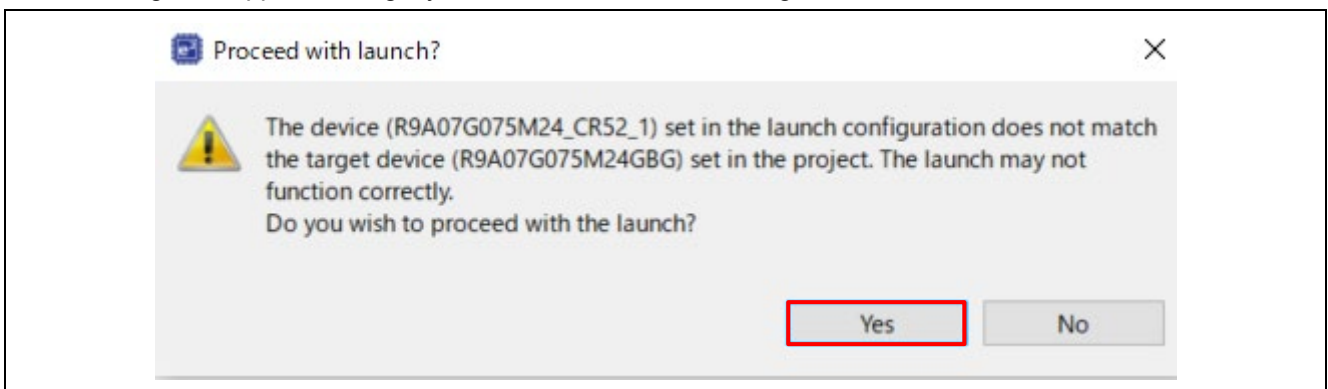

- Press the "Resume" button. Primary_0 debug will start and the program will be suspended in main.c. Press the "Resume" button again. Program will run.

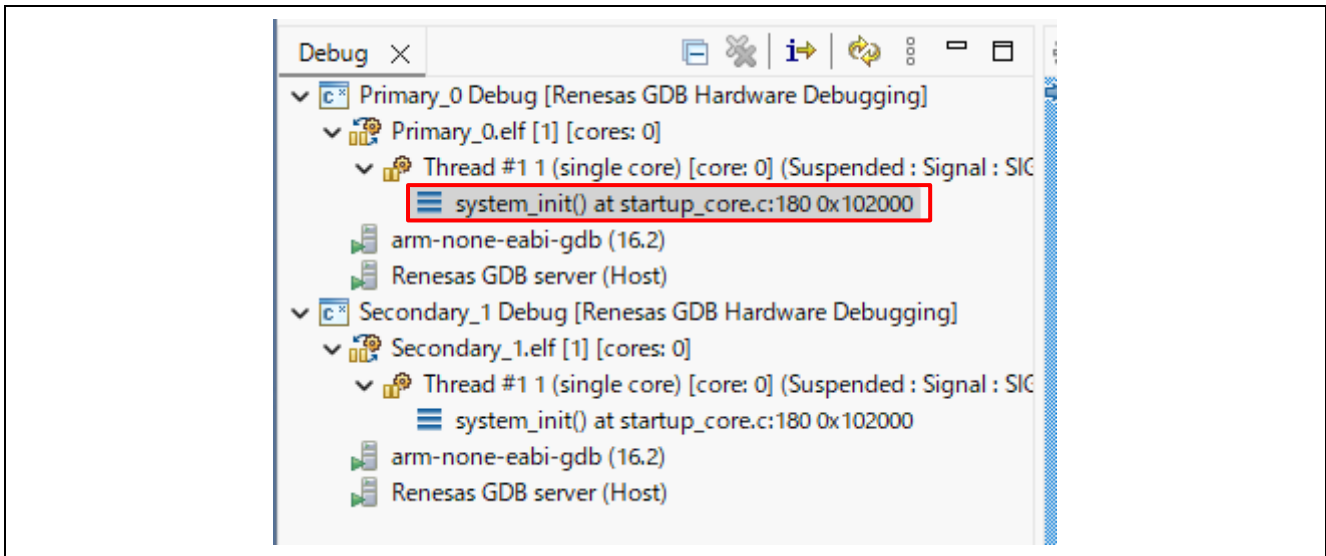

- Press the "Resume" button. Secondary_1 debug will start and the program will be suspended in main.c. Press the "Resume" button again. Program will run.

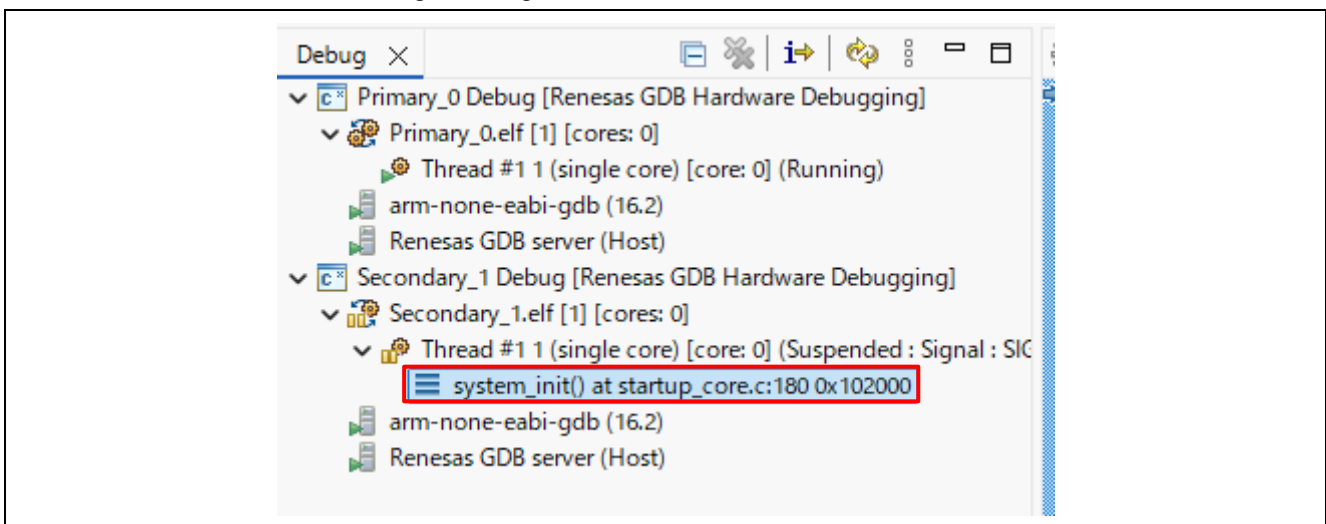

- Finally, the Primary_0 and Secondary_1 cores will start up and the program will run.

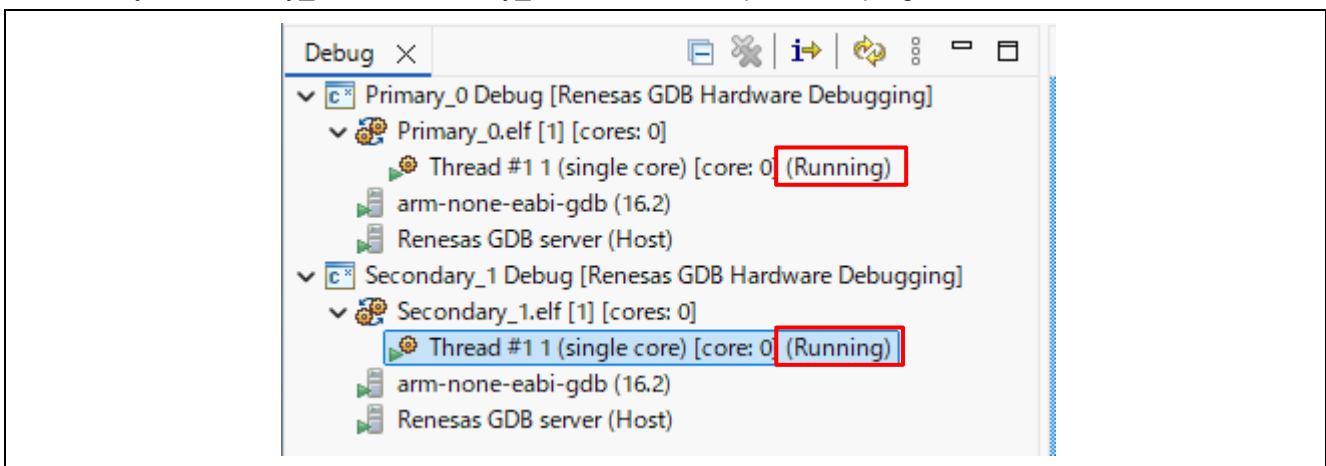

5.2 Setup sample project for EWARM

Build the sample code and load it into RAM using IAR Systems EWARM.

Note). Please install EWARM and adapt the RZ_FSP_Packs_v4.0.0 in advance.

Refer to the latest getting started guide. (r01an6434ejxxxx-rzt2-rzn2-fsp-getting-started.pdf)

This package includes the following projects.

Project	CPU	
Dual-core project (CR52_dual)	Primary_0	CR52_0
	Secondary_1	CR52_1
Dual-core project (CR52-CA55_dual)	Primary_0	CR52_0
	Secondary_1	CA55_2

Note). In EWARM, set the Smart Configurator startup settings as follows.

[Tools] -> [Configure Tools]

- Menu Text: **FSP Smart Configurator**
- Command: **\$RASC_EXE_PATH\$** (The following example is "C:\Renesas\rz\sc_v2025-12_fsp_v4.0.0\eclipse\rasc.exe")
- Argument: **--compiler IAR configuration.xml**
- Initial Directory: **\$PROJ_DIR\$**

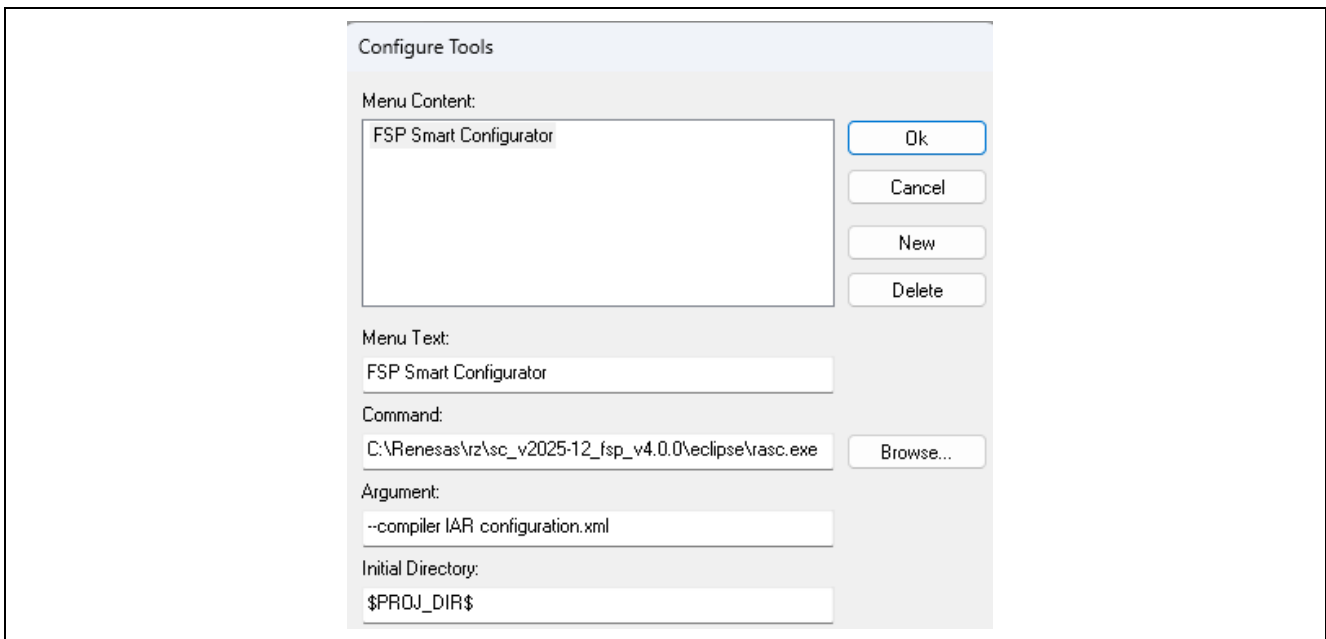

Edit "buildinfo.ipcf" file. Open the buildinfo.ipcf file and edit "RASC_EXE_PATH" to match the installation path of "rasc.exe".

```

<customArgVars>↓
  <group name="RA Smart Configurator">↓
    <argVar>↓
      <name>RASC_EXE_PATH</name>↓
      <value>C:\Renesas\rz\sc_v2025-12_fsp_v4.0.0\eclipse\rasc.exe</value>↓
    </argVar>↓
  </group>
</customArgVars>
    
```

5.2.1 Dual core project startup procedure (CR52_0, CR52_1), (CR52_0, CA55_2)

1. Open the sample project.
"RZN2H_Modbus_EVB_rev400\Modbus_gateway\project\xxxx_dual\warm\Primary_0
\Primary_0.eww"

Note), **xxxx** is either "CR52" or "CR52-CA55", select one.

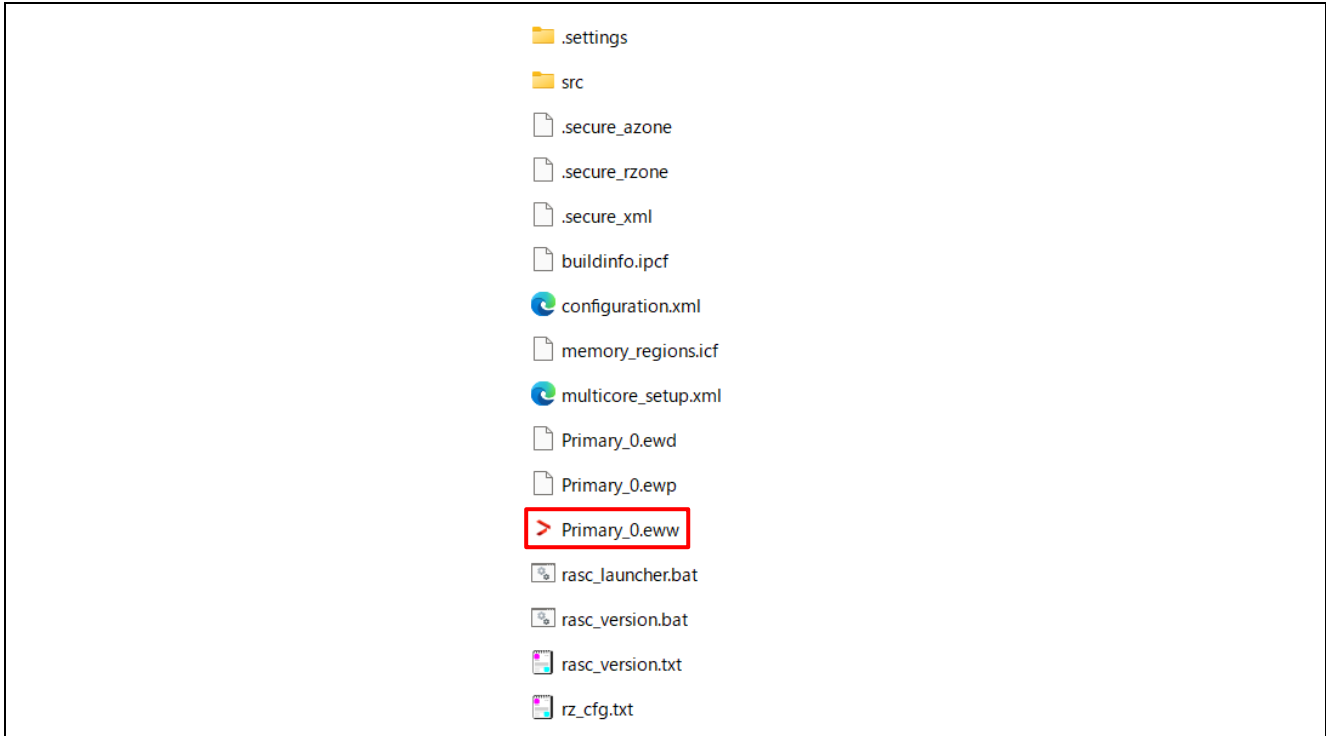

2. Open the "RZ Smart Configurator"

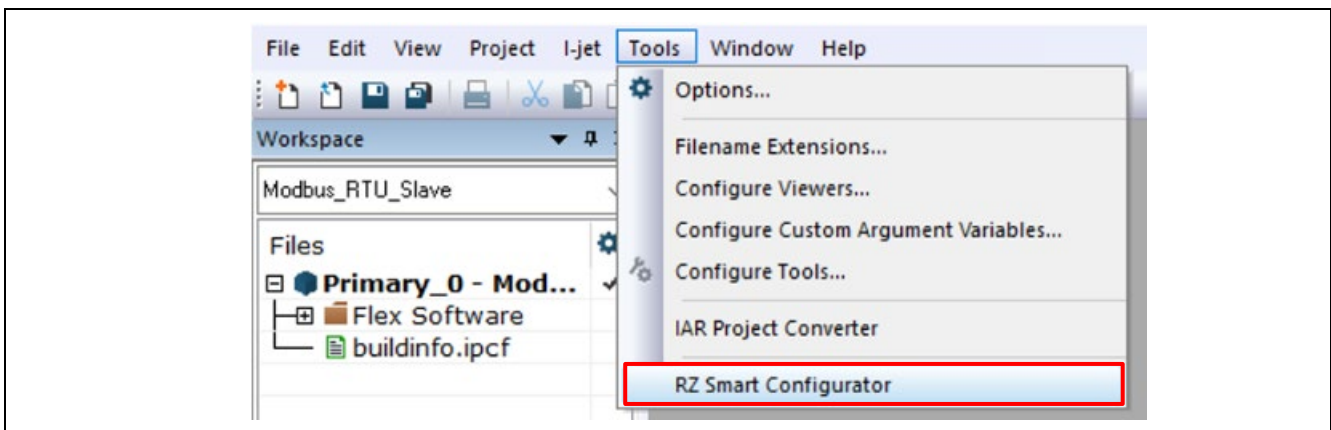

3. Confirm the project boot mode. (Following is RAM boot mode.)
Generate the code with "**Generate Project Content**".

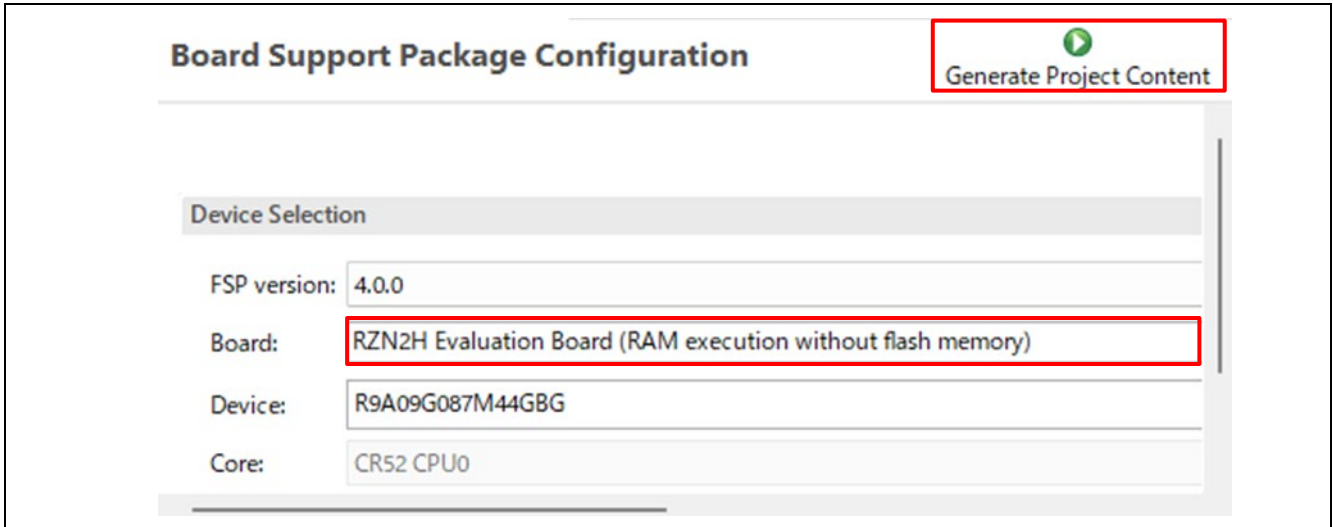

4. Select the "Rebuild All" item from the "Project" menu to rebuild the project.

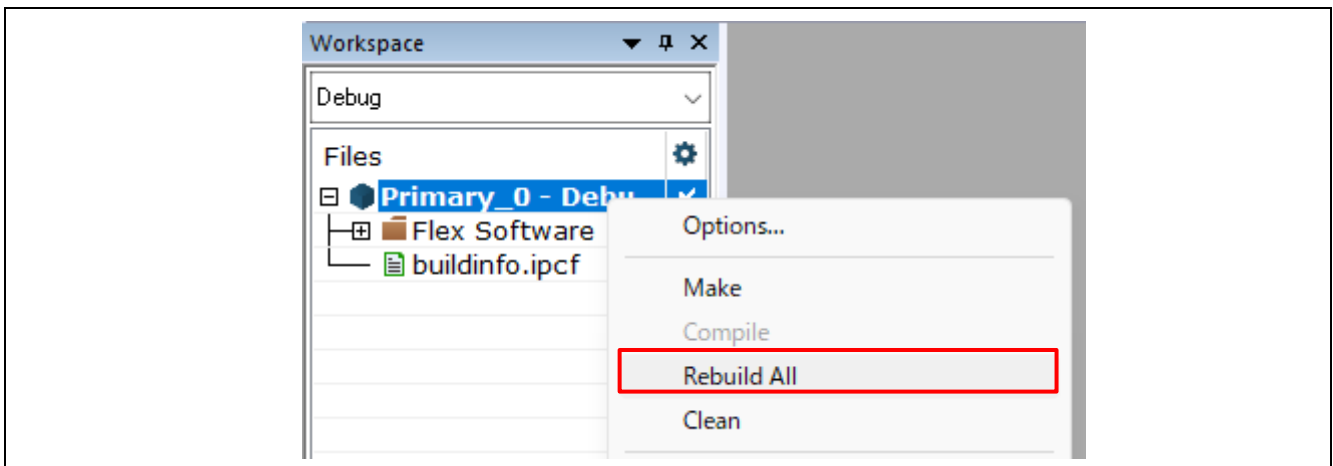

5. When the building is complete, close the "**Primary_0**" project.

- Open the sample project.
"RZN2H_Modbus_EVB_rev400\Modbus_gateway\project\xxxx_dualwarm\Secondary_1\Secondary_1.eww"

Note), **xxxx** is either "CR52" or "CR52-CA55", select one.

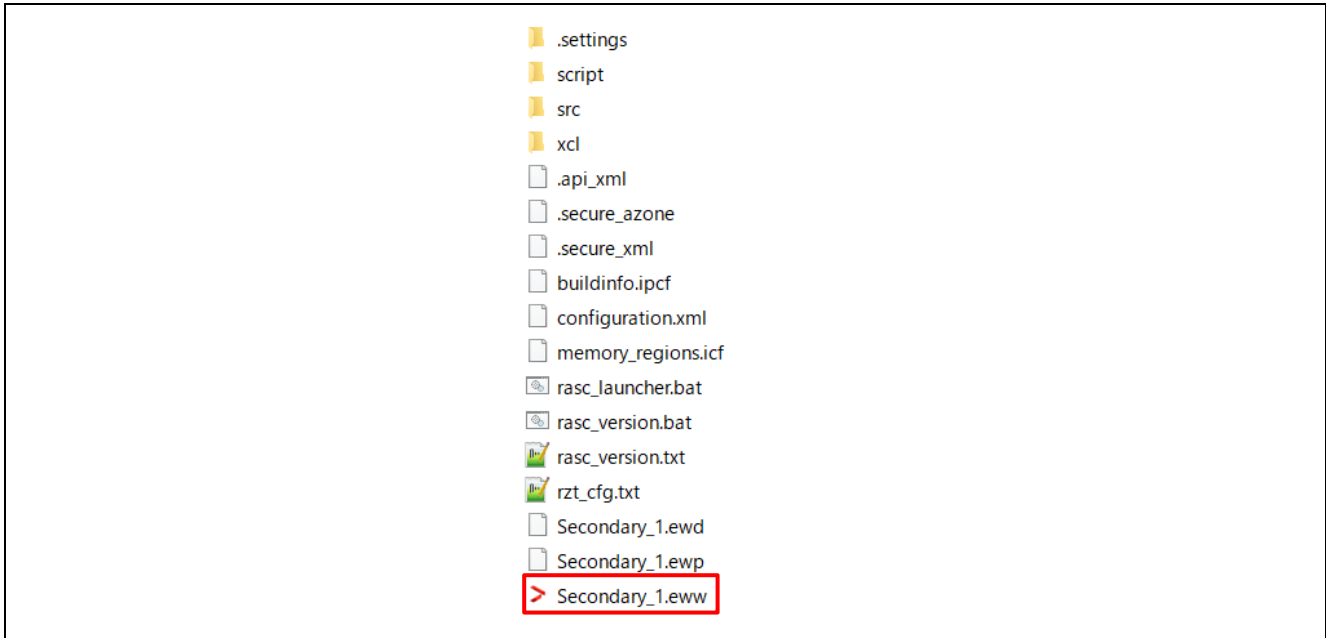

- Open the "RZ Smart Configurator"

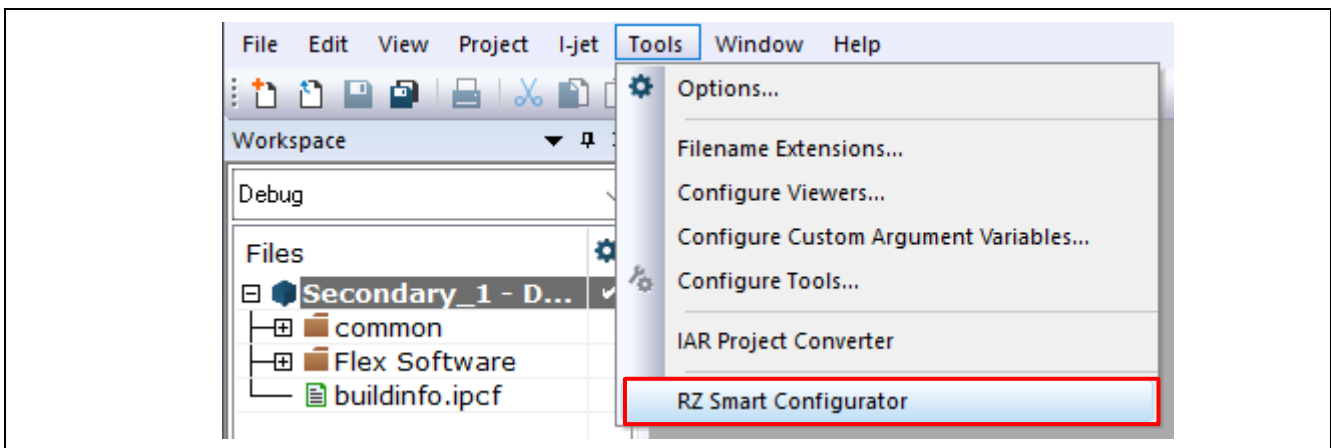

8. Confirm the project boot mode. (Following is RAM boot mode.)
Generate the code with "**Generate Project Content**".

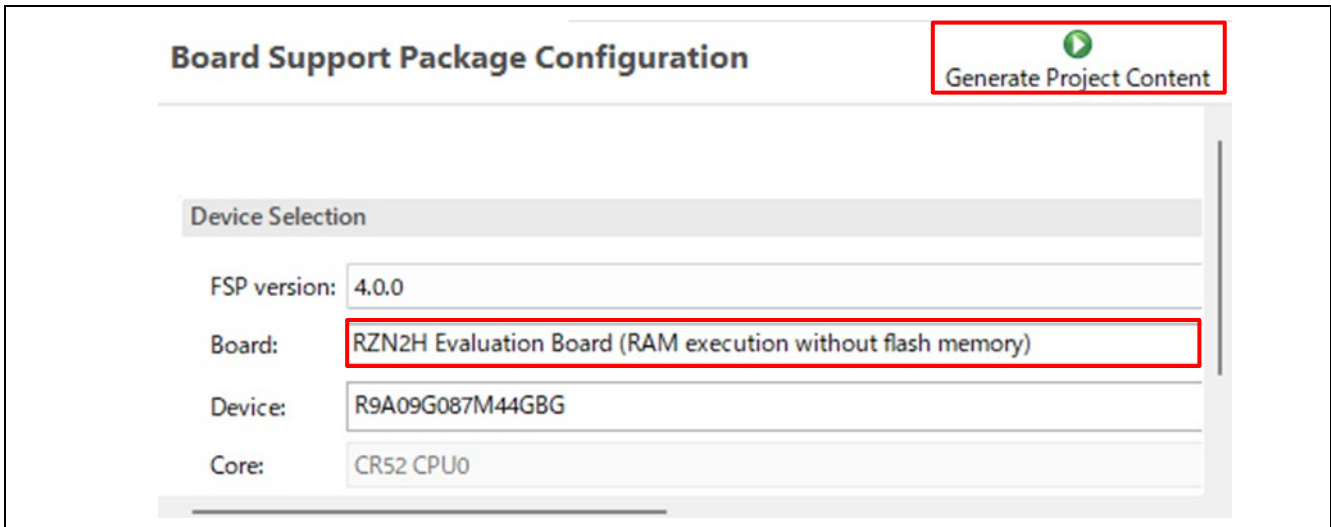

9. Select the "Rebuild All" item from the "Project" menu to rebuild the project.

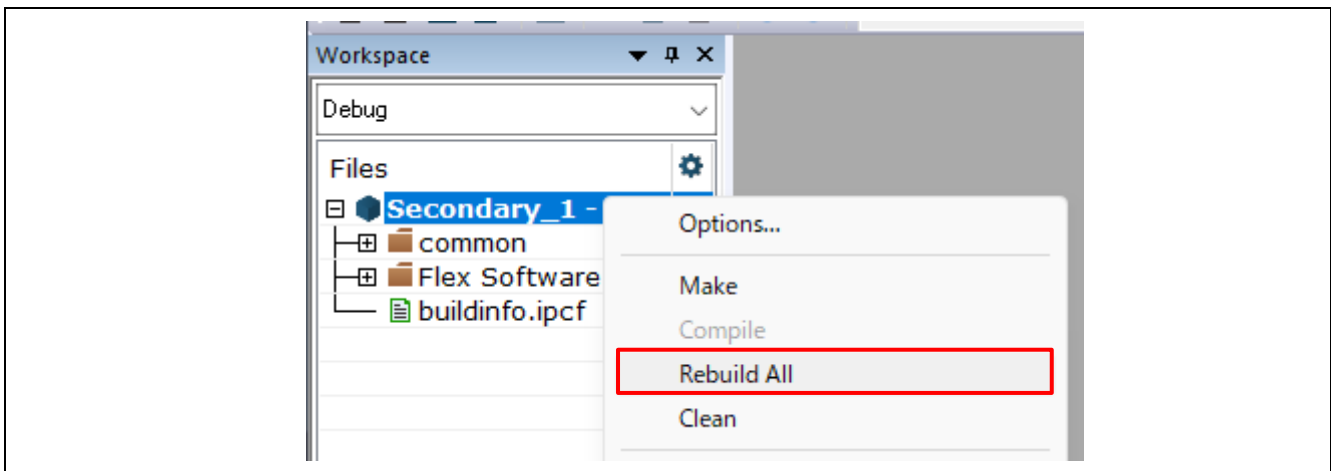

10. When the building is complete, close the "**Secondary_1**" project.

11. Start the “**Primary_0**” project again.
12. Check your debugger options settings.
[Tools] → [Options] → [Project] item, Set "Make before debugging" to "Never".

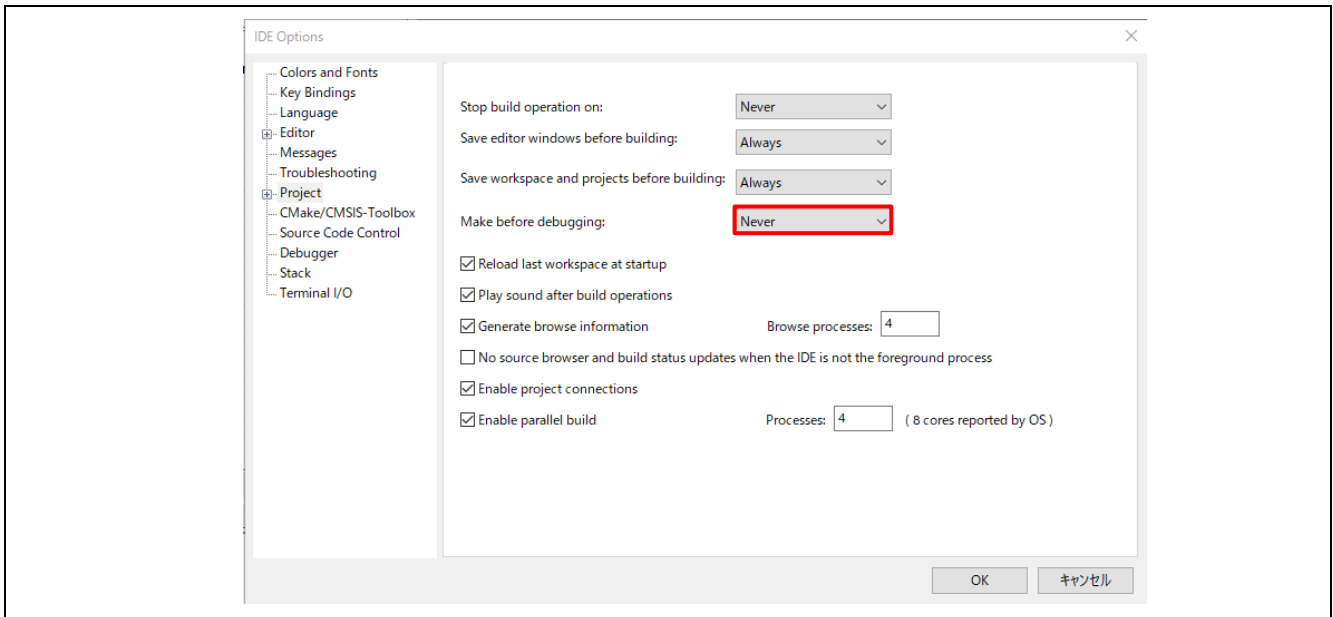

13. After connecting the board and I-jet, click the “Download and Debug button” on the Project toolbar.
When run “Download and Debug”, the “**Secondary_1**” debug screen will also launch at the same time.

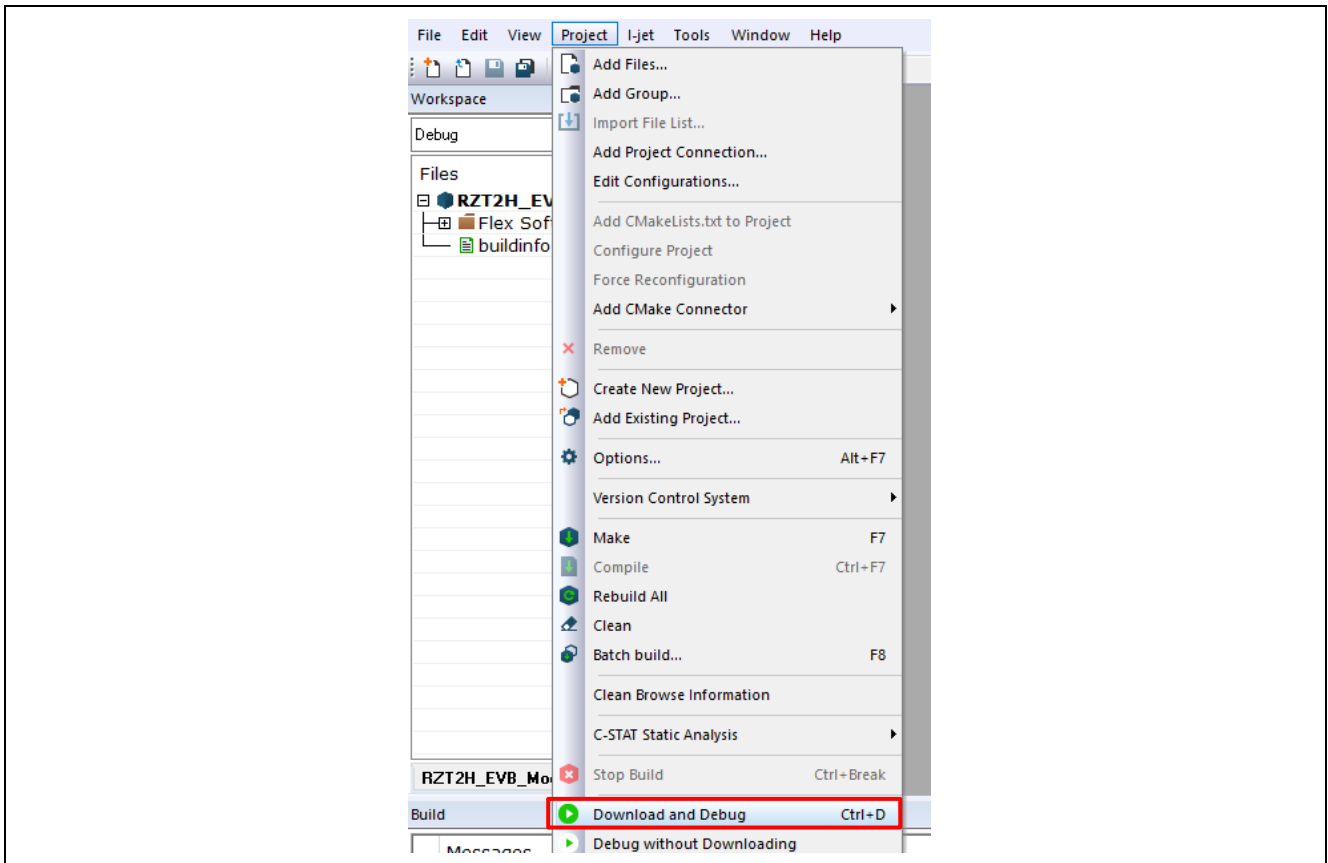

14. First, press the "Resume" button for the "Primary_0" project.

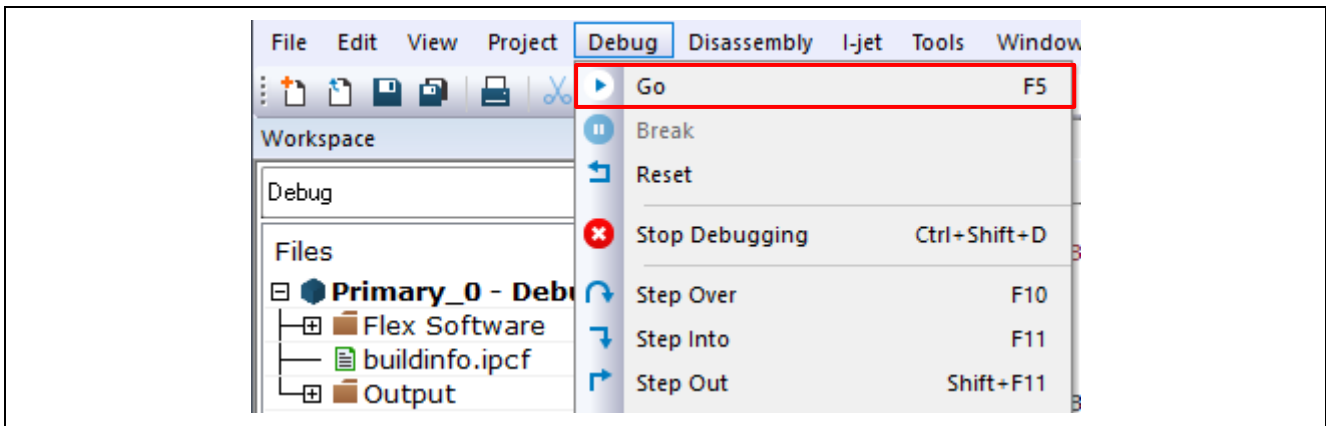

15. Next, press the "Resume" button for the "Secondary_1" project. Program will run.

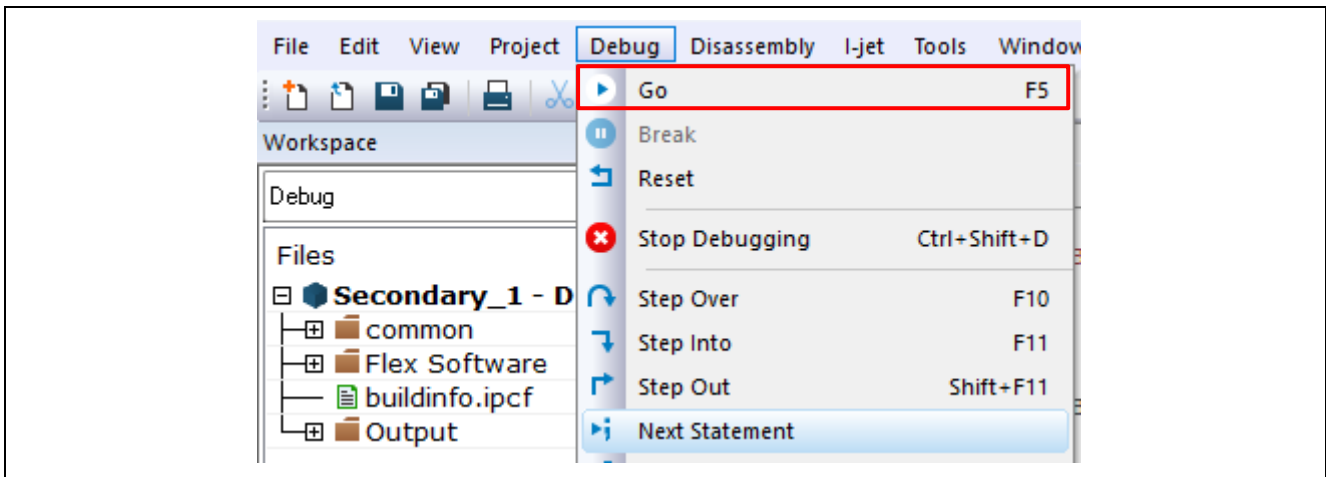

5.3 Demonstration

5.3.1 Simple demonstration

Users can see the simple demonstration using this Modbus protocol stack in this sample project. For this control, "Read_Discrete_Inputs" and "Write_Single_Coil" function codes are used. Specifically, the following sequence is executed.

In this chapter, we will check the operation using the configuration shown in Figure 3.5 in Chapter 3.3.2.

1. Start two demo applications "ModbusDemoApplication.exe" at the same time. Set one to "TCP Gateway" and the other to "Serial Client". See Figure 4.1 and Figure 4.2 in Chapter 4.
2. Connect "Serial Client" and then "TCP Gateway".
3. Changing "Discrete Input" on the Serial side will reflect "Discrete Input" on the TCP side.

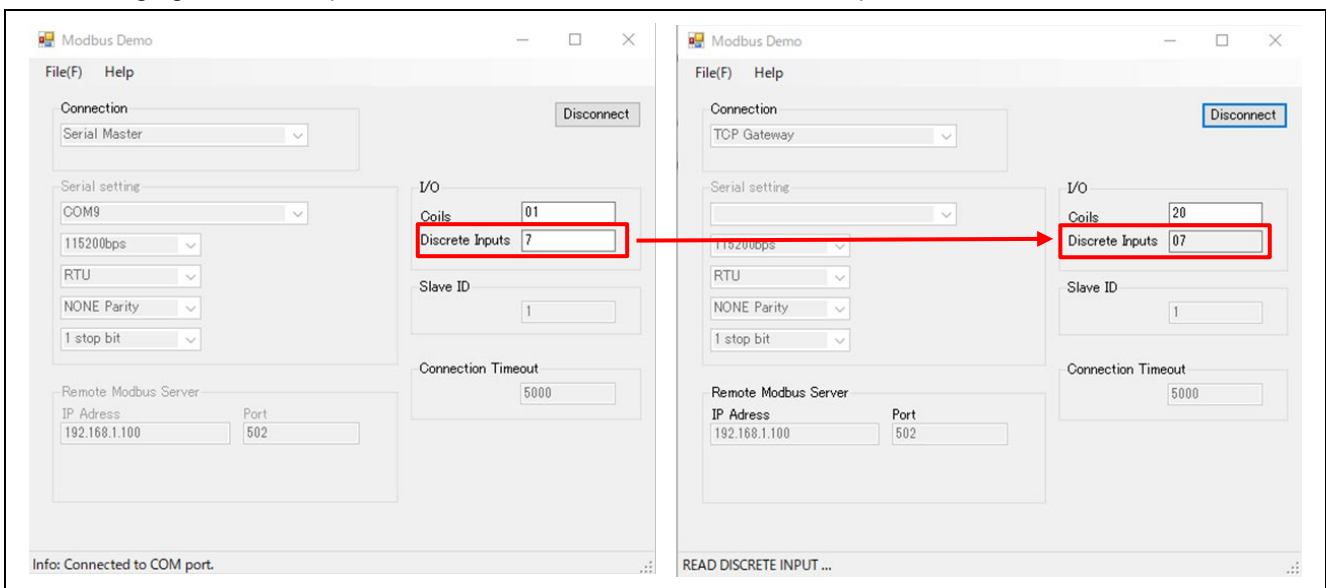

Figure 5.1 Demo Tool Evaluation Settings

5.3.2 Standard demonstration

In this chapter, we will check the operation using the configuration shown in Figure 3.4 in Chapter 3.3.2.

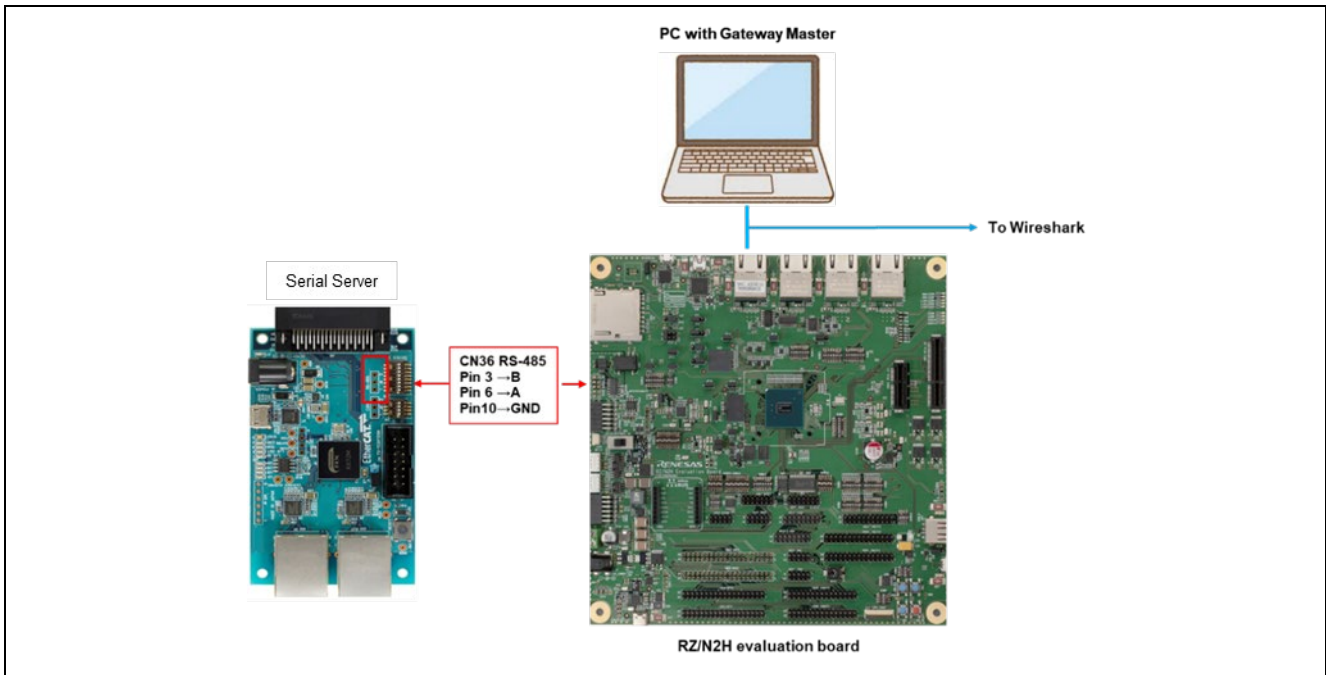

Figure 5.2 Example of evaluation connection using serial server.

Start "ModbusDemoApplication.exe".

Set it to "TCP Gateway" and set the TCP settings "IP Address" and the server settings "Server ID" as shown in Figure 5.1.

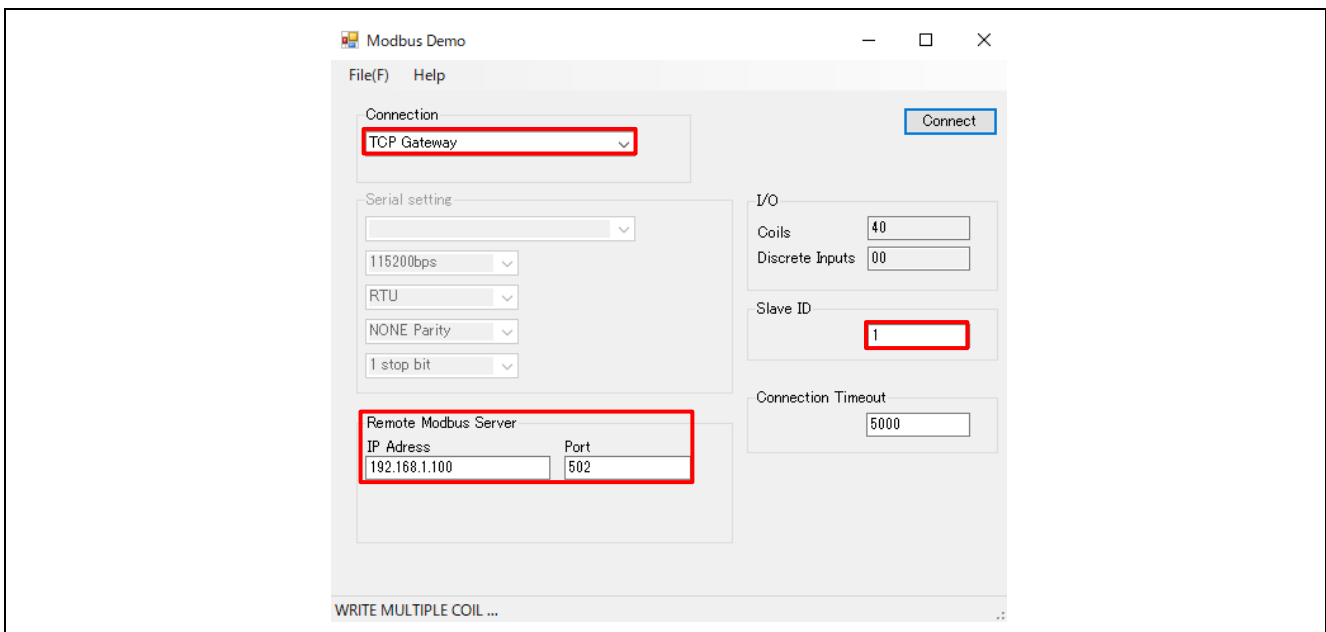

Figure 5.3 Demo Tool Evaluation Settings

TCP frames are communicated, so you can check the packets using Wireshark.

6. Appendix

6.1 Appendix A. Setting the baud rate.

1. Open
“RZ/N2H_Modbus_EVB_rev0400\Modbus_gateway\common\renesas\modbus_user\ modbus_init.
c”
2. Change the following variables.

```
/* serial connection setting */  
st_init_info.u32_baud_rate = UART_BAUD_115200;  
/* Baud rate for serial port configuration, supported baud rate values are 9600 to 115200 bps */
```

The values that can be set are 115200, 76800, 38400, 31250, 19200 or 9600.

The timeout period is calculated based on the baud rate setting above.

6.2 Appendix B. Application Programming Interface

Function

· Modbus_tcp_init_ip_table

Description	Modbus set host IP list properties.		
Format	<pre>void Modbus_tcp_init_ip_table (ENABLE_FLAG e_flag, TABLE_MODE e_mode);</pre>		
Parameter	ENABLE_FLAG	e_flag	Status is whether the connection table enabled or disabled.
	TABLE_MODE	e_mode	Status indicating the list contain IP to be accepted or rejected.
Return value	None		
Error code	None		

· Modbus_tcp_add_ip_addr

Description	Modbus add an IP address to host IP list.		
Format	<pre>uint32_t Modbus_tcp_add_ip_addr (pchar_t pu8_add_ip.)</pre>		
Parameter	pchar_t	pu8_add_ip	Host IP address in numbers and dots notation. ex. 192.168.1.100
Return value	Error code		
Error code	ERR_OK		On success
	ERR_IP_ALREADY_PRESENT		If address already present in list.
	ERR_MAX_CLIENT		If maximum connections reached.
	ERR_TABLE_DISABLED		If IP list is disabled.

· Modbus_tcp_delete_ip_addr

Description	Modbus delete an IP address to host IP list		
Format	<pre>uint32_t Modbus_tcp_delete_ip_addr (pchar_t pu8_del_ip)</pre>		
Parameter	pchar_t	pu8_del_ip	Host IP address in numbers and dots notation ex. 192.168.1.101
Return value	Error code		
Error code	ERR_OK ERR_IP_ALREADY_PRESENT ERR_MAX_CLIENT ERR_TABLE_DISABLED		On success If address already present in list. If maximum connections reached. If IPlist is disabled.

· Modbus_slave_map_init

Description	Modbus function code mapping API		
Format	<pre>uint32_t Modbus_slave_map_init (p_slave_map_init_t pt_slave_func_tbl)</pre>		
Parameter	p_slavemap_init	pt_slave_func_tbl	Structure pointer to function code mapping table
Return value	Error code		
Error code	ERR_OK ERR_INVALID_STACK_INIT_PARAMS ERR_MEM_ALLOC		On success. If parameter is null. If memory allocation failed.

· Modbus_tcp_server_init_stack

Description	Modbus TCP stack initialization API		
Format	<pre>uint32_t Modbus_tcp_server_init_stack (uint32_t u32_additional_port, uint8_t u8_tcp_multiple_client)</pre>		
Parameter	Uuint32_t	u32_additonal_port	Additional port configured by user.
	Uuint8_t	u8_tcp_multiple_client	Status whether multiple clients are enabled.
Return value	Error code		
Error code	ERR_OK ERR_STACK_INIT		On successful initialization of the task or mailbox. If initialization of the task or mailbox failed.

Structure

· slave_map_init_t

Member variables type	Member variables	Description
fp_function_code1_t	fp_function_code1	Callback function pointer for Modbus function code 1 (Read coils) operation.
fp_function_code2_t	fp_function_code2	Callback function pointer for Modbus function code 2 (Read Discrete Inputs) operation.
fp_function_code3_t	fp_function_code3	Callback function pointer for Modbus function code 3 (Read Holding Registers) operation.
fp_function_code4_t	fp_function_code4	Callback function pointer for Modbus function code 4 (Read Input Register Read coils) operation.
fp_function_code5_t	fp_function_code5	Callback function pointer for Modbus function code 5 (Write Single Coil) operation.
fp_function_code6_t	fp_function_code6	Callback function pointer for Modbus function code 6 (Write Single Register) operation.
fp_function_code15_t	fp_function_code15	Callback function pointer for Modbus function code 15 (Write Multiple Coils) operation.
fp_function_code16_t	fp_function_code16	Callback function pointer for Modbus function code 16 (Write Multiple Registers) operation.
fp_function_code23_t	fp_function_code23	Callback function pointer for Modbus function code 23 (Read/Write Multiple Registers) operation.

· p_req_read_coils_t

Member variables type	Member variables	Description
uint16_t	u16_transaction_id	Specifies the transaction ID
uint16_t	u16_protocol_id	Specifies the protocol ID
uint8_t	u8_slave_id	Identification of a remote slave connected
uint16_t	u16_start_addr	Specifies address of the first coil
uint16_t	u16_num_of_coils	Specifies the number of coils to be read

- **p_req_read_inputs_t**

Member variables type	Member variables	Description
uint16_t	u16_transaction_id	Specifies the transaction ID
uint16_t	u16_protocol_id	Specifies the protocol ID
uint8_t	u8_slave_id	Identification of a remote slave connected
uint16_t	u16_start_addr	Specifies address of the first discrete input
uint16_t	u16_num_of_inputs	Specifies the number of discrete inputs to be read

- **p_req_read_holding_reg_t**

Member variables type	Member variables	Description
uint16_t	u16_transaction_id	Specifies the transaction ID
uint16_t	u16_protocol_id	Specifies the protocol ID
uint8_t	u8_slave_id	Identification of a remote slave connected
uint16_t	u16_start_addr	Specifies address of the first holding register
uint16_t	u16_num_of_reg	Specifies the number of registers to be read

- **p_req_read_input_reg_t**

Member variables type	Member variables	Description
uint16_t	u16_transaction_id	Specifies the transaction ID
uint16_t	u16_protocol_id	Specifies the protocol ID
uint8_t	u8_slave_id	Identification of a remote slave connected
uint16_t	u16_start_addr	Specifies address of the first input register
uint16_t	u16_num_of_reg	Specifies the number of registers to be read

- **p_req_write_single_coil_t**

Member variables type	Member variables	Description
uint16_t	u16_transaction_id	Specifies the transaction ID
uint16_t	u16_protocol_id	Specifies the protocol ID
uint8_t	u8_slave_id	Identification of a remote slave connected
uint16_t	u16_output_addr	Specifies address of the coil
uint16_t	u16_output_value	Data to be written

- **p_req_write_single_reg_t**

Member variables type	Member variables	Description
uint16_t	u16_transaction_id	Specifies the transaction ID
uint16_t	u16_protocol_id	Specifies the protocol ID
uint8_t	u8_slave_id	Identification of a remote slave connected
uint16_t	u16_register_addr	Specifies address of the register
uint16_t	u16_register_value	Data to be written

- **p_req_write_multiple_coils_t**

Member variables type	Member variables	Description
uint16_t	u16_transaction_id	Specifies the transaction ID
uint16_t	u16_protocol_id	Specifies the protocol ID
uint8_t	u8_slave_id	Identification of a remote slave connected
uint16_t	u16_start_addr	Specifies address of the first coil
uint16_t	u16_num_of_outputs	Specifies the number of coils to be written
uint8_t	u8_num_of_bytes	Specifies the number of bytes of data
uint8_t	aru8_data [MAX_DISCRETE_DATA]	Data to be written * MAX_DISCRETE_DATA is defined in 251

- **p_req_write_multiple_reg_t**

Member variables type	Member variables	Description
uint16_t	u16_transaction_id	Specifies the transaction ID
uint16_t	u16_protocol_id	Specifies the protocol ID
uint8_t	u8_slave_id	Identification of a remote slave connected
uint16_t	u16_start_addr	Specifies address of the first register
uint16_t	u16_num_of_reg	Specifies the number of registers to be written
uint8_t	u8_num_of_bytes	Specifies the number of bytes of data
uint16_t	aru16_data [MAX_REG_DATA]	Data to be written * MAX_REG_DATA is defined in 125

· p_req_read_write_multiple_reg_t

Member variables type	Member variables	Description
uint16_t	u16_transaction_id	Specifies the transaction ID
uint16_t	u16_protocol_id	Specifies the protocol ID
uint8_t	u8_slave_id	Identification of a remote slave connected
uint16_t	u16_read_start_addr	Specifies address of the first register to be read from
uint16_t	u16_num_to_read	Specifies the number of registers to be read
uint16_t	u16_write_start_addr	Specifies address of the first register to be written to
uint16_t	u16_num_to_write	Specifies the number of registers to be written
uint8_t	u8_write_num_of_bytes	Specifies the number of bytes of data
uint16_t	aru16_data [MAX_REG_DATA]	Data to be written * MAX_REG_DATA is defined in 125

· p_resp_read_coils_t

Member variables type	Member variables	Description
uint16_t	u16_transaction_id	Specifies the transaction ID
uint16_t	u16_protocol_id	Specifies the protocol ID
uint8_t	u8_slave_id	Identification of a remote slave connected (Own ID)
uint8_t	u8_exception_code	Error detected during processing the request. On success the exception code should be zero, if the exception code is nonzero the aru8_data [253] will be null
uint8_t	u8_num_of_bytes	Specifies the number of bytes of data
uint8_t	aru8_data [MAX_DISCRETE_DATA]	Data to be read * MAX_DISCRETE_DATA is defined in 251

- **p_resp_read_inputs_t**

Member variables type	Member variables	Description
uint16_t	u16_transaction_id	Specifies the transaction ID
uint16_t	u16_protocol_id	Specifies the protocol ID
uint8_t	u8_slave_id	Identification of a remote slave connected (Own ID)
uint8_t	u8_exception_code	Error detected during processing the request. On success the exception code should be zero, if the exception code is nonzero the aru8_data [253] will be null
uint8_t	u8_num_of_bytes	Specifies the number of bytes of data
uint8_t	aru8_data [MAX_DISCRETE_DATA]	Buffer to store the read data * MAX_DISCRETE_DATA is defined in 251

- **p_resp_read_holding_reg_t**

Member variables type	Member variables	Description
uint16_t	u16_transaction_id	Specifies the transaction ID
uint16_t	u16_protocol_id	Specifies the protocol ID
uint8_t	u8_slave_id	Identification of a remote slave connected (Own ID)
uint8_t	u8_exception_code	Error detected during processing the request. On success the exception code should be zero, if the exception code is nonzero the aru8_data [253] will be null
uint8_t	u8_num_of_bytes	Specifies the number of bytes of data
uint16_t	aru16_data [MAX_REG_DATA]	Buffer to store the read data * MAX_REG_DATA is defined in 125

- **p_resp_read_input_reg_t**

Member variables type	Member variables	Description
uint16_t	u16_transaction_id	Specifies the transaction ID
uint16_t	u16_protocol_id	Specifies the protocol ID
uint8_t	u8_slave_id	Identification of a remote slave connected (Own ID)
uint8_t	u8_exception_code	Error detected during processing the request. On success the exception code should be zero, if the exception code is nonzero the aru8_data [253] will be null
uint8_t	u8_num_of_bytes	Specifies the number of bytes of data
uint16_t	aru16_data [MAX_REG_DATA]	Buffer to store the read data. * MAX_REG_DATA is defined in 125

· **p_resp_write_single_coil_t**

Member variables type	Member variables	Description
uint16_t	u16_transaction_id	Specifies the transaction ID
uint16_t	u16_protocol_id	Specifies the protocol ID
uint8_t	u8_slave_id	Identification of a remote slave connected (Own ID)
uint8_t	u8_exception_code	Error detected during processing the request. On success the exception code should be zero
uint16_t	u16_output_addr	Specifies address of the coil
uint16_t	u16_output_value	Data to be written

· **p_resp_write_single_reg_t**

Member variables type	Member variables	Description
uint16_t	u16_transaction_id	Specifies the transaction ID
uint16_t	u16_protocol_id	Specifies the protocol ID
uint8_t	u8_slave_id	Identification of a remote slave connected (Own ID)
uint8_t	u8_exception_code	Error detected during processing the request. On success the exception code should be zero
uint16_t	u16_register_addr	Specifies address of the register
uint16_t	u16_register_value	Data to be written

· **p_resp_write_multiple_coils_t**

Member variables type	Member variables	Description
uint16_t	u16_transaction_id	Specifies the transaction ID
uint16_t	u16_protocol_id	Specifies the protocol ID
uint8_t	u8_slave_id	Identification of a remote slave connected (Own ID)
uint8_t	u8_exception_code	Error detected during processing the request. On success the exception code should be zero
uint16_t	u16_start_addr	Specifies address of the first coil
uint16_t	u16_num_of_outputs	Specifies the number of coils to be written

- **p_resp_write_multiple_reg_t**

Member variables type	Member variables	Description
uint16_t	u16_transaction_id	Specifies the transaction ID
uint16_t	u16_protocol_id	Specifies the protocol ID
uint8_t	u8_slave_id	Identification of a remote slave connected (Own ID)
uint8_t	u8_exception_code	Error detected during processing the request. On success the exception code should be zero, if the exception code is nonzero the aru8_data [253] will be null
uint16_t	u16_start_addr	Specifies address of the first register
uint16_t	u16_num_of_reg	Specifies the number of registers to be written

- **p_resp_read_write_multiple_reg_t**

Member variables type	Member variables	Description
uint16_t	u16_transaction_id	Specifies the transaction ID
uint16_t	u16_protocol_id	Specifies the protocol ID
uint8_t	u8_slave_id	Identification of a remote slave connected (Own ID)
uint8_t	u8_exception_code	Error detected during processing the request. On success the exception code should be zero, if the exception code is nonzero the aru8_data [253] will be null
uint8_t	u8_num_of_bytes	Specifies the number of complete bytes of data
uint16_t	aru16_read_data [MAX_REG_DATA]	Data to be read * MAX_REG_DATA is defined in 125

- **p_resp_invalid_function_code_t**

Member variables type	Member variables	Description
uint16_t	u16_transaction_id	Specifies the transaction ID
uint16_t	u16_protocol_id	Specifies the protocol ID
uint8_t	u8_slave_id	Identification of a remote slave connected (Own ID)
uint8_t	u8_exception_code	Error detected during processing the request. On success the exception code should be zero, if the exception code is nonzero the aru8_data [253] will be null
uint8_t	u8_num_of_bytes	Specifies the number of complete bytes of data

7. Limitations

There is no limitation.

Revision History

Rev.	Date	Description	
		Page	Summary
1.00	Dec 23, 2024	-	First Edition issued
2.11	Jun 20, 2025	-	- Added FSP2.2 compatibility method - Change the switch settings for the MP board
3.00	Nov 28, 2025	-	Supports RZ/N2 FSP3.0.0
4.00	Apr 10, 2026	-	Supports RZ FSP4.0.0

General Precautions in the Handling of Microprocessing Unit and Microcontroller Unit Products

The following usage notes are applicable to all Microprocessing unit and Microcontroller unit products from Renesas. For detailed usage notes on the products covered by this document, refer to the relevant sections of the document as well as any technical updates that have been issued for the products.

1. Precaution against Electrostatic Discharge (ESD)

A strong electrical field, when exposed to a CMOS device, can cause destruction of the gate oxide and ultimately degrade the device operation. Steps must be taken to stop the generation of static electricity as much as possible, and quickly dissipate it when it occurs. Environmental control must be adequate. When it is dry, a humidifier should be used. This is recommended to avoid using insulators that can easily build up static electricity. Semiconductor devices must be stored and transported in an anti-static container, static shielding bag or conductive material. All test and measurement tools including work benches and floors must be grounded. The operator must also be grounded using a wrist strap. Semiconductor devices must not be touched with bare hands. Similar precautions must be taken for printed circuit boards with mounted semiconductor devices.

2. Processing at power-on

The state of the product is undefined at the time when power is supplied. The states of internal circuits in the LSI are indeterminate and the states of register settings and pins are undefined at the time when power is supplied. In a finished product where the reset signal is applied to the external reset pin, the states of pins are not guaranteed from the time when power is supplied until the reset process is completed. In a similar way, the states of pins in a product that is reset by an on-chip power-on reset function are not guaranteed from the time when power is supplied until the power reaches the level at which resetting is specified.

3. Input of signal during power-off state

Do not input signals or an I/O pull-up power supply while the device is powered off. The current injection that results from input of such a signal or I/O pull-up power supply may cause malfunction and the abnormal current that passes in the device at this time may cause degradation of internal elements. Follow the guideline for input signal during power-off state as described in your product documentation.

4. Handling of unused pins

Handle unused pins in accordance with the directions given under handling of unused pins in the manual. The input pins of CMOS products are generally in the high-impedance state. In operation with an unused pin in the open-circuit state, extra electromagnetic noise is induced in the vicinity of the LSI, an associated shoot-through current flows internally, and malfunctions occur due to the false recognition of the pin state as an input signal become possible.

5. Clock signals

After applying a reset, only release the reset line after the operating clock signal becomes stable. When switching the clock signal during program execution, wait until the target clock signal is stabilized. When the clock signal is generated with an external resonator or from an external oscillator during a reset, ensure that the reset line is only released after full stabilization of the clock signal. Additionally, when switching to a clock signal produced with an external resonator or by an external oscillator while program execution is in progress, wait until the target clock signal is stable.

6. Voltage application waveform at input pin

Waveform distortion due to input noise or a reflected wave may cause malfunction. If the input of the CMOS device stays in the area between V_{IL} (Max.) and V_{IH} (Min.) due to noise, for example, the device may malfunction. Take care to prevent chattering noise from entering the device when the input level is fixed, and also in the transition period when the input level passes through the area between V_{IL} (Max.) and V_{IH} (Min.).

7. Prohibition of access to reserved addresses

Access to reserved addresses is prohibited. The reserved addresses are provided for possible future expansion of functions. Do not access these addresses as the correct operation of the LSI is not guaranteed.

8. Differences between products

Before changing from one product to another, for example to a product with a different part number, confirm that the change will not lead to problems. The characteristics of a microprocessing unit or microcontroller unit products in the same group but having a different part number might differ in terms of internal memory capacity, layout pattern, and other factors, which can affect the ranges of electrical characteristics, such as characteristic values, operating margins, immunity to noise, and amount of radiated noise. When changing to a product with a different part number, implement a system-evaluation test for the given product.

<ul style="list-style-type: none">•Arm® and Cortex® are registered trademarks of Arm Limited (or its subsidiaries) in the EU and/or elsewhere. All rights reserved.•Ethernet is a registered trademark of Fuji Xerox Co. Ltd.•Modbus is a registered trademark of Schneider Electric, licensed to the Modbus Organization, Inc.•IEEE is a registered trademark of the Institute of Electrical and Electronics Engineers Inc•Additionally all product names and service names in this document are a trademark or a registered trademark which belongs to the respective owners.

Notice

1. Descriptions of circuits, software and other related information in this document are provided only to illustrate the operation of semiconductor products and application examples. You are fully responsible for the incorporation or any other use of the circuits, software, and information in the design of your product or system. Renesas Electronics disclaims any and all liability for any losses and damages incurred by you or third parties arising from the use of these circuits, software, or information.
2. Renesas Electronics hereby expressly disclaims any warranties against and liability for infringement or any other claims involving patents, copyrights, or other intellectual property rights of third parties, by or arising from the use of Renesas Electronics products or technical information described in this document, including but not limited to, the product data, drawings, charts, programs, algorithms, and application examples.
3. No license, express, implied or otherwise, is granted hereby under any patents, copyrights or other intellectual property rights of Renesas Electronics or others.
4. You shall be responsible for determining what licenses are required from any third parties, and obtaining such licenses for the lawful import, export, manufacture, sales, utilization, distribution or other disposal of any products incorporating Renesas Electronics products, if required.
5. You shall not alter, modify, copy, or reverse engineer any Renesas Electronics product, whether in whole or in part. Renesas Electronics disclaims any and all liability for any losses or damages incurred by you or third parties arising from such alteration, modification, copying or reverse engineering.
6. Renesas Electronics products are classified according to the following two quality grades: "Standard" and "High Quality". The intended applications for each Renesas Electronics product depends on the product's quality grade, as indicated below.
 - "Standard": Computers; office equipment; communications equipment; test and measurement equipment; audio and visual equipment; home electronic appliances; machine tools; personal electronic equipment; industrial robots; etc.
 - "High Quality": Transportation equipment (automobiles, trains, ships, etc.); traffic control (traffic lights); large-scale communication equipment; key financial terminal systems; safety control equipment; etc.Unless expressly designated as a high reliability product or a product for harsh environments in a Renesas Electronics data sheet or other Renesas Electronics document, Renesas Electronics products are not intended or authorized for use in products or systems that may pose a direct threat to human life or bodily injury (artificial life support devices or systems; surgical implantations; etc.), or may cause serious property damage (space system; undersea repeaters; nuclear power control systems; aircraft control systems; key plant systems; military equipment; etc.). Renesas Electronics disclaims any and all liability for any damages or losses incurred by you or any third parties arising from the use of any Renesas Electronics product that is inconsistent with any Renesas Electronics data sheet, user's manual or other Renesas Electronics document.
7. No semiconductor product is absolutely secure. Notwithstanding any security measures or features that may be implemented in Renesas Electronics hardware or software products, Renesas Electronics shall have absolutely no liability arising out of any vulnerability or security breach, including but not limited to any unauthorized access to or use of a Renesas Electronics product or a system that uses a Renesas Electronics product. RENESAS ELECTRONICS DOES NOT WARRANT OR GUARANTEE THAT RENESAS ELECTRONICS PRODUCTS, OR ANY SYSTEMS CREATED USING RENESAS ELECTRONICS PRODUCTS WILL BE INVULNERABLE OR FREE FROM CORRUPTION, ATTACK, VIRUSES, INTERFERENCE, HACKING, DATA LOSS OR THEFT, OR OTHER SECURITY INTRUSION ("Vulnerability Issues"). RENESAS ELECTRONICS DISCLAIMS ANY AND ALL RESPONSIBILITY OR LIABILITY ARISING FROM OR RELATED TO ANY VULNERABILITY ISSUES. FURTHERMORE, TO THE EXTENT PERMITTED BY APPLICABLE LAW, RENESAS ELECTRONICS DISCLAIMS ANY AND ALL WARRANTIES, EXPRESS OR IMPLIED, WITH RESPECT TO THIS DOCUMENT AND ANY RELATED OR ACCOMPANYING SOFTWARE OR HARDWARE, INCLUDING BUT NOT LIMITED TO THE IMPLIED WARRANTIES OF MERCHANTABILITY, OR FITNESS FOR A PARTICULAR PURPOSE.
8. When using Renesas Electronics products, refer to the latest product information (data sheets, user's manuals, application notes, "General Notes for Handling and Using Semiconductor Devices" in the reliability handbook, etc.), and ensure that usage conditions are within the ranges specified by Renesas Electronics with respect to maximum ratings, operating power supply voltage range, heat dissipation characteristics, installation, etc. Renesas Electronics disclaims any and all liability for any malfunctions, failure or accident arising out of the use of Renesas Electronics products outside of such specified ranges.
9. Although Renesas Electronics endeavors to improve the quality and reliability of Renesas Electronics products, semiconductor products have specific characteristics, such as the occurrence of failure at a certain rate and malfunctions under certain use conditions. Unless designated as a high reliability product or a product for harsh environments in a Renesas Electronics data sheet or other Renesas Electronics document, Renesas Electronics products are not subject to radiation resistance design. You are responsible for implementing safety measures to guard against the possibility of bodily injury, injury or damage caused by fire, and/or danger to the public in the event of a failure or malfunction of Renesas Electronics products, such as safety design for hardware and software, including but not limited to redundancy, fire control and malfunction prevention, appropriate treatment for aging degradation or any other appropriate measures. Because the evaluation of microcomputer software alone is very difficult and impractical, you are responsible for evaluating the safety of the final products or systems manufactured by you.
10. Please contact a Renesas Electronics sales office for details as to environmental matters such as the environmental compatibility of each Renesas Electronics product. You are responsible for carefully and sufficiently investigating applicable laws and regulations that regulate the inclusion or use of controlled substances, including without limitation, the EU RoHS Directive, and using Renesas Electronics products in compliance with all these applicable laws and regulations. Renesas Electronics disclaims any and all liability for damages or losses occurring as a result of your noncompliance with applicable laws and regulations.
11. Renesas Electronics products and technologies shall not be used for or incorporated into any products or systems whose manufacture, use, or sale is prohibited under any applicable domestic or foreign laws or regulations. You shall comply with any applicable export control laws and regulations promulgated and administered by the governments of any countries asserting jurisdiction over the parties or transactions.
12. It is the responsibility of the buyer or distributor of Renesas Electronics products, or any other party who distributes, disposes of, or otherwise sells or transfers the product to a third party, to notify such third party in advance of the contents and conditions set forth in this document.
13. This document shall not be reprinted, reproduced or duplicated in any form, in whole or in part, without prior written consent of Renesas Electronics.
14. Please contact a Renesas Electronics sales office if you have any questions regarding the information contained in this document or Renesas Electronics products.

(Note1) "Renesas Electronics" as used in this document means Renesas Electronics Corporation and also includes its directly or indirectly controlled subsidiaries.

(Note2) "Renesas Electronics product(s)" means any product developed or manufactured by or for Renesas Electronics.

(Rev.5.0-1 October 2020)

Corporate Headquarters

TOYOSU FORESIA, 3-2-24 Toyosu,
Koto-ku, Tokyo 135-0061, Japan

www.renesas.com

Trademarks

Renesas and the Renesas logo are trademarks of Renesas Electronics Corporation. All trademarks and registered trademarks are the property of their respective owners.

Contact information

For further information on a product, technology, the most up-to-date version of a document, or your nearest sales office, please visit:

www.renesas.com/contact/.