

RX23W Group

Testing for Certification of Compliance with the Radio Law (Japan)

Introduction

This application note describes testing for certification of compliance with the Radio Law in Japan.

Target Device

RX23W Group

Note: Descriptions in this application note are examples for reference and actual procedures will differ with the system configuration and certification body. In addition, confirm the latest information on test standards and so on. This application note is created on the basis of available information as of October in 2019.

Contents

1. Overview.....	2
1.1 Related Documents.....	2
2. Preparing an Application	3
2.1 The Preparatory Examination.....	3
2.2 Drawing up the Application Forms	4
2.2.1 Application form for test certification	4
2.2.2 Type specifications.....	6
2.2.3 Block diagram of radio equipment.....	7
2.2.4 Photographs or drawings showing the component layout	8
2.2.5 Dimensions and outline drawing of shape showing that it cannot be opened easily	9
2.2.6 Other documents.....	10
3. Operations Involved in Testing	11
3.1 CW (non-modulated continuous wave) Transmission.....	12
3.2 Continuous Transmission of a Pseudo-Random Bit Sequence	13
3.3 Reception	14
3.4 Scanning.....	15
3.4.1 Execute Advertising.....	15
3.4.2 Execute Scanning	16
Revision History	17

The *Bluetooth*[®] word mark and logos are registered trademarks owned by Bluetooth SIG, Inc. and any use of such marks by Renesas Electronics Corporation is under license. Other trademarks and registered trademarks are the property of their respective owners.

1. Overview

This application note describes how to prepare an application for obtaining certification of compliance with the Radio Law in Japan and the operations involved in testing.

1.1 Related Documents

Please refer to the following documents related to this application note.

- RX23W Group User's Manual: Hardware (R01UH0823)
- RX23W Group Bluetooth Test Tool Suite operating instructions (R01AN4554)

2. Preparing an Application

To make an application, carry out a preparatory examination and draw up the application forms.

2.1 The Preparatory Examination

Examine the frequency variation in continuous non-modulated transmission. Also examine the occupied bandwidths with and without spectrum spreading, the intensity of spurious or unwanted emissions, the variation of antenna power in the continuous transmission of a pseudo-random bit sequence, and the intensity of radio fields such as secondarily generated radio waves in reception. After that, confirm that the device is in conformity with the ARIB STD-T66 standard.

For a testing method, refer to TELEC-T401, a characteristics testing method for radio equipment for use in radio systems for low-power data communications using radio waves with frequency in the range from 2,400 MHz to 2,483.5 MHz (2.4-GHz-band advanced low-power data communications systems).

Items to be confirmed are listed below. All samples are tested around three frequencies: 2,402, 2,440, and 2,480 MHz on each LE 1M PHY and LE 2M PHY. For the operations involved in testing, refer to "3. Operations Involved in Testing".

Table 2-1. The preparatory examination confirmation items

Declared antenna power: x.xx mW
OBW: 1.5 MHz

Item		Unit	Judge		Sample 1 (MHz)			Remarks
			Lower	Upper	2402	2440	2480	
Carrier Frequency	Frequency	MHz						
	Difference	ppm	-50.00	50.00				
Occupied Bandwidth	Lower	MHz						
	Upper	MHz						
	Bandwidth	MHz		26.00				
Carrier Power	Antenna power	mW						Difference from declared power of the antenna
	Difference	%	-80.0	20.0				
Unwanted Emission (2374 to 2509.5 MHz (except for 2387 to 2496.5 MHz))		MHz						
		uW/MHz		2.50				
Unwanted Emission (2387 to 2496.5 MHz (except for 2400 to 2483.5 MHz))		MHz						
		uW/MHz		25.00				
Unwanted Emission (30 to 2374 MHz)		MHz						
		uW/MHz		2.50				
Unwanted Emission (2509.5 to 12500 MHz)		MHz						
		uW/MHz		2.50				
Radiation (30 to 1000 MHz)		MHz						
		nW		4.00				
Radiation (1000 to 12500 MHz)		MHz						
		nW		20.00				

2.2 Drawing up the Application Forms

Draw up the application forms listed below. Use the forms prescribed by the respective certification bodies.

- Application form for test certification
- Type specifications
- Block diagram of radio equipment
- Photographs or drawings showing the component layout
- Dimensions and outline drawing of shape showing that it cannot be opened easily

2.2.1 Application form for test certification

Obtain the Application form for test certification from the certification body. A description example is shown below.

Table 2-2. A description example of application form for test certification

Application form for Test Certification		
To: Telecom Engineering Center	Date of application:	
(Applicant's)	Zip code: Address: Corporation name: Representative, position: Responsible person, division: (Seal or signature)	
I delegate the authority on this application procedure to the following proxy. (*1)		
(Proxy's)	Zip code: Address: Corporation name: Person's name, position: (Seal or signature)	
I hereby apply for certification of equipment with the attached construction type, under the provisions of Article 38-6 of the Radio Act, in accordance with the General Contractual Conditions on Technical Regulations Conformity Certification and Type Certification.		
Classification of application	New (<input checked="" type="checkbox"/>) Simplified (<input type="checkbox"/>)	
Category of specified radio equipment	Radio equipment under Article 2 Paragraph (1) Item(19) of Certification Ordinance	
Type or name of radio equipment	XXXXXXXXXX	
Name of equipment manufacturer	XXXXXXXXXXXXXXXXXX	
Serial number	XXXXXXXXXX	
Number of units applied	XX	
Emission modes, frequencies and antenna power to be certified	Radio wave format: F1D Frequency: 2402 to 2480 MHz (2 MHz interval 40 waves) Antenna power: 0.00XXXW (*A)	
Connection to telecommunication link	Yes (<input type="checkbox"/>) No (<input checked="" type="checkbox"/>)	
Submission of radio equipment	Yes (<input checked="" type="checkbox"/>) No (<input type="checkbox"/>)	
Submission of characteristic test report	Yes (<input type="checkbox"/>) No (<input checked="" type="checkbox"/>)	
Article 14-2 Paragraph 1 of the Ordinance Regulating Radio Equipment applied	Yes (<input type="checkbox"/>) No (<input checked="" type="checkbox"/>)	
In case of simplified application (*2)	Changes in construction design	Yes (<input type="checkbox"/>) No (<input type="checkbox"/>)
	Certification number	

	Difference from certified Radio equipment	(Attached sheet)
Contact address	Zip code, address	
	Division name	
	Name of person	
	Telephone number	
	e-mail or facsimile	
Remarks		

Notes:

1. Filling in the blanks marked by (*1) is not required in case of no proxy.
2. Filling in the blanks marked by (*2) is not required in case of new application.

Notes: A. Please apply for an antenna power allowable deviation within the range of + 20% to -80%.

2.2.2 Type specifications

Please obtain the type specifications from the certification body. The form is "No. 3", and the target radio equipment is "Type Specifications of radio equipment used for citizen's band radio stations, cordless telephone radio stations, specified low-power radio stations, radio stations for low-power security systems, radio stations for low-power data communications systems, digital cordless telephone radio stations, PHS land mobile stations, narrow-area communications system land mobile stations, and land mobile stations of 5 GHz band wireless access system, land mobile stations of a narrow-area communications system., and radio station of an Ultra-wide band wireless system". A description example of the type specifications document is shown below.

Table 2-3. A description example of type specifications

Type Specifications				
1 Communication Method		Simplex		
2 Transmitter	(1) Rated Output	0.00XXX W (*1)	(2) Type and Frequency Range of Transmittable Radio Wave	F1D 2402 to 2480 MHz (2-MHz intervals, 40 waves)
	(3) Oscillation	Synthesizer method with frequency of oscillation controlled by a crystal resonator Reference frequency: 32 MHz		
	(4) Modulation	F1D GFSK 1Mbps, 2Mbps		
3 Manufacturer Information		Name of Manufacturer	Model Type or Name	Serial Number
		XXXXXXXXXX	XXXXXXXXXX	XXXXXXXXXX
4 Antenna		(1) Type and Structure		(2) Gain
		λ/4-type Monopole type (H) Chip antenna (*2)		+2.3 dBi (*2)
5 Classification and Model Type or Name of Auxiliary Equipment		The function specified in Article 9-4-8 of the Radio Equipment Regulations Controller: PC with USB I / F (Connect using USB cable) (*3)		
6 Other Type Specifications Items		Conformance with technical standards stipulated in Chapter 3 of the Radio Law No connection with public lines Specific radio equipment of the module type		
7 Attached Drawing		Block diagram of radio equipment		
8 Reference Information		Model Type or Name of Radio Equipment: XXXXXXXXX Antenna impedance: 50Ω Rated power supply voltage: DC5.0V The main part of the modulation part and the radio part is mounted on an integrated circuit in a BGA (85) package with a pin spacing of 0.5 mm, and is soldered to the board by surface mounting technology, so that it cannot be opened easily. (*4)		

- Notes: 1. In making an application, report a value such that any change from that given will be within the range from +20% to -80%.
 2. Write the format, configuration, and gain that match the data sheet characteristics.
 3. Describe the methods of operation in the examinations.
 4. Describe the explanation that "High-frequency part and modulation part cannot be opened easily".

2.2.3 Block diagram of radio equipment

The following is an example. Create it accord with the actual system.

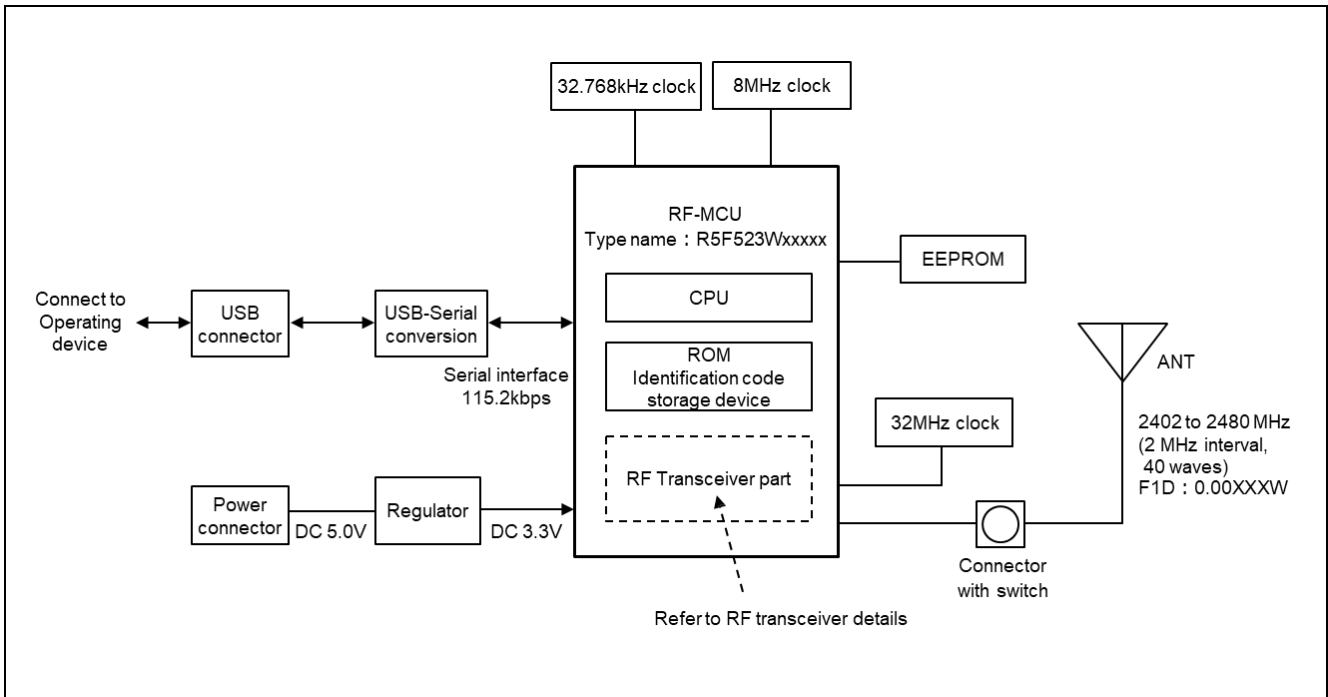

Figure 2-1. Block diagram of radio equipment (Example)

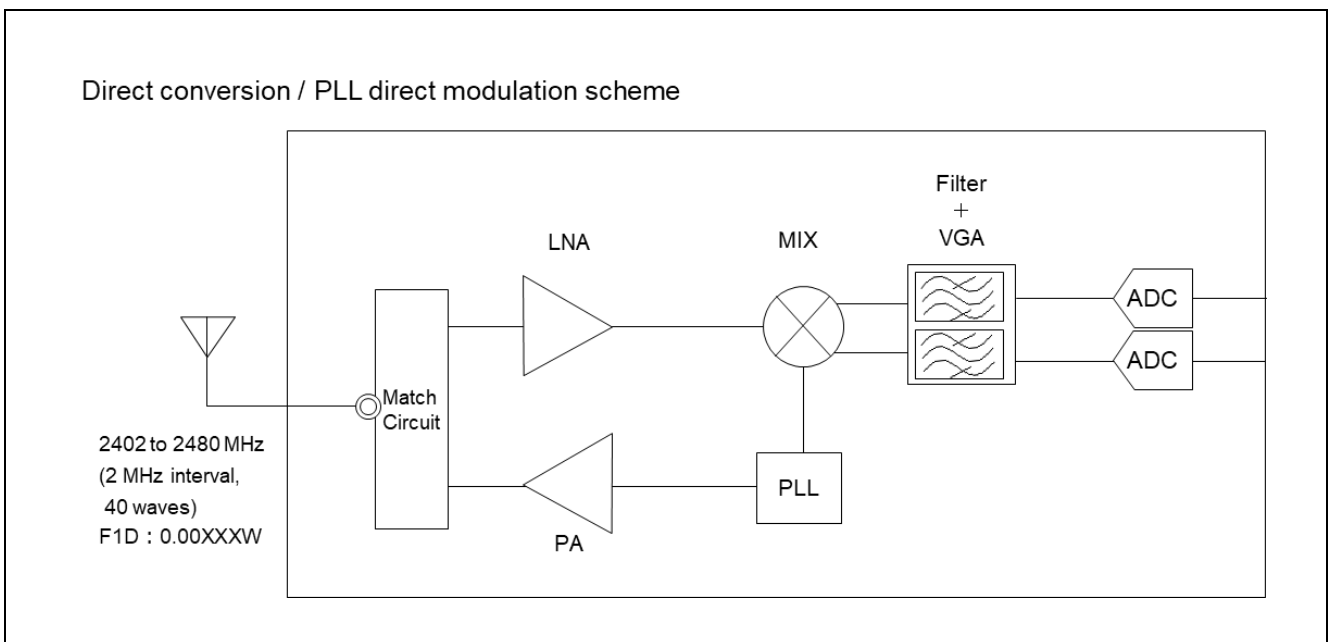

Figure 2-2. Block diagram of radio equipment — RF transceiver details (Example)

2.2.4 Photographs or drawings showing the component layout

The following is an example. Create it accord with the actual system.

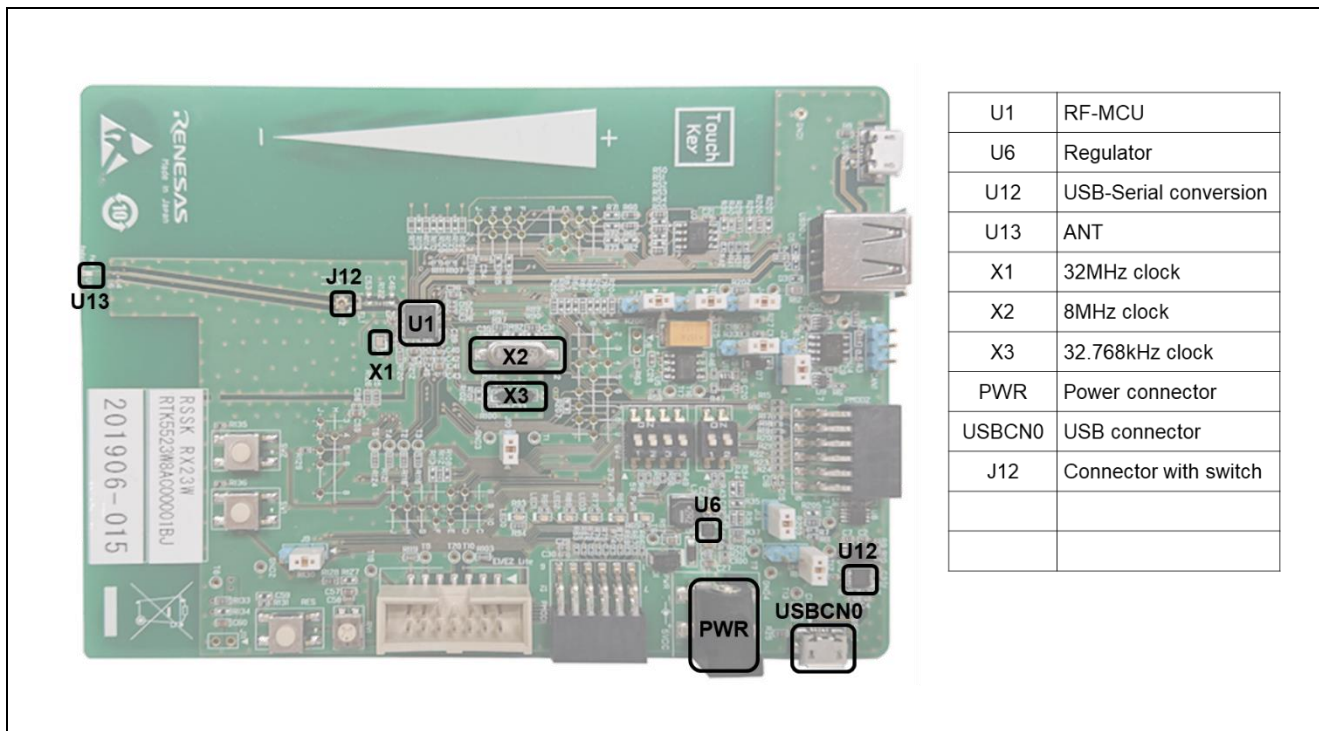

Figure 2-3. Photographs or drawings showing the component layout (Example)

2.2.5 Dimensions and outline drawing of shape showing that it cannot be opened easily

This is an example of drawing showing outlines the structure and shape of the radio equipment regarding "the high-frequency part and modulation part cannot be opened easily". Create it accord with the actual system.

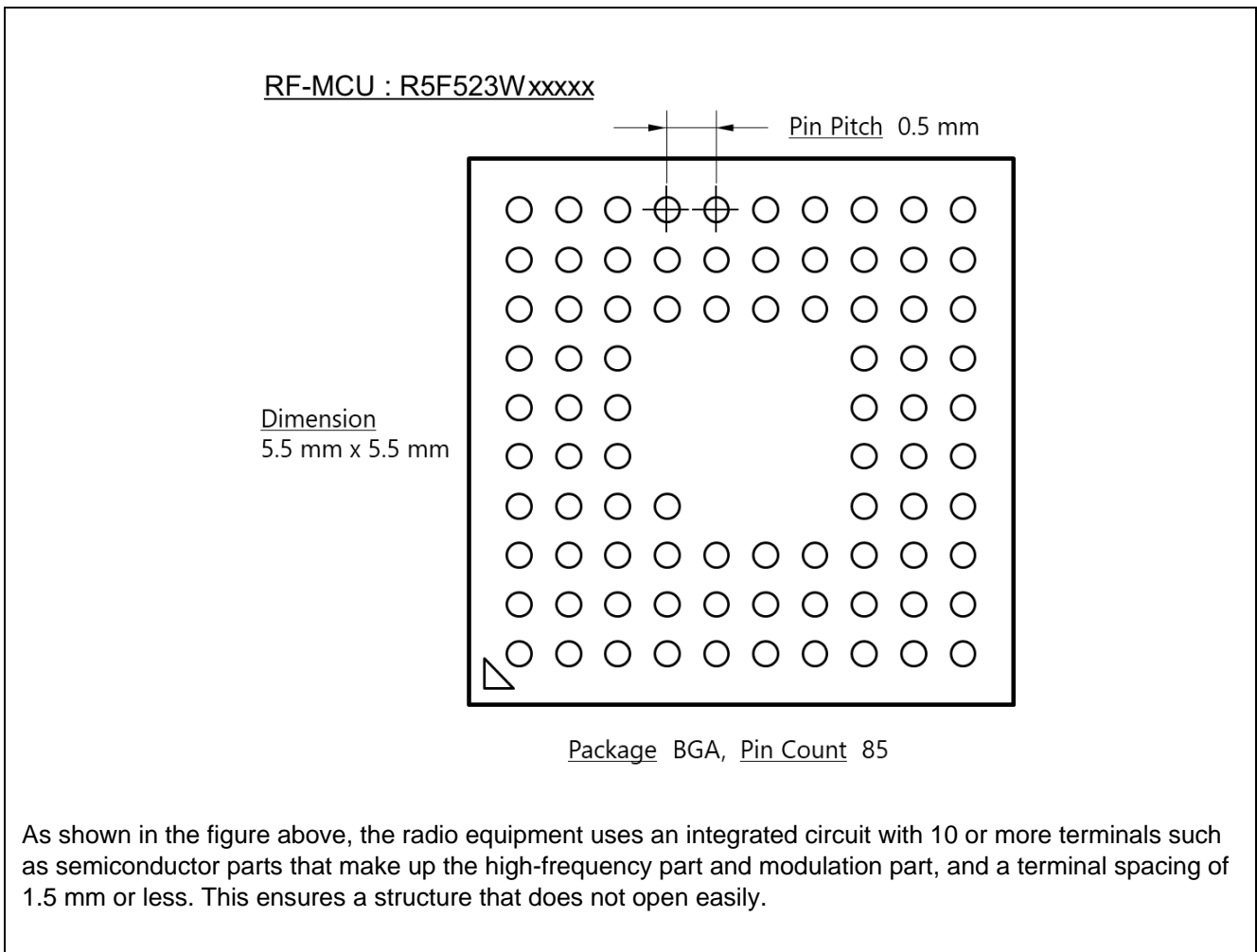

Figure 2-4. Dimensions and outline drawing of shape (Example)

2.2.6 Other documents

If the certification body requests the submission of the following documents, prepare according to the instructions of the certification body.

2.2.6.1 Document about antenna

Prepare the data (data sheet) that provides the basis for gain, such as shape, dimensions, and measurement results.

2.2.6.2 Correspondence table of manufacturing numbers and identification codes

Create a correspondence table between the manufacturing number and identification code of the application product. A description example is shown below.

Table 2-4. Correspondence table of manufacturing numbers and identification codes (Example)

Manufacturing numbers	Identification codes
ABC 0021	xx-xx-xx-xx-xx- A0
ABC 0022	xx-xx-xx-xx-xx- A1
ABC 0023	xx-xx-xx-xx-xx- A2
ABC 0024	xx-xx-xx-xx-xx- A3
ABC 0025	xx-xx-xx-xx-xx- A4
ABC 0026	xx-xx-xx-xx-xx- A5
ABC 0027	xx-xx-xx-xx-xx- A6
ABC 0028	xx-xx-xx-xx-xx- A7
ABC 0029	xx-xx-xx-xx-xx- A8
ABC 0030	xx-xx-xx-xx-xx- A9
ABC 0031	xx-xx-xx-xx-xx- AA
ABC 0032	xx-xx-xx-xx-xx- AB
ABC 0033	xx-xx-xx-xx-xx- AC
ABC 0034	xx-xx-xx-xx-xx- AD
ABC 0035	xx-xx-xx-xx-xx- AE
ABC 0036	xx-xx-xx-xx-xx- AF
ABC 0037	xx-xx-xx-xx-xx- B0
ABC 0038	xx-xx-xx-xx-xx- B1
ABC 0039	xx-xx-xx-xx-xx- B2
ABC 0040	xx-xx-xx-xx-xx- B3
ABC 0041	xx-xx-xx-xx-xx- B4
ABC 0042	xx-xx-xx-xx-xx- B5
ABC 0043	xx-xx-xx-xx-xx- B6
ABC 0044	xx-xx-xx-xx-xx- B7
ABC 0045	xx-xx-xx-xx-xx- B8

2.2.6.3 Photograph or figure showing appearance







Prepare an appearance diagram that shows the dimensions and elsewhere of the application product.

3. Operations Involved in Testing

Use the SMA connector to connect the device under test to the measuring instrument of the certification body. Make sure that the SMA connector can be connected from the end of the antenna.

Table 3-1 describes the test items, the execution operations of the device under test (hereinafter DUT), and the Bluetooth Test Tool Suite (hereinafter BTTS) tools to use.

Table 3-1. The test items, the execution operations of the DUT, and the BTTS tools to use

Test item	Execution operation	BTTS tool
Frequency variation	3.1 CW (non-modulated continuous wave) Transmission	RF Evaluation tool 
Occupied bandwidth with and without spectrum spreading	3.2 Continuous Transmission of a Pseudo-Random Bit Sequence	RF Evaluation tool 
Intensity of spurious or unwanted emission	3.2 Continuous Transmission of a Pseudo-Random Bit Sequence	RF Evaluation tool 
Variation of antenna power	3.2 Continuous Transmission of a Pseudo-Random Bit Sequence	RF Evaluation tool 
Intensity of radio fields such as secondarily generated radio waves	3.3 Reception	RF Evaluation tool 
Functions for preventing interference (between identifying codes)	3.4 Scanning (*1)	Beacon tool  

*1 : Confirming the BD address of the opposite device (Opposing device performs advertising)

Notes: When using the BTTS in certification tests, refer to the following contents in the "RX23W Group Bluetooth Test Tool Suite operating instructions (R01AN4554)" (hereinafter, "Operating instructions").

1. Overview
Describes the features and operating environment of BTTS.
2. Installation
Describes the contents and installation procedure of the BTTS package.
3. Common operation
Describes how to start the tool and how to connect to the target device.
- 6.2.3 Filter settings
Describes how to set the filter to make it easier to detect the target device.

3.1 CW (non-modulated continuous wave) Transmission

1. Select "RF Evaluation" in the tool launcher to start the RF evaluation tool. Connect the DUT according to the procedure described in the Operating instructions.
2. Click the "Transmit Test" of the upper part tab and select the "Continuous Wave Transmit" radio button.
3. Select the non-modulated wave "Modulation Disable" with the pull-down menu below the radio button.
4. Select "Middle" as the transmission power with the "Transmit Power" pull-down menu.
5. Select "1M" or "2M" as the transmission PHY with the "PHY" pull-down menu.
6. Select the transmission frequency channel with the "Transmit Frequency" pull-down menu.
Low: 2402MHz (RF-Ch.00), Middle: 2440MHz (RF-Ch.19), High: 2480MHz (RF-Ch.39)
7. Click the "▶START" button to start CW transmission.
8. Click the "■STOP" button to stop transmission.
To change the PHY, perform steps 5 through 8. To change the frequency, perform steps 6 through 8.

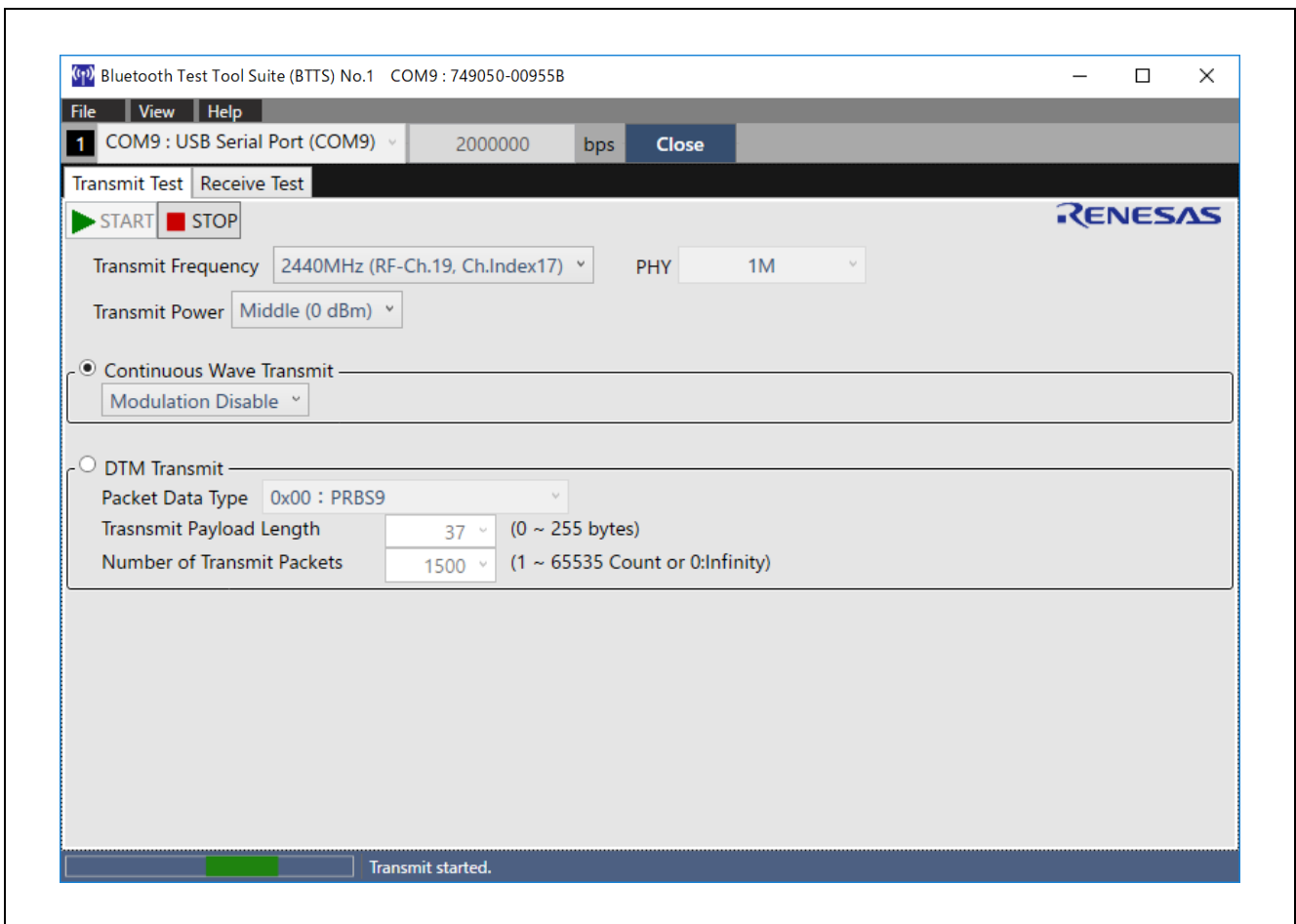

Figure 3-1. CW transmission settings

3.2 Continuous Transmission of a Pseudo-Random Bit Sequence

1. Select "RF Evaluation" in the tool launcher to start the RF evaluation tool. Connect the DUT according to the procedure described in the Operating instructions.
2. Click the "Transmit Test" of the upper part tab and select the "DTM Transmit" radio button.
3. Select the pseudo-random number "0x00: PRBS9" (pseudo-random bit sequence with period 2^9-1) with the pull-down menu below the radio button.
Select "0" (Infinity) with the "Number of Transmit Packets" pull-down menu.
4. Select "Middle" as the transmission power with the "Transmit Power" pull-down menu.
Select "Low" or "High" when performing the "Antenna Power Deviation" test.
5. Select "1M" or "2M" as the transmission PHY with the "PHY" pull-down menu.
6. Select the transmission frequency channel with the "Transmit Frequency" pull-down menu.
Low: 2402MHz (RF-Ch.00), Middle: 2440MHz (RF-Ch.19), High: 2480MHz (RF-Ch.39)
7. Click the "▶START" button to start continuous transmission of pseudo-random numbers.
8. Click the "■STOP" button to stop continuous transmission.
To change the PHY, perform steps 5 through 8. To change the frequency, perform steps 6 through 8.

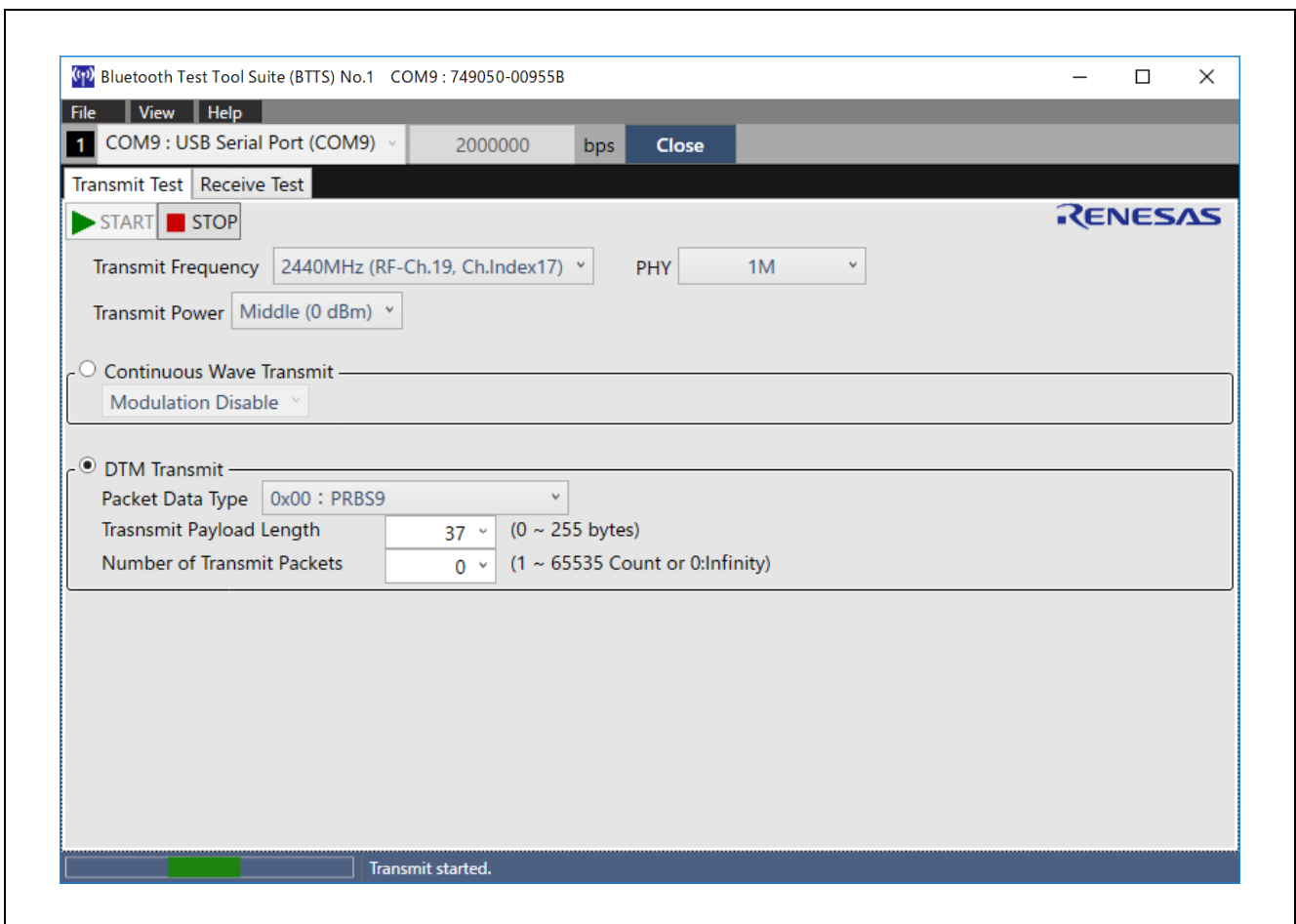

Figure 3-2. Pseudo random number continuous transmission setting

3.3 Reception

1. Select "RF Evaluation" in the tool launcher to start the RF evaluation tool. Connect the DUT according to the procedure described in the Operating instructions.
2. Click the "Receive Test".
3. Select "0" (Infinity) with the "Expected Packet Counts" pull-down menu.
4. Select "1M" or "2M" as the receive PHY with the "PHY" pull-down menu.
5. Select the receive frequency channel with the "Receive Frequency" pull-down menu.
Low: 2402MHz (RF-Ch.00), Middle: 2440MHz (RF-Ch.19), High: 2480MHz (RF-Ch.39)
6. Click the "▶START" button to start receiving operation.
7. Click the "■STOP" button to stop receiving operation.
To change the PHY, perform steps 4 through 7. To change the frequency, perform steps 5 through 7.

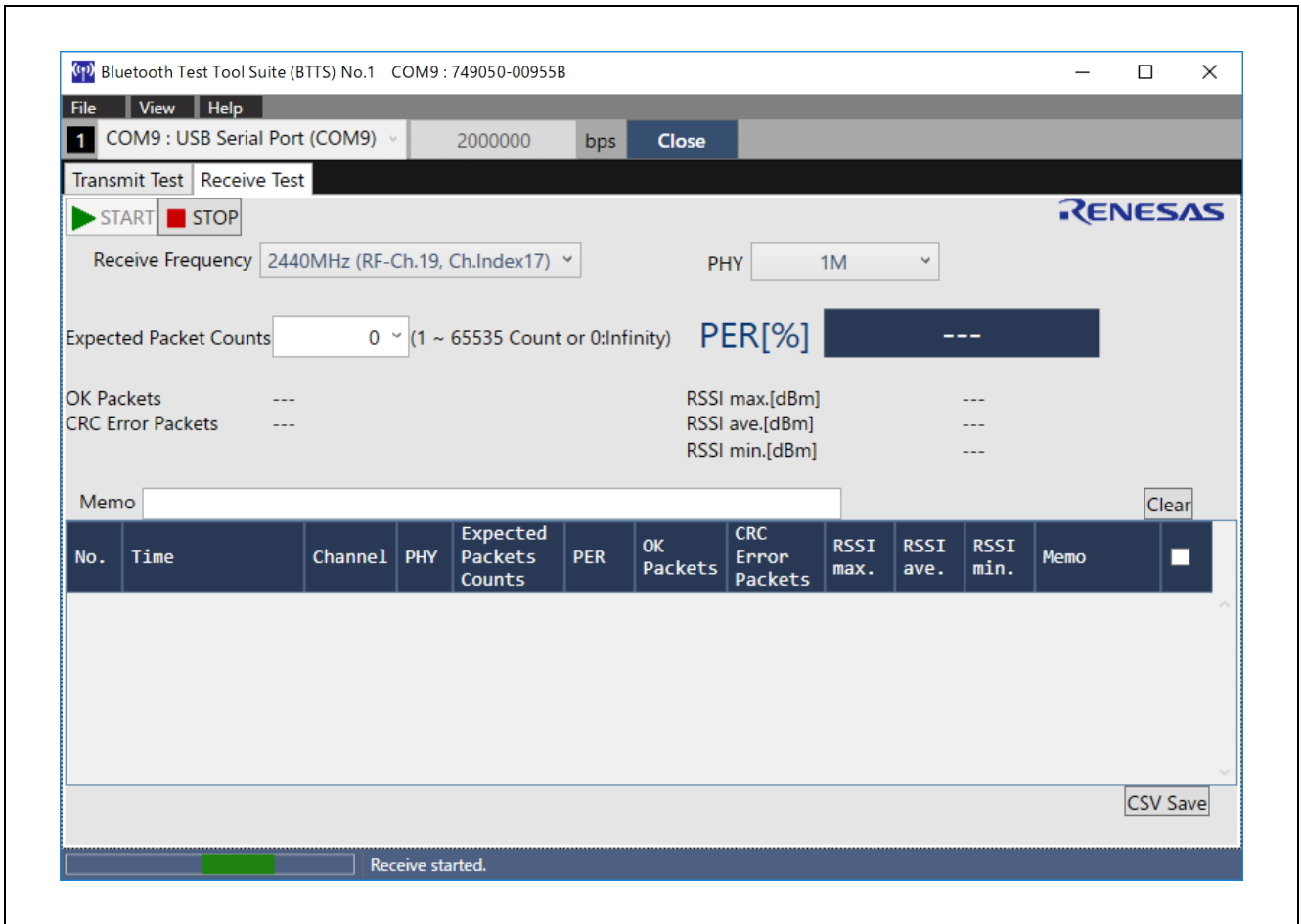

Figure 3-3. Receive operation setting

3.4 Scanning

3.4.1 Execute Advertising

To perform scanning on the receiving device side, first execute advertising on the opposite device side.

1. Select "Beacon Advertising" in the tool launcher to start the beacon advertising tool. Connect the DUT according to the procedure described in the Operating instructions.
2. Check the checkbox on the "Handle #0" tab at the top.
3. Check the "Public" radio button in the "Advertising Address" frame.
4. Enter "0000A0" in the "Advertising Interval" text box and set the advertising interval to 100 msec. (Can be changed to any interval)
5. Check the "Legacy" radio button in the "Data Packet Length" frame.
6. Check the checkbox for all channels in "Advertising Channel".
7. Select "Local Name" from the "Advertising Data" pull-down menu, and enter an arbitrary device name in the text box.
8. Click the "▶START" button to start advertising.
9. After the test is complete, click the "■STOP" button to stop advertising.

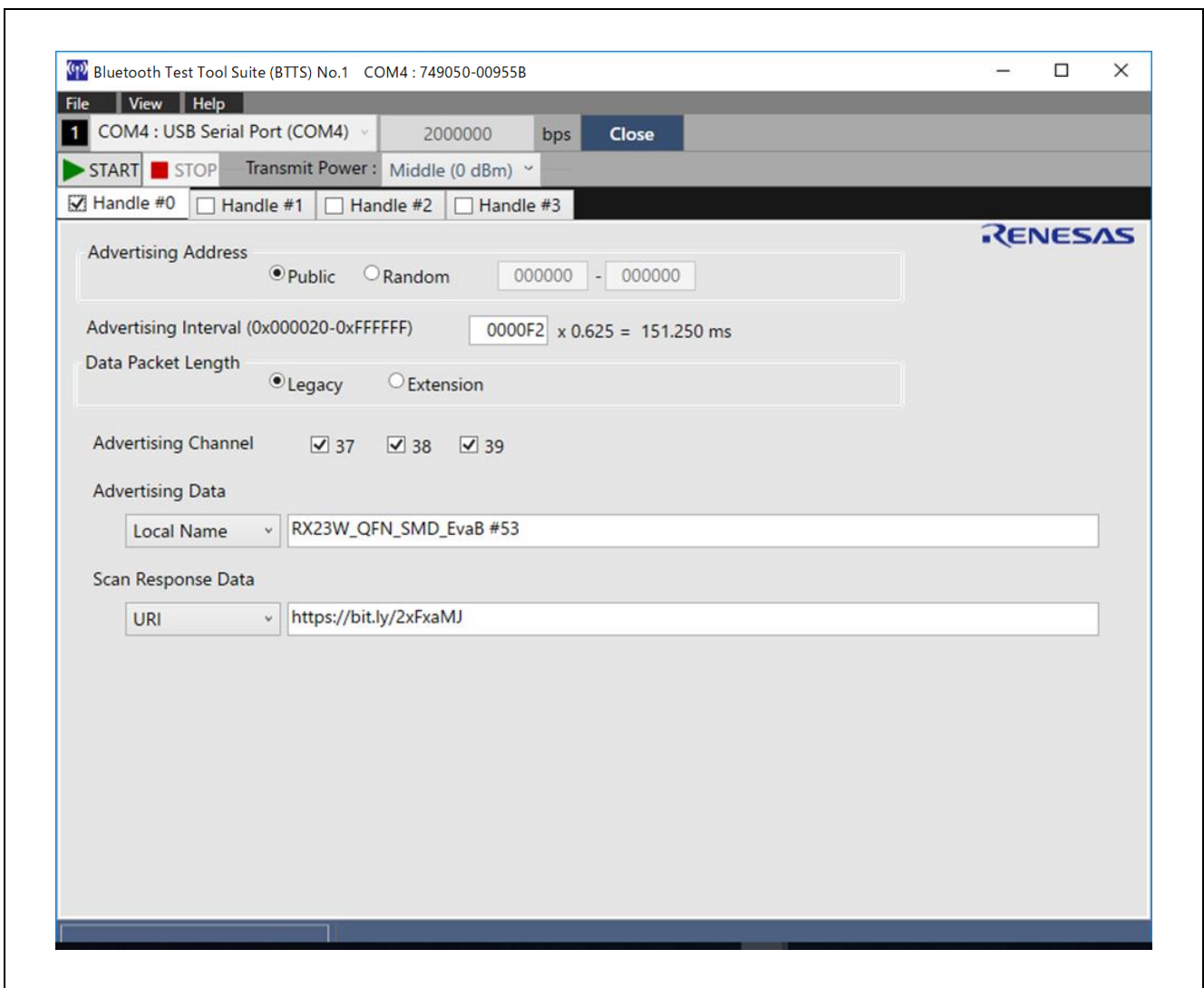

Figure 3-4. Advertising setting (opposite device side)

3.4.2 Execute Scanning

The receiving device side performs scanning.

1. Select "Beacon Scanning" in the tool launcher to start the beacon scanning tool. Connect the DUT according to the procedure described in the Operating instructions.
2. Check the "Passive" radio button in the "Scanning Mode" frame.
3. Check the "Normal Range (1M PHY)" check button.
4. Enter "0640" in the "Interval" text box and "0640" in the "Window" text box to set the scanning duty cycle to 100%. (Can be changed to any value)
5. Depending on the environment of the surrounding advertiser, enable the filter function according to the procedure described in the Operating instructions.
6. Click the "▶START" button to start scanning.
7. Confirm that the information of the opposite device is displayed in the "Scanning Result:" data grid.
8. After the test is complete, click the "■STOP" button to stop scanning.

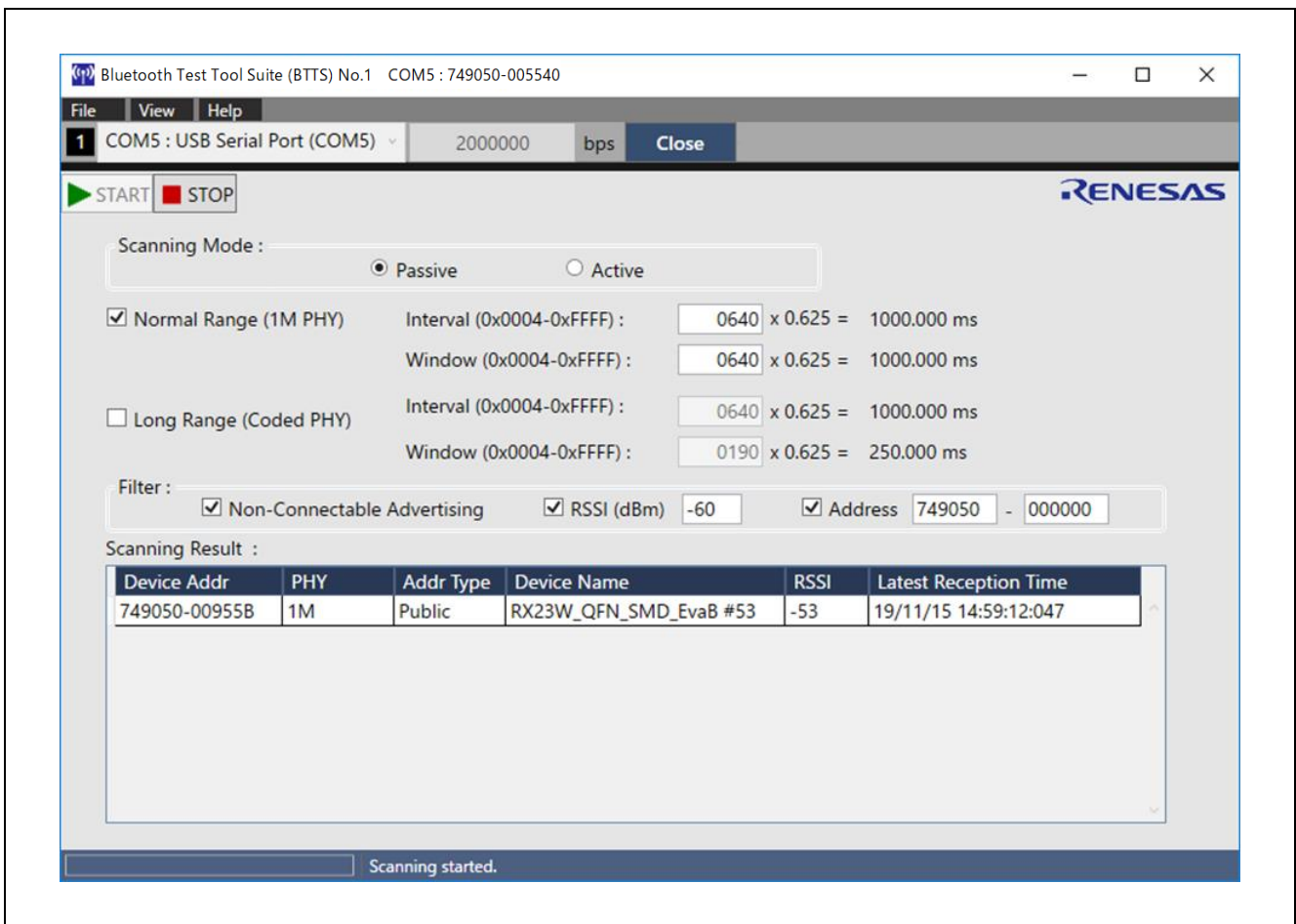

Figure 3-5. Scanning setting (receiving device side)

Revision History

Rev.	Date	Description	
		Page	Summary
1.00	Nov.15.19	—	First edition issued
1.01	Jan,30.20	2, 11 12 - 16	Tool name change (text) Bluetooth Trial Tool Suite → Bluetooth Test Tool Suite Tool name change (Figure) Figure 3-1, Figure 3-2, Figure 3-3, Figure 3-4, Figure 3-5

General Precautions in the Handling of Microprocessing Unit and Microcontroller Unit Products

The following usage notes are applicable to all Microprocessing unit and Microcontroller unit products from Renesas. For detailed usage notes on the products covered by this document, refer to the relevant sections of the document as well as any technical updates that have been issued for the products.

1. Precaution against Electrostatic Discharge (ESD)

A strong electrical field, when exposed to a CMOS device, can cause destruction of the gate oxide and ultimately degrade the device operation. Steps must be taken to stop the generation of static electricity as much as possible, and quickly dissipate it when it occurs. Environmental control must be adequate. When it is dry, a humidifier should be used. This is recommended to avoid using insulators that can easily build up static electricity.

Semiconductor devices must be stored and transported in an anti-static container, static shielding bag or conductive material. All test and measurement tools including work benches and floors must be grounded. The operator must also be grounded using a wrist strap. Semiconductor devices must not be touched with bare hands. Similar precautions must be taken for printed circuit boards with mounted semiconductor devices.

2. Processing at power-on

The state of the product is undefined at the time when power is supplied. The states of internal circuits in the LSI are indeterminate and the states of register settings and pins are undefined at the time when power is supplied. In a finished product where the reset signal is applied to the external reset pin, the states of pins are not guaranteed from the time when power is supplied until the reset process is completed. In a similar way, the states of pins in a product that is reset by an on-chip power-on reset function are not guaranteed from the time when power is supplied until the power reaches the level at which resetting is specified.

3. Input of signal during power-off state

Do not input signals or an I/O pull-up power supply while the device is powered off. The current injection that results from input of such a signal or I/O pull-up power supply may cause malfunction and the abnormal current that passes in the device at this time may cause degradation of internal elements. Follow the guideline for input signal during power-off state as described in your product documentation.

4. Handling of unused pins

Handle unused pins in accordance with the directions given under handling of unused pins in the manual. The input pins of CMOS products are generally in the high-impedance state. In operation with an unused pin in the open-circuit state, extra electromagnetic noise is induced in the vicinity of the LSI, an associated shoot-through current flows internally, and malfunctions occur due to the false recognition of the pin state as an input signal become possible.

5. Clock signals

After applying a reset, only release the reset line after the operating clock signal becomes stable. When switching the clock signal during program execution, wait until the target clock signal is stabilized. When the clock signal is generated with an external resonator or from an external oscillator during a reset, ensure that the reset line is only released after full stabilization of the clock signal. Additionally, when switching to a clock signal produced with an external resonator or by an external oscillator while program execution is in progress, wait until the target clock signal is stable.

6. Voltage application waveform at input pin

Waveform distortion due to input noise or a reflected wave may cause malfunction. If the input of the CMOS device stays in the area between V_{IL} (Max.) and V_{IH} (Min.) due to noise, for example, the device may malfunction. Take care to prevent chattering noise from entering the device when the input level is fixed, and also in the transition period when the input level passes through the area between V_{IL} (Max.) and V_{IH} (Min.).

7. Prohibition of access to reserved addresses

Access to reserved addresses is prohibited. The reserved addresses are provided for possible future expansion of functions. Do not access these addresses as the correct operation of the LSI is not guaranteed.

8. Differences between products

Before changing from one product to another, for example to a product with a different part number, confirm that the change will not lead to problems. The characteristics of a microprocessing unit or microcontroller unit products in the same group but having a different part number might differ in terms of internal memory capacity, layout pattern, and other factors, which can affect the ranges of electrical characteristics, such as characteristic values, operating margins, immunity to noise, and amount of radiated noise. When changing to a product with a different part number, implement a system-evaluation test for the given product.

Notice

1. Descriptions of circuits, software and other related information in this document are provided only to illustrate the operation of semiconductor products and application examples. You are fully responsible for the incorporation or any other use of the circuits, software, and information in the design of your product or system. Renesas Electronics disclaims any and all liability for any losses and damages incurred by you or third parties arising from the use of these circuits, software, or information.
 2. Renesas Electronics hereby expressly disclaims any warranties against and liability for infringement or any other claims involving patents, copyrights, or other intellectual property rights of third parties, by or arising from the use of Renesas Electronics products or technical information described in this document, including but not limited to, the product data, drawings, charts, programs, algorithms, and application examples.
 3. No license, express, implied or otherwise, is granted hereby under any patents, copyrights or other intellectual property rights of Renesas Electronics or others.
 4. You shall not alter, modify, copy, or reverse engineer any Renesas Electronics product, whether in whole or in part. Renesas Electronics disclaims any and all liability for any losses or damages incurred by you or third parties arising from such alteration, modification, copying or reverse engineering.
 5. Renesas Electronics products are classified according to the following two quality grades: "Standard" and "High Quality". The intended applications for each Renesas Electronics product depends on the product's quality grade, as indicated below.
 - "Standard": Computers; office equipment; communications equipment; test and measurement equipment; audio and visual equipment; home electronic appliances; machine tools; personal electronic equipment; industrial robots; etc.
 - "High Quality": Transportation equipment (automobiles, trains, ships, etc.); traffic control (traffic lights); large-scale communication equipment; key financial terminal systems; safety control equipment; etc.
- Unless expressly designated as a high reliability product or a product for harsh environments in a Renesas Electronics data sheet or other Renesas Electronics document, Renesas Electronics products are not intended or authorized for use in products or systems that may pose a direct threat to human life or bodily injury (artificial life support devices or systems; surgical implantations; etc.), or may cause serious property damage (space system; undersea repeaters; nuclear power control systems; aircraft control systems; key plant systems; military equipment; etc.). Renesas Electronics disclaims any and all liability for any damages or losses incurred by you or any third parties arising from the use of any Renesas Electronics product that is inconsistent with any Renesas Electronics data sheet, user's manual or other Renesas Electronics document.
6. When using Renesas Electronics products, refer to the latest product information (data sheets, user's manuals, application notes, "General Notes for Handling and Using Semiconductor Devices" in the reliability handbook, etc.), and ensure that usage conditions are within the ranges specified by Renesas Electronics with respect to maximum ratings, operating power supply voltage range, heat dissipation characteristics, installation, etc. Renesas Electronics disclaims any and all liability for any malfunctions, failure or accident arising out of the use of Renesas Electronics products outside of such specified ranges.
 7. Although Renesas Electronics endeavors to improve the quality and reliability of Renesas Electronics products, semiconductor products have specific characteristics, such as the occurrence of failure at a certain rate and malfunctions under certain use conditions. Unless designated as a high reliability product or a product for harsh environments in a Renesas Electronics data sheet or other Renesas Electronics document, Renesas Electronics products are not subject to radiation resistance design. You are responsible for implementing safety measures to guard against the possibility of bodily injury, injury or damage caused by fire, and/or danger to the public in the event of a failure or malfunction of Renesas Electronics products, such as safety design for hardware and software, including but not limited to redundancy, fire control and malfunction prevention, appropriate treatment for aging degradation or any other appropriate measures. Because the evaluation of microcomputer software alone is very difficult and impractical, you are responsible for evaluating the safety of the final products or systems manufactured by you.
 8. Please contact a Renesas Electronics sales office for details as to environmental matters such as the environmental compatibility of each Renesas Electronics product. You are responsible for carefully and sufficiently investigating applicable laws and regulations that regulate the inclusion or use of controlled substances, including without limitation, the EU RoHS Directive, and using Renesas Electronics products in compliance with all these applicable laws and regulations. Renesas Electronics disclaims any and all liability for damages or losses occurring as a result of your noncompliance with applicable laws and regulations.
 9. Renesas Electronics products and technologies shall not be used for or incorporated into any products or systems whose manufacture, use, or sale is prohibited under any applicable domestic or foreign laws or regulations. You shall comply with any applicable export control laws and regulations promulgated and administered by the governments of any countries asserting jurisdiction over the parties or transactions.
 10. It is the responsibility of the buyer or distributor of Renesas Electronics products, or any other party who distributes, disposes of, or otherwise sells or transfers the product to a third party, to notify such third party in advance of the contents and conditions set forth in this document.
 11. This document shall not be reprinted, reproduced or duplicated in any form, in whole or in part, without prior written consent of Renesas Electronics.
 12. Please contact a Renesas Electronics sales office if you have any questions regarding the information contained in this document or Renesas Electronics products.

(Note1) "Renesas Electronics" as used in this document means Renesas Electronics Corporation and also includes its directly or indirectly controlled subsidiaries.

(Note2) "Renesas Electronics product(s)" means any product developed or manufactured by or for Renesas Electronics.

(Rev.4.0-1 November 2017)

Corporate Headquarters

TOYOSU FORESIA, 3-2-24 Toyosu,
Koto-ku, Tokyo 135-0061, Japan
www.renesas.com

Trademarks

Renesas and the Renesas logo are trademarks of Renesas Electronics Corporation. All trademarks and registered trademarks are the property of their respective owners.

Contact information

For further information on a product, technology, the most up-to-date version of a document, or your nearest sales office, please visit:
www.renesas.com/contact/.