

RL78/G22

Multiwavelength Smoke Detector Reference Design

Introduction

This application note describes a reference design for an ultra-low-power Multiwavelength Smoke Detector using the RL78/G22 microcontroller and an AFE (Analog Front-End IC).

This design targets photoelectric smoke detectors and adopts a multi-LED smoke discrimination technology. By utilizing light of different wavelengths, it enables high-precision smoke detection, reducing false alarms and improving detection performance.

This application note provides a detailed explanation of the system configuration, operating principles, and smoke testing, supporting developers in effectively utilizing this design.

Target Device

RL78/G22

Note: The hardware and sample software for this Multiwavelength Smoke Detector are provided for reference purposes only in development and are not guaranteed by our company as a finalized product. When using the hardware and sample software, please conduct sufficient evaluation in an appropriate environment before use.

Contents

1. Overview.....	1
1.1 Functional Principle of Photoelectric Multiwavelength Smoke Detector	1
1.2 Residential and Commercial Smoke Detector	1
2. Multiwavelength Smoke Detector POC Substrate	2
2.1 Overview of POC Substrate	2
2.2 POC Board Features and Hardware Specifications.....	2
2.3 System Benefits from Renesas Component Integration	3
2.4 Features of Analog Front-End IC RAA23910X	3
3. UL Test Requirements.....	4
3.1 Types of Tests and Criteria	4
3.2 Concept of opacity.....	5
3.2.1 How to measure opacity.....	5
3.2.2 Defining Opacity	5
4. Smoke detection by POC substrate	7
4.1 Photoelectric Detection Method	7
4.2 Transmission ratio	9
4.3 TIA Gain Settings	9
4.4 AD Conversion and Transmission Ratio Calculation	10
5. Smoke Detection Algorithm	11
5.1 Smoke Detection Algorithm and Software Settings	11
5.1.1 Smoke Detection Algorithms.....	11
5.1.2 Setting thresholds for software.....	12
5.2 Test Results.....	13
5.2.1 Smoldering Wood Test.....	13
5.2.2 Cooking Nuisance Test	14
5.2.3 Polyurethane Fire Test.....	16
5.3 Parameter setting	18
6. Register Settings	20
7. Nomenclature	22
8. References	23

1. Overview

This User's Manual (Solution) contains information about the "Multiwavelength Smoke Detector POC (Proof of Concept) board with RL78/G22 microcontroller and AFE (Analog Front-End IC)" and sample software to efficiently create Multiwavelength Smoke Outline of developing detectors.

The hardware and sample software for this Multiwavelength Smoke Detector are for development purposes only, and we do not guarantee that it will work as a product. When using hardware and sample software, please use it after thorough evaluation in an appropriate environment.

Operation check device

The operation of the sample software is checked with the following devices mounted on the Multiwavelength Smoke Detector POC board (hereinafter referred to as the POC board).

- RTK7RL22SMD00000BJ (Multiwavelength Smoke Detector POC Board)
- R7F102GBE2DNP#YJ1 (on-board MCU)
- RAA23910X (on-board AFE)

1.1 Functional Principle of Photoelectric Multiwavelength Smoke Detector

The photoelectric Multiwavelength Smoke Detector consists of an LED (transmitter) that emits light in a case called a smoke chamber and a photodiode (receiver) that detects the light. Air flows through this chamber, and in the event of a fire, smoke will be contained.

The structure of the smoke chamber prevents external light from entering the smoke chamber so as not to interfere with the measurement. Both the transmitting light source (LED) and the receiving photodetector (photodiode) are located at an angle of about 140 degrees, so that the light does not shine directly on the detector in clean or less polluted air. As ambient smoke enters the smoke chamber, the transmitted light is scattered with these smoke particles and received by the detector, which triggers an alarm as a fire alarm if it exceeds the set threshold.

1.2 Residential and Commercial Smoke Detector

The type called Residential Smoke Detector is a dedicated type that is installed in various houses such as homes and apartments. Most of these detectors are streamlined with reliable features and low cost. It is usually battery-powered, has a simple configuration that sounds an alarm on its own, and has limited communication and coordination control functions.

Commercial Smoke Detectors, on the other hand, are more comprehensive in terms of features and operating range. Commercial installations must be able to communicate through wire or wirelessly, with DC power supply voltage (12~48V) or AC power, battery backup, connection to a central control panel (receiver) and control in conjunction with a fire alarm system.

2. Multiwavelength Smoke Detector POC Substrate

2.1 Overview of POC Substrate

The Multiwavelength Smoke Detector can be implemented using only the RL78/G22 microcontroller mounted on the POC board, AFEs, LEDs (transmitters), photodiodes (receivers), and a few external components. The transmitting LEDs are positioned in such a way that the light beam is scattered to the receiver only when there is smoke or dust. This board detects scattered light with infrared IR LEDs (hereinafter referred to as Red LED) and Blue LEDs of different wavelengths, especially for the purpose of recognizing the type of smoke as a multiwavelength type.

2.2 POC Board Features and Hardware Specifications

POC substrates have the following characteristics: The specifications are listed in Table 2-1.

- "OR" type power supply configuration (DC24V~40V main power supply, USB power supply, E2Lite emulator power supply, user serial power supply, main unit debug power supply)
- Compact, low-power, high-performance microcontrollers
- Analog front-end IC provides smoke detection driver and op amp
- Alarm LED (Red) and external notification signal circuit
- User LED (Green)
- User Buttons
- Photoelectric smoke detection of multi-wavelength light using two types of LEDs (IR and Blue)

Table 2-1. POC Board Specifications

No.	Large Items	items	specifications	remarks
1	power supply	Mains power supply	DC24~40V	Current Limit max160uA
2	LED	Infrared (IR) Forward LED	Wavelength 850nm	
3		Blue Forward LED	Wavelength: 470nm	
4		Infrared (IR) Backward LED	Wavelength 850nm	
5	Photodiode	Wideband type	Wavelength: 400~1100nm	
6	alarm	Red LED flashing	Mains power supply 52mA pull-in	
7	size	Notification Signal Generation	75.50mm x 95.50mm x 1.6mm	

2.3 System Benefits from Renesas Component Integration

- The low-power Multiwavelength Smoke Detector analog front-end RAA23910X includes 2xLED drivers, 2xPhotodetector inputs with programmable gain transimpedance amplifiers, ADC+DAC, linear regulator for MCU power supply, 3.3V or 5V operation, and more. Compared to discrete designs, the number of components, board space, and overall system cost are significantly reduced.
- The highly integrated AFE can be used for light detection of different IR wavelengths, greatly improving the accuracy of the Smoke Detector and making it possible to consider a UL217 or UL268 compliant Multiwavelength Smoke Detector system.
- Equipped with an RL78/G22 microcontroller and Data Flash, it is possible to store non-volatile data (alarm counters, operating hour meters, etc.). (The sample software does not have any functions)
- Very few external components required = > lowest BOM and smaller solution size.

2.4 Features of Analog Front-End IC RAA23910X

The highly integrated RAA23910X low-power analog front-end IC contains all the peripherals and features required for a photoelectric smoke detector system that is primarily focused on residential smoke detector design. Therefore, it is easy to realize a electronic circuit for Multiwavelength Smoke Detector with only two main components: MCU + AFE.

- 8-Bit DAC Adjustable Current (45mA~300mA, or 90mA~600mA)
- Photodetector TIA amplifier + PGA (programmable gain up to 160 MV/A)
- 10-bit ADC for photodetector input
- General Purpose I/O - Single-wire TX/RX interface
- LDOs for microcontroller power supplies
- SPI interface

3. UL Test Requirements

3.1 Types of Tests and Criteria

The performance of the Smoke Detector is specified in UL Standards UL217 and UL268. Among them, different criteria are specified for the smoke test of the photoelectric smoke detector depending on the different combustion products and combustion conditions shown in Table 3-1. From UL217 (8th edition) and UL268 (7th edition), cooking disturbance smoke test and polyurethane smoldering flame test are added.

Table 3-1. UL Testing: Smoke Test Types and Criteria

No.	Exam name	time	Opacity & MIC	Combustion	remarks
1	Fire Test	Alarms must not occur for more than 4 minutes	No provision	Paper & Wood	Smoke profile available
2	Smoldering Test	No Stipulated Statement	Alarm before opacity exceeds 29.26%/m (10%/feet)	Ponderosa Pine Bar	Smoke profile available
3	Polyurethane Fire Test	6 minutes after the end of the exam	Alarm before the opacity exceeds 15.47%/m (5.0%/feet)	polyurethane	Smoke profile available
4	Polyurethane Smoldering Test	No Stipulated Statement	Alarm before the opacity exceeds 34.23%/m (12.0%/feet)	polyurethane	Smoke profile available
5	Cooking Disturbance Smoke Test	No Stipulated Statement	Do not raise an alarm with an opacity of 4.84%/m (1.5%/feet) or a MIC value of 59.3~49.2	hamburger	Smoke profile available

Smoke testing should be performed using a Smoke Detector whose sensitivity is adjusted to the range described in UL standards.

3.2 Concept of opacity

There is an indicator of opacity in the judgment criteria of the UL standard. This is a measure of how difficult it is for light to pass through per unit length, and is calculated from the transmittance of light in order to quantify the visibility of the fire lineup.

3.2.1 How to measure opacity

The method of measurement of opacity is defined by the UL standard.

Figure 3-1 shows a schematic diagram of the method for measuring opacity in the UL standard.

In this measurement method, the opacity is calculated from the ratio of the transmittance T_c in the absence of smoke and the transmittance T_s in the presence of smoke.

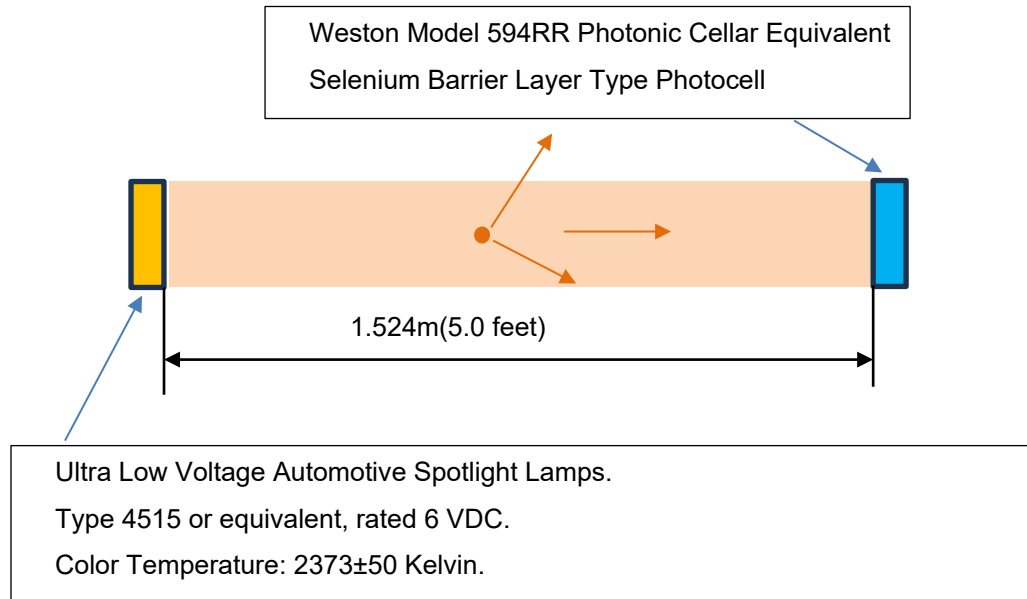

Figure 3-1. Schematic diagram of how to measure opacity

3.2.2 Defining Opacity

The opacity at a given distance d is expressed by Equation 3-1.

In this case, T_c is the transmittance without smoke at a distance d , and T_s is the transmittance at a distance d when there is smoke.

$$Q_u = \left[1 - \left(\frac{T_s}{T_c} \right)^{\frac{1}{d}} \right] \times 100$$

Equation 3-1

For example, if we consider %/foot, if the measurement of T_s and T_c is the value when measured at 5.0 feet as standard, the opacity will be as shown in Equation 3-2.

$$Q_{uf} = \left[1 - \left(\frac{T_s}{T_c} \right)^{\frac{1}{5}} \right] \times 100$$

Equation 3-2

If T_s/T_c is 80% at 5 feet, the opacity is 4.365%/foot, as shown in Equation 3-3.

$$\begin{aligned} Q_{uf} &= \left[1 - (0.8)^{\frac{1}{5}} \right] \times 100 \\ &= [1 - 0.9564] \times 100 \\ Q_{uf} &= 4.365 (\%/ft) \end{aligned}$$

Equation 3-3

Similarly, in the case of opacity in meters, from 5 feet = 1.524 m, Equation 3-3, which shows the opacity in units of 1 foot, becomes Equation 3-4 in units of 1 m, and the opacity is 13.62%/m.

$$\begin{aligned} Q_{um} &= \left[1 - (0.8)^{\frac{1}{1.524}} \right] \times 100 \\ &= [1 - 0.8638] \times 100 \\ Q_{um} &= 13.62 (\%/m) \end{aligned}$$

Equation 3-4

Therefore, a Q_{uf} of 4.365(%/ft) and a Q_{um} of 13.62(%/m) show the same smoke concentration.

4. Smoke detection by POC substrate

4.1 Photoelectric Detection Method

The smoke chamber to be installed on the POC board should have the structure shown in Figure 4-1. A cover is required to prevent ambient light. It is necessary to provide a shading block in the smoke chamber so that the light emitted from the LED does not directly enter the photodiode. Make sure that the light emitted by the LEDs and scattered by the smoke particles that have entered is detected by the photodiode. In addition, each LED and photodiode should have a guide to reduce the spread of light.

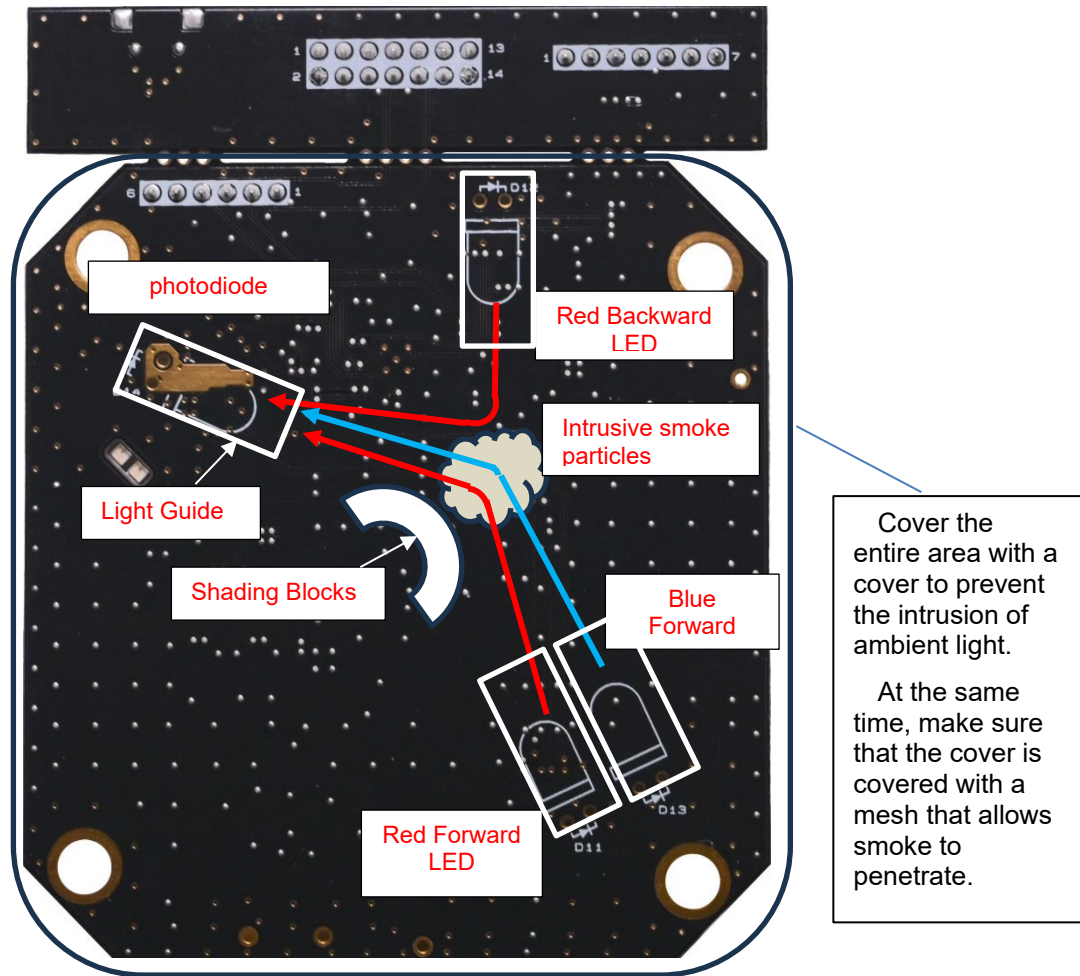

Figure 4-1. Smoke Chamber Structure

The scattered light detected by the photodiode is amplified by the TIA (Trans Impedance Amp) inside the AFE-IC and converted into digital data by the ADC of the RL78/G22. In addition, the transfer rate shown in Section 4.2 is used to treat the detected value of scattered light from each LED as the same indicator.

Smoke detection uses different wavelengths of Red and Blue LEDs, which have different scattering characteristics depending on the type of smoke. In addition, photodiodes that can detect a wide range of colors from Red to Blue are selected. Table 4-1 shows the parts list of photoelectric sensors mounted on POC boards. Table 4-2 shows a list of the drive currents for each LED. In addition, depending on the structure of the smoke chamber, it is necessary to select an appropriate one, including the LED pointing angle.

Table 4-1. Photoelectric wire sensor components

Name	Ref.	number	Model name	wavelength	package
Red LEDs (Red Forward, Red Backward)	D11,D12	2	SFH 4554	850nm	Lead product (shell-shaped Φ 5mm)
Blue LED (Blue Forward)	D13	1	HLMP-CB3A-UV0DD	470nm	Lead product (shell-shaped Φ 5mm)
photodiode	D14	1	SFH 203	400-1100nm	Lead product (shell-shaped Φ 5mm)

Note: When using 3.3V, the Blue LED cannot be used.

Table 4-2. LED drive current

Name	drive current
Red Forward LED	76mA
Blue Forward LED	48mA
Red Backward LED	170mA

4.2 Transmission ratio

The photodiode receives different intensities for each LED. In order to evaluate these with the same index, the intensity ratio between the scattered light received by the photodiode and the direct incident light of the LED is used as the transmission rate, as shown in Equation 4-1.

$$\text{Transmission ratio} = \frac{\text{Received intensity of scattered light detected by a photodiode}}{\text{Light reception intensity when LED light is directly incident on a photodiode}}$$

Equation 4-1

The light reception intensity of each LED when it is directly irradiated with the photodiode is measured in advance, and the ratio of the detected scattered light to this is used as the transmission rate.

4.3 TIA Gain Settings

Figure 4-2 shows the block diagram of the TIA implemented inside the AFE-IC. The TIA (Trans Impedance Amp) converts and amplifies the faint light detection current of the photodiode into a voltage value, which is then further amplified by the PGA (Programmable Gain Amp). This signal (PHOTO_OUT) is input to the AD converter of the RL78/G22.

The gain must be set softly according to the intensity of the scattered light, TIA_INPUTGAIN and TIA_PGAGAIN. If these sensitivities are too low, the scattered light will not be captured, and if the sensitivity is too high, the data will be saturated. In the sample program, the following settings are set as defaults.

INPUTGAIN setting1 2.5MΩ

PGAGAIN setting1 8X

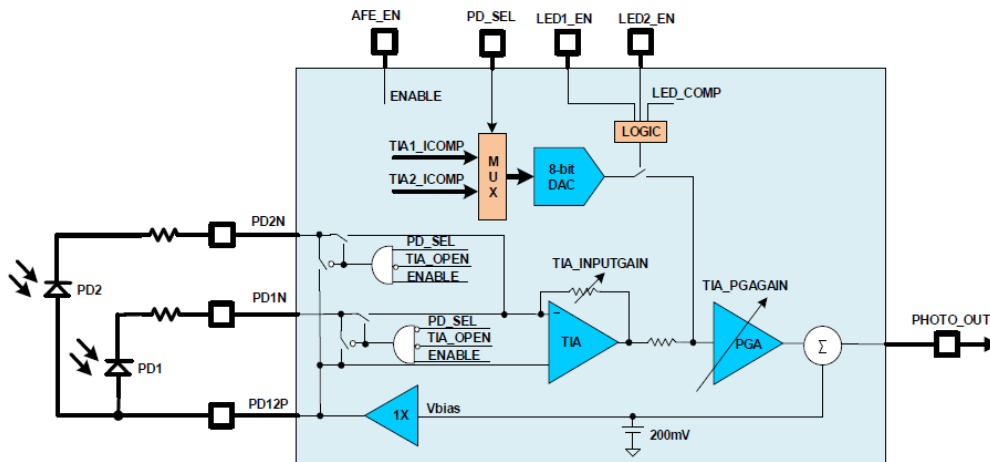

Addr	Bit	Name	R/W	POR	Description
0x01	7:5	SPARE0	RW	0x1	Reserved (Set to 0 when writing to this register)
	4	LED_COMP	RW	0x1	TIA Offset Compensation Enable 0x0 = TIA Offset Compensation enabled entire time that AFE_EN pin is high 0x1 = TIA Offset Compensation enabled only when and LED is illuminated
	3:2	TIA_INPUTGAIN	RW	0x1	TIA Input Gain: 0x0 = 1.25MΩ 0x1 = 2.5MΩ 0x2 = 3.75MΩ 0x3 = 5MΩ
	1:0	TIA_PGAGAIN	RW	0x2	TIA PGA Gain: 0x0 = 1.6X 0x1 = 8X 0x2 = 16X 0x3 = 32X

Figure 4-2. TIA Block Diagram and Its Installation Functions

4.4 AD Conversion and Transmission Ratio Calculation

The photo detector detected by the AFE-IC is amplified and finally input into the RL78/G22's AD converter. Since the conversion result of the D converter is a digitally converted value, conversion calculation is required for the transfer rate to the original value.

Equation 4-2 and Equation 4-3 show how to calculate the original signal voltage from the conversion result of the AD converter.

At this time, 2.048 indicates the reference voltage of the RL78/G22ADC, 1024 indicates the full count of the AD converter, and the values in parentheses of INPUTgain and PGAGAIN indicate the setting values of the various tests shown in Section 5.2, respectively.

$$\text{Transmission rate (numerator)} = \frac{\text{Measured light reception intensity AD value} - \text{offset}}{1024} \times 2.048 \div [\text{INPUTgain}(2.5M) \times \text{PGAGAIN}(x8)]$$

Equation 4-2

$$\text{Transmission rate (denominator)} = \frac{\text{Direct incident light reception intensity AD value} - \text{offset}}{1024} \times 2.048 \div [\text{INPUTgain}(2.5M) \times \text{PGAGAIN}(x8)]$$

Equation 4-3

The transmission rate can be calculated by dividing the above numerator by the denominator.

As shown in Equation 4-2 and Equation 4-3, the AFE-IC has an offset that must be measured and corrected in advance. There are two ways to make corrections. Please refer to Section 5.1 for the method of characteristic analysis and reflection in the alarm firing level value.

- A method in which the detection value is measured with the light shielded, the offset voltage is grasped in advance as a light reception level value, the characteristic analysis is performed excluding the offset value, and the alarm firing level is determined by including the offset value.
- A method of measuring by hard-correcting the offset voltage by setting the LED_COMP, and determining the characteristic analysis and alarm firing level without offsetting.

The sample program is judged by including the offset voltage for basic data collection, but if various conditions are determined, it can be hard-corrected in advance with a LED_COMP for simplicity. In addition, if you make a hard correction, the photosensitive dynamic range will be slightly expanded.

5. Smoke Detection Algorithm

The results of the Smoldering Wood, Cooking Nuisance, and Polyurethan Fire tests using smoke detection algorithms are described.

5.1 Smoke Detection Algorithm and Software Settings

5.1.1 Smoke Detection Algorithms

The various tests listed in Section 5.2 use the following algorithms:

- Using a Red Backward LED with a small numerical difference in transmission rate depending on the type of smoke, the alarm is stopped until the level of opacity (4.84%/m) that should not be triggered by the Cooking Nuisance.
- Next, Cooking Nuisance and non-Cooking Nuisance are judged by the magnitude of the transmission rate of the Red Forward LED and the Blue Forward LED.
- Red > Blue cases are judged as Cooking Nuisances, and Blue > Red cases are judged to be non-Cooking Nuisances and an immediate warning is issued.
- Finally, an alarm is always set before the opacity exceeds 15.47%/m.

Figure 5-1 shows the flow of operation that incorporates this smoke detection algorithm.

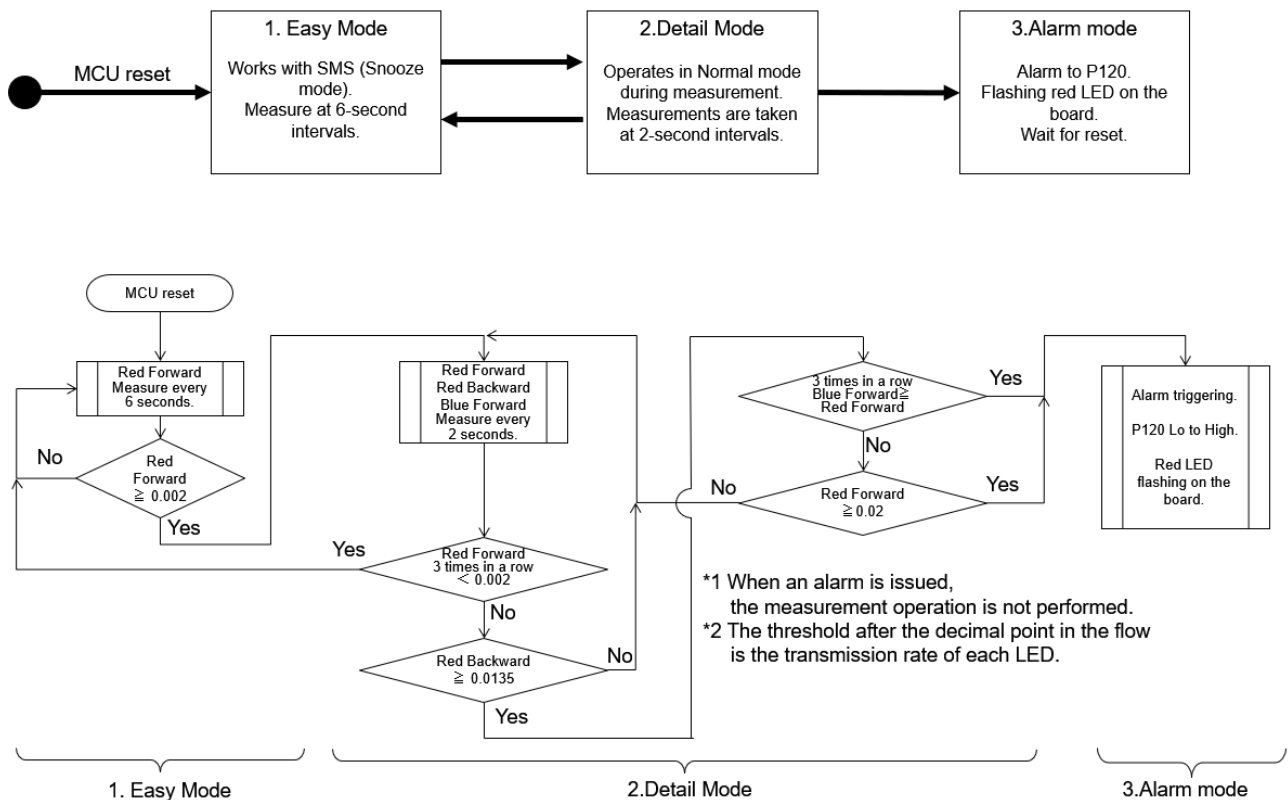

Figure 5-1. Judgment Flow Diagram of the Smoke Detection Algorithm

The details of each judgment threshold are shown below.

- ALM_REDFWD1: Indicates the threshold value of the Red Forward LED to switch from '6-second interval measurement of the Red Forward LED' to '2-second interval measurement of the Red Forward LED, Blue Forward LED, and Red Backward LED' by detecting changes in the surrounding environment, including smoke generation.
- ALM_REDBACK: Indicates the threshold that determines when to start detecting the type of smoke.
- ALM_REDFWD2: Indicates the threshold that determines when an alarm must be triggered.

5.1.2 Setting thresholds for software

In order to simplify the process, the algorithm shown in Section 5.1.1 uses not the transfer rate, but the numerical value obtained by replacing the photodiode light reception value calculated backwards from Equation 4-1, Equation 4-2, and Equation 4-3 using an AD converter. This workflow is illustrated in Figure 5-2. Table 5-1 shows the specific threshold values set in the sample program. Note that this value includes the offset of the AFE.

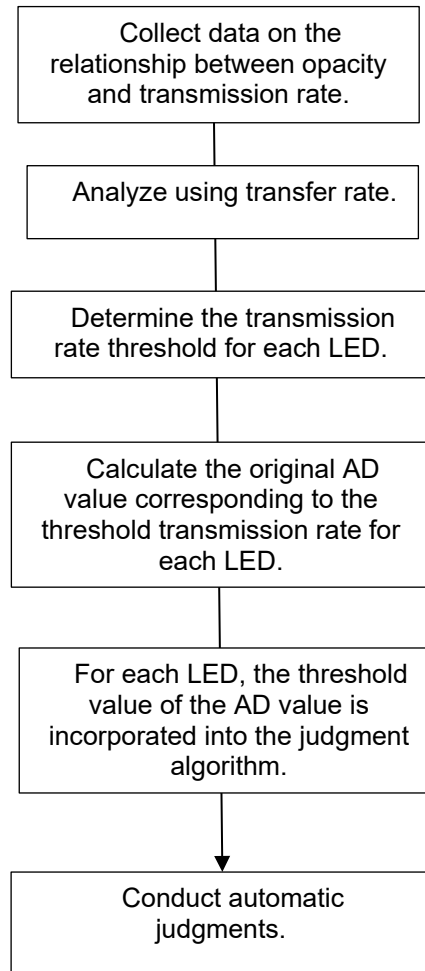

Figure 5-2. Flow for Setting Thresholds to Software

Table 5-1. Sample Program Judgment Thresholds

Judgment threshold	Sample program settings	explanation
ALM_REDFWD1	120	The threshold value for detecting changes in the surrounding environment, including smoke generation, with a Red Forward LED and switching to measurement using three LEDs.
ALM_REDBACK	200	The threshold that determines when to start detecting the type of smoke.
ALM_REDFWD2	290	A threshold that determines when an alarm is triggered.

5.2 Test Results

5.2.1 Smoldering Wood Test

Figure 5-3 and Figure 5-4 (enlarged view of Figure 5-3) show the results of the Smoldering Wood test. Red is the change in the transmission rate of the Red Forward LED, blue is the change in the transmission rate of the Blue Forward LED, orange is the change in the transmission rate of the Red Backward LED, and the left axis is the numerical value. The green color corresponding to the value on the right axis indicates the change in opacity, and the dark blue indicates the opacity when the POC board issues a warning. The yellow line indicates the opacity that the alarm should not exceed. Table 5-2 shows the POC board warning information.

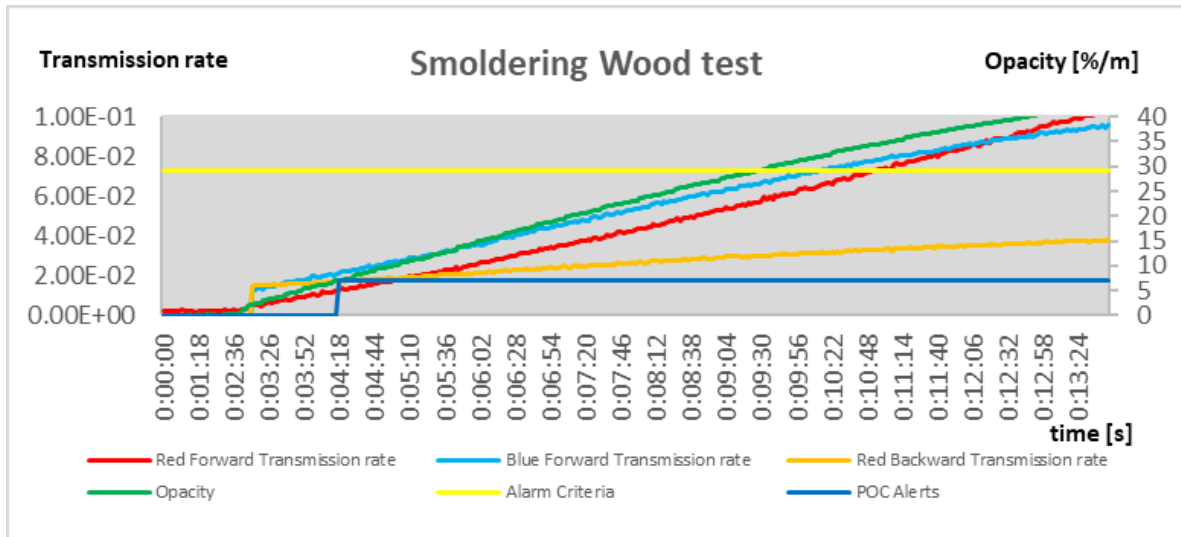

Figure 5-3. Smoldering Wood Test Results

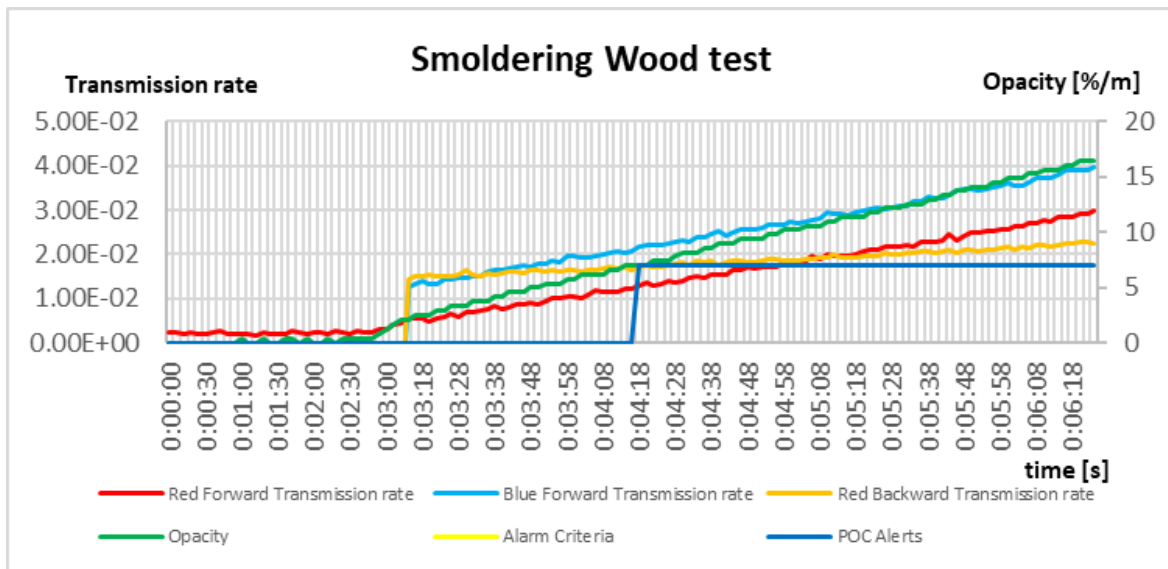

Figure 5-4. Enlarged view of Figure 5-3

Table 5-2. Smoldering Wood Test Alarm Notification Result Table

item	time	unit	remarks
Start of data recording	0:00:00	Hours:Minutes:Seconds	-
Combustion material input	0:02:00	Hours:Minutes:Seconds	-
Alarm Warning Time	0:04:18	Hours:Minutes:Seconds	Time since the start of data recording
Alarm opacity	6.98	%/m	Opacity when an alarm is triggered
Standards for Alarm Triggering	29.26	%/m	Warning is required before this is exceeded

The characteristics of the test results are shown below.

- Up to 3 minutes and 14 seconds (1 minute and 14 seconds after the combustion material is inserted), detection is performed only by the Red Forward LED, and after the Red Forward LED exceeds the threshold value, detection begins with the addition of the Blue Forward and Red Backward LEDs.
- Smoke is detected at 4 minutes and 18 seconds (2 minutes and 18 seconds after the combustion material is added) and an alarm is issued.
- The opacity at the time of alarm is 6.98%/m, which indicates that smoke detection is sufficiently low compared to the alarm judgment standard of 29.26%/m.
- The transmission rate of the Red Forward is low compared to the transmission rate of the Blue Forward.

5.2.2 Cooking Nuisance Test

Figure 5-5 and Figure 5-6 (enlarged view of Figure 5-5) show the results of the Cooking Nuisance test. Table 5-3 shows the POC board notification information.

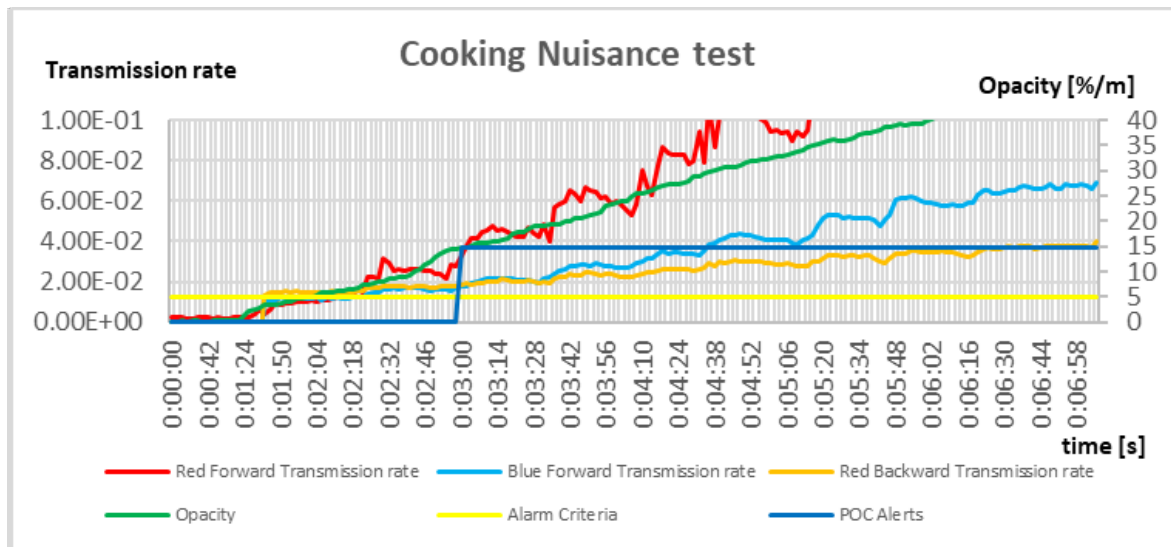

Figure 5-5. Cooking Nuisance Test Results

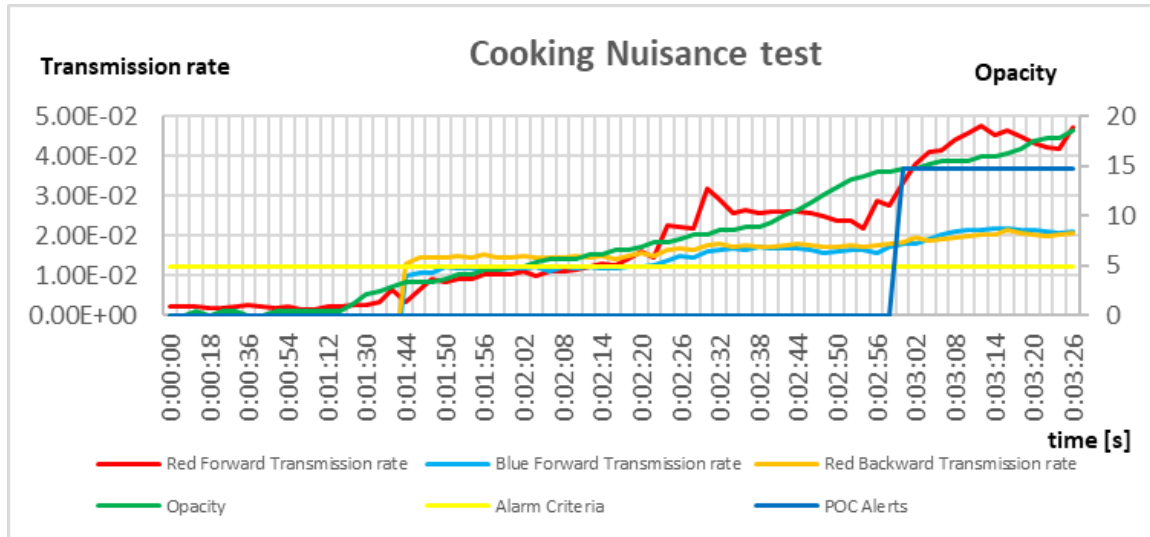

Figure 5-6. Enlarged view of Figure 5-5

Table 5-3. Cooking Nuisance Test Alarm Notification Result Table

item	time	unit	remarks
Start of data recording	0:00:00	Hours:Minutes:Seconds	-
Combustion material input	0:01:00	Hours:Minutes:Seconds	-
POC Alarm Notification	0:03:00	Hours:Minutes:Seconds	Data Recording Start Time Criteria
POC Utterance Opacity	14.78	%/m	Opacity at the time of issuance
Alarm Criteria	4.84	%/m	No further notice shall be issued below

The characteristics of the test results are shown below.

- Up to 1 minute and 44 seconds (44 seconds after the combustion material is inserted), detection is performed only by the Red Forward LED, and when the Red Forward LED exceeds the threshold value, detection begins with the addition of the Blue Forward LED and the Red Backward LED.
- Smoke is detected at 3 minutes 00 seconds (2 minutes 00 seconds after the combustion material is added) and an alarm is issued.
- The opacity at the time of alarm is 14.78%/m, which is higher than the standard of 4.84%/m, which is the criterion for not alarming. In other words, false alarms caused by cooking can be prevented.
- Unlike ordinary smoke, the transmission rate in Forward of Red is reversed from the middle to the transmission rate in Forward of the Blue and is higher.

5.2.3 Polyurethane Fire Test

Figure 5-7 and Figure 5-8 (enlarged view of Figure 5-7) show the results of the Polyurethane Fire test. Table 5-4 shows the POC board warning information.

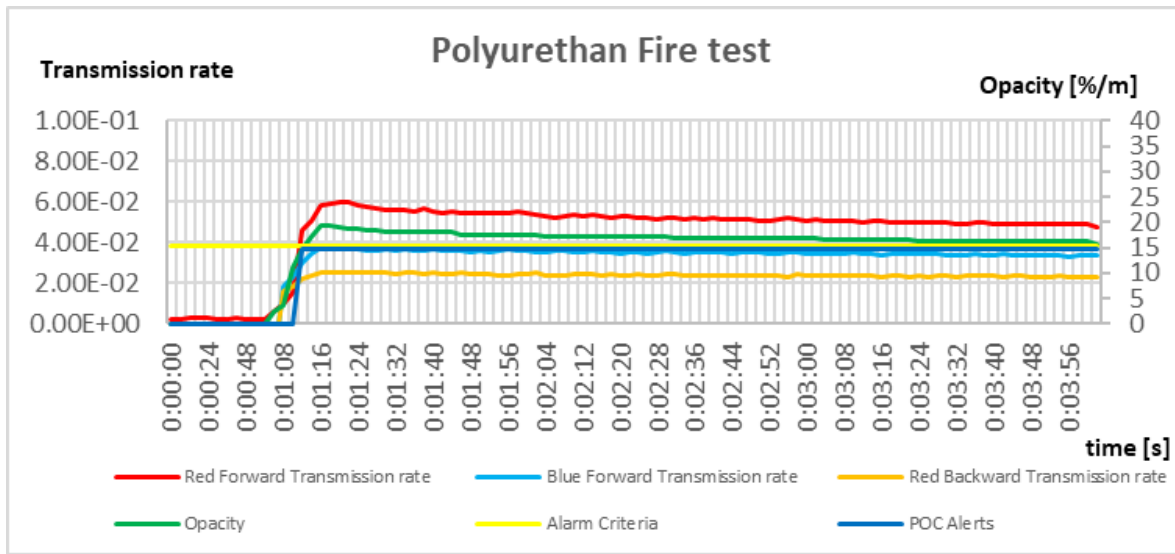

Figure 5-7. Polyurethane Fire Test Results

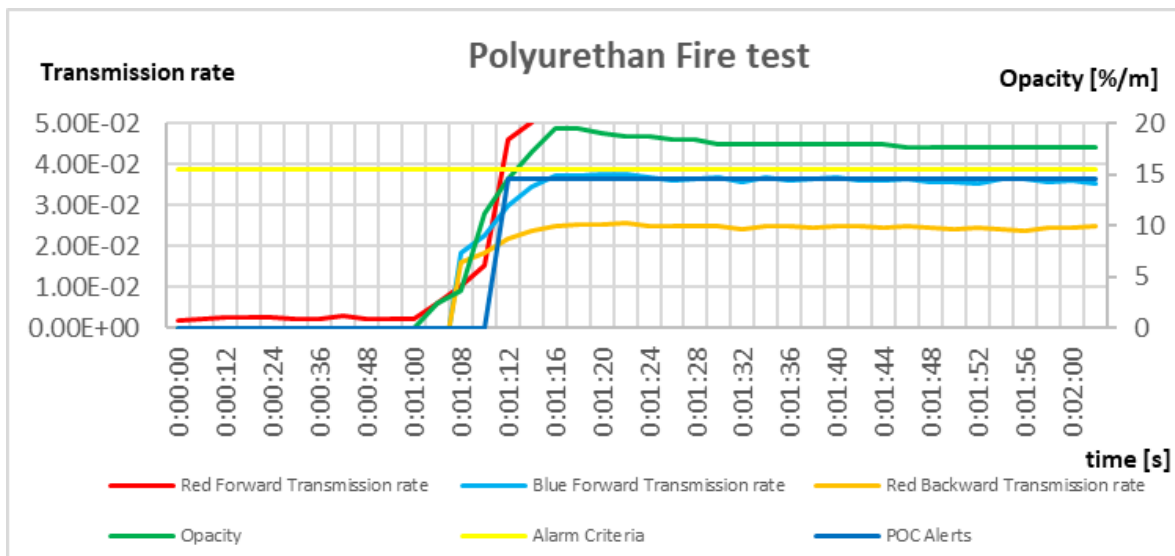

Figure 5-8. Enlarged view of Figure 5-7

Table 5-4. Polyurethan Fire Test Alarm Alerting Status

item	time	unit	remarks
Start of data recording	0:00:00	Hours:Minutes:Seconds	-
Combustion material ignition	0:01:00	Hours:Minutes:Seconds	-
POC Alarm Notification	0:01:12	Hours:Minutes:Seconds	Data Recording Start Time Criteria
POC Utterance Opacity	14.61	%/m	Opacity at the time of issuance
Alarm Criteria	15.47	%/m	Warning is required before this is exceeded

The characteristics of the test results are shown below.

- Up to 1 minute 08 seconds (08 seconds after ignition of the combustion material), detection is performed only by the Red Forward LED, and when the Red Forward LED exceeds the threshold value, detection begins with the addition of the Blue Forward LED and the Red Backward LED.
- Smoke is detected in 1 minute and 12 seconds (12 seconds after the combustion material is ignited) and an alarm is issued.
- The opacity at the time of alarm activation is 14.61%/m, which is less than the standard of 15.47 when the alarm must be issued.
- Unlike ordinary smoke, the transmission rate is higher in the Red Forward than in the Blue Forward, as in the case of Cooking Nuisance.

For reference, the Smoldering Polyurethan test results are shown in Figure 5-9. Similar to normal smoke, the transmission rate of the Blue Forward LED is greater than that of the Red Forward LED.

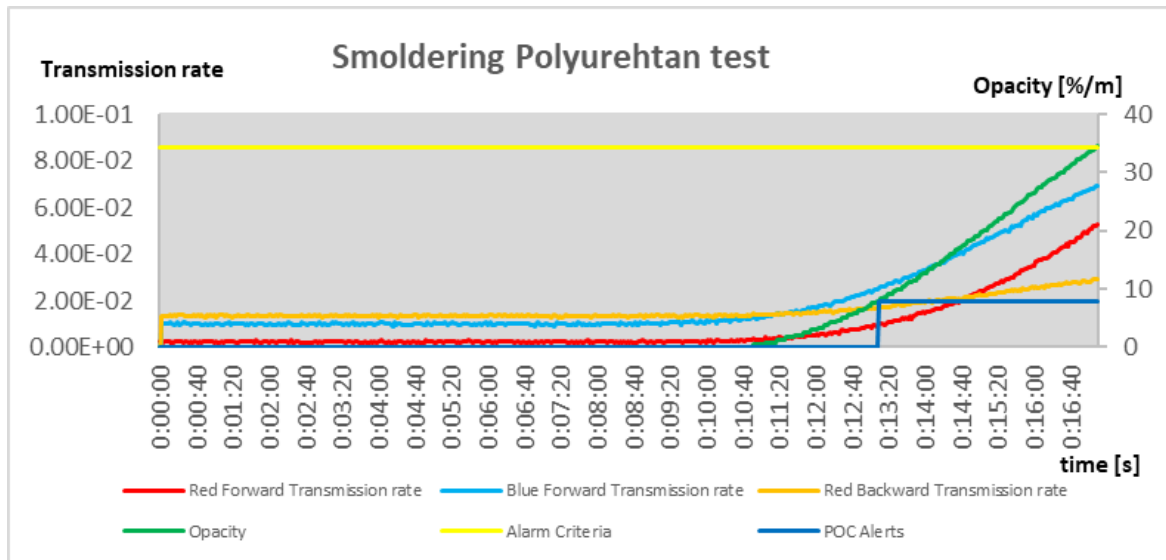

Figure 5-9. Smoldering Polyurethan Test Results

5.3 Parameter setting

Table 5-5~Table 5-8 lists the parameters for this solution.

Table 5-5. Parameter List (Overall Control)

Variable type	Variable name	Data content
unit16_t	APP_u16Use_SMS	Whether or not to use SMS in Easy judgment mode. 0: Do not use. 1: Use.
unit16_t	APP_u16Use_UART	Whether or not the AD conversion value is serially output. 0: Do not output. 1: Output.
unit16_t	APP_u16LED_Enable	LED Lighting Enabled/Disabled LED lighting control at the timing of LED lighting 0: Remains unlit. 1: Lights up. * In SMS operation, it works fixed to "light up".
unit16_t	APP_u16Seq1_LED	LEDs used in Easy judgment mode. 0: Red Forward. 1: Blue Forward. During SMS operation, which LED to use in the SMS process is set.
unit16_t	APP_u16Seq1_IntTime	Easy judgment mode measurement period [ms]. LSB:1[ms]. Specified in 100[ms] increments. If a fraction is specified, less than 100 [ms] is truncated.
unit16_t	APP_u16Seq2_IntTime	Detailed judgment mode measurement period [ms]. LSB:1[ms]. Specify in units of 100 [ms]. If a fraction is specified, less than 100 [ms] is truncated.
unit16_t	APP_u16AlarmRedFwd1_Threshold	Red anterior threshold 1. The AD conversion value corresponding to the propagation rate of 0.004 in the Red Forward.
unit16_t	APP_u16AlarmRedBack_Threshold	Red backward threshold. The AD conversion value corresponding to the propagation rate of 0.017 behind the Red.
unit16_t	APP_u16AlarmRedFwd2_Threshold	Red anterior threshold 2. The AD conversion value corresponding to the transmission rate of 0.033 in the Red Forward.

Table 5-6. Parameter List (Red Forward LED)

Variable type	Variable name	Data content
unit8_t	APP_u8LED_RF_Current	LED Red Forward current. LED Red Forward Current = 45mA + 31mA = 76mA.
unit8_t	APP_u8LED_RF_InputGain	LED Red Forward PD input gain. 0:1.25MΩ, 1:2.5MΩ, 2:3.75MΩ, 3:5MΩ.
unit8_t	APP_u8LED_RF_PGAGain	LED Red Forward PD PGA Gain. 0:1.6X, 1:8X, 2:16X, 3:32X.
unit8_t	APP_u8LED_RF_TIAIComp	LED Red Forward AFE Offset Correction. Correction = -0.25mV x APP_u16LED_RF_InputGain x APP_u16LED_RF_PGAGain.

Table 5-7. Parameter List (Blue Forward LED)

Variable type	Variable name	Data content
unit8_t	APP_u8LED_BF_Current	LED Blue Forward current. LED Blue Forward Current = 45mA + 3mA = 48mA.
unit8_t	APP_u8LED_BF_InputGain	The PD input gain when using the LED Blue Forward. 0:1.25MΩ, 1:2.5MΩ, 2:3.75MΩ, 3:5MΩ.
unit8_t	APP_u8LED_BF_PGAGain	PD PGA gain when using Blue Forward LED. 0:1.6X, 1:8X, 2:16X, 3:32X.
unit8_t	APP_u8LED_BF_TIAIComp	LED Blue Forward offset correction. Correction = -0.25mV x APP_u16LED_BF_InputGain x APP_u16LED_BF_PGAGain.

Table 5-8. Parameter List (Red Backward LED)

Variable type	Variable name	Data content
unit8_t	APP_u8LED_RB_Current	LED Red Backward current. LED Red Backward Current = 45mA + 125mA = 170mA.
unit8_t	APP_u8LED_RB_InputGain	PD input gain when Red Backward LED. 0:1.25MΩ, 1:2.5MΩ, 2:3.75MΩ, 3:5MΩ.
unit8_t	APP_u8LED_RB_PGAGain	Red Backward LED PD PGA Gain 0:1.6X, 1:8X, 2:16X, 3:32X.
unit8_t	APP_u8LED_RB_TIAIComp	LED Red Backward Offset Correction. Correction = -0.25mV x APP_u16LED_RB_InputGain x APP_u16LED_RB_PGAGain.

6. Register Settings

Table 6-1~Table 6-4 lists the register settings for this solution.

Table 6-1. List of AFE Register Settings

Register Name	Bit	Feature name	The variable value to set, or a fixed value
TIA	3:2	TIA_INPUTGAIN	APP_u8LED_RF_InputGain 0:1.25M Ω 1:2.5M Ω 2:3.75M Ω 3:5M Ω
TIA	1:0	TIA_PGAGAIN	APP_u8LED_RF_PGAGain 0:1.6X 1:8X 2:16X 3:32X
ADC_CFG	1	ADC_EN	0x1 0x1 = ADC is powered up when ADC_EN = 0x1 and AFE_EN pin = high

Table 6-2. List of LED Settings in Detail judgment mode

LEDs to be set	AFE Register Name	Bit	Feature name	Variable values to set
Red Forward	LED1	7:0	LED1	APP_u8LED_RF_Current LED Red Forward current = 45mA + APP_u8LED_RF_Current
Red Backward	LED2	7:0	LED2	APP_u8LED_RB_Current LED Red backward current = 45mA + APP_u8LED_RB_Current
Blue Forward	LED2	7:0	LED2	APP_u8LED_BF_Current LED Blue Forward current = 45mA + APP_u8LED_BF_Current

Table 6-3. List of MCU Register Settings at the Start of AD Conversion

MCU Register Name	Variable values to set	remarks
ADCEN	1U	enable AD clock
ADCE	1U	enable AD comparator
ADIF	0U	clear INTAD interrupt flag
ADMK	0U	enable INTAD interrupt
ADCS	1U	enables conversion operation

Table 6-4. MCU Register Settings at the End of AD Conversion

MCU Register Name	Variable values to set	remarks
ADCS	0U	disable conversion operation
ADMK	1U	disable INTAD interrupt
ADIF	0U	clear INTAD interrupt flag
ADCE	0U	disable AD comparator
ADCEN	0U	disable AD clock

7. Nomenclature

- IC Integrated Circuit
- POC Proof of Concept
- SW Software
- HW Hardware
- MCU Micro Controller Unit
- CPU Central Processing Unit
- AFE Analog Front End
- LED Light-Emitting Diode
- PD Photodiode
- IR Infrared Radiation
- TIA Transimpedance Input Amplifier
- PGA Programmable Gain Amplifiers
- DAC D/A converter or digital-to-analog Converter
- ADC A/D converter or analog-to-digital Converter
- SPI Serial Peripheral Interface
- UART Universal Asynchronous Receiver Transmitter
- ROM Read-Only Memory
- RAM Random Access Memory
- DC Direct Current
- AC Alternating Current
- LDO Low-Dropout voltage regulator
- GPIO General-Purpose Input and Output
- TX Transmission
- RX Reception
- USB Universal Serial Bus
- PCB Polychlorinated Biphenyl
- PC Personal Computer
- SINI System Initialization
- APP Application
- IDE Integrated Development Environment
- UL Underwriters Laboratories

8. References

- [1] RL78/G22 User's Manual: Hardware (R01UH0978)
- [2] RL78/G22 Multiwavelength Smoke Detector Evaluation Board Manual (Hardware) (R01UH1161)
- [3] RL78/G22 Multiwavelength Smoke Detector Evaluation Board Manual (Software) (R01US0776)
- [4] SCHEMATIC DIAGRAM SMOKE DETECTOR
(RENESAS_SMOKEDETECTOR_R1_20230309.pdf)
- [5] MCP1501 High-Precision Buffered Voltage Reference (Datasheet)
(MCP1501_Data_Sheet_DS20005474-3499863.pdf)
- [6] Sunhayato USB Serial Conversion Module MM-FT232 Instruction Manual
(manual-mm-ft232-ja.pdf)

Revision History

Rev.	Date	Description	
		Page	Summary
1.00	Feb.20.25	—	Initial publication
1.01	Apr.09.26		Revisions: - Figure 4-2 - References

General Precautions in the Handling of Microprocessing Unit and Microcontroller Unit Products

The following usage notes are applicable to all Microprocessing unit and Microcontroller unit products from Renesas. For detailed usage notes on the products covered by this document, refer to the relevant sections of the document as well as any technical updates that have been issued for the products.

1. Precaution against Electrostatic Discharge (ESD)

A strong electrical field, when exposed to a CMOS device, can cause destruction of the gate oxide and ultimately degrade the device operation. Steps must be taken to stop the generation of static electricity as much as possible, and quickly dissipate it when it occurs. Environmental control must be adequate. When it is dry, a humidifier should be used. This is recommended to avoid using insulators that can easily build up static electricity. Semiconductor devices must be stored and transported in an anti-static container, static shielding bag or conductive material. All test and measurement tools including work benches and floors must be grounded. The operator must also be grounded using a wrist strap. Semiconductor devices must not be touched with bare hands. Similar precautions must be taken for printed circuit boards with mounted semiconductor devices.

2. Processing at power-on

The state of the product is undefined at the time when power is supplied. The states of internal circuits in the LSI are indeterminate and the states of register settings and pins are undefined at the time when power is supplied. In a finished product where the reset signal is applied to the external reset pin, the states of pins are not guaranteed from the time when power is supplied until the reset process is completed. In a similar way, the states of pins in a product that is reset by an on-chip power-on reset function are not guaranteed from the time when power is supplied until the power reaches the level at which resetting is specified.

3. Input of signal during power-off state

Do not input signals or an I/O pull-up power supply while the device is powered off. The current injection that results from input of such a signal or I/O pull-up power supply may cause malfunction and the abnormal current that passes in the device at this time may cause degradation of internal elements. Follow the guideline for input signal during power-off state as described in your product documentation.

4. Handling of unused pins

Handle unused pins in accordance with the directions given under handling of unused pins in the manual. The input pins of CMOS products are generally in the high-impedance state. In operation with an unused pin in the open-circuit state, extra electromagnetic noise is induced in the vicinity of the LSI, an associated shoot-through current flows internally, and malfunctions occur due to the false recognition of the pin state as an input signal become possible.

5. Clock signals

After applying a reset, only release the reset line after the operating clock signal becomes stable. When switching the clock signal during program execution, wait until the target clock signal is stabilized. When the clock signal is generated with an external resonator or from an external oscillator during a reset, ensure that the reset line is only released after full stabilization of the clock signal. Additionally, when switching to a clock signal produced with an external resonator or by an external oscillator while program execution is in progress, wait until the target clock signal is stable.

6. Voltage application waveform at input pin

Waveform distortion due to input noise or a reflected wave may cause malfunction. If the input of the CMOS device stays in the area between V_{IL} (Max.) and V_{IH} (Min.) due to noise, for example, the device may malfunction. Take care to prevent chattering noise from entering the device when the input level is fixed, and also in the transition period when the input level passes through the area between V_{IL} (Max.) and V_{IH} (Min.).

7. Prohibition of access to reserved addresses

Access to reserved addresses is prohibited. The reserved addresses are provided for possible future expansion of functions. Do not access these addresses as the correct operation of the LSI is not guaranteed.

8. Differences between products

Before changing from one product to another, for example to a product with a different part number, confirm that the change will not lead to problems. The characteristics of a microprocessing unit or microcontroller unit products in the same group but having a different part number might differ in terms of internal memory capacity, layout pattern, and other factors, which can affect the ranges of electrical characteristics, such as characteristic values, operating margins, immunity to noise, and amount of radiated noise. When changing to a product with a different part number, implement a system-evaluation test for the given product.

Notice

1. Descriptions of circuits, software and other related information in this document are provided only to illustrate the operation of semiconductor products and application examples. You are fully responsible for the incorporation or any other use of the circuits, software, and information in the design of your product or system. Renesas Electronics disclaims any and all liability for any losses and damages incurred by you or third parties arising from the use of these circuits, software, or information.
2. Renesas Electronics hereby expressly disclaims any warranties against and liability for infringement or any other claims involving patents, copyrights, or other intellectual property rights of third parties, by or arising from the use of Renesas Electronics products or technical information described in this document, including but not limited to, the product data, drawings, charts, programs, algorithms, and application examples.
3. No license, express, implied or otherwise, is granted hereby under any patents, copyrights or other intellectual property rights of Renesas Electronics or others.
4. You shall be responsible for determining what licenses are required from any third parties, and obtaining such licenses for the lawful import, export, manufacture, sales, utilization, distribution or other disposal of any products incorporating Renesas Electronics products, if required.
5. You shall not alter, modify, copy, or reverse engineer any Renesas Electronics product, whether in whole or in part. Renesas Electronics disclaims any and all liability for any losses or damages incurred by you or third parties arising from such alteration, modification, copying or reverse engineering.
6. Renesas Electronics products are classified according to the following two quality grades: "Standard" and "High Quality". The intended applications for each Renesas Electronics product depends on the product's quality grade, as indicated below.

"Standard": Computers; office equipment; communications equipment; test and measurement equipment; audio and visual equipment; home electronic appliances; machine tools; personal electronic equipment; industrial robots; etc.

"High Quality": Transportation equipment (automobiles, trains, ships, etc.); traffic control (traffic lights); large-scale communication equipment; key financial terminal systems; safety control equipment; etc.

Unless expressly designated as a high reliability product or a product for harsh environments in a Renesas Electronics data sheet or other Renesas Electronics document, Renesas Electronics products are not intended or authorized for use in products or systems that may pose a direct threat to human life or bodily injury (artificial life support devices or systems; surgical implantations; etc.), or may cause serious property damage (space system; undersea repeaters; nuclear power control systems; aircraft control systems; key plant systems; military equipment; etc.). Renesas Electronics disclaims any and all liability for any damages or losses incurred by you or any third parties arising from the use of any Renesas Electronics product that is inconsistent with any Renesas Electronics data sheet, user's manual or other Renesas Electronics document.
7. No semiconductor product is absolutely secure. Notwithstanding any security measures or features that may be implemented in Renesas Electronics hardware or software products, Renesas Electronics shall have absolutely no liability arising out of any vulnerability or security breach, including but not limited to any unauthorized access to or use of a Renesas Electronics product or a system that uses a Renesas Electronics product. RENESAS ELECTRONICS DOES NOT WARRANT OR GUARANTEE THAT RENESAS ELECTRONICS PRODUCTS, OR ANY SYSTEMS CREATED USING RENESAS ELECTRONICS PRODUCTS WILL BE INVULNERABLE OR FREE FROM CORRUPTION, ATTACK, VIRUSES, INTERFERENCE, HACKING, DATA LOSS OR THEFT, OR OTHER SECURITY INTRUSION ("Vulnerability Issues"). RENESAS ELECTRONICS DISCLAIMS ANY AND ALL RESPONSIBILITY OR LIABILITY ARISING FROM OR RELATED TO ANY VULNERABILITY ISSUES. FURTHERMORE, TO THE EXTENT PERMITTED BY APPLICABLE LAW, RENESAS ELECTRONICS DISCLAIMS ANY AND ALL WARRANTIES, EXPRESS OR IMPLIED, WITH RESPECT TO THIS DOCUMENT AND ANY RELATED OR ACCOMPANYING SOFTWARE OR HARDWARE, INCLUDING BUT NOT LIMITED TO THE IMPLIED WARRANTIES OF MERCHANTABILITY, OR FITNESS FOR A PARTICULAR PURPOSE.
8. When using Renesas Electronics products, refer to the latest product information (data sheets, user's manuals, application notes, "General Notes for Handling and Using Semiconductor Devices" in the reliability handbook, etc.), and ensure that usage conditions are within the ranges specified by Renesas Electronics with respect to maximum ratings, operating power supply voltage range, heat dissipation characteristics, installation, etc. Renesas Electronics disclaims any and all liability for any malfunctions, failure or accident arising out of the use of Renesas Electronics products outside of such specified ranges.
9. Although Renesas Electronics endeavors to improve the quality and reliability of Renesas Electronics products, semiconductor products have specific characteristics, such as the occurrence of failure at a certain rate and malfunctions under certain use conditions. Unless designated as a high reliability product or a product for harsh environments in a Renesas Electronics data sheet or other Renesas Electronics document, Renesas Electronics products are not subject to radiation resistance design. You are responsible for implementing safety measures to guard against the possibility of bodily injury, injury or damage caused by fire, and/or danger to the public in the event of a failure or malfunction of Renesas Electronics products, such as safety design for hardware and software, including but not limited to redundancy, fire control and malfunction prevention, appropriate treatment for aging degradation or any other appropriate measures. Because the evaluation of microcomputer software alone is very difficult and impractical, you are responsible for evaluating the safety of the final products or systems manufactured by you.
10. Please contact a Renesas Electronics sales office for details as to environmental matters such as the environmental compatibility of each Renesas Electronics product. You are responsible for carefully and sufficiently investigating applicable laws and regulations that regulate the inclusion or use of controlled substances, including without limitation, the EU RoHS Directive, and using Renesas Electronics products in compliance with all these applicable laws and regulations. Renesas Electronics disclaims any and all liability for damages or losses occurring as a result of your noncompliance with applicable laws and regulations.
11. Renesas Electronics products and technologies shall not be used for or incorporated into any products or systems whose manufacture, use, or sale is prohibited under any applicable domestic or foreign laws or regulations. You shall comply with any applicable export control laws and regulations promulgated and administered by the governments of any countries asserting jurisdiction over the parties or transactions.
12. It is the responsibility of the buyer or distributor of Renesas Electronics products, or any other party who distributes, disposes of, or otherwise sells or transfers the product to a third party, to notify such third party in advance of the contents and conditions set forth in this document.
13. This document shall not be reprinted, reproduced or duplicated in any form, in whole or in part, without prior written consent of Renesas Electronics.
14. Please contact a Renesas Electronics sales office if you have any questions regarding the information contained in this document or Renesas Electronics products.

(Note1) "Renesas Electronics" as used in this document means Renesas Electronics Corporation and also includes its directly or indirectly controlled subsidiaries.

(Note2) "Renesas Electronics product(s)" means any product developed or manufactured by or for Renesas Electronics.

(Rev.5.0-1 October 2020)

Corporate Headquarters

TOYOSU FORESIA, 3-2-24 Toyosu,
Koto-ku, Tokyo 135-0061, Japan

www.renesas.com

Trademarks

Renesas and the Renesas logo are trademarks of Renesas Electronics Corporation. All trademarks and registered trademarks are the property of their respective owners.

Contact information

For further information on a product, technology, the most up-to-date version of a document, or your nearest sales office, please visit:

www.renesas.com/contact/.