

RL78/G1H, RAA604S00

Antenna diversity setting method and effectiveness evaluation

Introduction

This document shows the required register settings and evaluation results in the field test regarding antenna diversity in the RL78 / G1H and RAA604S00.

Note: The contents of this document are provided as reference example and do not guarantee signal quality in systems. When measured by the customer, please use it in test facility such as anechoic chamber to comply with the radio regulations.

Target Device

RL78/G1H, RAA604S00

Contents

1. Overview	2
2. Flowchart for G1H/RAA604S00 based antenna diversity	2
3. Constraint for antenna diversity operation.....	3
4. Setting register values for antenna diversity	3
5. Evaluation under wired condition	7
5.1 Measurement system	7
5.2 Measurement procedure	7
5.3 Measurement results	10
6. Field evaluation of wireless condition.....	11
6.1 Measurement system	11
6.2 Measurement procedure	13
6.3 Measurement results.....	14
6.3.1 Test 1.....	14
6.3.2 Test 2.....	15
Revision History.....	16

1. Overview

This application note describes register settings and effectiveness in the antenna diversity mode as shown by field test evaluation results. These will be helpful for customers when actually using antenna diversity. Communication environment varies depending on various surrounding environmental conditions such as antenna installation status and obstacles.

The antenna diversity of the RL78 / G1H and RAA604S00 is an antenna selection method that selects the antenna with stronger radio waves by switching.

2. Flowchart for G1H/RAA604S00 based antenna diversity

The flowchart of antenna diversity is shown in Figure 1.

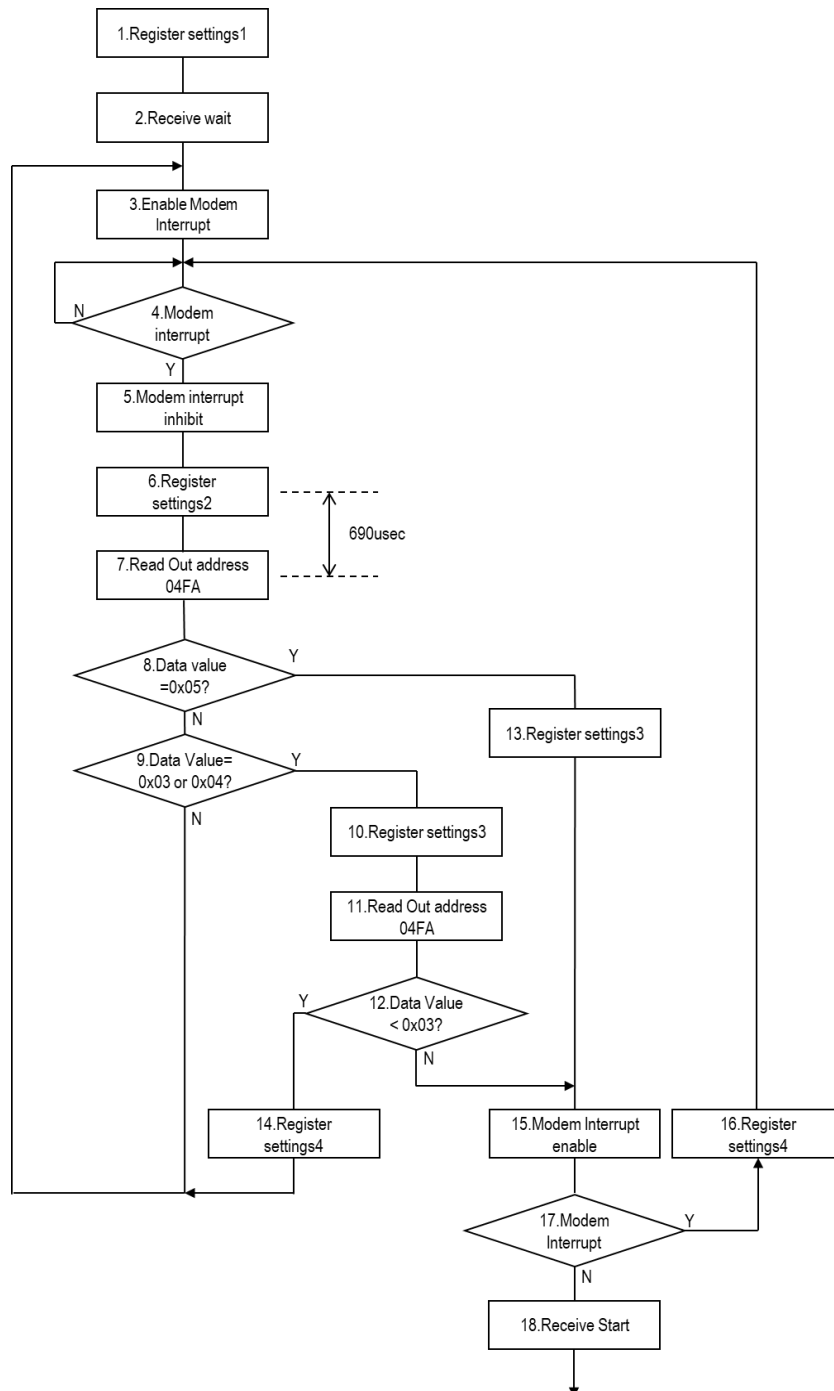

Figure 1. Flowchart for G1H/RAA604S00 based antenna diversity

3. Constraint for antenna diversity operation

When using the diversity function of G1H / RAA604S00, there are the following constraint.

- Only data rate 100kbps (Modulation Index = 1) / 2GFSK is supported.
- Preamble 15 bytes only (registers are optimal for that preamble length).
- Use preamble 4-byte mode.

4. Setting register values for antenna diversity

Before setting these register values, you must set the register value, which corresponds to data rate = 100kbps / modulation Index = 1.

Refer to the application note (R01AN3410).

According to the flow in Figure 1, set register values in the order shown in Table 1.

All table number corresponds to Figure 1.

(1) Register settings 1

Address 0408 is a read only status register, so for that register read action is needed (not write).

Any read out value is OK. The read action clears the status.

See Table 1 for Register settings.

Table 1. Register settings 1 (Initial setting)

Address(H)	Data(H)
000E	98
00B2	07
00CE	07
00D1	FF
00D0	FF
042D	06
0408	XX
04E3	88
04E4	88
04E7	98
04E8	01
04F4	06
04F9	03
04FC	01
0513	0E

(2) Receive wait

Setting address 000C data to 01, enter the receive mode.

See Table 2 for register setting.

Table 2. Receive wait

Address(H)	Data(H)
000C	01

(3) Enable Modem Interrupt

Address 003B is an interrupt register, set bit7 to "1", and not change anything else.

See Table 3 for register setting.

Table 3. Enable Modem Interrupt

Address(H)	Data(B)
003B	1XXXXXXXX

(4) Modem Interrupt

Polling the bit 7 of address 0038 until set to high.

See Table 4 for register setting.

Table 4. Modem Interrupt

Address(H)	Data(H)
0038	XX

(5) Modem Interrupt inhibit

To ensure the correct MAC timer interrupt, inhibit modem interrupt.

See Table 5 for register setting.

Table 5. Modem Interrupt inhibit

Address(H)	Data(B)
003B	0XXXXXXXX

(6) Register settings 2

Set the MAC timer wait 690us through address 002C and 002D. Modem Interrupt change by setting address 04E3 data to 22.

Address 0408 is a read only status register, so for that register read action is needed (not write).

MAC timer start by setting bit0 of address 0034 data to "1".

See Table 6 for Register settings.

Table 6. Register settings 2 (MAC timer interrupt)

Address(H)	Data(H)
002C	FF
002D	4A
04E3	22
0408	XX

Address(H)	Data(B)
0034	XXXXXXXX1

(7) Read Out address 04FA

See Table 7 for register setting.

Table 7 Read Out address 04FA

Address(H)	Data(H)
04FA	XX

(8) Data value = 0x05 ?

If address 04FA value is 5, SFD is detected so proceeding to (13) Register settings 3.

(9) Register value = 0x03 or 0x04 ?

Else if address 04FA value is 3 or 4, preamble is detected so proceeding to (10) Register settings 3, else preamble is not detected, so return to (2) Receive wait.

(10) Register settings 3

See Table 8 for Register settings.

Table 8. Register settings 3 (After preamble detect)

Address(H)	Data(H)
04E3	94
04E2	06

(11) Read Out address 04FA

Same as (7). See Table 7 for register setting.

(12) Data value < 0x03 ?

Read out address 04FA, if data value is below 3, preamble is not detected so proceed to (14) Register setting 4, else proceed to receive, going to (15) MODEM interrupt enable.

(13) Register settings 3

Same as (10). See Table 8 for Register settings.

After preamble detect (address 04FA data over 2), change the MODEM interrupt setting by address 04E2 and 04E3.

(14) Register settings 4

To retry receiving, stop the receive by setting address 01 to "1".

Then MODEM interrupt change to level detect (address 4E2 and 4E3).

Re-enter the receive mode, by setting address 0C data to "1".

See Table 9 for Register settings.

Table 9. Register settings 4 (Receive retry)

Address(H)	Data(H)
0001	01
04E2	00
04E3	88

Address(H)	Data(B)
000C	XXXXXXXX1

(15) Modem Interrupt enable

After preamble detection, enable SFD-not-detect interrupt.

Set bit7 of address 003B to "1", and not change anything else.

See Table 3 for register setting.

(16) Register settings 4

Same as (14). See Table 9 for Register settings.

(17) Modem Interrupt

Check the MODEM interrupt (bit 7 of address 38). If interrupt is occurred, retry receive and move to (16) Register setting 4, else proceed to receive (move to (18) Receive Start).

See Table 4 for register setting.

(18) Receive Start

Start receiving.

5. Evaluation under wired condition

5.1 Measurement system

In evaluating antenna diversity, it is required to confirm that RX DUT can receive signal normally in single antenna mode and antenna diversity mode.

About each of ANT1 and ANT2 terminals of RX DUT, input the signal by wire from Signal generator (SG) and confirm that it can be received normally.

When each RX DUT is connected as shown in Figure 2 and Figure 3, it is possible to check the operation of single antenna and the operation of antenna diversity at the same time.

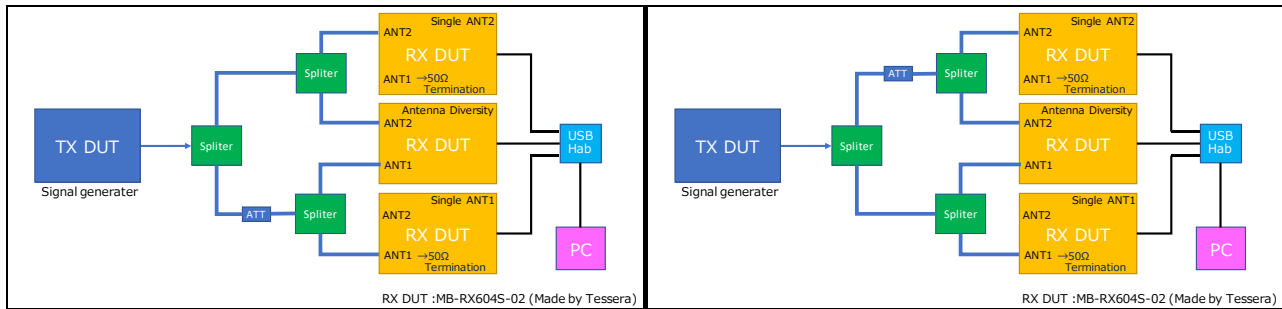

Figure 2. ATT on ANT1 side

Figure 3. ATT on ANT2 side

By sharing antenna input between each RX DUT for single antenna and RX DUT for antenna diversity via splitters as shown in Figure 2 and Figure 3, receiver characteristics with single antenna can be evaluated for each of ANT1 and ANT2, it is possible to confirm which antenna terminal has been selected by antenna diversity.

Attenuator (ATT) between transmitting system and receiving system makes difference in received power between ANT1 side and ANT2 side to confirm that the antenna terminal with the higher RSSI is selected in antenna diversity at the same time.

5.2 Measurement procedure

The procedure for measuring the receiver characteristics using the measurement system shown in Figure 2 and Figure 3 is shown below.

(1) Connect RX DUT and PC with USB cable

Connect PC and each RX DUT with USB cable.

Each function is executed by commands from PC.

At this time, receiver sensitivity may deteriorate due to the radiation noise of USB, attach a clamp filter to USB cable and wire USB cable perpendicular to RX DUT.

(2) Start terminal software of PC

Start terminal software and set the serial port.

When RF characteristic evaluation program starts, commands are ready to be entered.

(3) Setting command to RX DUT

(a) RX DUT for Single ANT1

Input commands shown in Table 10 to RX DUT for single antenna of ANT1, then the DUT is in packet receiving state.

Table 10. Setting RX DUT for Single ANT1

command (and SetData[Dec])? >tfband 9	->Frequency setting (Japan)
command (and SetData[Dec])? >tfsk 2	->Modulation method setting (100kbps_m=1)
command (and SetData[Dec])? >t2 32	->Channel number setting (e.g.,927.1MHz)
command (and SetData[Dec])? >tpl4brx 0	->Preamble 4byte mode OFF
command (and SetData[Dec])? >tberlen 20	->Data length 20byte
command (and SetData[Dec])? >tfcs 4	->FCS4byte
command (and SetData[Dec])? >tdw 1	->Data Whitening ON
command (and SetData[Dec])? >tsfdext 1	->SFD4byte mode ON
command (and SetData[Dec])? >tantse1 1	->Antenna select (ANT1)
command (and SetData[Dec])? >tantdv 0	->Antenna diversity Mode OFF
command (and SetData[Dec])? >t7 0x11	->PER and BER measurement started

(b) RX DUT for Single ANT2

Input commands shown in Table 11 to RX DUT for single antenna of ANT2, then the DUT is in packet receiving state.

Table 11. Setting RX DUT for Single ANT2

command (and SetData[Dec])? >tfband 9	->Frequency setting (Japan)
command (and SetData[Dec])? >tfsk 2	->Modulation method setting (100kbps_m=1)
command (and SetData[Dec])? >t2 32	->Channel number setting (e.g.,927.1MHz)
command (and SetData[Dec])? >tpl4brx 0	->Preamble 4byte mode OFF
command (and SetData[Dec])? >tberlen 20	->Data length 20byte
command (and SetData[Dec])? >tfcs 4	->FCS4byte
command (and SetData[Dec])? >tdw 1	->Data Whitening ON
command (and SetData[Dec])? >tsfdext 1	->SFD4byte mode ON
command (and SetData[Dec])? >tantse2 0	->Antenna select (ANT2)
command (and SetData[Dec])? >tantdv 0	->Antenna diversity Mode OFF
command (and SetData[Dec])? >t7 0x11	->PER and BER measurement started

(c) RX DUT for antenna diversity

Input commands shown in Table 12 to RX DUT for antenna diversity, then the DUT is in packet receiving state.

Table 12. Setting RX DUT for antenna diversity

command (and SetData[Dec])? >tfband 9	->Frequency setting (Japan)
command (and SetData[Dec])? >tfsk 2	->Modulation method setting (100kbps_m=1)
command (and SetData[Dec])? >t2 32	->Channel number setting (e.g.,927.1MHz)
command (and SetData[Dec])? >tpl4brx 1	->Preamble 4byte mode ON
command (and SetData[Dec])? >tberlen 20	->Data length 20byte
command (and SetData[Dec])? >tfcs 4	->FCS4byte
command (and SetData[Dec])? >tdw 1	->Data Whitening ON
command (and SetData[Dec])? >tsfdext 0	->SFD4byte mode OFF (SFD=2byte)
command (and SetData[Dec])? >tantdv 1	->Antenna diversity Mode ON
command (and SetData[Dec])? >t7 0x11	->PER and BER measurement started

(4) Start packet transmission

Start packet transmission from SG.

It is required to carry out packet transmission according to the constraints shown in Chapter 3.

(5) Confirmation of measurement results

After the packet transmission from SG is completed, check the receiver characteristics of each RX DUT displayed in the terminal software.

PER / BER / RSSI can be confirmed as the receiver characteristic.

5.3 Measurement results

Measurement results of PER characteristics and RSSI (Average value) when ATT=10dB in either ANT1 or ANT2 are shown below.

The signal conditions are as follows.

- Data rate=100kbps (m=1)
- Ch=927.1MHz
- Data length=20byte
- FCS length=4byte
- Preamble length=15byte

In addition, setting contents of each RX DUT are the same as Table 10 to 12.

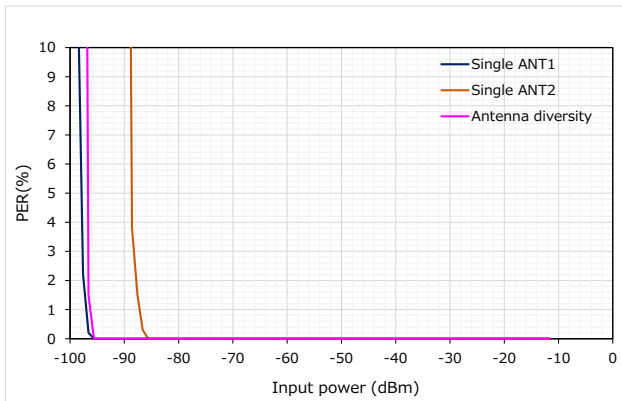

Figure 4. PER (ATT10dB on ANT2 side)

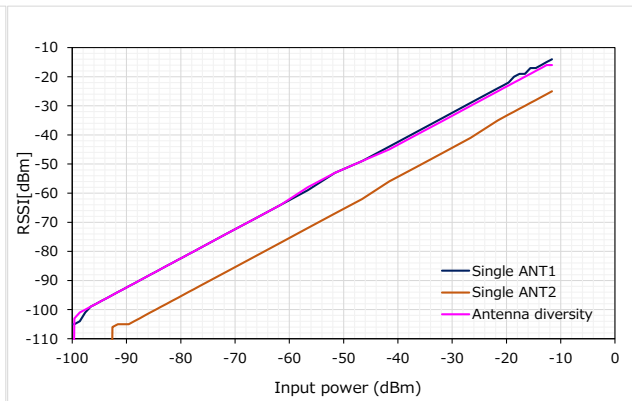

Figure 5. RSSI (ATT10dB on ANT2 side)

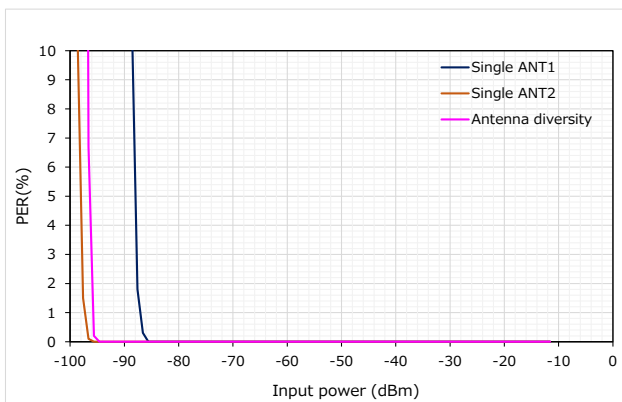

Figure 6. PER (ATT10dB on ANT1 side)

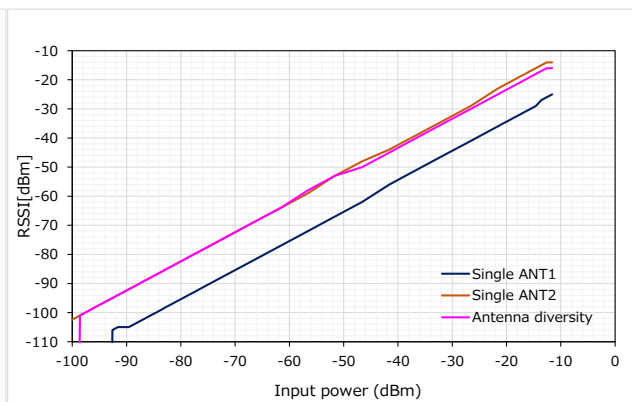

Figure 7. RSSI (ATT10dB on ANT1 side)

As shown in Figure 5 and Figure 7, there is around 10dB difference in RSSI between ANT1 and ANT2.

RSSI of antenna diversity is closer to the one of single antenna on the side without ATT. Also, as shown in Figure 4 and Figure 6, PER characteristics of antenna diversity is close to that of single antenna on the side without ATT, too.

In this way, it can be confirmed that diversity feature is working normally.

6. Field evaluation of wireless condition

6.1 Measurement system

The measurement system is shown in Figure 8 and Figure 9.

For the transmitting system, TX DUT that has acquired radio wave certification is used, and installed in a fixed location on the office floor.

The receiving system has the same configuration as in Chapter 5 and is installed in a conference room on the same office floor far from the transmitting system.

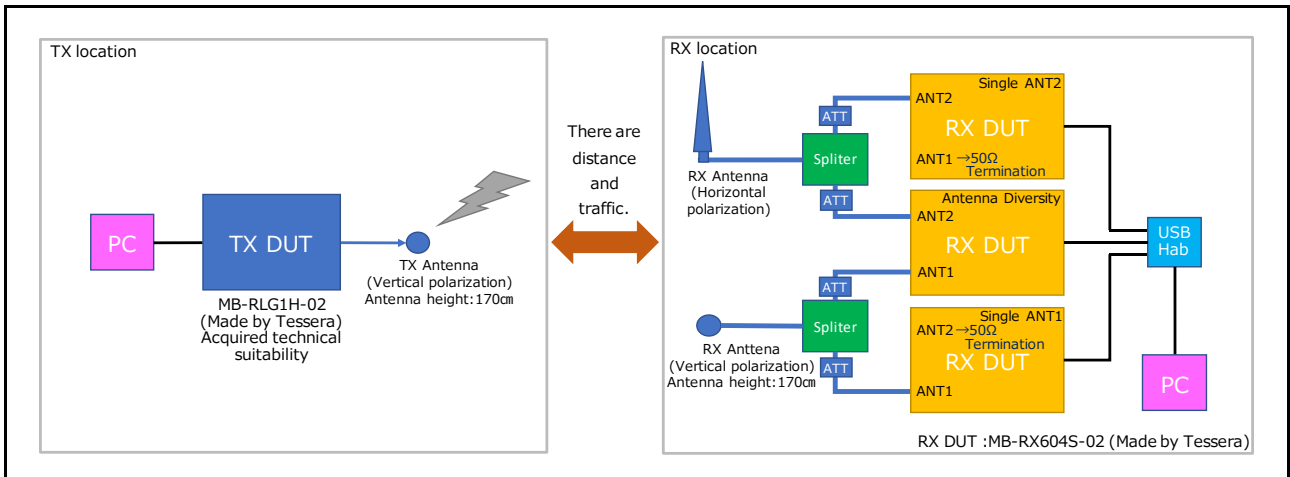

Figure 8. ANT1: Vertical polarization ANT2: Horizontal polarization

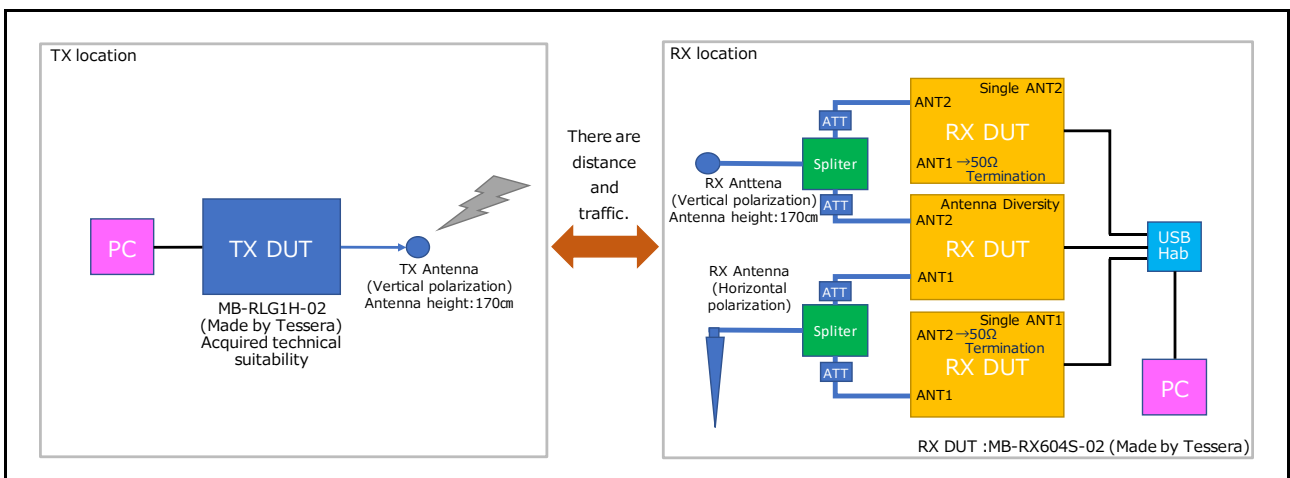

Figure 9. ANT1: Horizontal polarization ANT2: Vertical polarization

Below are the photos of the transmitting system and receiving system set up as shown in Figure 8 and Figure 9.

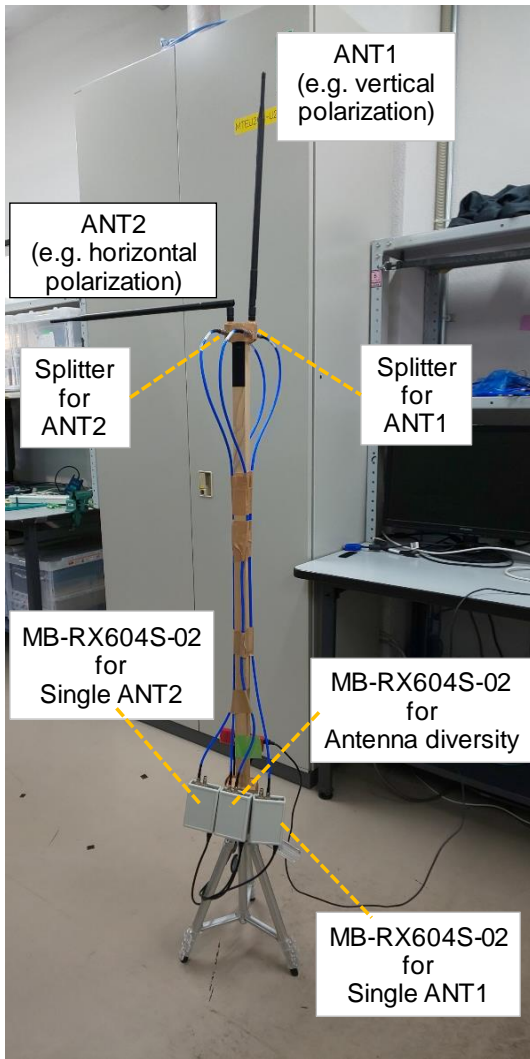

Figure 10. receiving system



Figure 11. transmitting system

6.2 Measurement procedure

(1) Connect RX DUT and PC with USB cable

As in Chapter 5, connect PC and each RX DUT with USB cable.

(2) Start terminal software of PC

As in Chapter 5, start terminal software and set the serial port.

(3) Setting command to RX DUT

The commands to be set in the RX DUT are the same as those in Tables 5 to 7 described in Chapter 5.

(4) Settings command to TX DUT and start packet transmission

In performing wireless communication, it is required to comply with the following conditions specified in the radio regulation of Japan (ARIB).

Table 13. Example conditions specified in the radio regulation of Japan (ARIB).

Transmission power	-> 20mW or less (+13dBm or less)
Unit CH bandwidth	-> 200kHz or less
Simultaneous use CH	-> 2
CCA time	-> 128us or above
Transmission time limit	-> 3ms to 200ms
Pause time	-> 2ms or above
Total transmission time of Wireless CH	-> 360s or less
CCA Threshold	-> -80dBm or less

Based on the provisions shown in Table 13, commands set to TX DUT is shown in Table 14.

Table 14. Setting TX DUT

command (and SetData[Dec])? >tfband 9	->Frequency setting (Japan)
command (and SetData[Dec])? >tfsk 2	->Modulation method setting (100kbps_m=1)
command (and SetData[Dec])? >t2 32	->Channel number setting (e.g.,927.1MHz)
command (and SetData[Dec])? >t4 90	->Output power setting (e.g., +13dBm)
command (and SetData[Dec])? >tpl 15	->Preamble length setting (15byte)
command (and SetData[Dec])? >t5 20	->TX packet length setting (e.g., 20byte)
command (and SetData[Dec])? >tfc3 4	->FCS length setting (e.g., 4byte)
command (and SetData[Dec])? >ti 100000	->TX interval setting (e.g., 100ms)
command (and SetData[Dec])? >tccavt 0x01AA	->CCA Level threshold setting (e.g.,-86dBm)
command (and SetData[Dec])? >tccavt 36	->CCA Duration setting (e.g., 360us)
command (and SetData[Dec])? >tberpn9 1	->PN9 mode setting ON
command (and SetData[Dec])? >tdw 1	->Data Whitening ON
command (and SetData[Dec])? >txopt 1	->CCA enable
command (and SetData[Dec])? >tttl 1	->Total transmission settings ON
command (and SetData[Dec])? >t6 50000	->Start packet transmission (e.g., 50000packet)

(5) Confirmation of measurement results

As in Chapter 5, check the receiver characteristics after the packet transmission is completed.

6.3 Measurement results

Measurement results of PER characteristics and RSSI characteristics are shown below.

6.3.1 Test 1

The receiving system was installed in the conference room more than 50 meters away from the transmitting system. Between the transmitting system and the receiving system, there are many desks and chairs, and many people come and go.

The signal conditions are as follows.

- Data rate=100kbps (m=1)
- Ch=927.1MHz
- Data length=20byte
- FCS length=4byte
- Preamble length=15byte
- TX interval=100msec

In addition, setting contents of each RX DUT and TX DUT are the same as Table 10 to 12 and Table 14, respectively.

Table 15. Test1 measurement results

TX			RX					
Real communication time	Number of successful transmissions	Busy	Antenna	Polarization	Packet			RSSI [dBm]
					OK	NG	PER[%]	
87min 11sec	49341	659	ANT1	vertical	49338	0	0.0061	-92
			ANT2	horizontal	26367	2283	46.5617	-101
			Diversity	-	49260	0	0.1642	-92
87min 11sec	49278	722	ANT1	horizontal	30992	2748	37.1869	-100
			ANT2	vertical	49340	0	0	-92
			Diversity	-	49330	0	0.0203	-91

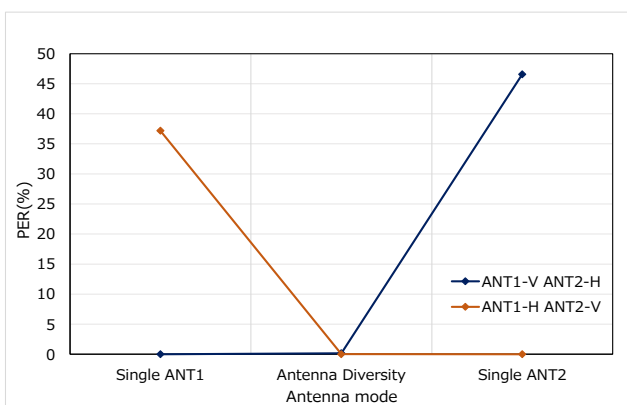

Figure 12. PER characteristics of Test 1

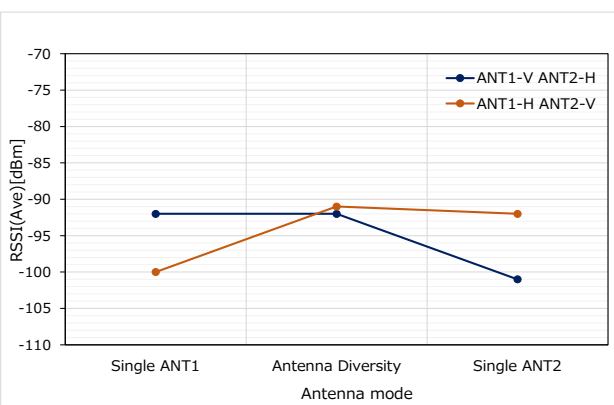

Figure 13. RSSI characteristics of Test 1

As shown in Table 15 and Figure 13, RSSI of antenna diversity is almost the same as that of single antenna of vertical polarization. And, as shown in Table 15 and Figure 12, PER characteristics of antenna diversity is close to that of single antenna of vertical polarization.

For antenna diversity, the antenna with the better BER characteristics is selected as a result.

6.3.2 Test 2

Measurement results of wireless communication while moving receiving system are shown below. The location of the transmitting system is the same as that of TEST 1, and the location where the receiving system moves is 50 meters or more away from the transmitting system, such as the office floor, stairs halls, elevator halls, downstairs, upstairs.

The signal conditions are as follows.

- Data rate=100kbps (m=1)
- Ch=927.1MHz
- Data length=20byte
- FCS length=4byte
- Preamble length=15byte
- TX interval=22msec

In addition, setting contents of each RX DUT and TX DUT are the same as Table 10 to 12 and Table 14, respectively.

Table 16. Test 2 measurement results

TX			RX					
Real communication time	Number of successful transmissions	Busy	Antenna	Polarization	Packet			RSSI [dBm]
					OK	NG	PER[%]	
22min 10sec	49473	563	ANT1	Vertical	46505	423	5.9992	-93
			ANT2	Horizontal	45836	387	7.3515	-92
			Diversity	-	48058	2	2.8602	-90
22min 10sec	49389	611	ANT1	Horizontal	44467	572	9.9658	-93
			ANT2	Vertical	45069	490	8.7469	-94
			Diversity	-	46905	2	5.0295	-91

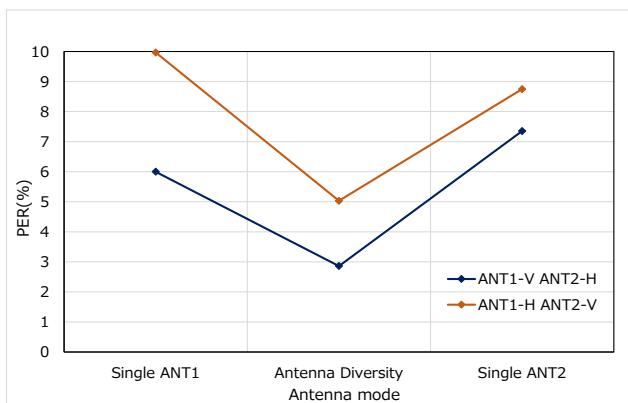

Figure 14. PER characteristics of Test 2

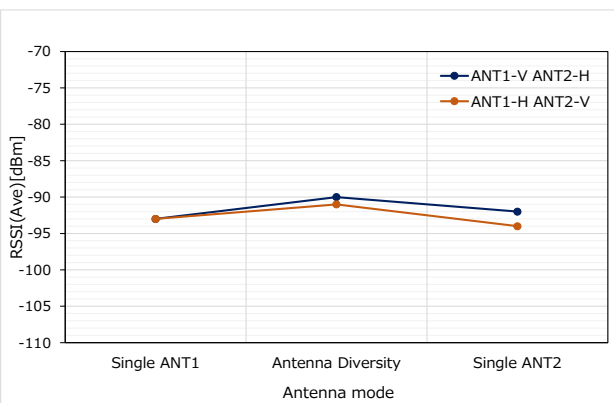

Figure 15. RSSI characteristics of Test 2

By communicating while carrying the receiving system, it is greatly affected by the traffic, and the communication distance also fluctuates. Since the polarizations of ANT1 and ANT2 are different, the receiving antenna switches depending on the location. Antenna diversity resulted in the highest RSSI as shown in Figure 15, and the best PER characteristics as shown in Table 16 and Figure 14, compared to each single antenna.

Revision History

Rev.	Date	Description	
		Page	Summary
1.00	Jan. 25, 2022	-	First edition issued
1.01	July 26, 2024	p.3	Typo correction. (Corrected 2FSK to 2GFSK)

General Precautions in the Handling of Microprocessing Unit and Microcontroller Unit Products

The following usage notes are applicable to all Microprocessing unit and Microcontroller unit products from Renesas. For detailed usage notes on the products covered by this document, refer to the relevant sections of the document as well as any technical updates that have been issued for the products.

1. Precaution against Electrostatic Discharge (ESD)

A strong electrical field, when exposed to a CMOS device, can cause destruction of the gate oxide and ultimately degrade the device operation. Steps must be taken to stop the generation of static electricity as much as possible, and quickly dissipate it when it occurs. Environmental control must be adequate. When it is dry, a humidifier should be used. This is recommended to avoid using insulators that can easily build up static electricity.

Semiconductor devices must be stored and transported in an anti-static container, static shielding bag or conductive material. All test and measurement tools including work benches and floors must be grounded. The operator must also be grounded using a wrist strap. Semiconductor devices must not be touched with bare hands. Similar precautions must be taken for printed circuit boards with mounted semiconductor devices.

2. Processing at power-on

The state of the product is undefined at the time when power is supplied. The states of internal circuits in the LSI are indeterminate and the states of register settings and pins are undefined at the time when power is supplied. In a finished product where the reset signal is applied to the external reset pin, the states of pins are not guaranteed from the time when power is supplied until the reset process is completed. In a similar way, the states of pins in a product that is reset by an on-chip power-on reset function are not guaranteed from the time when power is supplied until the power reaches the level at which resetting is specified.

3. Input of signal during power-off state

Do not input signals or an I/O pull-up power supply while the device is powered off. The current injection that results from input of such a signal or I/O pull-up power supply may cause malfunction and the abnormal current that passes in the device at this time may cause degradation of internal elements. Follow the guideline for input signal during power-off state as described in your product documentation.

4. Handling of unused pins

Handle unused pins in accordance with the directions given under handling of unused pins in the manual. The input pins of CMOS products are generally in the high-impedance state. In operation with an unused pin in the open-circuit state, extra electromagnetic noise is induced in the vicinity of the LSI, an associated shoot-through current flows internally, and malfunctions occur due to the false recognition of the pin state as an input signal become possible.

5. Clock signals

After applying a reset, only release the reset line after the operating clock signal becomes stable. When switching the clock signal during program execution, wait until the target clock signal is stabilized. When the clock signal is generated with an external resonator or from an external oscillator during a reset, ensure that the reset line is only released after full stabilization of the clock signal. Additionally, when switching to a clock signal produced with an external resonator or by an external oscillator while program execution is in progress, wait until the target clock signal is stable.

6. Voltage application waveform at input pin

Waveform distortion due to input noise or a reflected wave may cause malfunction. If the input of the CMOS device stays in the area between V_{IL} (Max.) and V_{IH} (Min.) due to noise, for example, the device may malfunction. Take care to prevent chattering noise from entering the device when the input level is fixed, and also in the transition period when the input level passes through the area between V_{IL} (Max.) and V_{IH} (Min.).

7. Prohibition of access to reserved addresses

Access to reserved addresses is prohibited. The reserved addresses are provided for possible future expansion of functions. Do not access these addresses as the correct operation of the LSI is not guaranteed.

8. Differences between products

Before changing from one product to another, for example to a product with a different part number, confirm that the change will not lead to problems. The characteristics of a microprocessing unit or microcontroller unit products in the same group but having a different part number might differ in terms of internal memory capacity, layout pattern, and other factors, which can affect the ranges of electrical characteristics, such as characteristic values, operating margins, immunity to noise, and amount of radiated noise. When changing to a product with a different part number, implement a system-evaluation test for the given product.

Notice

1. Descriptions of circuits, software and other related information in this document are provided only to illustrate the operation of semiconductor products and application examples. You are fully responsible for the incorporation or any other use of the circuits, software, and information in the design of your product or system. Renesas Electronics disclaims any and all liability for any losses and damages incurred by you or third parties arising from the use of these circuits, software, or information.
2. Renesas Electronics hereby expressly disclaims any warranties against and liability for infringement or any other claims involving patents, copyrights, or other intellectual property rights of third parties, by or arising from the use of Renesas Electronics products or technical information described in this document, including but not limited to, the product data, drawings, charts, programs, algorithms, and application examples.
3. No license, express, implied or otherwise, is granted hereby under any patents, copyrights or other intellectual property rights of Renesas Electronics or others.
4. You shall be responsible for determining what licenses are required from any third parties, and obtaining such licenses for the lawful import, export, manufacture, sales, utilization, distribution or other disposal of any products incorporating Renesas Electronics products, if required.
5. You shall not alter, modify, copy, or reverse engineer any Renesas Electronics product, whether in whole or in part. Renesas Electronics disclaims any and all liability for any losses or damages incurred by you or third parties arising from such alteration, modification, copying or reverse engineering.
6. Renesas Electronics products are classified according to the following two quality grades: "Standard" and "High Quality". The intended applications for each Renesas Electronics product depends on the product's quality grade, as indicated below.

"Standard": Computers; office equipment; communications equipment; test and measurement equipment; audio and visual equipment; home electronic appliances; machine tools; personal electronic equipment; industrial robots; etc.

"High Quality": Transportation equipment (automobiles, trains, ships, etc.); traffic control (traffic lights); large-scale communication equipment; key financial terminal systems; safety control equipment; etc.

Unless expressly designated as a high reliability product or a product for harsh environments in a Renesas Electronics data sheet or other Renesas Electronics document, Renesas Electronics products are not intended or authorized for use in products or systems that may pose a direct threat to human life or bodily injury (artificial life support devices or systems; surgical implantations; etc.), or may cause serious property damage (space system; undersea repeaters; nuclear power control systems; aircraft control systems; key plant systems; military equipment; etc.). Renesas Electronics disclaims any and all liability for any damages or losses incurred by you or any third parties arising from the use of any Renesas Electronics product that is inconsistent with any Renesas Electronics data sheet, user's manual or other Renesas Electronics document.
7. No semiconductor product is absolutely secure. Notwithstanding any security measures or features that may be implemented in Renesas Electronics hardware or software products, Renesas Electronics shall have absolutely no liability arising out of any vulnerability or security breach, including but not limited to any unauthorized access to or use of a Renesas Electronics product or a system that uses a Renesas Electronics product. RENESAS ELECTRONICS DOES NOT WARRANT OR GUARANTEE THAT RENESAS ELECTRONICS PRODUCTS, OR ANY SYSTEMS CREATED USING RENESAS ELECTRONICS PRODUCTS WILL BE INVULNERABLE OR FREE FROM CORRUPTION, ATTACK, VIRUSES, INTERFERENCE, HACKING, DATA LOSS OR THEFT, OR OTHER SECURITY INTRUSION ("Vulnerability Issues"). RENESAS ELECTRONICS DISCLAIMS ANY AND ALL RESPONSIBILITY OR LIABILITY ARISING FROM OR RELATED TO ANY VULNERABILITY ISSUES. FURTHERMORE, TO THE EXTENT PERMITTED BY APPLICABLE LAW, RENESAS ELECTRONICS DISCLAIMS ANY AND ALL WARRANTIES, EXPRESS OR IMPLIED, WITH RESPECT TO THIS DOCUMENT AND ANY RELATED OR ACCOMPANYING SOFTWARE OR HARDWARE, INCLUDING BUT NOT LIMITED TO THE IMPLIED WARRANTIES OF MERCHANTABILITY, OR FITNESS FOR A PARTICULAR PURPOSE.
8. When using Renesas Electronics products, refer to the latest product information (data sheets, user's manuals, application notes, "General Notes for Handling and Using Semiconductor Devices" in the reliability handbook, etc.), and ensure that usage conditions are within the ranges specified by Renesas Electronics with respect to maximum ratings, operating power supply voltage range, heat dissipation characteristics, installation, etc. Renesas Electronics disclaims any and all liability for any malfunctions, failure or accident arising out of the use of Renesas Electronics products outside of such specified ranges.
9. Although Renesas Electronics endeavors to improve the quality and reliability of Renesas Electronics products, semiconductor products have specific characteristics, such as the occurrence of failure at a certain rate and malfunctions under certain use conditions. Unless designated as a high reliability product or a product for harsh environments in a Renesas Electronics data sheet or other Renesas Electronics document, Renesas Electronics products are not subject to radiation resistance design. You are responsible for implementing safety measures to guard against the possibility of bodily injury, injury or damage caused by fire, and/or danger to the public in the event of a failure or malfunction of Renesas Electronics products, such as safety design for hardware and software, including but not limited to redundancy, fire control and malfunction prevention, appropriate treatment for aging degradation or any other appropriate measures. Because the evaluation of microcomputer software alone is very difficult and impractical, you are responsible for evaluating the safety of the final products or systems manufactured by you.
10. Please contact a Renesas Electronics sales office for details as to environmental matters such as the environmental compatibility of each Renesas Electronics product. You are responsible for carefully and sufficiently investigating applicable laws and regulations that regulate the inclusion or use of controlled substances, including without limitation, the EU RoHS Directive, and using Renesas Electronics products in compliance with all these applicable laws and regulations. Renesas Electronics disclaims any and all liability for damages or losses occurring as a result of your noncompliance with applicable laws and regulations.
11. Renesas Electronics products and technologies shall not be used for or incorporated into any products or systems whose manufacture, use, or sale is prohibited under any applicable domestic or foreign laws or regulations. You shall comply with any applicable export control laws and regulations promulgated and administered by the governments of any countries asserting jurisdiction over the parties or transactions.
12. It is the responsibility of the buyer or distributor of Renesas Electronics products, or any other party who distributes, disposes of, or otherwise sells or transfers the product to a third party, to notify such third party in advance of the contents and conditions set forth in this document.
13. This document shall not be reprinted, reproduced or duplicated in any form, in whole or in part, without prior written consent of Renesas Electronics.
14. Please contact a Renesas Electronics sales office if you have any questions regarding the information contained in this document or Renesas Electronics products.

(Note1) "Renesas Electronics" as used in this document means Renesas Electronics Corporation and also includes its directly or indirectly controlled subsidiaries.

(Note2) "Renesas Electronics product(s)" means any product developed or manufactured by or for Renesas Electronics.

(Rev.5.0-1 October 2020)

Corporate Headquarters

TOYOSU FORESIA, 3-2-24 Toyosu,
Koto-ku, Tokyo 135-0061, Japan
www.renesas.com

Trademarks

Renesas and the Renesas logo are trademarks of Renesas Electronics Corporation. All trademarks and registered trademarks are the property of their respective owners.

Contact information

For further information on a product, technology, the most up-to-date version of a document, or your nearest sales office, please visit:
www.renesas.com/contact/.