

RA6W1 PMGR DPM

The RA6W1 is a highly integrated, ultra-low-power Wi-Fi MCU that enables users to develop a complete Wi-Fi solution on a single chip. The RA6W2 module is comprised of the RA6W1 (Wi-Fi) and the DA14531 (Bluetooth® Low Energy) MCU. This document describes the power management features supported by the RA6W1 and RA6W2 and explains how the PMGR module can be used for low-power applications.

Contents

Contents	1
Figures	2
Tables	2
1. Terms and Definitions	3
2. References.	3
3. Introduction	4
4. Sleep Modes	5
4.1 Sleep Mode 1	5
4.2 Sleep Mode 2	5
4.3 Sleep Mode 3	5
4.4 Sleep Mode 3 + DPM LPM	5
4.5 Sleep Mode 4	5
5. PMGR	6
5.1 PMGR Interaction with Application	6
6. PMGR DPM	8
6.1 DPM Modes	8
6.1.1 Power Saving Modes in DPM LPM	9
6.2 DPM Service and Application	10
6.3 PMGR DPM and Bluetooth LE Dependency	12
7. Application Programming Interface	13
7.1 Add PMGR Module in FSP e ² studio	13
7.2 PMGR Power Modes	14
7.3 PMGR Constraints	14
7.4 Wake Sources	14
7.5 Notifier Register	15
7.6 User Data Area in Retention Memory	15
7.7 DPM Port Filtering	16
7.8 LPM Examples	16
7.8.1 Sleep Mode 2 Configuration	16
7.8.2 Sleep Mode 3 Configuration	18
7.8.3 Sleep 3 + DPM LPM Mode Configuration	20
7.8.4 Sleep Mode 4 Configuration	23
7.9 Wake-up Reason from DPM LPM	24

7.10 DPM LPM Specific Configuration	27
8. TCP Client Example with DPM	28
8.1 Using API	28
8.2 Using AT Command	30
Appendix A Comparison of AT Commands: DA16200 vs. RA6W1	33
Appendix B PMGR CLI Commands	34
Appendix C RTM CLI	35
9. Revision History	36

Figures

Figure 1. PMGR internal block diagram	6
Figure 2. PMGR interaction with application	7
Figure 3. DPM modes	8
Figure 4. Power states in DPM mode with legacy DTIM	9
Figure 5. TWT basic flow	10
Figure 6. DPM service in RTOS running mode	11
Figure 7. Application in DPM RTOS running mode	12
Figure 8. API reference	13
Figure 9. PMGR stack in FSP	13
Figure 10. Sleep mode 2 configuration using API	17
Figure 11. Sleep mode 2 configuration using AT command	18
Figure 12. Sleep mode 3 configuration using API	19
Figure 13. Sleep mode 3 configuration using AT command	20
Figure 14. Sleep 3 DPM LPM mode configuration using API	21
Figure 15. Sleep 3 DPM LPM default configuration using AT command	22
Figure 16. Sleep 3 DPM LPM mode configuration using Force AT command	23
Figure 17. Flow of AT commands for waking up by GPIO of MCU	25
Figure 18. Flow of AT commands for waking up by UC from AP	26
Figure 19. Flow of AT commands for waking up by disconnection from AP	27
Figure 20. TCP client send function using API	28
Figure 21. TCP client receive function using API	29
Figure 22. TCP client configuration on DPM	30
Figure 23. TCP client send flow using AT commands	31
Figure 24. TCP client receive flow using AT commands	32
Figure 25. PMGR CLI commands	34
Figure 26. RTM information	35

Tables

Table 1. Power modes	14
Table 2. Constraints	14
Table 3. Wake source	14
Table 4. Notifier priority order	15
Table 5. Port filtering APIs	16
Table 6. BSP wake-up sources	24
Table 7. DPM wake-up types	24
Table 8. Comparison of AT Commands: DA16200 vs. RA6W1	33

1. Terms and Definitions

AP	Access Point
BSP	Board Support Package
CMD	Command
COM	Communication Port
EVB	Evaluation Board
GPIO	General Purpose Input Output
MCU	Micro-controller Unit
PPA	Programmable Pin Assignment
RX	Receive
SDIO	Secure Digital Input Output
SPI	Serial Peripheral Interface
TX	Transmit
UART	Universal Asynchronous Receiver
WAP	Wireless Application Protocol

2. References.

- [1] RA6W1, Datasheet, Renesas Electronics.
- [2] RA6W1 Getting Started Guide, Manual, Renesas Electronics.
- [3] RA6W1 and RA6W2 AT Commands, Manual, Renesas Electronics.
- [4] UM-WI-030, DA16200 DA16600 DPM, Manual, Renesas Electronics.
- [5] UM-WI-003, DA16200 DA16600 Host Interface and AT Command, Manual, Renesas Electronics.

Note 1 References are for the latest published version, unless otherwise indicated.

3. Introduction

Power Manager (PMGR) is a new generic power management FSP module designed to simplify and standardize power management across RA6W1 applications. Power management in modern embedded systems is critical for optimizing battery life and reducing energy consumption. However, different chips and modems implement power-saving features in various ways, making it difficult for developers to manage power efficiently across different solutions.

To address this challenge, the PMGR provides an abstraction layer that enables developers to define power constraints at the application level rather than dealing with complex chip-specific power modes. This ensures that power optimization is handled efficiently and consistently across Renesas' portfolio.

There are five Sleep modes supported by the RA6W1—Sleep mode 1, Sleep mode 2, Sleep mode 3, and Sleep mode 3 + DPM, and Sleep mode 4. This application note focuses on developing and utilizing power-saving techniques supported by the RA6W1 using the PMGR API.

4. Sleep Modes

Currently, the RA6W1 supports four sleep modes: Sleep mode 1, Sleep mode 2, Sleep mode 3, and Sleep 3 + DPM LPM.

4.1 Sleep Mode 1

Sleep 1 mode is a deep sleep/reset state. In this state, power is applied (VBAT), but all internal circuitry is powered off. When reset is de-asserted, the device can start immediately without waiting for power stabilization.

This mode is purely hardware-controlled and cannot be managed through the PMGR API through software.

4.2 Sleep Mode 2

In this state, all power domains are off except for the RTC and wake-up pins, allowing a timer or an external event to trigger the device to wake up from sleep..

4.3 Sleep Mode 3

In this state, all power domains are off except for the wake-up pins and retention memory (RTM). The RTM preserves system information.

4.4 Sleep Mode 3 + DPM LPM

In this state, all power domains are off except for the wake-up pins, and retention memory. The retention memory retains system information, including the Wi-Fi state, enabling a fast wake-up for simple network management tasks such as DTIM processing.

Additionally, this sleep mode allows the device (Station mode) to remain in a low-power state while maintaining its connection with the Access Point, ensuring efficient power management without losing network connectivity. If required, a full system wake-up can also be triggered.

NOTE
SDK 8.0.2 does not support wake up through RTC timer in Sleep 3.

4.5 Sleep Mode 4

In this state, all power domains are turned off except for the Real-Time Clock (RTC), wake-up pins, RAM, LDO, and the M33 tick-less timer. Upon wake-up, the Cortex-M33 CPU resumes execution from the same task context.

- RAM remains powered (all 704 kB)
- Wake-up events: device can wake on a unicast beacon packet with fast recovery
- Application continuity: no software or application reinitialization is required.

5. PMGR

Figure 1 shows the PMGR internal block diagram. The PMGR module consists of multiple internal blocks that work together to manage low-power modes efficiently. Applications communicate with the PMGR through the `rm_pmgr_w` blocks. Here `rm_wifi` represents the Wi-Fi application, which also operates on top of the PMGR to support DPM LPM. When FreeRTOS has no active tasks to execute, the Idle Task invokes the PMGR, which then determines the appropriate sleep mode to trigger.

The `rm_pmgr_w` module interacts with `pm_ild`, a low-level power management driver responsible for switching between different low-power modes. DPM functions are handled by `dpm_ild`, which checks preconditions for DPM sleep, notifies callbacks when the system is entering into low power mode, and initiates DPM sleep by calling `sleep3_ild`.

The `sleep3_ild` (PTIM) is a lightweight firmware running in the DPM LPM state, ensuring Wi-Fi connectivity by monitoring AP frames and sending keep-alive frames. The PMGR communicates with the RTC to manage wake-up timers and with GPIO to monitor interrupts for waking up from low-power modes. Network connectivity during DPM LPM is maintained by storing essential parameters such as socket states, ARP tables, and DHCP configurations in retention memory in association with LWIP. When `sleep3_ild` receives a packet, it forwards it to the MAC driver (MAC DPM DRV), which then delivers the packet to the upper layers when the application is ready to receive it.

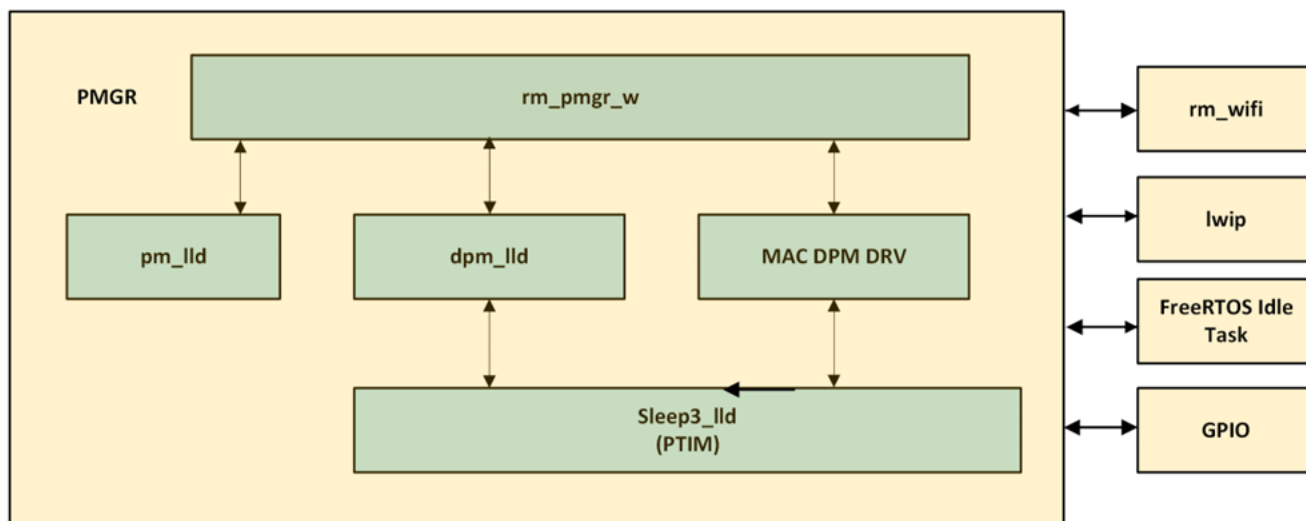

Figure 1. PMGR internal block diagram

5.1 PMGR Interaction with Application

Figure 2 shows how the PMGR interacts with applications.

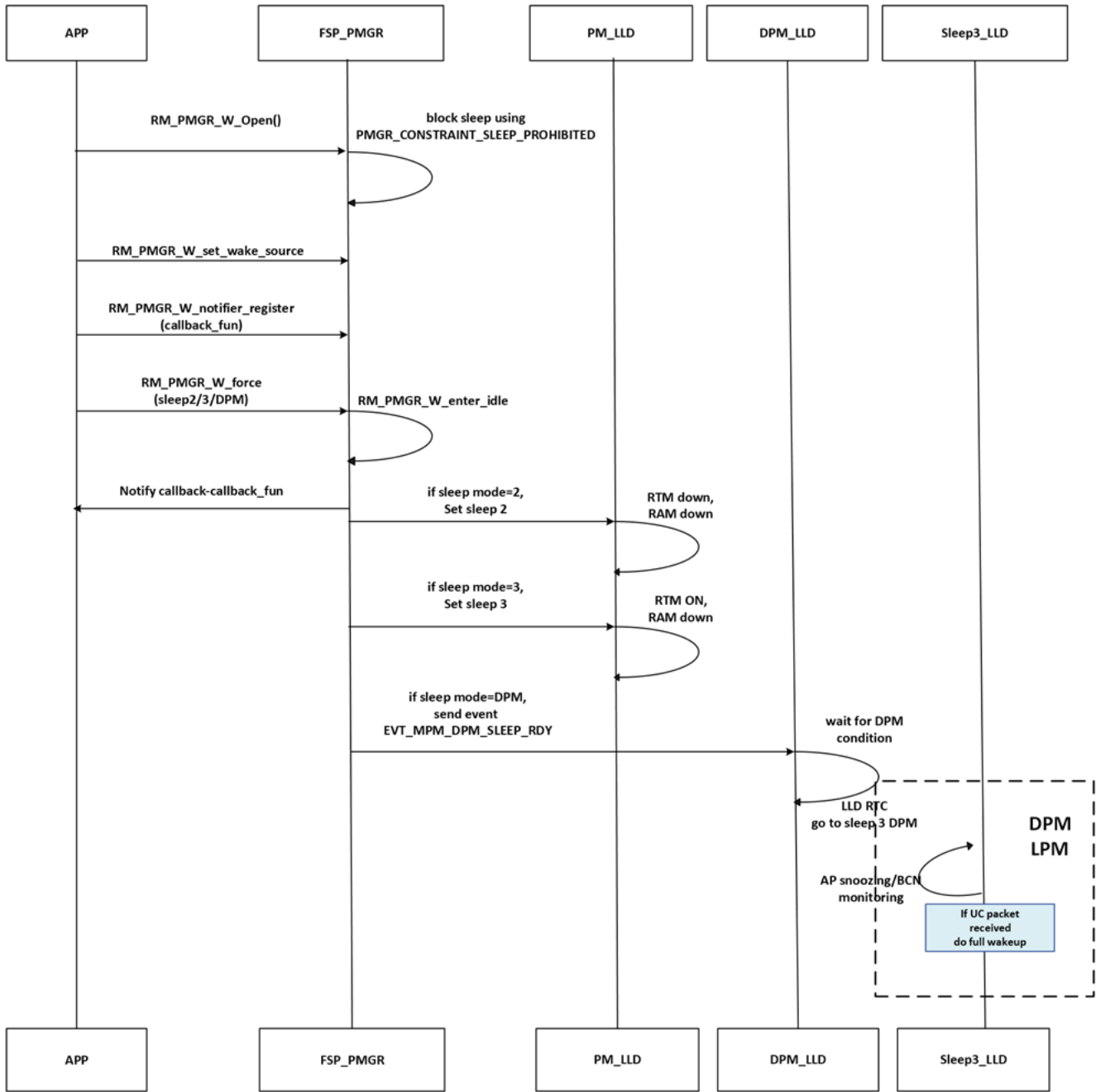

Figure 2. PMGR interaction with application

6. PMGR DPM

Dynamic Power Management (DPM) is a technology to achieve low power consumption while connecting to access point (AP) or peer for a long time. If device has no actions for sending data to peer devices or communicating with external devices, the device can keep a low power state while waiting to receive any data from peer.

6.1 DPM Modes

DPM provides two different sub-modes: RTOS Running Mode and DPM Low Power mode (LPM). RTOS Running mode allows a device to communicate over the network and with external devices, while DPM LPM enables a device to receive data only from the AP.

In DPM mode, the DPM service starts, monitors the state of applications, and manages the transition from RTOS Running mode to DPM LPM. Additionally, the DPM service controls timer functions and transfers received data to the relevant applications.

Figure 3 shows how DPM mode operates. DPM can be enabled only in Wireless Application Protocol (WAP) that is in 802.11 Station mode and when the device is in a Wi-Fi-connected state. Therefore, provisioning is required to configure AP profiles before entering DPM LPM. Transitioning from RTOS running mode to DPM LPM may take some time due to various processing tasks, see Figure 7

For application monitoring, register the job name with the DPM service first. To register job names, use `RM_PMGR_W_dpm_job_name_set()`. Each time the device enters RTOS Running mode, the DPM service and applications are restarted, and applications must be re-registered with the DPM service.

The DPM service monitors sleep constraints. If an application needs to prevent sleep, it calls `RM_PMGR_W_add_sleep_constraint()` with the constraint `PMGR_CONSTRAINT_POWER_RAM`. When the application is ready for sleep, it calls `RM_PMGR_W_remove_sleep_constraint()` with the same constraint.

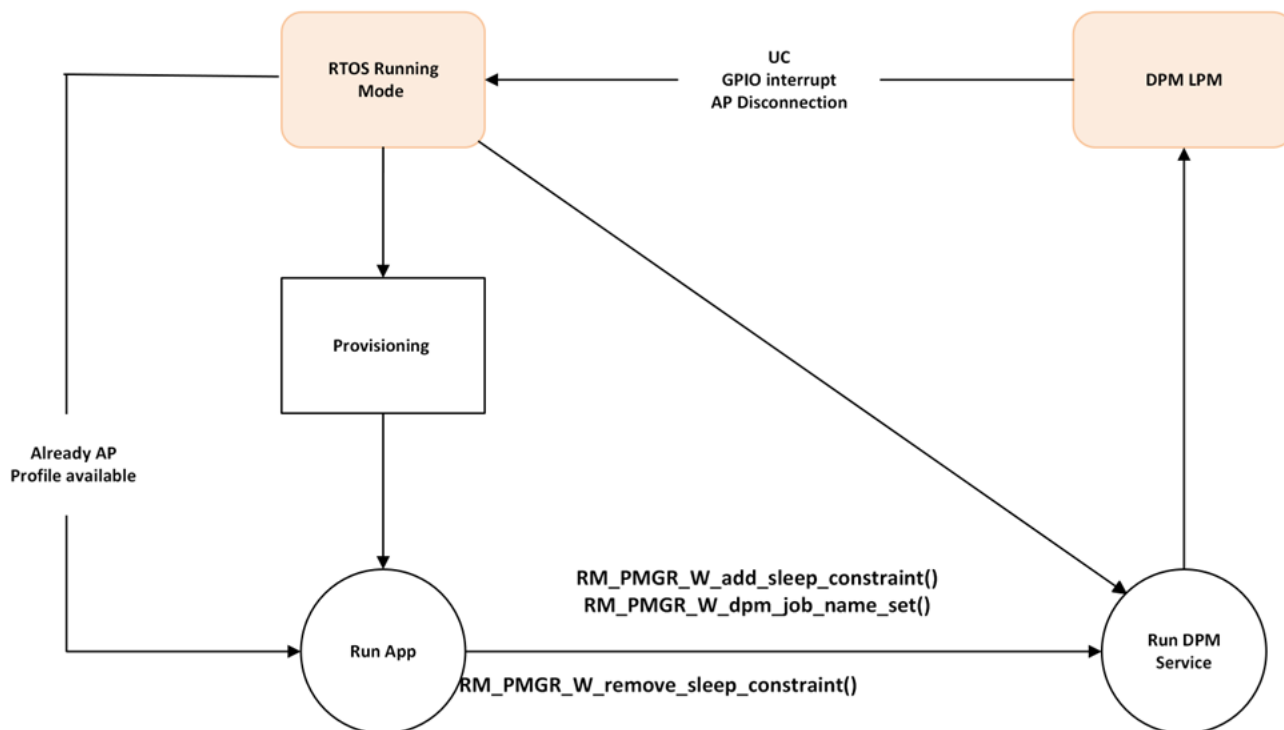

Figure 3. DPM modes

6.1.1 Power Saving Modes in DPM LPM

DPM mode uses 802.11 standard features to achieve low power consumption while keeping connection with the AP. The 802.11 PS features are legacy PS and TWT. Legacy PS mechanism is based on DTIM beacon interval. It listens to DTIM beacon based on DPM configuration and schedule other tasks (PS-Poll transmission) according to Beacon TIM element information. TWT mechanism is based on TWT setup to schedule AP-STA frames exchange.

The software supports both legacy PS (DTIM) and TWT features and can switch between both modes dynamically.

Figure 4 shows power states in the DPM mode using Legacy PS. The device can send data to peer devices over the network and communicate with external devices like peripherals or a host device only in RTOS running mode.

When the device enters DPM LPM, a firmware for Delivery Traffic Indication Message (DTIM) runs on retention RAM (or RTM) with DTIM interval periodically. The PTIM is a tiny firmware image only for checking data from AP such as UC, BC/MC, or BCN. The device stays in Sleep mode 3 when PTIM is not active in DPM LPM.

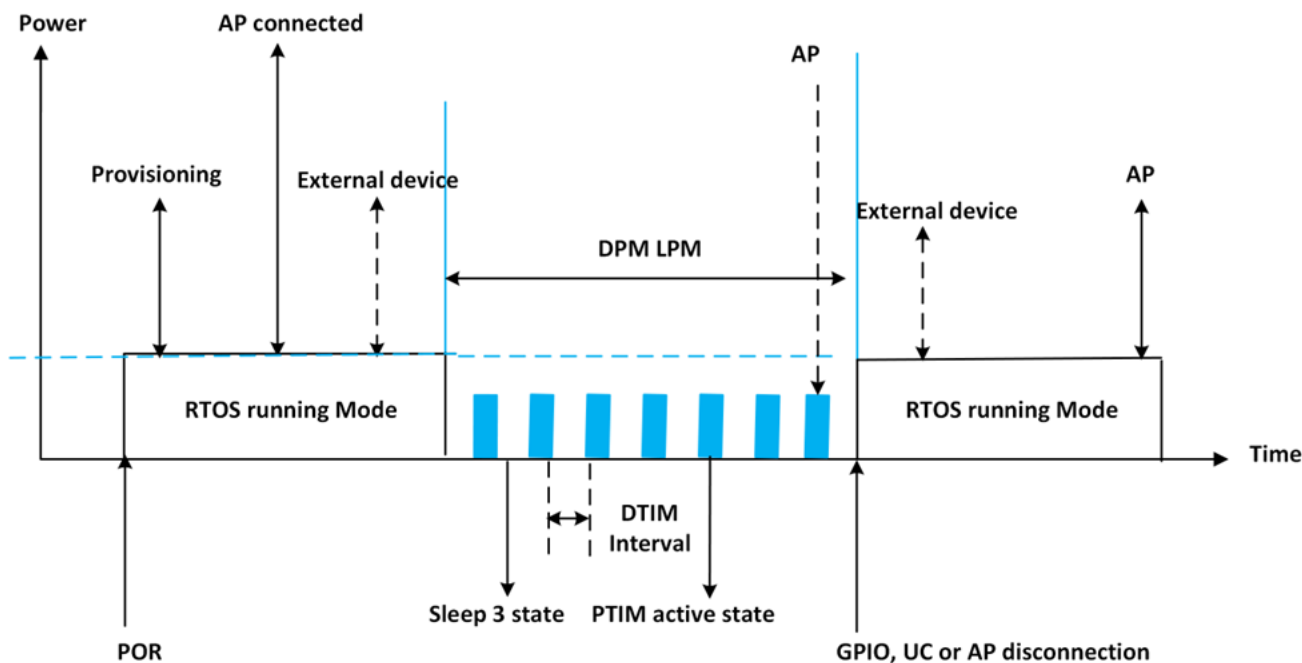

Figure 4. Power states in DPM mode with legacy DTIM

Target Wake Time (TWT) is a new power saving feature introduced in the IEEE 802.11ax standard. TWT enables STAs and AP to schedule specific times for the STA to wake up and communicate. Generally, TWT agreement is defined by:

- TWT Service period (TWT-SP) – The STA wake duration
- TWT wake interval – the period between two consecutive TWT SP, see Figure 5

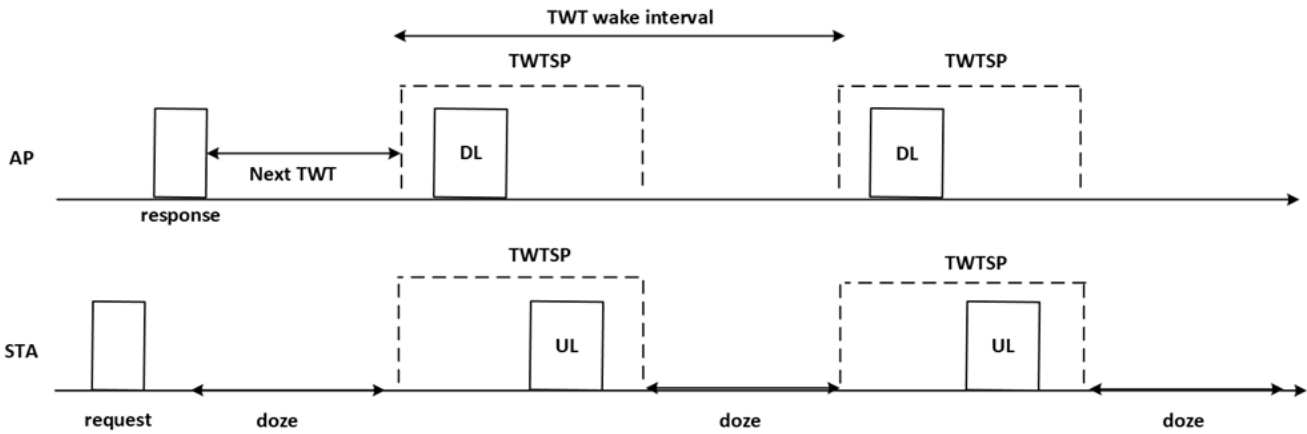

Figure 5. TWT basic flow

6.2 DPM Service and Application

When data from AP or peer device are received, a registered DPM timer is expired or GPIO interrupts occur in DPM LPM, the device wakes up from DPM LPM and DPM service runs in RTOS running mode. Figure 6 shows how the DPM service manages the received data and callback of DPM timer, and monitors applications in RTOS Running mode.

If the network session is connected with peer devices and there is received data from peers, the application needs to be registered with the port number within 200 ms because DPM service checks the port number where the data is received from peers and then transfers the data to the application with the same port number. Also, the application must notify that it is in ready state for receiving the data to the DPM service within 7000 ms using `RM_PMGR_W_dpm_rcv_ready_set()` after waking up from DPM LPM. Otherwise, DPM service drops the data because network stack cannot keep the data for a long time.

DPM timer is registered by the application and can be expired in RTOS Running mode or DPM LPM. When the timer is expired, the DPM service checks whether the application is registered and ready to get the callback. Therefore, the application must be registered at every wake-up from DPM LPM and notify the DPM service that it is ready using `RM_PMGR_W_dpm_wakeup_done()`.

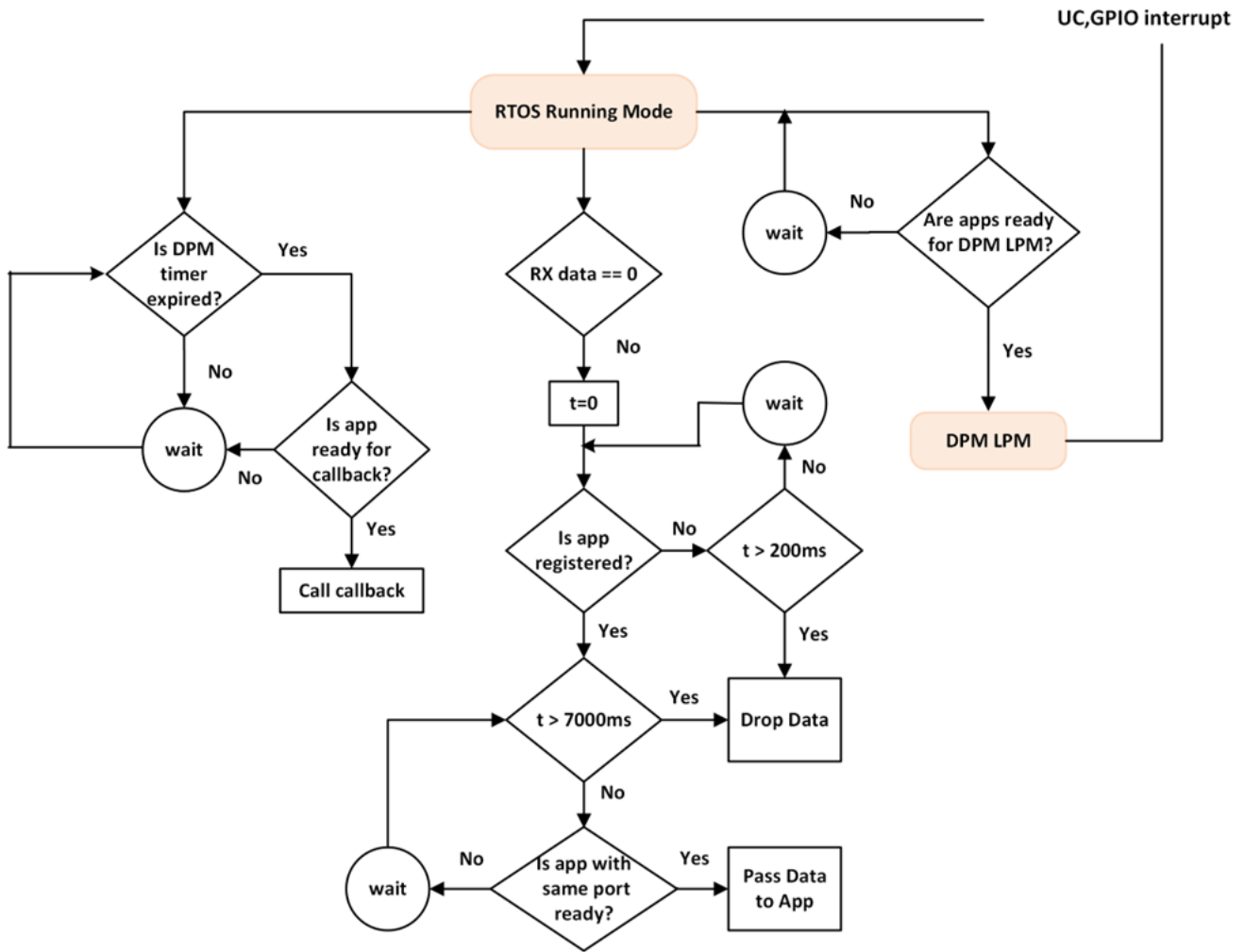

Figure 6. DPM service in RTOS running mode

Figure 7 shows how to register applications and notify the state of applications to the DPM service.

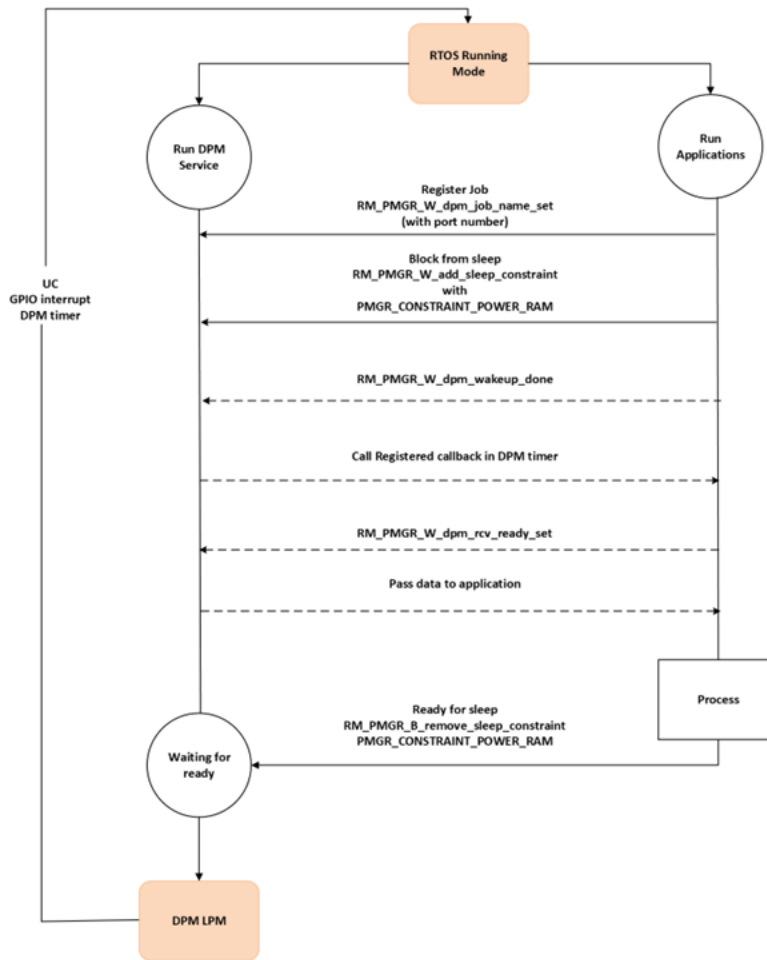

Figure 7. Application in DPM RTOS running mode

6.3 PMGR DPM and Bluetooth LE Dependency

The RA6W2 can enter DPM LPM mode only when Bluetooth LE is turned off, as Bluetooth LE is considered a power constraint. When Bluetooth LE is active, the system automatically adds the PMGR_CONSTRAINT_POWER_RAM constraint. This constraint is removed when Bluetooth LE is turned off.

The FSP API RM_BLE_ABS_Open applies a Bluetooth LE constraint, while RM_BLE_ABS_Close removes it. To allow the device to enter DPM LPM, you must either stop the Bluetooth LE service or set Bluetooth LE to Hibernate mode.

To stop the Bluetooth LE service:

1. Disconnect any active connections using R_BLE_GAP_Disconnect().
2. Stop advertising with R_BLE_GAP_StopAdv().
3. Call RM_BLE_ABS_Close() to disable Bluetooth LE and remove the constraint.

Alternatively, to place Bluetooth LE directly into Hibernate mode, use the AT command: AT+SLEEP=3.

7. Application Programming Interface

All PMGR APIs are documented in the RA6W1 Flexible Software Package. You can find them under **API Reference > Modules > Power > PMGR (rm_pmgr_w)**.



Figure 8. API reference

7.1 Add PMGR Module in FSP e² studio

To add The PMGR module to an FSP project in e² studio, go to **New Stack > Power > PMGR - Power Manager (rm_pmgr_w)**, see [Figure 9](#).

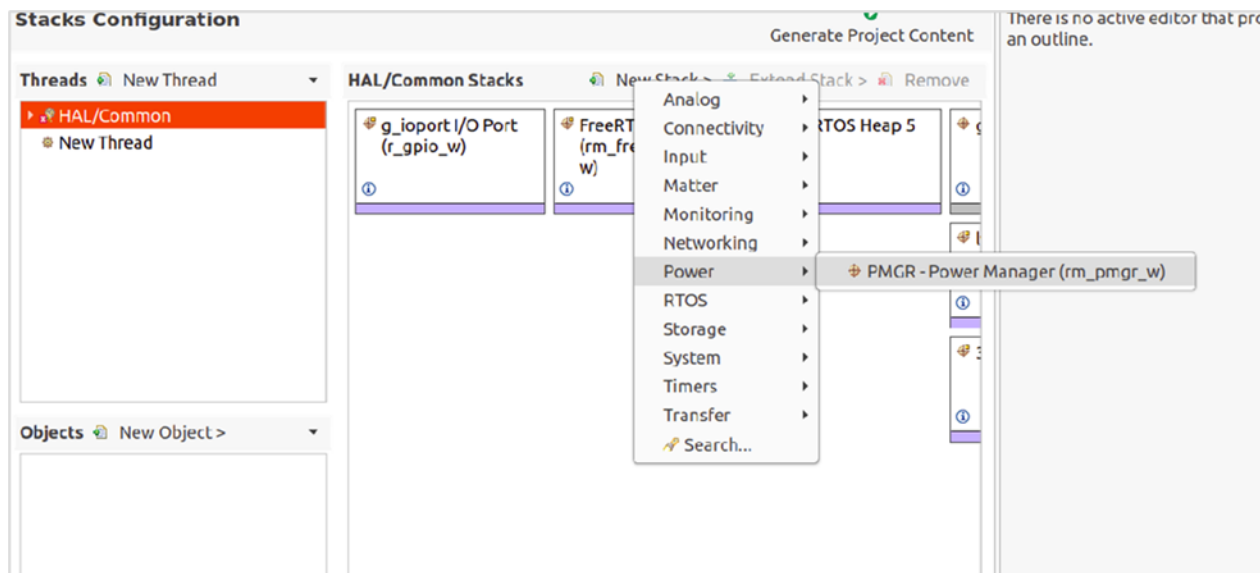

Figure 9. PMGR stack in FSP

7.2 PMGR Power Modes

The PMGR provides multiple power-saving modes to optimize energy consumption based on system requirements. These modes define how the RAM and retention memory are managed during low-power states.

[Table 1](#) summarizes the available PMGR Power modes.

Table 1. Power modes

Power modes	RAM power	Retention memory	Behavior
PMGR_LLD_STATE2	OFF	OFF	Deep Sleep mode, no retention.
PMGR_LLD_STATE3	OFF	ON	RAM is powered down; retention memory is active.
PMGR_LLD_DPM	OFF	ON	Same as PMGR_LLD_STATE3, with AP snoozing is enabled.
PMGR_LLD_POWER_MODE_SLEEP4	ON	ON	Same as PMGR_LLD_DPM with RAM powered on and M33 tick-less timer.
PMGR_LLD_CPU_CLOCK_GATING	ON	N/A	The CPU clock halted, but the power is maintained.
PMGR_LLD_AUTO	Dynamic	Dynamic	The PMGR selects the optimal power mode automatically.

The PMGR uses `RM_PMGR_W_force()` API for forcefully setting power modes. This function overrides the decision made by PMGR, forcing usage of a given power state. Corresponding AT commands for setting Force mode is `AT+PMGRFORCE`, see [Ref. \[2\]](#).

7.3 PMGR Constraints

The PMGR constraints define restrictions on the system's low-power behavior. These constraints ensure that certain power states remain enabled or disabled based on application requirements. For example, an application might prohibit Sleep modes or require RAM to stay powered to prevent data loss.

The following constraints can be applied to control power states, see [Table 2](#).

Table 2. Constraints

Constraints	Description
PMGR_CONSTRAINT_NON	No constraints: all Sleep modes are allowed.
PMGR_CONSTRAINT_SLEEP_PROHIBITED	Prevent the system from entering any Sleep mode.
PMGR_CONSTRAINT_POWER_RAM	Ensure RAM remains powered on during low-power states.
PMGR_CONSTRAINT_POWER_RETENTION	Ensure retention memory stays powered.

Applications can apply or remove constraints dynamically using the PMGR API - `RM_PMGR_W_add_sleep_constraint()` and `RM_PMGR_W_remove_sleep_constraint()`. Corresponding AT command for sleep constraint is `AT+PMGRCONSTRAINT`. See [Ref. \[3\]](#) for more details.

7.4 Wake Sources

System middleware and customized applications are allowed to specify which components are used as wake source and as such should be kept powered on. Wake source is a bit map, the implementation is Boolean parameter per wake source (no matter how many times a wake source is set, single clear should set it to false).

[Table 3](#) describes the available wake sources in the PMGR.

Table 3. Wake source

Wake source	Description
PMGR_WAKE_SOURCE_NON	No wake source defined.
PMGR_WAKE_SOURCE_GPT	GPT wake source.
PMGR_WAKE_SOURCE_GPIO	GPIO wake source.

Wake source	Description
PMGR_WAKE_SOURCE_ADC	ADC wake source.
PMGR_WAKE_SOURCE_WIFI	Wi-Fi/MAC wake source. Connectivity wake source.
PMGR_WAKE_SOURCE_BLE	Bluetooth LE wake source.

Applications can set or clear wake source using `RM_PMGR_W_set_wake_source()` and `RM_PMGR_W_clr_wake_source()`. Corresponding AT command is `AT+PMGRWAKESRC`.

To configure pin and port configuration for `PMGR_WAKE_SOURCE_GPIO` and `PMGR_WAKE_SOURCE_ADC`, Applications can set or clear using `R_BSP_WakeupSourcePinSet` and `R_BSP()_WakeupSourcePinUnSet()`. Corresponding AT command is `AT+SETCONFIG`. To get the port details use `AT+GETCONFIG`, see [Ref. 3](#)

NOTE
set/clear wake source API in RA6W1/2 is available, but it only modifies wake_source bitmap. The side effect or expected operational behavior by setting/clearing the wake_source is not defined in RA6W1/2. The actual wake_source configuration should be done with each module's API independently. For example, use <code>R_BSP_WakeupSourcePinSet</code> to enable GPIO wake-up.

7.5 Notifier Register

The PMGR provides an interface for applications to register notifier callback functions using the `RM_PMGR_W_notifier_register()` API. This allows applications to execute specific actions when transitioning to Low-power mode. Applications can define both the callback function and priority ensuring execution in a predefined order. The PMGR invokes these registered callbacks based on their assigned priority during the low-power transition.

Within the callback function, applications can perform tasks such as logging with delays or updating specific fields as needed.

By default, the maximum number of registered callbacks is defined by `MAX_NOTIFIER_ARRAY` (5), limiting the number of applications that can register for PMGR notifications. This value can be adjusted in the FSP PMGR properties to accommodate additional application requirements.

The PMGR notifier order can be configured as shown in [Table 4](#)

Table 4. Notifier priority order

Notifier priority order	Description
PMGR_W_NOTIFIER_ORDER_SYS_LOW	Reserved for system low order.
PMGR_W_NOTIFIER_ORDER_CUSTOMISED_LOW	Reserved for customized application.
PMGR_W_NOTIFIER_ORDER_SYS_HIGH	Reserved for system high order.
PMGR_W_NOTIFIER_ORDER_HIGHEST	First executed.

NOTE
The notifier callback function is restricted to only adding debug logs or updating application fields. It cannot be used to prevent the system from entering Sleep mode.

7.6 User Data Area in Retention Memory

The PMGR provides a maximum of 10096 bytes of the user data area in RTM to store user application data. User data in RAM which is not stored in the RTM should not be retained during DPM LPM because all other areas of RAM are powered off during Sleep mode 3 of DPM LPM.

The application can use `RM_PMGR_W_user_rtm_pool_alloc()`, `RM_PMGR_W_user_rtm_free()`, and `RM_PMGR_W_user_rtm_get()` to allocate, free, and access user data from RTM, respectively. See APIs in `fsp_user_manual_v0.8.0` for more information.

NOTE
The RA6W1 has 64 kB of RTM memory, but it cannot be split into smaller parts. Because of this, the whole 64 kB remains

NOTE

powered ON in DPM LPM mode, even if only part of it is needed.

7.7 DPM Port Filtering

Port filtering allows the device to selectively wake up from DPM LPM by responding only to specific TCP/UDP port numbers or IP multicast addresses. This helps achieve low power consumption by preventing unnecessary wake-ups caused by unregistered network traffic.

The APIs listed in [Table 5](#) enable filtering for a designated TCP/UDP port number or IP multicast address, ensuring that only relevant packets trigger a wake-up event while the device remains in Low-power mode.

Table 5. Port filtering APIs

Port filtering API	Description
RM_WIFI_dpm_tcp_port_filter_set	Set TCP port number for DPM wake-up.
RM_WIFI_dpm_tcp_port_delete	Delete TCP port number.
RM_WIFI_dpm_udp_port_filter_set	Set UDP port number for DPM wake-up.
RM_WIFI_dpm_udp_port_filter_delete	Delete UDP port Port filtering allows the device to selectively wake up from DPM LPM by responding only to specific TCP/UDP port numbers or IP multicast addresses. This helps achieve low power consumption by preventing unnecessary wake-ups caused by unregistered network traffic.
RM_WIFI_dpm_ptim_mc_filter_set	Set IP multicast address to allow receiving packet in DPM sleep.
RM_WIFI_dpm_ptim_mcv6_filter_set	Set IPv6 multicast address to allow receiving packet in DPM sleep.

When waking up from LPM, the application restarts. It must call RM_PMGR_W_dpm_rcv_ready_set() to ensure that only the DPM service sends packets to the upper layer.

7.8 LPM Examples

7.8.1 Sleep Mode 2 Configuration

7.8.1.1 Using API

[Figure 10](#) shows the Sleep mode 2 configuration process using PMGR APIs. After rebooting, the application initializes the PMGR module using RM_PMGR_W_Open(), which adds a sleep constraint for RAM. To allow Sleep mode 2, this constraint is removed using RM_PMGR_W_remove_sleep_constraint (PMGR_CONSTRAINT_POWER_RAM). The RM_PMGR_W_notifier_register() API, though optional, can be used to register a callback function for notification purposes before entering Sleep mode 2. The application then calls RM_PMGR_W_force () with a specified sleep duration (t_time) to transition into Sleep mode 2. Here the time should be provided in milliseconds. After the RTOS wakes up, the system restarts, and the application resets, requiring re-registration with the PMGR.

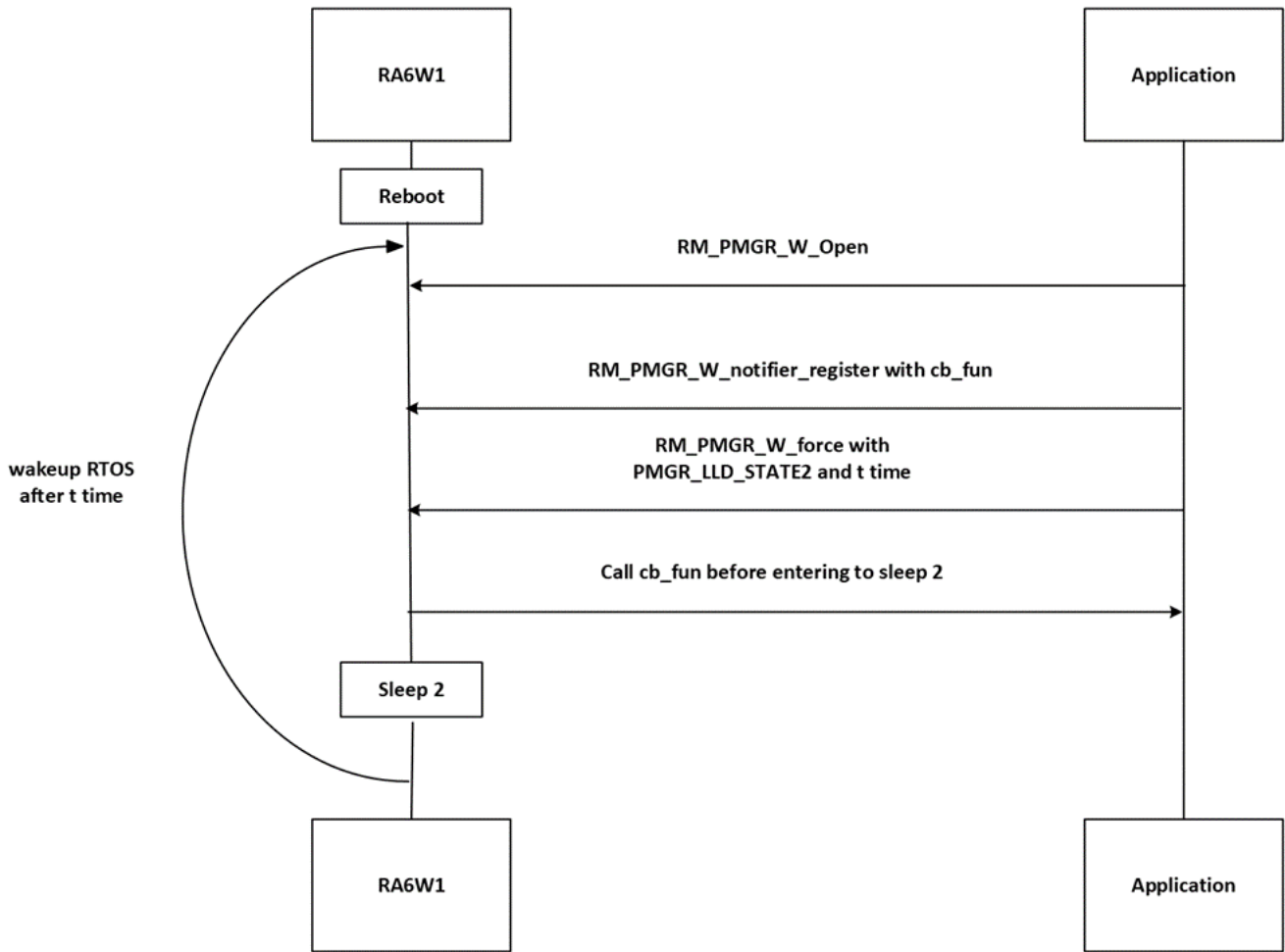

Figure 10. Sleep mode 2 configuration using API

7.8.1.2 Using AT Command

Figure 11 shows the Sleep mode 2 configuration using AT commands. After rebooting, the system initializes and sends the response +INIT:DONE,0. The MCU then issues AT+PMGRMCUWUDONE to notify that the wake-up process is complete. Next, the AT+PMGRCONSTRAINT=1,1 command is sent to remove the RAM power constraint. Finally, AT+PMGRFORCE=2,10000 is used to force the device into Sleep mode 2 for 10 s. Time to be provided is in milliseconds. When the sleep duration expires, the system wakes up, and the process restarts.

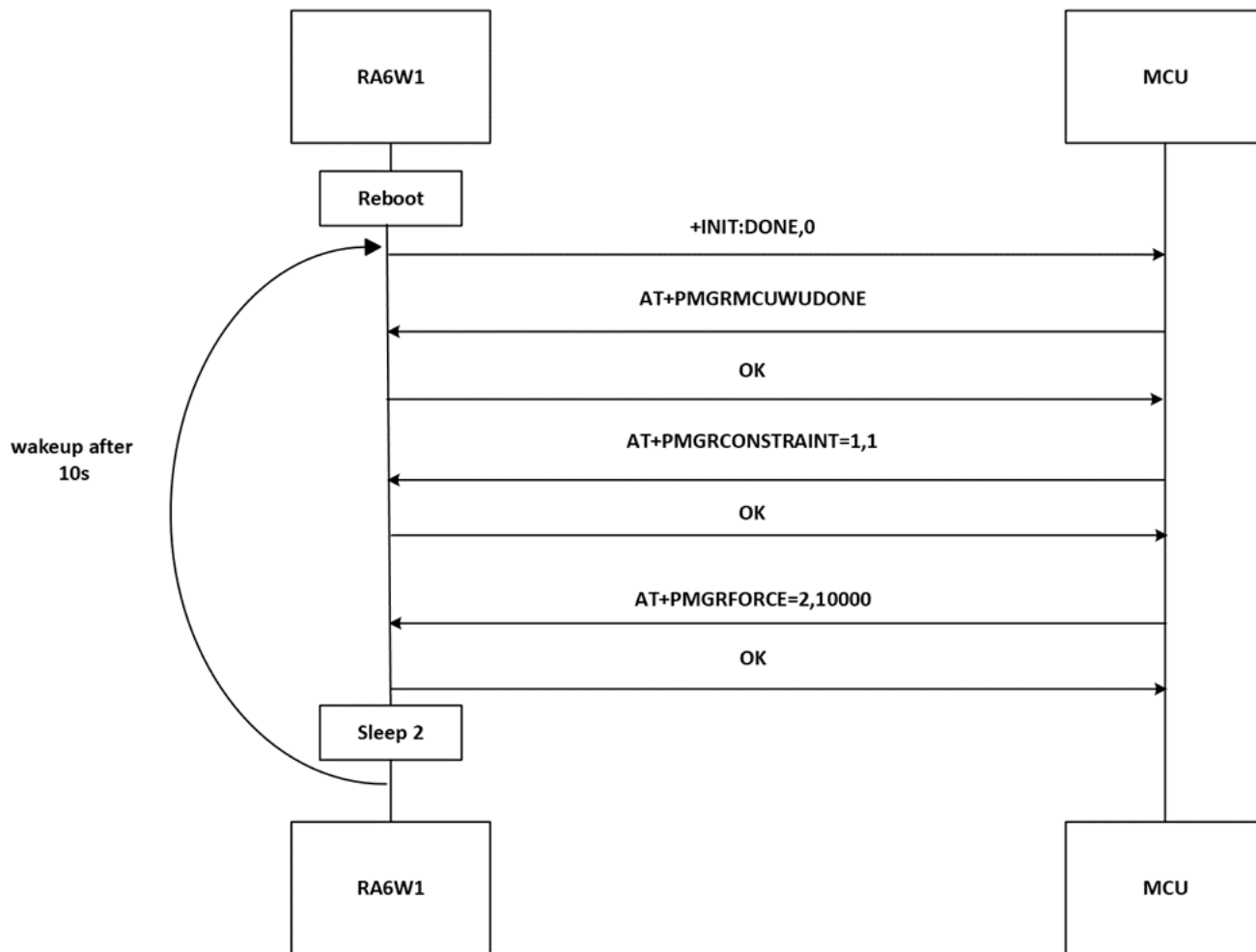

Figure 11. Sleep mode 2 configuration using AT command

7.8.2 Sleep Mode 3 Configuration

7.8.2.1 Using API

Figure 12 shows the Sleep mode 3 configuration using PMGR APIs. After rebooting, the application initializes the PMGR module with `RM_PMGR_W_Open()`. To retain necessary power during Sleep mode 3, `RM_PMGR_W_add_sleep_constraint(PMGR_CONSTRAINT_POWER_RETENTION)` is applied, while `RM_PMGR_W_remove_sleep_constraint(PMGR_CONSTRAINT_POWER_RAM)` removes RAM power constraints to allow Sleep mode 3 entry. Optionally, the application can register a callback function using `RM_PMGR_W_notifier_register()` for notification before entering sleep. The device then transitions into Sleep 3 mode using `RM_PMGR_W_force(PMGR_LLD_STATE3, t_time)`, with the callback function executed beforehand. After the sleep duration expires, the RTOS wakes up, and the system restarts, requiring reinitialization of PMGR settings.

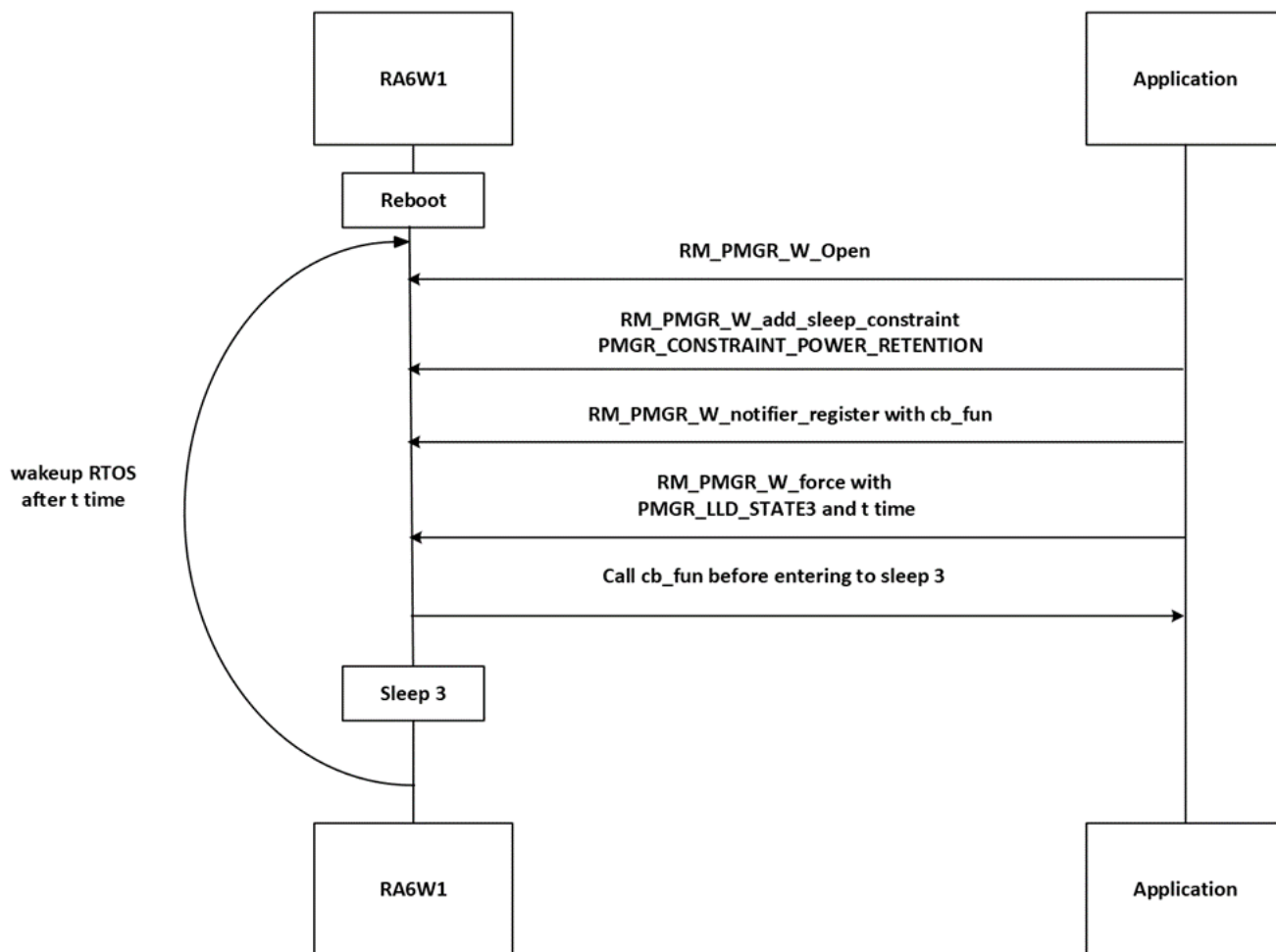

Figure 12. Sleep mode 3 configuration using API

7.8.2.2 Using AT Command

Figure 13 shows the Sleep mode 3 configuration using AT commands. After rebooting, the system sends the response +INIT:DONE,0 to indicate initialization completion. The MCU then issues AT+PMGRMCUWUDONE to notify that the wake-up process is complete, receiving an OK response. Next, AT+PMGRCONSTRAINT=1,1 is sent to remove the RAM power constraint, allowing entry into Sleep mode 3. The command AT+PMGRFORCE=3,10 forces the device into Sleep mode 3 for 10 s, confirmed with an OK response.

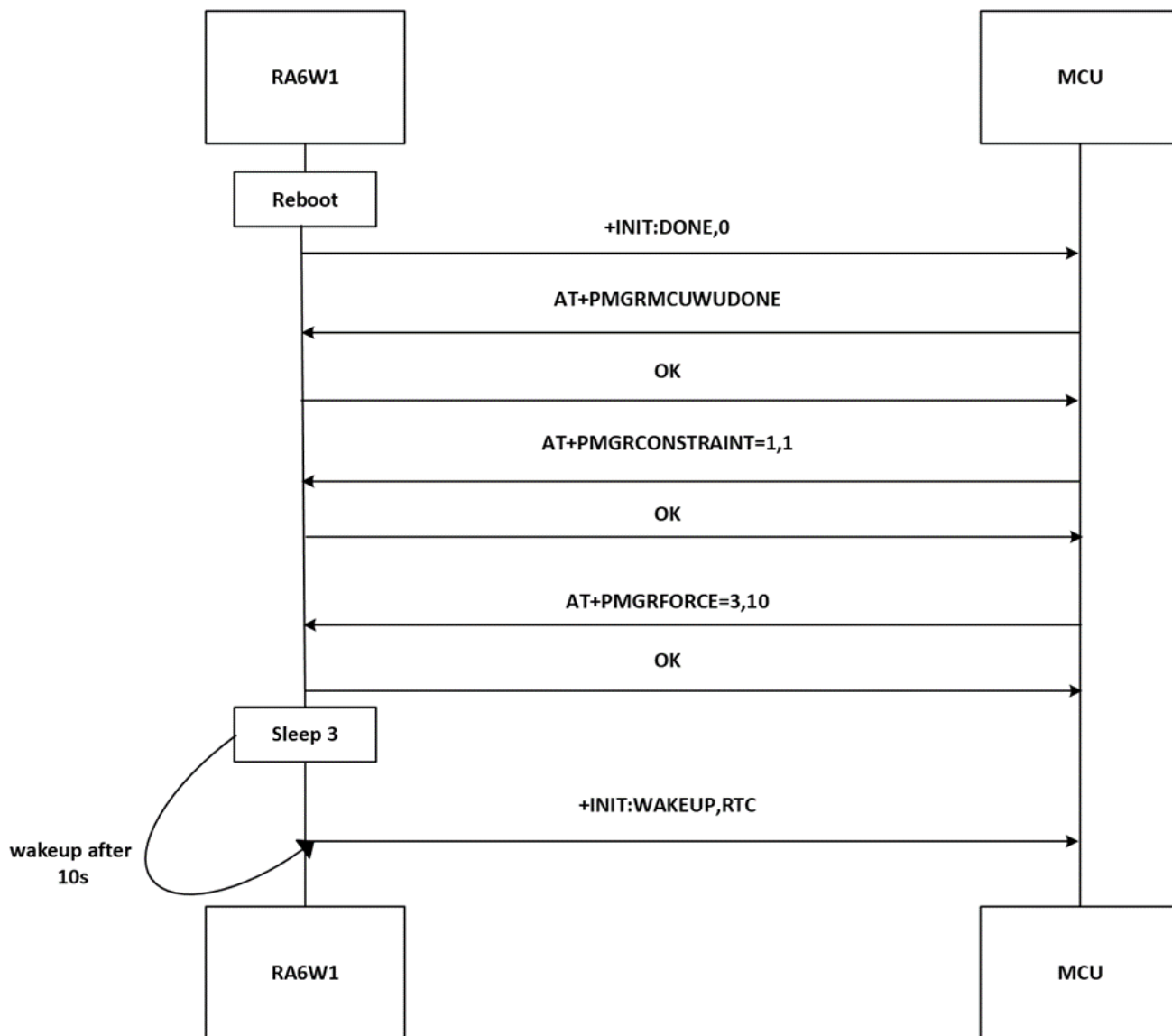

Figure 13. Sleep mode 3 configuration using AT command

7.8.3 Sleep 3 + DPM LPM Mode Configuration

7.8.3.1 Using API

The Sleep 3 DPM LPM mode is configurable only when an AP connection is available. After reboot, the system initializes by calling `RM_PMGR_W_Open` and sets the wake-up source using `RM_PMGR_W_set_wake_source` with `PMGR_WAKE_SOURCE_WIFI`. The retention constraint (`PMGR_CONSTRAINT_POWER_RETENTION`) is applied to ensure that the Wi-Fi connection and configuration are retained during sleep. When the AP connection is established and DHCP resolution is complete, an optional notifier is registered using `RM_PMGR_W_notifier_register`. Before entering Sleep 3 DPM LPM mode, the system either forces sleep using `RM_PMGR_W_force` with `PMGR_LLD_DPM` and a specified duration or removes the RAM power constraint using `RM_PMGR_W_remove_sleep_constraint`. A callback function (`cb_fun`) is executed before entering sleep. The system remains in Low-power mode while maintaining the Wi-Fi connection, allowing it to wake up as needed, see [Figure 14](#).

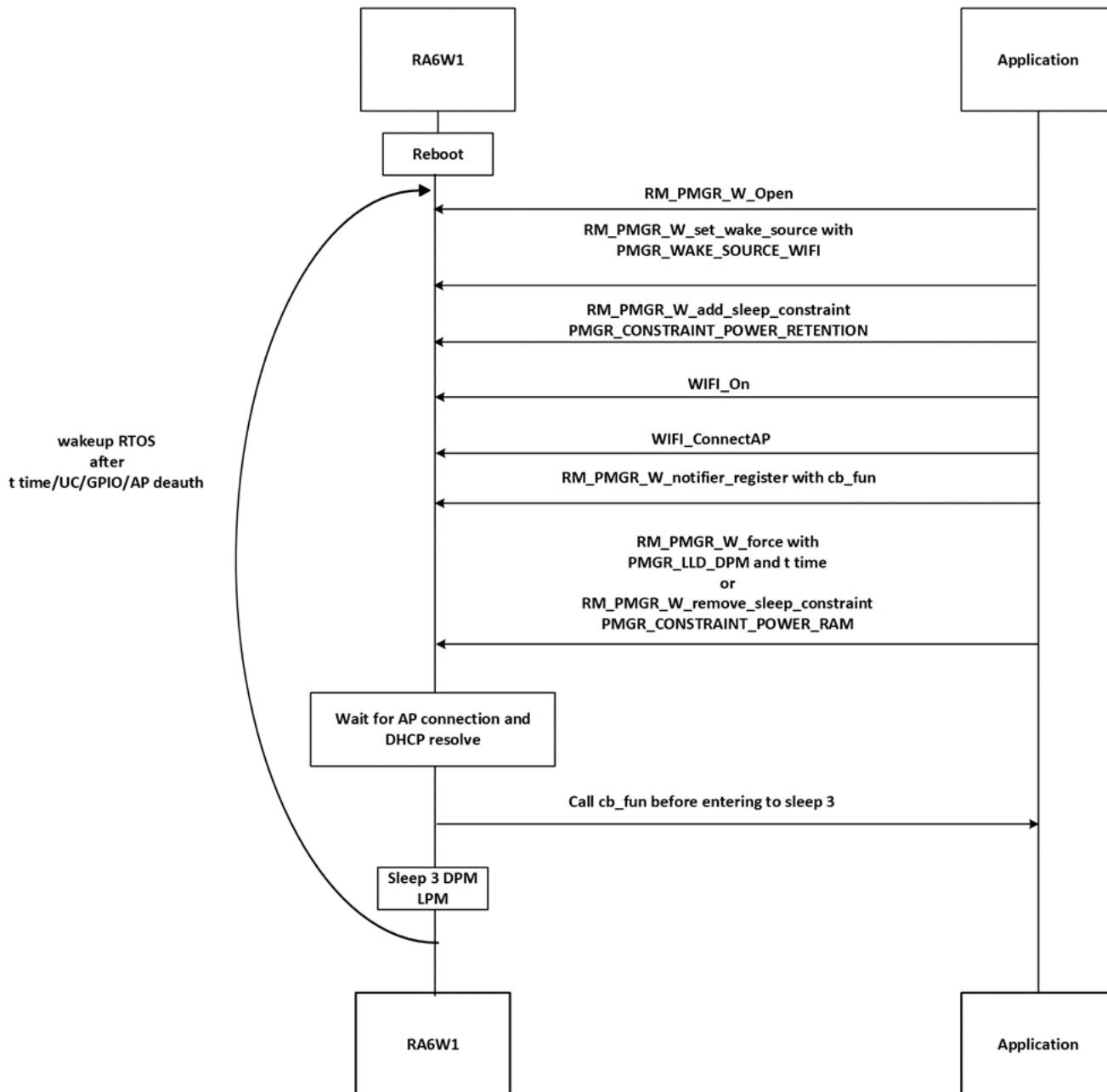

Figure 14. Sleep 3 DPM LPM mode configuration using API

7.8.3.2 Using AT Command

The Sleep 3 DPM LPM mode using AT commands is configurable only when an AP connection is available, ensuring that the Wi-Fi module maintains its connection while in low power mode. Upon reboot, the RA6W1 module initializes and sends a +INIT:DONE,0 message to the MCU. The MCU then issues AT+PMGRMCUWUDONE to notify that the wake-up process is completed, receiving an OK response.

Following this, the MCU configures the module for AP provisioning using the necessary AT commands. After provisioning, the module autonomously attempts to connect to the AP and establish a connection. When DHCP is resolved, it notifies the MCU with the assigned SSID and IP address.

At this point, the device transitions into Sleep 3 DPM LPM mode, since DPM is enabled by default in the Wi-Fi module. While in LPM, the module maintains AP snoozing functionality. If a unicast (UC) packet is received, the device triggers an RTOS wake-up and notify the MCU of the wake-up reason using the +INIT:WAKEUP,UC message, see [Figure 15](#).

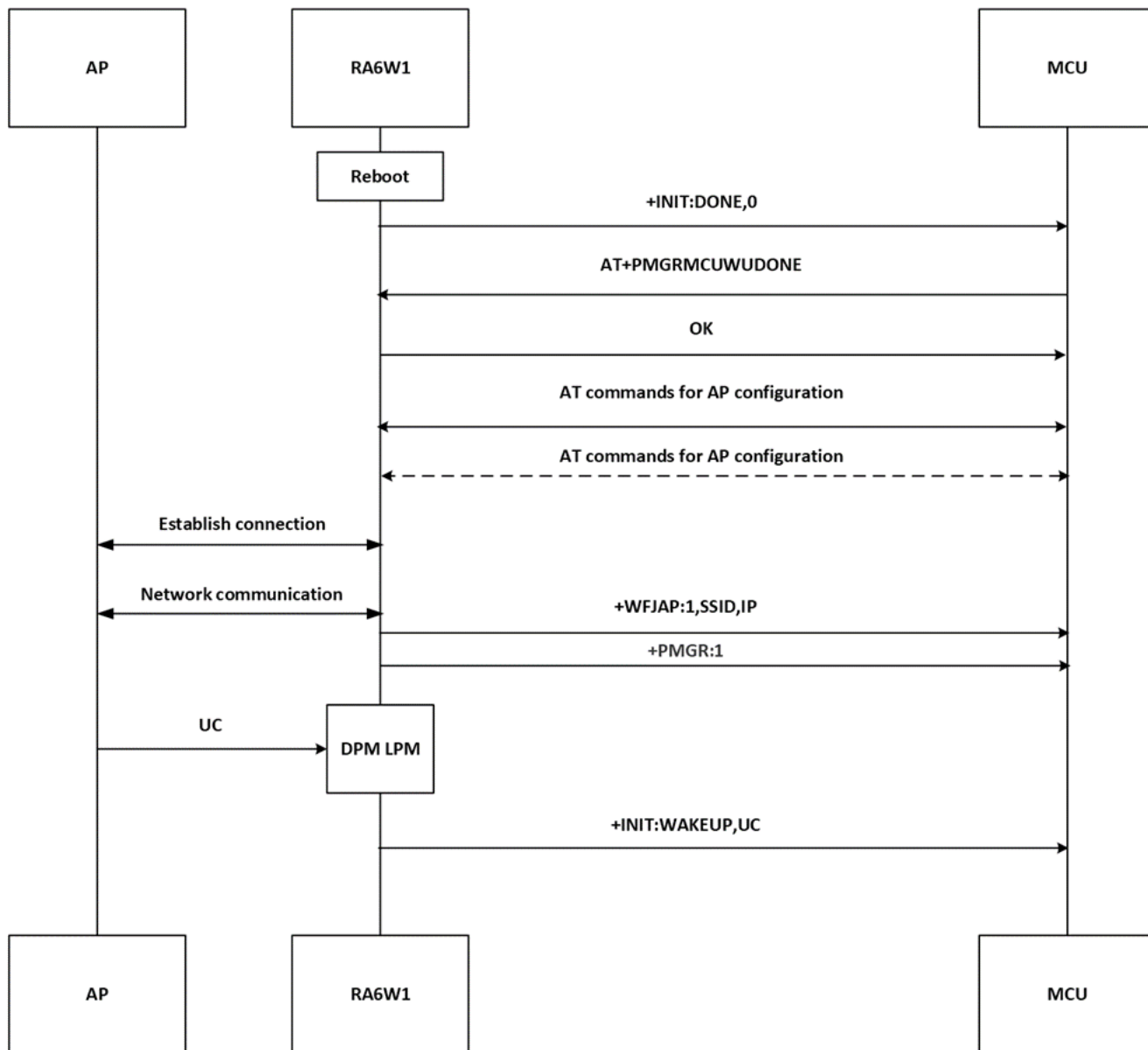

Figure 15. Sleep 3 DPM LPM default configuration using AT command

Apart from the default transition to Sleep 3 DPM LPM mode, the MCU can explicitly force the Wi-Fi module into this sleep mode using the AT+PMGRFORCE command. After rebooting, the Wi-Fi module initializes and sends +INIT:DONE,0. The MCU acknowledges wake-up by sending AT+PMGRMCUWUDONE. To prevent the module from entering sleep prematurely, the MCU applies a sleep constraint using AT+PMGRCONSTRAINT=1,1. This ensures that the module remains active until all required configurations are complete. The MCU provisions the device with an AP configuration, and the module connects to the AP. When DHCP is resolved, the module notifies the MCU with the SSID and assigned IP. The module sends +PMGR:1 indicating that it has entered DPM LPM mode, see [Figure 16](#).

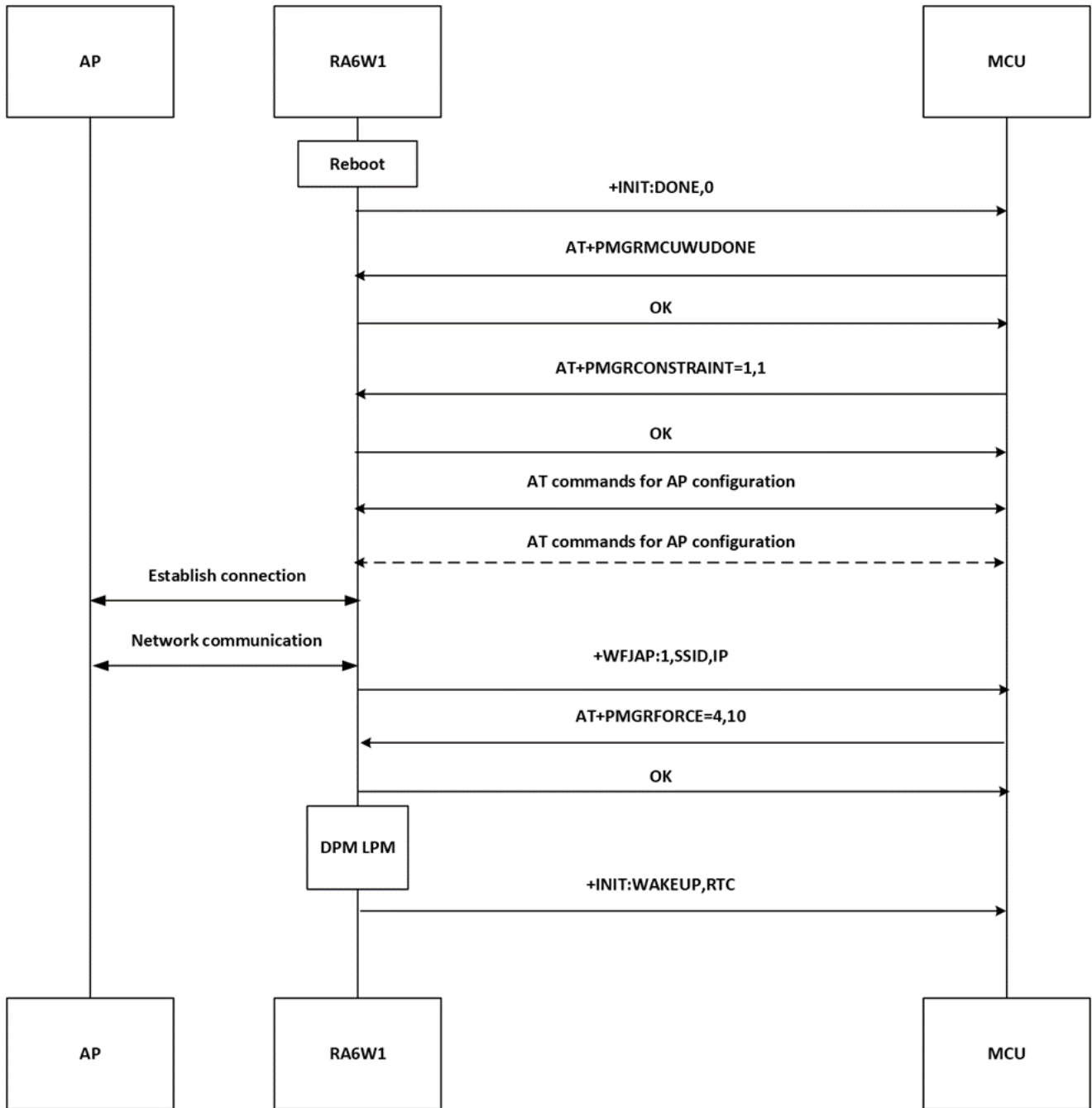

Figure 16. Sleep 3 DPM LPM mode configuration using Force AT command

7.8.4 Sleep Mode 4 Configuration

To configure Sleep mode 4:

1. Configure STA TIN with disabled DPM.
2. After connection use the following commands from UART terminal:
 - `wifi listen_interval 10 // this is equivalent to DTIM 10 in DPM`
 - `wifi ps_mode_set 1 // Enable/Disable Power-save mode.`

NOTE

After the reboot you need to use the commands again (they are not stored in nvram).

7.9 Wake-up Reason from DPM LPM

Wake-up Reasons are defined by two parameters `bsp_wakeup_source` and `dpm_wakeup_type`. `RM_PMGR_W_dpm_wakeup_src_get()` used to get `bsp_wakeup_source`, which is the wake-up reason. `RM_PMGR_W_dpm_wakeup_type_get()` used to get `dpm_wakeup_type`, which is the wake-up type.

Table 6. BSP wake-up sources

BSP wake-up source	Values	Description
BSP_WAKEUP_RESET	0x00	Internal reset
BSP_WAKEUP_SOURCE_GPIO	0x01	Boot from GPIO wake-up signal
BSP_WAKEUP_SOURCE_WAKEUP_COUNTER	0x02	Boot from wake-up counter
BSP_WAKEUP_SOURCE_POR	0x04	Boot from power on reset
BSP_WAKEUP_SOURCE_WATCHDOG	0x08	Boot from RTC_watchdog (not cpu watchdog)
BSP_WAKEUP_SOURCE_SENSOR	0x10	Boot from sensor (ADC)
BSP_WAKEUP_SOURCE_PULSE	0x20	Boot from pulse sensor
BSP_WAKEUP_RESET_WITH_RETENTION	0x80	Boot from retention
BSP_WAKEUP_SOURCE_UNKNOWN	0xff	Boot from unknown reason

Table 7. DPM wake-up types

DPM wake-up type	Values	Description
DPM_UNKNOWN_WAKEUP	0	Unknown wake-up
DPM_RTCTIME_WAKEUP	1	RTC time wake-up
DPM_PACKET_WAKEUP	2	UC/BC/MC
DPM_USER_WAKEUP	3	In case of DPM1_USER_0 , DPM_USER_1 wake-up
DPM_NOACK_WAKEUP	4	In case of No ACK, No BCN
DPM_DEAUTH_WAKEUP	5	TIM received the Deauth packet
DPM_TIM_ERR_WAKEUP	6	TIM has something wrong and fault
DPM_TCP_KA_TIMEOUT_WAKEUP	8	TCP Keep alive timeout wake-up

The device can be awake by following main events in DPM LPM.

- GPIO from MCU, see [Figure 17](#)
- UC from AP, see [Figure 18](#)
- Disconnection from AP, see [Figure 19](#)

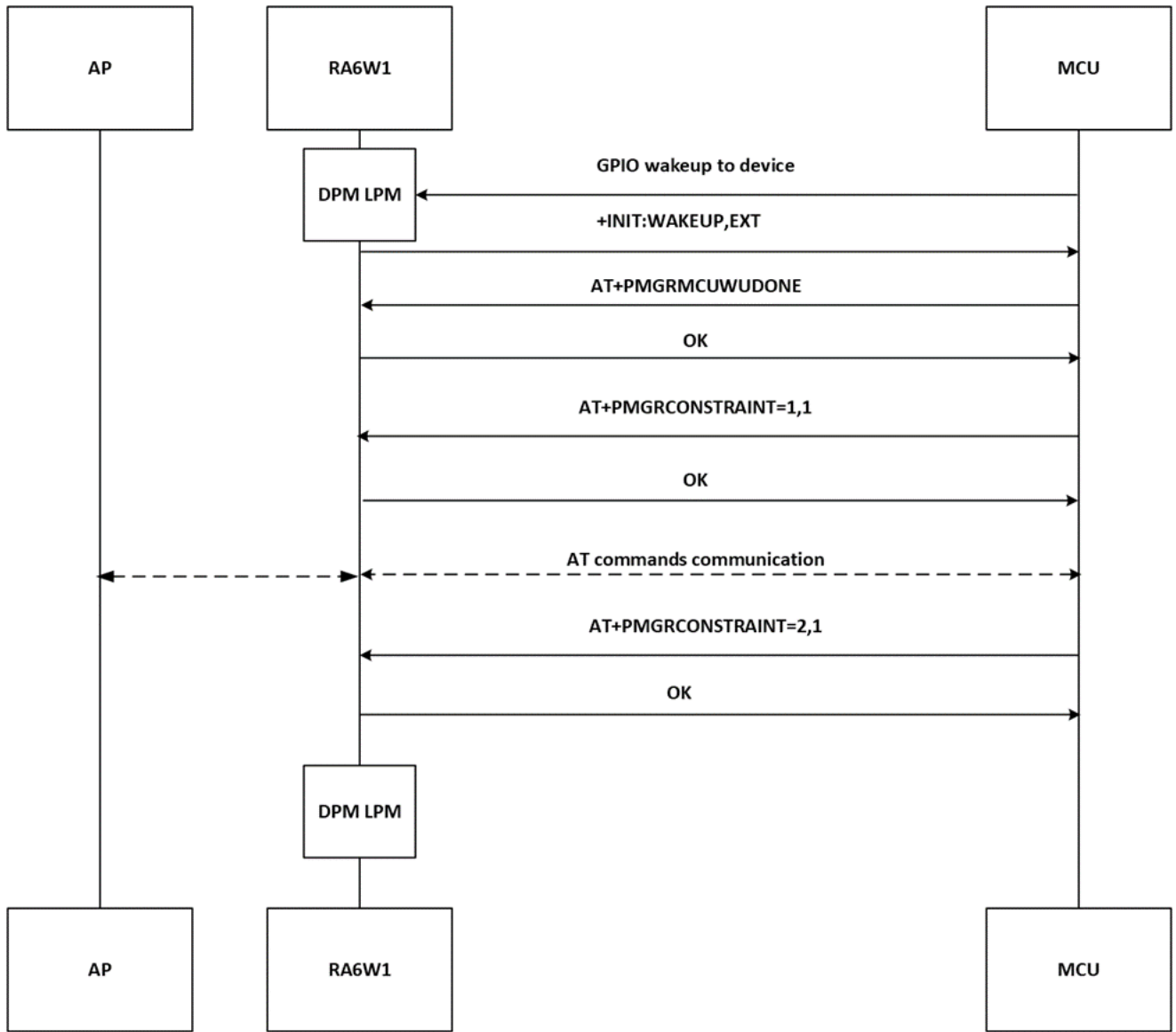

Figure 17. Flow of AT commands for waking up by GPIO of MCU

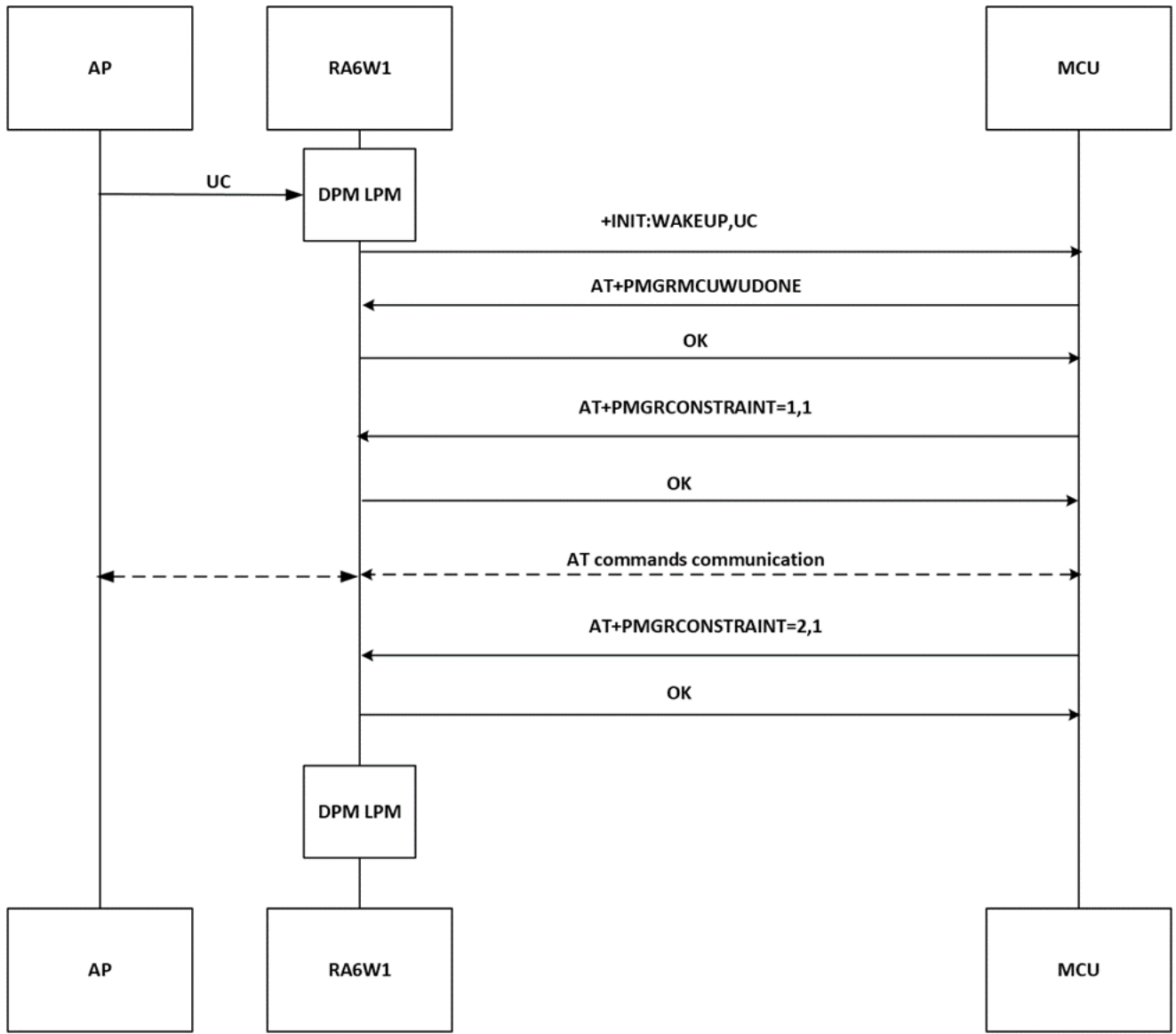

Figure 18. Flow of AT commands for waking up by UC from AP

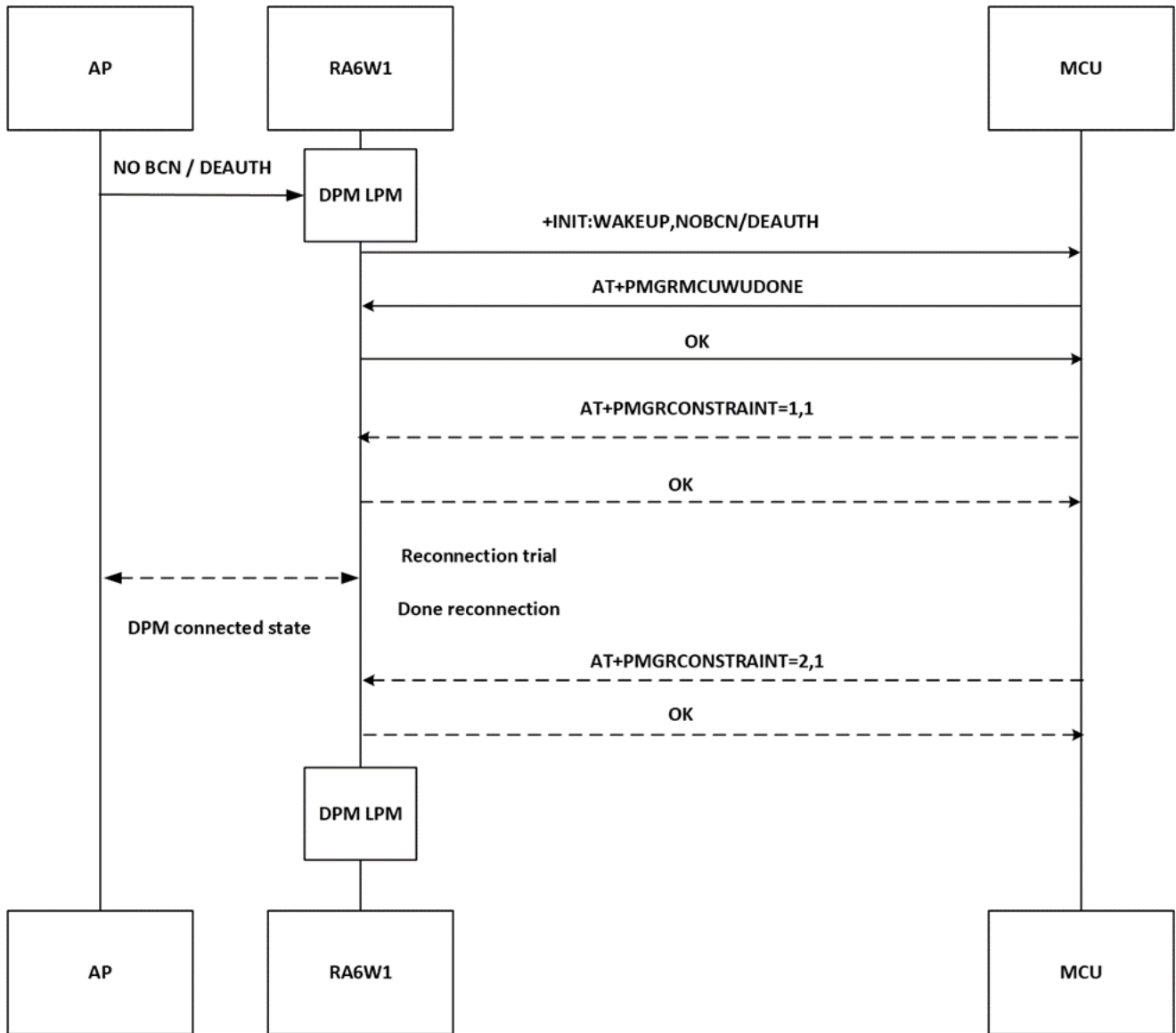

Figure 19. Flow of AT commands for waking up by disconnection from AP

7.10 DPM LPM Specific Configuration

- **DPM Keep Alive Time**
 To maintain AP connectivity in LPM mode, Keep Alive packets are sent periodically to the AP. By default, this interval is set to 30,000 ms. The command AT+PMGRDPMKA is available to configure this, with a valid range of 0 to 600,000 ms.
- **DTIM Count**
 This is the interval to check the AP's beacon. By default, this count is set to 10. The command AT+PMGRDPMTIMWU is available to configure this, with a valid range of 1 to 6000.
- **TWT Configuration**
 TWT configuration is managed through API functions such as WIFI_TwtSetup() for setting up TWT and WIFI_TwtTeardown() for disabling it. On the other hand, the RA6W1 provides an AT command-based approach, where TWT operations are controlled using AT+PMGRFORCE=5,<twt_action>, .

8. TCP Client Example with DPM

8.1 Using API

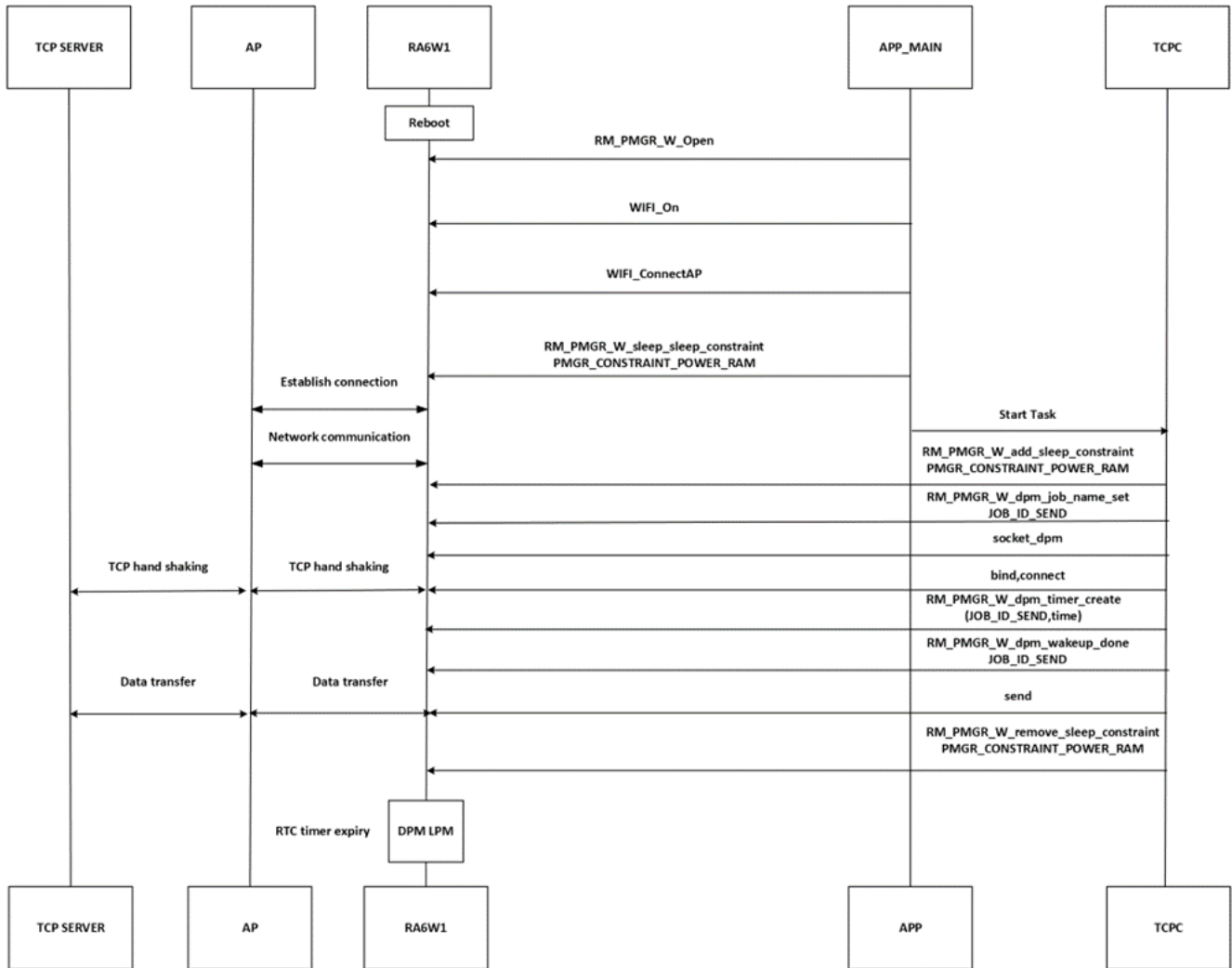

Figure 20. TCP client send function using API

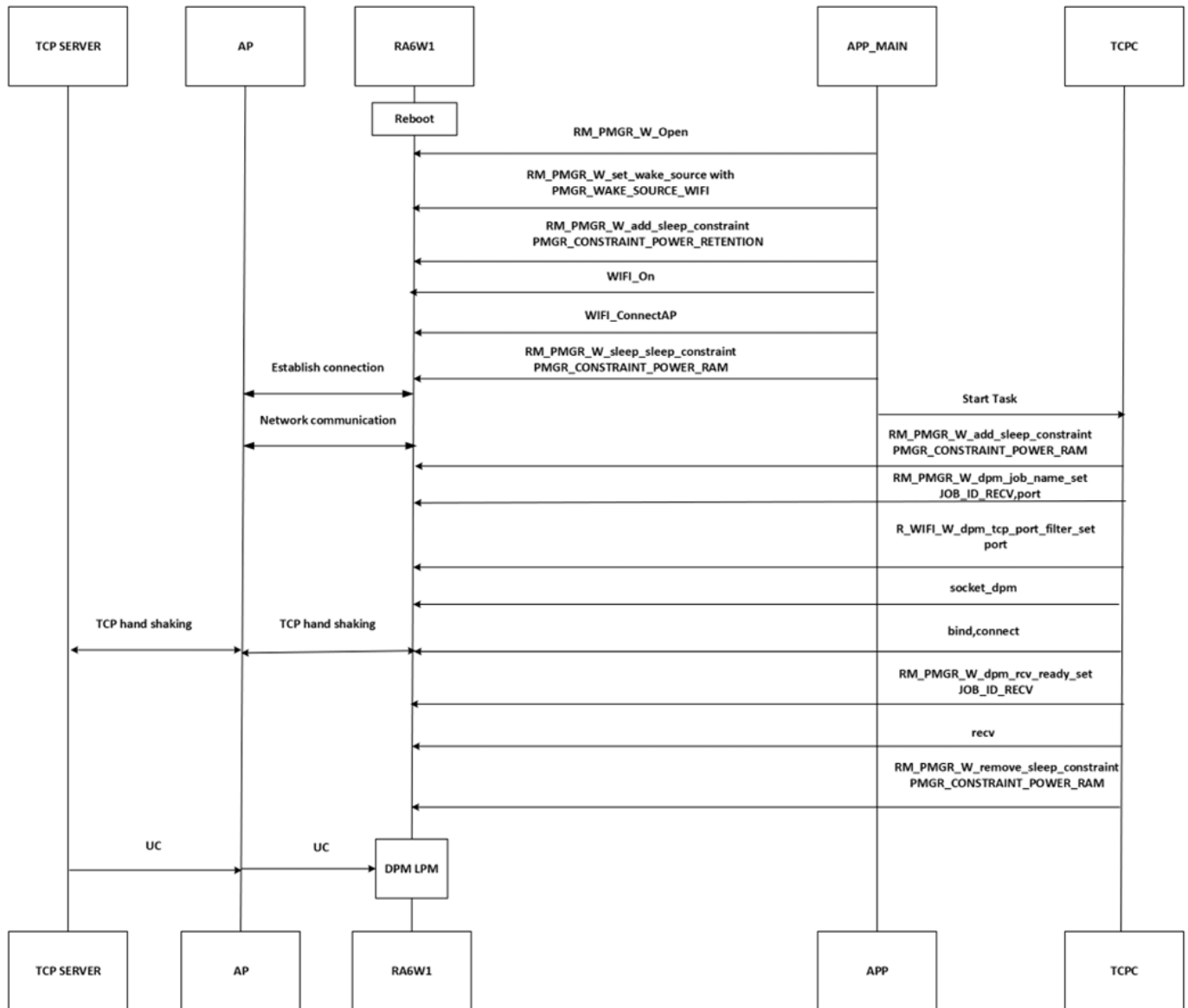

Figure 21. TCP client receive function using API

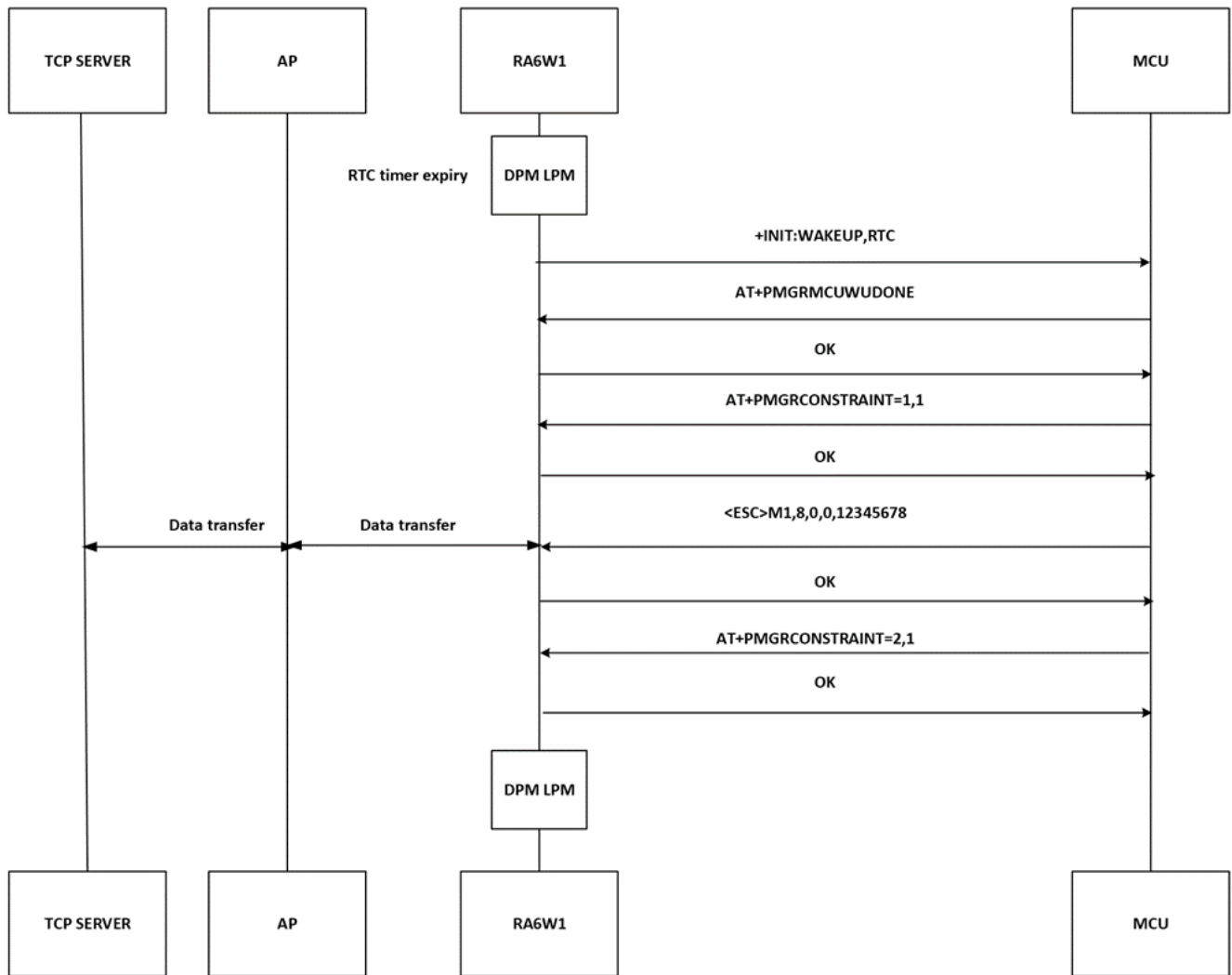

Figure 23. TCP client send flow using AT commands

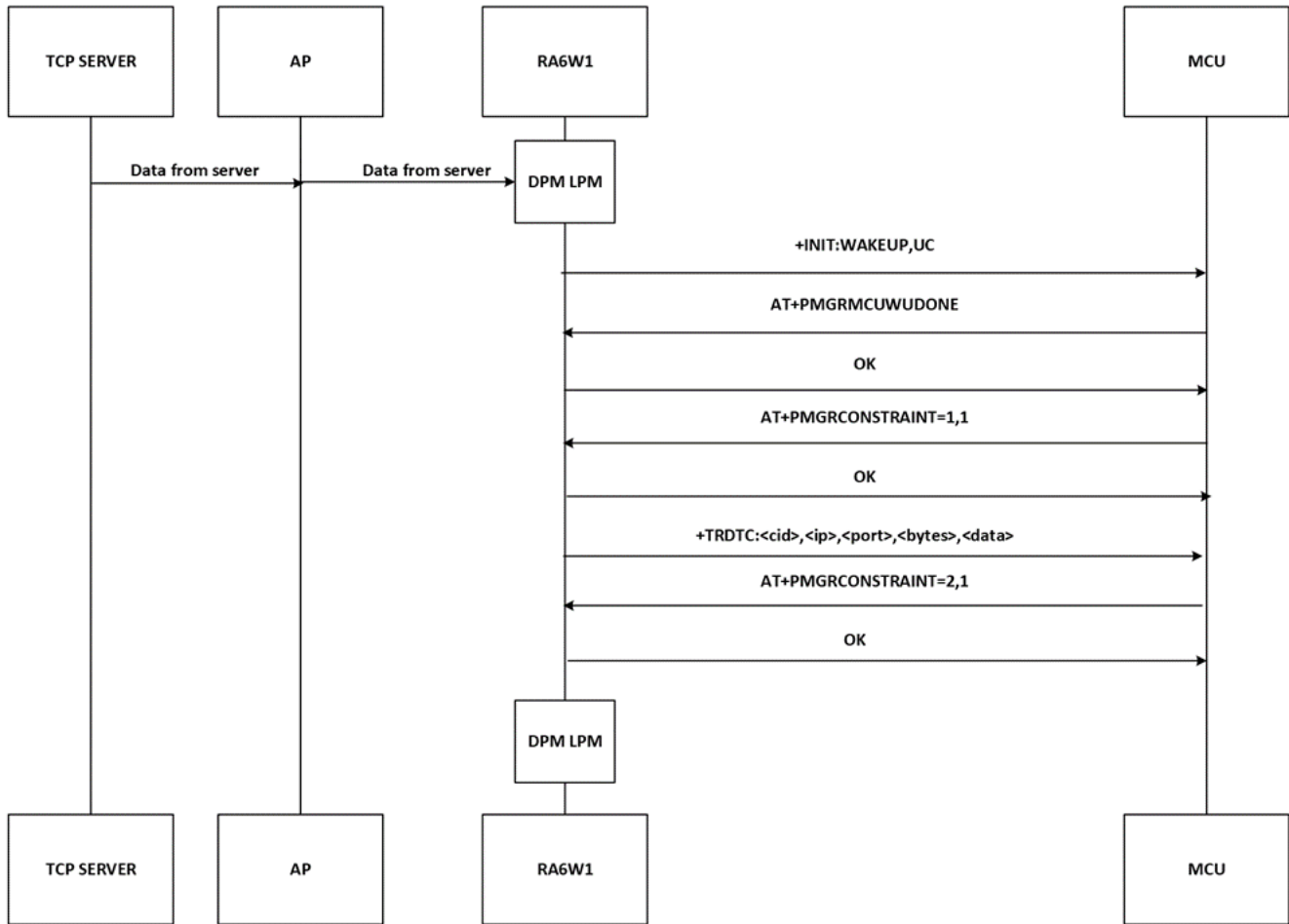

Figure 24. TCP client receive flow using AT commands

Effective power management is critical for optimizing the performance, efficiency, and longevity of IoT devices. The PMGR plays a central role in regulating power consumption, enabling low-power states, and ensuring seamless transitions between different operating modes. By leveraging intelligent power management techniques, developers can achieve significant energy savings without compromising device functionality.

This application note has provided an in-depth overview of PMGR’s capabilities, key features, and best practices for implementation. A well-designed power management strategy enhances battery life, reduces operational costs, and ensures reliable performance in diverse IoT applications. As IoT technology continues to evolve, advancements in power management solutions remain a cornerstone for achieving sustainable and efficient device operation.

Appendix A Comparison of AT Commands: DA16200 vs. RA6W1

The following comparison highlights the key differences and similarities between the AT command sets of DA16200 and RA6W1, helping developer's transition between the two modules efficiently.

Table 8. Comparison of AT Commands: DA16200 vs. RA6W1

Feature/Command	DA16200 behavior	RA6W1 behavior
DPM on/off	AT+DPM	Not supported. DPM enabled by default
DPM keep alive	AT+DPMKA	AT+PMGRDPMKA
Set DPM TIM wake-up count	AT+DPMTIMWU	AT+PMGRDPMTIMWU
Set DPM user wake-up time	AT+DPMUSERWU	AT+PMGRDPMUSERWU
Set the user application not to enter DPM sleep	AT+CLRDPM_SLP_EXT	AT+PMGRCONSTRAINT=1,1
Set the user application ready to enter DPM sleep	AT+SETDPM_SLP_EXT	AT+PMGRCONSTRAINT=2,1
Set Sleep mode 2	AT+SETSLEEP2EXT	AT+PMGRFORCE=2,<time>
Set Sleep mode 3	AT+SETSLEEP3EXT	AT+PMGRFORCE=3,<time>
ABNORMAL commands	Supported	Not supported
Wake source	Not supported	AT+PMGRWAKESRC
Constraints	Not supported	AT+PMGRCONSTRAINT
TWT	Not supported	AT+PMGRFORCE=5,<><>, ...

Appendix B PMGR CLI Commands

Figure 25 shows the available PMGR CLI commands.

```
[/RRQ61000/pmgr] # pmgr
[/RRQ61000/pmgr] # help
pmgr commands:
  status          : PMGR show status
  add_constraint  : PMGR add constraint [constraint]
  remove_constraint : PMGR remove constraint [constraint]
  set_wake_source : PMGR set wake source [wake_source]
  clear_wake_source : PMGR clear wake source [wake_source]
  force           : PMGR force [state] [sleep_time_sec] where [sleep_time_sec] is optional
  dpm_sleep       : timer [id] [msec], ...
  dpm_timer       : timer [id] [sec], ...
  dpm_all_timer   : alltimer, alloc all dpm timer
  dpm_timer_list  : timer_list, print out timer list
  dpm_kill_timer  : kill timer [id]
  pm_sleep        : timer [id] [second], ...
  ip_cond         : IPv4/6 condition check for entering PMGR_LLD_DPM

[/RRQ61000/pmgr] # █
```

Figure 25. PMGR CLI commands

Appendix C RTM CLI

Retention Memory information can be obtained using CLI `rtm_info, sw`, see [Figure 26](#).

```
RTM_ARP_BASE      : 0x[RR061000] # 28600960, size:0xf0
RTM_DNS_BASE      : 0x28600a50, size:0x98
RTM_RTC_TIMER_BASE : 0x28600ae8, size:0x230
RTM_DPM_MONITOR_BASE : 0x28600d18, size:0x7c
APP_ALLOC_SZ      : 0xa94

RTM_TCP_BASE      : 0x2860e400, size:0x660
  dpm_lwip_sock_names(0x2860e400, 640), dpm_tcp_sess_list(0x2860e680, 992:248*4)
  total_size: 1632(640+992)

RTM_USER_POOL_BASE : 0x2860ea60, size:0x40
RTM_USER_DATA_BASE : 0x2860eaa0, size:0x1560

<< DPM RTM MEM STATUS >>
mem: 0x2860eaa0 used:0 next:0x1558 prev:0x0 size:5456
Total mem : 5464
node cnt  : 1
error_cnt : 0
illegal cnt: 0
Used_mem  : 0
Free mem  : 5456

- Whole available to allocate ( No allocated ) ...
```

Figure 26. RTM information

9. Revision History

Revision	Date	Description
1.02	Dec 3, 2025	Added Sleep 4 and updated RTC Timer related changes.
1.01	Aug 31, 2025	Updated Section 7.4.
1.00	May 30, 2025	First release.

IMPORTANT NOTICE AND DISCLAIMER

RENESAS ELECTRONICS CORPORATION AND ITS SUBSIDIARIES (“RENESAS”) PROVIDES TECHNICAL SPECIFICATIONS AND RELIABILITY DATA (INCLUDING DATASHEETS), DESIGN RESOURCES (INCLUDING REFERENCE DESIGNS), APPLICATION OR OTHER DESIGN ADVICE, WEB TOOLS, SAFETY INFORMATION, AND OTHER RESOURCES “AS IS” AND WITH ALL FAULTS, AND DISCLAIMS ALL WARRANTIES, EXPRESS OR IMPLIED, INCLUDING, WITHOUT LIMITATION, ANY IMPLIED WARRANTIES OF MERCHANTABILITY, FITNESS FOR A PARTICULAR PURPOSE, OR NON-INFRINGEMENT OF THIRD-PARTY INTELLECTUAL PROPERTY RIGHTS.

These resources are intended for developers who are designing with Renesas products. You are solely responsible for (1) selecting the appropriate products for your application, (2) designing, validating, and testing your application, and (3) ensuring your application meets applicable standards, and any other safety, security, or other requirements. These resources are subject to change without notice. Renesas grants you permission to use these resources only to develop an application that uses Renesas products. Other reproduction or use of these resources is strictly prohibited. No license is granted to any other Renesas intellectual property or to any third-party intellectual property. Renesas disclaims responsibility for, and you will fully indemnify Renesas and its representatives against, any claims, damages, costs, losses, or liabilities arising from your use of these resources. Renesas' products are provided only subject to Renesas' Terms and Conditions of Sale or other applicable terms agreed to in writing. No use of any Renesas resources expands or otherwise alters any applicable warranties or warranty disclaimers for these products.

(Disclaimer Rev.1.1 Jan 2024)

Corporate Headquarters

TOYOSU FORESIA, 3-2-24 Toyosu
Koto-ku, Tokyo 135-0061, Japan

www.renesas.com

Trademarks

Renesas and the Renesas logo are trademarks of Renesas Electronics Corporation. All trademarks and registered trademarks are the property of their respective owners.

Contact Information

For further information on a product, technology, the most up-to-date version of a document, or your nearest sales office, please visit www.renesas.com/contact-us/

© 2025 Renesas Electronics Corporation. All rights reserved.