

## RA2E1 Group

### RA2E1 Sensor & Touchless key Demo Sample Software

---

#### Introduction

This application note explains demo software for RA2E1 Sensor & Touchless key demo.

#### Target Device

RA2E1 Group

#### Related Document

- (1) RA2E1 Group Sensor & Touchless key Demo Board (r12an0113ej0100-ra2e1)
- (2) HS300x Datasheet (<https://www.renesas.com/us/en/document/dst/hs300x-datasheet>)
- (3) ZMOD4410 Programming Manual (<https://www.renesas.com/us/en/document/mas/zmod4410-programming-manual-read-me?language=en>)

**Contents**

1. Outline.....	3
2. Confirmed Operation Environment.....	3
3. Software Functions.....	4
3.1 Contactless button (Touchless key) operation by capacitive touch sensor.....	4
3.1 Temperature / Relative humidity measurement by HS3001 .....	4
3.2 Indoor Air Quality (IAQ) measurement by ZMOD4410 .....	4
3.3 Temperature measurement by Thermopile sensor .....	4
4. Software functions .....	5
4.1 Software structure .....	5
4.2 File structure.....	8
4.3 Constants .....	10
4.4 Global Variables .....	12
4.5 Function Specifications .....	13
4.6 Overall processing Flow .....	14
4.7 UART command processing Flow.....	15
4.8 Touchless button operation processing flow .....	16
4.9 Sensor measurement processing flow .....	17
4.10 AUTO mode processing flow.....	18
4.11 Data flow.....	19
Revision History.....	21

### 1. Outline

This software performs LED, buzzer, and UART output (UART-USB conversion) according to the result of contactless button (touchless key) operation by the capacitive touch sensor and sensor control using I2C communication. More detail of this board, please refer RA2E1 Group Sensor & Touchless Key Demo Board (R12AN0113EJ0100).

Figure 1.1 shows system configuration.

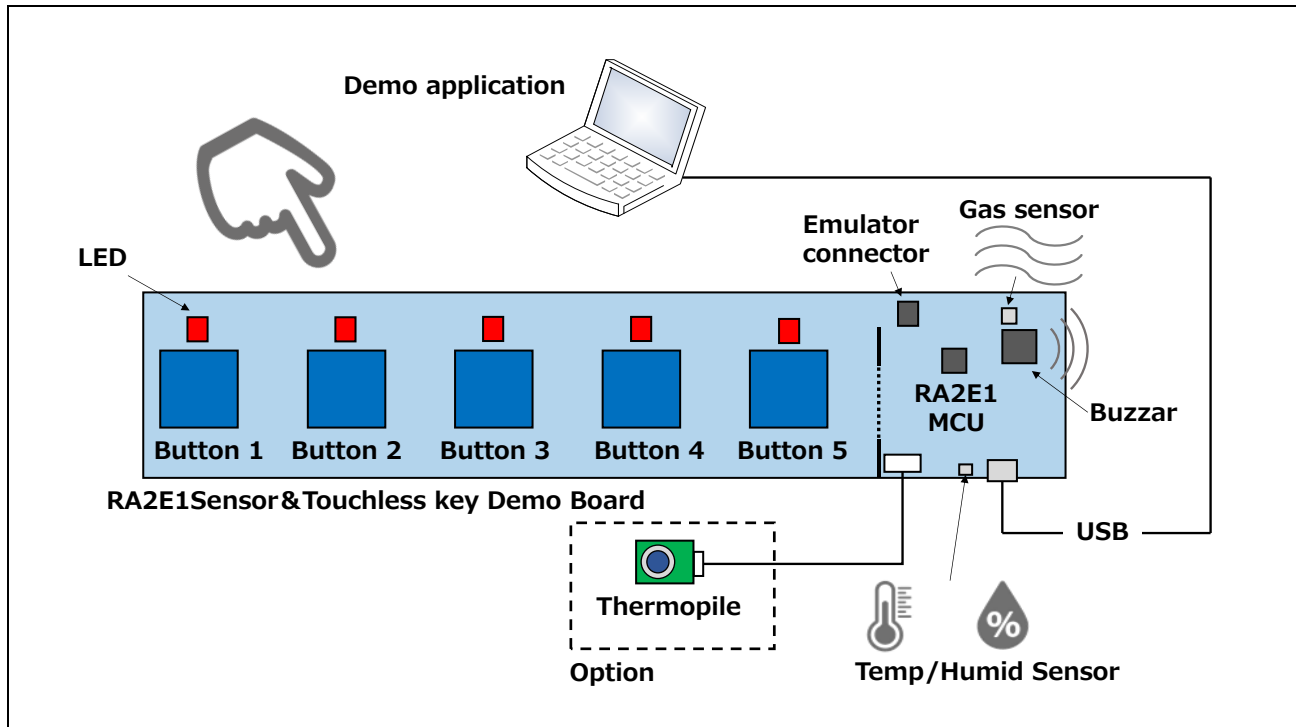

Figure 1.1 System configuration

### 2. Confirmed Operation Environment

Table 2.1 shows confirmed operation environment for this software.

Table 2.1 Confirmed operation environment

Item	Description
Demo board	RTK0EA0005D00001BJ
MCU	RA2E1
Operating Frequency	48MHz
Operating Voltage	5V
Integrated Development Environment	e <sup>2</sup> Studio 2021-01
C Compiler	GCC 9.2.1
FSP	2.3.0

### 3. Software Functions

Functions of this software are listed below.

- (1) Contactless button (touchless key) operation by the capacitive touch sensor
- (2) Temperature / Relative humidity measurement by HS3001
- (3) Indoor Air Quality (IAQ) measurement by ZMOD4410
- (4) Temperature measurement by Thermopile Sensor

#### 3.1 Contactless button (Touchless key) operation by capacitive touch sensor

By Capacitive Touch Sensing Unit (CTS2) in RA2E1 MCU.

Bring your finger about 15mm above the button and it will be judged ON and buzzer will be output.

LED turns on according to the mode.

#### 3.1 Temperature / Relative humidity measurement by HS3001

By build in I2C in MCU.

Measures temperature and humidity to first decimal place and sends it by UART.

#### 3.2 Indoor Air Quality (IAQ) measurement by ZMOD4410

By build in I2C in MCU.

Measures Indoor air quality (IAQ) to first decimal place and sends it by UART.

#### 3.3 Temperature measurement by Thermopile sensor

By build in I2C in MCU.

The surface temperature of the target object is measured to the first decimal place in measurement area of 16(4x4) elements and sends it by UART.

## 4. Software functions

### 4.1 Software structure

Figure 4.1 shows the software structure.

Use RA smart configurator to add following FSP modules and create an application.

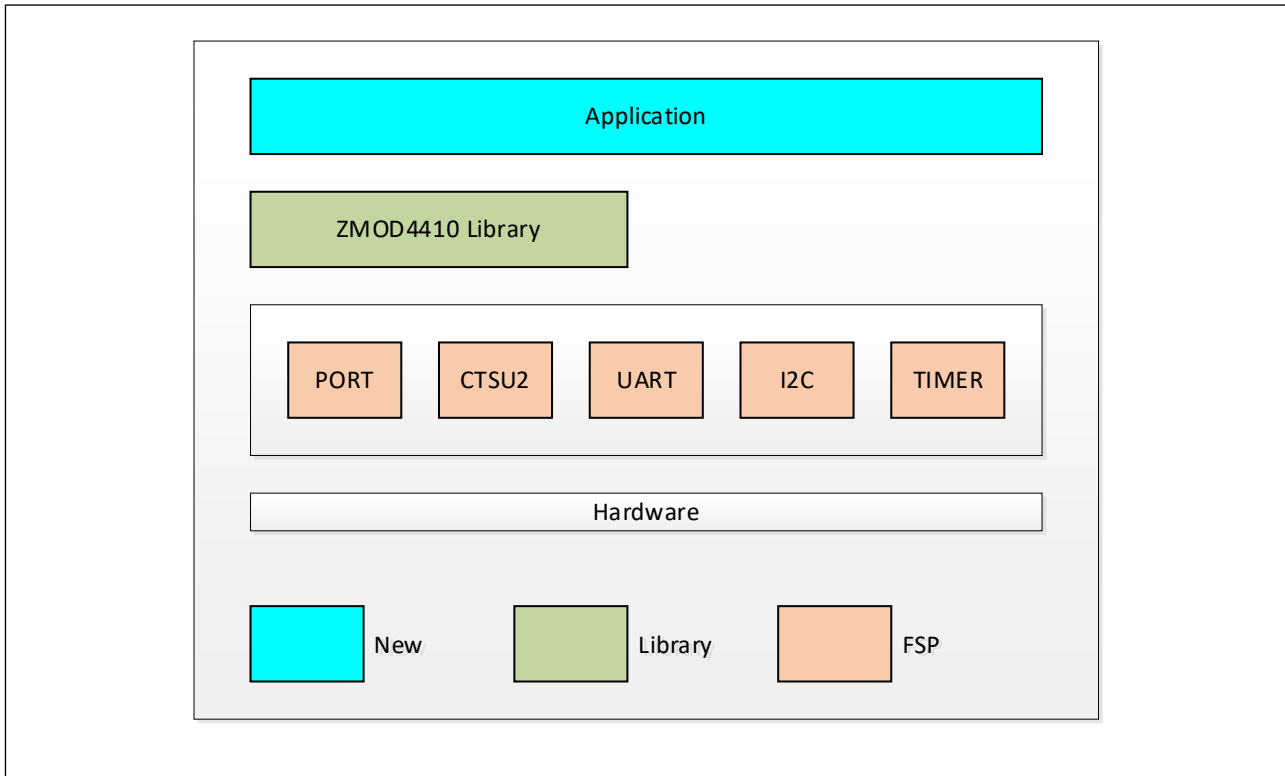
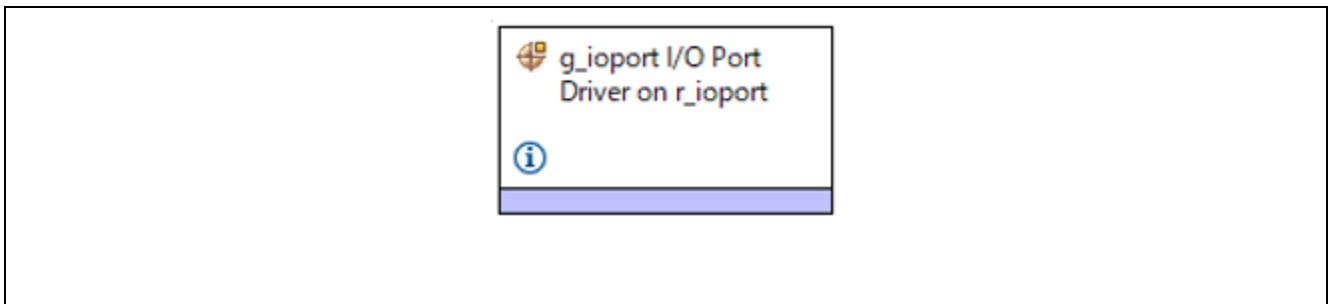
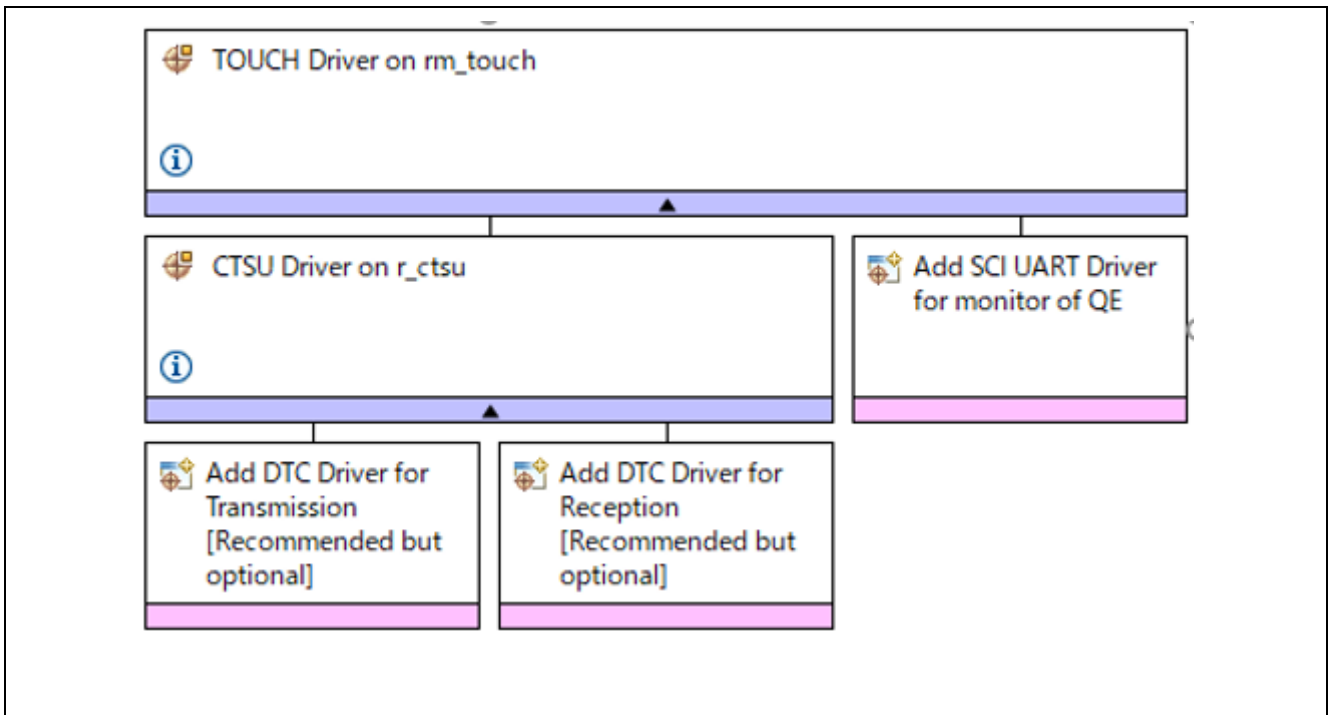

Figure 4.1 Software structure

PORT (r\_ioport)



CTSUS2 (rm\_touch)



UART (r\_sci\_uart)

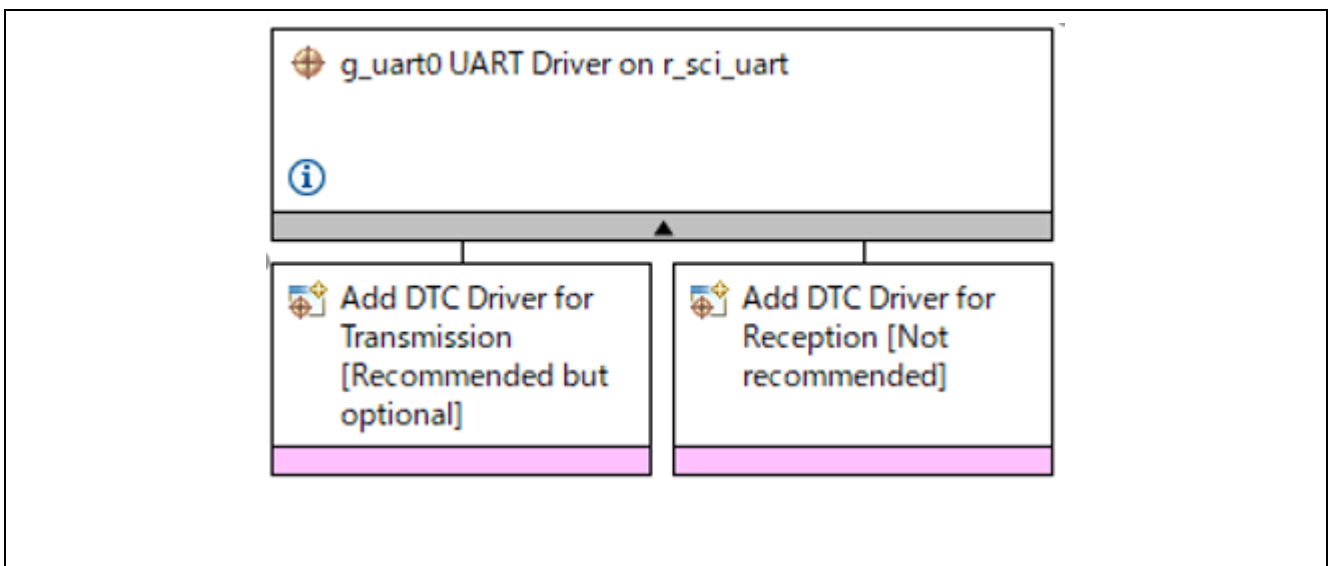

I2C (r\_sci\_i2c)

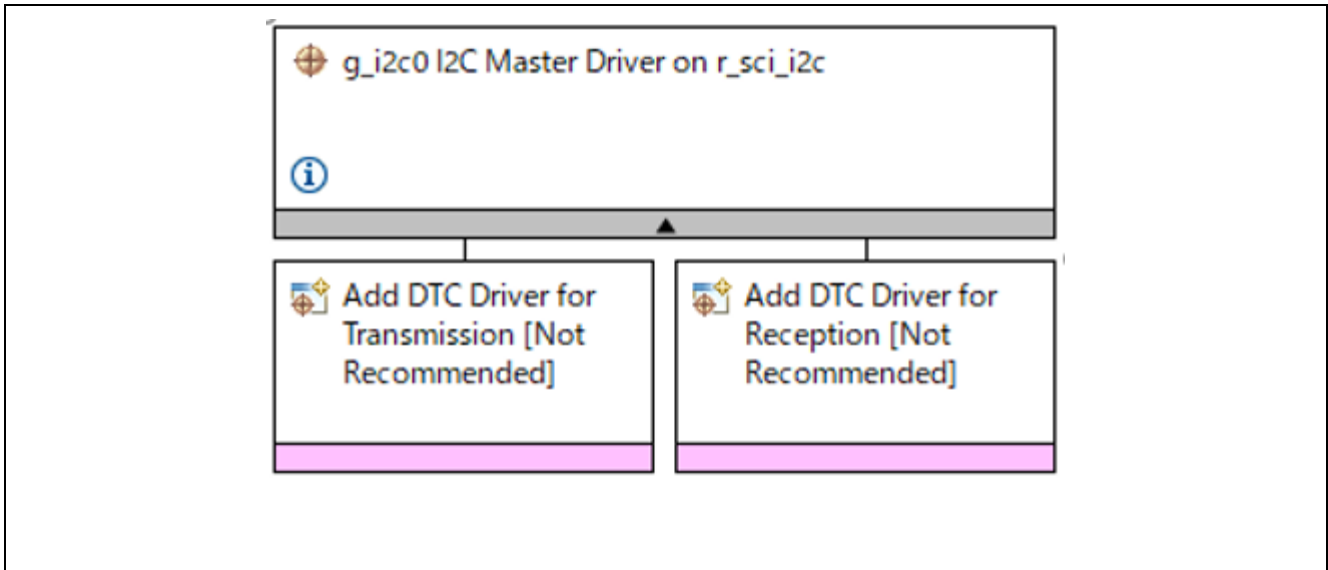

TIMER (r\_agt, r\_gpt)

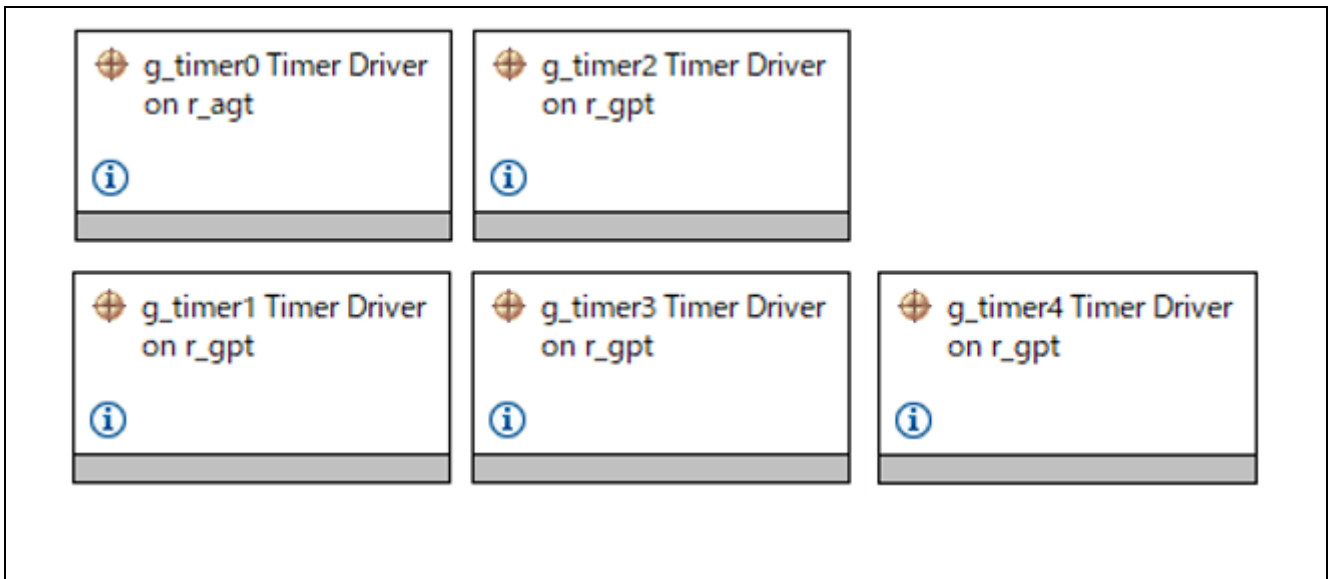

## 4.2 File structure

Figure 4.1 shows source file tree.

FSP files and libraries are omitted.

**Figure 4.1 Source file tree**

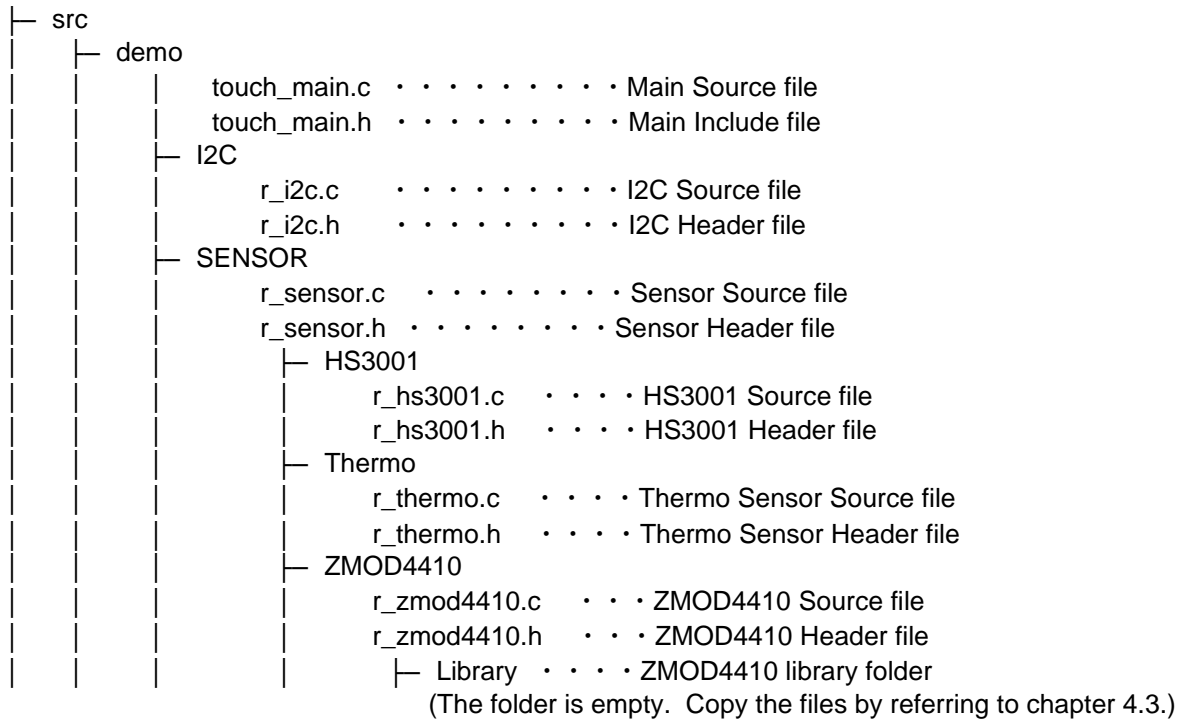

Table 4.1 shows source files.

**Table 4.1 Source Files**

File name	Description
touch_main.c	Main Source file
r_i2c.c	I2C Source file
r_sensor.c	Sensor Main Source file
r_hs3001.c	HS3001 Source file
r_thermo.c	Thermo Sensor Source file
r_zmod4410.c	ZMOD4410 Source file

Table 4.2 shows header files.

**Table 4.2 Header files**

File name	Description
voice_main.h	Main Header file
r_i2c.h	I2C Header file
r_sensor.h	Sensor Main Header file
r_hs3001.h	HS3001 Header file
r_thermo.h	Thermo Sensor Header file
r_zmod4410.h	ZMOD4410 Header file



### 4.3 How to get the ZMOD4410 library

Download the library for the ZMOD4410 from the following link.

<https://www.renesas.com/us/en/products/sensor-products/gas-sensors/zmod4410-indoor-air-quality-sensor-platform>

The library to download is the following.

[ZMOD4410 - 2nd Gen - Air Quality & eCO2 Firmware - Recommended for New Designs](#)

Unzip the downloaded library and copy the following files to the Library folder.

**Table 4.3 Library files**

Folder name	File name
REN_ZMOD4410-AirQuality-eCO2-FW-2nd-Gen-2p1p2_SWR_20201019 \Renesas_ZMOD4410_IAQ_2nd_Gen_Example_2.1.2 \Renesas_ZMOD4410_IAQ_2nd_Gen_Example \ZMOD4410_Firmware\gas-algorithm-libraries \iaq_2nd_gen\Arm Cortex-MM23\arm-none-eabi-gcc\	iaq_2nd_gen.h lib_iaq_2nd_gen.a lib_zmod4xxx_cleaning.a zmod4xxx_cleaning.h
REN_ZMOD4410-AirQuality-eCO2-FW-2nd-Gen-2p1p2_SWR_20201019 \Renesas_ZMOD4410_IAQ_2nd_Gen_Example_2.1.2 \Renesas_ZMOD4410_IAQ_2nd_Gen_Example \ZMOD4410_Firmware\zmod4xxx_example\src\	zmod4xxx.c zmod4xxx.h zmod4xxx_types.h zmod4410_config_iaq2.h

## 4.4 Constants

Table 4.4 shows the list of constants.

**Table 4.4 Constants**

Constants name	Setting	Description
VD_PRIV_INFINITY_LOOP	while(1)	Error Loop
VD_PRIV_STS_ERR	(-1)	Error code
VD_PRIV_BTN_MD_OFF	(0x0001)	Run mode Off
VD_PRIV_BTN_MD_LOW	(0x0002)	Run mode Low
VD_PRIV_BTN_MD_MID	(0x0003)	Run mode Middle
VD_PRIV_BTN_MD_HI	(0x0004)	Run mode Hi
VD_PRIV_BTN_MD_AUTO	(0x0005)	Run mode Auto
VD_PRIV_AUTO_MD_0	(0x0010)	Run mode Auto_0
VD_PRIV_AUTO_MD_1	(0x0020)	Run mode Auto_1
VD_PRIV_AUTO_MD_2	(0x0030)	Run mode Auto_2
VD_PRIV_AUTO_MD_3	(0x0040)	Run mode Auto_3
VD_PRIV_AUTO_MD_4	(0x0050)	Run mode Auto_4
<b>LED</b>		
VD_PRIV_LED_ON	(0)	LED On
VD_PRIV_LED_OFF	(1)	LED Off
VD_PRIV_LED_POW	(0x0001)	LED Pow bit
VD_PRIV_LED_LOW	(0x0002)	LED Low bit
VD_PRIV_LED_MID	(0x0004)	LED Middle bit
VD_PRIV_LED_HI	(0x0008)	LED Hi bit
VD_PRIV_LED_AUTO	(0x0010)	LED Auto bit
VD_PRIV_LED_MD_OFF	(0)	LED mode off bit
VD_PRIV_LED_MD_LOW	(0x0003)	LED mode low bit
VD_PRIV_LED_MD_MID	(0x0005)	LED mode middle bit
VD_PRIV_LED_MD_HI	(0x0009)	LED mode hi bit
VD_PRIV_LED_MD_A0	(0x0011)	LED mode auto0 bit
VD_PRIV_LED_MD_A1	(0x0013)	LED mode auto1 bit
VD_PRIV_LED_MD_A2	(0x0015)	LED mode auto2 bit
VD_PRIV_LED_MD_A3	(0x0019)	LED mode auto3 bit
VD_PRIV_LED_MD_A4	(0x0019)	LED mode auto4 bit
<b>CTSU</b>		
VD_PRIV_BTN_1	(1)	Button1 bit
VD_PRIV_BTN_2	(2)	Button2 bit
VD_PRIV_BTN_3	(3)	Button3 bit
VD_PRIV_BTN_4	(4)	Button4 bit
VD_PRIV_BTN_5	(0)	Button5 bit
VD_PRIV_BTN_POW	(0x0002)	Button Pow
VD_PRIV_BTN_LOW	(0x0004)	Button Low
VD_PRIV_BTN_MID	(0x0008)	Button Middle
VD_PRIV_BTN_HI	(0x0010)	Button Hi
VD_PRIV_BTN_AUTO	(0x0001)	Button Auto
VD_PRIV_BTN_BIT_POW	(0x0001)	Button bit Pow
VD_PRIV_BTN_BIT_LOW	(0x0002)	Button bit Low
VD_PRIV_BTN_BIT_MID	(0x0004)	Button bit Middle
VD_PRIV_BTN_BIT_HI	(0x0008)	Button bit Hi
VD_PRIV_BTN_BIT_AUTO	(0x0010)	Button bit Auto
<b>BUZZER</b>		
VD_PRIV_BZ_POW	(22943)	Buzzer Count Pow (1046Hz)
VD_PRIV_BZ_LOW	(20441)	Buzzer Count Low (1174Hz)
VD_PRIV_BZ_MID	(18208)	Buzzer Count Middle (1318Hz)
VD_PRIV_BZ_HI	(17190)	Buzzer Count Hi (1396Hz)
VD_PRIV_BZ_AUTO	(15314)	Buzzer Count Auto (1567Hz)
VD_PRIV_BZ_A0	(22943)	Buzzer Count Auto_0

VD_PRIV_BZ_A1	(20441)	Buzzer Count Auto_1
VD_PRIV_BZ_A2	(18208)	Buzzer Count Auto_2
VD_PRIV_BZ_A3	(17190)	Buzzer Count Auto_3
VD_PRIV_BZ_A4	(15314)	Buzzer Count Auto_4
VD_PRIV_BZ_CNT_1	(1)	Buzzer Count (N * 100ms)
<b>TOOL</b>		
VD_PRIV_MODE_RUN	(1)	Send Enable
VD_PRIV_MODE_STOP	(0)	Send Disable
VD_PRIV_DATA_HEAD	(0x88)	Data Head Mark
VD_PRIV_SEND_LEN	(57)	Send length
VD_PRIV_SEND_TIME	(5)	Send Interval (N * 20ms)
<b>UART</b>		
VD_PRIV_WAIT	(1)	Wait Send Complete
VD_PRIV_NO_WAIT	(0)	No Wait Send Complete
VD_PRIV_KEY_ERR	(0xff)	Error
VD_PRIV_KEY_CR	(0x0d)	CR ASCII CODE
VD_PRIV_KEY_LF	(0x0a)	LF ASCII CODE
VD_PRIV_UART_RX_MAX	(64)	Receive Buffer Size
VD_PRIV_UART_CMD_MAX	(64)	Command Buffer Size
<b>THERMO Sensor</b>		
VD_PRIV_THR_R_LEN	(35)	Receive Data Length
VD_PRIV_THR_DATA_OFS	(2)	Data Offset
VD_PRIV_THR_DATA_CNT	(16)	Data Count
VD_PRIV_THR_THR	(400)	Thresh (40.0°C)
VD_PRIV_THR_LVL1	(0)	Level1 Count
VD_PRIV_THR_LVL2	(2)	Level2 Count
VD_PRIV_THR_LVL3	(4)	Level3 Count
<b>GAS Sensor</b>		
VD_PRIV_IAQ_LVL1	(1.99f)	Level1 Thresh
VD_PRIV_IAQ_LVL2	(2.99f)	Level2 Thresh
VD_PRIV_IAQ_LVL3	(3.99f)	Level3 Thresh
VD_PRIV_IAQ_LVL4	(4.99f)	Level4 Thresh

## 4.5 Global Variables

Table 4.5 shows the global variables.

**Table 4.5 Global Variables**

Variables name	Type	Description
gs_timer1_cnt	int16_t	Timer1 count
gs_timer3_cnt	int16_t	Timer3 count
gs_timer4_cnt	int16_t	Timer4 count
gs_sts_prev	int16_t	Status previous
gs_btn_mode	int16_t	Run mode
gs_btn_mode_prev	int16_t	Run mode previous
gs_btn_nml_prev	int16_t	Normal mode previous
gs_btn_prev	int16_t	Button previous
gs_auto_mode_prev	int16_t	Auto mode previous
gs_iaq_fdata	float	IAQ float data
gs_iaq_idata	int16_t	IAQ int data
gs_temp_idata	int16_t	Temperature int data
gs_humi_idata	int16_t	Humidity int data
gs_btn_data	uint16_t	Button data
gs_data_num	int16_t	Send data number
<b>Command</b>		
gs_mode_flg	uint16_t	Send mode flag
<b>CTSU</b>		
gs_btn_status	uint64_t	Button status
gs_btn_dif	uint16_t[]	Button difference data
<b>UART</b>		
gs_uart_rx_len	int16_t	Receive length
gs_uart_rd_idx	int16_t	Buffer Read index
gs_uart_wr_idx	int16_t	Buffer Write index
gs_uart_cmd_len	int16_t	Command length
gs_uart_rx_buf	uint8_t[]	Receive Buffer
gs_uart_cmd_buf	uint8_t[]	Command Buffer
gs_send_time	int16_t	Send Interval
gs_send_buf	uint8_t[]	Send Buffer
gs_thr_data	uint8_t[]	Thermo sensor data Buffer

## 4.6 Function Specifications

Table 4.6 shows the list of functions.

**Table 4.6 Function list**

Function name	Description
touch_main	Main function
touch_init	Initialize
touch_loop	Main loop
btn_func	Button function
btn_func_normal_0	Normal mode Off function
btn_func_normal_L	Normal mode Low function
btn_func_normal_M	Normal mode Middle function
btn_func_normal_H	Normal mode High function
btn_func_auto	Auto mode function
btn_bit_set	Button bit set
btn_check	Button check
normal_mode_func	Normal mode function
auto_func	Auto mode function
auto_mode0_func	Auto mode0 function
auto_mode1_func	Auto mode1 function
auto_mode2_func	Auto mode2 function
auto_mode3_func	Auto mode3 function
auto_mode4_func	Auto mode4 function
led_set	LED data set
buzzer_start	Buzzer (buzzer wave) start
timer_open	Timer initialize
timer4_wait	Timer4 (20ms wait timer) start
timer3_stop	Timer3 (300ms buzzer timer) stop
ctsu_open	CTSU initialize
ctsu_getkey	Get key code
uart_open	UART initialize
uart_cmd_func	UART command function
uart_getchr	UART Get Key code
uart_putmsg	UART Send message
uart_wait_tx_end	UART Wait Send complete
cmd_chk	Command check
send_bin_data	Send binary data
thermo_data_cnt	Thermo sensor data count
thermo_data_clr	Thermo sensor data count clear

### 4.7 Overall processing Flow

The following describes the overall processing flow.

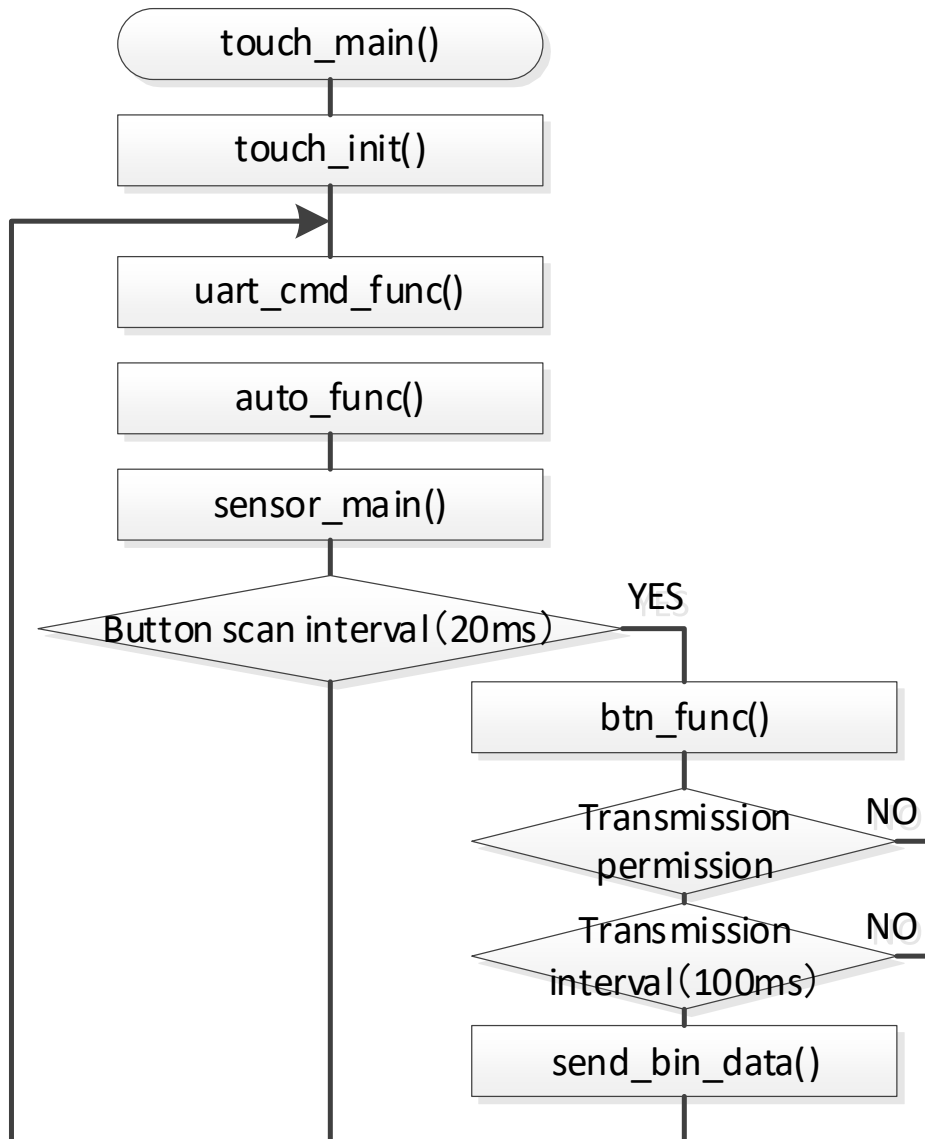

## 4.8 UART command processing Flow

The following shows UART processing flow.

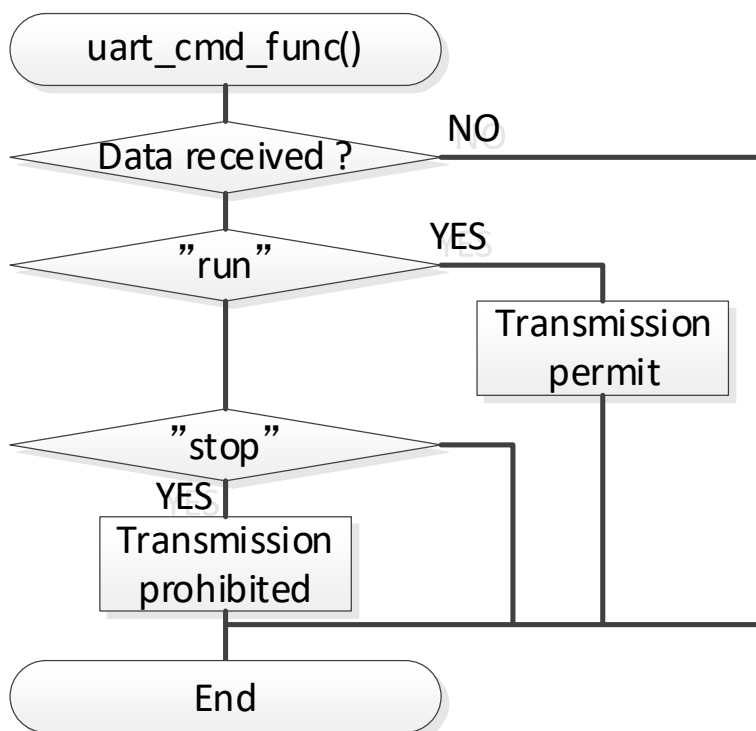

### 4.9 Touchless button operation processing flow

Following shows the touchless button operation processing flow.

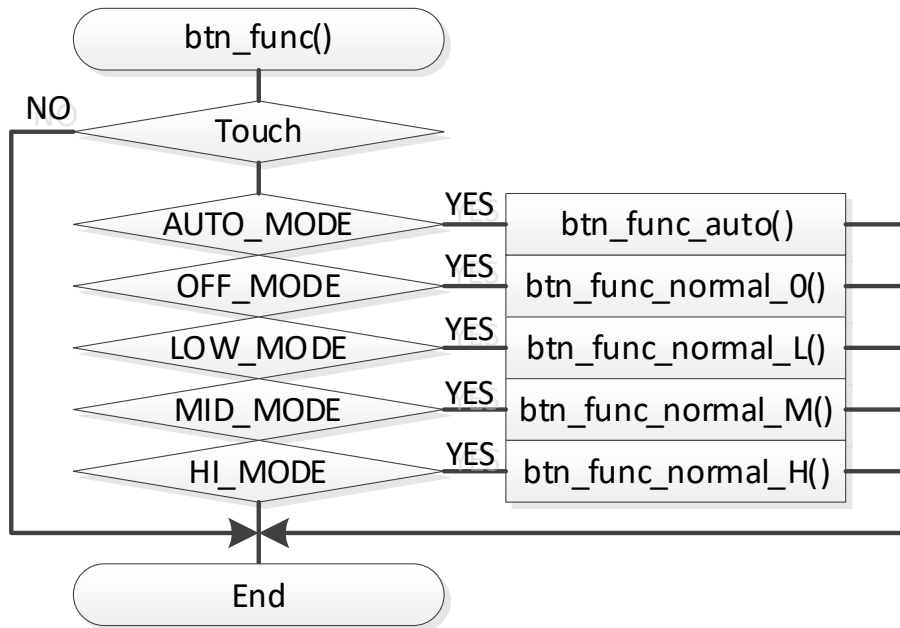



### 4.10 Sensor measurement processing flow

Following shows the sensor measurement processing flow.

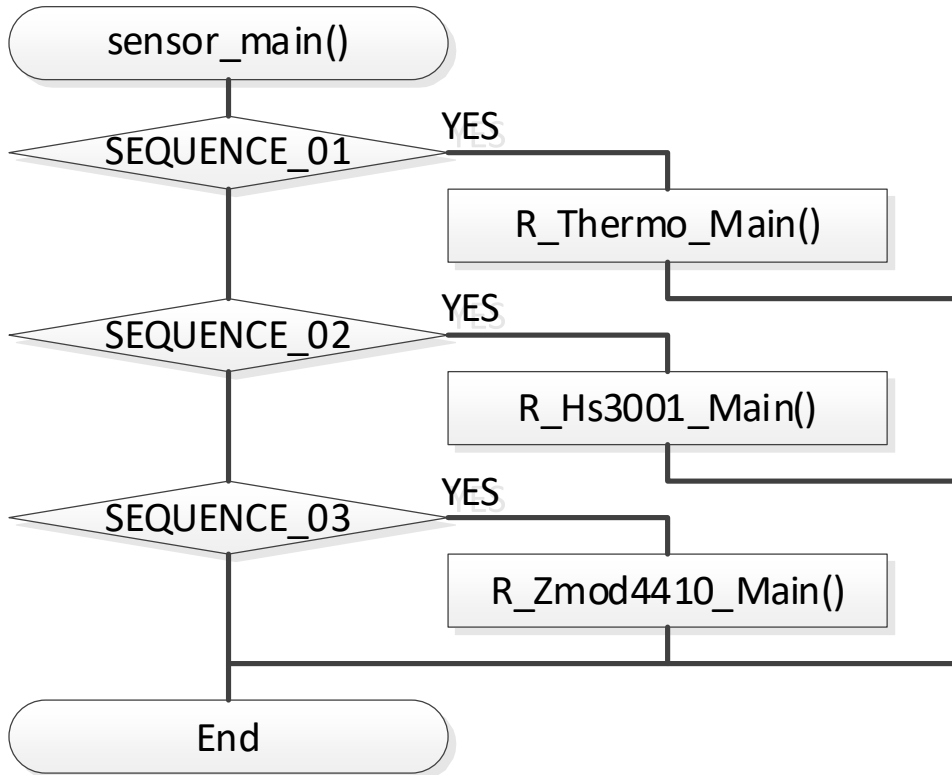

### 4.11 AUTO mode processing flow

Following shows the AUTO mode processing flow.

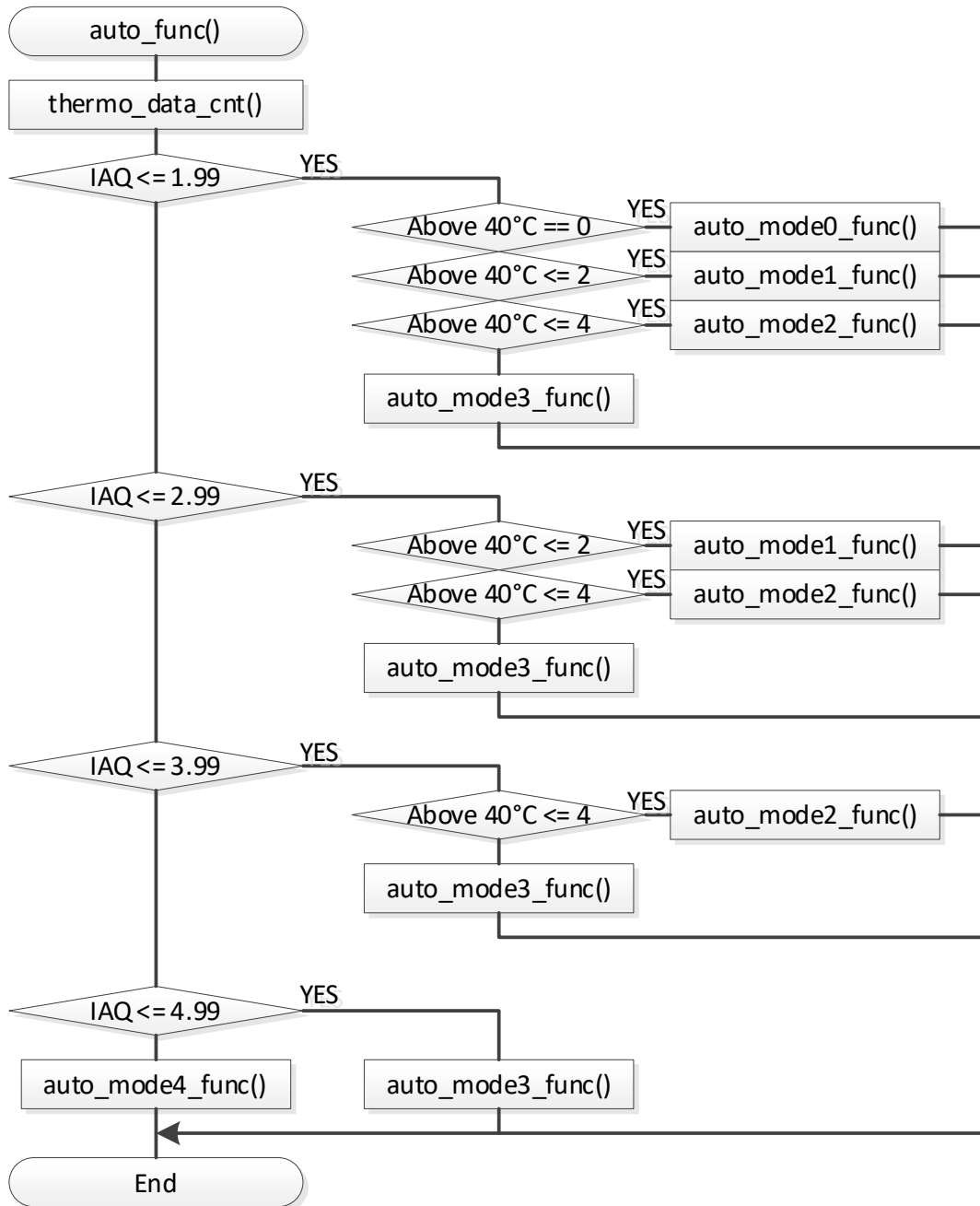

## 4.12 Data flow

Following shows the data flow.

Copies the button data and sensor data to the transmission buffer and send to UART every 100ms.

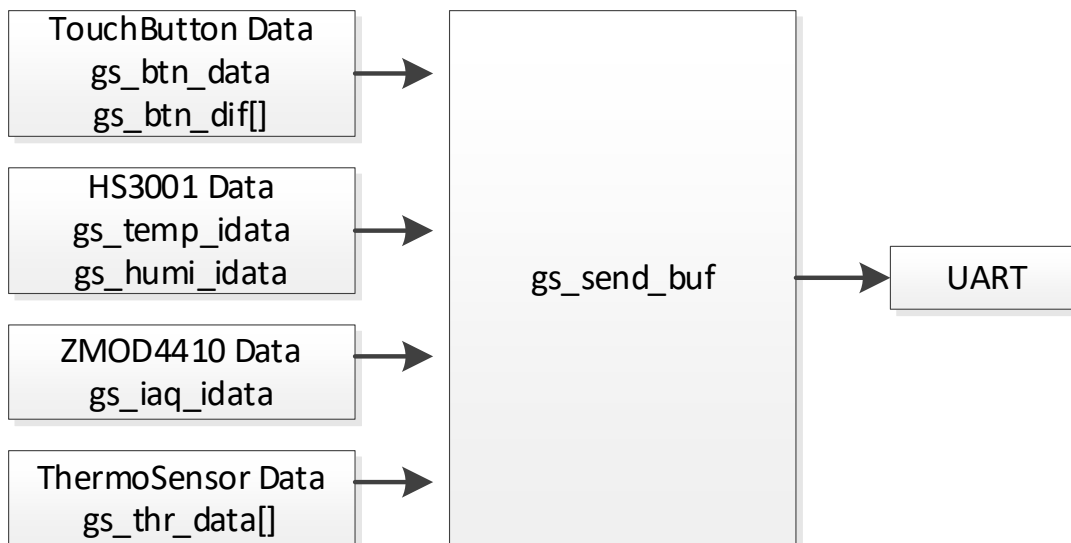

Transmitted data format is as follows.

OFFSET	Item	Byte	Description
0	Data Head Mark	1	Shows data header (0x88)
1	Data Number	1	Loop between 0x00 and 0xFF
2	Button Status	1	Button status; When each button is touched, the following bit is set to 1 Bit0:Button1, Bit1: Button2, Bit2: Button3, Bit3: Button4, Bit4: Button5
3	Mode	1	OFF(0x01), LOW(0x02), MID(0x03), HI(0x04), AUTO_MODE0(0x15), AUTO_MODE1(0x25), AUTO_MODE2(0x35), AUTO_MODE3(0x45), AUTO_MODE4(0x55)
4	Button1 Data	2	DIFF value (0 to 65535)
6	Button2 Data	2	DIFF value (0 to 65535)
8	Button3 Data	2	DIFF value (0 to 65535)
10	Button4 Data	2	DIFF value (0 to 65535)
12	Button5 Data	2	DIFF value (0 to 65535)
14	Temperature	2	Value obtained by multiplying the data with one decimal place by ten (example : when data is 12.3°C value will be 123)
16	Humidity	2	Value obtained by multiplying the data with one decimal place by ten (example : when data is 45.6%, value will be 456)
18	IAQ	2	Value obtained by multiplying the data with one decimal place by ten (example : when data is 12.3, value will be 123)
20	Dummy	1	Dummy
21	Thermo sensor	1	Number of byte of following thermo sensor data(35)
22	PTAT	2	Thermo sensor data Value obtained by multiplying the data with one decimal place by ten (example : when data is 12.3°C, value will be 123)
24	P00 Data - P15 Data	32 (2 * 16)	Thermo sensor data Value obtained by multiplying the data with one decimal place by ten (example : when data is 12.3°C, value will be 123)
56	PEC	1	Checksum of Thermo sensor data
	Total byte	57	

Transmitted data is supposed to be used in application on PC as shown below.

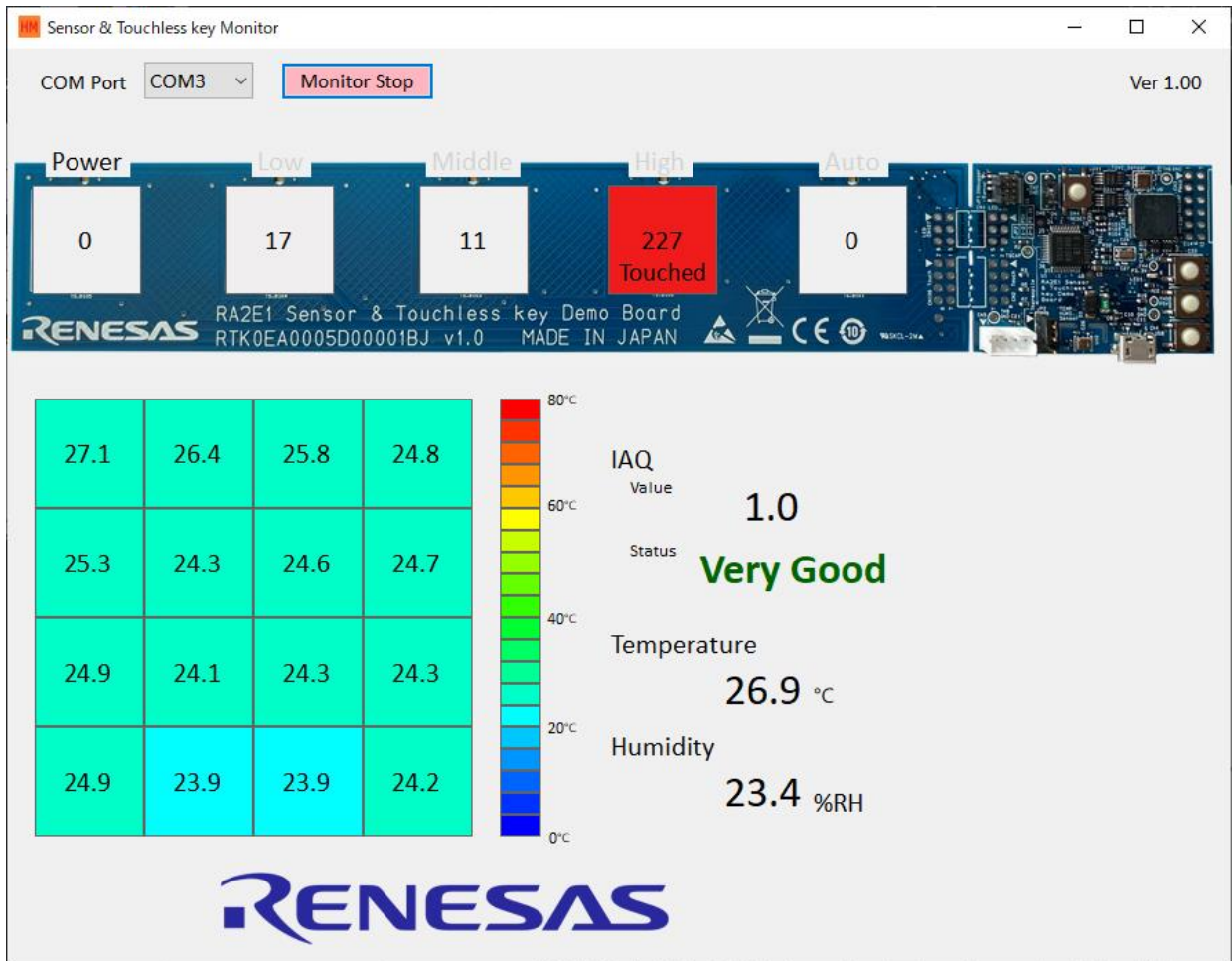

More info and detail of this application, please refer Sensor & Touchless key Demo Evaluation Tool “Sensor & Touchless key Monitor” (R20AN0614EJ0100).

**Revision History**

Rev.	Date	Description	
		Page	Summary
1.00	Feb.11.21	-	First release

## General Precautions in the Handling of Microprocessing Unit and Microcontroller Unit Products

The following usage notes are applicable to all Microprocessing unit and Microcontroller unit products from Renesas. For detailed usage notes on the products covered by this document, refer to the relevant sections of the document as well as any technical updates that have been issued for the products.

### 1. Precaution against Electrostatic Discharge (ESD)

A strong electrical field, when exposed to a CMOS device, can cause destruction of the gate oxide and ultimately degrade the device operation. Steps must be taken to stop the generation of static electricity as much as possible, and quickly dissipate it when it occurs. Environmental control must be adequate. When it is dry, a humidifier should be used. This is recommended to avoid using insulators that can easily build up static electricity.

Semiconductor devices must be stored and transported in an anti-static container, static shielding bag or conductive material. All test and measurement tools including work benches and floors must be grounded. The operator must also be grounded using a wrist strap. Semiconductor devices must not be touched with bare hands. Similar precautions must be taken for printed circuit boards with mounted semiconductor devices.

### 2. Processing at power-on

The state of the product is undefined at the time when power is supplied. The states of internal circuits in the LSI are indeterminate and the states of register settings and pins are undefined at the time when power is supplied. In a finished product where the reset signal is applied to the external reset pin, the states of pins are not guaranteed from the time when power is supplied until the reset process is completed. In a similar way, the states of pins in a product that is reset by an on-chip power-on reset function are not guaranteed from the time when power is supplied until the power reaches the level at which resetting is specified.

### 3. Input of signal during power-off state

Do not input signals or an I/O pull-up power supply while the device is powered off. The current injection that results from input of such a signal or I/O pull-up power supply may cause malfunction and the abnormal current that passes in the device at this time may cause degradation of internal elements. Follow the guideline for input signal during power-off state as described in your product documentation.

### 4. Handling of unused pins

Handle unused pins in accordance with the directions given under handling of unused pins in the manual. The input pins of CMOS products are generally in the high-impedance state. In operation with an unused pin in the open-circuit state, extra electromagnetic noise is induced in the vicinity of the LSI, an associated shoot-through current flows internally, and malfunctions occur due to the false recognition of the pin state as an input signal become possible.

### 5. Clock signals

After applying a reset, only release the reset line after the operating clock signal becomes stable. When switching the clock signal during program execution, wait until the target clock signal is stabilized. When the clock signal is generated with an external resonator or from an external oscillator during a reset, ensure that the reset line is only released after full stabilization of the clock signal. Additionally, when switching to a clock signal produced with an external resonator or by an external oscillator while program execution is in progress, wait until the target clock signal is stable.

### 6. Voltage application waveform at input pin

Waveform distortion due to input noise or a reflected wave may cause malfunction. If the input of the CMOS device stays in the area between  $V_{IL}$  (Max.) and  $V_{IH}$  (Min.) due to noise, for example, the device may malfunction. Take care to prevent chattering noise from entering the device when the input level is fixed, and also in the transition period when the input level passes through the area between  $V_{IL}$  (Max.) and  $V_{IH}$  (Min.).

### 7. Prohibition of access to reserved addresses

Access to reserved addresses is prohibited. The reserved addresses are provided for possible future expansion of functions. Do not access these addresses as the correct operation of the LSI is not guaranteed.

### 8. Differences between products

Before changing from one product to another, for example to a product with a different part number, confirm that the change will not lead to problems. The characteristics of a microprocessing unit or microcontroller unit products in the same group but having a different part number might differ in terms of internal memory capacity, layout pattern, and other factors, which can affect the ranges of electrical characteristics, such as characteristic values, operating margins, immunity to noise, and amount of radiated noise. When changing to a product with a different part number, implement a system-evaluation test for the given product.

## Notice

1. Descriptions of circuits, software and other related information in this document are provided only to illustrate the operation of semiconductor products and application examples. You are fully responsible for the incorporation or any other use of the circuits, software, and information in the design of your product or system. Renesas Electronics disclaims any and all liability for any losses and damages incurred by you or third parties arising from the use of these circuits, software, or information.
2. Renesas Electronics hereby expressly disclaims any warranties against and liability for infringement or any other claims involving patents, copyrights, or other intellectual property rights of third parties, by or arising from the use of Renesas Electronics products or technical information described in this document, including but not limited to, the product data, drawings, charts, programs, algorithms, and application examples.
3. No license, express, implied or otherwise, is granted hereby under any patents, copyrights or other intellectual property rights of Renesas Electronics or others.
4. You shall be responsible for determining what licenses are required from any third parties, and obtaining such licenses for the lawful import, export, manufacture, sales, utilization, distribution or other disposal of any products incorporating Renesas Electronics products, if required.
5. You shall not alter, modify, copy, or reverse engineer any Renesas Electronics product, whether in whole or in part. Renesas Electronics disclaims any and all liability for any losses or damages incurred by you or third parties arising from such alteration, modification, copying or reverse engineering.
6. Renesas Electronics products are classified according to the following two quality grades: "Standard" and "High Quality". The intended applications for each Renesas Electronics product depends on the product's quality grade, as indicated below.

"Standard": Computers; office equipment; communications equipment; test and measurement equipment; audio and visual equipment; home electronic appliances; machine tools; personal electronic equipment; industrial robots; etc.

"High Quality": Transportation equipment (automobiles, trains, ships, etc.); traffic control (traffic lights); large-scale communication equipment; key financial terminal systems; safety control equipment; etc.

Unless expressly designated as a high reliability product or a product for harsh environments in a Renesas Electronics data sheet or other Renesas Electronics document, Renesas Electronics products are not intended or authorized for use in products or systems that may pose a direct threat to human life or bodily injury (artificial life support devices or systems; surgical implantations; etc.), or may cause serious property damage (space system; undersea repeaters; nuclear power control systems; aircraft control systems; key plant systems; military equipment; etc.). Renesas Electronics disclaims any and all liability for any damages or losses incurred by you or any third parties arising from the use of any Renesas Electronics product that is inconsistent with any Renesas Electronics data sheet, user's manual or other Renesas Electronics document.
7. No semiconductor product is absolutely secure. Notwithstanding any security measures or features that may be implemented in Renesas Electronics hardware or software products, Renesas Electronics shall have absolutely no liability arising out of any vulnerability or security breach, including but not limited to any unauthorized access to or use of a Renesas Electronics product or a system that uses a Renesas Electronics product. RENESAS ELECTRONICS DOES NOT WARRANT OR GUARANTEE THAT RENESAS ELECTRONICS PRODUCTS, OR ANY SYSTEMS CREATED USING RENESAS ELECTRONICS PRODUCTS WILL BE INVULNERABLE OR FREE FROM CORRUPTION, ATTACK, VIRUSES, INTERFERENCE, HACKING, DATA LOSS OR THEFT, OR OTHER SECURITY INTRUSION ("Vulnerability Issues"). RENESAS ELECTRONICS DISCLAIMS ANY AND ALL RESPONSIBILITY OR LIABILITY ARISING FROM OR RELATED TO ANY VULNERABILITY ISSUES. FURTHERMORE, TO THE EXTENT PERMITTED BY APPLICABLE LAW, RENESAS ELECTRONICS DISCLAIMS ANY AND ALL WARRANTIES, EXPRESS OR IMPLIED, WITH RESPECT TO THIS DOCUMENT AND ANY RELATED OR ACCOMPANYING SOFTWARE OR HARDWARE, INCLUDING BUT NOT LIMITED TO THE IMPLIED WARRANTIES OF MERCHANTABILITY, OR FITNESS FOR A PARTICULAR PURPOSE.
8. When using Renesas Electronics products, refer to the latest product information (data sheets, user's manuals, application notes, "General Notes for Handling and Using Semiconductor Devices" in the reliability handbook, etc.), and ensure that usage conditions are within the ranges specified by Renesas Electronics with respect to maximum ratings, operating power supply voltage range, heat dissipation characteristics, installation, etc. Renesas Electronics disclaims any and all liability for any malfunctions, failure or accident arising out of the use of Renesas Electronics products outside of such specified ranges.
9. Although Renesas Electronics endeavors to improve the quality and reliability of Renesas Electronics products, semiconductor products have specific characteristics, such as the occurrence of failure at a certain rate and malfunctions under certain use conditions. Unless designated as a high reliability product or a product for harsh environments in a Renesas Electronics data sheet or other Renesas Electronics document, Renesas Electronics products are not subject to radiation resistance design. You are responsible for implementing safety measures to guard against the possibility of bodily injury, injury or damage caused by fire, and/or danger to the public in the event of a failure or malfunction of Renesas Electronics products, such as safety design for hardware and software, including but not limited to redundancy, fire control and malfunction prevention, appropriate treatment for aging degradation or any other appropriate measures. Because the evaluation of microcomputer software alone is very difficult and impractical, you are responsible for evaluating the safety of the final products or systems manufactured by you.
10. Please contact a Renesas Electronics sales office for details as to environmental matters such as the environmental compatibility of each Renesas Electronics product. You are responsible for carefully and sufficiently investigating applicable laws and regulations that regulate the inclusion or use of controlled substances, including without limitation, the EU RoHS Directive, and using Renesas Electronics products in compliance with all these applicable laws and regulations. Renesas Electronics disclaims any and all liability for damages or losses occurring as a result of your noncompliance with applicable laws and regulations.
11. Renesas Electronics products and technologies shall not be used for or incorporated into any products or systems whose manufacture, use, or sale is prohibited under any applicable domestic or foreign laws or regulations. You shall comply with any applicable export control laws and regulations promulgated and administered by the governments of any countries asserting jurisdiction over the parties or transactions.
12. It is the responsibility of the buyer or distributor of Renesas Electronics products, or any other party who distributes, disposes of, or otherwise sells or transfers the product to a third party, to notify such third party in advance of the contents and conditions set forth in this document.
13. This document shall not be reprinted, reproduced or duplicated in any form, in whole or in part, without prior written consent of Renesas Electronics.
14. Please contact a Renesas Electronics sales office if you have any questions regarding the information contained in this document or Renesas Electronics products.

(Note1) "Renesas Electronics" as used in this document means Renesas Electronics Corporation and also includes its directly or indirectly controlled subsidiaries.

(Note2) "Renesas Electronics product(s)" means any product developed or manufactured by or for Renesas Electronics.

(Rev.5.0-1 October 2020)

## Corporate Headquarters

TOYOSU FORESIA, 3-2-24 Toyosu,  
Koto-ku, Tokyo 135-0061, Japan  
[www.renesas.com](http://www.renesas.com)

## Trademarks

Renesas and the Renesas logo are trademarks of Renesas Electronics Corporation. All trademarks and registered trademarks are the property of their respective owners.

## Contact information

For further information on a product, technology, the most up-to-date version of a document, or your nearest sales office, please visit:  
[www.renesas.com/contact/](http://www.renesas.com/contact/).